

# 1 – About SIPs and CSIPs

This report focuses on a relatively new technology and a relatively small industry within the larger scope of the building community. In addition, by addressing cementitious-faced SIPs, this report addresses an even narrower segment.

To put this report in perspective, we first review the current status and practices of the SIP industry.

## 1.1 – What are SIPs and CSIPs?

SIPs are high-performance composite building panels used in floors, walls, and roofs for residential and light commercial buildings. These panels are fabricated in a factory and shipped to a construction site, where they can be quickly assembled to form a tight, energy-efficient building envelope.

SIPs are a simple composite sandwich panel. ASTM International defines simple sandwich panels as “a three layered construction formed by bonding a thin layer (facing) to each side of a thick layer (core).”<sup>1</sup> The term “composite” refers to any material in which two or more distinct materials are combined together, yet remain uniquely identifiable in the mix.



**Figure 1 – Structural Insulated Panel with Cement Fiber Facing**

Generally, SIPs are made by sandwiching a core of rigid foam plastic insulation between two structural skins, though many different variations (based on facing and core materials) are included in the blanket definition. SIPs are currently made with a variety of structural skin materials, including oriented strand board (OSB), treated plywood, fiber-cement board (cementitious), and metal. However, virtually any bondable material could be used as a facing. Core materials are typically expanded polystyrene (EPS), extruded polystyrene (XPS), or polyurethane, but other rigid insulation can be used as well. Facings and core materials are bonded by structural adhesives.

These variables allow for panels to be optimized to the specific needs of any project. SIPs are typically available in thicknesses ranging from 4½ inches to 12¼ inches. Walls are commonly between 4 and 6 inches, and roof panels are generally thicker (often up to 12 inches, depending on climate

<sup>1</sup> ASTM C274 - 07 Standard Terminology of Structural Sandwich Constructions

conditions). SIPs with cementitious facings are typically cut to 4 feet by 8 feet. SIPs may be as large as 9 feet by 28 feet with OSB facings. Custom sizes are also available, and many manufacturers offer curved SIPs for curved roof applications.<sup>2</sup>

This design flexibility, as well as the different combinations of core and facing materials, allow for unique performance properties for each project. SIPs' flexibility, strength, and energy performance make them an important twenty-first-century building material for high-performance buildings.

*NOTE: As a designed composite, SIPs are an assembled product. Therefore, the subcomponents and assemblies must be tested rather than evaluated theoretically.*

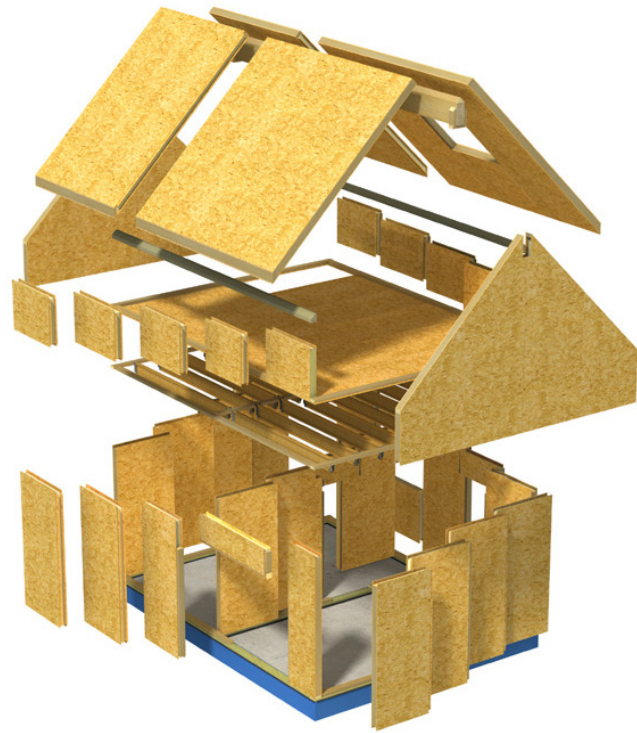

**Figure 2 - Diagram of SIP House Construction with OSB Facings**

## 1.2 – A History of SIPs

SIPs were developed nearly 75 years ago when the Forest Products Laboratory (FPL), established by the U.S. Department of Agriculture, built the first SIP house in 1935 in Madison, Wisconsin. FPL engineers speculated that plywood and hardboard sheathing could take a portion of the structural load in wall applications. Their prototype SIPs were constructed using framing members within the panel combined with structural sheathing and insulation. These panels were used to construct test homes, which were continually tested and monitored for the next 31 years.<sup>3</sup>

Following the FPL experiment, Alden B. Dow, son of the founder of Dow Chemical Company and a student of Frank Lloyd Wright, created the first foam core SIP in 1952. By the 1960s, rigid foam insulating products were readily available, leading to the production of SIPs as they are today.

In the early 1990s, advanced computer-aided manufacturing (CAM) technology was developed. This technology can convert computer-aided design (CAD) drawings to code and allow automated cutting machines to fabricate SIPs to match a building's specific design. CAD-to-CAM technology has streamlined the SIP manufacturing process, bringing further labor savings to builders.

---

<sup>2</sup> "Structural Insulated Panels Product Guide". SIPA and APA. December 2007.

<sup>3</sup> "The History of SIPs", <http://www.sips.org/>

This development coincided with SIPA's formation in 1990. SIPA was formed to provide support and visibility for those manufacturing and building with this emerging building technology and to increase SIPs' market share through a partnership with the Engineered Wood Association (APA).

Taking advantage of the building industry's growing interest in energy efficiency, SIPA collaborated with the Partnership for Advanced Housing Technology to "develop a set of prescriptive performance standards, which were submitted for inclusion in the International Code Council's Residential Code (IRC)."<sup>4</sup> On May 22, 2007, structural insulated panel wall systems were adopted into the IRC. Section R614 of the 2007 IRC Supplement and subsequent editions of the code include prescriptive standards for SIP wall construction. The IRC Prescriptive Method for SIPs is attached as Appendix A. For more information regarding the adoption of SIPs in building codes, as well as how this changes the design decision process, see section 2.2.

Today, SIPs offer a high-tech solution for residential and low-rise nonresidential buildings, with a great potential for multistory building applications.

### 1.3 – Current Material Options in the SIP Industry

A closer examination of SIP's three components—the structural facing, insulating core, and adhesive holding the pieces together—yields a greater understanding of their potential. The variety of available materials allows panels to be tailored to each project and component materials to complement each other, making the design of SIPs both a material selection problem and a dimensional problem. For example, increasing the core thickness to obtain the proper design values can compensate for facing materials that lack rigidity. This flexibility allows materials to be chosen for reasons other than mechanical performance.

The rapid development of new technologies makes for new possibilities, and the material options are essentially boundless. Thus, this review cannot touch on every available option. Instead, it includes the most common and readily available material options currently used in the SIP industry and highlights the material options focused upon in this research.

#### 1.3.1 – Facing Materials

Ideally, SIP facings should have high stiffness (high flexural rigidity), high tensile and compressive strength, high impact resistance, quality surface finish, resistance to environmental impacts (e.g., chemical, UV, heat, etc.), and durability.<sup>5</sup>

The following table reviews the most common facing materials in the current SIP market, examining their positive and negative performance attributes.

---

<sup>4</sup> Get Energy Smart.org "What Are SIPs?" <<http://www.getenergysmart.org/Files/Presentations/HY-R%20NYSERDA%20Presentation.ppt>> 8 Nov. 2006

<sup>5</sup> Zenkert, D. "The Handbook of Sandwich Construction". Pg. 12.

## Common SIP Facing Materials

<i>Material</i>	Pros	Cons
Oriented Strand Board	<ul style="list-style-type: none"> <li>• Inexpensive</li> <li>• Readily available</li> <li>• Recognized in current IRC code</li> </ul>	<ul style="list-style-type: none"> <li>• Requires finishing on interior and exterior</li> <li>• Swells with moisture</li> </ul>
Cement Fiber	<ul style="list-style-type: none"> <li>• Will not rot, burn, or corrode</li> <li>• Acts as a finished interior and exterior</li> <li>• More durable and lasts longer</li> </ul>	<ul style="list-style-type: none"> <li>• Heavier than other options and more difficult to handle</li> <li>• Brittle and prone to cracking during shipment</li> <li>• More expensive than OSB</li> </ul>
Metal	<ul style="list-style-type: none"> <li>• Inexpensive</li> <li>• Readily available</li> <li>• More durable and lasts longer</li> </ul>	<ul style="list-style-type: none"> <li>• Requires finishing on interior and exterior</li> </ul>
Others	Magnesium oxide board, fiber-reinforced polymers	

Table 1 – Common SIP Facing Materials

OSB facings are used for the vast majority of SIPs. OSB is an engineered wood product made from cross-oriented layers of thin, rectangular wooden strips compressed and bonded together with wax and resin adhesives. OSB has been extensively tested as a load-bearing material and is commonly available in large sizes. In addition, the Prescriptive Method Supplement to the IRC (discussed in the next chapter) requires OSB facings for SIPs to be recognized in the code for one- to two-story residential buildings.

Metal SIP manufacturers often use aluminum as a skin material. This structural panel system is used in both residential sites, such as carports or walkways, as well as industrial systems, such as the construction of cold storage facilities. Panel designers sometimes take advantage of their aluminum siding and connect panels metal to metal with pop rivets. Another option is a cam-lock system or a system in which internal gutters allow the panels to be reversed.

Fiber-cement board faced SIPs, referred to as CSIPs, are the focus of this research. CSIPs constitute a smaller portion of the market than OSB faced SIPs, but they carry many added benefits. CSIPs are typically manufactured from cellulose-reinforced cement boards for inside and outside skins, commonly referred to as “fiber-reinforced cement,” or simply “fiber cement.” Table 2 – Required Evaluation of Cement Fiber Panels” lists required testing.

Fiber-cement panels can have different finished looks, such as a wood grain, stucco, or smooth.<sup>6</sup> This removes the need for CSIPs to be finished on the interior or exterior, making it the entire wall assembly

<sup>6</sup> <http://www.toolbase.org/Building-Systems/Whole-House-Systems/fiber-cement-faced-sips>

and removing the need for several steps in the construction process. If CSIPs are used as the interior finish surface, they must comply with the appropriate fire codes. Where used as the exterior finish surface, fiber-cement board must be tested for weather resistance, transverse and racking loading, and fire resistance.

In addition to providing an interior and exterior finish, buildings constructed with CSIPs typically will last longer and require less maintenance than those built with other types of SIPs. Fiber cement boards have a high resistance to moisture absorption, will not support black mold growth, and are rot and vermin resistant. CSIPs have a higher fire rating than OSB-faced SIPs, and in most residential applications, no drywall is necessary. This lack of drywall requirements is determined by the fire-requirements of the applicable building code. See Section 2.2.8 for a more detailed discussion of fire code requirements and limitations of CSIPs.

While there are many benefits to CSIPs, there are negative aspects as well. CSIPs are significantly heavier than OSB SIPs. A 4'x8' CSIP panel weighs roughly 180 lbs., while a 4'x8' OSB SIP weighs 111 lbs. This makes CSIPs more cumbersome during construction. In addition, due to the free silica—a health hazard if inhaled—contained in most cement fiber, in-field modifications (especially with rotary saws) should be avoided.

The final difficulty with CSIPs is the relative infancy of the industry. Since few CSIP manufacturers and large-scale organizations exist, CSIP prices are higher for the consumer than need be, and service is less reliable and consistent.

Required Evaluation of Cement Fiber Panels	
Interior Use	<ul style="list-style-type: none"> <li>• ASTM C1325 – Standard Specification for Non-Asbestos Fiber-Mat Reinforced Cementitious Backer Units</li> </ul>
Non-Structural Use	<ul style="list-style-type: none"> <li>• ASTM C1325 with Section S1</li> <li>• ICC-ES AC376 – Acceptance Criteria for Reinforced Cementitious Sheets Used As Wall Sheathing and Floor Underlayment</li> </ul>
Interior Finish	<ul style="list-style-type: none"> <li>• ASTM E84 – Standard Test Method for Surface Burning Characteristics of Building Materials. <i>Refer to Section 2.2.8 for more information on this testing.</i></li> </ul>
Construction Types	<ul style="list-style-type: none"> <li>• ASTM E 119 – Standard Test Methods for Fire Tests of Building Construction Materials</li> <li>• IBC Table 601.</li> </ul>
Non-Combustible	<ul style="list-style-type: none"> <li>• ASTM E136 – Standard Test Method for Behavior of Materials in a Vertical Tube Furnace at 750°C</li> </ul>
Vertical Use	<ul style="list-style-type: none"> <li>• ICC-ES AC 376</li> </ul>
Racking Strength	<ul style="list-style-type: none"> <li>• ICC-ES AC 376</li> <li>• Section 3.6/AC269 – Acceptance Criteria for Racking Shear Evaluation of Proprietary Sheathing Materials Used as Braced Wall Panels</li> </ul>
Water Resistive Barrier	<ul style="list-style-type: none"> <li>• Assembly Tests per ASTM E331 – Standard Test Method for Water Penetration of Exterior Windows, Skylights, Doors, and Curtain Walls by Uniform Static Air Pressure Difference <i>under the conditions specified in IBC 1403.2.</i></li> <li>• Tests on lateral resistance and nail head pull through shall be conducted with ASTM D1037 – Standard Test Methods for Evaluating Properties of Wood-Base Fiber and Particle Panel Materials</li> </ul>
Diaphragm Strength	<ul style="list-style-type: none"> <li>• ICC-ES AC 376</li> </ul>

Table 2 – Required Evaluation of Cement Fiber Panels

### 1.3.2 – Core Materials

The core is responsible for providing thermal insulation, counteracting shear and transverse forces and resisting moisture penetration. The insulating core also reduces the panel’s weight (compared to some other prefabricated structural panel systems), making CSIPs easier to construct and better suited for seismic-active regions.

The properties of primary interest for core materials are density, shear modulus, shear stiffness, stiffness perpendicular to the faces, thermal insulation, and acoustic insulation.<sup>7</sup> The following tables describe the relevant performance of the most common core materials in the current SIP market.

Minimum Properties for SIP Insulating Core Materials			
Insulation Material	Type I EPS	Type X XPS	Polyurethane
Min. Density, lb./ft. <sup>3</sup>	0.9	1.30	2.2
Thermal resistance of 1.00 in. thickness, minimum °F-ft. <sup>2</sup> h/Btu at mean temperature: 40°F	4.0	5.4	6.7
Thermal resistance of 1.00 in. thickness, minimum °F-ft. <sup>2</sup> h/Btu at mean temperature 75°F (23.9°C)	3.6	5.0	X
Compressive resistance at yield or 10% deformation, whichever occurs first (with skins intact), minimum	10.0	15.0	19
Flexural strength, minimum, psi	25.0	40.0	30
Water vapor permeance of 1.00 in. thickness, maximum, perm (ng/Pa-s-m <sup>2</sup> )	5.0	1.1	2.3
Water absorption by total immersion, maximum, volume %	4	0.3	4.3
Dimensional stability, (change in dimensions), maximum, %	2	2	2
Tensile strength, minimum (ASTM D 1623), psi	X	X	35
Shear strength, minimum (ASTM C 273), psi	X	X	25
<i>X = Please reference manufacturer's data</i>			

Table 3 – Minimum Properties for SIP Insulating Core Materials<sup>8</sup>

Expanded Polystyrene (EPS) is the most common core material, used in 85% of all SIPs.<sup>9</sup> EPS has a closed-cell, moisture-resistant structure composed of millions of tiny air-filled pockets. It generally does not release ozone-depleting chlorofluorocarbons (CFCs). The material is molded into large blocks and cut to the proper shapes for use in SIPs.

<sup>7</sup> Zenkert, pg. 23.

<sup>8</sup> This chart was compiled using a list of minimum values for each material, taken from ASTM C 578, ASTM D 1622, ASTM D 1621, ASTM C 203, ASTM D 1623, ASTM C 273, ASTM E96, ASTM C 27, and ASTM D 2126.

<sup>9</sup> Morley, Michael. Building With Structural Insulated Panels. Pg. 23.

The IRC Prescriptive Method requires that SIPs use molded EPS as a core material. This EPS must meet the requirements of ASTM C 578 (referenced in “Minimum Properties for SIP Insulating Core Materials”), a consensus document developed by producers of polystyrene foam, third-party testing companies, regulatory agencies, and insulation users in North America. It covers the types, physical properties, and dimensions of cellular polystyrene used as thermal insulation for temperatures from -65°F to 165°F. Flame spread rating of SIP cores must be less than 75 and the smoke-development rating shall be less than 450, as tested in accordance with ASTM E 84. This does not mean all SIPs must use EPS, but if another material is used, it must be shown to be of equal or better performance by a professional engineer.

Extruded Polystyrene (XPS) is similar to EPS, but is not used nearly as frequently within the SIP industry. XPS performs almost twice as well as EPS in regards to compressive strength, flexural strength, and shear resistance. However, these benefits come at a significant cost: sheets of XPS are far more expensive, can only be made four inches thick, and do not create a perfectly flat gluing surface. Because of these drawbacks, XPS is used infrequently in the SIP industry.

Polyurethane or polyisocyanurate (both commonly referred to as urethane) is also used by manufacturers as an insulating material. Liquid foam is injected between two skins under considerable pressure, which hardens to produce a strong bond between the foam core and the skins. The foam core contains a blowing agent, some of which escapes over time, reducing the initial R-value of the SIP from about R-9 to R-7 per inch (2.5 cm) of thickness. Wall panels made of polyisocyanurate or polyurethane are typically 3.5 inches (89 mm) thick. Ceiling panels are up to 7.5 inches (190 mm) thick. These panels, although more expensive, are more fire-resistant and water vapor-diffusion-resistant than EPS.<sup>10</sup>

### 1.3.3 – Adhesives

The final component of a SIP assembly is the adhesive that bonds the facing and core materials. As with facing and core materials, there are several options for adhesive. No matter which option is chosen, this glue must:

- Resist Forces: The adhesive joint must be able to transfer the design loads (have the desired tensile and shear strength). They must resist buckling and racking forces.
- Thermal stresses: A frequent cause of debonding (and catastrophic failure of the panel) is due to thermal stress.
- Moisture Penetration: The adhesive must be able to withstand any sort of moisture penetration into the joint without delamination or bond failure.

Other variables of adhesive performance that must be considered include preparation requirements for application, required bonding pressure, adhesive viscosity, bond thickness, viscoelastic properties, and curing shrinkage.

---

<sup>10</sup> <http://www.eere.energy.gov/>



Defining the common performance properties of available adhesives is difficult because each is a proprietary material. However, any adhesive used in the construction of a SIP must comply with International Code Council Acceptance Criteria AC05.

## 1.4 – Factory Fabrication

SIPs and CSIPs are prefabricated under factory-controlled settings prior to use on a building site. The only code requirement for SIP fabrication is that the process must conform to quality documentation in accordance with ICC Acceptance Criteria 10. Despite proprietary variations from manufacturer to manufacturer, the process is relatively similar throughout the industry.

Prior to SIP fabrication, shop drawings are created for the panels, detailing exactly how each panel will fit into the overall building design. A count of the required panels, their dimensions, and special cuts (such as windows and doors) is created, and each panel is made specifically for its purpose within the building.

Typically, fabricating EPS- and XPS-core SIPs begins by placing one facing out on the assembly area. The desired thickness of core material is run through a glue-spreading machine, where the appropriate amount of glue is spread on both sides of the core. The core section is then placed on top of the bottom facing, and a top facing is positioned above it. This assembly is moved into a press, which applies even pressure to the top and bottom facings. Specific adhesives require different pressure, curing time, temperature, and humidity, all of which are controlled.

After the panels are removed from the press, they are set aside to cure for 24 hours. Once cured, they are moved to the fabrication section of the plant, where windows, doors, electrical chases, and other openings specific to the project are prepared.

The approach to urethane panels is rather different. Panel facings are separated at the required distance by spacers, and the mixed components of the foam core are injected between the facings. As the foam expands and fills the void, the foam bonds the two facings together without the need for an adhesive.

### 1.4.1 – CSIP Plant Optimization

Although the manufacturing of CSIPs is typologically similar to wood SIP manufacturing, the plant should address the following key issues and concerns:

- Dust control: dust created by fiber cement contains free silica, which can result in silicosis if inhaled. Dust control for the fabrication and handling of FCB is critical.
- Smaller unit sizes: FCB comes in dimensions of 4'x8', 4'x10', and 4'x12', while OSB ranges as high as 8'x24'.
- Higher weights per unit size: FCB is denser than OSB.
- Optimization of shop drawings to reduce fabrication.

Illustrated below is a 10,000 square foot SIP operation capable of producing roughly 1Mn square feet of panels per year (or roughly 250 to 300 affordable single-family homes per year). The capital costs in equipment are in the four SIP presses (roughly \$25K each), the glue spreader (roughly \$5K), the equipment to properly cut EPS to the desired size (roughly \$5K), the vertical panel saw (roughly \$5K) and the CNC machines (roughly \$15K each). The total investment required is roughly \$150K.

### Basic CSIP Manufacturing and Fabricating

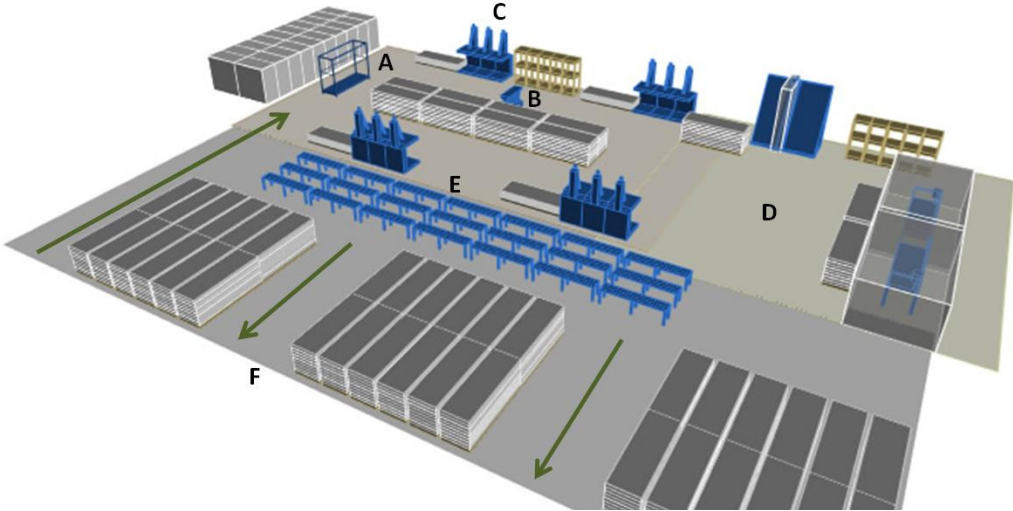

Figure 3 – Basic CSIP Manufacturing and Fabricating

This plant has three major zones: lamination (where the panels are laminated, denoted by A, B, C), basic fabrication (where the panels are cut, denoted by D), and final fabrication (where the panels are finished, labeled, organized, and shipped, denoted by E, F). These areas are outlined in the floor colors.

# Lamination

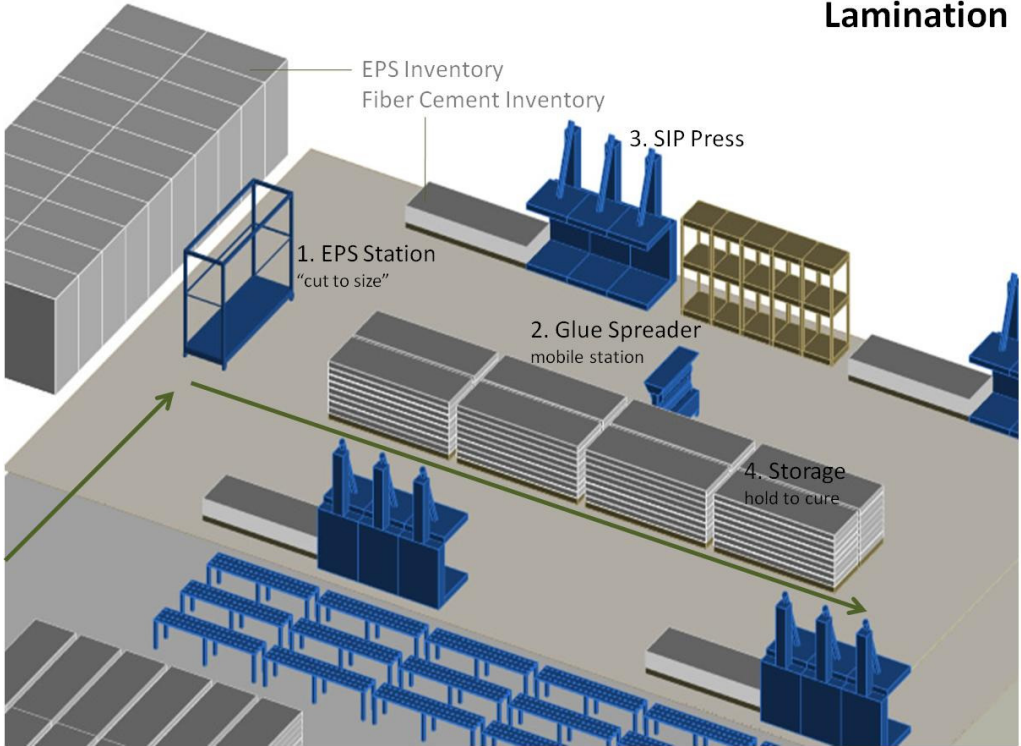

Figure 4 - Lamination

The process flow through the factory starts with the EPS station, where large blocks of EPS are inventoried and cut down to the desired panel size and thickness. Inventorying large blocks of foam is more cost-effective than inventorying various sizes of foam. This station’s primary tool is a hot wire station (1) that can rapidly tool the foam. From this station, the foam is delivered to the individual panel presses (3).

The panel presses (3) are hydraulic presses that deliver a consistent amount of pressure to properly adhere the foam and the facing. Because the glue is exothermic and expansive, the press must offset this pressure. Large bundles of fiber-cement board, which by themselves are extremely heavy, are pre-positioned at the head of the presses to reduce time and fatigue. Additionally, the mobile glue spreader (2) is prepositioned near the press and foam to decrease travel distances. The presses should contain built-in pallets, so removing the CSIPs from the presses is a nominal task.



Figure 5 – Typical SIP Press

The presses are loaded by laying one sheet of FCB on the press from the co-located bundles, spreading glue on the foam using the co-located glue spreader, placing the foam on top of the FCB, and registering the final face of FCB on the foam. This sequence is repeated until the press is fully loaded. The hydraulic press is preloaded (to take up any slack) and the panels are re-registered to ensure they are uniform. The hydraulic press is set to the desired pressure and left for two to three hours or until the glue is fully cured. The crew then moves to the next press location. Four presses are shown in the Figure 5 – Typical SIP Press” for a total rate of 100 to 120 panels a day (three batches for four presses each). This process is a small batched process and is not continuous. After the presses are unloaded, the product may be held for 24hours to fully cure (4).

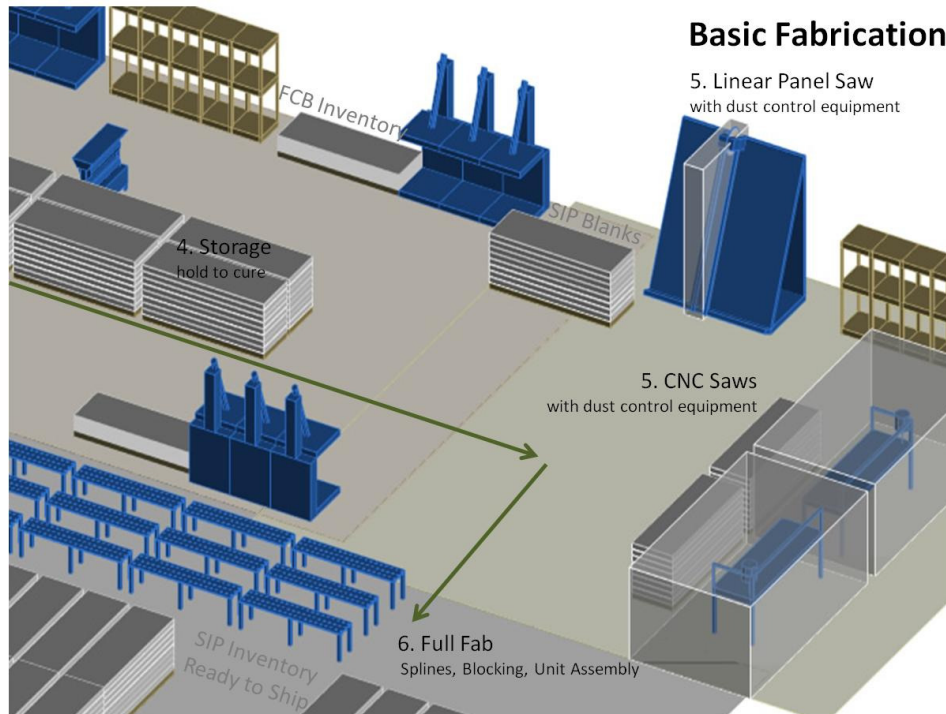

Figure 6 – Basic CSIP Fabrication

The next station is Basic Fabrication, where CSIP blanks (panels without any tooling) are cut to size or penetrations are cut out. These two tasks are the most critical in CSIP operations because they must be done with proper dust control. There are two primary cutting tools: (5) linear panel saws and CNC saws. The linear panel saw should be used when only one or two straight cuts are needed. A modified panel saw should be used with a blade capable of cutting a 6” panel. Next, for more complex cuts, a small CNC saw should be used with a tool capable of cutting through a 6” panel. These CNC saws are typically the lower end equipment (maximum of 4’x12’). Next the panels move to final or full fabrication, where the splines are cut, the panels are checked and labeled, and assemblies are cut, caulked, and primed (if allowed for). The rate by which basic fabrication runs is twelve panels per hour. Because many projects use blanks alone, this may or may not be the bottleneck and is the primary reason shop drawing optimization (to reduce cuts) is necessary.

At this stage, these panels flow on gravity conveyors to various stations.



Figure 7 - From Left to Right: Linear Panel Saw, CNC Saw, Gravity Conveyor

Staffing is based on the work team's education. Lamination requires two operators and one shop hand; Basic fabrication requires two to three operators and one shop hand. A general manager is needed for the plant. Shop drawings can be done in-house, remotely by consultants, or outsourced. Therefore, a total of six operators, four shop hands, and one general manager are needed.

Once fabricated, SIPs are shipped to a job site, where they are erected per the building design. Section 1.5 describes the installation of SIPs, water barriers, and windows in their current applications. The information shows how these requirements can be addressed in high-rise applications. Those wishing to skip these details may turn to Section 1.6, The Current SIP Market, or Section 1.7, Current Limitations for Multistory Applications.

### 1.5 – Current Use and Construction of Panels

Currently, CSIPs are limited to wall panel use in residential construction (governed by the IRC). Some companies detail roof panels, but comprehensive testing data on this use and use as a diaphragm is lacking. Because fiber-cement facing panels are limited to relatively small dimensions (e.g., 4'x8', 4'x10', and 4'x12'), all joints, connections, and penetrations must be properly managed, detailed, and constructed to provide adequate connection strength, proper moisture and water management, and reduced thermal shorts and bridges.

The following is a detailed guide that is typical in the industry. These details have been tested to all the relevant standards and have passed the weather barrier and thermal barrier tests. These details make some basic assumptions:

- Monolithic panels make up roughly 75% of typical residential envelopes with 90% of the panel being undisturbed (i.e., unbroken area);
- The splines and connection locations (horizontal or vertical) to other substructures make up the remaining 10% (nailed connection area) with localized drainage planes; and,
- Penetrations make up roughly 25% of all envelopes and should be limited to full panels (i.e., penetrations do not span multiple panels) with localized drainage planes and redundant layers of flashing.



**Figure 8 - CSIP Wall Construction**

For manufacturers, this means the panel shop drawings are based on window and door openings. These assumptions allow designers to assume the splines, connections, and penetrations can be made with localized drainage planes—multiple layers of water management and pressure equalization to allow moisture to move freely outside of the panel core—and additional layers to prevent water infiltration. Additionally, these detailing standards will encourage drying to the exterior and proper moisture management in any potential cavity. Basic standards include connections to substructures, splines, and all blocking in penetrations by the following standards. However, always consult your manufacturer for particular product specifications.

- Edge: 8d common nails, 6" o.c., ¼" from edges, 2" from corners
- Splines: 5.5" 19/32 OSB, 8d common nails, 6" o.c. ¼" from edges, 2" from corners
- Finishing: Prime entire envelope and openings with concrete masonry unit (CMU) block filler or equivalent to repair and patch any disturbed areas. Proceed with localized drainage planes and spaces around all penetrations.

Section 1.5.1 uses these standards unless otherwise noted.

### 1.5.1 – Installation of Typical Wall Panels

1. Installation of bottom plate—connection to foundation system or horizontal plate: Bottom plate is installed with a capillary break between plate and foundation. The bottom plate must be fastened and properly sealed to prevent air infiltration. Where required by code, metal Z-flashing can be installed on the outer face of the top plate-SIP for proper water management.

1. Installation to bottom  
plate



2. Installation of panel one: CSIP slips over bottom plate. Blocking installed in window penetrations at window opening. Note: window blocking installed at factory.

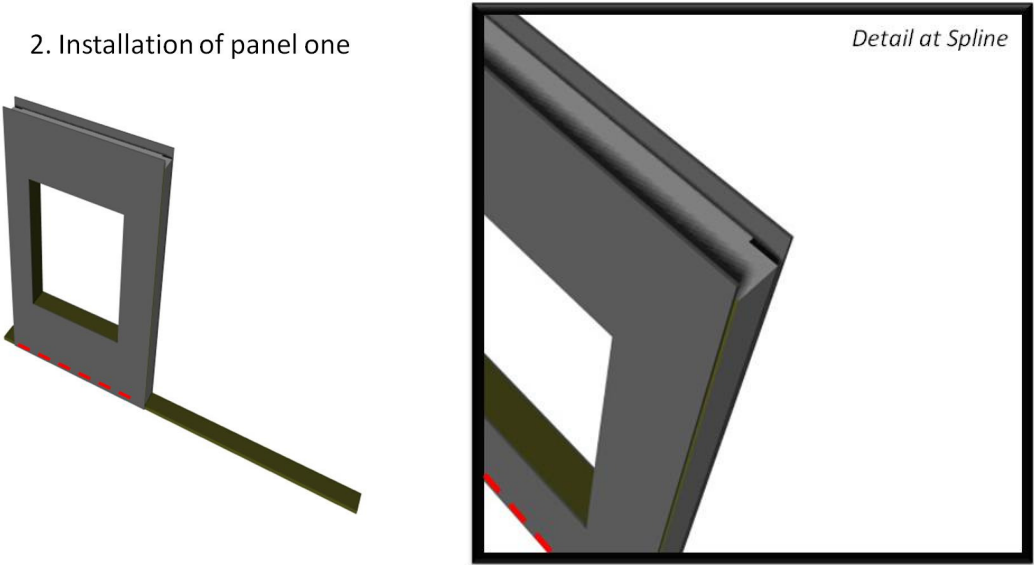

3. Installation of spline: Splines are comprised of 19/32 OSB or better splines, cut 5.5" wide to prevent telegraphing or "saw tothing" of panels. This detail recognizes the industry need to give generous spline widths and meet code minimums for fastening depth through the spline. More spline types are detailed later in this report.

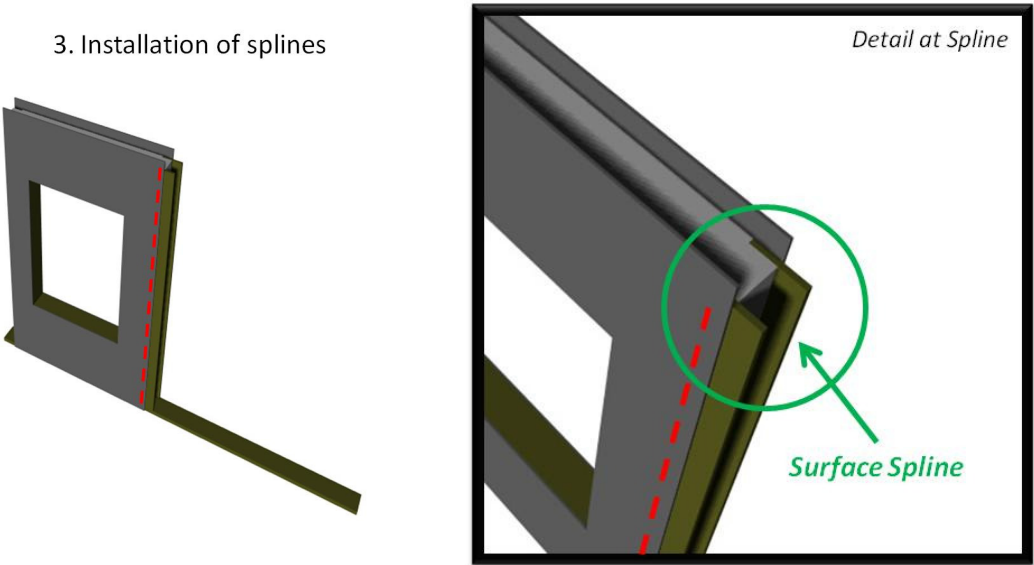



4. Installation of panel two: Refer to step 2.

4. Installation of panel two

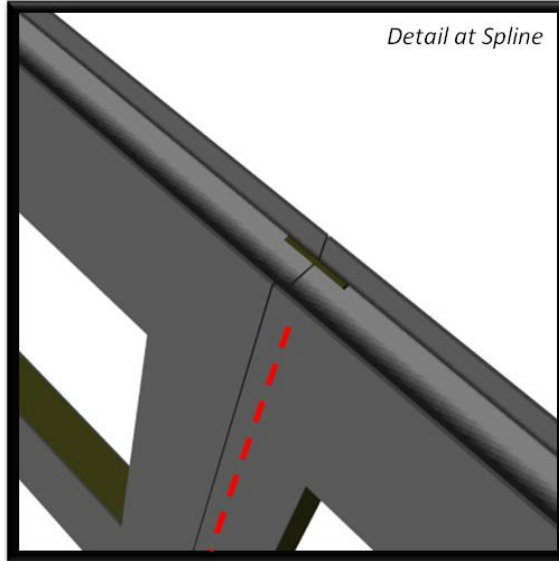
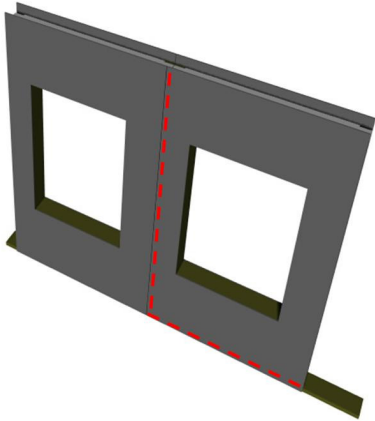

5. Installation of panel splines: Refer to step 3.

5. Installation of splines

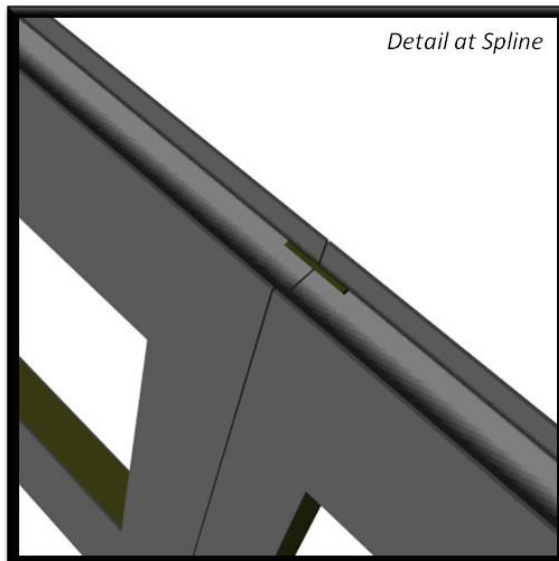
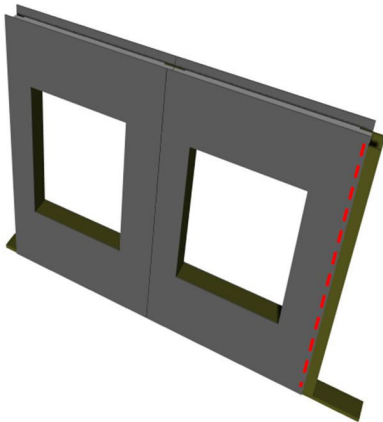

6 & 7. Installation of band plate and top plate: installed with 2x6 #3 or better. Plates must be tied together horizontally with and to the panel and must be tied together vertically.

6. Install band plate

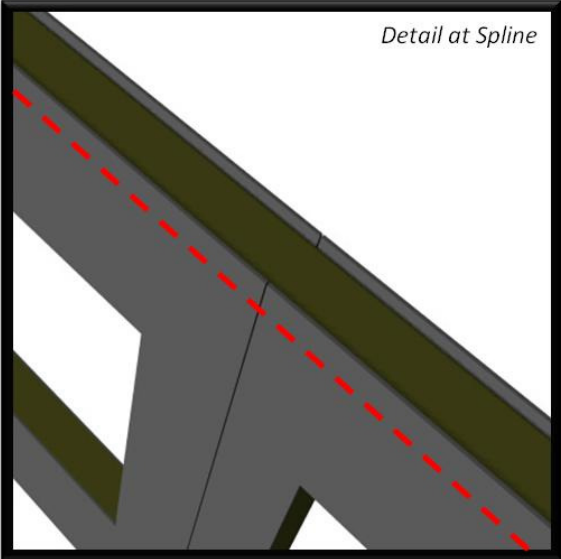
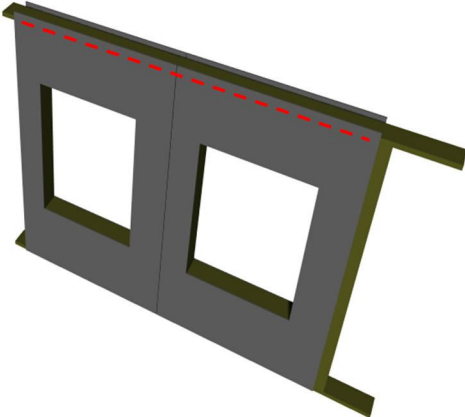

7. Install top plate

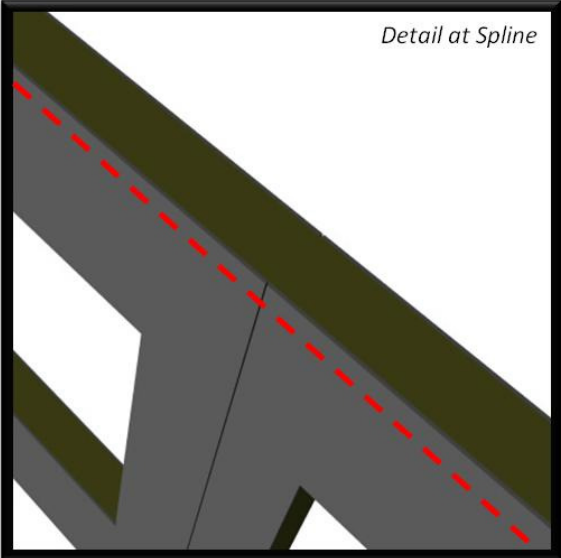
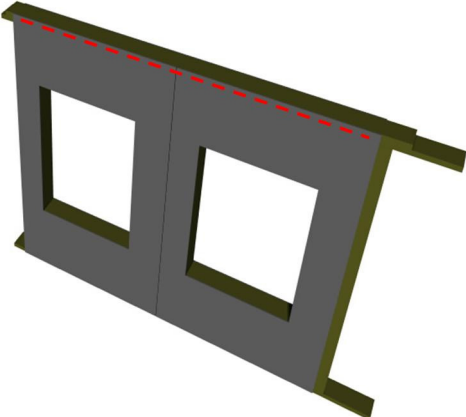

This concludes installing a basic panel. Subsequent panels tie directly into the installed panel to continue the wall plane.

## 1.5.2 – Construction of Weather Barrier and Window/Other Penetrations

The construction of the weather barrier follows. These details are shown both as an individual panel and as two combined panels.

8. CMU block fill primer: After all panels are set, the panels are primed to provide a continuous unbroken base finish using CMU block filler in all exposed surfaces and joints and potential surface defects and irregularities. The simple goal in this step is to specify a paint to fill imperfections, reduce water infiltration in pores, and seal all cracks and constructability issues. These paints should be specified with some latex qualities—such as elasticity to stretch and give.

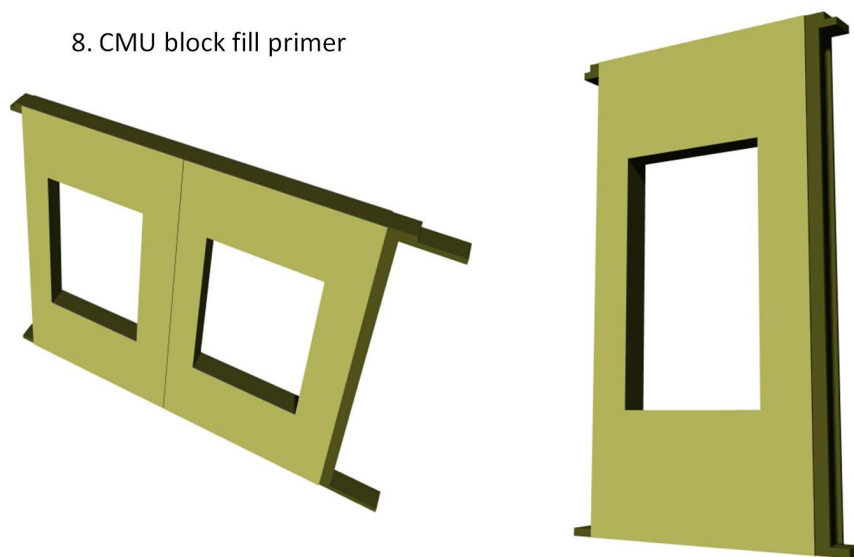

9a. Installation of pan flashing: Use self-adhering flexible flashing for pan flashing such as Dupont FlexWrap or StraightFlash to protect horizontal penetrations. This flashing must be cut so the ends extend past window openings. Fasten inner legs into jamb (minimum 1”) by slitting the flashing so one leg turns up the jamb and the other leg continues straight on the wall. Pan flashing must fit tightly into the opening. When using multiple pieces, pan flashing must overlap 3” at minimum. Note: if mechanical fastening is required, fasten only at the exterior face.

9b. Installation of jamb flashing: Use self-adhering flexible flashing protect vertical penetrations by cutting the flashing ends to extend past window openings. Fasten inner legs into jamb/head (minimum 1”) by slitting the flashing so one leg turns up the jamb and the other leg continues straight on the wall. The flashing must fit tightly into the opening; therefore, when using multiple pieces, pan flashing must overlap 3” minimum. Note: if mechanical fastening is required, fasten only at the exterior face.

9c. Installation of head flashing: Use self-adhering flexible flashing protect horizontal penetrations by cutting flashing only to fit into window to cover unprotected areas (i.e., use piece to overlap only in section unprotected by head). The flashing must fit tightly into the opening. When using multiple pieces, pan flashing must overlap 3" minimum. Note: if mechanical fastening is required, fasten only at the exterior face.

9. Installation of flashing



10a. Installation of window set: Only use windows with outer flange (i.e., nailing flange). Be sure to back caulk the window by applying sealant at window jambs and head. Use sealant at sill where required. Then set the window by installing the window level and plumb per the manufacturer's specifications.

10b. Installation of jamb flashing: Use self-adhering flexible flashing to protect vertical penetrations. Use continuous, unbroken piece (no mechanical fastening) and extend flashing above the window a minimum of 1" and below the window a minimum of 3".

10c. Installation of head flashing: Protect horizontal penetrations using self-adhering flexible flashing. Use continuous, unbroken piece (no mechanical fastening) and extend flashing 2" past jamb flashing.

10d. Installation of localized drainage space: Using polypropylene mesh deflection and ventilation system (or equivalent product to capture a void), provide a space for drainage to occur between the flashing and the trim pieces. An ideal product would be an equivalent tape, which could be stapled over the drainage planes to promote positive drain action within this space. This creates a cavity space to help manage water flow and drying to the outer wall.

10e. Installation of metal flashing: Install metal cap flashing above topmost trim by caulking joint between the metal flashing and the fiber-cement SIP. This is an important step because the drainage spaces and planes will allow any trapped water to move out of the assembly. However, the caulk will reduce the amount of water entering the space. This step should be considered a best practice.

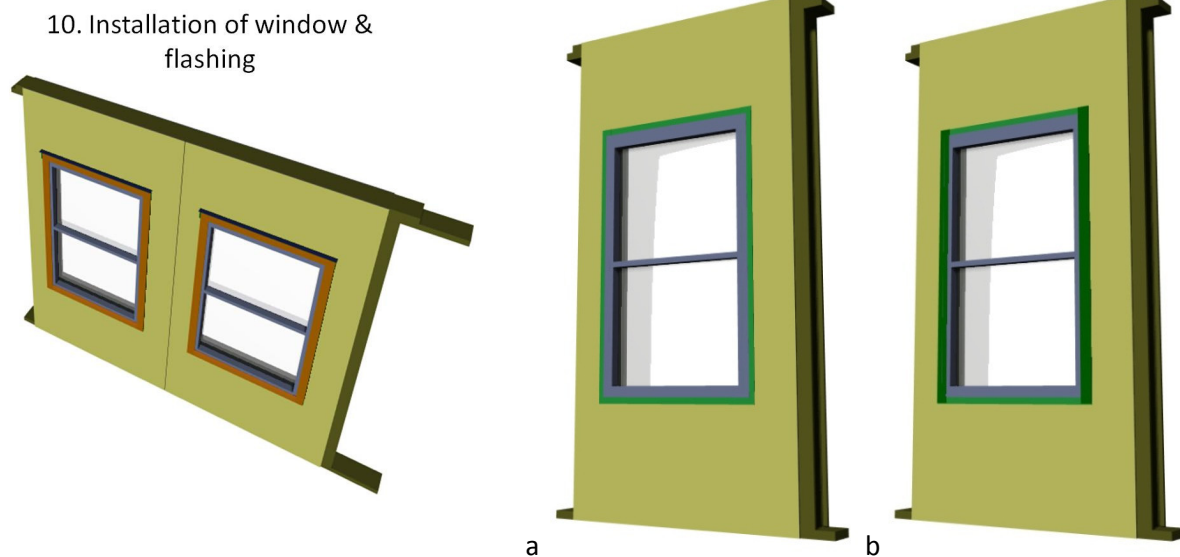

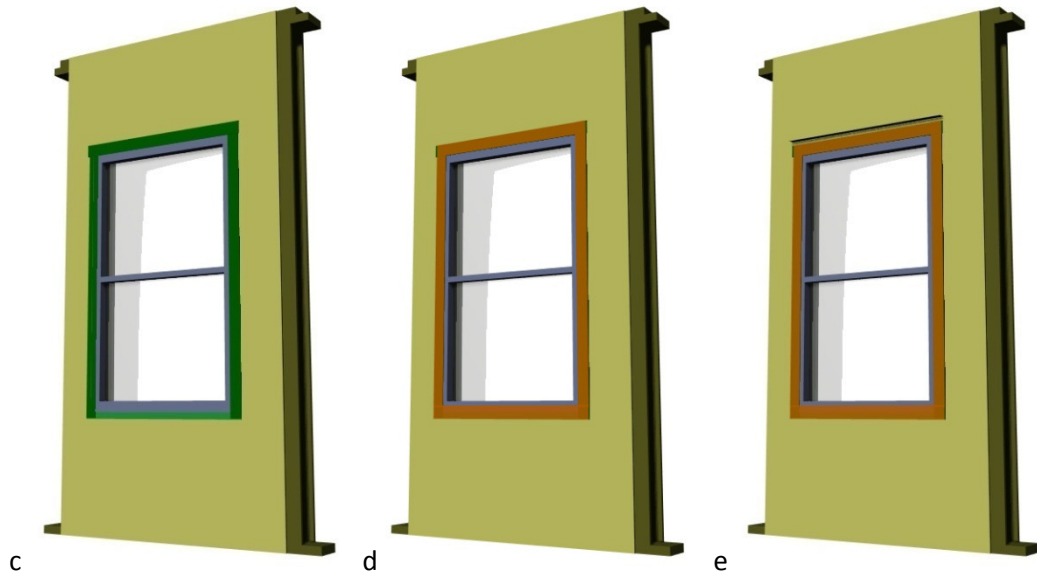

11. Installation of trim (a, b, c): Allow for positive drainage at all abutments and surface caulk all joints and other exposed areas. Follow the manufacturer's specifications.

11. Installation of trim





## 1.6 – The Current SIP Market

SIP usage has only been comprehensively tracked since 2003 through the industry trade association SIPA (Structural Insulated Panel Association). Currently there are roughly two dozen manufacturers and members in the association. This association represents some of the largest manufacturers in the industry but only a third to a half of the sandwich panel manufacturers in the United States. Domestic SIP production has remained near 50-60MN sq. ft. of panels annually which can easily be converted, to roughly a \$250-450Mn market cap at market rates of \$5-7.50 per sq. ft. SIP's annual growth has ranged from 2-12% annually until 2007 when the national new housing starts cooled and the industry shrunk, a projected, 11%.The reliability of these SIP numbers is questionable due to the small sample size and lack of standard reporting techniques.

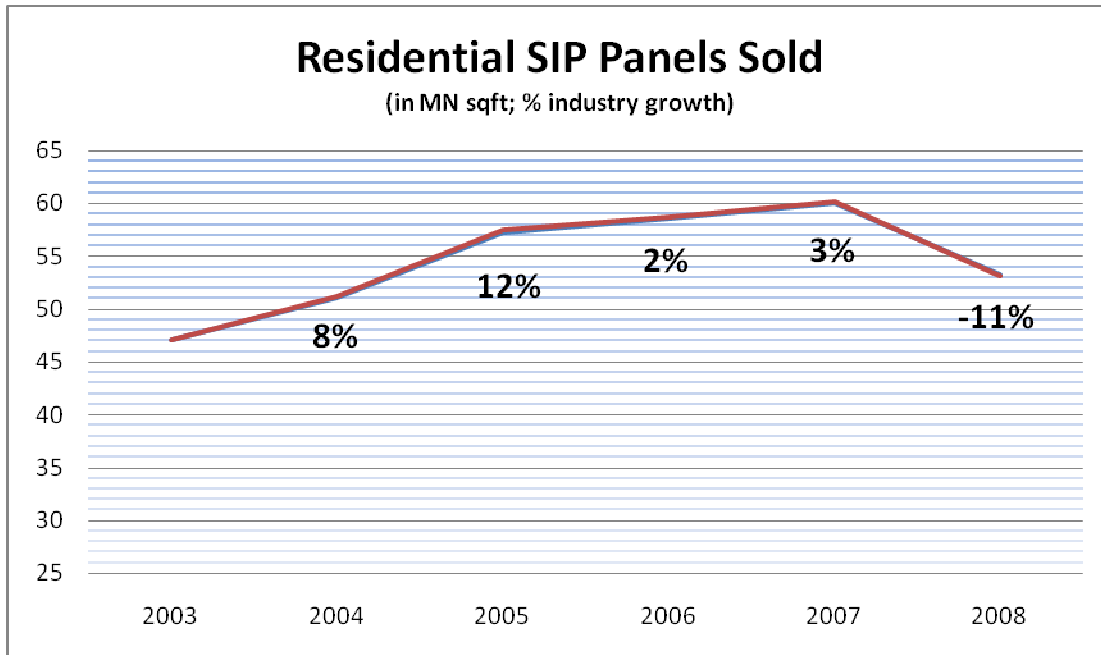

Figure 9 – Residential SIP Panels Sold, 2003-2008

*Note: 2008 data is published in 2Q 2009 and not yet available at the time of publishing this report; 2008 projections (represented above) are based on conversations with Bill Wachtler of SIPA.*

In 2007, the SIP market continued to be split evenly between residential and non-residential use. More importantly, SIPs can be broken down into panel types based on facings. Metal facings make up 50% of the market, followed by OSB on both sides (42%) and OSB on one side (6%). Plywood, fiber cement, and gypsum make up the remaining 2% of the market totaling 1.2M sq. ft. panels. Residential panel use is typically limited to OSB where non-residential use is typically comprised of metal. Metal SIPs are also used extensively in the refrigeration industry and for patio enclosures. Due to the current limitations of the Prescriptive acceptance of SIPs in the 2007 International Residential Code supplement, virtually all SIP buildings currently built are three stories or less.

Bill Wachtler, president of the Structural Insulated Panel Association, provided an update for this document prior to the official industry report to be published in second quarter 2009:

“Although production of structural insulated panels (SIPs) has decreased slightly in 2007 and 2008, it has largely avoided the plight of the U.S. housing market, according to an annual survey conducted by the Structural Insulated Panel Association (SIPA). In 2008, a year when single family housing starts dropped by 40 percent, SIP production experienced only a [10-]13 percent decrease. Similarly, total SIP production grew nearly 5 percent in 2007 despite a 29 percent decline in single family starts. Survey results showed that although the industry’s growth can be partially attributed to increased participation in the nonresidential market, it also indicates a



sizable gain in residential market share [projected to have increased from 0.75% of all new housing starts to 1.0% of all new housing starts].”<sup>11</sup>

### 1.6.1 – Market Growth Potential

The CSIP (and larger SIP) industry currently faces many obstacles to growth, but it carries significant potential for expansion within current and new markets.

The major current problem is a significant lack of awareness and technical knowledge from owners, builders, architects, engineers, and the general public. If these key members in the construction process aren't aware of CSIPs, they will not specify their use. This problem is compounded by a shortage of case histories and case studies, a lack of standardization and specifications within the industry, and a lack of knowledgeable installers, as well as the diverse base of small manufacturers. In addition, fire resistance performance and building codes limit large-scale growth. These issues are addressed in Sections 1.7, 2.2.8, 3.5, and 4.2.

Like any new building system, a builder's first SIP construction project is likely to have problems. However, SIP construction has a fast learning curve, and we must avoid the perception that SIPs are difficult to install.

In addition, CSIPs face the need for industry development. Since the industry is small, production capacity is limited and slow to respond to market opportunities. Also, the CSIP supply chain is in its infancy and has only limited distribution channels and lacks a strong, national brand name. Growth depends on finding more CSIP manufacturer start-ups to generate demand for the product, rather than waiting for the OSB-faced SIP industry to recognize the new market value of CSIPs and expand to include the new material in production lines. The potential for product failure due to a lack of technical background, a lack of continued service after sale, and a concern that a poor quality product could ruin the SIP industry's reputation are other potential problems for such a young industry.

Finally, testing, national standards, and inconsistencies in manufacturing facilities slow the industry's growth. CSIP needs industry partnerships to leverage applications testing, including producing more data on the panels' seismic, moisture, durability, and weatherization. This testing must also work toward informing a standardized process for manufacturing and acceptance. CSIP manufacturers must develop and conform to consensus-based reference standards (ANSI). This formal development of processes and standards is important for a certified CSIP to spread and pick up new manufacturing locations.

Despite these obstacles, SIPs are gaining market share within the construction industry, which is good and bad for CSIPs. Within the SIP industry, the overwhelming trend is to use OSB facings, so the technical approach is focused on one facing material. Even so, this use is also spreading an awareness of SIPs as a building technology independent of facing materials, making the recognition of and transition to cement-fiber facings easier.

---

<sup>11</sup> Email correspondence and conversations between Joe Hagerman and Bill Wachtler of SIPA.

For CSIPs to become a recognized substitute to SIPs, it requires code recognition and the removal of building size limitations. In addition, CSIPs must work for inclusion in the SIP Prescriptive Method for the IRC, and must work to extend a similar prescriptive method accepted into the International Building Code (IBC). Without being accepted directly into the code, every CSIP project will require engineering to show compliance. Overcoming this step will make it much easier for builders to choose CSIPs for their building projects.

Despite these obstacles, SIPs offer many qualities that are becoming increasingly desirable, and there is tremendous opportunity for CSIPs in current and new construction markets. This opportunity is largely driven by rapidly increasing energy and construction costs, and the ever-growing interest in “green” building. Due to their inherent energy-efficient performance and ease of construction, CSIPs are an attractive candidate for addressing these variables. When paired with other energy-efficient and green technologies, CSIPs favorably affect a building owner’s return on investment, asset turnover, opportunity cost, and environmentalism.

SIPs’ composite nature makes them versatile and desirable for both single- and multistory construction. For both building types, CSIPs are an enabling technology that reduce substructure demands. CSIPs also offer an easily constructed, thermally efficient, cost-effective alternative building envelope. The wealth of materials and design options available allows considerable flexibility for new designs and uses.

In sum, CSIPs require significant development to fully embrace their potential. This report systematically compiles data based on the current CSIP industry and includes a detailed description of its potential extensions and future development.

## 1.7 – Current Limitations for Multistory Application

Two major factors currently limit the application of CSIPs to multistory construction: building codes and CSIP performance. Building code limitations will be explained here, while the latter will be discussed in-depth in Section 2.

Currently, CSIPs are used in construction up to three stories. This report uses the term “multistory” to focus on buildings above this threshold. While the applicable building code for a project is determined by the municipality providing the building permit, the majority of municipalities have adopted the I-Codes, a set of codes created by the ICC. The ICC has created distinct codes for one- and two-story residential construction (IRC), larger commercial and industrial construction (IBC), energy conservation in buildings (IECC), and more. *For multistory construction, the IBC is the most widely adopted code and will govern the majority of the buildings within the scope of this report.*

Despite this baseline, local codes dictate the decisions and understanding of acceptable CSIP applications.

The basis for panels used in multistory construction is restricted by the following:

- Combustibility (discussed in Section 2.2.8.1) based on ASTM E136 - 04 Standard Test Method for Behavior of Materials in a Vertical Tube Furnace at 750°C and ISO 1182 Non-Combustibility Test for Building Materials limit CSIPs to:

- Type V construction (three story maximum per Table 503 ); limitations dictated by the building code in Chapter 6, Types of Construction, and Chapter 5, General Building Heights and Areas, and
- Exterior wall coverings in Type I buildings per 603.1.10.
- Fire Rating (discussed in Section 2.2.8.2) based on ASTM E119 - 08a Standard Test Methods for Fire Tests of Building Construction require CSIPs to conform to IBC 2603.4 Thermal Barrier. Note: each vendor must show compliance as a thermal barrier.
- Weather Barrier based on ASTM E331-00 Standard Test Method for Water Penetration of Exterior Windows, Skylights, Doors, and Curtain Walls by Uniform Static Air Pressure Difference require CSIPs to:
  - Conform to IBC 1403.2 as a weather barrier resistant to water intrusion and vapor permeance to allow drying while reducing vapor intrusion.
  - Weather barriers are manufacturer/vendor specific. Typical details shown in Section 1.5.3 have been known to pass the weather barrier requirements, but each manufacturer/vendor must show compliance as a weather barrier.
- Fiber-Cement Siding under IBC 1405.15 Fiber-Cement Siding as a Metal Veneer assembly (requiring the same fasteners, finishes, and other performance requirements of Metal Veneer assemblies.

The ways panels can be used in multistory construction are further limited by the following code provisions:

- Required fire ratings, Table 601 (discussed in 2.2.8)
  - CSIPs must obtain a fire separation distance greater than or equally to 30' (per Table 602) for exterior walls.
  - Joints in exterior walls are not required to have a fire rating (per 704.13).

TABLE 601 FIRE-RESISTANCE RATING REQUIREMENTS FOR BUILDING ELEMENTS (hours)									
BUILDING ELEMENT	TYPE I		TYPE II		TYPE III		TYPE IV	TYPE V	
	A	B	A <sup>e</sup>	B	A <sup>e</sup>	B	HT	A <sup>e</sup>	B
Structural frame <sup>a</sup>	3 <sup>b</sup>	2 <sup>b</sup>	1	0	1	0	HT	1	0
Bearing walls									
Exterior <sup>g</sup>	3	2	1	0	2	2	2	1	0
Interior	3 <sup>b</sup>	2 <sup>b</sup>	1	0	1	0	1/HT	1	0
Nonbearing walls and partitions	See Table 602								
Exterior									
Nonbearing walls and partitions	0	0	0	0	0	0	See Section 602.4.6	0	0
Interior <sup>f</sup>									
Floor construction	2	2	1	0	1	0	HT	1	0
Including supporting beams and joists									
Roof construction	1 1/2 <sup>c</sup>	1 <sup>c, d</sup>	1 <sup>c, d</sup>	0 <sup>d</sup>	1 <sup>d</sup>	0 <sup>d</sup>	HT	1 <sup>c, d</sup>	0
Including supporting beams and joists									

For SI: 1 foot = 304.8 mm.

a. The structural frame shall be considered to be the columns and the girders, beams, trusses and spandrels having direct connections to the columns and bracing members designed to carry gravity loads. The members of floor or roof panels which have no connection to the columns shall be considered secondary members and not a part of the structural frame.

b. Roof supports: Fire-resistance ratings of structural frame and bearing walls are permitted to be reduced by 1 hour where supporting a roof only.

c. Except in Group F-1, H, M and S-1 occupancies, fire protection of structural members shall not be required, including protection of roof framing and decking where every part of the roof construction is 20 feet or more above any floor immediately below. Fire-retardant-treated wood members shall be allowed to be used for such unprotected members.

d. In all occupancies, heavy timber shall be allowed where a 1-hour or less fire-resistance rating is required.

e. An approved automatic sprinkler system in accordance with Section 903.3.1.1 shall be allowed to be substituted for 1-hour fire-resistance-rated construction, provided such system is not otherwise required by other provisions of the code or used for an allowable area increase in accordance with Section 506.3 or an allowable height increase in accordance with Section 504.2. The 1-hour substitution for the fire resistance of exterior walls shall not be permitted.

f. Not less than the fire-resistance rating required by other sections of this code.

g. Not less than the fire-resistance rating based on fire separation distance (see Table 602).

Figure 10 - Fire Resistance Rating Requirements for Building Elements<sup>12</sup>

<sup>12</sup> Table 601, 2006 International Building Code.

In addition, building height is limited by use and type of construction, per Table 503 of the IBC:

<b>TABLE 503</b>										
<b>ALLOWABLE HEIGHT AND BUILDING AREAS<sup>a</sup></b>										
Height limitations shown as stories and feet above grade plane.										
Area limitations as determined by the definition of "Area, building," per story										
GROUP	HGT(feet)	TYPE OF CONSTRUCTION								
		TYPE I		TYPE II		TYPE III		TYPE IV	TYPE V	
		A	B	A	B	A	B	HT	A	B
		UL	160	65	55	65	55	65	50	40
A-1	S	UL	5	3	2	3	2	3	2	1
	A	UL	UL	15,500	8,500	14,000	8,500	15,000	11,500	5,500
A-2	S	UL	11	3	2	3	2	3	2	1
	A	UL	UL	15,500	9,500	14,000	9,500	15,000	11,500	6,000
A-3	S	UL	11	3	2	3	2	3	2	1
	A	UL	UL	15,500	9,500	14,000	9,500	15,000	11,500	6,000
A-4	S	UL	11	3	2	3	2	3	2	1
	A	UL	UL	15,500	9,500	14,000	9,500	15,000	11,500	6,000
A-5	S	UL	UL	UL	UL	UL	UL	UL	UL	UL
	A	UL	UL	UL	UL	UL	UL	UL	UL	UL
B	S	UL	11	5	4	5	4	5	3	2
	A	UL	UL	37,500	23,000	28,500	19,000	36,000	18,000	9,000
E	S	UL	5	3	2	3	2	3	1	1
	A	UL	UL	26,500	14,500	23,500	14,500	25,500	18,500	9,500
F-1	S	UL	11	4	2	3	2	4	2	1
	A	UL	UL	25,000	15,500	19,000	12,000	33,500	14,000	8,500
F-2	S	UL	11	5	3	4	3	5	3	2
	A	UL	UL	37,500	23,000	28,500	18,000	50,500	21,000	13,000
H-1	S	1	1	1	1	1	1	1	1	NP
	A	21,000	16,500	11,000	7,000	9,500	7,000	10,500	7,500	NP
H-2 <sup>d</sup>	S	UL	3	2	1	2	1	2	1	1
	A	21,000	16,500	11,000	7,000	9,500	7,000	10,500	7,500	3,000
H-3 <sup>d</sup>	S	UL	6	4	2	4	2	4	2	1
	A	UL	60,000	26,500	14,000	17,500	13,000	25,500	10,000	5,000
H-4	S	UL	7	5	3	5	3	5	3	2
	A	UL	UL	37,500	17,500	28,500	17,500	36,000	18,000	6,500
H-5	S	4	4	3	3	3	3	3	3	2
	A	UL	UL	37,500	23,000	28,500	19,000	36,000	18,000	9,000
I-1	S	UL	9	4	3	4	3	4	3	2
	A	UL	55,000	19,000	10,000	16,500	10,000	18,000	10,500	4,500
I-2	S	UL	4	2	1	1	NP	1	1	NP
	A	UL	UL	15,000	11,000	12,000	NP	12,000	9,500	NP
I-3	S	UL	4	2	1	2	1	2	2	1
	A	UL	UL	15,000	10,000	10,500	7,500	12,000	7,500	5,000
I-4	S	UL	5	3	2	3	2	3	1	1
	A	UL	60,500	26,500	13,000	23,500	13,000	25,500	18,500	9,000
M	S	UL	11	4	4	4	4	4	3	1
	A	UL	UL	21,500	12,500	18,500	12,500	20,500	14,000	9,000
R-1	S	UL	11	4	4	4	4	4	3	2
	A	UL	UL	24,000	16,000	24,000	16,000	20,500	12,000	7,000
R-2	S	UL	11	4	4	4	4	4	3	2
	A	UL	UL	24,000	16,000	24,000	16,000	20,500	12,000	7,000
R-3	S	UL	11	4	4	4	4	4	3	3
	A	UL	UL	UL	UL	UL	UL	UL	UL	UL
R-4	S	UL	11	4	4	4	4	4	3	2
	A	UL	UL	24,000	16,000	24,000	16,000	20,500	12,000	7,000
S-1	S	UL	11	4	3	3	3	4	3	1
	A	UL	48,000	26,000	17,500	26,000	17,500	25,500	14,000	9,000
S-2 <sup>b,c</sup>	S	UL	11	5	4	4	4	5	4	2
	A	UL	79,000	39,000	26,000	39,000	26,000	38,500	21,000	13,500
U <sup>c</sup>	S	UL	5	4	2	3	2	4	2	1
	A	UL	35,500	19,000	8,500	14,000	8,500	18,000	9,000	5,500

Figure 11 - Allowable Height and Building Areas<sup>13</sup>

Please note each manufacturer should supply data (through evaluation or certification reports) that it has completed and verified proper testing demonstrating its system complies with the respective ICC codes. More information on this concept can be found in Section 4.2.

<sup>13</sup> Table 503, 2006 International Building Code.