



2013

Basics in EMC/EMI and Power Quality
Introduction, Annotations, Applications

SCHAFFNER
energy efficiency and reliability



Basics in EMC and Power Quality

I	Introduction	5
1	Sources of electromagnetic signals	5
1.1	Natural and technical sources of electromagnetic signals	5
1.2	Definition of noise	5
1.2.1	Frequency ranges	5
1.2.2	Differential-mode noise	6
1.2.3	Common-mode noise	6
1.3	Noise propagation	6
1.3.1	Coupling methods	6
1.3.2	Radiation	6
2	Legal requirements	7
2.1	Global legislation	7
2.1.1	CE marking for the European Union	7
2.1.2	CCC and CQC approvals for China	8
2.1.3	FCC registrations for the USA	8
2.1.4	EMC framework in Australia/New Zealand	9
2.1.5	VCCI registrations for Japan	9
2.1.6	Other international requirements	9
2.2	EMC standards	9
2.2.1	Standard classification	10
2.2.2	Common limit lines	12
2.3	Safety approvals	12
2.3.1	EMC testing as a service	13
2.3.2	The test	13
3	EMC measurements	13
3.1	Emission	13
3.1.1	High-frequency (HF) radiated emission	13
3.1.2	High-frequency conducted emission	14
3.1.3	Discontinuous interference (clicks)	15
3.1.4	Mains harmonics	16
3.1.5	Voltage fluctuations and flicker	16
3.2	Immunity	17
3.2.1	RF immunity	17
3.2.2	Conducted immunity	18
3.2.3	Radiated immunity	19
3.2.4	Transient immunity	19
3.2.5	Electrostatic discharges (ESD)	19
3.2.6	Electrical fast transients (bursts)	20
3.2.7	Surge	21
3.2.8	Power magnetic fields	21
3.2.9	Supply network	21

4	Noise suppression	23
4.1	Conceptual EMC	23
4.2	Shielding	23
4.2.1	Shielded housings	23
4.2.2	Shielded cables	23
4.3	Grounding	24
4.3.1	Grounding concepts	24
4.3.2	Earthing	24
4.4	Suppression components	24
4.4.1	Chokes	25
4.4.2	Capacitors	26
4.4.3	Filters	27
4.4.4	Filter attenuation	28
5	Power quality	28
5.1	Definition	28
5.1.1	Frequency ranges	29
5.2	Reactors in drive systems	29
5.2.1	Need for protection	29
5.2.2	Overview of uses	30
5.2.3	Line input	30
5.3	Output solutions for motor drives	31
5.3.1	dv/dt – voltage potential jumps in relation to the time	31
5.3.2	Voltage overshoots and voltage peaks	31
5.3.3	Additional losses in the motor	32
5.3.4	Cable shields and parasitic earth currents	32
5.3.5	Bearing damage	32
5.3.6	Acoustic noise levels	33
5.3.7	Solutions for output problems	33
II	Annotations to filter specifications	35
1	Filter ratings	35
1.1	Electrical specifications	35
1.1.1	Current	35
1.1.2	Voltage	35
1.1.3	Frequency	36
1.1.4	DC resistance	36
1.1.5	Discharge resistors	36
1.1.6	MTBF	36
1.2	Mechanical specifications	36
1.2.1	Mechanical tolerances	36
1.2.2	Filter terminals and cable cross-sections	37
1.2.3	Torque specifications	38

1.3	Environmental requirements	38
1.3.1	RoHS	38
1.3.2	Vibration and bump testing	39
1.3.3	Climatic classification	39
2	Safety requirements	39
2.1	Type testing	39
2.2	Hipot testing	39
2.3	Leakage currents	40
2.4	Flammability classification	41
2.5	Fuses	41
3	Power distribution networks	42
3.1	Designation of networks	42
3.2	TN network	42
3.2.1	TN-S system	42
3.2.2	TN-C and TN-C-S systems	42
3.3	TT network	42
3.4	IT network	42
3.5	Network with one grounded phase	43
4	Installation instructions	43
4.1	Installation of filters	43
4.2	Cable connection and routing	44
4.2.1	Shield connections	44
4.2.2	Cable routing	44
4.3	EMC planning	44
III	Typical applications	45
1	Choke applications	45
2	Power supply applications	45
3	Medical applications	46
4	Test and measurement equipment	47
5	Motor drive applications	47
6	Energy regeneration	47
7	Renewable energies	49
8	NEMP applications	51
9	TEMPEST applications	51
10	Communication equipment	51
11	Shielded rooms	51
IV	Abbreviations	52

I Introduction

1 Sources of electromagnetic signals

Electromagnetic signals are the result of electrical currents and voltages. Whenever electricity is used to drive equipment, an electromagnetic signal ensues as well. These signals can be used to transmit information from one point to the next, or they can simply be a byproduct of the operation of equipment. Where the signals are unintended, we speak of electromagnetic noise. It is this noise that can cause equipment to malfunction, and manufacturers must therefore take steps to reduce the effects of noise.

In this chapter we will mainly look at the unwanted noise, but for the purpose of explanation we will sometimes also refer to intended signals. Most people are more aware of the intended signal transmission than of unintended signals.

1.1 Natural and technical sources of electromagnetic signals

To a certain extent, electromagnetic signals are natural phenomena. One of the best known phenomena is a lightning strike, which is nothing more than a huge current flowing from a cloud towards Earth. This current causes high electromagnetic fields. Other than that, we also have atmospheric radiation. These types of signals are comparably small and are generally not considered for EMC on an equipment level.

More important for our purposes are the technical sources of electromagnetic signals. Electrically powered equipment, as already mentioned, is one such source. In this category we can identify two main sources of electromagnetic noise: power supplies and motor drive systems. On the other hand, we also purposely generate signals in order to transmit them over a distance, as in a TV station. With the increase of communication and especially wireless services, this element is becoming more and more important.

1.2 Definition of noise

The intended generation of signals for information transmission is not considered noise, but it does have an impact on the overall EMC of equipment. This will come up again in a later chapter. In this chapter, our focus is on unwanted noise signals and their characteristics.

1.2.1 Frequency ranges

A key characteristic of electromagnetic noise is its frequency. The EMC standards generally cover the range from 0 Hz to 400 GHz. Currently, however, not all frequency ranges are completely regulated.

The first important frequency range is the range around the power network frequency, which in Europe is 50 Hz. Most loads connected to the power network are non-linear loads, i.e., they draw a current that does not follow the sinusoidal voltage. Non-linear loads have the characteristic of generating additional currents at multiples of the network frequency. These currents are called harmonics and are generally considered up to the 40th or 50th order. In other words, our first frequency range starts at 50 Hz and ends at 2 kHz or 2.5 kHz. For 60 Hz networks, the range goes from 60 Hz to 2.4 kHz or 3 kHz. From the end of the harmonics range to 9 kHz, we have a frequency range that is not currently regulated. We will come back to this in the "Power quality" chapter. Above 9 kHz, the high-frequency range starts. This range is also called the radio-frequency or RF range. Radio frequency is the collective term for all frequencies from a few kilohertz to several gigahertz. EMC standards limit the frequency range to 400 GHz on the upper end, although test methods for such frequencies have not been defined yet. Current standards define testing methods from 9 kHz to 1 GHz, and some newer versions go up to 2 GHz or higher. The technical progress today is faster than the development of standards. Computers and communication equipment use fundamental frequencies that are already above 2 GHz. Looking at harmonic frequencies, even a 2 GHz upper limit is no longer sufficient to cover RF problems.

The RF range is generally split into a conducted and a radiated range. For the lower part of the RF range, noise is expected to travel along lines rather than radiate from the equipment. The main reason for this is that the required antenna structures are bigger for lower frequencies. In other words, the physical size of most equipment is simply not sufficient to radiate low frequency noise. While an exact frequency cannot be defined, the standards generally set the conducted RF range from 150 kHz to 30 MHz. Some standards also start at the lower frequency of 9 kHz. The radiated range then starts at 30 MHz. The upper limit of this range depends on the standard, but it will generally be about 1 GHz, for some products 2 or 3 GHz. To summarize, we have the following ranges:

Harmonics	LF range	Conducted RF range	Conducted RF range	Radiated RF range	Radiated RF range
50 Hz–2/2.5 kHz 60 Hz–2.4/3 kHz	2/2.5 Hz–9 kHz 2.4/3 kHz–9 kHz	9 kHz–150 kHz	150 kHz–30 MHz	30 MHz–1/2/3 GHz *	Above 3 GHz
Regulated range		Regulated range for some products			
Unregulated range		* Upper limit depends on product			

Definition of frequency ranges

The defined testing methods for these frequency ranges are explained in a later chapter.

1.2.2 Differential-mode noise

Looking at conducted signals, noise can occur between any two lines of the system. In a single-phase system this could be between phase (P) and neutral (N) lines. In a three-phase system it could be phase 1 (R) and phase 2 (S). In DC systems, the noise can travel from plus to minus. Such noise is called differential-mode noise or symmetrical noise. The picture below shows differential-mode noise in a single-phase system.

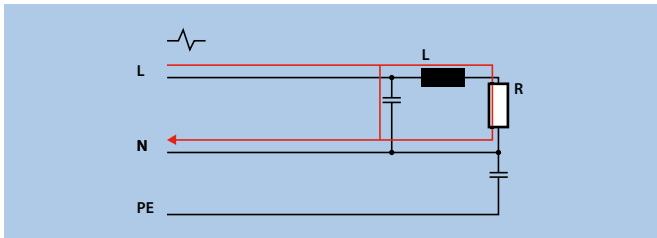

Differential-mode noise in single-phase systems

Differential-mode noise is a result of parasitic components in a circuit, such as equivalent series inductance (ESL) or equivalent series resistance (ESR) or components. In an electronic system, differential-mode noise usually occurs at lower frequencies and is commonly associated with the switching frequency of a switch-mode power supply or a motor drive.

1.2.3 Common-mode noise

Noise can also be conducted from any line in the system towards earth. In a single-phase system, signals could go from L and P towards earth. This type of noise is then called common-mode noise. The main difference is that common-mode noise travels in all lines in the same direction and then towards earth. The picture below shows common-mode signals in a single-phase system.

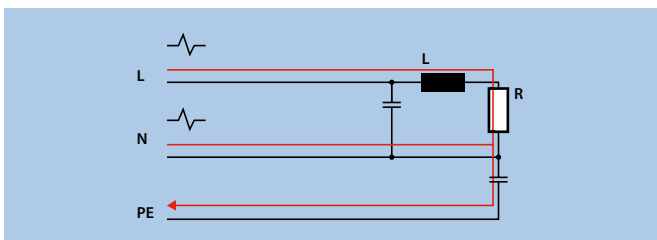

Common-mode noise in single-phase systems

Common-mode noise results from stray capacitances in a system, often occurring between semiconductors and heat sinks. It is more often found in the higher frequency range.

When we look at the measurements later, we will see that the result of the measurement does not make the differentiation between the two types of noise. For noise suppression, however, it is crucial to understand what kind of noise signal we are dealing with.

1.3 Noise propagation

Electromagnetic signals are generated in electrical and electronic systems and can then propagate inside the system or even outside. This propagation can work along lines or through radiation. These coupling paths are explained in the following paragraphs.

1.3.1 Coupling methods

Looking at the connections in an electrical or electronic system, we can identify three different coupling paths. One is galvanic coupling, which requires a direct connection between the single parts of the system. Second is capacitive coupling, which can happen when two cables of the system are routed close to each other, thus forming a parasitic capacitor. Where cable loops of different cables are laid out too close to each other, inductive coupling can occur.

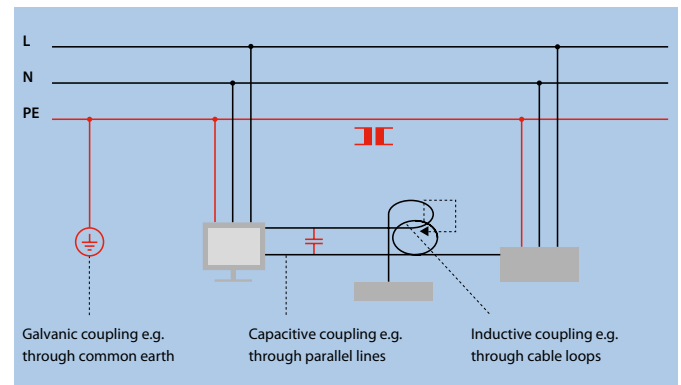

Coupling paths between systems

Galvanic coupling effects often ensue due to common ground connections. Capacitive coupling is typical for industrial applications, where power and signal lines are laid parallel over long distances.

1.3.2 Radiation

Noise can not only propagate along direct connections but also through the air via radiation. Once HF signals are generated inside a system, they are simply propagating along the path of least resistance. If the structure or layout of the system provides good antenna characteristics, the signals will use those parasitic antennas and radiate from the system into the air. There, the noise travels as electromagnetic waves and can be picked up by other equipment along its path.

2 Legal requirements

2.1 Global legislation

Electromagnetic phenomena and their effect on electric and electronic equipment have compelled many countries to implement measures that ensure the proper operation of equipment. Originally, most requirements came from military sectors and civil aviation, where the need for flawless operation of equipment is strongly related to the safety of people. Only later, when the use of electronic components expanded into almost every aspect of our lives and wireless transmission and communication systems became increasingly important, did requirements for electromagnetic compatibility expand into other civil sectors.

Legislation in various countries produced regulations and standards with which equipment has to comply. Since legislative systems vary from country to country, the compliance schemes used in each country are also very different. Where some schemes entail strong legislation and mandatory approval rules, others rely on voluntary registration and manufacturers' responsibility.

2.1.1 CE marking for the European Union

The concept of CE marking tries to reduce the huge number of national approvals by introducing harmonized rules. These rules are written in the EU directives. The directives as such are not legally binding to manufacturers, but all member countries are obliged to convert any approved directive into national law within a given period of time. Any failure to do so is a direct violation of European law, and the member state doing so will be punished.

The CE marking in this context is the mark of the manufacturer, indicating that the product is in compliance with all applicable directives. In addition to the CE marking, the manufacturer has to prepare a declaration of conformity stating that the described product is in compliance with the directives.



CE mark

This was meant to make trading easier for manufacturers, since they do not have to go through the ordeal of national approvals for each country. This requires, however, that manufacturers know which directives exist, are approved and apply to each of their products.

The EU does not offer comprehensive information on this topic. For this reason, the European system is very often regarded as difficult and prohibitive.

As mentioned before, the rules are defined in the European directives, which are then converted into national laws. As one example, the EMC directive with the title 89/336/EU was converted into law in each member state, such as the German EMC Act from November 1992. Each directive also defines the conformity procedures that can be used to show compliance with the directive. The directives contain the technical contents to be harmonized. They do not contain any guidelines about implementation and fining systems. As a result, non-compliant equipment can lead to a fine in one country but imprisonment in another.

The EU has produced a number of basic directives, such as the CE marking directive, with the purpose of defining procedures applicable to many other directives. One directive defines all existing conformity procedures. However, not all of these procedures can be used for all directives.

Typical conformity routes are modules A (self-declaration), B (competent body) and H (notified body). Other conformity routes would be type approvals in connection with a certified quality system (medical directive).

The scope of the EMC directive is very general. All products likely to emit or be susceptible to electromagnetic energy are covered.

To show compliance with the directive, products must not emit EM energy in an amount sufficient to affect other equipment. At the same time, each piece of equipment must be sufficiently immune against EM energy from other sources.

This leaves a lot of room for interpretation and speculation, and the EU soon released an unofficial document providing guidance on the EMC directive. A new version of the EMC directive is also forthcoming to further clarify the gray areas of the initial directive.

However complicated the EMC directive may seem, it still covers its main purpose. It removes the necessity to test to various national standards and guarantees acceptance in all EU member states.

The conformity routes permitted by the EMC directive are self-declaration, competent body route and EC-type approval by a notified body. This is due to change in the new directive, however, where the institution of a competent body is completely removed and only notified bodies remain. The self-declaration route is a way for manufacturers to take care of their approvals without involving any third parties. For the EMC directive, conformity can be assumed if the product is in compliance with existing harmonized EMC standards.

We will explain the system of harmonizing standards in a later chapter. The manufacturer can therefore test its product against these standards and then declare the conformity.

Where harmonized standards do not exist or testing is uneconomical, the manufacturer has the option of involving a competent body. The manufacturer prepares a technical construction file (TCF), which should contain all EMC-relevant information, including testing data. The TCF is then checked by the competent body, and if the EMC

concept is clear and acceptable, the competent body will issue a certificate.

For radio transmitting devices (for example, radio telephones), the involvement of a notified body is mandatory. The manufacturer has to submit documents and one sample to the notified body for testing and approval.

As mentioned before, the situation with competent and notified bodies will change in the future. The new directive no longer contains the competent body approval route. The notified body will assume the tasks of the competent body. However, the involvement of notified bodies is no longer mandatory, even if harmonized standards are not used. Approvals of radio transmitting devices are no longer in the scope of the EMC directive, having been handled for some time now by the telecom directive. The changes from this new EMC directive will come into effect on July 20, 2007, with an additional two-year transition period.

2.1.2 CCC and CQC approvals for China

CQC develops voluntary product certification services called CQC Mark Certification for products that fall outside the compulsory certification catalog. The aim is to protect consumers and property, safeguard consumer rights and interests, improve the product quality of domestic enterprises, increase product competitiveness in the international market and facilitate the access of foreign products to the domestic market. CQC, as the body that earlier conducted quality certification activities and a high authoritative body in China, is a brand well known in the world. This, in turn, can greatly enhance the brand image of the enterprises it certifies.

In December 2001, the State General Administration of Quality Supervision, Inspection and Quarantine of the People's Republic of China issued the regulations for compulsory product certification. The Compulsory Product Certification System began to replace the original Quality License System for Commodity Inspection and Safety Certification System for Electrical Equipment. The abbreviation of the China Compulsory Product Certification is CCC or 3 C. It is the statutory compulsory safety certification system and the basic approach to safeguarding consumer rights and interests and protecting personal and property safety adopted widely by international organizations.

China Compulsory Certification System came into force on May 1, 2002. In accordance with the joint announcement no. 38 [2003] by the State General Administration for Quality Supervision and Inspection and Quarantine of the People's Republic of China and the Certification and Accreditation Administration of the People's Republic of China, the date for implementing the supervision and management of the market for compulsory product certification was set as August 1, 2003.

The compulsory product certification requirements cover 135 products divided into 20 categories, including household appliances, motor vehicles, motorcycles, safety goggles, medical devices, lighting apparatuses, cables and wires. CQC has been appointed to undertake the work of compulsory product certification for 17 categories within the CCC catalog.

2.1.3 FCC registrations for the USA

Approvals for the American market are usually related to the Federal Communications Commission (FCC). The FCC is an independent United States government agency, directly responsible to Congress. The FCC was established by the Communications Act of 1934 and is charged with regulating interstate and international communications by radio, television, wire, satellite and cable. The FCC's jurisdiction covers the 50 states, the District of Columbia, and U.S. possessions.

The most commonly referred to regulation is part 15, which covers all commercial products. Like the European standards, the FCC rules define environments for residential and industrial areas.

Equipment used in residential areas requires verification and certification. The equipment has to be tested in a test site and by testing personnel listed by FCC.

In recent amendments to the rules, FCC now enables manufacturers to use the same testing methods as laid out in CISPR 22, with only minor additional rules. Other commonly used rules of the FCC are the parts 18 for industrial equipment and 68 for telecommunication equipment.

Approvals according to FCC regulations are straightforward for manufacturers. However, the approval can only be used for the American market. Manufacturers who wish to sell the same product in Canada, Mexico or even the European market must go through completely different approval procedures.

2.1.4 EMC framework in Australia/New Zealand

One of the newer EMC schemes is the EMC Framework covering Australia and New Zealand. The Framework takes a very similar approach to Europe, giving manufacturers more responsibility in the marketing of their products. The EMC Framework came into effect on January 1, 1997. It covers all electric and electronic products to be sold on the Australian and New Zealand markets.

The authority for all related matters is the Australian Communication Authority (ACA). As in the U.S. model, the main goal of the EMC Framework is the protection of essential radio and broadcast services and the minimization of electromagnetic interference. For this reason, immunity testing is required only for radio and broadcast equipment. For all other equipment, only emission requirements apply. In addition, the Framework only applies to commercial, residential and light industrial environments.

As in Europe, the EMC Framework defines different compliance routes. The manufacturer can choose the self-declaration route or the involvement of a competent body. Accredited testing is required only when the competent body is involved. In all other cases, it is recommended but not mandatory. All standards for Australia are produced by Standards Australia, but as mentioned previously, they are based on international or European standards.

The ACA introduced the C-tick mark as its conformity mark. Like the CE marking, the C-tick mark shows compliance with regulations – in this case, the relevant EMC standards. However, there are two pre-conditions for a manufacturer to use this mark. First, the manufacturer must be represented in Australia. This can be through a branch office or an authorized representative. Second, the manufacturer has to register with the ACA, but only for the initial use of the C-tick mark.



C-tick mark

Like in Europe, market access can be very easy for well-informed manufacturers. Third-party approvals are not generally required and manufacturers can market their products on their own responsibility.

2.1.5 VCCI registrations for Japan

The Japanese scheme is quite different. In 1985 four organizations – the Japan Electronic Industry Development Association, the Japan Business Machine Makers Association, the Electronic Industries Association of Japan, and the Communications Industry Association of Japan – jointly established the Voluntary Control Council for Interference by Information Technology Equipment and Electronic

Office Machines (VCCI) to cope with radio interference problems arising from personal computers, word processors, facsimile terminals and other similar electronic equipment. The system is completely voluntary, but strongly supported in Japan. Selling equipment without VCCI registration and the VCCI mark is legally possible, but the product will fail from a marketing point of view.



VCCI mark

As the name of the VCCI already says, the scheme currently applies only to ITE (information technology equipment). The implemented standard requires the same limits as CISPR 22. The classes A and B from the CISPR publication are transferred to classes 1 and 2, respectively.

One drawback of the scheme is that only members can register products and display the VCCI label. In other words, manufacturers who wish to register their products with VCCI must first become members.

2.1.6 Other international requirements

A worldwide movement is in progress to implement compliance schemes for product safety and EMC. Argentina and Taiwan are among the most recent countries to join this trend, and many others are following. In both fields, there is a clear tendency towards international standards. However, most countries still require approvals and certifications that can only be issued by governmental organization or accredited institutions.

2.2 EMC standards

In the past, most countries had their own regulations and standards governing electromagnetic interference (EMI) or radio frequency interference (RFI). Then, on January 1, 1992, the European Directive 89/336/EEC on electromagnetic compatibility (EMC) came into force. This directive brings a common approach to EMC to every member state of the European Union. Common standards will be used throughout Europe to ensure that technical trade barriers are removed. As well as controlling EMI emissions from equipment, the directive also calls for equipment to be immune to external electromagnetic disturbances.

The task of elaborating the standards to be used has been assigned the European organization called CENELEC. Most of the European standards will be based upon international standards from CISPR and IEC. The numbering system used in the European standards is:

EN xxyyy. EN = European Norm. xx = 50 denotes that the standard is a standard of CENELEC origin. yyy is just a continuous number.

The EMC product standard for machine tools, EN 50370, is one such example. If $xx = 55$, the standard is based on a CISPR standard yyy . CISPR 13 therefore becomes EN 55013. Standards based on an IEC standard yyy are indicated with $xx = 60$. The numbering for these standards is harmonized between IEC and CENELEC, and as a result, these standards are often described like IEC/EN 61800-3, which would be the EMC product family standard for power drive systems. Once the European standard is complete, the individual members of the European Union will create national harmonized standards, usually assigning their harmonized standard a national number. For example, the British harmonized standard of EN 55011 is BS EN 55011.

2.2.1 Standard classification

The standards in the international system are divided into three different categories.

Basic standards describe the general and fundamental rules for meeting the requirements. Terminology, phenomena, compatibility levels, measurement, test techniques and classification of EM environments are so described within. The EN 61000-4-x series of standards are the best known examples for basic standards.

Generic standards refer to specific environments. They set minimal EMI levels that equipment in these environments must meet. Where no product-specific standards exist, the generic standards are to be used. Generic standards describe household and industrial EMI environments. Examples of generic standards are EN 61000-6-1/2/3/4. Products standards are for specific products or product groups. These standards are coordinated with the generic standards.

Product standards always take precedence over generic standards. If a product or product family standard exists for a certain product, the manufacturer must use this standard. Only in the absence of a product standard can the manufacturer use generic standards.

Overview of common product-related standards (excerpt)

Product type	Emission	Immunity
Household appliances and portable tools	EN 55014-1	EN 55014-2
Vacuum cleaners	EN 61000-3-2	
Laundry machines	EN 61000-3-3	
Heating		
Cooking equipment		
Luminaries	EN 55015	EN 61547
Discharge lamps	EN 61000-3-2	
Fluorescent lamps	EN 61000-3-3	
Home electronics	EN 55013	EN 55020
Amplifiers	EN 61000-3-2	
Audio players	EN 61000-3-3	
Radio, TV receivers and decoders		
IT equipment	EN 55022	EN 55024
Computers	EN 61000-3-2	
PC periphery equipment	EN 61000-3-3	
Copy machines		
Equipment for data & voice transmission on low voltage networks (3 to 148.5 kHz)	EN 50065-1	EN 61000-6-1/-2
Power line communication		
Power supplies with DC output	EN 61204-3	EN 61204-3
Switch mode power supplies	EN 61000-3-2	
DC/DC power converters	EN 61000-3-3	
Uninterruptible power supplies	EN 50091-2	EN 50091-2
	EN 61000-3-2	
	EN 61000-3-3	
Motor speed control equipment	EN 61800-3	EN 61800-3
Frequency inverters		
Current converters		
Servo drives		
Electrical medical devices	EN 60601-1-2	EN 60601-1-2
X-ray equipment		
CAT-scanners		
Machine tools	EN 61000-6-4	EN 50370-2
Lathing machines	(to be replaced by EN 50370-1)	
Grinding machines		
CNC centers		
Scientific equipment	EN 55011	EN 61000-6-1
Measurement equipment		EN 61000-6-2
Laboratory equipment		
Generic standards (if no product standards applicable)	Emission	Immunity
Residential, office and light industrial environment	EN 61000-6-3	EN 61000-6-1
Industrial environment	EN 61000-6-4	EN 61000-6-2

2.2.2 Common limit lines

The various standards set down limits for conducted and radiated EMI emission. These limits are defined in dB μ V for the conducted voltage and dB μ V/m for the radiated field strength. The reference values are 1 μ V for 0 dB μ V and 1 μ V/m for 0 dB μ V/m. Typically, limit lines are defined separately for residential areas and industrial areas. These two areas are represented by two classes of limits: class A represents the industrial environment; class B defines the limits for residential areas. While a number of different limit lines exist for the various standards, the class A and B limits of EN 55011 and EN 55022 have become the reference limits for most standards.

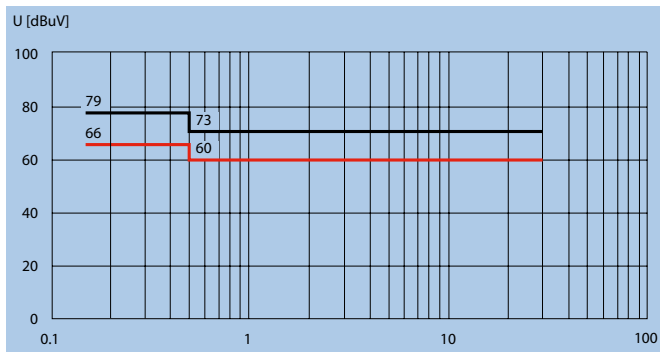

Limits for line conducted voltage class A (EN 55011/22)

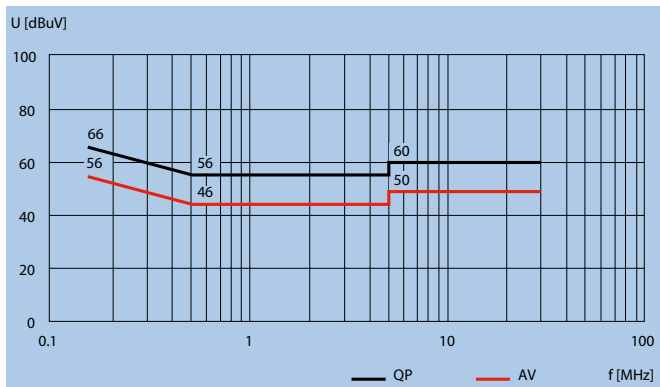

Limits for line conducted voltage class B (EN 55011/22)

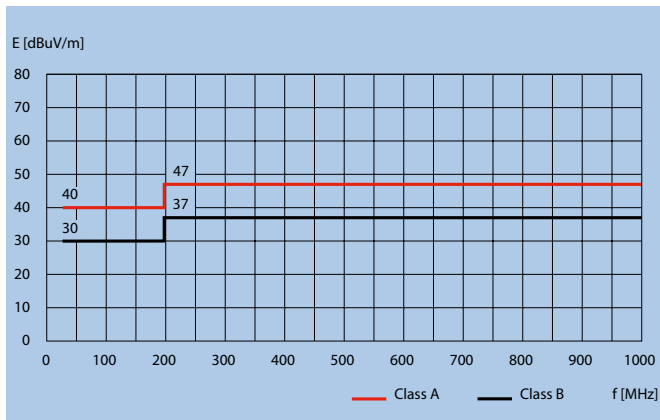

Limits for radiated field strength classes A and B (EN 55011/22)

The respective measurement methods for conducted and radiated emission measurements are described in a later chapter.

2.3 Safety approvals

The UL mark stands for “listed” and identifies units whose use for the generally accepted applications in the relevant field is not restricted. Here at Schaffner, we feature the UL mark on medical and safety facility filters and power quality products.



The mirror image “RU” stands for “recognized” and identifies tested products or components that are subsequently used in UL-certified end products, machines or systems. A good share of our standard and customized components such as chokes and filters bear this label.



Recognized component mark for Canada and the United States.

This UL Recognized Component mark, which became effective in April 1998, may be used on components certified by UL to both Canadian and U.S. requirements. Although UL had not originally planned to introduce a combined Recognized Component mark, the popularity of the Canada/U.S. Listing and Classification marks among clients with UL certifications for both Canada and the United States led to this mark.



The ENEC mark for lighting components, IT equipment, transformers, equipment switches, control units, clamping devices and connector plugs, capacitors and RFI suppression components documents the uniform Europe-wide certification in the ENEC procedure according to EN standards.



A CSA mark on its own, without indicators, means that the product is certified primarily for the Canadian market for the applicable Canadian standards. If a product has features from more than one area (such as electrical equipment with fuel-burning features), the mark indicates compliance with all applicable standards.



China Quality Certification Center (CQC). CQC develops voluntary product certification services called CQC Mark Certification for products not subject to compulsory certification. The objective is to protect consumers, ensure the safety of persons and property, safeguard the rights and interests of users, improve the product quality and international competitiveness of Chinese enterprises, and facilitate the import of foreign products to China.



2.3.1 EMC testing as a service

The fully equipped Schaffner EMC testing laboratory with its trained personnel is dedicated primarily to testing and measuring our own products. However, we also provide EMC testing as a service. Schaffner is ISO 9001 : 2000-certified and the test center is ISO/IEC 17025-accredited. The scope of services even encompasses mobile testing vehicles.

These mobile EMC labs make it possible to conduct testing and interpret the results right at the customer's site.

2.3.2 The test

Prototypes are subject to the most stringent standards. In the EMC laboratory, for example, prototypes are checked for electromagnetic compatibility. In the test center, their surge and short-circuit protection is checked, while continuous load testing is used to gauge their reliability. Environmental compatibility begins with the selection and testing of materials, the use of environmentally friendly manufacturing processing and compliance with the latest standards worldwide.

3 EMC measurements

3.1 Emission

Emission is every electromagnetic disturbance that is produced by the equipment under test (EUT) and given off to the environment. If we look at a portable telephone with a base station, for example, the telephone emits the communication signal and the base station receives it. This kind of emission is intended and necessary for the correct operation of the equipment. Every government has the task of controlling these intended emissions by controlling the frequencies of operation and requiring special approvals.

However, most electric and electronic equipment also produces a lot of unintended emission that is not necessary for the operation –

that is, emission as a kind of waste product. To guarantee the proper operation of other equipment in the vicinity, this unintended emission must be limited. This unintended emission can be spread over a vast frequency range, starting from the power network frequency (50 Hz for Europe) up to several GHz (gigahertz = 1 billion cycles per second).

Signals can generally be transmitted through air or along cables, resulting in radiated and conducted emission.

3.1.1 High-frequency (HF) radiated emission

While there is no fixed definition as to where high frequency starts, EMC authorities typically consider everything from a few kHz (kilohertz = 1000 cycles per second) upwards to be HF. In the EMC field, the term radio frequency (RF) is often used instead of HF.

Air-transmitted interference, called radiated emission, can be measured with a receiving antenna on a proper test site. The following picture shows a sample setup.

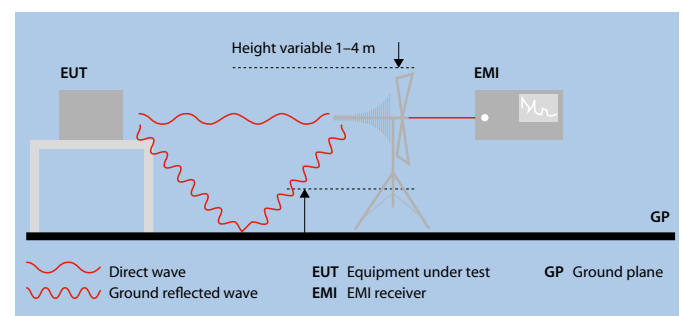

Radiated emission test on an open-area test site (OATS)

The classic radiated measurement according to common standards is performed on an open area test site (OATS). The minimum ground plane area as given in CISPR 22 should be regarded as indicative only; the true measure of an OATS is its calibrated normalized site attenuation (NSA), and meeting this will normally require a larger ground plane area. Maintaining a large area free of obstructions (including wooden buildings) is also important.

The ground plane is necessary to regularize reflections from the ground surface, and the antenna height scan deals with the nulls that inevitably result from the presence of the ground plane. The height scan is not intended to measure emission from the EUT in the vertical direction. Only the horizontal plane of emission as given by the azimuth rotation of the EUT is tested.

Any open area test site is likely to suffer from ambient signals, that is, signals that are generated in the neighborhood and received on the site but not emitted from the EUT. These signals can easily exceed both the emission of the EUT and the limit values at many frequencies. An emission plot which contains ambients is hard to

interpret, and more importantly, ambients that mask EUT emission make it impossible to measure the EUT at these frequencies. There is no foolproof method whereby ambient signals can be subtracted from an emission measurement.

Other problems of OATS can be unwanted reflections from objects that are not within the defined borders but that nonetheless can reflect the EUT signal back to the antenna. It should also be noted that objects that do not appear to be reflecting normally can begin doing so under certain circumstances. A tree would surely not be suspected of reflecting electromagnetic waves, but if it is wet after a rain shower, it definitely would.

In order to avoid problems with the OATS, alternative testing methods are under investigation. The first one that was also approved by EMC standards was the anechoic chamber. The outer hull is an RF-tight shielded chamber that keeps out the ambient signals. Measurement in such a chamber would be impossible, however, since the reflections inside cannot be controlled and the measurement result could not be compared to OATS measurements.

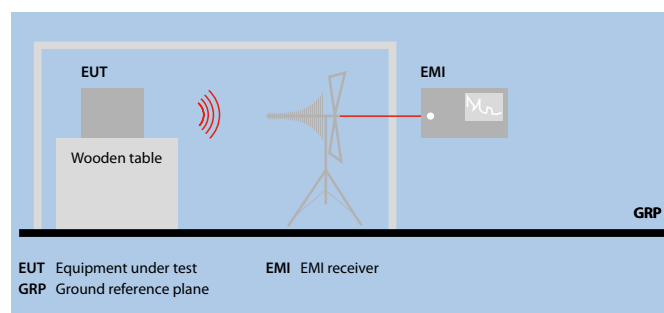

Radiated emission test in an anechoic chamber

In order to prevent reflections, the walls of the chamber are lined with absorbing material. Modern chambers achieve this through a combination of ferrite material, usually in the form of tiles glued directly to the wall, and cone-shaped foam absorbers on top of the tiles. The tiles work excellently in the lower frequency range, but their performance deteriorates with increasing frequencies. Foam cones work well in any frequency range, but their size is directly related to the wavelength, so at low frequencies, cones must be very long to be effective, meaning that the shielded chamber must also be much bigger. The combination of cones and tiles has proven practical and economical.

3.1.2 High-frequency conducted emission

Conducted emission is any emission transported from equipment to the environment along cables. The main emphasis in measuring line-conducted emission is placed on the AC mains input of the EUT,

though other interface ports are becoming more and more important, like telecom and network ports on information technology equipment.

In order to measure conducted emission, a line impedance stabilization network (LISN) is inserted into the mains power supply of the EUT. Newer standards call this network artificial mains network (AMN). The LISN leads the RF signals from the EUT to the output for the measurement receiver, while at the same time blocking the AC input voltage from the receiver. According to the standard, the highest emission on each of the phases has to be recorded, but in common practice a peak measurement is performed on one phase, and only if the measured emission is within a defined margin from the limit will the testing be performed with average (AV) and quasi-peak (QP) detectors on all phases.

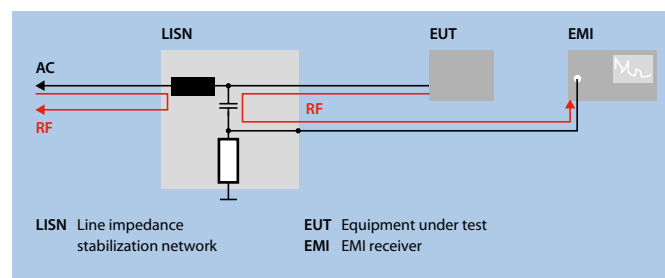

Measurement principle for line-conducted voltage measurements

The CISPR quasi-peak and average detectors weigh the indicated value according to its pulse repetition frequency (PRF). Continuous interference is unaffected; the indicated level of pulsed interference is reduced by a defined degree based on the time constants and bandwidths defined in CISPR 16. A receiver is calibrated using pulses of a defined impulse area, spectral density and repetition rate.

It is normal practice to perform initial emissions testing with the peak detector. Provided that the receiver dwells on each frequency for long enough to capture the maximum emission – this depends on the EUT's emission cycle time – the peak detector will always give the maximum output level. A list of frequencies at which high emissions are detected is created, and these frequencies are revisited individually with the quasi-peak (and average, for conducted emissions) detectors, which will give the reading to be compared against the limit.

The ground reference plane (GRP) is an essential part of the conducted emission test. A proper measurement is impossible without a GRP. Even a Class II EUT without safety earth connection must be tested over a GRP, since it provides a return path for stray capacitance from the EUT. The GRP should be:

- at least 2 m x 2 m, and at least 0.5m larger than the boundary of the EUT;

- made of copper, aluminum or steel, though the thickness is not too important;
- bonded to the local supply safety earth (this is for safety only and not necessary for the measurement);
- bonded by a very short, low-inductive strap to the reference terminal of the AMN/LISN. A length of wire is not adequate for repeatability at the higher frequencies. The AMN/LISN should preferably be bolted directly to the GRP.

For table-top apparatuses, different standards allow the GRP to be either vertical or horizontal, but all require the closest face of the EUT to be maintained at a distance of 40 cm from the GRP and at least 80 cm from all other conductive surfaces. This is typically achieved with a wooden table either 40 cm high off a conducting floor used as the GRP or 80 cm high and 40 cm away from a conducting wall used as the GRP. Floor-standing EUTs should be placed on a conducting floor used as the GRP but not in electrical contact with it.

The distance between the boundary of the EUT and the closest surface of the AMN/LISN must be 80 cm. The mains lead from the EUT to the AMN/LISN should preferably be 1m long and raised at least 10cm from the GRP for the whole of its length. Longer mains leads may be bundled non-inductively, but this introduces considerable variations into the results, and it is preferable to shorten them to the standard length. Alternatively, provide a standard wooden jig such that the bundling can be done in a repeatable manner. The following picture shows the setup as defined in the measurement standard.

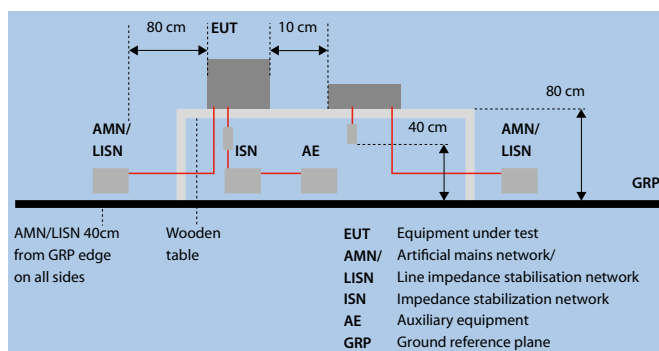

Standard compliant setup for conducted emission measurements

Mains-powered peripherals that are necessary for the operations of the EUT but not themselves under test should be powered from a separate artificial mains network (AMN) or LISN. Other connected leads should be terminated in their normal loads but not extend closer than 40 cm from the GRP. The measurement should be well decoupled from any external disturbances. These can be coupled into the setup either via the mains supply or by direct coupling to the leads. Although the AMN/LISN will reduce both the noise on the mains supply and variations in the supply impedance, it does not do this perfectly, and a permanently installed RF filter at the mains supply to the test environment is advisable. Ambient radiated signals should also be attenuated, and it is usual to perform the measurements inside a screened room, with the walls and floor of the room forming the ground reference plane. However, a fully screened room is not essential if ambient signals are at a low enough level to be tolerated.

3.1.3 Discontinuous interference (clicks)

Domestic appliances, power tools and certain other products need to be measured for discontinuous interference in the frequency range of 150 kHz to 30 MHz. Because the interference generated by such products is not periodic, the limits are relaxed compared to continuous limits.

The relevant standard was designed to allow products' interference levels to be suppressed according to annoyance levels. Hence, emissions must be measured for their amplitude, duration and repetition rate, to determine whether the interference is discontinuous – a “click” – or continuous, as defined in the standard.

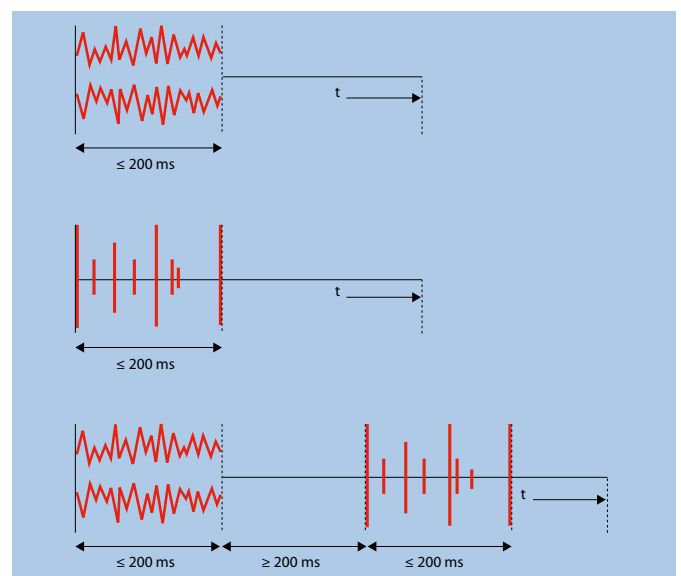

Definition of clicks

Once the discontinuous interference has been quantified, corrected limits can be applied. Such a process is complex, difficult and prone to errors if measurements are made manually. For accurate and repeatable results, automated analysis is necessary.

3.1.4 Mains harmonics

In general the public mains power supply voltage waveform is sinusoidal, which means that it includes only the fundamental frequency (50 or 60 Hz) without any harmonic multiples of this frequency. Purely resistive circuits such as filament lamps or heaters, when powered from the mains, draw a current that is directly proportional to the applied voltage, and do not create any extra harmonic components. By contrast, non-linear circuits do draw a non-sinusoidal current, despite the applied voltage being sinusoidal. All non-linear currents, however, will cause harmonic currents, i.e., currents with frequencies that are integer multiples of the supply frequency.

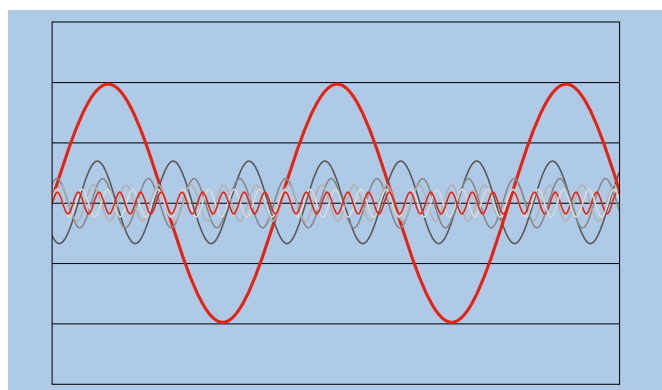

Mains current with harmonics

Traditionally, harmonic pollution was only a concern for larger installations, particularly for power generation and distribution and heavy industry. But the modern proliferation of small electronic devices, each drawing perhaps only a few tens or hundreds of watts of mains power, and usually single-phase (such as personal computers), has brought the problem of mains harmonics to the fore even in domestic and commercial applications. Of all the above examples, it is the electronic DC power supplies that are causing the most concern due to the increasing numbers of electronic devices such as TV sets in domestic premises, information technology equipment in commercial buildings and adjustable-speed drives in industry.

The difficulties caused by harmonic pollution can be divided into two categories: those caused by the harmonic currents themselves and those caused by voltage waveform distortion resulting from the harmonic currents flowing in a finite supply source impedance.

The principal problem with the harmonic currents is that they can cause overheating in the local supply distribution transformer if it is inadequately rated, or if it is rated on the assumption of low

harmonic levels. Power factor correction capacitors can overheat as well, due to the much higher harmonic currents they experience because of their lower impedance at higher frequencies, leading to failure.

Harmonic currents in the neutral conductors of three-phase supplies present reliability and safety risks, where neutral conductors have not been suitably dimensioned. Many modern installations use neutral conductors of the same cross-sectional area as their associated phase conductors, and some (usually older) buildings are known to use half-size or smaller neutral conductors. Unfortunately, emission of "triplen" harmonics (multiples of 3: 3, 6, 9, 12, etc.) add constructively in neutral conductors and can reach 1.7 times the phase current in some installations. Overheating of conductors is aggravated by the skin effect, which tends to concentrate higher frequency currents towards the outside of the conductor, so that they experience greater resistance and create more heating effect. A further result of harmonic currents, especially when they leak into the earth network, is increased magnetic interference with sensitive systems operating in the audio band, such as induction loop installations.

The non-sinusoidal current drawn from the supply causes distortion of the supply voltage, since the inductance of the supply increases the source impedance as the harmonic order rises. This waveform distortion can cause serious effects in direct-on-line induction motors, ranging from a minor increase in internal temperature through excessive noise and vibration to actual damage. Electronic power supplies may fail to regulate adequately; increased earth leakage current through EMI filter capacitors due to their lower reactance at the harmonic frequencies can also be expected.

System resonance effects at the harmonic frequencies can create areas of the power distribution network where the voltage is more heavily distorted than elsewhere and/or has significant over- or under-voltage. Also, some areas of the network can suffer from much higher levels of current than elsewhere, at a few harmonic frequencies.

Common standards for harmonics are the IEC/EN 61000-3-2 and the U.S. standard IEEE 519. IEC/EN 61000-3-2 bases its requirements on an equipment level, i.e., the standard defines limit values for harmonic currents that must be fulfilled by each individual piece of equipment. The IEEE 519 looks at harmonics from an installation point of view. Rather than looking at equipment, this standard measures harmonics at the point of common coupling, i.e., where equipment of one installation starts to interact with equipment from a second installation.

3.1.5 Voltage fluctuations and flicker

When loads are being switched on and off constantly, the voltage supply will experience fluctuations and changes that cannot be

compensated fast enough. Although not directly influencing other equipment, such fluctuations can become an annoyance if electric light connected to the same supply unit changes varies to the fluctuations. The subjective impression of such light changes are called flicker and represent varying brightness or intensity. Above a certain level, flicker can be disturbing or even harmful to one's health. To avoid such problems, the voltage changes resulting from any equipment need to be restricted, or equipment needs to be installed such that voltage changes from the equipment cannot lead to flicker.

Flicker is a result of voltage fluctuations. It is therefore natural that all equipment with timers and thermostats, which cause frequent changes of the load, will also cause voltage changes and fluctuations. Examples of such equipment are copy machines, laser printers, heaters, air conditioners and similar appliances.

3.2 Immunity

A product manufacturer is unlikely to know or have control over the actual location of use of its products, and products should be expected to work correctly in any environment that they are reasonably likely to encounter. While it is a requirement of the EMC and R&TTE Directives that any product placed on the market or taken into service should have adequate immunity, any manufacturer who is concerned about the quality of its products will take steps to ensure this, irrespective of the legislation, since the issue is a straightforward one of fitness for purpose.

3.2.1 RF immunity

In order to test equipment for its immunity against RF signals, a defined signal needs to be generated and coupled into the EUT. Due to the nature of the signals and their means of transmission, various transducers are defined by the relevant standards for various testing methods.

The base signal for all RF immunity tests is a sine wave signal, which is then modulated in different ways and applied to the EUT. The range for testing spans from 0.15 to 1000 MHz, with a rising trend for the upper limit. A signal generator must therefore be able to generate signals over that frequency range. Since the power output of generators is usually limited and the outgoing signal is not high enough to cover the requirements of the testing standards, additional amplifiers are used. The amplifiers must also cover the whole frequency range, but since the power requirements change with the frequency, most testing systems utilize two amplifiers, a higher power version for the lower frequency range and a lower power version for the upper one.

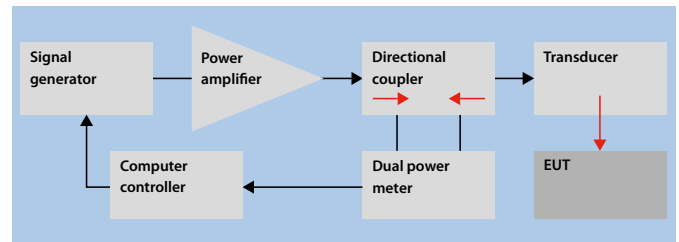

Testing principle for RF immunity

The EUT may be susceptible to modulated but not unmodulated RF. Signal circuits will detect the RF signal and respond to its amplitude; an unmodulated carrier may cause a non-critical DC shift in AC coupled circuits, whereas detected modulation can be within the signal bandwidth. The EUT can also be immune to a high level of RF but unexpectedly susceptible at a lower level. Most standards mandate the use of amplitude modulated (AM) signals. Using frequency modulated (FM) signals does not generally produce any additional susceptibilities except in special cases. For AM, a 1 kHz sine wave is normally used, with some product-specific exceptions. These standards refer the specified level of the unmodulated signal, which is then modulated at 80% depth. This increases the peak applied signal by over 5 dB. By contrast, some automotive RF immunity standards refer the test level to the peak value after modulation. An alternative modulation technique is pulse modulation, in which the signal is effectively switched on and off. This has been used for emulating GSM signals at 900 MHz, where a 200 Hz pulse modulation is specified. No increase in the overall peak level is caused by this technique.

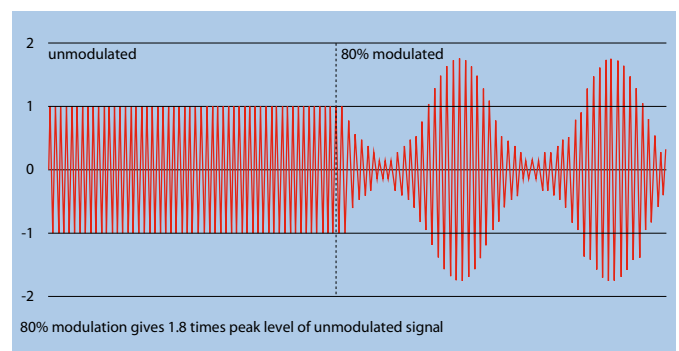

AM modulation of RF signals

The application of an interference signal to the EUT is an important part, but it covers only the first half of the test. As important as the signal generation is the evaluation of the behavior of the EUT. Only if the EUT functions within normal operation parameters during the whole test can it be considered as having fulfilled the requirements. There are a number of ways to observe the behavior of the EUT during testing, and some product standards are actually very detailed

about the monitoring method. For equipment involving audio functions, measurement methods are often used to monitor correct performance. Systems involving data transmission and digital signal processing can often be evaluated with network analyzers or similar analysis tools. Equipment with defined, tangible output is often evaluated after the test by investigating the output material. The most common method, though, is simple observation of the EUT and its functions with a video camera. This camera needs to be immune to the interference in the chamber and needs to be constructed in a way, that the field is not distorted. Usually, such cameras are built into boxes covered with ferrite tiles.

Where product standards do not clearly define the intended operation of the EUT during testing, the manufacturer can refer to the general performance criterion as laid out in many basic standards as well as the generic EN EMC standards, which states that:

“The equipment shall continue to operate as intended without operator intervention. No degradation of performance or loss of function is allowed below a performance level specified by the manufacturer when the equipment is used as intended.

The performance level may be replaced by a permissible loss of performance. If the minimum performance level or the permissible performance loss is not specified by the manufacturer, then either of these may be derived from the product description and documentation, and by what the user may reasonably expect from the equipment if used as intended.”

Care should be taken that performance criteria are clearly defined before the testing is started. Once the testing starts and the equipment fails, performance criteria should not be softened to make the EUT pass, because this would only mean that the criteria were not well defined in the first place.

3.2.2 Conducted immunity

At frequencies up to the point at which the EUT dimensions approach a quarter wavelength, the major coupling route into the EUT is via interference injected in common mode on the connected cables. Cable testing is therefore an important method for checking RF susceptibility, and IEC/EN 61000-4-6 specifies the test methods. Any method of cable RF injection testing should require that the common-mode impedance at the end of the cable remote from the EUT be defined. Each type of cable should have a common-mode decoupling network at its far end to ensure this impedance with respect to the ground reference plane (GRP) and to isolate any ancillary equipment from the effects of the RF current on the cable. For equipment to be used and tested in a system where the cable lengths and terminations at either end are controlled, these terminations provide the appropriate common-mode impedance. Otherwise, where the far end termination is unspecified, a nominal impedance of 150 ohms will represent the average of most instal-

lation conditions, which can vary between a few ohms and a few hundred ohms over the test frequency range of 150 kHz up to 80 MHz. If ancillary equipment (AE) is not isolated from the signal by a decoupling network or filter, then it must be able to withstand the applied RF without affecting the system performance.

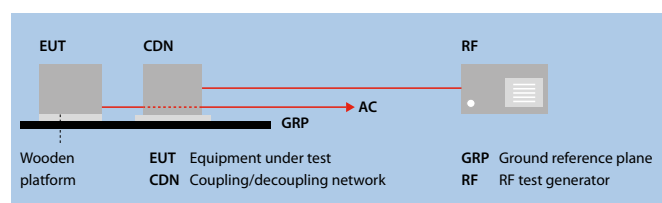

Testing principle for conducted immunity

The most straightforward method of coupling is by a capacitive connection to the cable under test. The disturbance signal is split via a coupling network to each of the conductors in the cable, so that the disturbance appears in common mode on all conductors together. In addition to a coupling network, a decoupling network is required to prevent the signals applied to the EUT from affecting other devices or being fed into the mains power supply. The combination of a series resistance of 100 ohms and the amplifier output impedance of 50 ohms establishes a common-mode RF impedance at the EUT port of 150 ohms. The coupling and decoupling networks are normally combined into one box to form a so-called coupling/decoupling network (CDN).

A useful alternative to the CDN for RF injection is the EM clamp. This device consists of a tube of split ferrite rings of two different grades that can be clamped over the cable to be tested and is therefore non-invasive and applicable to any cable type.

The signal is fed in via a single-turn loop extending the entire length of the clamp and terminating at each end in an impedance. This creates both a voltage that gives capacitive coupling and a current that gives inductive coupling to the cable. The combination of graded ferrite and capacitive/inductive coupling gives the clamp significant directivity, particularly above 10 MHz, so that substantially less signal is applied to the AE end of the cable, and the common-mode impedance seen by the EUT is quite close to 150 ohms across a large part of the spectrum of the test signal.

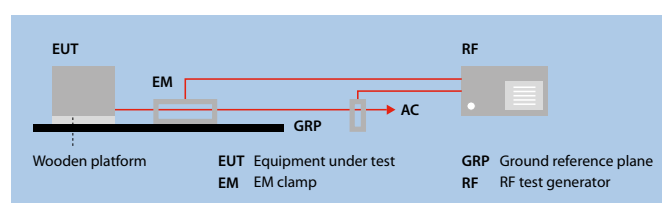

Conducted immunity testing with capacitive coupling clamp

As with the CDN, the EM clamp should be properly bonded to the ground plane to give a repeatable impedance. But also as with the CDN, variations due to cable layout on the AE side of the test setup and due to the AE itself should be minimized.

3.2.3 Radiated immunity

The standard test for radiated immunity is IEC/EN 61000-4-3. This requires a radiated RF field generated by an antenna in a shielded anechoic enclosure using a pre-calibrated field, swept from 80 MHz to 1000 MHz with a step size not exceeding 1% of fundamental and a dwell time sufficient to allow the EUT to respond. The antenna faces each of the four sides of the EUT in each polarization (and top and bottom, if these might be affected), hence there are 8 (or 12) tests in all. Amendment 1:1998 adds tests from 800 to 960 MHz and 1.4 to 2 GHz for protection against digital mobile phones.

The EUT is placed on the usual 0.8 m high wooden table (for table-top devices) with its front face in the same plane as the uniform field area that was previously calibrated. Both the antenna position and the uniform area are fixed with respect to the chamber. The standard requires that at least 1m of connected cable length be exposed to the field, and recommends the use of ferrite chokes to decouple longer cables. The cable layout cannot be generally specified, but at least some of the length should be in the same plane as one of the polarizations of the antenna.

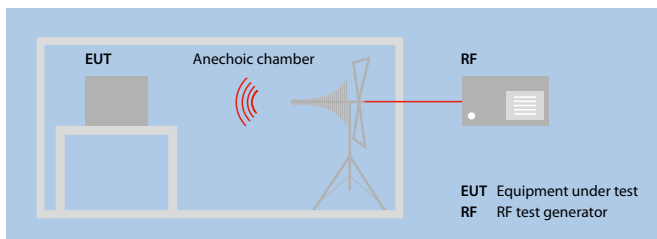

Testing principle for radiated immunity

The EUT is rotated on the table so that each of its four sides – and the top and bottom, if it may be used in any orientation – face the antenna in turn and are coplanar with the uniform area. For each orientation, two sweeps are performed across the frequency range, one in each antenna polarization. If the frequency is swept from 80 to 1000 MHz in 1% steps with the conventional minimum dwell time of 3 seconds per step, each sweep should take about 15 minutes, and the whole test should take over two hours. This ignores the need for the software to control the frequency step, however, including settling and leveling at each new frequency. Depending on the software algorithm, this can increase the duration per step (and therefore the total test duration) 1.5- to 2-fold.

3.2.4 Transient immunity

In addition to covering continuous radio frequency phenomena, EMC means ensuring product immunity from several sources of transient phenomena that are present in the electromagnetic environment. These phenomena can be natural, such as electrostatic discharge (ESD) and lightning surge, or man-made, such as switching transients and fault surges. They involve short-duration (nanosecond or microsecond) events that have high enough amplitudes to disrupt the operation of electronic circuits and, in some cases, have enough energy to destroy or damage components. Except for ESD, the source of a transient is not normally near to the victim equipment, and its energy is almost entirely coupled into the circuits via cable connections. Therefore, immunity testing involves applying a repeatable pulse of a defined waveform and level into each relevant cable port in a specified and reproducible manner. Apart from the rarely used pulsed magnetic field and damped oscillatory wave tests of IEC 61000-4-9 and -10, there are no commercial tests that apply radiated transients. ESD is the special case that is the exception to this rule: it is applied from a simulator that attempts to mimic the real-world event and includes both radiated and conducted components. Application of a series of transients is accompanied by monitoring of the function of the EUT to determine whether it has been disrupted and, if so, whether the disruption is acceptable.

3.2.5 Electrostatic discharges (ESD)

All conductive objects have self-capacitance with respect to ground and mutual capacitance with respect to other bodies. This capacitance can maintain a DC charge with respect to ground. With perfectly insulating materials, this charge would remain on the object indefinitely, but in reality, there is some surface and volume conductivity, and the free electrons drift, so that the charge differential is gradually neutralized. This is called electrostatic discharge.

In a moving person, all these factors come together to give a continuously varying voltage on that person. In the worst case – highly insulating materials, low relative humidity and vigorous movement – the voltage may reach as high as 25 kV. Charge potentials higher than this tend to be limited by corona effects. In more typical situations, voltages vary between 2 to 8 kV.

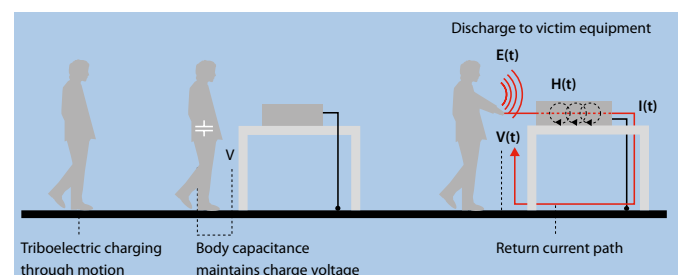

Typical human discharge scenario

When a charged object contacts another object at a different potential, the charge is equalized between the two objects, and there is both a voltage $v(t)$ and current $i(t)$ transient as this occurs. Digital circuits in particular may respond to these induced pulses as if they were intentional signals, and their operation is consequently corrupted.

IEC 61000-4-2 and its EN equivalent is the principal basic standard for testing electrostatic discharge immunity. It applies a defined current waveform at a specified voltage level from a handheld generator, which is essentially a capacitor supplied from a high-voltage supply whose charge voltage is discharged via a series impedance through the point of contact to ground. Two methods are given: contact discharge and air discharge.

In the **contact discharge** method, the stress may be applied directly to the EUT or to a coupling plane adjacent to the EUT. Before each test pulse, the capacitor is charged to the desired level, but its voltage is held off the generator's probe by a vacuum relay. The probe is applied to a suitably chosen point on the EUT or the coupling plane. The generator is then triggered. This action is repeated the desired number of times, at each location, with the appropriate polarities and levels.

The same generator is used for the **air discharge** method, but with a rounded rather than a pointed probe tip. The capacitor is charged to the desired level as before, but the voltage is now continuously applied to the probe, which is held away from the EUT. For each test pulse, the tip is brought up to the chosen point on the EUT, gradually, until it touches. Just before this, the air gap between the tip and the EUT will break down and a discharge current will flow, limited as before by the combined series impedance of the generator, the air gap, the EUT and the return path. Again, the action is repeated the desired number of times, at each location, with the appropriate polarities and levels.

The ESD pulse has a sub-nanosecond rise time, so radio frequency layout precautions are vital. The test must re-create the fast rise time found in reality, since this is an important parameter in deciding both the path the discharge takes through the EUT and the response of the EUT itself. The ground reference plane (GRP) is an integral part of the setup and the generator's return lead must be well bonded to it, since this connection forms part of the current return path.

The indirect discharge part of the test uses two other planes, different from the GRP, known as the horizontal coupling plane (HCP) and the vertical coupling plane (VCP). Discharges to these planes simulate the

stress caused by the radiated field from real-life discharges to nearby objects. Each coupling plane is connected to the GRP by a resistor lead to ensure that any charge bleeds off within a few microseconds.

3.2.6 Electrical fast transients (bursts)

When a circuit is switched off, the current flowing through the switch is interrupted instantaneously. Put another way, at the moment of switching there is an infinite di/dt . As a result, a high instantaneous voltage, added to the circuit-operating voltage, appears across the opening switch contacts. This causes the tiny but increasing air gap across the contacts to break down, and a current flows again, which collapses the voltage spike, so that the briefly formed arc extinguishes. But this re-interrupts the current, so another voltage spike appears, creating a further arc. This process repeats itself until the air gap is large enough to sustain the applied voltage without breakdown, at which point the circuit can be said to be properly switched off. The visible effect is a brief spark between the contacts, which actually consists of a whole series of micro sparks – the so-called “showering arc” – whose repetition rate and amplitude depend on the circuit and switch parameters.

Poor filtering or inadequate screen termination on each interface then lets these transients pass into the electronic circuits, where they appear as interfering signals at sensitive nodes. As with other types of transient, digital circuits tend to be more susceptible, since each short pulse can appear as a valid digital signal. Occurring in bursts, there is a higher probability that one or more pulses will coincide with a critical timing edge. However, analog circuits can also be affected, typically by saturation of sensitive amplifiers. Pulse-counting circuits are also susceptible if the burst masquerades as real input.

IEC 61000-4-4 and its EN equivalent are the principal basic standards for testing fast transient immunity. Testing involves applying a specified burst waveform via a defined coupling network to the mains connection and via a defined clamp device to any signal connection. Only conducted coupling is used; there is no specification for radiated transient immunity. The choice of ports for the application of the burst depends on the instructions in the product standard being used, but it is generally applied to AC and DC power ports and to signal and control ports that may be connected to cables longer than 3m.

The effects of burst transients relate mostly to high-frequency components of the pulses. Common EMI filters will thus have some positive effects on burst problems. On the other hand, it should be pointed out that EMI filters are not specifically designed for burst suppression. The HF components of the pulses reach such high frequencies that oscillation of the filter circuit is also possible.

3.2.7 Surge

High-energy transients appearing at the ports of electronic equipment are generally the result either of nearby lightning strikes or due to major power system disturbances such as fault clearance or capacitor bank switching. Lightning can produce surges with energies of several joules by the following mechanisms:

- at Direct strike to primary or secondary circuits: the latter can be expected to destroy protective devices and connected equipment; the former will pass through the service transformers either by capacitive or transformer coupling.
- at Indirect cloud-to-ground or cloud-to-cloud strikes create fields which induce voltages in all conductors.
- at Ground current flow from nearby cloud-to-ground discharges couples into the grounding network via common impedance paths and causes substantial potential differences between different ground points.
- at Primary surge arrester operation or flashover in the internal building wiring causes voltage transients.

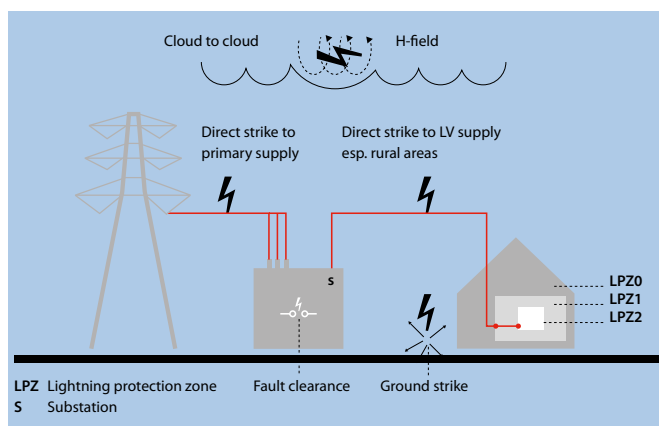

Surge generation

Surges impinging on electronic equipment may cause hardware damage and complete failure or, in lesser cases, operational upset. Below a certain level dependent on equipment design, no effect is observed. Above this level, a surge may cause the operation of the equipment to change state, without any long-term effect on the circuit components. But at a higher level, there may be enough energy to cause breakdown in critical components. The maximum voltage that is likely to occur is limited by flashover considerations. In a typical domestic mains supply, for instance, no more than about 6kV can be withstood by the wiring components.

Typically, protection involves adding parallel surge suppression devices such as clamping diodes, varistors or spark gaps. The purpose of these devices is to break down in a controlled manner at a voltage lower than can be sustained by the circuit and dissipate the surge energy within themselves. They must therefore be sized to

withstand the maximum surge energy to be expected in a particular application. The rate of change of applied voltage and current also has a bearing on both the susceptibility of a particular interface to upset and on the ability of protection devices to cope with the surge.

Schaffner filters will show little suppression effects for surge pulses unless they are equipped with additional surge suppressors (Z versions). Nonetheless, Schaffner filters are tested against destruction from overvoltages and can therefore be used without risk of damage by surge pulses.

3.2.8 Power magnetic fields

Power magnetic fields are magnetic fields caused by the AC mains power supply in conductors. The fields are continuous and related to the current flowing in the conductor. The frequency of the field corresponds to the net supply frequency, i.e., 50Hz in European systems.

Magnetic fields are always present around conductors carrying any amount of current. If the conductor forms a loop, the circular magnetic field waves add up and form a directional field. In both cases, the fields generated are directly proportional to the current that is flowing. In other words, the higher the current, the stronger the magnetic field.

Power magnetic fields can reach field strengths of more than 100A/m, depending on the environmental conditions. Logic dictates that the higher the current, the more severe the effect of the magnetic fields. Industrial applications and high-voltage distribution systems thus present more stringent conditions than household appliances. High magnetic fields exist in the vicinity of motors, generators and all equipment with high power requirements.

Magnetic fields affect only a very limited range of electrical equipment, i.e., equipment that relies on magnetic fields for its function. The most commonly used equipment is a standard CRT (cathode-ray tube), but the ongoing replacement of this technology with LCD and plasma displays is steadily reducing this problem. Also, the effect of magnetic fields on displays is easy to recognize, and misinformation of the user is very unlikely. However, the display can become illegible, and in areas where the information on the screen is essential for the proper use of the equipment, such disturbances cannot be accepted. One example would be the use in medical environments, where screens often display the physical status of a patient. More critical is the effect of magnetic fields on sensors and readers that use magnetic effects to produce measurement results. If the meter starts flickering or behaving strangely in any other way, the user will easily recognize an equipment malfunction. However, the influence of a magnetic field might lead merely to an inaccurate reading that is not recognizable to the user. Immunity of such equipment against magnetic fields is therefore essential.

3.2.9 Supply network

When equipment is connected to the power network, its operation usually affects the supply voltage characteristics. We have already explained the occurrence of harmonics as a result of non-linear currents. Equipment is also affected by interference that already exists in the supply network. The following picture gives an overview of existing interference.

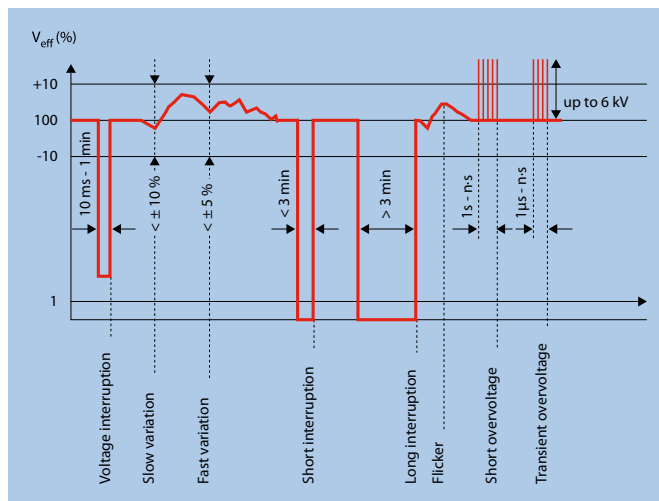

Supply changes in a typical supply network

The currently existing standards deal mainly with voltage dips and short interruptions. Voltage dips are interference in the mains power supply, ranging from constant repeating variations to sudden dips or a complete shut-off. Such power distortions can seriously affect other equipment. Whereas a short dip can influence processors in other equipment, a complete temporary shut-off can reset equipment and have it start up again in an unsafe condition. Voltage dips are short changes of the supply voltage to a certain level – for example, the voltage can drop to 50% of its original value. The duration of such a dip can be expected to be between half a period of the net frequency to a few seconds, but usually the duration is on the lower end of that scale.

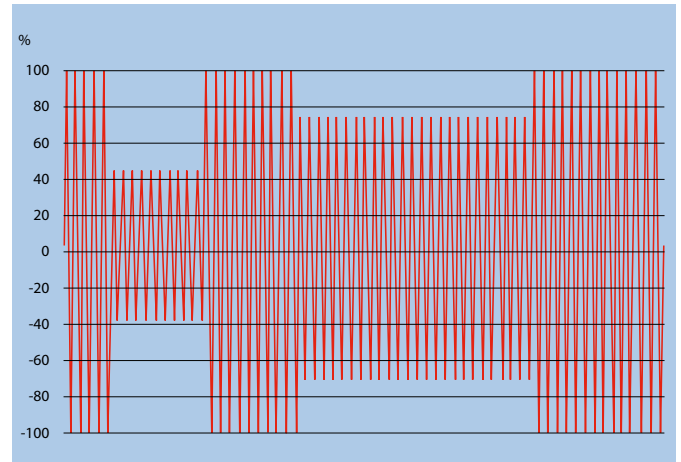

Example of voltage dips

Short interruptions are voltage dips to 0%. The duration of such interruptions can be several seconds but does not usually exceed one minute.

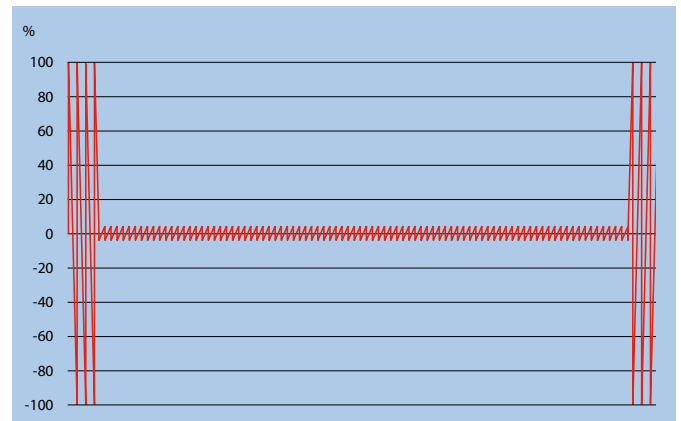

Example for short interruptions

Voltage dips and variations not only affect industrial networks but are also very common in residential areas. Voltage dips occur very frequently but are not always a problem. In many cases, the internal circuitry of equipment or the power supply installation can compensate for such occurrences. Interruptions will usually lead to degradation of the performance of the equipment, but it has to be ensured that afterwards, the equipment is either safely shut down or does not restart in unsafe conditions.

In order to perform testing against voltage dips and interruptions, the EUT must be connected to a well-defined power supply, thus enabling exact switching parameters and synchronization of the dips with the phase angle of the power supply.

The key point for testing is the generator, and the standards set very high requirements for such generators. They must be capable of

handling constant currents at voltage levels of 100%, 70% and 40% of the supply voltage.

More difficult than that are the requirements for rise time and inrush currents. At a supply voltage of 230 V, the generator must be able to switch (dip) within 1 to 5 μs while at the same time being able to handle up to 500 A of inrush current. These two requirements make the development of appropriate generators difficult, and a lot of existing testing equipment still does not comply.

4 Noise suppression

With the explosive increase of the popularity of electronic devices, the demand for regulation has created innumerable standards and conformity procedures. Accompanying this is the need not only for testing but for improvements to equipment design as well. In this chapter, we wish to examine some common design features affecting EMC and noise suppression components.

4.1 Conceptual EMC

Before looking at the different methods of noise suppression, it is important to point out that proper handling of EMC always requires a concept. It starts with the first design idea and ends with the product launch.

Very often, EMC is the last step in a design. When all the product features have implemented and the functionality is established, any EMC problems are solved. At this point, EMC becomes expensive, time-consuming and difficult to handle. Manufacturers should therefore always start thinking about EMC in the early stages of product design.

4.2 Shielding

From the point of view of legislation and standards, EMC takes place only outside of the equipment. Internal EMC is considered a functional issue and therefore not part of the regulations. Shielding is therefore a good measure to reduce electromagnetic noise outside of the equipment by keeping the noise inside. Shielding can be applied to enclosures and cables.

4.2.1 Shielded housings

For many kinds of equipment, shielded housings have become a default measure for noise reduction. Shielded enclosures should be made of metal or other conductive materials. The enclosure has to be grounded plainly, because ungrounded enclosures will provide only minimum shielding attenuation. The paint of enclosures often neutralizes the shielding effect of the enclosure. If the paint is non-conductive, the enclosure has long openings at doors and other openings. The same applies to gaskets, which in most cases are

made of rubber to guarantee a certain IP class. Conductive paints and gaskets are available, but more expensive.

Every opening in an enclosure acts like an antenna. A horizontal opening acts like a vertical antenna and vice versa. Openings can be apertures for ventilation purposes but also contact points between non-conductive parts of the enclosure (paint). If EMC characteristics are critical, the relation between size of apertures and wavelength of the disturbance to be attenuated should be considered. If necessary, special EMC openings, conductive paints and gaskets can help.

4.2.2 Shielded cables

Cable shielding is a very effective measure to improve susceptibility and reduce emission. However, incorrect installation can reduce the effectiveness or even completely destroy the effect of shielding. External voltages and currents do not directly affect the signal line, only the shield around the cable. The disturbances that reach the inside conductor are thus attenuated. The shielding effectiveness can therefore be described as the relation between the current on the shield and the induced voltage on the inner conductor.

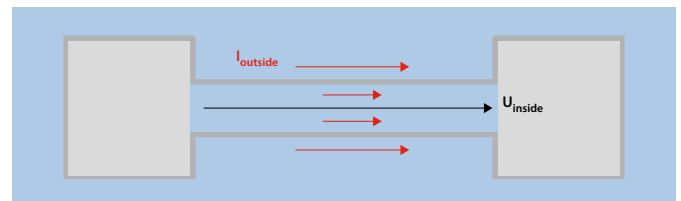

Principle of shield effectiveness

The attenuation of a shield depends on the material and installation. The best values are achieved with conduits, but this is necessary in only a few cases. Metal films or braided wires serve well enough for common applications. For more critical installations, double-braided wires or two separate shields can be used. If shielded cables are used, the ends of the shield have to be connected to ground. If none of the ends is connected, the shield becomes ineffective. Induced fields cannot be diverted; ground currents cannot be reduced. If shields are connected on only one side, they become effective against electric fields. However, once the resonance frequency of the shield is reached, the shield becomes ineffective and even amplification can occur. If both ends of the shield are connected to ground, the shield has the best effect. Electrical and magnetic fields can be reduced. Differences of potential do not affect the signal line. However, since potential differences result in currents on the shields, other lines can be affected.

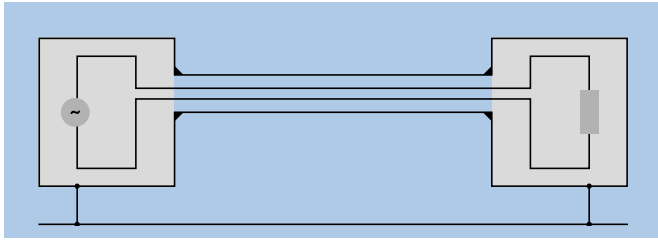

Proper connection of shielded cable ends

For the sake of completeness, it should be pointed out that shield connections as shown above can occasionally generate additional ground loops. If additional problems occur, compensation conductors between the two units or additional earthing along the shield should be applied.

Proper connection of the ground is also important for the performance of the shield.

The most common problem with the connection of shields is the use of "pigtailed", as shown on the left side of the picture. The shield is twisted to one tail and then connected to ground on only one point. This increases the coupling resistance of the shield and reduces its performance. The best connection of a shield is a 360° connection at both ends as shown on the right side.

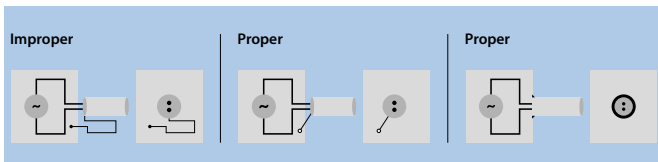

Improper and proper shield connections

4.3 Grounding

Ground connections are essential for EMC concepts in many ways. Connection types and concepts have influence on the function and performance of a grounding system. Basically, grounding should fulfill the following requirements:

- ! at Coupling between susceptible paths and paths with high emission should be reduced.
- ! at Coupling from external radiated fields should be reduced, along with emission from the equipment itself.
- ! at Differences in potential between several units are to be avoided.

4.3.1 Grounding concepts

As mentioned before, grounding is not the only effective measure. The optimum result can be achieved together with other design tools such as shielding and filtering. For all EMC countermeasures, the whole set of tools should be used and the most economical solution chosen. For grounding, a number of general rules apply:

- ! at Each electrical circuit should have an independent ground connection in order to avoid different potentials.
- ! at The method of grounding depends on the frequency of the signal.
 - For lower frequencies, the dimensions of the circuit are small compared to the wavelength and resonances are not likely to occur. Grounding on one side is sufficient and should be done on the transmitter side, with the receiver side floating. This method is called single-point grounding
 - For higher frequencies, the wavelength is small against the dimensions and resonances are hard to avoid. In order to have defined conditions, cables with well-known characteristic impedances are used and grounded on both ends. In some cases, cables are additionally grounded at several points along the signal path. This grounding concept is called multi-point grounding.
- ! For circuits with low- and high-frequency signals, triaxial cables would be the best solution. However, high price and weight rules them out in many cases. Mixed concepts are therefore used, combining grounding with twisted cables and other methods.
- ! Grounding is not only necessary for one piece of equipment but for the whole system. All single units should be connected to the same ground point to avoid potential differences. If more than one system grounding point is used, a low-resistance connection between those points is imperative.

4.3.2 Earthing

Grounding and earthing have separate functions in equipment and different rules apply to them. Earthing is solely for safety reasons, so the resistance of the earth connection is important. Most safety standards required the earth connection to be tested. Grounding, however, is mostly used for EMC reasons. More important than the resistance is the impedance of the ground connection, especially at higher frequencies. Plain connections are therefore more effective than point connections. Flat, braided cables should also be preferred over round solid wires.

Grounding should never be confused with earthing. Earthing is the connection of the whole system to common ground for safety reasons. Grounding can be applied for functional reasons or to improve EMC characteristics.

4.4 Suppression components

Interference can be reflected towards its source by incorporating an LC network in the noise path. This prevents interference energy from leaving a suppressed device and entering the power supplyline. An efficient inductor-capacitor combination to protect against line-conducted interference consists of the following:

- ! Series inductances in the interference paths
- ! Cx capacitors between phase and neutral
- ! Cy capacitors between phases and earth

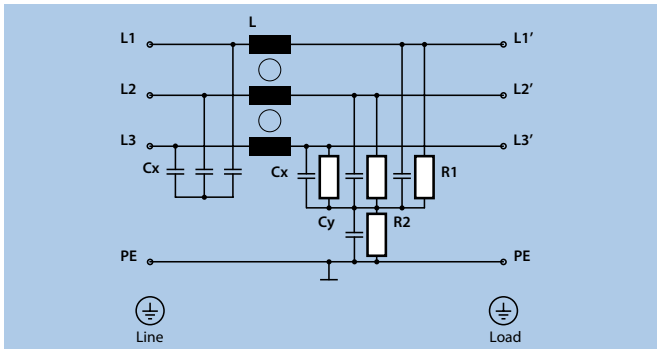

Typical circuit diagram of an EMI filter

4.4.1 Chokes

Chokes consist of an electrical conductor wound around a material with magnetic characteristics, the core. Various shapes exist for the core material: ring cores, D-cores, E-cores, I-cores, etc. Regardless of the shape, the choke always makes use of its magnetic characteristics to suppress RF noise.



Ring, D-, E- and I-cores

The core material pushes the performance of a choke to its maximum. It enhances the magnetic effects in the choke, improves the suppression characteristics and leads to more compact components. Core materials are also dependent on outside factors such as temperature or current, however. When used outside of its specifications, a choke can saturate, leaving it unable to supply its original impedance.

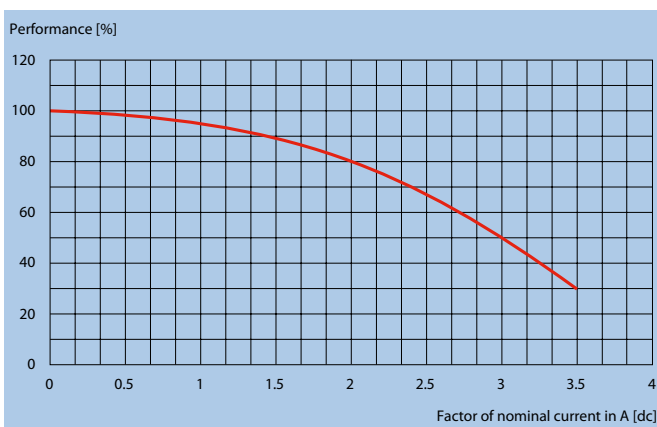

Saturation of chokes due to current

While the rated current is one of the main factors causing saturation, high asymmetric noise currents can be another reason for this effect. Saturation can be avoided by keeping the choke within its specifications or by a special winding technique called current compensation. This is explained later.

The impedance characteristic of a choke in relation to the frequency makes it an interesting component for noise suppression. The impedance increases at higher frequencies. Theoretically, the impedance would continue to increase with the frequency. A real choke, however, includes a certain winding capacitance. When the resonance point is reached, the impedance of the choke will reverse and decrease. This is shown in the following picture.

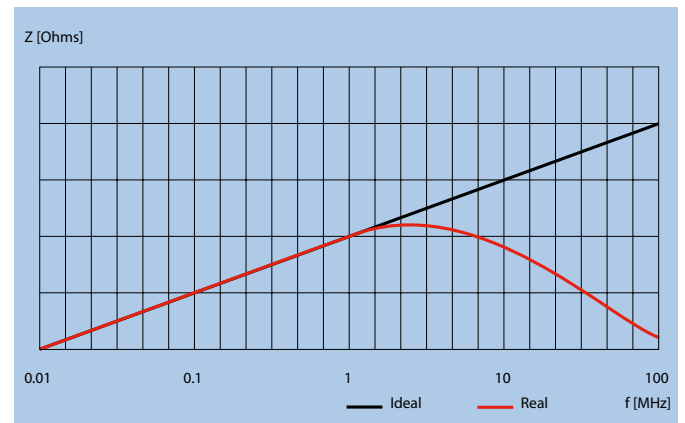

Typical impedance characteristic of chokes

Three main types of chokes may be used for the purpose of noise suppression:

- Common-mode chokes – with multiple windings to avoid saturation (loss of effective inductance) of the core material
- Saturating chokes – ideal for reducing fast current changes
- Rod-cored chokes – which present a constant inductance even at high currents

Common-mode chokes (RN, RD and EV/EH series) are used to attenuate common-mode or asymmetric (P/N → E) interference signals by being connected in series with the phase and neutral lines of an AC power line input. The magnetic fields produced by this winding technique cancel each other out. Full inductance is only presented to interference signals that flow asymmetrically from phase/neutral to earth.

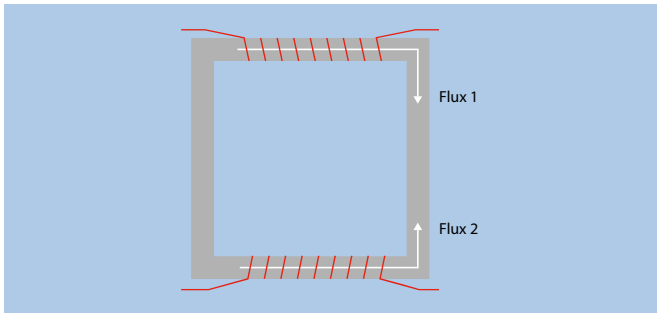

Principle of current compensation

Symmetrical components of the noise are also attenuated by the leakage inductance of the windings. The impedance of the choke at power line frequencies is therefore negligible, resulting in practically zero voltage drop. These chokes are typically used in conjunction with suppression capacitors as follows:

- In phase-angle control circuits where the desired degree of suppression cannot be achieved by saturating chokes alone
- For suppressing high interference levels from ultrasonic generators, fast rectifiers, switched mains equipment etc.
- For suppressing equipment with no earth connection
- For input filters to protect digital circuitry from mains-borne interference

Saturating-type chokes (RI types) change impedance at the moment of switching and can be used to attenuate differential mode or symmetrical (P → N) interference as generated by phase angle control devices such as thyristors and triacs. Interference levels can be brought within the limits of national and international regulations by using these chokes in conjunction with appropriate suppression capacitors. For optimum attenuation, chokes must be connected as close as possible to the semiconductor switching device. A simple single-stage suppression circuit is shown in the following illustration; this can be made into a dual-stage filter by the load itself and one additional capacitor.

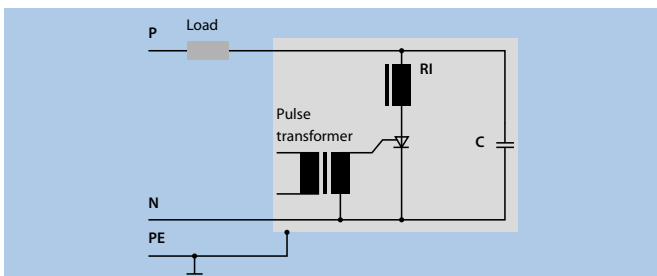

Saturating chokes in series with thyristors

4.4.2 Capacitors

Capacitors are basically two metal plates separated by a distance filled with a non-conductive medium like air, but more often other sturdy materials are used to improve the capacity. Most solutions in this catalog employ a self-healing plastic film dielectric, which offers significant quality and reliability advantages. All capacitor dielectric materials contain pinholes and other imperfections; during manufacture, a high voltage is applied to the dielectric to burn away the metallization around the pinhole, creating a high-quality capacitor in which any weak areas are totally isolated. Similarly, if a voltage surge punctures the dielectric during normal operation, an arc occurs at the point of failure, melting the surrounding metal and isolating the area of the breakdown. This maintains the quality of the capacitor instead of causing a failure due to voltage breakdown. The impedance of a capacitor decreases at higher frequencies. Due to the inductive behavior of the connection leads, however, capacitors reach a point of resonance after which their impedance increases again.

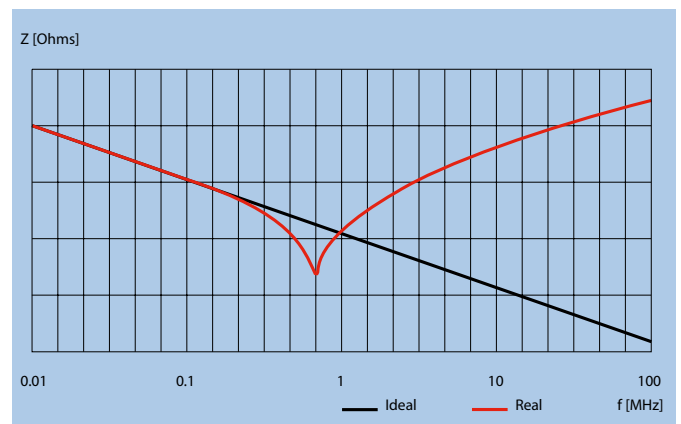

Typical impedance characteristic of RFI capacitors

Resonances can be almost completely avoided with feedthrough constructions. Instead of connection leads attached to the capacitor coil, the line is directed through the center of the coil. One side of the capacitor is then connected directly to the line; the other end is connected to the housing. The result is a common-mode capacitor without significant connection leads, thus avoiding resonance points.

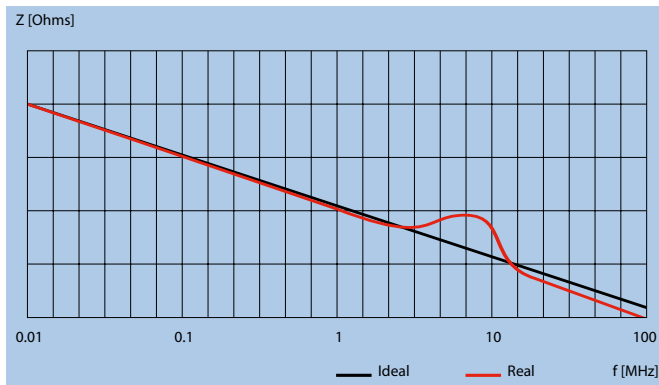

Typical impedance characteristic of a feedthrough capacitor

Capacitors are connected between phases or between phase and earth and are therefore subject to safety considerations. All the capacitors used in Schaffner's feedthrough components are of a series construction, which reduces the voltage stress on each capacitor element. This provides an excellent safety margin for high-voltage transients, and – in the case of AC feedthrough components – minimizes ionization effects to ensure long and reliable component life.

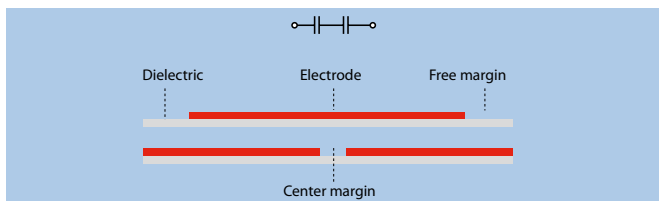

Series construction of capacitors

4.4.3 Filters

The mains, or power line, filter is the key element in eliminating mains-borne interference. This filter has to meet not only the requirements of electromagnetic compatibility (EMC) but safety aspects as well. For some applications, the filter also has to prevent the radiation of classified information from the mains line (TEMPEST applications). Other applications require a filter to protect equipment from destructive voltages on the power line, like those caused by lightning or nuclear explosion (NEMP).

Filters are available with a variety of electrical and mechanical specifications. PCB filters are designed for compactness and ease of assembly, and avoid the need for extra mounting components and installation operations necessary with chassis styles, but at the expense of finite available space for filtering circuitry. Consequently, they typically offer just a single stage of attenuation, with limitations on the maximum power handling capability. This typically makes these filters ideal for companies that have planned for EMC protec-

tion throughout the equipment design process and are completing equipment protection with these low-cost components. When integrating these components, care must be taken to provide a low-impedance connection to earth and minimize the potential for any noise radiation from the mains inlet connection.



Schaffner PCB filter FN 409

IEC inlet filters are widely used for interference suppression purposes in computers and their monitors, business equipment such as printers or copiers, and in medical devices. The filters combine the commonly used IEC inlet with excellent filter performance at a very small size and are therefore an excellent choice for equipment with switch-mode power supplies (SMPS). In addition to the classic filter function, IEC inlet filters are also available in combination with switches, fuse holders and/or voltage selectors.



Schaffner IEC inlet filter FN 9222

Chassis mount filters provide a higher performance solution in metal cases for optimum connection to earth and good high-frequency performance. With the space available for up to three circuit stages for noise attenuation, users can usually find an option with the performance to provide an off-the-shelf solution for even the most difficult EMC problem (retrofitting an EMC solution to an existing design, for instance).



Schaffner chassis mount filter FN 2410

Power electronic devices such as industrial frequency converters, as well as machine tools, are typical application areas for three-phase power line filters. In addition to this industrial market sector, these types of filter are also suitable for mainframe computer systems, large uninterruptible power supplies, and medical equipment such

as X-ray machines. All the filters are supplied in chassis mounting metal cases, facilitating good connection to earth and optimum high-frequency performance. Versions are also available with a neutral line or different operating voltages up to 690 VAC, enabling designers to quickly locate the most economical and technically suitable EMC solutions for their projects.



Schaffner three-phase filter FN 3270

Feedthrough capacitors and filters offer a particularly cost-effective means of combating conducted interference. Offering a high insertion loss across a broad band of frequencies – from a few tens of kHz right through to the GHz region – these single-line components are exceptionally easy to fit and can provide a more economical RFI suppression solution than dedicated filters, especially for systems that have multiple input or multiple output power lines.



Schaffner feedthrough filter FN 7611

4.4.4 Filter attenuation

Filters are generally described by their attenuation, also called insertion loss. In order to determine the attenuation, a defined source and load are connected and the signal from the source is measured. The filter is then inserted and the measurement repeated. The attenuation is then calculated from the two results with

$$A[\text{dB}] = 20 \cdot \log \frac{V_2}{V_1}$$

where V_2 and V_1 are the results with and without the filter, respectively. The measurement is described in CISPR 17. The load and source impedance must be 50Ω each. Both asymmetrical (common-mode) and symmetrical (differential-mode) attenuations need to be measured. The results are then usually shown in an attenuation diagram.

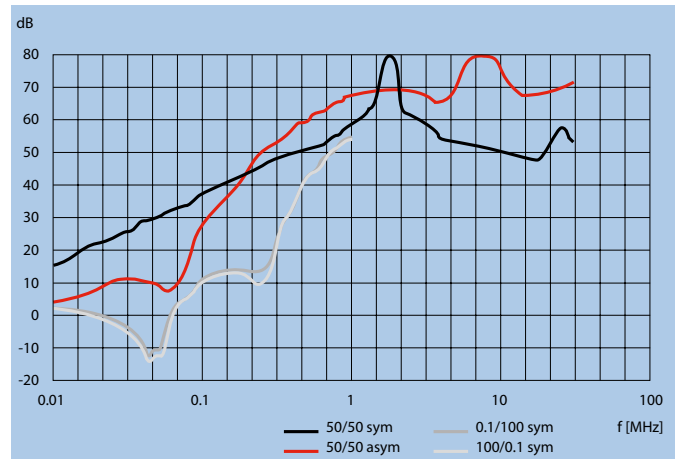

Typical attenuation diagram

The attenuation diagram of Schaffner products always shows two additional lines: the symmetrical attenuations for $0.1/100 \Omega$ and $100/0.1 \Omega$ load and source impedances. The attenuation diagram of a filter never reflects the subsequent reality, just the laboratory measurement conditions. Measurements at different impedance values easily show that the attenuation shifts with changing impedances. The attenuation characteristic also does not tell the end user how well the filter is going to perform under load conditions. Schaffner filters are therefore always tested additionally at various load conditions in order to guarantee good attenuation performance without saturation in the final application.

5 Power quality

Power quality is an issue of increasing importance, and many electricity supply utilities are now mandated to provide a mains supply with controlled quality parameters such as harmonic distortion and voltage limits. To achieve this, they must in turn place restrictions on the pollution caused by various types of connected load, especially those which draw distorted current waveforms.

5.1 Definition

In previous chapters about EMC measurements, we have already seen the effects of harmonics and voltage fluctuations on equipment connected to the power grid. These effects can be supplemented by frequency variations and similar interference related to the power grid voltage and frequency.

The efficiency of a power network is generally described by the power factor PF. This power factor is calculated by the formula.

$$PF = \frac{I_{1,rms}}{I_{rms}} \cdot \cos\varphi$$

where $I_{1,rms}$ = rms value of the fundamental current
 I_{rms} = rms value of the total current, including harmonics and distortions

The closer the power factor is to 1, the more efficient the power grid is being used.

When we move down to the equipment level and consider the quality of the power, we often come across frequency inverters. Frequency inverters are among the most widely used pieces of equipment for AC motor control. Nowadays, they are found in virtually every area of industry, in applications as diverse as pumps, air conditioning systems, elevators and cranes, conveyors, machine tools, alternative energy production and in a vast array of other industrial and domestic automation.

In the quest for ultra-compact, efficient power conversion, inverter manufacturers employ high-speed semiconductor (IGBT) switches and pulse width modulation (PWM) techniques to generate fast rise time voltage pulses of the appropriate duration and polarity. Unfortunately, this creates a considerable number of problems for OEMs and system integrators, from purely functional difficulties to very severe motor damage. There follows a brief summary of the most significant problems and phenomena:

Inverter input

- EMC problems
- Harmonics
- Commutation notches
- Inrush & peak currents
- Low-frequency interference

Inverter output

- Excessive dv/dt
- Peak & overvoltages
- Parasitic earth currents
- Eddy current losses in the motor
- Displacement currents in the coils
- Bearing currents
- Additional inverter pulse loads
- Acoustic motor noise
- EMC problems

Inverter DC link

- DC link capacitor stress
- Harmonics
- Various other problems

Whole system

- Low efficiency/low power factor
- Uncertain system immunity

- Unacceptable interference emissions
- Uncertain service security & reliability

5.1.1 Frequency ranges

According to the definitions in the standards, EMC deals with a frequency range from DC to 400 GHz. However, limits are currently only defined for a very limited area of that whole frequency range.

The following ranges are currently defined:

- 50/60 Hz to 2.5/3 kHz for mains harmonics (depending on power frequency)
- 150 kHz to 30 MHz for line-conducted emission
- 30 MHz to 1 GHz for radiated emission
- 9 to 150 kHz for certain equipment for conducted emission
- 1 GHz to 18 GHz for some industrial equipment for radiated emission
- 1 GHz to 40 GHz for some telecom equipment for radiated emission

This leaves an undefined area from 2.5/3 kHz to 150 kHz. However, this area is not noise-free; it is simply not regulated. While excessive noise in this frequency range will not lead to non-compliant equipment, it will most certainly lead to functional problems.

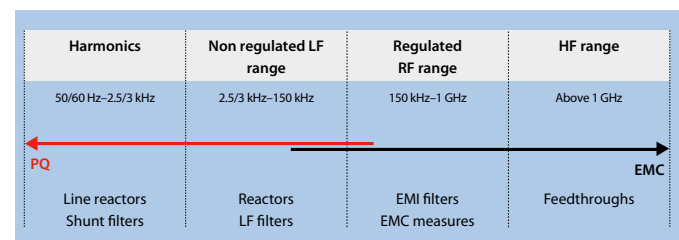

Regulated and non-regulated frequency ranges

The lower frequency range is typically seen as the power quality (PQ) range. However, the picture above illustrates that the PQ and EMC ranges overlap. As a matter of fact, EMC is only one part of the overall power quality. The same is true for the solutions. A filter for the conducted emission range from 150 kHz to 30 MHz will not simply cover this defined range; it will also attenuate at lower and at higher frequencies. Manufacturers can therefore profit from a single provider of PQ and EMC solutions like Schaffner.

5.2 Reactors in drive systems

5.2.1 Need for protection

Manufacturers of variable speed drives (VSD) nowadays are operating in an extremely competitive marketplace, and the tendency is to offer drive products without input reactors unless the end user specifically requests it. Users, though, often are not familiar with the reasons why a reactor is beneficial both for the reliability of the drive's electronics and for the quality of the power supply. The introduction of an input reactor has the following effects:

- | Buffers the electronics from input transients due to utility and load switching elsewhere in the supply
- | Prevents high inrush currents and reduces the transient load on the input components
- | Improves VSD crest factor, reducing power input line losses
- | Controls emissions of line current harmonics due to the rectifier input circuit
- | Controls the impact of commutation notches on the power supply
- | Protects and increases the service life of DC link capacitors of VSDs
- | Reduces differential-mode low-frequency phenomena up to a few hundred kHz

5.2.2 Overview of uses

Reactors and filters can be used in various locations in a power drive system: in line with the power input (line reactor), in the DC link between the rectifier and capacitor (DC link choke) and at the drive output to the motor (motor reactor). A reactor at each of these positions has specific effects that are by no means mutually exclusive. Generally, it would be unnecessary to have a reactor in both the power input and the DC link, but the functions of the input line reactor are quite different from a filter at the drive output, and it is entirely reasonable to include both of these.

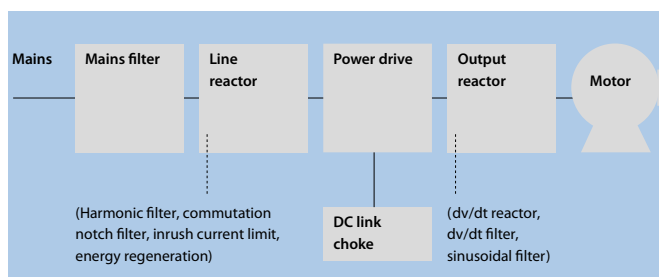

Possible locations of reactors in drives

5.2.3 Line input

A reactor in the power supply input will do two things: protect the drive electronics from power disturbances and protect the power supply from disturbances created by the drive.

Harmonic attenuation. A three-phase input rectifier with a reservoir capacitor draws current discontinuously. When the input voltage across any pair of diodes is greater than the DC link voltage maintained across the capacitor, then current flows and charges the capacitor. When the input voltage is less, the diodes block the input current and the reservoir capacitor supplies the DC link current. This gives rise to a characteristic “double pulse” input current drawn from any of the three phases; these accumulate in the DC link to give a series of unipolar pulses of current at six times the frequency of the input (300 Hz in EU applications).

The discontinuous phase current is rich in harmonics of 50 Hz. The total harmonic distortion (THD) is typically 90% to 150% with a harmonic content predominantly made up of 5th, 7th, 11th and 17th harmonics.

The effects of these harmonics on the power supply and ultimately on other users are manifold:

- | Transformer and neutral conductor overload due to excessive zero-phase currents
- | Overheating of power factor correction capacitors due to high frequency currents
- | Conductor losses due to skin effect at higher frequencies
- | Voltage distortion, amplified at remote points in the network due to resonances
- | Failure of direct-off-line induction motors trying to run at harmonic frequencies
- | Acoustic and electrical interference at audio frequencies
- | Increased earth leakage currents due to stray and EMI filter capacitances

The electricity supply industry is naturally keen to reduce these effects. Electricity suppliers are required in many countries today to offer a supply of guaranteed quality, and they can do this only if the users’ pollution is controlled. Limits are placed on harmonics emissions either by the terms of connection offered by the utility or by a requirement to meet international standards, of which IEC 61000-3-2 for equipment <16 A per phase and IEC 61000-3-12 (draft) for equipment current between 16 and 75 A per phase are the most significant. In the USA, harmonics are in the scope of the IEEE 519 standard. To meet these requirements for a standard three-phase rectifier-reservoir input circuit, some inductance in line is needed. This is the function of the line reactor. The reactor’s inductance slows the rate of rise of each individually rectified pulse and continues supplying current for a millisecond or two after the input voltage has dropped below the DC link voltage. The six-pulse waveform is thus “stretched” and can become continuous rather than discontinuous if the inductance is high enough.

At the same time, the peak amplitude of the current is reduced. This means that the crest factor of the waveform is reduced so that the peak-to-rms ratio is lower. This has many benefits, including lower stress on the reservoir capacitors and hence greater reliability. The harmonic attenuation is directly related to the value of inductance in circuit. Since Schaffner reactors are specified as a percentage voltage drop, we can relate this percentage to the harmonic attenuation as shown in the table below. As can be seen, the 4% inductor gives considerably better harmonic attenuation than the 2% inductor but at the cost of greater voltage drop and a much larger component.

In addition to standard line reactors and harmonic filters, Schaffner can also offer a variety of customized solutions for harmonics reduction.

Relation between uk and harmonics reduction

Harmonic Number	Input impedance uk in % vs. remaining harmonics										
	0.5	1	2	3	4	5	6	7	8	9	10
5	80	60	46	40	34	32	30	28	26	24	23
7	60	37	22	16	13	12	11	10	9	8.3	7.5
11	18	12	9	7.4	6.3	5.8	5.2	5	4.3	4.2	4
13	10	7.5	5.8	4.9	4.2	3.9	3.6	3.3	3.15	3	2.8
17	7.3	5.2	3.6	3	2.4	2.2	2.1	0.9	0.7	0.5	0.4
19	6	4.2	2.8	2.2	2	0.8	0.7	0.4	0.3	0.25	0.2
THID	102.5	72.2	52.3	44.13	37.31	34.96	32.65	30.35	28.04	25.92	24.68

5.3 Output solutions for motor drives

At present, there are trends observable in the motor drive market that could have tremendous effects on the reliability of entire drive systems and the measures taken to guarantee it:

- Miniaturization, both of motor drives and motors, often accompanied by cost savings in the insulation strength of motor windings
- Retrofitting of motor drives in existing systems with old motors and unshielded cables
- Trends towards high-rotational speed machines with low mass (such as HF spindles)
- Innovative low-speed motor technologies with a high number of poles (such as tool beds with torque motors in machine-tool engineering applications)

Motor drives are known sources of interference and are therefore usually equipped with an input filter. However, fewer people are aware of the problems on the output side where the converter supplies the motor with the modulated signal. Some of the typical output challenges are described below.

5.3.1 dv/dt – voltage potential jumps in relation to the time

To keep the losses in the frequency converter or servo low, the aim is to keep the switching times of the power semiconductors as short as possible. The result of this is that with the newest generation of IGBTs, rise times of sometimes more than $12 \text{ kV}/\mu\text{s}$ can be measured, whereas – depending on the motor – a dv/dt of $<1000 \text{ V}/\mu\text{s}$ is considered permissible (VDE 0530 : 500 to $1000 \text{ V}/\mu\text{s}$).

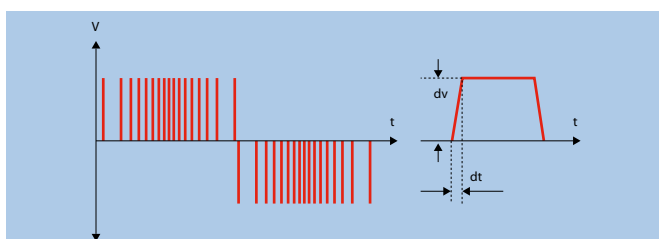

Definition of dv/dt

In the case of short motor cables up to about 20 m, these rise times – owing to the small line impedance – act fully on the insulation of the motor windings. Depending on the structure of the motor coils, wires that carry the full voltage are situated immediately in parallel and next to each other. Since even very short parallel-laid wires have a capacitive action, the permanent potential jumps result in pole reversal losses across the winding insulation. Now, if the enamel insulation is impure even to a very minor extent, this results in the so-called hot-spots, and hence, sooner or later, to a destruction of the winding insulation. In any case, this dv/dt stress load leads to premature aging and thus to a reduction in the life of the motor.

5.3.2 Voltage overshoots and voltage peaks

Voltage overshoots and voltage peaks can come with high dv/dt values but are also a problem on their own. Due to the structure of the windings, a motor acts like a capacitor in the equivalent circuit diagram – owing to the fast voltage pulses of the switching frequency – and not as an inductance, as is the case in normal 50 Hz applications. With every additional meter of motor cable, more wire inductance is added to this structure. This inductance acts like a choke according to the energy storage principle. If chokes are subject to voltage pulses, voltage peaks occur every time switching on or off takes place. The higher the energy content (inductance) of the choke, the higher these voltage peaks become. In other words, the longer the motor cable, the higher the maximum voltage amplitudes. These amplitudes can, in turn, reach values that cause a stress situation in the winding insulation of the connected motor. Owing to the cable impedance, the dv/dt stress – in the case of longer motor cables – is reduced to less problematical values. On the basis of the line theory, however, peak values of 1600 V or more (depending on the DC link voltage) can occur due to cable reflections, which can have very steep dv/dt values. According to VDE 0530, peak values of $<1000 \text{ V}$ are recommended. Despite the reduced dv/dt owing to the cable impedance, there is no significant stress relief for the motor, since now the increased voltage amplitudes represent the dominant stress factor.

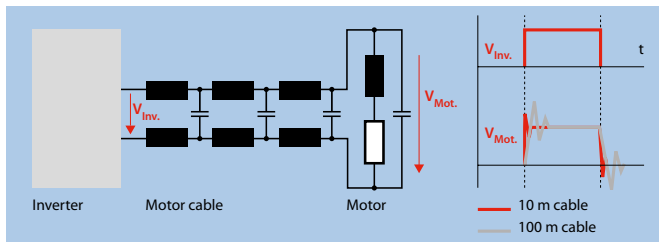

Simplified equivalent circuit of shielded cables

Note that the picture above shows only the equivalent circuit of one phase.

5.3.3 Additional losses in the motor

Apart from the problem with the winding insulation, the steep switching edges create another phenomenon: harmonics of the output signal. By applying Fourier analysis, it can be mathematically proven that the harmonic spectrum of the motor currents becomes wider with the steepness of the pulses – that is, the harmonic content increases. The current ripple (PWM and harmonics) results in additional magnetic losses in the motor. The life of the motor is sensitively shortened owing to the permanently increased operating temperature.

5.3.4 Cable shields and parasitic earth currents

From the standpoint of EMI suppression, shielded motor cables are required to avoid back-coupling of radiated interference to the mains cable in the frequency range from about 1 to 30MHz. This measure of the EMC can, however, only be considered to be efficient if the ends of the cable shield of the motor cable are put in contact with the ground of the motor and the frequency converter – if possible, at HF low impedance and over as large an area as possible. This ensures that the interference currents can mostly flow back to the source by the shortest route.

Frequency converters normally work in grounded networks and do not have any potential separation. The geometric expansion of both the frequency converter motor and this shielded motor cable therefore form parasitic capacitances of the electrically conducting components with respect to the ground potential. If the available DC voltage is chopped in the frequency converter, then during the potential jumps of the voltage, considerable pulse currents flow across the parasitic capacitances to the earth. The level of the interference currents on the cable shield depends on the dv/dt as well as the value of the parasitic capacitances ($I = C \cdot dv/dt$). With a motor cable length of about 100m, peak values of the pulse currents of 20 amperes and more are not unusual, regardless of the power rating class of the drive.

The harmonic spectrum of these currents can reach a range of several MHz. The shield of the motor cable, owing to the existing braid-

ing, offers a very large surface area and a sufficient cross-section to carry these currents. As a result, the impedance of the shield across a broad frequency range is of a very low-impedance nature. Losses due to the skin effect are limited to a minimum because of the large surface area. Inadequate ground connections of the cable shield (the so-called “pigtailed”), on the other hand, are highly resistive for the frequency range under consideration and often nullify the desired shielding effect.

If there are parallel-laid control cables or electronic components in the vicinity of the motor cables, pulsed HF currents flow across their geometric expansion and the resultant parasitic capacitances, which in turn could have an impermissible influence on neighboring equipment through capacitive coupling.

If neighboring components are located in the immediate vicinity of the motor cable, the conductor loops and the high di/dt values of the shield currents also result in a magnetic coupling that can also lead to impermissible influencing.

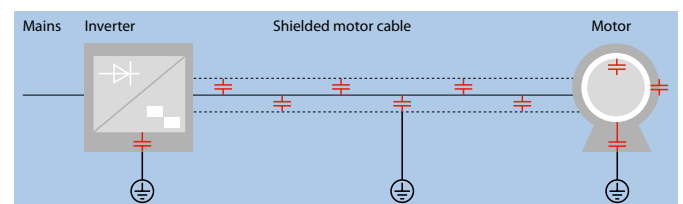

Parasitic capacitances in a drive system

The currents flowing across the shield must be supplied by the frequency converter as well. They are not dependent on the rating of the drive but only on the geometric expansion of the structure. With small power ratings, the result of this, especially in case of long motor cables, can be that a frequency converter of the next higher rating has to be used that is able to supply both the currents required by the load and the parasitic currents via the earthing. The operation of several motors connected in parallel on one frequency converter is problematic. The parallel connection of several shielded cables results in a relatively high total capacitance and thus correspondingly high shield currents. The parallel connection of several drives, however, is accompanied by even more problems. Parasitic currents across the motor and the entire system can considerably affect the reliability of the whole system.

5.3.5 Bearing damage

A general distinction has to be made between two different physical occurrences:

- The shaft voltage (or rotor voltage) is an inductive voltage that is induced in the motor shaft owing to the differences in the flux densities of the stator and rotor. Above all, it is influenced by the

length of the motor. As long as the lubricant film in the bearing is intact, the voltage builds up until, finally, a compensating current flows towards the earth. In this case, the path of least resistance is through the motor bearings. This bearing current (I_b), over a long period of time, usually results in drying of the bearings and thus failure of the motor. It is possible to counter this phenomenon to a certain degree through the use of ceramic bearings.

! The bearing voltage is an asymmetric (common-mode) voltage that occurs because of capacitive coupling between the motor housing, the stator and the rotor (C_1, C_2, C_3) and results in dv/dt and electrostatic discharge currents ($I_{dv/dt}$ and I_{EDM}) across the bearing ($C_{\text{Bearing}}, U_{\text{Bearing}}$). To be more accurate, this bearing voltage results in two different currents: in the first minutes of operation, as long as the lubricant in the bearing is cold, currents in the range of 5 to 200 mA ($I_{dv/dt}$) flow through C_{Bearing} because of the dv/dt . These rather negligible currents generally do not result in any bearing damage. After a little while, when the lubricant film has heated up, peak currents of 5 to 10 A and more can be measured (I_{EDM}). These flashovers leave behind small pits on the surface of the bearing. The running of the bearing becomes increasingly rough because of the damaged surface and the life is thus considerably shortened. Typically, the bearing voltage is between 10 and 30 V. But since it is directly dependent on the mains supply voltage, bearing damage increases overproportionally at higher supply voltages.

In the case of unshielded motor cables, the cable capacitance (C_{Cable}) and hence the current (I_{Cable}) is relatively small. The parasitic capacitances on the inside of the motor dominate. Ideally, the parasitic currents flow through the motor housing to the ground (I_{C1}). However, if the grounding of the motor is inadequate, an additional impedance results ($Imp.$), which limits the current (I_{C1}). As a result of the additional impedance, the potentials at C_2, C_3 and C_{Bearing} increase sharply. The values of the bearing currents also increase massively and flow fully through the bearings to the earth (I_{Bearing}); in that case, the life expectancy of the ball bearings, and hence of the entire motor, is reduced to a few hours.

5.3.6 Acoustic noise levels

Compared to the previously described problem cases, the whistling noises of the motor – caused by the switching frequency – would appear to be negligible. However, in applications related to heating, ventilation and air-conditioning technology (HVAC), in which the noise is distributed more intensely in the entire building through air ducts or heating pipes, this point has to be taken into account.

5.3.7 Solutions for output problems

For reasons of cost, time and space, an attempt is generally first made to manage without additional components. However, the subsequent costs that can result from motor or system failures are often entirely out of proportion to the far lower initial costs of preventive interference suppression measures.

If the decision is made in favor of components to increase the reliability and operational safety, the following types have established themselves in the market:

- ! dv/dt chokes and filters (low inductance, hardly any reduction in the control dynamic)
- ! Motor chokes (increased inductance, better signal smoothing, but not universally applicable to controlled drives)
- ! Sinusoidal output filters (high L and C for optimizing the output signal, but also not universally applicable)

Traditional symmetric sinusoidal output filters – FN 5020, FN 5040, FN 5045. Traditional symmetric sinusoidal output filters are LC-low passes filters that convert the PWM signal of the frequency converter between the phases into a smooth sinusoidal curve. The residual ripple of the signal can be adjusted by using the values of the L and C. An optimum cost-benefit ratio is often reached at a ripple voltage of 3 % to 5 %.

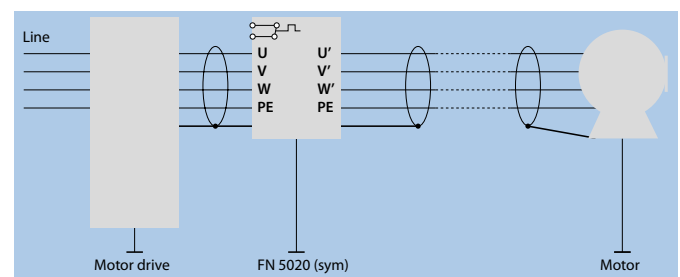

Drive with symmetrical sinusoidal filter

Symmetric sinusoidal output filters connected directly to the converter output have, above all, the following advantages:

- ! Complete protection of the motor from dv/dt and overvoltages
- ! Reduction of the additional magnetic losses and eddy current losses in the motor
- ! Reduction of the additional losses of the frequency converter owing to lower pulse currents to earth
- ! Reduction of the acoustic noise of the motor
- ! Reduction of the interference potential coming from shielded motor cables
- ! Increase in the reliability and operational safety of the overall system

For a large number of applications, this can be considered the ideal solution. Most problems are solved efficiently and in a cost-effective manner with the symmetric sinusoidal signal.

In some cases, additional measures are necessary. Symmetric sinusoidal filters, despite all their advantages, are not able to improve certain problem cases, since despite the filter, there is still a pulsed signal to earth. These problems are:

- ▮ Bearing damage
- ▮ Parasitic earth currents
- ▮ Necessity of shielded motor cables
- ▮ Limited maximum possible motor cable length

Sinus Plus symmetrical and asymmetrical sinusoidal output filter – FN 530, FN 5020 with additional module FN 5030.

Sinus Plus is a highly developed modular sinusoidal filter concept from Schaffner that is unique in the market today. Consisting of a traditional symmetric and an additional asymmetric sinusoidal filter module, it can be customized exactly to any requirement. Through innovative circuits and an additional connection to the DC link, the additional module is capable of sending the asymmetric interferences directly to the very place they originated.

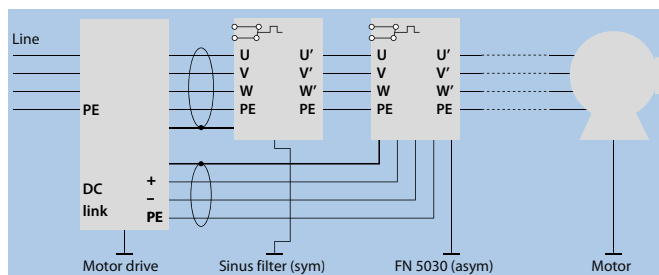

Drive with symmetrical and asymmetrical filter modules

This procedure is in keeping with the basic principle of interference suppression techniques: take the necessary measures at the source of the noise, not at the drain. Sinus Plus should always be considered to be a modular system in which the symmetrical filter part (FN 5020) can be connected autonomously but the asymmetric (FN 5030) may only be connected together with the symmetric module. FN 530 combines both solutions in one box. Operated in combination, this solution results in the following additional advantages:

- ▮ Complete elimination of bearing damage
- ▮ The possibility of using unshielded motor cables without any reductions in immunity
- ▮ Practically no more limitations with regard to the maximum cable length
- ▮ Almost complete elimination of the pulse currents to earth
- ▮ No interference influence of neighboring cables and equipment

- ▮ Elimination of the additional losses in the frequency converter
- ▮ Reduction in the suppression efforts on the input side. Since frequency converters are operated in ground-referred networks, every measure taken on the output side also influences the behavior on the input side (and vice versa). Since hardly any pulsed interference currents flow to the earth when Sinus Plus is used, the asymmetric part of the EMC mains input filter can be reduced, resulting in total cost savings.

II Annotations to filter specifications

1 Filter ratings

1.1 Electrical specifications

Where indicated, the component values in the datasheets are nominal values. The actual values can vary from the indicated ones based on the electrical tolerances given by the manufacturers. The test conditions for the components are listed below.

Tolerances and test conditions for passive components

Inductance	30%	50%	1 kHz
Capacitance	20%	20%	1 kHz
Resistance	10%	10%	DC

1.1.1 Current

Current ratings of EMI filters are determined by the individual filter components. Since current flow leads to a temperature rise in passive components, the ambient temperature of the environment where the filter is to be used has a direct impact on the rated current.

The nominal currents stated for our components refer to an ambient temperature of $\theta_N = 40^\circ\text{C}$ or $\theta_N = 50^\circ\text{C}$ as indicated on the component and in this catalog. The maximum operating current at any other ambient temperature θ can be calculated by means of the following formula:

$$I = I_N \cdot \sqrt{\frac{\theta_{\max} - \theta_{\text{act}}}{\theta_{\max} - \theta_N}}$$

where	I_N	rated current at θ_N
	θ_{act}	actual ambient temperature
	θ_N	temperature at which the rated current is defined
	θ_{\max}	rated maximum temperature of the component

If a filter with $I_N = 7\text{ A}$ at $\theta_N = 50^\circ\text{C}$ and a rated maximum temperature of $\theta_{\max} = 100^\circ\text{C}$ is to be used at an ambient temperature of $\theta_{\text{act}} = 65^\circ\text{C}$, the rated current of this filter must be reduced to $I_{N,65^\circ\text{C}} = 5.9\text{ A}$.

The actual current may also exceed the nominal current for a certain period of time. The exact specifications are given in the datasheet for each product.

1.1.2 Voltage

When looking at voltage ratings, care needs to be taken not to confuse the voltage rating of the filter with the nominal voltage of the power grid.

The most common nominal voltages are defined in IEC 60038. A European power grid, for example, has a defined nominal voltage of $230\text{ V} \pm 10\%$. The maximum voltage at the terminals can therefore be $230\text{ V} + 10\% = 253\text{ V}$.

The rated voltage of the filter defines the maximum continuous operating voltage, i.e., the maximum voltage at which the filter should be used continuously. Short overvoltages are permitted in accordance with IEC 60939, but to avoid damage to the filter capacitors, the continuous voltage should not exceed the rated voltage for an extended period of time.

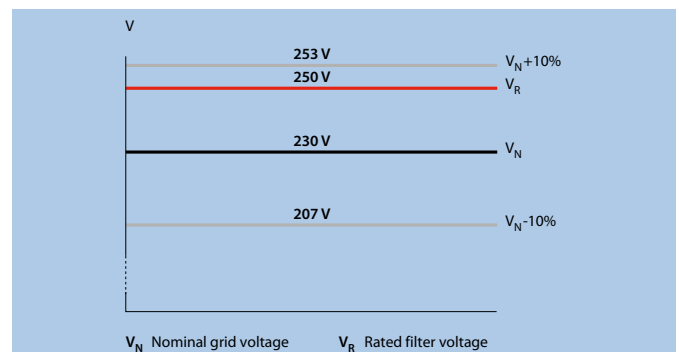

Relation between nominal and rated voltage

The nominal voltage +10% can exceed the rated voltage of the filter, as shown in the graph above. It is important to note that the nominal voltage of power grids is supposed to be at the defined value and within the boundaries of $\pm 10\%$ but not continuously at one of the limiting values. It is therefore safe to say that a power network in Europe will not run continuously at 253 V.

The voltage rating is usually given for a supply frequency of 50/60 Hz. If the filter is operated at higher frequencies (e.g., 400 Hz), the voltage must be derated. This is also described in the following chapter.

The rated voltage of three-phase filters indicated on labels, in datasheets or catalogues sometimes lead to confusion when only one voltage value is stated, i.e. 480 VAC. This value always has to be understood as phase-to-phase voltage. The respective phase-to-neutral voltage is $1/\sqrt{3}$ times this value, i.e. $480\text{ VAC}/\sqrt{3} = 277\text{ VAC}$.

The rated voltage of newer products indicated for both, phase-to-phase voltage and phase-to-neutral voltage respectively, stating i.e. 480/277 VAC.

1.1.3 Frequency

Depending on the type of filter, three different frequencies can be defined.

Supply frequency. The frequency of the AC mains supply network, typically 50 or 60 Hz. The operating frequency of the filter is determined by the behavior of the capacitors. Depending on the voltage-frequency characteristic of the capacitor, it might be possible to operate a filter at a higher frequency but with a reduced input voltage.

Switching frequency. The frequency used to switch the IGBTs in the output stage of a frequency converter or SMPS. This frequency has a direct relation to the power loss in the converter and in the output components. Generally speaking, lower frequencies result in lower losses. For an output filter, it is also necessary to consider the relation between the switching frequency and the resonance frequency of the filter. Our filters are always designed in such a way that the resonance frequency is at least 2.5 times lower than the lowest switching frequency.

Motor frequency. The simulated supply frequency of the frequency converter. This frequency determines the rotational speed of the motor. Most applications operate at 50/60 Hz motor fields, but applications with higher rotational speeds also exist (high-speed spindle drives up to 2000 Hz).

1.1.4 DC resistance

The DC resistance of the filter is the resistance measured at the relevant power network frequency, i.e., 50 Hz for European applications and at a defined temperature, such as 25 °C.

1.1.5 Discharge resistors

Discharge resistors are connected across the filter capacitors to avoid electrical charges at the terminals of the filter after the filter has been disconnected. Failure to do so can be lethal, and discharge resistors are therefore a safety standards requirement. Generally, high-value resistors are used to slowly discharge the capacitor after disconnection.

If a filter is to be used in IT power networks (see “Power distribution networks” chapter), discharge resistors are not recommended. In IT networks the insulation of the power system is usually monitored in order to detect initial fault conditions. Discharge resistors can interfere with the monitoring equipment and indicate fault conditions where none exist.

1.1.6 MTBF

The MTBF (mean time between failures) is the reciprocal value of the failure rate. The failure rate indicates the statistical percentage of units failing over a certain amount of time. The MTBF will thus change over time, because the reliability of a product decreases as components age. The MTBF in our catalogs is calculated according to MIL-HB-217F.

The MTBF should not be confused with the lifetime of a product. It is instead an indication for the reliability – that is, for the probability of failure in the field. As an illustrative example, we could look at the airbag in a car. The MTBF has to be very high, because the airbag should deploy when needed, even if the car is more than 20 years old. The lifetime of the airbag, however, is short: the deployment takes seconds and then the lifetime is over.

1.2 Mechanical specifications

1.2.1 Mechanical tolerances

The mechanical tolerances in our drawings are given in accordance with EN 22768-2 (ISO 2768-2). All measures in a mechanical drawing should have defined tolerances. Instead of defining each individual tolerance, it is sufficient to give a reference to the tolerance classes of the above-mentioned standard. The general tolerances are defined in categories “fine,” “medium,” “coarse” and “very coarse.” The table below shows the actual tolerance measures according to these categories.

Mechanical tolerances





	Rated measure in mm							
	≥ 0.5	> 3	> 6	> 30	> 120	> 400	> 1000	> 2000
	... 3	... 6	... 30	... 120	... 400	... 1000	... 2000	... 4000
Category	Tolerance measure in mm							
f (fine)	±0.05	±0.05	±0.1	±0.15	±0.2	±0.3	±0.5	–
m (medium)	±0.1	±0.1	±0.2	±0.3	±0.5	±0.8	±1.2	±2
c (coarse)	±0.2	±0.3	±0.5	±0.8	±1.2	±2	±3	±4
v (very coarse)	–	±0.5	±1	±1.5	±2.5	±4	±6	±8

1.2.2 Filter terminals and cable cross-sections

Schaffner filters can be equipped with a number of different standard connectors. Below is an overview of all standard connection

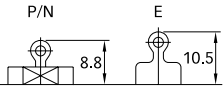
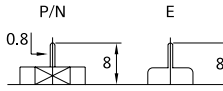
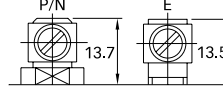
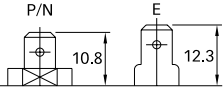
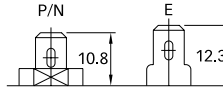
types available. Upon request, filters can also be built with other popular connection types. Please contact your nearest Schaffner office for more details.

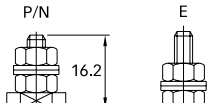
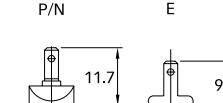
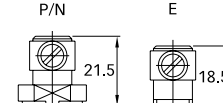
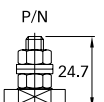
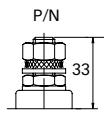
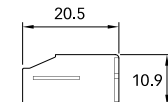
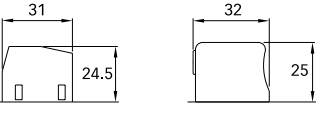
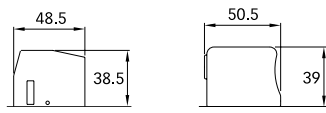
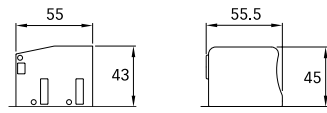
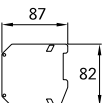
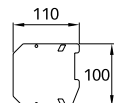
Terminals and connection types

<p>Type -01</p> <p>Solder lug with a hole capable of accommodating several small wires</p> 	<p>Type -02</p> <p>Pin suitable for direct assembly onto through-hole printed circuit boards</p> 	<p>Type -03</p> <p>Clamp terminal with M4 screw Recommended torque: 1–1.3 Nm</p> 
<p>Type -05</p> <p>Industry-standard size faston terminal 6.3 x 0.8 mm</p> 	<p>Type -06</p> <p>Industry-standard size faston, which may also be used as a solder lug 6.3 x 0.8 mm</p> 	<p>Type -07</p> <p>Insulated wire, stripped ready for soldering. Wire gauge varies according to filter</p> 
<p>Type -08, -09, -10</p> <p>08: M4 screw (1.3 Nm) 09: M5 screw (2.2 Nm) 10: UNC 8-32 screw (1.3 Nm)</p> 	<p>Type -13</p> <p>Faston, 2.8 x 0.5 mm</p> 	<p>Type -23</p> <p>Clamp terminal with M5 screw Recommended torque: 1.8–2.2 Nm</p> 
<p>Type -24</p> <p>M6 screw lead-through Recommended torque: 3.5–4 Nm</p> 	<p>Type -28</p> <p>M10 screw lead-through Recommended torque: 15–17 Nm</p> 	<p>Type -29</p> <p>Safety terminal block for solid wire 6 mm², flex wire 4 mm² or AWG 10 Recommended torque: 0.7–0.8 Nm</p> 
<p>Type -33</p> <p>Safety terminal block for solid wire 16 mm², flex wire 10 mm² or AWG 6 Recommended torque: 1.5–1.8 Nm</p> <p>HDFK 10 STB 10</p> 	<p>Type -34</p> <p>Safety terminal block for solid wire 35 mm², flex wire 25mm² or AWG 2 Recommended torque: 4–4.5 Nm</p> <p>HDFK 25 STB 25</p> 	<p>Type -35</p> <p>Safety terminal block for solid and flex wire 50 mm² or AWG 1/0 Recommended torque: 7–8 Nm</p> <p>HDFK 50 STB 50</p> 
<p>Type -36</p> <p>Safety terminal block for 95 mm² or AWG 4/0 cables Recommended torque: 20 Nm</p> 	<p>Type -37</p> <p>Safety terminal block for 150 mm² or AWG 6/0 cables Recommended torque: 30 Nm</p> 	<p>Type -16, -38</p> <p>16: Solder/faston, 2.8 x 0.5 mm 38: Faston, 2.8 x 0.8 mm</p> 

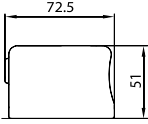
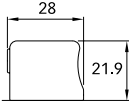
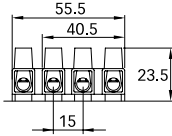
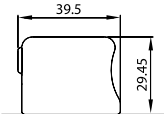
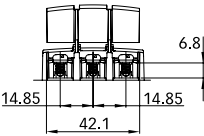
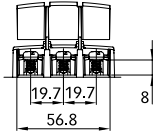
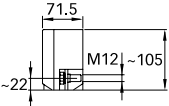
Type -40	Type -44	Type -47
Safety terminal block for solid and flex wire 95mm ² or AWG 4/0 Recommended torque: 17–20 Nm	Safety terminal block for solid wire 10 mm ² , flex wire 6mm ² or AWG 8 Recommended torque: 1.5–1.8 Nm	Strip terminal block for solid wire 16 mm ² , flex wire 10mm ² or AWG 8 Recommended torque: 1.9–2.2 Nm
	STB 6 	
Type -53	Type -71	Type -72
Safety terminal block for solid and flex wire 16mm ² or AWG 4 Recommended torque: 2–2.3 Nm	M4 screw terminal for ring/fork lug self-lifting Recommended torque: 1–1.2 Nm	M5 screw terminal for ring/fork lug self-lifting Recommended torque: 1.9–2.2 Nm
		
Type -99*		
High current terminal for flex wire 150 mm ² or AWG 6/0 Recommended torque: 27–30 Nm		
		

* Specification for FN 3100-300-99 only. Other -99 specifications (FN 2200, FN 3270, FN 3359, FN 3410, FN 3412) can be found on the individual product data sheets.

Below is a reference list showing the relation between the AWG number of connectors and the corresponding copper cross section of the wire.

AWG and metric cable specifications

AWG number	Cu mm ²
22	0.33
20	0.54
18	0.83
16	1.34
14	2.15
12	3.44
11	4.17
10	5.26
9	6.63
8	8.37
7	10.5
6	13.3

1.2.3 Torque specifications

The torque specifications in the table above are given to guarantee proper connections and avoid destruction of the terminals. They should be complied with at all times.

1.3 Environmental requirements

1.3.1 RoHS

With the adoption of EU Directive 2002/95/EC, the use of certain hazardous chemical substances is prohibited. Effective July 1, 2006, no new electric or electronic equipment may contain any of the following banned substances:

- a) Lead (Pb)
- b) Hexavalent chromium (Cr(VI))
- c) Mercury (Hg)
- d) PBB (polybrominated biphenyls) and PBDE (polybrominated diphenyl ethers)
- e) Cadmium (Cd)

As complete elimination of the banned substances is impossible, an EU Commission Decision of August 18, 2005 (2005/618/EC) tolerates certain maximum concentrations. These tolerances, defined by weight in homogenous materials, are:

- █ ≤0.1 weight % for a, b, c, d
- █ ≤0.01 weight % for e

The following exceptions are applicable as listed in the Annex of Directive 2002/95/EC:

- Lead as an alloying element
 - in steel containing up to 0.35 % lead by weight
 - in aluminum containing up to 0.4 % lead by weight
 - in copper alloy containing up to 4 % lead by weight
- Lead in glass of electronic components

As a global enterprise, the Schaffner Group designs and manufactures products in accordance with this legislation. We see the need for implementation and compliance as a key element of our business activity and, whenever possible, we strive to achieve concentration levels below the maximum tolerances.

Schaffner is using the following label to identify RoHS-compliant in documents and on its website.

RoHS

Labels for RoHS and lead-free compliance

1.3.2 Vibration and bump testing

Our filters are typically specified to maintain their characteristics when properly mounted after being subjected to a vibration test consisting of a sinusoidal sweep from 10 Hz to 55 Hz and back to 10 Hz for a duration of 120 minutes. The test is applied in the main axes and a deviation of ± 0.75 mm or 10g is used. Vibration testing is performed in accordance with the standard IEC 60068-2-6.

The filters will also maintain their characteristics after being subjected to the following bump test: 1000 bumps of 10 g, applied for 16 ms in three axes appropriate to the mounting instructions. The relevant testing standard is the IEC 60068-2-29.

1.3.3 Climatic classification

All components have to work in defined climatic conditions. IEC 60068-1 defines climatic categories and the relevant testing methods. Typically, the climatic category is indicated by three numbers separated by slashes as shown below.

25/100/21

25 Test A: cold (lower category temperature)
-25 °C (in accordance with IEC 60068-2-1)

100 Test B: dry heat (upper category temperature)
100 °C (in accordance with 60068-2-2)

21 Test C: damp heat (duration of test)
21 days (in accordance with IEC 60068-2-78)

For environments where the standard specifications are not sufficient (e.g., military) Schaffner can also offer custom-made solutions with extended environmental specifications.

2 Safety requirements

Most filters are connected in the mains supply line to the power supply system, making them the object of safety-related concerns. A number of items have to be considered during the design of a filter.

2.1 Type testing

Type testing is performed with an initial sample in order to verify the safety-relevant specifications for the design. All type testing is performed in accordance with the relevant safety standards. For some tests, the discharge resistors have been removed for type testing. This is in accordance with the relevant testing specification. When the filter is built into equipment and type testing is performed for the final equipment, the following points should be considered:

- Some tests might overstress the discharge resistors and lead to their destruction.
- In some cases, the equipment requires the measurement of the insulation resistance (e.g., EN 60204). This measurement cannot be performed with discharge resistors.

In special cases, samples without discharge resistors can be provided. Please contact your nearest Schaffner representative for details.

2.2 Hipot testing

In filters we use components that are connected between the phases of the supply network or between one phase and earth. It is therefore important to determine how well filters resist high voltages. A high-voltage test, often called hipot test, is performed for this reason by applying a voltage between enclosure and phase or between two connectors for a defined time. The current flowing between the same points is measured. Current flow means that the insulation is broken; the equipment fails the test.

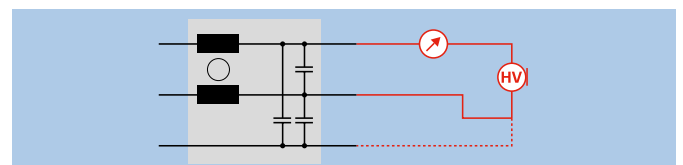

Testing principle of high-voltage testing

During approval procedures, the test is usually performed over a longer period (typically one minute) with a defined voltage. Many safety standards require the testing to be performed on 100 % of all units, but to save time, a test with higher voltage but reduced time

is accepted. It should be noted that repeated high-voltage testing can lead to a damage of the insulation.

The testing voltages used for 100% testing are indicated in the individual datasheets. Please note that hipot tests are high-stress tests for the capacitors inside the filter. Each additional test stresses the capacitors again and leads to a reduction of lifetime. Schaffner recommends keeping the number of hipot tests to a minimum and never testing the filters at higher than the indicated voltages.

2.3 Leakage currents

During normal operation of electrical equipment, some current flows along the protective earth conductor towards earth. Such currents, called leakage currents, pose a potential safety risk to the user and are therefore limited by most current product safety standards. Examples for these standards are EN 60950-1 for information technology equipment or UL 1283 for passive EMI filters. The standards include limits for the maximum allowed leakage current.

In most installations today we find residual current breakers or leakage-current breakers to protect against high leakage currents. Typical tripping values for these breakers are 30 mA where personal protection is the main goal and 300 mA for protection against fire.

For equipment that can by definition not meet these limits, additional provisions are required—for example, attaching special warning labels.

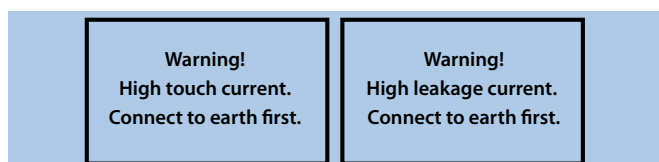

Warning labels for increased leakage currents

For passive EMI filters it is common to calculate the leakage currents based on the capacitor values against earth and other parasitic components. The following figure shows a typical capacitor configuration. In the case of a balanced capacitor network, the leakage currents will be negligible. On the other hand, the leakage currents will reach the maximum value at the highest imbalance between the phases. Causes for the imbalance are the tolerances of the capacitor values as well as the voltage imbalance in the supply network.

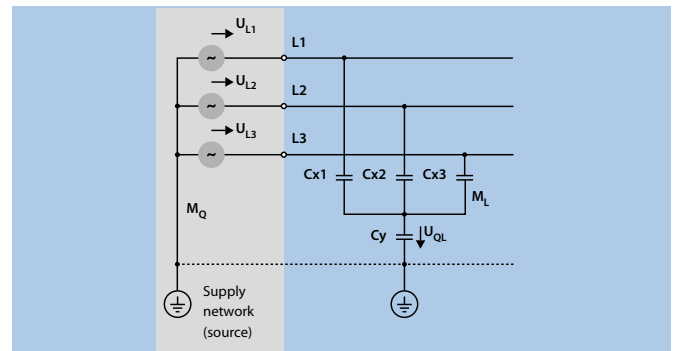

Typical capacitor configuration in three-phase filters

Most capacitors in passive filters are rated by the manufacturers with a tolerance of $\pm 20\%$. The highest voltage drop at C_y occurs when two of the X-capacitors show the lowest tolerance values and one shows the highest. In addition, C_y is assumed at its highest tolerance value. To put a good picture to the theory, a sample calculation can be performed with a 480V three-phase filter. The capacitor values are given at $C_x = 4.4 \mu\text{F}$ and $C_y = 1.8 \mu\text{F}$; the tolerances for all capacitors are $\pm 20\%$ according to the manufacturer. Not considering the supply voltage imbalance, the leakage current is calculated as approximately 23 mA.

Practical experience shows that the tolerances of capacitors are never spread that widely. An assumed tolerance range from -20% to 0% seems more realistic. Using this assumption in the calculation above results in a leakage current of only about 10mA. It should be pointed out, though, that there is no agreement between filter manufacturers regarding the calculation method for leakage currents in filters. It is therefore perfectly possible to have differing leakage currents in two filters, even though the circuit diagrams and component values are identical.

Up to this point, the voltage imbalance of the supply network was not figured into the calculation. In practical application, supply networks do have a certain imbalance. To include this in the calculation, we use the supply network standard EN 50160, which defines the conditions in public power supply networks. According to this standard, the voltage imbalance for regional networks can be up to 3%. Using this in the previous calculation, the leakage current now adds up to 26 mA for a capacitor tolerance of $\pm 20\%$ and 13 mA for $+0/-20\%$.

Compared to three-phase networks, the calculation of leakage currents in single-phase networks is significantly easier. With a given supply voltage and frequency, the leakage current depends solely on the total capacitance. The following figure shows the typical capacitor circuit for single-phase filters.

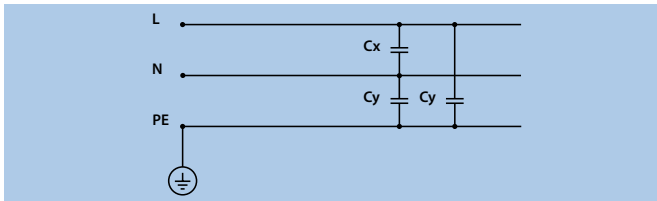

Typical capacitor configuration for single-phase filters

For a filter with $C_x = 100 \text{ nF}$ and $C_y = 2.2 \text{ nF}$ and a given tolerance of $\pm 20\%$, the leakage currents come to $190 \text{ }\mu\text{A}$. The worst-case scenario is given if the neutral conductor is interrupted. The total capacitance then consists of two parallel capacitors: C_{yL} on the one hand and the series connection of C_x and C_{yN} on the other. The following figure shows the equivalent circuit.

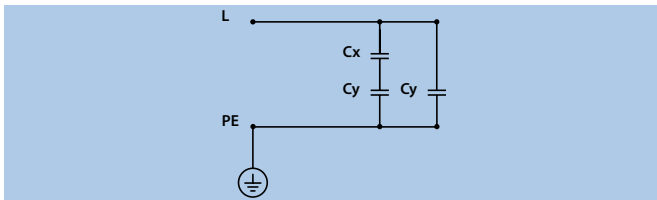

Total capacitance with interruption of neutral

For fault conditions, the maximum leakage current can be as high as $377 \text{ }\mu\text{A}$.

It was already mentioned that the leakage current is lowest when the supply network and the capacitor network are balanced. Every imbalance increases the leakage current. With this in mind, it is also obvious that the supply network topology must have a significant influence on the amount of leakage current from equipment. The network topologies are explained in the “Power distribution networks” chapter. Another potential source of imbalance problems is the moment when equipment is switched on.

2.4 Flammability classification

The American approval agency UL requires flammability tests for all plastic materials used in devices and appliances to ensure that the material cannot burn in case of malfunction of the equipment. The exact requirements are defined in the standard UL 94. During the tests, a specimen of the plastic material is exposed twice to an open flame. The exact specifications are given in the above-mentioned standard. During the test the following items are observed:

- Afterflame time after first flame application, t_1
- Afterflame time after second flame application, t_2
- Afterglow time after second flame application, t_3
- Whether or not specimens burn up to the holding clamp
- Whether or not specimens drip flaming particles that ignite the cotton indicator

Based on the results, the material is then classified as shown in the table below.

2.5 Fuses

All filters with fuse holders are delivered without fuses due to the variety of fuses in different local markets. Below you'll find a brief recommendation regarding fuses.

The maximum rated current in the specification is not always the fuse value required by our customers. Users should also consider the current rating in relation to the ambient temperature. A fuse needs to be selected by the user depending on ambient temperature, tripping rating, acting behavior (fast, medium, slow) and other electrical specifications. Fuse holders are designed to hold cartridge fuses with $5 \times 20 \text{ mm}$ for Europe and $6.3 \times 32 \text{ mm}$ for the USA. Please refer to the product datasheet to see the kind of fuse supported by a particular model.

Custom filters can be equipped and delivered with fuses. If you wish to buy IEC filter modules with pre-mounted fuses, please contact your local Schaffner sales office.

Test criteria for UL flammability classes

Criteria conditions	V-0	V-1	V-2
Afterflame time for each individual specimen t_1 or t_2	10 s	30 s	30 s
Total afterflame time for any condition set (t_1 plus t_2 for the five specimens)	50 s	250 s	250 s
Afterflame plus afterglow time for each individual specimen after the second flame application ($t_2 + t_3$)	30 s	60 s	60 s
Afterflame or afterglow of any specimen up to the holding clamp	No	No	No
Cotton indicator ignited by flaming particles or drops	No	No	Yes

3 Power distribution networks

3.1 Designation of networks

Throughout the world we find a variety of different power distribution networks. The most common ones are defined in IEC 60364-1. The constellation of the power network often has an impact on the filter performance, and some filters are even designed for specific networks to ensure maximum performance at the highest reliability level. The distribution networks are designated using the following codes:

AB (-C -D)

A	Grounding condition of the supply I: insulated T: grounded
B	Connection of the installation N: connected to PE T: grounded directly
C	Connection of N and PE C: connected S: separated
D	Indication that part of the system has separate N and PE lines

Example: TN-C-S: Grounded supply network where the installation is connected to PE. PE and N are combined to a PEN conductor, but in parts of the network there are also separate PE and N lines.

3.2 TN network

In TN networks one point of the distribution system is directly connected to ground. Each installation in the systems is connected to this common grounding point via the PE conductor. There are three different variations of TN networks

3.2.1 TN-S system

The S indicates that there must be a separate PE conductor throughout the whole system. The figures below show the possible configurations.

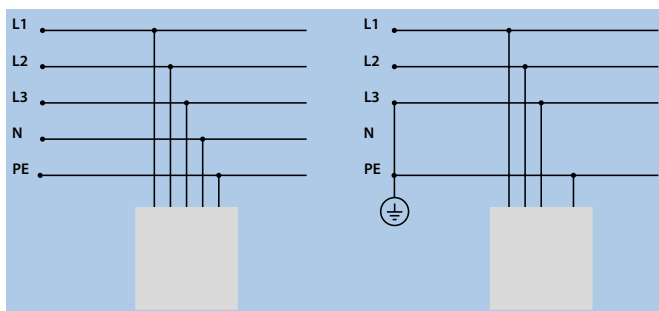

TN-S distribution networks

3.2.2 TN-C and TN-C-S systems

In TN-C systems the protective earth connector and neutral line are combined into one conductor. For a pure TN-C system this is done throughout the system. A system where PE and N are separated in some parts only is called TN-C-S.

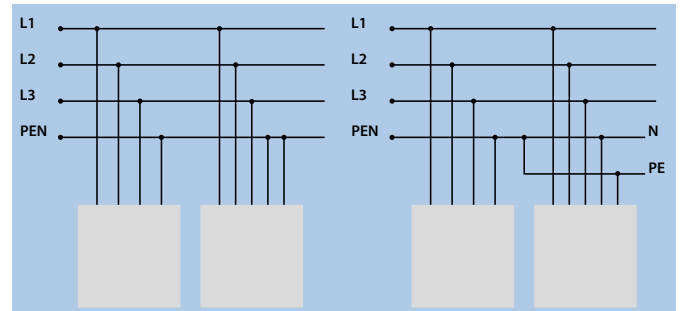

TN-C (left) and TN-C-S (right) distribution networks

3.3 TT network

In a TT system the ground points for the system and the installations are electrically separated. Both parts are grounded directly and independently.

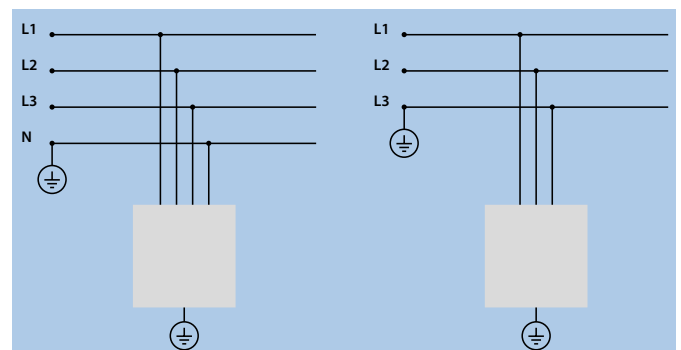

TT distribution networks

3.4 IT network

In an IT system there are two possibilities: either all active parts are separated from ground, or one point of the system is grounded via a defined high impedance (R_{GND}).

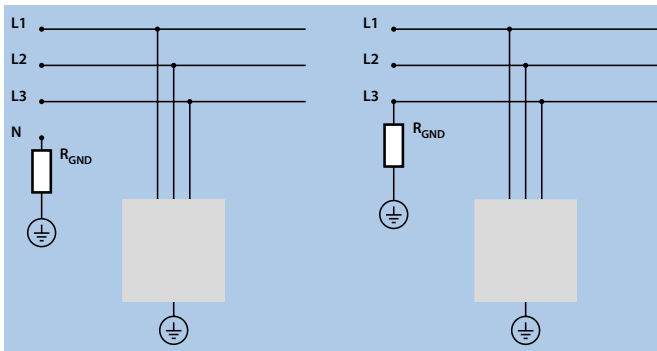

IT distribution networks

The setup comes with a number of special issues to be considered when using filters. For power networks one always considers the first-fault condition, where one phase is short-circuited to ground. The advantage of an IT system lies in the fact that in such a fault condition the risk of high touch currents is negligible. Inside of the filter, however, the voltage across the capacitors will increase significantly. If the filter is not specifically designed for IT networks, there is a good risk of destruction of the capacitors in the case of a network first fault.

An IT network with a single fault turns into a TN system, but with increased phase voltages. It continues to function, but for safety reasons the first fault should be repaired as quickly as possible. In IT networks, therefore, the insulation of the phases against earth is constantly monitored. If additional resistors are connected between line and earth inside connected equipment, the monitoring system is influenced and might detect non-existing faults. As a result, discharge resistors are not permitted in filters in systems for IT distribution networks.

Schaffner offers a variety of filters especially designed for IT networks, such as FN 258 HVIT and FN 3359 HV. For more details, please consult the datasheets for the products.

3.5 Network with one grounded phase

Some regions, such as Japan, utilize a power distribution network where one phase is directly earthed.

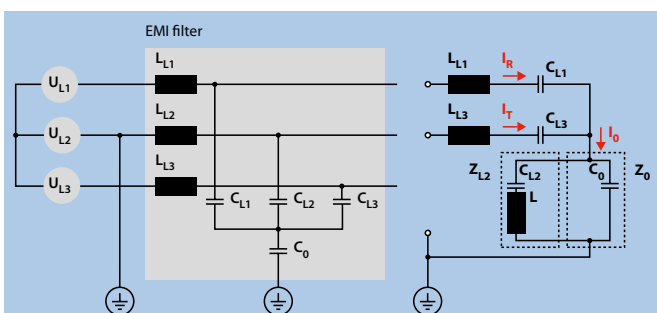

Power network with grounded phase and filter (left) and equivalent circuit (right)

With this arrangement the impedance towards earth is completely changed, resulting in different voltage drops and leakage currents. The outcome of this is that the standard rating for leakage currents cannot automatically be applied for networks with a grounded phase.

For such applications, Schaffner also offers a dedicated range of products in this catalog. Please consult the data-sheets for more information. Further products for the Japanese market are available. Please contact your local Schaffner vendor for more details.

4 Installation instructions

While EMI filters are a proven measure to ensure compliance of products with EMC requirements, they can only be effective if properly installed. Not only is the filter installation itself of utmost importance, however. The planning and implementation of other EMC measures and design rules also contributes to good performance in terms of noise emission.

Where available, manufacturers should always refer to the installation instructions when installing filters. Further information about installation is also available at www.schaffner.com.

4.1 Installation of filters

The intention of using filters is to prevent unwanted signals from entering a certain electrical area. In order to do so, the filter should be installed as close as possible to that area. The connection between the filter and source circuit should be kept as short as possible.

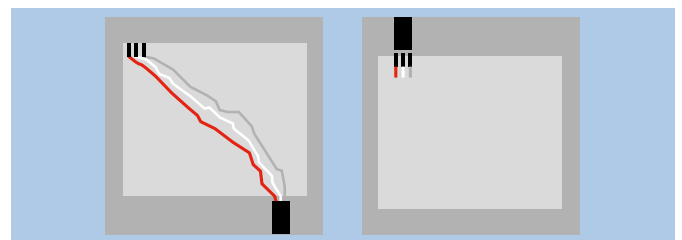

Improper (left) and correct (right) placement of filters

Installations as shown in the left figure above should be avoided whenever possible. Even though the connection between the filter and protected circuit is the shortest possible due to the filter design, the cables from the filter to the printed board take the longest possible way inside the enclosure. They can therefore pick up all signals along the board and radiate them like an antenna, thus working as an unwanted interference source. If the connection is kept short, the interference from the board is eliminated at the source while at the

same time keeping the distance between AC supply and filter short. The filter will show its maximum effect under these circumstances.

Even more important than the filter position is its connection to ground. Proper grounding is essential for the operation of a filter. Without ground connection, the filter is floating and loses its common-mode attenuation provided by the Y-capacitors. One of the most common problems with grounding is the installation of filters by directly attaching them to enclosures with painted or otherwise treated surfaces, in that way interrupting the ground connection and leaving the filter almost useless. To avoid this problem, the part of the surface where the filter will be installed should be abraded.

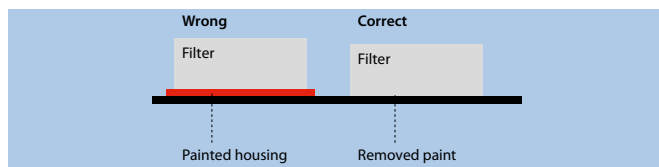

Proper ground connection of filters

Abrasion of enclosures, however, is not always an option. Depending on the ambient conditions, surface treatment might be a requirement to avoid corrosion, and conductive coatings might not be available.

When the ground connection is done, care should be taken to have as big a connection area as possible. It is a common misconception that the conventional PE wire will be sufficient for RF grounding purposes. Instead, flat wires should be preferred over round ones and braided wires over solid ones. The flat wire should be connected plainly on both the filter and the ground connection side in order to ensure proper filtering.

4.2 Cable connection and routing

It is said that in an EMC concept the filter contributes about 50% of the total performance. The remaining 50% is achieved through proper EMC design. Two issues are of special importance in this context: the connection of shielded cables and the cable routing inside of equipment.

4.2.1 Shield connections

Shield connections have already been discussed in a previous chapter. Once again, it is important to connect the shield ends of shielded cables on both sides of the cable with the best possible means. The ideal case would be 360° connections on both sides.

4.2.2 Cable routing

Whenever cables are left longer than necessary or routed close to each other, additional antennas and coupling areas are created. The result is often a short-circuit of the noise suppression components, and the attempt to reduce noise fails not because of the suppression component but because of the cabling.

To improve the situation, cables should be shortened to the necessary length and routed in defined ways. Where cable crossings cannot be avoided, a 90° crossing should be used for maximum decoupling. To avoid an EMI short circuit of the filter, special care should be taken never to cross input and output cables of a filter.

4.3 EMC planning

EMC should always go hand in hand with the general design of the product. From the very beginning, designers should consider which noise sources and susceptible circuits they have in their equipment. This makes it possible to physically separate them and avoid problems right from the start rather than having to fight them later.

Next, the cabling should be considered, keeping in mind the recommendation from the previous chapter. It is much easier to plan the cable layout first rather than having to modify it at a later stage.

Finally, the filtering components should be planned in as well. Filters are not added at the end to get rid of a problem, they are an integral part of the overall EMC design of a product.

A filter should be located as close to the noise source as possible.

When using drive filters, the filter should be placed close to the drive, or in some mechanical designs even under the drive. Mains filters are placed as close to the power inlet as is feasible.

When using filters or reactors, one should always consider the heat dissipation from the filtering component. To avoid overheating, leave sufficient space around the component and ensure air circulation.

Schaffner can support manufacturers with their EMC layout from the early stages of new product ideas or designs. Contact your nearest Schaffner representative for more information.

III Typical applications

1 Choke applications

1.1 Current-compensated chokes (RN, RD and EV/EH series)

These chokes are used to attenuate common-mode or asymmetric (P/N → E) interference signals by being connected in series with the phase and neutral lines of an AC power line input. The magnetic fields produced by this winding technique cancel each other out. Full inductance is only presented to interference signals that flow asymmetrically from phase/neutral to earth.

Symmetrical components of the noise are also attenuated by the leakage inductance of the windings. The impedance of the choke at power line frequencies is therefore negligible, resulting in practically zero voltage drop. Current-compensated chokes are used with multiple windings to avoid saturation (loss of effective inductance). An efficient inductor-capacitor combination to protect against line-conducted interference consists of:

- Series inductances in the interference paths
- Cx capacitors between phase and neutral
- Cy capacitors between phases and earth

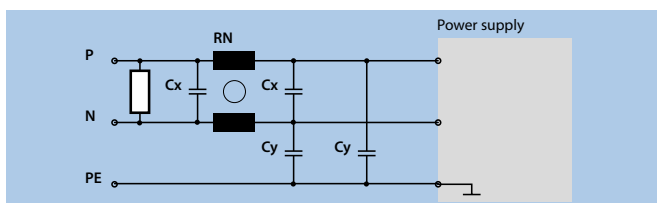

Basic power line filter to remove common and differential-mode noise, based on a current-compensated choke

- In phase-angle control circuits where the desired degree of suppression cannot be achieved by saturating chokes alone
- For suppressing high interference levels from ultrasonic generators, fast rectifiers, switched mains equipment etc.
- For suppressing equipment with no earth connection
- For input filters to protect digital circuitry from mains-borne interference

1.2 Saturating chokes (RI types)

These chokes change impedance at the moment of switching and can be used to attenuate differential-mode or symmetrical (P → N) interference as generated by phase angle control devices such as thyristors and triacs. Interference levels can be brought within the limits of national and international regulations by using these chokes in conjunction with appropriate suppression capacitors. For optimum attenuation, chokes must be connected as close as possible to the semiconductor switching device. A simple single-stage suppression circuit is shown in the following illustration; this can be made into a dual-stage filter by the load itself and one additional capacitor.

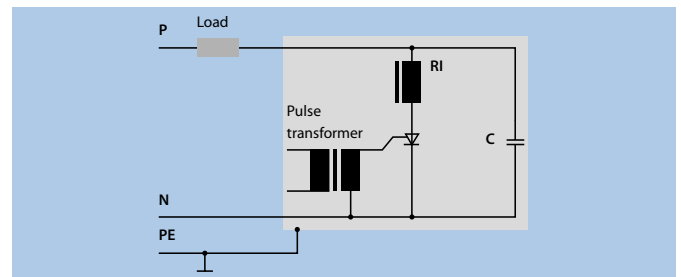

Saturating chokes in series with thyristors

2 Power supply applications

The number of switch-mode power supplies (SMPSs) in electrical and electronic equipment is steadily increasing. They are used not only in traditional applications, such as computers, but also in a growing number of consumer products. At the same time the switching speed of the power supplies is becoming faster, in order to minimize the volume of magnetic devices for the PFC and transformer and to reduce the overall size of the power supply.

While the operational advantages of SMPSs are unquestionable, the negative impacts are becoming increasingly obvious. On the one hand there is an increase in the harmonic distortion of the power networks, which has already resulted in new versions of the relevant standard IEC 61000-3-2. Single-phase harmonic distortion can be eliminated by using front-end power factor correction technologies or harmonic chokes. On the other hand the noise emission due to the high switching frequency is becoming harder to control. Schaffner EMC single-phase filters or IEC inlet filters are designed to minimize EMC emissions from switch-mode power supplies.

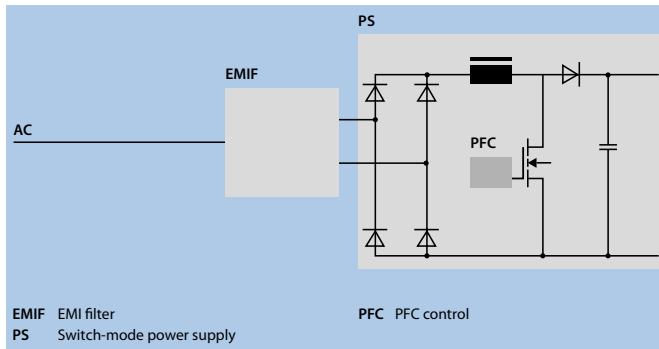

Single-phase power line filter with SMPS to remove common and differential-mode noise

Linear power supplies do not generate EMC noise in the same way as switch-mode power supplies. The majority of EMC noise in a system with a linear power supply is a result of the load behavior and, nowadays, the driving digital logic. Single-phase EMC filters or IEC inlet filters help to reduce the EMC emissions to an acceptable level. Additionally the system immunity will be increased to protect against EMC noise from the grid.

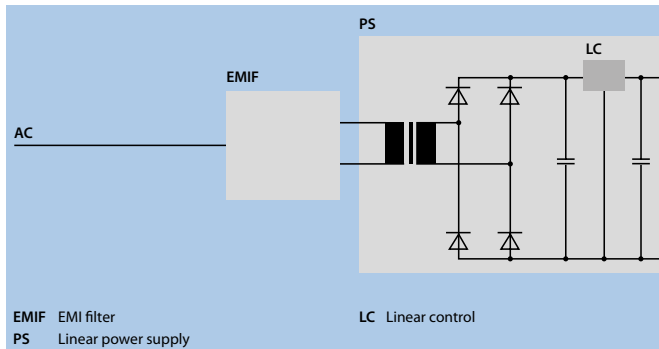

Typical linear power supply application with EMC line filter

2.1 Single-phase filters

These are the key element in eliminating system-generated and mains-borne interference. One of the biggest advantages of using a single-phase filter is the rapid availability of the associated safety approvals.

Single-phase filters are used in a wide range of applications, such as control panels, systems, equipment and apparatus, together with power supplies or other electrical functions.

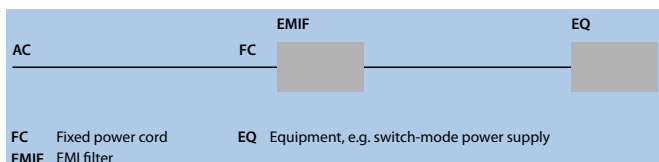

Schaffner single-phase filter FN 2030

2.2 IEC inlet filters

IEC inlet filters with a standard IEC connector are a practical solution when you need to meet the requirements of different country-specific mains plugs. The EMC filter function protects your system and suppresses EMI noise while the IEC connector allows you to equip your system with a standard connector to fit country-specific mains cords. The compact dimensions and supplementary options, such as a mains switch, fuse holder or voltage selector, offer numerous advantages to the user. IEC inlet filters are used in a broad variety of applications, typically in conjunction with a power supply. IEC inlet filters with an integrated voltage selector allow country-specific voltages to be selected in linear power supply designs.

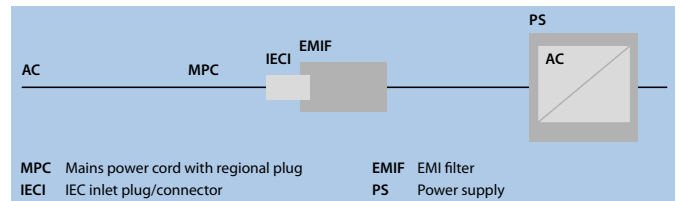

IEC inlets can be used in test and measurement equipment, medical equipment, consumer goods, power supplies and in various other electrical and electronic applications.



Schaffner IEC inlet filter FN 280 with fuses and switch

3 Medical applications

Medical applications sometimes require special EMI filters. Depending on the environment and the use to which the medical equipment is put, the EMC filter may vary significantly from a standard product. Medical electrical equipment or in-vitro diagnostic medical devices have different requirements for leakage current, air and creepage clearances and test voltage, amongst other things. For medical devices with higher safety levels, in accordance with IEC/EN

60601-1, Schaffner offers medical grade versions (B type) of many of its filters, with a lower leakage current, increased air and creepage clearance, discharge resistor and higher test voltage. These filters are available as single-phase or IEC inlet filters, as well as for special three-phase applications.

4 Test and measurement equipment

Test and measurement equipment involves a wide variety of applications. These range from the filter requirements for a power supply through to systems which include power supplies, motors, drives, valves etc. Depending on the requirements, you can select the most appropriate filter from a broad range of single-phase and three-phase filter products.

5 Motor drive applications

A power drive system acts as a converter of electrical energy into mechanical energy. The inverter within the system is commonly used because of its simplicity. However, inverters are well known EMI sources in many industrial applications as well as an increasing number of consumer products.

The power frequency of the supply network is normally 50 Hz or 60 Hz. The inverter can actually vary the speed of the output frequency from 0 Hz to several 100 Hz or >1 kHz, depending on the application.

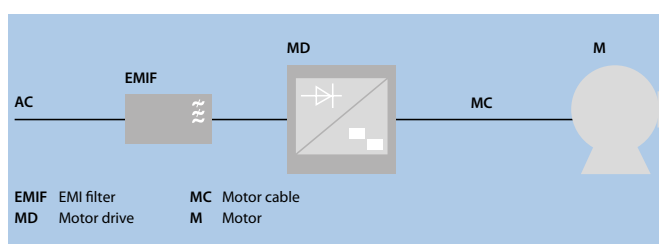

Example of a power drive system

The supply voltage is rectified in the converter section. This section consists of a set of diodes, usually six for a three-phase bridge and four for a single-phase bridge. The DC link consists of a DC capacitor, which stores the rectified energy and releases this energy into the power switching stage. This stage is usually a bank of six transistors. In the example below, the power transistors consist of Insulated Gate Bipolar Transistors (IGBT). The fast-power semiconductors chop the DC voltage into a square wave voltage at the carrier frequency. Control circuits regulate the square wave pause/pulse ratio and generate a three-phase voltage with adjustable power frequency to vary the motor speed. This control mechanism is called Pulse Width Modulation (PWM).

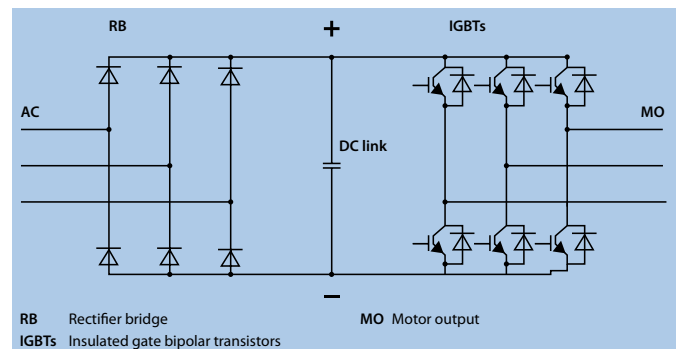

Rectifier bridge in a frequency converter

This high frequency switching will cause EMI. Noise from the output motor cable as well as from control and supply cables couples into adjacent cables and systems. Parasitic capacitance to the ground plane enables the noise to exit the installation and get onto the mains distribution network as common-mode noise. The longer the cable, the greater the capacitance to ground and the bigger the common-mode noise currents that will flow.

Schaffner's vast experience in the area of motor drives enables us to provide you with EMC and power quality solutions for both the input and output sides of inverters.

6 Energy regeneration

Today, modern frequency inverters for motor speed control are an integral part of both industrial and residential applications. In regular operation, the motor acts as the consumer of the provided electrical energy. Sometimes, the same motor is also working as a generator; this phenomenon occurs during the braking process of the motor and is known as the regeneration of electrical power. Traditional inverters are not able to use this regenerated energy. Therefore, more and more drive manufacturers equip their inverters with regeneration units in order to utilize this "free" energy for further use.

Energy regeneration inverter systems offer numerous advantages over traditional drives, such as:

- Delivery of generated energy back to the mains power lines for further use
- No problems with unwanted heat dissipation from brake resistors
- No waste of precious energy
- No bulky external brake resistor required
- Higher dynamic characteristics of the system

Unfortunately, this innovative technology also gives rise to a considerable number of problems. First of all, in a motor drive system

with an energy regeneration unit, all the problems known from traditional motor drive applications also occur (EMI, harmonics, dv/dt , overvoltages, magnetic losses in the motor, motor bearing damage, etc.).

As there is a second converter deployed, electromagnetic compatibility (EMC) also becomes even more critical; today, dedicated draft standards for ER systems already apply.

Furthermore, the energy is being returned to the mains by means of a second converter, which operates in the direction of the mains power lines. The ER converter is conducting the regenerated power via a pulse width-modulated signal toward the net. This mode of operation is extremely critical, as the 50 Hz sine wave of the mains power lines and a pulsed regenerative voltage at approximately 1 to 4 kHz cannot tolerate each other very well. The commutation from the regenerative converter even causes short circuits between the phases towards the public power grid.

In other words, without a proper solution like those suggested by Schaffner, the operation of ER systems is not guaranteed at all. In order to ensure the function and avoid significant interference effects towards the public network, the returning signal needs to be smoothed and adjusted to the power line requirements by means of additional line-conditioning measures. Compliance, reliability and proper function are prime objectives.

Traditional and ER drive philosophies are very different. The installation and solution of the aforementioned problems have to be just as different. The following block schematic diagram shows the most common interference suppression measure deployed in traditional drive units today.

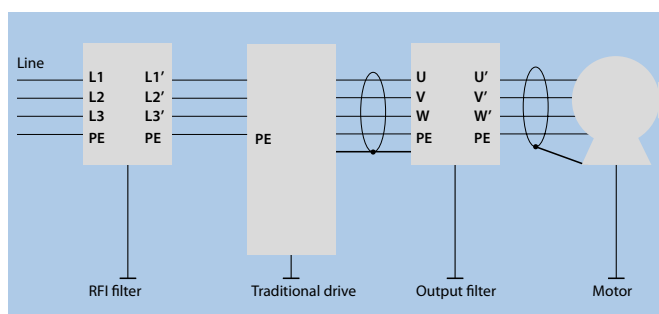

RFI filter solution for traditional drives

A regenerative drive system requires additional measures: First of all, a traditional RFI filter may not be sufficient to meet the dedicated standards and legislation. It's also necessary to consider that the filter must provide full interference attenuation performance in both

directions, no matter which operation is active. This creates much tougher requirements for the filter.

Furthermore, ER drives require a special line impedance that cannot quite be compared to a traditional line reactor. Without this line impedance, the ER converter will start producing short circuits between the phases as soon as the system changes into regeneration mode. These short circuits are caused by the IGBT switches (commutation) of the regenerative drive unit.

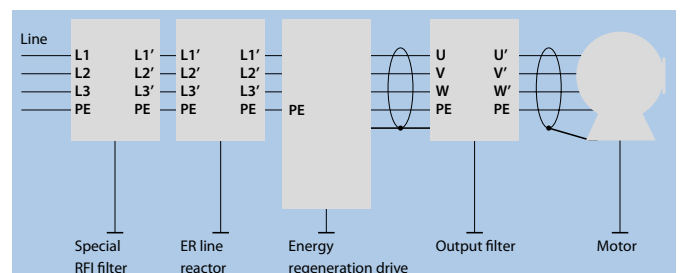

Installation of additional measures for ER drives

The configuration shown in the figure above deploys large smoothing capacitors directly on the mains power lines. If one of the following phenomena occurs, the operation of an additional line reactor is suggested for the line side of the RFI filter.

- Amplification of harmonics
- Self-excitation of machines or equipment
- Overvoltages caused by switching
- Unsatisfactory function of audio frequency ripple control relays

The following parameters have a key influence on the design of the ER solution:

- Kind of modulation and the modulation factor of the drive
- Regeneration switching frequency
- Impedances of the drive
- Cable length
- Special drive peculiarities (circuits to increase the DC link voltage, etc.)

With so many uncertain influences, it does not make much sense to provide a standardized range of filter solutions. The recommendation instead is to find the best solution for a particular ER application by looking directly at the relevant drive and the equipment that incorporates it. With many years of experience in the motor drive sector, Schaffner is the ideal partner for the development and production of fit-and-forget, ER-capable filter and line impedance solutions.

7 Renewable energies

Renewable energy sources like solar power stations or wind parks are becoming increasingly popular. While the means of power generation differs significantly among the natural sources, the conversion process is very similar. We will therefore explain the relation between the application and the solutions by using solar power generation as an example.

Functional model for photovoltaic applications. Through photovoltaic technology, the sun's radiation can be directly converted into electrical energy. The solar cells of a photovoltaic plant generally consist of two layers – a positively conducting and a negatively conducting layer. As soon as light falls on the cell, a voltage is generated. A connected inverter converts the DC voltage that has been so generated into AC voltage and feeds it to the public network.

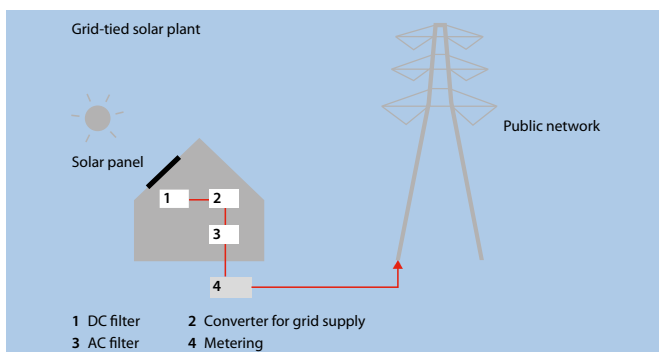

General principle of photovoltaic energy generation

Functional principle of solar inverters. As described above, a solar inverter is used for converting the DC voltage into AC voltage. This involves the present-day modules with complete digital control and high efficiency. For better understanding, the solar inverter can be compared, in the broadest sense, with a regenerating frequency converter for motor control (ER motor drive).

Basically, a distinction is made between two kinds of solar inverters: inverters without transformers and solar inverters with integrated isolation transformers. Although the latter design has clear advantages with regard to the functioning and reliability of the solar module, it is not considered at present because of the additional losses, the greater weight and the size.

In the case of the solar inverter without a transformer, the DC voltage is supported by capacitors and then converted into a 50 Hz three-phase voltage by means of a self-commutated converter bridge (such as IGBTs), which is then supplied to the mains power network. What is involved here is not a pure sinusoidal form but a pulsed signal (such as PWM) with a high harmonic content and interference potential.

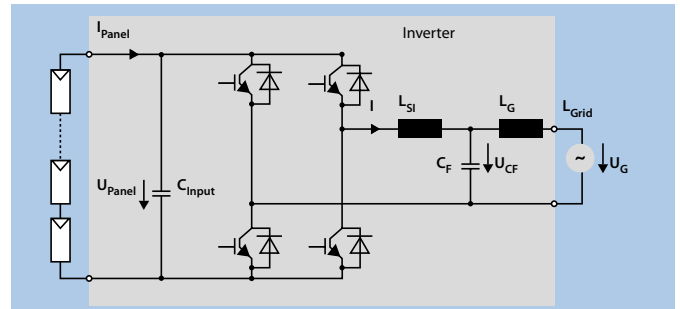

Principle circuit diagram: single-phase solar inverter (without transformer) with grid connection

Occurrence of interferences when using solar inverters. As is already known from motor drive technology, every kind of inverter gives enough cause for the use of interference suppression components. This is no different in the case of the solar inverter. The fast switching processes that occur when the DC voltage is chopped generate a broadband interference spectrum. The unfiltered connection of the solar inverter to the public supply network would thus be a contravention of the EMC Directive.

However, conducted and radiated interferences occur not only in the direction of the network but also in the direction of the solar module and can adversely affect it in function and efficiency. Whereas the conducted interferences are mostly decoupled in the case of the solar inverter with a transformer, there is a clear need for additional interference suppression components on the DC side in the solar inverter without a transformer.

Because of the steep switching edges, the non-sinusoidal, pulsed AC voltage signal at the inverter output also has a considerable harmonic content that is generally well above the permissible limiting values of international standardization (EN 61000-3-2; IEEE 519).

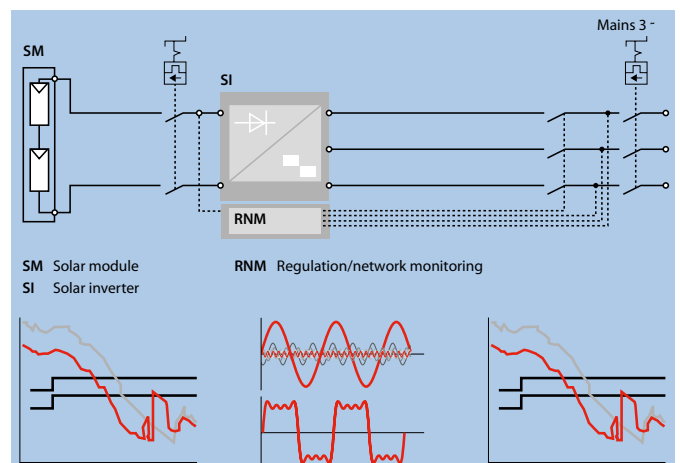

Typical block circuit diagram of a grid-tied solar plant with interferences occurring

Apart from the standardization, the operation of a large number of such plants would pollute and distort the public power network in such a way that reliable operation of grid-tied loads would become impossible.

There is, therefore, a clear need for action. The responsibility for suppressing all the impermissible interferences lies with manufacturers, who must declare their plants safe, reliable and compliant to their customers and government.

To solve the problems shown in the previous chapters, different products are required that fit the application exactly and need to work together synergistically. The block schematic diagram below will provide a first overview.

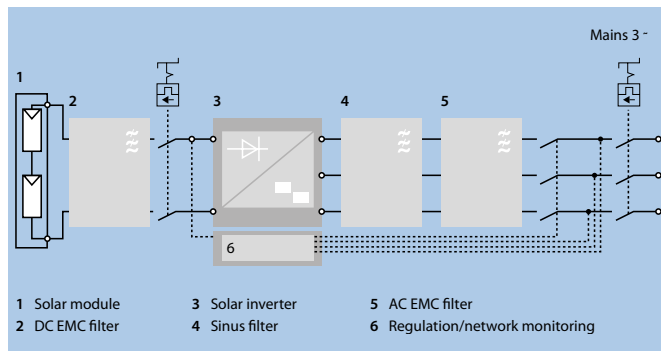

Typical block circuit diagram of a grid-tied solar plant with interference suppression components

DC EMC filter. The DC EMC filter decouples the solar module and mainly takes care of the suppression of high-frequency, conducted interferences from the inverter. These can have a negative effect on the function, reliability and efficiency of the solar cells and must therefore be kept away from the module. In some applications, an overvoltage protection is installed in addition to the EMC filter; it can, in principle, also be integrated into the filter. The DC filter distinguishes itself primarily by a high admissible nominal operating voltage up to 1000 VDC.

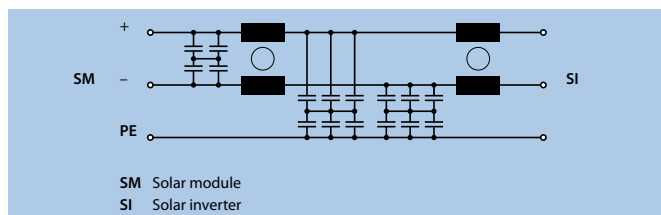

Schematic of a typical DC EMC filter for solar applications

Sinusoidal filter (or LCL filter). A three-phase pulsed AC voltage can be measured at the output of the inverter bridge. As already

mentioned in the previous chapters, a pulsed signal cannot just be connected to any public low-voltage network as it is. The LC sinusoidal filter or the LCL filter comes into use here. Its main task is to smoothen the pulsed output signal in order to supply power to the network that is as low in harmonics as possible. The LC or LCL filter can be understood as a network decoupling in the broadest meaning of the term, with the help of which the inverter and hence the entire solar plant becomes network-compatible.

Depending on the customer's wishes, Schaffner can supply the complete LC/LCL filter or just the output reactor.

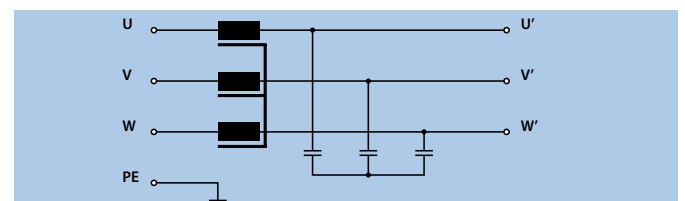

Schematic of a typical sinusoidal filter for solar applications

AC EMC filter. The high-frequency, conducted interferences can also be measured at the mains input and, to fulfill the EMC Directive, must be reduced below the limiting values. Here, for example, an FN 3359 standard filter can be used, which has proven itself in recent years in numerous applications.



FN 3359-1000-99 with protective covers

8 NEMP applications

A nuclear electromagnetic pulse (NEMP) is a high intensity, short duration, electromagnetic field produced as a result of a nuclear explosion outside the atmosphere (exo-atmospheric). The most critical threat for technically highly developed nations is an exo-atmospheric burst (at an altitude of more than 40km) producing a NEMP which causes such high voltages and currents in antennas, power transmission networks etc. that it may leave an entire continent without power, telephone or radio communications. Electronic equipment can be protected against a NEMP if it is placed in a special room or housing which screens it from the electromagnetic fields and if all the feed lines to these areas are protected with voltage limiting devices, such as varistors, gas discharge tubes and suppressor diodes. The Schaffner FN 700Z filter series is designed for NEMP protection. Other suitable filters are available on request.

9 TEMPEST applications

Telecommunication or data processing equipment can transmit signals or distribute them along power lines, providing a mechanism for unauthorized people to access classified information. The study and blocking of such sensitive signals is known as TEMPEST. Mains filters with high attenuation over a large frequency range are necessary. The best possible filter solution can only be identified by specifying the requirements precisely. The FN 700Z filter series has been used in many TEMPEST applications. Other suitable filters are available on request.

10 Communication equipment

Communication equipment requires clean battery power. Special telecommunication base stations transmitting high frequency signals must be protected using feedthrough capacitors or filters. High frequency noise can be absorbed by the battery cable and may harm the system. Feedthrough capacitors or filters shield the system and short high frequency noise to ground.

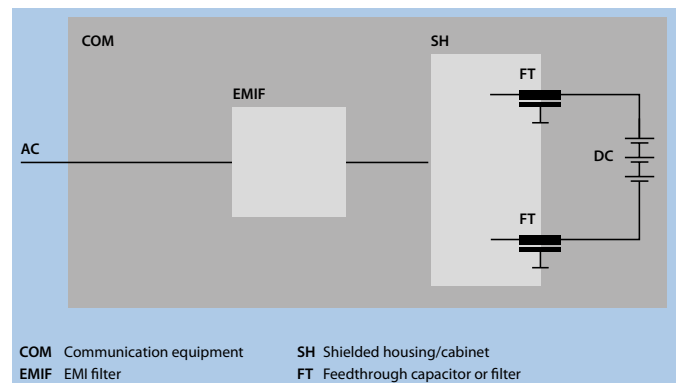

11 Shielded rooms

These rooms are often interference-suppressed using feedthrough capacitors or filters. Typical applications are rooms with sensitive equipment or with upgraded EMI requirements for medical equipment, such as computer tomography or magnetic resonance tomography.

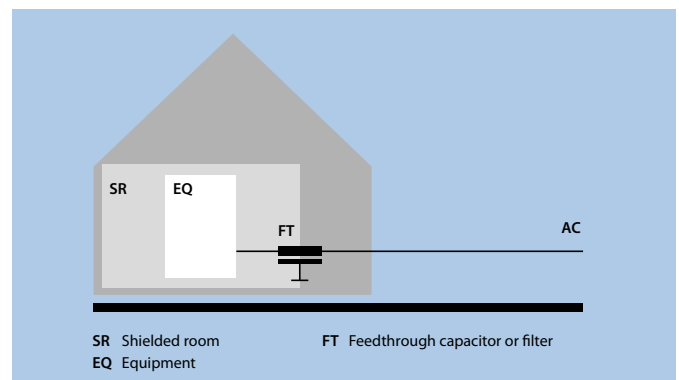

Feedthrough capacitors and filters also improve the security of communications and prevent information in higher frequency signals from leaving the room via the mains or power line.

Schaffner offers a wide selection of different feedthrough capacitors and feedthrough filters for AC and DC applications.



IV Abbreviations

AE	Auxiliary equipment
AMN	Artificial mains network
AV	Average
CDN	Coupling/decoupling network
CE	Communauté Européenne
CISPR	Comité International Spécial des Perturbations Radioélectriques
EMC	Electromagnetic compatibility
ER	Energy regeneration
ESD	Electrostatic discharges
EUT	Equipment under test
FCC	Federal Communications Commission
GHz	Gigahertz = 1 billion cycles per second
GRP	Ground reference plane
HCP	Horizontal coupling plane
HF	High frequency
HVAC	Heating, ventilation, air conditioning
Hz	Hertz = cycles per second
ISN	Impedance stabilization network
kHz	Kilohertz = 1000 cycles per second
LF	Low frequency
LISN	Line impedance stabilization network
MHz	Megahertz = 1 million cycles per second
MTBF	Mean time between failures
NEMP	Nuclear electromagnetic pulse
NSA	Normalized site attenuation
PQ	Power quality
PRF	Pulse repetition frequency
PWM	Pulse width modulation
QP	Quasi-peak
R&TTE	Radio and telecommunication terminal equipment
RF	Radio frequency
SMPS	Switch-mode power supply
TEMPEST	Transient electromagnetic pulse emanation standard
THID	Total harmonic current distortion
THVD	Total harmonic voltage distortion
TDD	Total demand distortion
VCCI	Voluntary Control Council for Interference by Information Technology Equipment and Electronic Office Machines
VCP	Vertical coupling plane
VSD	Variable speed drive

**Headquarters, global innovation
and development center**

Schaffner Group
Nordstrasse 11
4542 Luterbach
Switzerland
T +41 32 681 66 26
F +41 32 681 66 30
info@schaffner.com
www.schaffner.com

To find your local partner within
Schaffner's global network, please go to
www.schaffner.com

© 2013 Schaffner Group
Specifications are subject to change
within notice. The latest version of the
data sheets can be obtained from the
website. All trademarks recognized.

Schaffner is an ISO-registered company.
Its products are designed and
manufactured under the strict quality
and environmental requirements of
the ISO 9001 and ISO 14001 standards.

This document has been carefully
checked. However, Schaffner does not
assume any liability for errors or
inaccuracies.

Sales and application centers

China
Schaffner EMC Ltd. Shanghai
T20-3, No 565 Chuangye Road
Pudong New Area
Shanghai 201201
T +86 21 3813 9500
F +86 21 3813 9501 / 02
cschina@schaffner.com
www.schaffner.com

Finland
Schaffner Oy
Sauvonrinne 19 H
08500 Lohja
T +358 19 35 72 71
F +358 19 32 66 10
finlandsales@schaffner.com

France
Schaffner EMC S.A.S.
112, Quai de Bezons
95103 Argenteuil
T +33 1 34 34 30 60
F +33 1 39 47 02 28
francesales@schaffner.com

Germany
Schaffner Deutschland GmbH
Schoemperlenstrasse 12B
76185 Karlsruhe
T +49 721 56910
F +49 721 569110
germanysales@schaffner.com

Italy
Schaffner EMC S.r.l.
Via Galileo Galilei, 47
20092 Cinisello Balsamo (MI)
T +39 02 66 04 30 45/47
F +39 02 61 23 943
italysales@schaffner.com

Japan
Schaffner EMC K.K.
Mitsui-Seimei Sangenjaya Bldg. 7F
1-32-12, Kamiyuma, Setagaya-ku
Tokyo 154-0011
T +81 3 5712 3650
F +81 3 5712 3651
japansales@schaffner.com
www.schaffner.jp

Singapore
Schaffner EMC Pte Ltd.
Blk 3015A Ubi Road 1
05-09 Kampong Ubi Industrial Estate
T +65 6377 3283
F +65 6377 3281
singaporesales@schaffner.com

Spain
Schaffner EMC España
Calle Caléndula 93
Miniparc III, Edificio E
El Soto de la Moraleja
Alcobendas
28109 Madrid
T +34 618 176 133
spainsales@schaffner.com

Sweden
Schaffner EMC AB
Turebergstorg 1, 6
19147 Sollentuna
T +46 8 5792 1121 / 22
F +46 8 92 96 90
swedensales@schaffner.com

Switzerland
Schaffner EMV AG
Nordstrasse 11
4542 Luterbach
T +41 32 681 66 26
F +41 32 681 66 41
sales@schaffner.ch

Taiwan
Schaffner EMV Ltd.
6th Floor, No 413
Rui Guang Road
Neihu District
Taipei City 114
T +886 2 87525050
F +886 2 87518086
taiwansales@schaffner.com

Thailand
Schaffner EMC Co. Ltd.
Northern Region Industrial Estate
67 Moo 4 Tambon Ban Klang
Amphur Muang P.O. Box 14
Lamphun 51000
T +66 53 58 11 04
F +66 53 58 10 19
thailandsales@schaffner.com

UK
Schaffner Ltd.
5 Ashville Way
Molly Millars Lane
Wokingham
Berkshire RG41 2PL
T +44 118 9770070
F +44 118 9792969
uksales@schaffner.com
www.schaffner.uk.com

USA
Schaffner EMC Inc.
52 Mayfield Avenue
Edison, New Jersey 08837
T +1 732 225 9533
F +1 732 225 4789
usasales@schaffner.com
www.schaffner.com/us