

32a - Axle Nut Catalog



**SPITZ HEAVY DUTY
PITTSBURGH TRUCK PARTS
CASTLE TRUCK PARTS**





























heavydutyusa.com
Qbrand.com

December 17, 2015

[Printer Version](#)



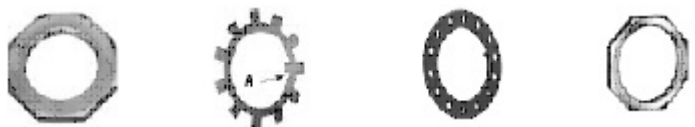









Counter Sales (724) 382-5887
National Accounts 1-800-525-0988

TRAILER AXLE NUTS						
EATON, MERITOR, SPICER & STD. FORGE 13,000 & 14,000 LB. AXLES Thread Size 1-1/4" -12						
INNER & OUTER NUT LOCK WASHER THRUST WASHER	R000618 R000617 R000619					
FRUEHAUF "PRO-PAR" AXLE / MERITOR EARLY MODEL TP AXLE Thread Size 3-1/2" -12 EATON EST230-P, EST 225-P, P-22 / HENDRICKSON HP / INGERSOLL F24H						
SPINDLE NUT LOCK WASHER COTTER PIN STEMCO Pro-Torq Nut	SIR5401* SIR5402 NA 447-4723					
MERITOR RL, RN, RQ, TK, TKL, TKN AXLES - "POSITIVE" ADJUSTMENT Thread Size 2-3/8" -16						
POS. ADJ. INNER NUT TAB LOCK LOCK WASHER OUTER NUT REPLACEMENT SERVICE NUT To convert to manual adj.	1227B678 R003010 R001252* R001251 R002128					
MERITOR TN, TQ AXLES - "MANUAL" ADJUSTMENT Thread Size 2-5/8" -16						
INNER NUT LOCK WASHER *includes set screw OUTER NUT STEMCO Pro-Torq Nut	B5210* SIR5300S* B5200* 447-4743					
MERITOR TN, TQ AXLES - "POSITIVE" ADJUSTMENT Thread Size 2-3/8" -16						
POS. ADJ. INNER NUT LOCK WASHER OUTER NUT REPLACEMENT SERVICE NUT To convert to manual adj.	127B678 A1229X2546 R001251 R002128					
MERITOR TP AXLES - "MANUAL" ADJUSTMENT Thread Size 3-1/2" -12						





INNER NUT LOCK WASHER *includes set screw OUTER NUT STEMCO Pro-Torq Nut	R007664* R007665* R007666* 447-4723	
MERITOR TP AXLES - "POSITIVE" ADJUSTMENT		Thread Size 3-1/4" -12
POS. ADJ. INNER NUT LOCK WASHER OUTER NUT REPLACEMENT SERVICE NUT REPLACEMENT WASHER To convert to manual adj. TAB LOCK STEMCO Pro-Torq Nut	1227R1240 1229Y3119 B2305* SIR2303 1229Y3119 SIR2302 449-4973	<div style="display: flex; justify-content: space-around;"> <div style="text-align: center;"> <p>INNER NUT</p>  </div> <div style="text-align: center;"> <p>LOCK WASHER</p>  </div> <div style="text-align: center;"> <p>OUTER NUT</p>  </div> <div style="text-align: center;"> <p>REPLACEMENT SERVICE NUT AND WASHER</p>  </div> </div> <div style="text-align: center; margin-top: 20px;">  </div>
MERITOR TR AXLE		Thread Size 3-1/4" -12
TAB LOCK INNER NUT LOCK WASHER OUTER NUT STEMCO Pro-Torq Nut	SIR2302 SIR2303* 1229Y3119 B2305* 449-4973	
MERITOR RL,RQ,TK,TKL,TKLD,TLTLD,TND,TQC,TQD DANA SPICER D-20,D-21,D-22,DD-21,DD-22,K-21,K-22,K-25,K-30 EATON C,C2,CD,CD2,CE,ESA-225J,EST,EST-225J,EST230J,ETA230C,ETA225D,ETA225J,H23L,H25R, HCE,HJ,HJE,J,JE,JH,LA-15,T-18C,20L-77,22L,22R,23L,23R,25R HENDRICKSON HN, INGERSOLL A22T, STD. FORGE A25, A26 & 17,000/18,000 LB. AXLES		Thread Size 2-5/8" -16
INNER NUT TAB LOCK WASHER LOCK WASHER OUTER NUT STEMCO Pro-Torq Nut	B5210* B5660 B5300* B5200* 447-4743	
MERITOR T-1100, EATON X-115, SPICER DANA D10, STD. FORGE T 8.5-S 11,000 LB. AXLES FRUEHAUF MODEL 5, TKF		Thread Size 1-1/2" -12
INNER & OUTER NUT LOCK WASHER THRUST WASHER STEMCO Pro-Torq Nut	R001087 R001000 R001001 448-4836	





STEERING AXLE SPINDLE NUTS

FORD 6,000 FRONT AXLE EATON EFA-12F4,EFA-13F5,E1200I, FE931, 12K, 13.2K		Thread Size 1-1/2" -18
SPINDLE NUTS THRUST WASHER STEMCO Pro-Torq Nut	R004861 R004869 448-4837	
EATON/DANA 10,12,13,14,000# AXLE		Thread Size 1-1/2" -18



INNER NUT LOCK WASHER LOCK OUTER NUT STEMCO Pro-Torq Nut	SIR3568 SIR3571 SIR3570 SIR3569 448-4837	   
MACK FRONT AXLES		Thread Size 1-5/8" -12
SPINDLE NUTS THRUST WASHER STEMCO Pro-Torq Nut	R003501 R003502 448-4839	 
MACK FRONT AXLES		Thread Size 2" -12
STEMCO Pro-Torq Nut	448-4864	
NAVISTAR 02109 (DANA FA109 9,000LBS. NAVISTAR 02309 (DANA I-90 9,000LBS.		NAVISTAR 02139 (DANA FA139 12,000LBS. NAVISTAR 02329 (DANA I-108 10,800LBS. Thread Size 2-1/16" -16
INNER & OUTER NUT LOCK WASHER THRUST 3-3/4" O.D. THRUST 4-1/8" O.D.	R004855 R004871* R006138 R006139	  
NAVISTAR FA48		Thread Size 7/8" -14
SPINDLE NUT THRUST WASHER	R004850 R004875	 
NAVISTAR FA68, FA72		Thread Size 1" -14
SPINDLE NUT	R004851	



STEERING AXLE SPINDLE NUTS (continued)

NAVISTAR FA70, FA89, FA91, FA98		Thread Size 1-1/8" -12
SPINDLE NUT THRUST WASHER	R004853 R004868	 
NAVISTAR FA71, FA101		Thread Size 1-1/8" -12
SPINDLE NUT LOCK WASHER	R004852 R004870	 
MERITOR FD-900, FD-901, FR00900, FF-901, FF-931 AXLES		Thread Size 1-1/2" -12





INNER NUT LOCK WASHER WASHER OUTER NUT STEMCO Pro-Torq Nut	SIR2299 SIR2297* SIR2298* SIR2296* 448-4836	
MERITOR FR00970 & E SERIES DRIVE AXLES		Thread Size 2-1/4"-16
NUT LOCK RING THRUST WASHER	R002300* R002301* R002302	
MERITOR FG-900 AXLES		Thread Size 1-3/4"-12
INNER NUT INNER NUT (16,000 LB) LOCK WASHER OUTER WASHER OUTER NUT	R003510 R002661* R002660* R002659* R002658*	
MERITOR FH-901, FL-901, FL-931 AXLES		Thread Size 1-3/4"-12
SPINDLE NUT THRUST WASHER STEMCO Pro-Torq Nut	KIT1416 R002663 448-4865	



DRIVE AXLE SPINDLE NUTS

CHEVY/GMC H150		
SPINDLE NUT LOCK WASHER	R004856 R004873	
CHEVY/GMC T150, T170		
SPINDLE NUT LOCK WASHER	R004858 R004876	
EATON 32M-MR, 34M, MF, 34D-DT-RT, 17800-17801 AXLES		
INNER NUT 3-7/16" INNER NUT 4-1/8" LOCK WASHER 4" O.D. LOCK WASHER 4-3/4" OUTER NUT 3-3/8" STEMCO Pro-Torq Nut OUTER NUT 4-1/16" STEMCO Pro-Torq Nut	R002462* R002468* R002461* R002467* R002460 <u>447-4743</u> NA <u>449-4973</u>	Thread Size 2-5/8"-12 Thread Size 3-1/4"-12 
EATON 38R3, RP-RT, 42R3-RP-RT, 18800, 18801-02-03 AXLES		Thread Size 3"-12

INNER NUT LOCK WASHER OUTER NUT	R002465 R002464* R002463	
FORD 15,000 LB. REAR AXLE		Thread Size 2"-16
INNER NUT LOCK WASHER OUTER NUT	R004862 R004878 R004863	
FORD 17,500 LB. AXLE		Thread Size 2-1/2"-16
SPINDLE NUT	R004864	

DRIVE AXLE SPINDLE NUTS (continued)

FORD 18,000 LB. AXLE		Thread Size 2-5/8"-12
INNER NUT LOCK WASHER LOCK WASHER OUTER NUT STEMCO Pro-Torq Nut	R006142* B5300* R002461* R002462* 449-4974	
MACK 50,000 AXLE		Thread Size 3-1/4"-12
TAB LOCK INNER NUT LOCK WASHER OUTER NUT STEMCO Pro-Torq Nut	SIR2302 SIR2303* SIR2304* B2305* 449-4973	
MACK 55,000, 58,000, 65,000 LB. SW-50C, SW-55C, SW-58C, SW-65C, S-50C, S-55C, S-58C, S-65C		Thread Size 3-9/16"-12
INNER NUT LOCK WASHER THRUST WASHER OUTER NUT	R006145 R006146 R006148 R006147	
MACK SW-56, S-34, S-38, S-44, S-462, SW-57, SW-441 AXLE		Thread Size 2-7/8"-12
INNER NUT LOCK WASHER WASHER OUTER NUT STEMCO Pro-Torq Nut	R003504 R003505 R006144 R003506 449-4904	
MACK SW-57C AXLE		Thread Size 2-15/16"-12
INNER NUT LOCK WASHER OUTER NUT	R003507 R003508 R003509	



NAVISTAR 14039 (INTERNATIONAL /DANA F170S) 17,000 LB. NAVISTAR 14042 (INTERNATIONAL /DANA J175S) 17,500 LB. NAVISTAR 14199 (EATON 16244) 17,500 LB. NAVISTAR 14341 (INTERNATIONAL /DANA RA341) 30,000 LB.		Thread Size 2-1/2"-12	
INNER & OUTER NUT LOCK WASHER	R004857 R004881*		

DRIVE AXLE SPINDLE NUTS (continued)

NAVISTAR 14044 (INTERNATIONAL /DANA J190S) 19,000 LB. NAVISTAR 14186 (EATON 17202/22) 19,000 LB. NAVISTAR 14351 (INTERNATIONAL /DANA G340S) 34,000 LB.		Thread Size 2-5/8"-12	
--	--	------------------------------	--

INNER & OUTER NUT LOCK WASHER STEMCO Pro-Torq Nut	R002462* R004877* 449-4974		
--	---	---	--

NAVISTAR 14308 (EATON DS402P) 40,000LB. NAVISTAR 14342,14464 (EATON DT401P) 40,000LB. NAVISTAR 14364 (EATON RS401) 40,000LB. NAVISTAR 14494 (EATON RS381/402) 38,000LB. NAVISTAR 14348 (MERITOR SQHD) 38,000LB. NAVISTAR 14368 (MERITOR STDD) 50,000LB.	NAVISTAR 14309 (EATON RT102) 40,000LB. NAVISTAR 14311 (EATON RS460/461) 46,000 NAVISTAR 14493 (EATON RS341) 34,000LB. NAVISTAR 14277 (MERITOR U240) 29,000LB. NAVISTAR 14338 (MERITOR SRDD) 44,000LB. Thread Size 3-1/4"-12
--	---

INNER & OUTER NUT LOCK WASHER STEMCO Pro-Torq Nut	1227V464 R006141* 449-4973		
--	---	--	--



MERITOR "F" SERIES AXLE **Thread Size 2-1/2"-16**

INNER NUT LOCK WASHER OUTER NUT	R002417* R002418* R002419*			
---------------------------------------	----------------------------------	---	---	---

MERITOR "H" SERIES AXLE **Thread Size 2-5/8"-16**

INNER NUT LOCK WASHER OUTER NUT STEMCO Pro-Torq Nut	R002420 KIT2761* R002422 447-4743			
---	---	---	---	---

MERITOR SPECIAL "H" SERIES AXLE H-145,H-162, H-172, H-240, H-262, H-362, H-350 **Thread Size 2-5/8"-12**

INNER NUT LOCK WASHER OUTER NUT STEMCO Pro-Torq Nut	R006142* KIT2761* R002462* 449-4974			
---	---	---	---	---

MERITOR "L" SERIES AXLE **Thread Size 3"-12**

INNER NUT LOCK WASHER OUTER NUT	R002423 R002424* R002425	
---------------------------------------	--------------------------------	---

DRIVE AXLE SPINDLE NUTS (continued)		
MERITOR "Q", "R" FOR SQHD & R170 AXLES		Thread Size 3-1/4"-12
TAB LOCK INNER NUT LOCK WASHER OUTER NUT STEMCO Pro-Torq Nut	SIR2302 SIR2303* SIR2304* B2305* 449-4973	

ALL PARTS PACKAGED & SOLD 10 PER BOX.

IN = INNER NUT
ON = OUTER NUT
LW = LOCK WASHER
L = LOCK
TAB = TAB LOCK WASHER

SIRCO	EUCLID	MERITOR	MERITOR	BATCO	BWP
SIR2296 ON	E-2296	R002296	1227B106	06-354	M-1956L-1331
SIR2299 IN	E-2299	R002299	127U541	06-358	M-1959L-1334
SIR2297 LW	E-2297	R002297	1229G475	06-355	M-1958L-1333
SIR2298 L	E-2298	R002298	1229F474	06-357	M-1957L-1332
SIR3568 IN	EATON -815622				L-3568
SIR3569 ON	EATON -815638				L-3569
SIR3570 L	EATON -817134				L-3570
SIR3571 LW	EATON -815623				L-3571
B5210 SIR5210 IN	E-540		1227C549	06-203	M-682 L-176
	SPICER 12-391, M10HN101	STD FORGE 103103-002			
B5200 SIR5200 ON	E-572		1227B756	06-201	M-684 L-178
	SPICER 12-393, M10HN102	STD FORGE 103102-001			
B5660 SIR5660 TAB	E-2237	R002237		06-230	M-1068L1327
	SPICER 12-394, M10HN151	STD FORGE 105106			
B5300 SIR5300 LW	E-573	R000537		06-202	M-683 L-177
	SPICER 12-392 M10HN100	STD FORGE 105107			
SIR5300S LW	E-3008		A1229W2545		M-2567L-3213
SIR2303 IN	E-2303	R002303		06-411	M-1980L-1355
	SPICER 12-417				
B2305 SIR2305 ON	E-2305	R002305		06-412	M-1978L-1353
	SPICER 12-418				
SIR2304 LW	E-2304	R002304		06-413	M-1979L-1354
	SPICER 12-418				
SIR2302 TAB	FOR SIR2303, SIR2305, SIR2301 NUTS				
SIR5401 ON	E-2550	R002550		06-226	M-1050L-1395
	FRUEHAUF ACE8510-001, SPICER 12-400				
SIR5402 LW	E-1561	R001561		06-228	M-1051L-893
	FRUEHAUF AXA0408-1 SPICER 12-402				

[447-4723](#) Trailer Axle, Thread Size 3.48" - 12
[447-4743](#) Trailer Axle, Thread Size 2-5/8" - 16
[448-4837](#) Steer Axle, Thread Size 1-1/2" - 18
[448-4864](#) Steer Axle, Thread Size 2" - 12
[449-4973](#) Drive Axle, 3/1/4" - 12

