



Product Catalog

Air-Cooled Series R™ Chillers Model RTAC 140 to 500 nominal tons (60 Hz)





Introduction

Like its chillers, Trane wants its relationships with customers to last. Trane is interested in maintaining long term, loyal relationships. This perspective means the point in time that a customer purchases a chiller is the beginning of a relationship, not the end. Your business is important, but your satisfaction is paramount.

The RTAC offers high reliability coupled with proven Series R performance.

The Series R Model RTAC is an industrial grade design built for both the industrial and commercial markets. It is ideal for schools, hospitals, retailers, office buildings, Internet service providers and manufacturing facilities.

Copyright

This document and the information in it are the property of Trane, and may not be used or reproduced in whole or in part without written permission. Trane reserves the right to revise this publication at any time, and to make changes to its content without obligation to notify any person of such revision or change.

Trademarks

All trademarks referenced in this document are the trademarks of their respective owners.

Revision History

RLC-PRC006M-EN (15 Jan 2015)

The following points describe the changes to this revision on the manual:

- Updated electrical data and customer wiring information
- Rapid Restart Test
- Add seismic isolator option
- Added optional tarp information



Table of Contents

| | |
|----------------------------------|----|
| Introduction | 2 |
| Table of Contents | 3 |
| Features and Benefits | 4 |
| Application Considerations | 7 |
| Model Number Descriptions | 13 |
| General Data | 14 |
| Performance Data | 20 |
| Controls | 30 |
| Electrical Data | 33 |
| Electrical Connection | 56 |
| Dimensions | 64 |
| Weights | 74 |
| Mechanical Specifications | 76 |
| Options | 77 |



Features and Benefits

World Class Energy Efficiency

The importance of energy efficiency cannot be understated. Fortunately, ASHRAE has created a guideline emphasizing its importance. Nonetheless, energy is often dismissed as an operational cost over which the owner has little control. That perception results in missed opportunities for energy efficiency, reduced utility bills, and higher profits. Lower utility bills directly affect profitability. Every dollar saved in energy goes directly to the bottom line. Trane's RTAC is one way to maximize your profits.

ASHRAE Standard 90.1 and Executive Order

All Trane air-cooled chillers meet the new efficiency levels mandated by ASHRAE Standard 90.1. This new standard requires higher efficiencies than past technologies can deliver. The US Federal Government has adopted standard 90.1 and, in some cases, requires even higher efficiencies. Federal Executive Order mandates energy consuming devices procured must be in the top 25% of their class. In the case of chillers, that product standard is ASHRAE 90.1. Trane's RTAC meets and exceeds the efficiency requirements of 90.1, while the high and extra efficiency RTAC can meet the "stretch goals" of Executive Order.

Precise Capacity Control

Trane's patented unloading system allows the compressor to modulate infinitely and exactly match building loads. At the same time chilled water temperatures will be maintained within +/- 1/2°F (0.28°C) of setpoint. Screw or scroll chillers with stepped capacity control do well to maintain chilled water temperatures within 2°F (1.1°C) of setpoint. Stepped control also results in over cooling because rarely does the capacity of the machine match the building load. The result can be 10% higher energy bills. Trane's RTAC optimizes the part load performance of your machine for energy efficiency, precise control for process applications, and your personal comfort regardless of the weather outside.

Excellent Reliability

A buildings environment is expected to be comfortable. When it is, no one says a word. If it's not... that's a different story. The same is true with chillers. No one ever talks about chillers, yet alone compressors, until they fail, and tenants are uncomfortable and productivity is lost. Trane's helical rotary compressors have been designed and built to stay running when you need them.

Fewer moving parts

Trane's helical rotary compressors have only two major rotating parts: the male and female rotor. A reciprocating compressor can have more than 15 times that number of critical parts. Multiples of pistons, valves, crankshafts, and connecting rods in a reciprocating unit all represent different failure paths for the compressor. In fact, reciprocating compressors can easily have a failure rate four times of a helical rotor. Combine that with two to three reciprocating compressors for each helical rotary compressor on chillers of equal tonnage, and statistics tell you it's a matter of time before you lose a reciprocating compressor.

Robust components

Helical rotary compressors are precisely machined using state of the art processes from solid metal bar stock. Tolerances are maintained within a micron or less than a tenth of the diameter of a human hair. The resulting compressor is a robust yet highly sophisticated assembly capable of ingesting liquid refrigerant without risk of damage.

Condenser coils

Trane's condenser coils are manufactured with the same philosophy as the compressors; they're built to last. Even though manufacturing processes have allowed thinner and thinner materials in their assembly, with obvious material and manufacturing savings, Trane's coil material did not change with the RTAC generation of air cooled chillers. Substantial condenser fins, that do not require additional coating in non-corrosive environments, contribute to the highest reliability standards for air-cooled chillers in the industry.

Superior Control

The Adaptive Control™ microprocessor system enhances the air-cooled Series R chiller by providing the very latest chiller control technology. With the Adaptive Control microprocessor, unnecessary service calls and unhappy tenants are avoided. The unit is designed not to trip or unnecessarily shut down. Only when the Tracer™ chiller controllers have exhausted all possible corrective actions and the unit is still violating an operating limit will the chiller shut down. Controls on other equipment typically shut down the chiller, usually just when it is needed the most.

For example: A typical five year old chiller with dirty coils might trip out on high pressure cutout on a 100°F (38°C) day in August. A hot day is just when comfort cooling is needed the most. In contrast, the air-cooled Series R chiller with an Adaptive Control microprocessor will stage fans on, modulate electronic expansion valves, and modulate slide valve positions as the chiller approaches a high pressure cutout, thereby keeping the chiller online when you need it the most.

Simple Installation

- **Factory Installed Flow Switch.** Installed in the optimum location in the piping for reduced chiller installation cost and superior flow sensing, reducing the potential for nuisance trips.
- **Close Spacing Installation.** The air-cooled Series R™ Chiller has the tightest recommended side clearance in the industry, four feet for maximum performance. In situations where equipment must be installed with less clearance than recommended, which frequently occurs in retrofit applications, restricted airflow is common. Conventional chillers may not work at all. However, the air-cooled Series R chiller with Adaptive Control™ microprocessor will make as much chilled water as possible given the actual installed conditions, stay on line during unforeseen abnormal conditions, and optimize the unit performance. Consult your Trane sales engineer for more details.
- **Factory Testing Means Trouble Free Startup.** All air-cooled Series R chillers are given a complete functional test at the factory. This computer based test program completely checks the sensors, wiring, electrical components, microprocessor function, communication capability, expansion valve performance and fans. In addition, each compressor is run and tested to verify capacity and efficiency. Where applicable, each unit is factory preset to the customer's design conditions; an example would be leaving liquid temperature setpoint. The result of this test program is that the chiller arrives at the job site fully tested and ready for operation.
- **Factory Installed and Tested Controls/Options Speed Installation.** All Series R chiller options, including main power supply disconnect, low ambient control, ambient temperature sensor, low ambient lockout, communication interface and ice making controls, are factory installed and tested. Some manufacturers send accessories in pieces to be field installed. With Trane, the customer saves on installation expense and has assurance that ALL chiller controls/options have been tested and will function as intended.

Unit Performance Testing

The AHRI Certification Program has had a certification program covering air-cooled water chillers for many years. With this in mind, customers may ask, "Do I need to factory performance test my chiller?"

Trane began promoting factory performance tests for water-cooled water chillers in 1984 for the same reasons it is valid today for air-cooled water chillers, to show we stand behind the products we design and build.

The benefits of a performance test include verification of performance, prevention of operational problems, and assurance of a smooth startup. Only a performance test conducted in a laboratory or laboratory grade facility will confirm both performance and operation of a specific chiller.

While most factory performance tests go smoothly, should problems occur, Trane personnel can quickly correct them and the chiller will ship as specified. Job site diagnosis, ordering of parts, and waiting for delivery of replacement components is significantly reduced.

A factory performance test reduces startup time, thereby saving job site expense. A chiller that has been tested is operation and performance proven. This allows the installing contractor to concentrate on proper electrical wiring and water piping, and the service technicians to concentrate on proper refrigerant charge, safeties diagnosis and initial logging of the chiller. Means of obtaining full load on the chiller and proving its performance do not have to be determined by engineers or contractors, thus saving time. The certified test report documents performance for the unit as built. In addition, factory testing significantly reduces commissioning time and risk by reintroducing manufacturer responsibility, where its mitigation should reside.

When a factory performance test is requested, the test can be conducted at the specified design conditions for all packaged chillers. The test facility has the capability to control ambient test conditions to assure our customers that our chillers will perform as predicted.

Rapid Restart™ testing is also available to demonstrate the chiller's rapid restart capabilities for disaster relief. While the chiller is operating at customer specified full load conditions, power to the chiller is cut and the customer can witness how quickly the chiller will return to full load.

For more information on test performance testing, see brochure RL-SLB012-EN.





Application Considerations

Important

Certain application constraints should be considered when sizing, selecting and installing Trane air-cooled Series R chillers. Unit and system reliability is often dependent upon proper and complete compliance with these considerations. When the application varies from the guidelines presented, it should be reviewed with your local Trane sales engineer.

Unit Sizing

Unit capacities are listed in the performance data section. Intentionally over sizing a unit to assure adequate capacity is not recommended. Erratic system operation and excessive compressor cycling are often a direct result of an oversized chiller. In addition, an oversized unit is usually more expensive to purchase, install, and operate. If over sizing is desired, consider using multiple units.

Water Treatment

Dirt, scale, products of corrosion and other foreign material will adversely affect heat transfer between the water and system components. Foreign matter in the chilled water system can also increase pressure drop and consequently, reduce water flow. Proper water treatment must be determined locally, depending on the type of system and local water characteristics. Neither salt nor brackish water is recommended for use in Trane air-cooled Series R chillers. Use of either will lead to a shortened life to an indeterminable degree. The Trane Company encourages the employment of a reputable water treatment specialist, familiar with local water conditions, to assist in this determination and in the establishment of a proper water treatment program.

Effect Of Altitude On Capacity

Air-cooled Series R chiller capacities given in the performance data tables are for use at sea level. At elevations substantially above sea level, the decreased air density will reduce condenser capacity and, therefore, unit capacity and efficiency.

Ambient Limitations

Trane air-cooled Series R chillers are designed for year round operation over a range of ambient temperatures. The Model RTAC chiller will operate as standard in ambient temperatures of 25°F to 115°F (-4°C to 46°C). With the low ambient option, these units will operate down to 0°F (-18°C). If an ambient temperature as high as 125°F (51°C) is the basis for design, the high ambient option will permit the chiller to run without going into a limiting condition. For installations in areas with large ambient differences, the wide ambient option will allow the chiller to perform uninhibited from 0°F to 125°F (-18°C to 51°C).

Water Flow Limits

The minimum and maximum water flow rates are given in the General Data tables. Evaporator flow rates below the tabulated values will result in laminar flow causing freeze up problems, scaling, stratification and poor control. Flow rates exceeding those listed may result in excessive tube erosion.

Note: Flow rates in General Data tables are for water only. They do not include glycol.

Leaving Water Temperature Limits

Trane air-cooled Series R chillers have three distinct leaving water categories: standard, low temperature, and ice making. The standard leaving solution temperature range is 40 to 65°F (4.4 to 15.6°C). Low temperature machines produce leaving liquid temperatures less than 40°F (4.4°C). Since liquid supply temperature setpoints less than 40°F (4.4°C) result in suction temperatures at or below the freezing point of water, a glycol solution is required for all low temperature machines. Ice making machines have a leaving liquid temperature range of 20 to 60°F (-6.7 to 15.6°C). Ice making controls include dual setpoint controls and safeties for ice making and standard cooling capabilities. Consult your local Trane sales engineer for applications or selections involving low

Application Considerations

temperature or ice making machines. The maximum water temperature that can be circulated through an evaporator when the unit is not operating is 108°F (42°C).

Flow Rates Out of Range

Many process cooling jobs require flow rates that cannot be met with the minimum and maximum published values for the Model RTAC evaporator. A simple piping change can alleviate this problem. For example: A plastic injection molding process requires 80 gpm (5.1 l/s) of 50°F (10°C) water and returns that water at 60°F (15.6°C). The selected chiller can operate at these temperatures, but has a minimum flow rate of 120 gpm (7.6 l/s). The system layout in Figure A1 can satisfy the process.

Figure 1. Flow rate out of range system layout

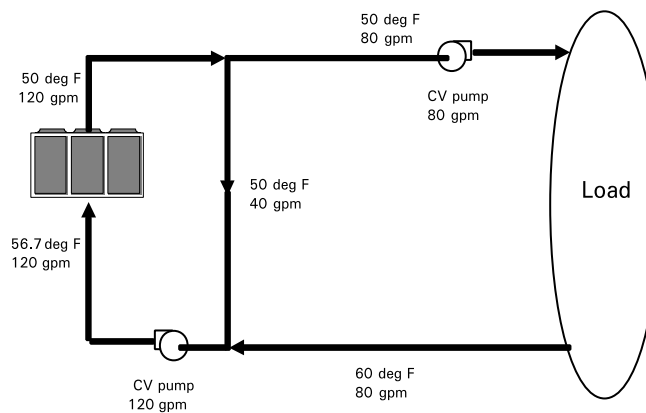

Flow Control

Trane requires the chilled water flow control in conjunction with the Air-Cooled Series R Chiller to be done by the chiller. This will allow the chiller to protect itself in potentially harmful conditions.

Supply Water Temperature Drop

The performance data for the Trane air-cooled Series R chiller is based on a chilled water temperature drop of 10°F (5.6°C). Chilled water temperature drops from 6 to 18°F (3.3 to 10°C) may be used as long as minimum and maximum water temperatures and flow rates are not violated. Temperature drops outside this range are beyond the optimum range for control and may adversely affect the microcomputer's ability to maintain an acceptable supply water temperature range. Further, temperature drops of less than 6°F (3.3°C) may result in inadequate refrigerant superheat. Sufficient superheat is always a primary concern in any refrigerant system and is especially important in a package chiller where the evaporator is closely coupled to the compressor. When temperature drops are less than 6°F (3.3°C), an evaporator runaround loop may be required.

Leaving Water Temperature Out of Range

Many process cooling jobs require temperature ranges that cannot be met with the minimum and maximum published values for the Model RTAC evaporator. A simple piping change can alleviate this problem. For example: A laboratory load requires 120 gpm (7.6 l/s) of water entering the process at 85°F (29.4°C) and returning at 95°F (35°C). The accuracy required is better than the cooling tower can give. The selected chiller has adequate capacity, but a maximum leaving chilled water temperature of 60°F (15.6°C).

In Figure A2, both the chiller and process flow rates are equal. This is not necessary. For example, if the chiller had a higher flow rate, there would simply be more water bypassing and mixing with warm water.

Figure 2. Temperature out of range system layout

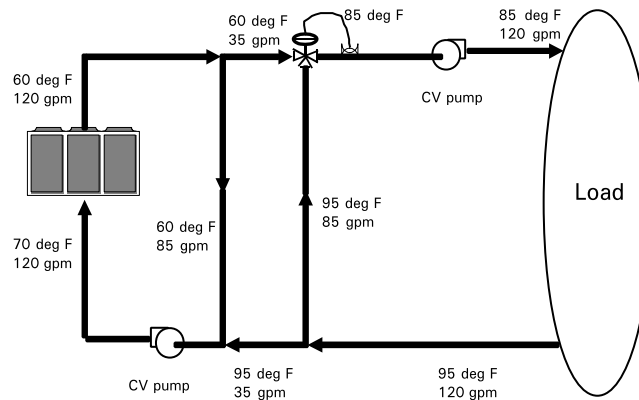

Variable Flow in the Evaporator

An attractive chilled water system option may be a variable primary flow (VPF) system. VPF systems present building owners with several cost saving benefits that are directly related to the pumps. The most obvious cost savings result from eliminating the secondary distribution pump, which in turn avoids the expense incurred with the associated piping connections (material, labor), electrical service, and variable frequency drive. Building owners often cite pump related energy savings as the reason that prompted them to install a VPF system.

The evaporator on the Model RTAC can withstand up to 50 percent water flow reduction as long as this flow is equal to or above the minimum flow rate requirements. The microprocessor and capacity control algorithms are designed to handle a maximum of 10% change in water flow rate per minute in order to maintain $\pm 0.5^\circ\text{F}$ (0.28°C) leaving evaporator temperature control. For applications in which system energy savings is most important and tight temperature control is classified as $\pm 2^\circ\text{F}$ (1.1°C), up to 30 percent changes in flow per minute are possible.

With the help of a software analysis tool such as System Analyzer™, DOE-2 or TRACE™, you can determine whether the anticipated energy savings justify the use of variable primary flow in a particular application. It may also be easier to apply variable primary flow in an existing chilled water plant. Unlike the "decoupled" system design, the bypass can be positioned at various points in the chilled water loop and an additional pump is unnecessary.

Series Chiller Arrangements

Another energy saving strategy is to design the system around chillers arranged in series. The actual savings possible with such strategies depends on the application dynamics and should be researched by consulting your Trane Systems Solutions Representative and applying an analysis tool from the Trace software family. It is possible to operate a pair of chillers more efficiently in a series chiller arrangement than in a parallel arrangement. It is also possible to achieve higher entering to leaving chiller differentials, which may, in turn, provide the opportunity for lower chilled water design temperature, lower design flow, and resulting installation and operational cost savings. The Trane screw compressor also has excellent capabilities for "lift," which affords an opportunity for "lift," which affords an opportunity for savings on the evaporator water loop.

Series chiller arrangements can be controlled in several ways. Figure A3 shows a strategy where each chiller is trying to achieve the system design set point. If the cooling load is less than 50 percent of the systems capabilities, either chiller can fulfill the demand. As system loads increase, the Chiller 2 becomes preferentially loaded as it attempts to meet the leaving chilled water setpoint. Chiller 1 will finish cooling the leaving water from Chiller 2 down to the system design setpoint.

Application Considerations

Staggering the chiller set points is another control technique that works well for preferentially loading Chiller 1. If the cooling load is less than 50 percent of the system capacity, Chiller 1 would be able to satisfy the entire call for cooling. As system loads increase, Chiller 2 is started to meet any portion of the load that Chiller 1 can not meet.

Figure 3. Typical series chiller arrangement

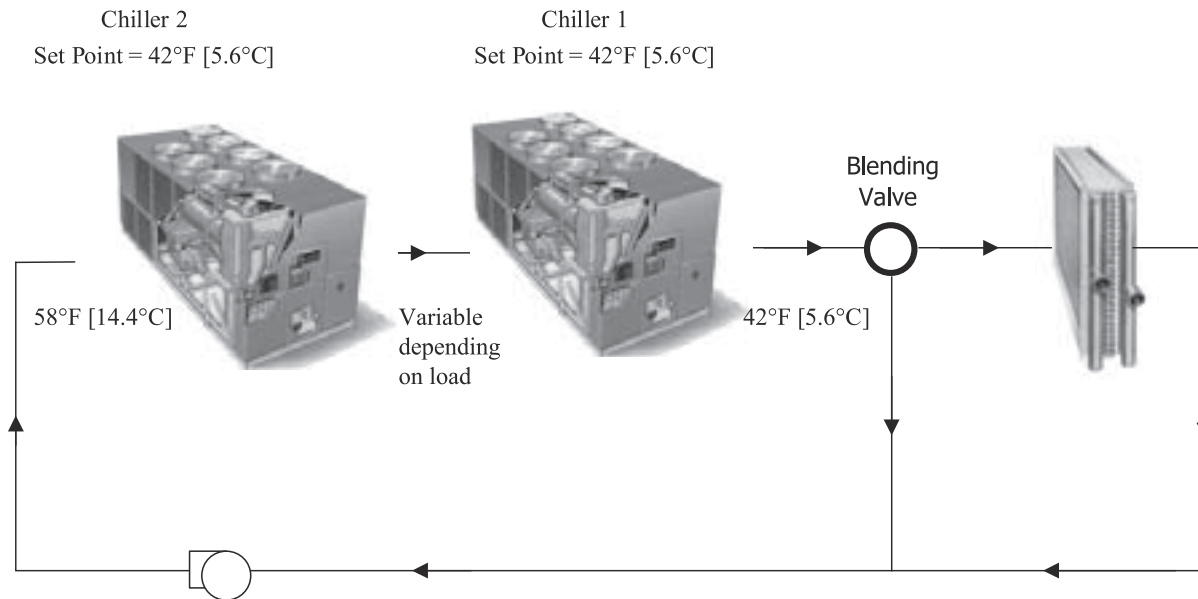

Typical Water Piping

All building water piping must be flushed prior to making the final connections to the chiller. To reduce heat loss and prevent condensation, insulation should be installed. Expansion tanks are also usually required so that chilled water volume changes can be accommodated.

Short Water Loops

The proper location of the temperature control sensor is in the supply (outlet) water connection or pipe. This location allows the building to act as a buffer and assures a slowly changing return water temperature. If there is not a sufficient volume of water in the system to provide an adequate buffer, temperature control can be lost, resulting in erratic system operation and excessive compressor cycling. A short water loop has the same effect as attempting to control from the building return water. Typically, a two minute water loop is sufficient to prevent problems. Therefore, as a guideline, ensure the volume of water in the evaporator loop equals or exceeds two times the evaporator flow rate in gallons per minute. For a rapidly changing load profile, the amount of volume should be increased. To prevent the effect of a short water loop, the following items should be given careful consideration: A storage tank or larger header pipe to increase the volume of water in the system and, therefore, reduce the rate of change of the return water temperature.

Applications Types

- Comfort cooling.
- Industrial process cooling.
- Ice/thermal storage.
- Low temperature process cooling.

Typical Unit Installation

Outdoor HVAC equipment must be located to minimize noise and vibration transmission to the occupied spaces of the building structure it serves. If the equipment must be located in close proximity to a building, it could be placed next to an unoccupied space such as a storage room, mechanical room, etc. It is not recommended to locate the equipment near occupied, sound sensitive areas of the building or near windows. Locating the equipment away from structures will also prevent sound reflection, which can increase levels at property lines, or other sensitive points.

When physically isolating the unit from structures, it is a good idea to not use rigid supports, and to eliminate any metal-to-metal or hard material contact, when possible. This includes replacing spring or metal weave isolation with elastomeric isolators. Figure A4 illustrates isolation recommendations for the RTAC.

For chiller sound ratings, installation tips and considerations on chiller location, pipe isolation, etc., refer to the Trane Air-Cooled Series R Chillers Sound Data and Application Guide for Noise Sensitive Installations.

System Options - Ice Storage

Trane air-cooled Series R Chillers are well suited for ice production. An air-cooled machine typically switches to ice production at night. Two things happen under this assumption. First, the leaving brine temperature from the evaporator is lowered to around 22 to 24°F (-5.5 to -4.4°C). Second, the ambient temperature has typically dropped about 15 to 20°F (8.3 to 11°C) from the peak daytime ambient. This effectively places a lift on the compressors that is similar to daytime running conditions. The chiller can operate in lower ambient at night and successfully produce ice to supplement the next day's cooling demands.

The Model RTAC produces ice by supplying ice storage tanks with a constant supply of glycol solution. Air-cooled chillers selected for these lower leaving fluid temperatures are also selected for efficient production of chilled fluid at nominal comfort cooling conditions. The ability of Trane chillers to serve "double duty" in ice production and comfort cooling greatly reduces the capital cost of ice storage systems.

When cooling is required, ice chilled glycol is pumped from the ice storage tanks directly to the cooling coils. No expensive heat exchanger is required. The glycol loop is a sealed system, eliminating expensive annual chemical treatment costs. The air-cooled chiller is also available for comfort cooling duty at nominal cooling conditions and efficiencies. The modular concept of glycol ice storage systems and the proven simplicity of Trane Tracer controllers allow the successful blend of reliability and energy saving performance in any ice storage application.

The ice storage system is operated in six different modes: each optimized for the utility cost of the hour.

1. Provide comfort cooling with chiller
2. Provide comfort cooling with ice
3. Provide comfort cooling with ice and chiller
4. Freeze ice storage
5. Freeze ice storage when comfort cooling is required
6. Off

Tracer optimization software controls operation of the required equipment and accessories to easily transition from one mode of operation to another. For example:

Even with ice storage systems there are numerous hours when ice is neither produced or consumed, but saved. In this mode the chiller is the sole source of cooling. For example, to cool the building after all ice is produced but before high electrical demand charges take effect, Tracer sets the air-cooled chiller leaving fluid setpoint to its most efficient setting and starts the chiller, chiller pump, and load pump.



Application Considerations

When electrical demand is high, the ice pump is started and the chiller is either demand limited or shut down completely. Tracer controls have the intelligence to optimally balance the contribution of ice and chiller in meeting the cooling load.

The capacity of the chiller plant is extended by operating the chiller and ice in tandem. Tracer rations the ice, augmenting chiller capacity while reducing cooling costs. When ice is produced, Tracer will lower the air-cooled chiller leaving fluid setpoint and start the chiller, ice and chiller pumps, and other accessories. Any incidental loads that persist while producing ice can be addressed by starting the load pump and drawing spent cooling fluid from the ice storage tanks.

For specific information on ice storage applications, contact your local Trane sales office.



Model Number Descriptions

Digits 1, 2 - Unit Model

RT = Rotary chiller

Digit 3 - Unit Type

A = Air-cooled

Digit 4 - Development Sequence

C = Development sequence

Digits 5, 6 & 7 - Nominal Capacity

140 = 140 Nominal tons
155 = 155 Nominal tons
170 = 170 Nominal tons
185 = 185 Nominal tons
200 = 200 Nominal tons
225 = 225 Nominal tons
250 = 250 Nominal tons
275 = 275 Nominal tons
300 = 300 Nominal tons
350 = 350 Nominal tons
400 = 400 Nominal tons
450 = 450 Nominal tons
500 = 500 Nominal tons

Digit 8 - Unit Voltage

A = 200/60/3
C = 230/60/3
J = 380/60/3
4 = 460/60/3
5 = 575/60/3

Digit 9 - Manufacturing Location

U = Water Chiller Business Unit,
Pueblo, CO USA

Digits 10, 11 - Design Sequence

XX = Factory Input

Digit 12 - Unit Basic Configuration

N = Standard efficiency/performance
H = High efficiency/performance
A = Extra efficiency/performance

Digit 13 - Agency Listing

N = No agency listing
U = C/UL listing
S = Seismic rated - IBC and OSHPD
R = C/UL listed and seismic rated

Digit 14 - Pressure Vessel Code

A = ASME pressure vessel code
C = Canadian code
D = Australian code
L = Chinese code

Digit 15 - Evaporator Application

F = Standard (40-60 F) leaving temp
G = Low (Less than 40 F) leaving temp
R = Remote (40-60 F) leaving temp

Digit 16 - Evaporator Configuration

N = 2 pass, 0.75" insulation
P = 3 pass, 0.75" insulation
Q = 2 pass, 1.25" insulation
R = 3 pass, 1.25" insulation

Digit 17 - Condenser Application

N = Standard ambient (25-115°F)
H = High ambient (25-125°F)
L = Low ambient (0-115°F)
W = Wide ambient (0-125°F)

Digit 18 - Condenser Fin Material

1 = Standard aluminum slit fins
2 = Copper fins
4 = CompleteCoat™ epoxy coated fins

Digit 19 - Condenser Fan/Motor Configuration

T = STD fans with TEAO motors
W = Low noise fans

Digit 20 - Compressor Motor Starter Type

X = Across-the-line
Y = Wye-delta closed transition

Digit 21 - Incoming Power Line Connection

1 = Single point power connection
2 = Dual point power connection

Digit 22 - Power Line Connection Type

T = Terminal block connection
D = Non-fused disconnect switch(es)
C = Circuit breaker(s)

Digit 23 - Unit Operator Interface

D = DynaView operator interface

Digit 24 - Remote Operator Interface

N = No remote interface
C = Tracer™ Comm 3 interface
B = BACnet® interface
L = LonTalk® compatible (LCI-C) interface

Digit 25 - Control Input Accessories/Options

N = No remote inputs
R = Ext. evaporator leaving water setpoint
C = Ext. current limit setpoint
B = Ext. leaving water and current limit setpoint

Digit 26 - Control Output Accessories/Options

N = No output options
A = Alarm relay outputs
C = Ice making I/O
D = Alarm relay outputs and ice making I/O

Digit 27 - Electrical Protection Options

0 = No short circuit rating
5 = Default short circuit rating
6 = High amp short circuit rating

Digit 28 - Flow Switch

T = Factory installed flow switch - water
U = Factory installed flow switch glycol

Digit 29 - Control Panel Accessories

N = No convenience outlet
A = 15A 115V convenience outlet (60Hz)

Digit 30 - Service Valves

1 = With suction service valves

Digit 31 - Compressor Sound Attenuation Option

0 = No compressor sound attenuation
1 = Factory installed compressor sound attenuation

Digit 32 - Appearance Options

N = No appearance options
A = Architectural louvered panels
C = Half louvers

Digit 33 - Installation Accessories

N = No installation accessories
F = Flange kit for water connections
R = Neoprene in shear unit isolators
G = Neoprene isolators and flange kit
E = Seismic elastomeric isolation pads
S = Seismic spring isolators

Digit 34 - Factory Testing Options

0 = Standard functional test
C = Customer-witnessed performance test with report
C = Customer-witnessed performance test plus Rapid Restart test
E = Non-witnessed performance test with report

Digit 35 - Control, Label & Literature

C = Spanish
E = English
F = French

Digit 36 - Special Order

X = Standard unit configuration
S = Unit has special order feature

Digit 37 - Safety Devices

N = Standard



General Data

Table 1. 60 Hz standard efficiency – I-P

| Size | | 140 | 155 | 170 | 185 | 200 | 225 | 250 | 275 | 300 | 350 | 400 | 450 | 500 |
|---------------------|----------|------------------------|---------|---------|---------|---------|---------|---------|-----------|-------------|-------------|-----------------|-----------------|-----------------|
| Compressor | | Screw | | | | | | | | | | | | |
| Quantity | # | 2 | 2 | 2 | 2 | 2 | 2 | 2 | 3 | 3 | 3 | 4 | 4 | 4 |
| Nominal size @60Hz | (tons) | 70/70 | 85/70 | 85/85 | 100/85 | 100/100 | 120/100 | 120/120 | 85-85/100 | 100-100/100 | 120-120/100 | 100-100/100-100 | 120-120/100-100 | 120-120/120-120 |
| Evaporator | | Flooded | | | | | | | | | | | | |
| Water storage | (gal) | 29 | 32 | 34 | 36 | 40 | 39 | 43 | 62 | 67 | 72 | 83 | 86 | 91 |
| 2 pass arrangement | | | | | | | | | | | | | | |
| Min flow | (gpm) | 193 | 214 | 202 | 217 | 241 | 217 | 241 | 309 | 339 | 375 | 404 | 422 | 461 |
| Max flow | (gpm) | 709 | 785 | 741 | 796 | 883 | 796 | 883 | 1134 | 1243 | 1374 | 1483 | 1548 | 1690 |
| Water connection | (NPS-in) | 4 | 4 | 6 | 6 | 6 | 6 | 6 | 8 | 8 | 8 | 8 | 8 | 8 |
| 3 pass arrangement | | | | | | | | | | | | | | |
| Min flow | (gpm) | 129 | 143 | 135 | 145 | 161 | 145 | 161 | 206 | 226 | 250 | 270 | 282 | 307 |
| Max flow | (gpm) | 473 | 523 | 494 | 531 | 589 | 531 | 589 | 756 | 829 | 916 | 989 | 1032 | 1127 |
| Water connection | (NPS-in) | 3.5 | 3.5 | 4 | 4 | 4 | 4 | 4 | 6 | 6 | 6 | 8 | 8 | 8 |
| Condenser | | Fin and tube | | | | | | | | | | | | |
| Qty of coils | # | 4 | 4 | 4 | 4 | 4 | 4 | 4 | 8 | 8 | 8 | 8 | 8 | 8 |
| Coil length | (in) | 156/156 | 180/156 | 180/180 | 216/180 | 216/216 | 252/216 | 252/252 | 180/108 | 216/108 | 252/108 | 216/216 | 252/216 | 252/252 |
| Coil height | (in) | 42 | 42 | 42 | 42 | 42 | 42 | 42 | 42 | 42 | 42 | 42 | 42 | 42 |
| | (mm) | 1067 | 1067 | 1067 | 1067 | 1067 | 1067 | 1067 | 1067 | 1067 | 1067 | 1067 | 1067 | 1067 |
| # of rows | # | 3 | 3 | 3 | 3 | 3 | 3 | 3 | 3 | 3 | 3 | 3 | 3 | 3 |
| Fins per foot | (fpf) | 192 | 192 | 192 | 192 | 192 | 192 | 192 | 192 | 192 | 192 | 192 | 192 | 192 |
| Fan | | Direct drive propeller | | | | | | | | | | | | |
| Quantity | # | 4/4 | 5/4 | 5/5 | 6/5 | 6/6 | 7/6 | 7/7 | 10/6 | 12/6 | 14/6 | 12/12 | 14/12 | 14/14 |
| Diameter | (in) | 30.0 | 30.0 | 30.0 | 30.0 | 30.0 | 30.0 | 30.0 | 30.0 | 30.0 | 30.0 | 30.0 | 30.0 | 30.0 |
| Air flow per fan | (cfm) | 9625 | 9394 | 9209 | 9209 | 9209 | 9210 | 9210 | 9209 | 9209 | 9208 | 9209 | 9210 | 9214 |
| Power/motor | (hp) | 1.5 | 1.5 | 1.5 | 1.5 | 1.5 | 1.5 | 1.5 | 1.5 | 1.5 | 1.5 | 1.5 | 1.5 | 1.5 |
| Fan speed | (rpm) | 1140 | 1140 | 1140 | 1140 | 1140 | 1140 | 1140 | 1140 | 1140 | 1140 | 1140 | 1140 | 1140 |
| Tip speed | (Ft/min) | 8954 | 8954 | 8954 | 8954 | 8954 | 8954 | 8954 | 8954 | 8954 | 8954 | 8954 | 8954 | 8954 |
| General Unit | | HFC-134a | | | | | | | | | | | | |
| # Refrig ckts | # | 2 | 2 | 2 | 2 | 2 | 2 | 2 | 2 | 2 | 2 | 2 | 2 | 2 |
| % min load | % | 15 | 15 | 15 | 15 | 15 | 15 | 15 | 15 | 15 | 15 | 15 | 15 | 15 |
| Refrigerant charge | (lb) | 165/165 | 175/165 | 175/175 | 215/210 | 215/215 | 225/215 | 225/225 | 365/200 | 415/200 | 460/200 | 415/415 | 460/415 | 460/460 |
| Oil charge | (gal) | 1.3/1.3 | 1.3/1.3 | 1.3/1.3 | 1.9/1.3 | 1.9/1.9 | 1.9/1.9 | 1.9/1.9 | 4.2/1.9 | 4.6/2.9 | 4.6/1.9 | 4.6/4.6 | 4.6/4.6 | 4.6/4.6 |
| Min ambient-std | (°F) | 25 | 25 | 25 | 25 | 25 | 25 | 25 | 25 | 25 | 25 | 25 | 25 | 25 |
| Min ambient-low | (°F) | 0 | 0 | 0 | 0 | 0 | 0 | 0 | 0 | 0 | 0 | 0 | 0 | 0 |

1. Data containing information on two circuits is shown as follows: ckt 1/ ckt 2.
 2. Minimum start-up/operating ambient is based on a 5 mph wind across the condenser.

Table 2. 60 Hz high efficiency – I-P

| Size | | 140 | 155 | 170 | 185 | 200 | 225 | 250 | 275 | 300 | 350 | 400 |
|---------------------|----------|------------------------|---------|---------|---------|---------|---------|---------|-------------|-------------|-----------------|-----------------|
| Compressor | | Screw | | | | | | | | | | |
| Quantity | # | 2 | 2 | 2 | 2 | 2 | 2 | 2 | 3 | 3 | 4 | 4 |
| Nominal size @60Hz | (tons) | 70/70 | 85/70 | 85/85 | 100/85 | 100/100 | 120/100 | 120/120 | 85-85/100 | 100-100/100 | 85-85/85/85 | 100-100/100-100 |
| Evaporator | | Flooded | | | | | | | | | | |
| Water storage | (gal) | 34 | 36 | 40 | 39 | 43 | 43 | 43 | 72 | 72 | 83 | 91 |
| 2 pass arrangement | | | | | | | | | | | | |
| Min flow | (gpm) | 202 | 217 | 241 | 217 | 241 | 241 | 241 | 375 | 375 | 404 | 461 |
| Max flow | (gpm) | 741 | 796 | 883 | 796 | 883 | 883 | 883 | 1374 | 1374 | 1483 | 1690 |
| Water connection | (NPS-in) | 6 | 6 | 6 | 6 | 6 | 6 | 6 | 8 | 8 | 8 | 8 |
| 3 pass arrangement | | | | | | | | | | | | |
| Min flow | (gpm) | 135 | 145 | 161 | 145 | 161 | 161 | 161 | 250 | 250 | 270 | 307 |
| Max flow | (gpm) | 494 | 531 | 589 | 531 | 589 | 589 | 589 | 916 | 916 | 989 | 1127 |
| Water connection | (NPS-in) | 4 | 4 | 4 | 4 | 4 | 4 | 4 | 6 | 6 | 8 | 8 |
| Condenser | | Fin and tube | | | | | | | | | | |
| Qty of coils | # | 4 | 4 | 4 | 4 | 4 | 8 | 8 | 8 | 8 | 8 | 8 |
| Coil length | (in) | 180/180 | 216/180 | 216/216 | 252/216 | 252/252 | 144/144 | 144/144 | 216/144 | 252/144 | 216/216 | 252/252 |
| Coil height | (in) | 42 | 42 | 42 | 42 | 42 | 42 | 42 | 42 | 42 | 42 | 42 |
| Number of rows | # | 3 | 3 | 3 | 3 | 3 | 3 | 3 | 3 | 3 | 3 | 3 |
| Fins per foot | (fpf) | 192 | 192 | 192 | 192 | 192 | 192 | 192 | 192 | 192 | 192 | 192 |
| Fan | | Direct drive propeller | | | | | | | | | | |
| Quantity | # | 5/5 | 6/5 | 6/6 | 7/6 | 7/7 | 8/6 | 8/8 | 12/6 | 14/6 | 12/12 | 14/14 |
| Diameter | (in) | 30 | 30 | 30 | 30 | 30 | 30 | 30 | 30 | 30 | 30 | 30 |
| Air flow/fan | (cfm) | 9199 | 9199 | 9199 | 9200 | 9201 | 9783 | 9203 | 9652 | 9605 | 9199 | 9201 |
| Power/motor | (hp) | 1.5 | 1.5 | 1.5 | 1.5 | 1.5 | 1.5 | 1.5 | 1.5 | 1.5 | 1.5 | 1.5 |
| Fan speed | (rpm) | 1140 | 1140 | 1140 | 1140 | 1140 | 1140 | 1140 | 1140 | 1140 | 1140 | 1140 |
| Tip speed | (Ft/Min) | 8954 | 8954 | 8954 | 8954 | 8954 | 8954 | 8954 | 8954 | 8954 | 8954 | 8954 |
| General Unit | | HFC-134a | | | | | | | | | | |
| # Refrig ckts | # | 2 | 2 | 2 | 2 | 2 | 2 | 2 | 2 | 2 | 2 | 2 |
| % min load | % | 15 | 15 | 15 | 15 | 15 | 15 | 15 | 15 | 15 | 15 | 15 |
| Refrigerant charge | (lb) | 175/175 | 215/205 | 215/215 | 225/215 | 225/225 | 235/235 | 235/235 | 415/200 | 460/200 | 415/415 | 460/460 |
| Oil charge | (gal) | 1.3/1.3 | 1.3/1.3 | 1.3/1.3 | 1.9/1.3 | 1.9/1.9 | 1.9/1.9 | 1.9/1.9 | 2.1-2.1/1.9 | 2.3-2.3/1.9 | 2.1-2.1/2.1-2.1 | 2.3-2.3/2.3-2.3 |
| Min ambient-std | (°F) | 25 | 25 | 25 | 25 | 25 | 25 | 25 | 25 | 25 | 25 | 25 |
| Min ambient-low | (°F) | 0 | 0 | 0 | 0 | 0 | 0 | 0 | 0 | 0 | 0 | 0 |

1. Data containing information on two circuits is shown as follows: ckt 1/ ckt 2.
 2. Minimum start-up/operating ambient is based on a 5 mph wind across the condenser.



General Data

Table 3. 60 Hz extra efficiency — I-P

| Size | | 140 | 155 | 170 | 185 | 200 | 250 | 275 | 300 | 350 |
|---------------------|----------|------------------------|---------|---------|---------|---------|-------------|-------------|-----------------|-----------------|
| Compressor | | Screw | | | | | | | | |
| Quantity | # | 2 | 2 | 2 | 2 | 2 | 3 | 3 | 4 | 4 |
| Nominal size @60Hz | (tons) | 70/70 | 85/70 | 85/85 | 100/85 | 100/100 | 70-70/85 | 85-85/85 | 70-70/70-70 | 85-85/85-85 |
| Evaporator | | Flooded | | | | | | | | |
| Water storage | (gal) | 40 | 39 | 43 | 43 | 43 | 72 | 72 | 83 | 91 |
| 2 pass arrangement | | | | | | | | | | |
| Min flow | (gpm) | 241 | 217 | 241 | 241 | 241 | 375 | 375 | 404 | 461 |
| Max flow | (gpm) | 883 | 796 | 883 | 883 | 883 | 1374 | 1374 | 1483 | 1690 |
| Water connection | (NPS-in) | 6 | 6 | 6 | 6 | 6 | 8 | 8 | 8 | 8 |
| 3 pass arrangement | | | | | | | | | | |
| Min flow | (gpm) | 161 | 145 | 161 | 161 | 161 | 250 | 250 | 270 | 307 |
| Max flow | (gpm) | 589 | 531 | 589 | 589 | 589 | 916 | 916 | 989 | 1127 |
| Water connection | (NPS-in) | 4 | 4 | 4 | 4 | 4 | 6 | 6 | 8 | 8 |
| Condenser | | Fin and tube | | | | | | | | |
| Qty of coils | # | 4 | 4 | 4 | 8 | 8 | 8 | 8 | 8 | 8 |
| Coil length | (in) | 216/216 | 252/216 | 252/252 | 144/144 | 144/144 | 216/144 | 252/144 | 216/216 | 252/252 |
| Coil height | (in) | 42 | 42 | 42 | 42 | 42 | 42 | 42 | 42 | 42 |
| Number of rows | # | 3 | 3 | 3 | 3 | 3 | 3 | 3 | 3 | 3 |
| Fins per foot | (fpf) | 192 | 192 | 192 | 192 | 192 | 192 | 192 | 192 | 192 |
| Fan | | Direct drive propeller | | | | | | | | |
| Quantity | # | 6/6 | 7/6 | 7/7 | 8/6 | 8/8 | 12/6 | 14/6 | 12/12 | 14/14 |
| Diameter | (in) | 30 | 30 | 30 | 30 | 30 | 30 | 30 | 30 | 30 |
| Air flow/fan | (cfm) | 9199 | 9200 | 9201 | 9783 | 9203 | 9652 | 9605 | 9199 | 9201 |
| Power/motor | (hp) | 1.5 | 1.5 | 1.5 | 1.5 | 1.5 | 1.5 | 1.5 | 1.5 | 1.5 |
| Fan speed | (rpm) | 1140 | 1140 | 1140 | 1140 | 1140 | 1140 | 1140 | 1140 | 1140 |
| Tip speed | (Ft/Min) | 8954 | 8954 | 8954 | 8954 | 8954 | 8954 | 8954 | 8954 | 8954 |
| General Unit | | HFC-134a | | | | | | | | |
| # Refrig ckts | # | 2 | 2 | 2 | 2 | 2 | 2 | 2 | 2 | 2 |
| % min load | % | 15 | 15 | 15 | 15 | 15 | 15 | 15 | 15 | 15 |
| Refrigerant charge | (lb) | 215/215 | 225/215 | 225/225 | 235/235 | 235/235 | 415/200 | 460/200 | 415/415 | 460/460 |
| Oil charge | (gal) | 1.3/1.3 | 1.9/1.3 | 1.9/1.9 | 1.9/1.9 | 1.9/1.9 | 2.1-2.1/1.9 | 2.1-2.1/1.9 | 2.1-2.1/2.1-2.1 | 2.1-2.1/2.1-2.1 |
| Min ambient-std | (°F) | 25 | 25 | 25 | 25 | 25 | 25 | 25 | 25 | 25 |
| Min ambient-low | (°F) | 0 | 0 | 0 | 0 | 0 | 0 | 0 | 0 | 0 |

1. Data containing information on two circuits is shown as follows: ckt 1/ ckt 2.
2. Minimum start-up/operating ambient is based on a 5 mph wind across the condenser.



General Data

Table 4. 60 Hz standard efficiency – SI

| Size | | 140 | 155 | 170 | 185 | 200 | 225 | 250 | 275 | 300 | 350 | 400 | 450 | 500 |
|---------------------------|----------------------|------------------------|-----------|-----------|-----------|-----------|-----------|-----------|-----------|-------------|-------------|-----------------|-----------------|-----------------|
| Compressor | | Screw | | | | | | | | | | | | |
| Quantity | # | 2 | 2 | 2 | 2 | 2 | 2 | 2 | 3 | 3 | 4 | 4 | 4 | 4 |
| Nominal size (tons) @60Hz | | 70/70 | 85/70 | 85/85 | 100/85 | 100/100 | 120/100 | 120/120 | 85-85/100 | 100-100/100 | 120-120/100 | 100-100/100-100 | 120-120/100-100 | 120-120/120-120 |
| Evaporator | | Flooded | | | | | | | | | | | | |
| Water storage | (L) | 110.0 | 121 | 129 | 136 | 151 | 148 | 163 | 235 | 254 | 273 | 314 | 326 | 344 |
| 2 pass arrangement | | | | | | | | | | | | | | |
| Min flow | (L/s) | 12 | 14 | 13 | 14 | 15 | 14 | 15 | 19 | 21 | 24 | 25 | 27 | 29 |
| Max flow | (L/s) | 45 | 50 | 47 | 50 | 56 | 50 | 56 | 72 | 78 | 87 | 94 | 98 | 107 |
| Water connection | (NPS-in) | 4 | 4 | 6 | 6 | 6 | 6 | 6 | 8 | 8 | 8 | 8 | 8 | 8 |
| 3 pass arrangement | | | | | | | | | | | | | | |
| Min flow | (L/s) | 8 | 9 | 9 | 9 | 10 | 9 | 10 | 13 | 14 | 16 | 17 | 18 | 19 |
| Max flow | (L/s) | 30 | 33 | 31 | 34 | 37 | 34 | 37 | 48 | 52 | 58 | 62 | 65 | 71 |
| Water connection | (NPS-in) | 3.5 | 3.5 | 4 | 4 | 4 | 4 | 4 | 6 | 6 | 6 | 8 | 8 | 8 |
| Condenser | | Fin and tube | | | | | | | | | | | | |
| Qty of coils | # | 4 | 4 | 4 | 4 | 4 | 4 | 4 | 8 | 8 | 8 | 8 | 8 | 8 |
| Coil length | (mm) | 3962/3962 | 4572/3962 | 4572/4572 | 5486/4572 | 5486/5486 | 6400/5486 | 6400/6400 | 4572/2743 | 5486/2743 | 6400/2743 | 5486/5486 | 6400/5486 | 6400/6400 |
| Coil height | (mm) | 1067 | 1067 | 1067 | 1067 | 1067 | 1067 | 1067 | 1067 | 1067 | 1067 | 1067 | 1067 | 1067 |
| # of rows | # | 3 | 3 | 3 | 3 | 3 | 3 | 3 | 3 | 3 | 3 | 3 | 3 | 3 |
| Fins per foot | (fpf) | 192 | 192 | 192 | 192 | 192 | 192 | 192 | 192 | 192 | 192 | 192 | 192 | 192 |
| Fan | | Direct drive propeller | | | | | | | | | | | | |
| Quantity | # | 4/4 | 5/4 | 5/5 | 6/5 | 6/6 | 7/6 | 7/7 | 10/6 | 12/6 | 14/6 | 12/12 | 14/12 | 14/14 |
| Diameter | (mm) | 726.0 | 726.0 | 726.0 | 726.0 | 726.0 | 726.0 | 726.0 | 726.0 | 726.0 | 726.0 | 726.0 | 726.0 | 726.0 |
| Air flow per fan | (m ³ /hr) | 16351 | 15958 | 15644 | 15644 | 15644 | 15646 | 15647 | 15644 | 15645 | 15642 | 15645 | 15646 | 15653 |
| Power/motor | (kW) | 1.12 | 1.12 | 1.12 | 1.12 | 1.12 | 1.12 | 1.12 | 1.12 | 1.12 | 1.12 | 1.12 | 1.12 | 1.12 |
| Fan speed | (rps) | 19 | 19 | 19 | 19 | 19 | 19 | 19 | 19 | 19 | 19 | 19 | 19 | 19 |
| Tip speed | M/S | 45 | 45 | 45 | 45 | 45 | 45 | 45 | 45 | 45 | 45 | 45 | 45 | 45 |
| General Unit | | HFC-134a | | | | | | | | | | | | |
| # Refrig ckts | # | 2 | 2 | 2 | 2 | 2 | 2 | 2 | 2 | 2 | 2 | 2 | 2 | 2 |
| % min load | % | 15 | 15 | 15 | 15 | 15 | 15 | 15 | 15 | 15 | 15 | 15 | 15 | 15 |
| Refrigerant charge | (kg) | 75/75 | 79/75 | 79/79 | 98/95 | 98/98 | 102/98 | 102/102 | 166/91 | 188/91 | 209/91 | 188/188 | 209/188 | 209/209 |
| Oil charge | (L) | 5/5 | 5/5 | 5/5 | 7/5 | 7/7 | 7/7 | 7/7 | 8-8/7 | 9-9/11 | 9-9/11 | 9-9/9-9 | 9-9/9-9 | 9-9/9-9 |
| Min ambient-std | (°C) | -3.9 | -3.9 | -3.9 | -3.9 | -3.9 | -3.9 | -3.9 | -3.9 | -3.9 | -3.9 | -3.9 | -3.9 | -3.9 |
| Min ambient-low | (°C) | -17.8 | -17.8 | -17.8 | -17.8 | -17.8 | -17.8 | -17.8 | -17.8 | -17.8 | -17.8 | -17.8 | -17.8 | -17.8 |

1. Data containing information on two circuits is shown as follows: ckt 1/ ckt 2.
2. Minimum start-up/operating ambient is based on a 5 mph wind across the condenser.



General Data

Table 5. 60 Hz high efficiency – SI

| Size | | 140 | 155 | 170 | 185 | 200 | 225 | 250 | 275 | 300 | 350 | 400 |
|---------------------|----------------------|------------------------|---------------|---------------|---------------|---------------|---------------|---------------|---------------|---------------|---------------|-----------------|
| Compressor | | Screw | | | | | | | | | | |
| Quantity | # | 2 | 2 | 2 | 2 | 2 | 2 | 2 | 3 | 3 | 4 | 4 |
| Nominal size @60Hz | (tons) | 70/70 | 85/70 | 85/85 | 100/85 | 100/100 | 120/100 | 120/120 | 85-85/100 | 100-100/100 | 85-85/85/85 | 100-100/100-100 |
| Evaporator | | Flooded | | | | | | | | | | |
| Water storage | (L) | 129 | 136 | 151 | 148 | 163 | 163 | 163 | 273 | 273 | 314 | 344 |
| 2 Pass arrangement | | | | | | | | | | | | |
| Min flow | (L/s) | 13 | 14 | 15 | 14 | 15 | 15 | 15 | 24 | 24 | 25 | 29 |
| Max flow | (L/s) | 47 | 50 | 56 | 50 | 56 | 56 | 56 | 87 | 87 | 94 | 107 |
| Water connection | (NPS-in) | 6 | 6 | 6 | 6 | 6 | 6 | 6 | 8 | 8 | 8 | 8 |
| 3 Pass arrangement | | | | | | | | | | | | |
| Min flow | (L/s) | 9 | 9 | 10 | 9 | 10 | 10 | 10 | 16 | 16 | 17 | 19 |
| Max flow | (L/s) | 31 | 34 | 37 | 34 | 37 | 37 | 37 | 58 | 58 | 62 | 71 |
| Water connection | (NPS-in) | 4 | 4 | 4 | 4 | 4 | 4 | 4 | 6 | 6 | 8 | 8 |
| Condenser | | Fin and tube | | | | | | | | | | |
| Qty of coils | # | 4 | 4 | 4 | 4 | 4 | 8 | 8 | 8 | 8 | 8 | 8 |
| Coil length | (mm) | 4572/ 4572 | 5486/ 4572 | 5486/ 5486 | 6400/ 5486 | 6400/ 6400 | 3657/ 3657 | 3657/ 3657 | 5486/ 3657 | 6400/ 3657 | 5486/ 5486 | 6400/ 6400 |
| Coil height | (mm) | 1067 | 1067 | 1067 | 1067 | 1067 | 1067 | 1067 | 1067 | 1067 | 1067 | 1067 |
| Number of rows | # | 3 | 3 | 3 | 3 | 3 | 3 | 3 | 3 | 3 | 3 | 3 |
| Fins per foot | (fpf) | 192 | 192 | 192 | 192 | 192 | 192 | 192 | 192 | 192 | 192 | 192 |
| Fan | | Direct drive propeller | | | | | | | | | | |
| Quantity | # | 5/5 | 6/5 | 6/6 | 7/6 | 7/7 | 8/6 | 8/8 | 12/6 | 14/6 | 12/12 | 14/14 |
| Diameter | (mm) | 762 | 762 | 762 | 762 | 762 | 762 | 762 | 762 | 762 | 762 | 762 |
| Air per fan | (m ³ /hr) | 15628 | 15628 | 15628 | 15629 | 15631 | 16619 | 15634 | 16397 | 16317 | 15628 | 15631 |
| Power/motor | (kW) | 1.12 | 1.12 | 1.12 | 1.12 | 1.12 | 1.12 | 1.12 | 1.12 | 1.12 | 1.12 | 1.12 |
| Fan speed | (rps) | 19 | 19 | 19 | 19 | 19 | 19 | 19 | 19 | 19 | 19 | 19 |
| Tip speed | M/S | 45 | 45 | 45 | 45 | 45 | 45 | 45 | 45 | 45 | 45 | 45 |
| General Unit | | HFC-134a | | | | | | | | | | |
| # refrig ckts | # | 2 | 2 | 2 | 2 | 2 | 2 | 2 | 2 | 2 | 2 | 2 |
| % min load | % | 15 | 15 | 15 | 15 | 15 | 15 | 15 | 15 | 15 | 15 | 15 |
| Refrig charge | (kg) | 79/79 | 98/93 | 98/98 | 102/98 | 102/102 | 107/107 | 107/107 | 188/91 | 209/91 | 188/188 | 209/209 |
| Oil charge | (L) | 5/5 | 5/5 | 5/5 | 7/5 | 7/7 | 7/7 | 7/7 | 8-8/7 | 9-9/7 | 8-8/8-8 | 9-9/9-9 |
| Min ambient-std | (°C) | -3.9 | -3.9 | -3.9 | -3.9 | -3.9 | -3.9 | -3.9 | -3.9 | -3.9 | -3.9 | -3.9 |
| Min ambient-low | (°C) | -17.8 | -17.8 | -17.8 | -17.8 | -17.8 | -17.8 | -17.8 | -17.8 | -17.8 | -17.8 | -17.8 |

1. Data containing information on two circuits is shown as follows: ckt 1/ ckt 2.
2. Minimum start-up/operating ambient is based on a 5 mph wind across the condenser.

Table 6. 60 Hz extra efficiency – SI

| Size | | 140 | 155 | 170 | 185 | 200 | 250 | 275 | 300 | 350 |
|---------------------|----------------------|-----------|-----------|-----------|-----------|------------------------|-----------|-------------|-------------|-----------------|
| Compressor | | | | | | | | | | |
| Quantity | # | 2 | 2 | 2 | 2 | 2 | 3 | 3 | 4 | 4 |
| Nominal size @60Hz | (tons) | 85/85 | 100/85 | 100/100 | 120/100 | 120/120 | 85-85/100 | 100-100/100 | 85-85/85/85 | 100-100/100-100 |
| Evaporator | | | | | | | | | | |
| | | | | | | Flooded | | | | |
| Water storage | (L) | 151 | 148 | 163 | 163 | 163 | 273 | 273 | 314 | 344 |
| 2 Pass arrangement | | | | | | | | | | |
| Min flow | (L/s) | 15 | 14 | 15 | 15 | 15 | 24 | 24 | 25 | 29 |
| Max flow | (L/s) | 56 | 50 | 56 | 56 | 56 | 87 | 87 | 94 | 107 |
| Water connection | (NPS-in) | 6 | 6 | 6 | 6 | 6 | 8 | 8 | 8 | 8 |
| 3 Pass arrangement | | | | | | | | | | |
| Min flow | (L/s) | 10 | 9 | 10 | 10 | 10 | 16 | 16 | 17 | 19 |
| Max flow | (L/s) | 37 | 34 | 37 | 37 | 37 | 58 | 58 | 62 | 71 |
| Water connection | (NPS-in) | 4 | 4 | 4 | 4 | 4 | 6 | 6 | 8 | 8 |
| Condenser | | | | | | | | | | |
| | | | | | | Fin and tube | | | | |
| Qty of coils | # | 4 | 4 | 4 | 8 | 8 | 8 | 8 | 8 | 8 |
| Coil length | (mm) | 5486/5486 | 6400/5486 | 6400/6400 | 3657/3657 | 4572/2743 | 5486/3657 | 6400/3657 | 5486/5486 | 6400/6400 |
| Coil height | (mm) | 1067 | 1067 | 1067 | 1067 | 1067 | 1067 | 1067 | 1067 | 1067 |
| Number of rows | # | 3 | 3 | 3 | 3 | 3 | 3 | 3 | 3 | 3 |
| Fins per foot | (fpf) | 192 | 192 | 192 | 192 | 192 | 192 | 192 | 192 | 192 |
| Fan | | | | | | | | | | |
| | | | | | | Direct drive propeller | | | | |
| Quantity | # | 6/6 | 7/6 | 7/7 | 8/6 | 8/8 | 12/6 | 14/6 | 12/12 | 14/14 |
| Diameter | (mm) | 762 | 762 | 762 | 762 | 762 | 762 | 762 | 762 | 762 |
| Air per fan | (m ³ /hr) | 15628 | 15629 | 15631 | 16619 | 15634 | 16397 | 16317 | 15628 | 15631 |
| Power/motor | (kW) | 1.12 | 1.12 | 1.12 | 1.12 | 1.12 | 1.12 | 1.12 | 1.12 | 1.12 |
| Fan speed | (rps) | 19 | 19 | 19 | 19 | 19 | 19 | 19 | 19 | 19 |
| Tip speed | M/S | 45 | 45 | 45 | 45 | 45 | 45 | 45 | 45 | 45 |
| General Unit | | | | | | | | | | |
| | | | | | | HFC-134a | | | | |
| # refig ckts | # | 2 | 2 | 2 | 2 | 2 | 2 | 2 | 2 | 2 |
| % min load | % | 15 | 15 | 15 | 15 | 15 | 15 | 15 | 15 | 15 |
| Refrig charge | (kg) | 98/98 | 102/98 | 102/102 | 107/107 | 107/107 | 188/91 | 209/91 | 188/188 | 209/209 |
| Oil charge | (L) | 5/5 | 7/5 | 7/7 | 7/7 | 7/7 | 8-8/7 | 8-8/7 | 8-8/8-8 | 8-8/8-8 |
| Min ambient-std | (°C) | -3.9 | -3.9 | -3.9 | -3.9 | -3.9 | -3.9 | -3.9 | -3.9 | -3.9 |
| Min ambient-low | (°C) | -17.8 | -17.8 | -17.8 | -17.8 | -17.8 | -17.8 | -17.8 | -17.8 | -17.8 |

1. Data containing information on two circuits is shown as follows: ckt 1/ ckt 2.
 2. Minimum start-up/operating ambient is based on a 5 mph wind across the condenser.



Performance Data

Table 7. 60 Hz standard efficiency – I-P units

| Evap Leaving Water Temp (°F) | Cond Entering Air Temp (°F) | | | | | | | | | | | | |
|---------------------------------------|-----------------------------|-------|--------------------------|------------------|-------|--------------------------|------------------|-------|--------------------------|------------------|-------|--------------------------|------------------|
| | Unit Size | 85 | | | 95 | | | 105 | | | 115 | | |
| | | Tons | kW Input ² | EER ³ | Tons | kW Input ² | EER ³ | Tons | kW Input ² | EER ³ | Tons | kW Input ² | EER ³ |
| 40 | 140 | 138.1 | 139.6 | 10.9 | 128.3 | 151.9 | 9.4 | 118.3 | 165.8 | 8 | 108 | 181.2 | 6.7 |
| | 155 | 151.5 | 151.6 | 11 | 141 | 165 | 9.5 | 130.1 | 180.1 | 8.1 | 119 | 196.9 | 6.8 |
| | 170 | 165.6 | 163.8 | 11.1 | 154.4 | 178.5 | 9.6 | 142.7 | 194.9 | 8.2 | 130.9 | 213.2 | 6.9 |
| | 185 | 181.5 | 182 | 10.9 | 169.2 | 197.8 | 9.5 | 156.6 | 215.5 | 8.1 | 143.6 | 235.4 | 6.8 |
| | 200 | 198.5 | 201 | 10.9 | 185.1 | 217.8 | 9.4 | 171.3 | 236.9 | 8.1 | 156.9 | 258.3 | 6.8 |
| | 225 | 218 | 221.6 | 10.8 | 203.6 | 240.2 | 9.4 | 188.6 | 261.2 | 8.1 | 173.1 | 284.8 | 6.8 |
| | 250 | 239.1 | 243.3 | 10.8 | 223.5 | 263.6 | 9.4 | 207.2 | 286.6 | 8.1 | 190.2 | 312.4 | 6.9 |
| | 275 | 265.5 | 266.3 | 10.9 | 247.6 | 289.2 | 9.5 | 229.1 | 315.1 | 8.1 | 210.2 | 344 | 6.9 |
| | 300 | 298.4 | 304.8 | 10.8 | 278.3 | 329.8 | 9.4 | 257.6 | 358.3 | 8 | 236.3 | 390.2 | 6.8 |
| | 350 | 338.9 | 348.7 | 10.7 | 316.6 | 377.1 | 9.3 | 293.4 | 409.3 | 8 | 269.3 | 445.4 | 6.8 |
| | 400 | 400.7 | 409.7 | 10.8 | 374.1 | 443.2 | 9.4 | 346.4 | 481.3 | 8 | 317.9 | 524 | 6.8 |
| | 450 | 440.8 | 453.5 | 10.7 | 412 | 490.4 | 9.3 | 382 | 532.4 | 8 | 350.9 | 579.4 | 6.8 |
| | 500 | 482.4 | 498.3 | 10.7 | 451.1 | 538.5 | 9.3 | 418.5 | 584.2 | 8 | 384.5 | 635.4 | 6.8 |
| 42 | 140 | 143.4 | 142.6 | 11.1 | 133.3 | 155 | 9.6 | 122.9 | 168.9 | 8.1 | 112.2 | 184.4 | 6.9 |
| | 155 | 157.3 | 154.8 | 11.2 | 146.4 | 168.3 | 9.6 | 135.2 | 183.5 | 8.2 | 123.7 | 200.4 | 6.9 |
| | 170 | 171.8 | 167.3 | 11.3 | 160.2 | 182 | 9.7 | 148.3 | 198.6 | 8.3 | 136 | 217 | 7 |
| | 185 | 188.2 | 185.9 | 11.1 | 175.6 | 201.8 | 9.6 | 162.5 | 219.7 | 8.3 | 149.1 | 239.6 | 7 |
| | 200 | 205.8 | 205.4 | 11 | 192 | 222.4 | 9.6 | 177.7 | 241.6 | 8.2 | 162.9 | 263.1 | 7 |
| | 225 | 225.9 | 226.5 | 11 | 211.1 | 245.3 | 9.6 | 195.6 | 266.5 | 8.2 | 179.6 | 290.3 | 7 |
| | 250 | 247.9 | 248.8 | 11 | 231.7 | 269.3 | 9.6 | 214.8 | 292.6 | 8.2 | 197.3 | 318.6 | 7 |
| | 275 | 275.3 | 272 | 11.1 | 256.8 | 295.1 | 9.6 | 237.8 | 321.1 | 8.3 | 218.3 | 350.2 | 7 |
| | 300 | 309.3 | 311.6 | 10.9 | 288.6 | 336.8 | 9.5 | 267.2 | 365.4 | 8.2 | 245.2 | 397.5 | 6.9 |
| | 350 | 351.3 | 356.7 | 10.9 | 328.2 | 385.3 | 9.5 | 304.2 | 417.8 | 8.2 | 279.3 | 454.3 | 6.9 |
| | 400 | 415.1 | 418.8 | 10.9 | 387.6 | 452.6 | 9.5 | 359.1 | 490.9 | 8.2 | 329.7 | 533.8 | 7 |
| | 450 | 456.6 | 463.7 | 10.9 | 426.8 | 500.9 | 9.5 | 395.8 | 543.2 | 8.2 | 363.7 | 590.7 | 6.9 |
| | 500 | 499.7 | 509.7 | 10.9 | 467.4 | 550.3 | 9.5 | 433.6 | 596.4 | 8.2 | 398.5 | 648.3 | 6.9 |
| 44 | 140 | 148.7 | 145.6 | 11.3 | 138.3 | 158.1 | 9.7 | 127.6 | 172.1 | 8.3 | 116.6 | 187.7 | 7 |
| | 155 | 163.1 | 158.1 | 11.4 | 151.9 | 171.7 | 9.8 | 140.3 | 187 | 8.4 | 128.5 | 204 | 7.1 |
| | 170 | 178.1 | 170.8 | 11.5 | 166.1 | 185.6 | 9.9 | 153.8 | 202.3 | 8.5 | 141.3 | 220.8 | 7.2 |
| | 185 | 195 | 189.9 | 11.3 | 182 | 205.9 | 9.8 | 168.5 | 223.9 | 8.4 | 154.7 | 244 | 7.1 |
| | 200 | 213.2 | 210 | 11.2 | 198.9 | 227.1 | 9.7 | 184.2 | 246.4 | 8.4 | 169 | 268.1 | 7.1 |
| | 225 | 234 | 231.6 | 11.2 | 218.6 | 250.5 | 9.7 | 202.7 | 271.9 | 8.4 | 186.1 | 295.9 | 7.1 |
| | 250 | 256.8 | 254.5 | 11.2 | 240.1 | 275.2 | 9.7 | 222.6 | 298.7 | 8.4 | 204.4 | 325 | 7.1 |
| | 275 | 285.3 | 277.9 | 11.3 | 266.2 | 301.1 | 9.8 | 246.6 | 327.3 | 8.4 | 226.5 | 356.5 | 7.2 |
| | 300 | 320.3 | 318.6 | 11.1 | 299 | 343.9 | 9.7 | 276.9 | 372.7 | 8.3 | 254.2 | 405 | 7.1 |
| | 350 | 363.9 | 364.9 | 11 | 340 | 393.7 | 9.6 | 315.2 | 426.5 | 8.3 | 289.5 | 463.3 | 7.1 |
| | 400 | 429.7 | 428.1 | 11.1 | 401.3 | 462.1 | 9.7 | 371.9 | 500.6 | 8.3 | 341.6 | 543.7 | 7.1 |
| | 450 | 472.6 | 474.1 | 11 | 441.9 | 511.7 | 9.6 | 409.9 | 554.3 | 8.3 | 376.7 | 602.2 | 7.1 |
| | 500 | 517.3 | 521.4 | 11 | 483.9 | 562.4 | 9.6 | 449 | 609 | 8.3 | 412.6 | 661.4 | 7.1 |

Table 7. 60 Hz standard efficiency – I-P units (continued)

| Evap Leaving Water Temp (°F) | Cond Entering Air Temp (°F) | | | | | | | | | | | | |
|---------------------------------------|-----------------------------|-------|--------------------------|------------------|-------|--------------------------|------------------|-------|--------------------------|------------------|-------|--------------------------|------------------|
| | 85 | | | | 95 | | | | 105 | | | | 115 |
| | Unit Size | Tons | kW Input ² | EER ³ | Tons | kW Input ² | EER ³ | Tons | kW Input ² | EER ³ | Tons | kW Input ² | EER ³ |
| 46 | 140 | 154.1 | 148.8 | 11.5 | 143.4 | 161.3 | 9.9 | 132.3 | 175.4 | 8.5 | 121 | 191 | 7.2 |
| | 155 | 169 | 161.5 | 11.6 | 157.4 | 175.2 | 10 | 145.6 | 190.5 | 8.6 | 133.4 | 207.6 | 7.2 |
| | 170 | 184.5 | 174.4 | 11.7 | 172.2 | 189.3 | 10.1 | 159.5 | 206.1 | 8.7 | 146.6 | 224.7 | 7.3 |
| | 185 | 201.9 | 194.1 | 11.5 | 188.5 | 210.1 | 10 | 174.6 | 228.3 | 8.6 | 160.4 | 248.5 | 7.3 |
| | 200 | 220.7 | 214.7 | 11.4 | 206 | 231.9 | 9.9 | 190.8 | 251.3 | 8.5 | 175.1 | 273.1 | 7.2 |
| | 225 | 242.1 | 236.8 | 11.3 | 226.3 | 255.8 | 9.9 | 209.8 | 277.5 | 8.5 | 192.8 | 301.7 | 7.2 |
| | 250 | 265.8 | 260.2 | 11.3 | 248.5 | 281.2 | 9.9 | 230.5 | 304.9 | 8.5 | 211.6 | 331.6 | 7.2 |
| | 275 | 295.4 | 284 | 11.5 | 275.8 | 307.3 | 10 | 255.6 | 333.6 | 8.6 | 234.9 | 362.9 | 7.3 |
| | 300 | 331.5 | 325.7 | 11.3 | 309.5 | 351.2 | 9.8 | 286.7 | 380.2 | 8.5 | 263.3 | 412.6 | 7.2 |
| | 350 | 376.6 | 373.3 | 11.2 | 352 | 402.4 | 9.8 | 326.3 | 435.4 | 8.4 | 297.3 | 467.6 | 7.2 |
| | 400 | 444.4 | 437.6 | 11.2 | 415.2 | 471.8 | 9.8 | 384.9 | 510.5 | 8.5 | 353.7 | 553.8 | 7.2 |
| | 450 | 488.8 | 484.8 | 11.2 | 457.1 | 522.7 | 9.8 | 424.1 | 565.7 | 8.4 | 384.5 | 602.6 | 7.2 |
| | 500 | 535.2 | 533.4 | 11.2 | 500.7 | 574.8 | 9.7 | 464.5 | 621.9 | 8.4 | 416.8 | 652.5 | 7.2 |
| 48 | 140 | 159.6 | 152 | 11.7 | 148.5 | 164.6 | 10.1 | 137.1 | 178.7 | 8.6 | 124.5 | 192.8 | 7.3 |
| | 155 | 175 | 164.9 | 11.7 | 163.1 | 178.7 | 10.2 | 150.8 | 194.2 | 8.7 | 137.3 | 209.6 | 7.4 |
| | 170 | 190.9 | 178.1 | 11.8 | 178.3 | 193.1 | 10.3 | 165.3 | 210 | 8.8 | 152 | 228.6 | 7.5 |
| | 185 | 208.9 | 198.3 | 11.6 | 195.1 | 214.5 | 10.1 | 180.8 | 232.7 | 8.7 | 166.2 | 253 | 7.4 |
| | 200 | 228.2 | 219.4 | 11.5 | 213.1 | 236.7 | 10 | 197.4 | 256.3 | 8.6 | 181.3 | 278.1 | 7.4 |
| | 225 | 250.4 | 242 | 11.5 | 234.1 | 261.3 | 10 | 217.1 | 283.1 | 8.6 | 199.5 | 307.5 | 7.3 |
| | 250 | 275 | 266.2 | 11.5 | 257.1 | 287.3 | 10 | 238.4 | 311.3 | 8.6 | 216 | 331.7 | 7.4 |
| | 275 | 305.7 | 290.2 | 11.7 | 285.4 | 313.6 | 10.1 | 264.7 | 340 | 8.7 | 243.3 | 369.5 | 7.4 |
| | 300 | 342.8 | 333 | 11.4 | 320.1 | 358.7 | 10 | 296.7 | 387.7 | 8.6 | 272.5 | 420.3 | 7.3 |
| | 350 | 389.6 | 381.8 | 11.3 | 364.1 | 411.2 | 9.9 | 337.5 | 444.5 | 8.5 | 301.2 | 462.7 | 7.3 |
| | 400 | 459.4 | 447.4 | 11.4 | 429.2 | 481.7 | 9.9 | 398.1 | 520.6 | 8.6 | 363.2 | 558.7 | 7.3 |
| | 450 | 505.3 | 495.8 | 11.3 | 472.6 | 533.9 | 9.9 | 438.5 | 577.3 | 8.5 | 389.9 | 597.2 | 7.4 |
| | 500 | 553.4 | 545.7 | 11.3 | 517.7 | 587.5 | 9.9 | 480.3 | 635.2 | 8.5 | 421.5 | 644.1 | 7.4 |

1. Rated in accordance with AHRI Standard 550/590 based on TOPSS version 140: sea level altitude, evaporator fouling factor of 0.0001°F-ft²h/Btu, evaporator temperature drop of 10°F, and 2 pass evaporator configuration. Consult a Trane representative for additional performance information.

2. kW input is for compressors only.

3. EER = Energy Efficiency Ratio (Btu/watt-hour). Power inputs include compressors, condenser fans and control power.

4. Interpolation between points is permissible. Extrapolation is not permitted.



Performance Data

Table 8. 60 Hz high efficiency – I-P units

| Evap Leaving Water Temp (°F) | Cond Entering Air Temp (°F) | | | | | | | | | | | | |
|---------------------------------------|-----------------------------|-------|--------------------------|------------------|-------|--------------------------|------------------|-------|--------------------------|------------------|-------|--------------------------|------------------|
| | Unit Size | 85 | | | 95 | | | 105 | | | 115 | | |
| | | Tons | kW Input ² | EER ³ | Tons | kW Input ² | EER ³ | Tons | kW Input ² | EER ³ | Tons | kW Input ² | EER ³ |
| 40 | 140 | 141.1 | 134.3 | 11.3 | 131.4 | 145.8 | 9.8 | 121.4 | 158.8 | 8.4 | 111.1 | 173.5 | 7.1 |
| | 155 | 156.2 | 145.2 | 11.5 | 145.6 | 157.9 | 10 | 134.7 | 172.3 | 8.6 | 123.5 | 188.4 | 7.2 |
| | 170 | 170.1 | 156.6 | 11.7 | 158.7 | 170.4 | 10.1 | 147 | 186.1 | 8.6 | 134.9 | 203.6 | 7.3 |
| | 185 | 186.9 | 175.1 | 11.5 | 174.6 | 190 | 10 | 161.8 | 206.9 | 8.6 | 148.7 | 225.9 | 7.3 |
| | 200 | 204.8 | 194.4 | 11.4 | 191.4 | 210.2 | 9.9 | 177.4 | 228.3 | 8.5 | 163.1 | 248.7 | 7.3 |
| | 225 | 221.3 | 215.8 | 11.2 | 207.2 | 233.2 | 9.8 | 192.5 | 253.1 | 8.4 | 177.2 | 275.5 | 7.2 |
| | 250 | 244.1 | 236.8 | 11.2 | 228.8 | 255.9 | 9.8 | 212.8 | 277.7 | 8.5 | 196.1 | 302.3 | 7.2 |
| | 275 | 273.5 | 256.1 | 11.6 | 255.4 | 277.6 | 10.1 | 236.8 | 302.2 | 8.6 | 217.7 | 329.8 | 7.3 |
| | 300 | 306.7 | 294.5 | 11.3 | 286.8 | 318 | 9.9 | 266.1 | 344.9 | 8.5 | 244.8 | 375.2 | 7.3 |
| | 350 | 344.2 | 318.4 | 11.6 | 321.6 | 346 | 10.1 | 298.2 | 377.3 | 8.7 | 274.3 | 412.4 | 7.3 |
| 400 | 413 | 396.6 | 11.3 | 386.3 | 428 | 9.9 | 358.5 | 463.9 | 8.5 | 329.9 | 504.4 | 7.3 | |
| 42 | 140 | 146.6 | 137 | 11.5 | 136.7 | 148.6 | 10 | 126.3 | 161.8 | 8.6 | 115.7 | 176.5 | 7.3 |
| | 155 | 162.3 | 148.2 | 11.8 | 151.4 | 161 | 10.2 | 140.2 | 175.4 | 8.8 | 128.6 | 191.6 | 7.4 |
| | 170 | 176.7 | 159.8 | 11.9 | 165 | 173.7 | 10.3 | 152.9 | 189.5 | 8.8 | 140.5 | 207.1 | 7.5 |
| | 185 | 194 | 178.8 | 11.7 | 181.3 | 193.8 | 10.2 | 168.2 | 210.8 | 8.8 | 154.7 | 229.9 | 7.5 |
| | 200 | 212.6 | 198.7 | 11.6 | 198.7 | 214.6 | 10.1 | 184.3 | 232.8 | 8.7 | 169.5 | 253.2 | 7.4 |
| | 225 | 229.7 | 220.6 | 11.4 | 215.1 | 238.1 | 10 | 199.9 | 258.1 | 8.6 | 184.1 | 280.7 | 7.3 |
| | 250 | 253.3 | 242.1 | 11.4 | 237.5 | 261.3 | 10 | 220.9 | 283.3 | 8.6 | 203.6 | 308.2 | 7.4 |
| | 275 | 284 | 261.5 | 11.8 | 265.4 | 283.2 | 10.3 | 246.2 | 307.9 | 8.8 | 226.5 | 335.6 | 7.5 |
| | 300 | 318.4 | 301 | 11.5 | 297.8 | 324.6 | 10.1 | 276.4 | 351.6 | 8.7 | 254.4 | 382.1 | 7.4 |
| | 350 | 357.3 | 324.9 | 11.8 | 333.9 | 352.7 | 10.3 | 309.9 | 384.1 | 8.9 | 285.2 | 419.4 | 7.5 |
| 400 | 428.4 | 405.3 | 11.5 | 400.8 | 436.8 | 10 | 372.2 | 472.9 | 8.7 | 342.7 | 513.6 | 7.4 | |
| 44 | 140 | 152.3 | 139.9 | 11.8 | 142 | 151.5 | 10.2 | 131.4 | 164.8 | 8.8 | 120.4 | 179.5 | 7.4 |
| | 155 | 168.5 | 151.3 | 12 | 157.3 | 164.1 | 10.4 | 145.7 | 178.6 | 9 | 133.8 | 194.9 | 7.6 |
| | 170 | 183.4 | 163.1 | 12.1 | 171.3 | 177.1 | 10.5 | 158.9 | 192.9 | 9 | 146.1 | 210.6 | 7.7 |
| | 185 | 201.3 | 182.6 | 11.9 | 188.2 | 197.6 | 10.4 | 174.6 | 214.7 | 9 | 160.7 | 233.9 | 7.6 |
| | 200 | 220.5 | 203.1 | 11.8 | 206.2 | 219 | 10.3 | 191.3 | 237.3 | 8.9 | 176 | 257.9 | 7.6 |
| | 225 | 238.2 | 225.6 | 11.6 | 223.2 | 243.2 | 10.1 | 207.5 | 263.3 | 8.8 | 191.2 | 286.1 | 7.5 |
| | 250 | 262.7 | 247.5 | 11.6 | 246.3 | 266.9 | 10.2 | 229.2 | 289.1 | 8.8 | 211.3 | 314.2 | 7.5 |
| | 275 | 294.7 | 267.1 | 12 | 275.5 | 288.9 | 10.5 | 255.7 | 313.7 | 9 | 235.4 | 341.5 | 7.7 |
| | 300 | 330.2 | 307.7 | 11.7 | 308.9 | 331.4 | 10.3 | 286.8 | 358.5 | 8.9 | 264.1 | 389.1 | 7.6 |
| | 350 | 370.5 | 331.6 | 12.1 | 346.5 | 359.5 | 10.5 | 321.8 | 391.1 | 9 | 296.4 | 426.5 | 7.7 |
| 400 | 444.1 | 414.3 | 11.7 | 415.6 | 445.9 | 10.2 | 386.1 | 482.2 | 8.8 | 355.6 | 523 | 7.6 | |

Table 8. 60 Hz high efficiency – I-P units (continued)

| Evap Leaving Water Temp (°F) | Cond Entering Air Temp (°F) | | | | | | | | | | | | |
|---------------------------------------|-----------------------------|-------|--------------------------|------------------|-------|--------------------------|------------------|-------|--------------------------|------------------|-------|--------------------------|------------------|
| | Unit Size | 85 | | | 95 | | | 105 | | | 115 | | |
| | | Tons | kW Input ² | EER ³ | Tons | kW Input ² | EER ³ | Tons | kW Input ² | EER ³ | Tons | kW Input ² | EER ³ |
| 46 | 140 | 158 | 142.8 | 12 | 147.4 | 154.5 | 10.4 | 136.5 | 167.8 | 9 | 125.2 | 182.7 | 7.6 |
| | 155 | 174.8 | 154.4 | 12.2 | 163.2 | 167.3 | 10.6 | 151.3 | 181.9 | 9.2 | 139.1 | 198.2 | 7.8 |
| | 170 | 190.3 | 166.4 | 12.3 | 177.8 | 180.5 | 10.7 | 165 | 196.4 | 9.2 | 151.9 | 214.2 | 7.9 |
| | 185 | 208.6 | 186.5 | 12.1 | 195.1 | 201.6 | 10.6 | 181.2 | 218.7 | 9.1 | 166.9 | 238 | 7.8 |
| | 200 | 228.5 | 207.5 | 12 | 213.7 | 223.6 | 10.5 | 198.4 | 241.9 | 9.1 | 182.7 | 262.6 | 7.7 |
| | 225 | 246.9 | 230.6 | 11.8 | 231.3 | 248.3 | 10.3 | 215.1 | 268.6 | 8.9 | 198.3 | 291.5 | 7.6 |
| | 250 | 272.2 | 253.1 | 11.8 | 255.3 | 272.6 | 10.3 | 237.6 | 295 | 8.9 | 219.1 | 320.4 | 7.7 |
| | 275 | 305.6 | 272.9 | 12.2 | 285.8 | 294.7 | 10.7 | 265.4 | 319.6 | 9.2 | 244.4 | 347.5 | 7.8 |
| | 300 | 342.1 | 314.5 | 11.9 | 320.2 | 338.3 | 10.4 | 297.5 | 365.6 | 9 | 274 | 396.3 | 7.7 |
| | 350 | 384 | 338.5 | 12.3 | 359.3 | 366.5 | 10.7 | 333.9 | 398.2 | 9.2 | 307.8 | 433.7 | 7.9 |
| 48 | 400 | 459.9 | 423.4 | 11.8 | 430.6 | 455.2 | 10.4 | 400.2 | 491.6 | 9 | 368.8 | 532.6 | 7.7 |
| | 140 | 163.9 | 145.8 | 12.2 | 153 | 157.6 | 10.6 | 141.7 | 170.9 | 9.1 | 129 | 184.2 | 7.8 |
| | 155 | 181.2 | 157.6 | 12.5 | 169.3 | 170.6 | 10.8 | 157.1 | 185.2 | 9.3 | 143.7 | 200.4 | 8 |
| | 170 | 197.2 | 169.9 | 12.6 | 184.4 | 184 | 10.9 | 171.2 | 200 | 9.4 | 157.7 | 217.9 | 8 |
| | 185 | 216.1 | 190.5 | 12.3 | 202.2 | 205.6 | 10.8 | 187.9 | 222.8 | 9.3 | 173.1 | 242.2 | 8 |
| | 200 | 236.6 | 212.1 | 12.2 | 221.4 | 228.2 | 10.7 | 205.7 | 246.6 | 9.2 | 189.4 | 267.3 | 7.9 |
| | 225 | 255.7 | 235.8 | 11.9 | 239.6 | 253.6 | 10.5 | 222.9 | 274 | 9.1 | 205.5 | 297.1 | 7.8 |
| | 250 | 281.9 | 258.7 | 12 | 264.5 | 278.4 | 10.5 | 246.1 | 301.1 | 9.1 | 226 | 324.8 | 7.8 |
| | 275 | 316.7 | 278.7 | 12.4 | 296.2 | 300.7 | 10.8 | 275.2 | 325.6 | 9.4 | 253.7 | 353.6 | 8 |
| | 300 | 354.3 | 321.5 | 12.1 | 331.6 | 345.4 | 10.6 | 308.2 | 372.7 | 9.2 | 284.1 | 403.6 | 7.9 |
| 350 | 397.8 | 345.5 | 12.5 | 372.3 | 373.6 | 10.9 | 346.2 | 405.5 | 9.4 | 319.4 | 441 | 8 | |
| 400 | 476 | 432.8 | 12 | 445.8 | 464.7 | 10.6 | 414.5 | 501.2 | 9.2 | 382.1 | 542.4 | 7.9 | |

1. Rated in accordance with AHRI Standard 550/590 based on TOPSS version 140: sea level altitude, evaporator fouling factor of 0.0001 °F-ft²h/Btu, evaporator temperature drop of 10°F, and 2 pass evaporator configuration. Consult a Trane representative for additional performance information.
2. kW input is for compressors only.
3. EER = Energy Efficiency Ratio (Btu/watt-hour). Power inputs include compressors, condenser fans and control power.
4. Interpolation between points is permissible. Extrapolation is not permitted.



Performance Data

Table 9. 60 Hz extra efficiency – I-P units

| Evap Leaving Water Temp (°F) | Unit Size | Cond Entering Air Temp (°F) | | | | | | | | | | | | | | | |
|---------------------------------------|--------------|-----------------------------|--------------------------|------------------|-------|-------|--------------------------|------------------|-------|------|--------------------------|------------------|-----|------|--------------------------|------------------|--|
| | | 85 | | | | 95 | | | | 105 | | | | 115 | | | |
| | | Tons | kW Input ² | EER ³ | | Tons | kW Input ² | EER ³ | | Tons | kW Input ² | EER ³ | | Tons | kW Input ² | EER ³ | |
| 40 | 140 | 146 | 129.3 | 11.8 | 136.1 | 140.2 | 10.3 | 125.8 | 152.6 | 8.8 | 114.9 | 166.6 | 7.5 | | | | |
| | 155 | 160.8 | 140.3 | 12 | 150.1 | 152.4 | 10.5 | 139.1 | 166.2 | 9 | 127.4 | 181.7 | 7.6 | | | | |
| | 170 | 176.3 | 151.7 | 12.2 | 164.7 | 164.9 | 10.6 | 152.8 | 180 | 9.1 | 140.1 | 196.8 | 7.7 | | | | |
| | 185 | 189.4 | 170.9 | 11.8 | 177.2 | 184.9 | 10.3 | 164.6 | 201 | 8.9 | 150.9 | 219 | 7.6 | | | | |
| | 200 | 207.9 | 190 | 11.6 | 194.6 | 205 | 10.2 | 180.9 | 222.2 | 8.8 | 165.7 | 241.5 | 7.5 | | | | |
| | 250 | 234.9 | 206.6 | 12 | 219.3 | 224 | 10.5 | 203.1 | 243.9 | 9 | 185.7 | 266.2 | 7.6 | | | | |
| | 275 | 264 | 229.4 | 12.2 | 246.8 | 249.1 | 10.6 | 229.2 | 271.6 | 9.1 | 210.1 | 296.6 | 7.7 | | | | |
| | 300 | 295.9 | 262.3 | 11.8 | 276.2 | 284.1 | 10.3 | 255.8 | 309.1 | 8.9 | 233.5 | 337 | 7.5 | | | | |
| | 350 | 355.9 | 308.8 | 12.1 | 332.9 | 335 | 10.6 | 309.1 | 365 | 9.1 | 283.2 | 398.4 | 7.7 | | | | |
| 42 | 140 | 151.9 | 131.9 | 12.1 | 141.7 | 142.9 | 10.5 | 131.1 | 155.4 | 9.1 | 119.9 | 169.4 | 7.7 | | | | |
| | 155 | 167.2 | 143.1 | 12.3 | 156.2 | 155.3 | 10.7 | 144.8 | 169.2 | 9.2 | 132.8 | 184.7 | 7.8 | | | | |
| | 170 | 183.3 | 154.7 | 12.5 | 171.4 | 168 | 10.9 | 159.1 | 183.2 | 9.3 | 146 | 200.1 | 7.9 | | | | |
| | 185 | 196.8 | 174.5 | 12.1 | 184.3 | 188.6 | 10.5 | 171.2 | 204.8 | 9.1 | 157.2 | 222.8 | 7.8 | | | | |
| | 200 | 216 | 194.1 | 11.8 | 202.3 | 209.1 | 10.4 | 188.1 | 226.4 | 9 | 172.4 | 245.8 | 7.7 | | | | |
| | 250 | 244.3 | 210.8 | 12.3 | 228.2 | 228.3 | 10.7 | 211.6 | 248.3 | 9.2 | 193.6 | 270.7 | 7.8 | | | | |
| | 275 | 274.4 | 234.1 | 12.4 | 256.7 | 253.8 | 10.8 | 238.5 | 276.4 | 9.3 | 218.9 | 301.5 | 7.9 | | | | |
| | 300 | 307.6 | 267.6 | 12.1 | 287.3 | 289.6 | 10.6 | 266.3 | 314.6 | 9.1 | 243.4 | 342.6 | 7.7 | | | | |
| | 350 | 369.8 | 315 | 12.4 | 346 | 341.4 | 10.8 | 321.6 | 371.4 | 9.3 | 295 | 405 | 7.9 | | | | |
| 44 | 140 | 158 | 134.6 | 12.4 | 147.5 | 145.6 | 10.8 | 136.6 | 158.2 | 9.3 | 125 | 172.3 | 7.9 | | | | |
| | 155 | 173.7 | 146 | 12.5 | 162.4 | 158.2 | 10.9 | 150.7 | 172.2 | 9.4 | 138.3 | 187.7 | 8 | | | | |
| | 170 | 190.4 | 157.9 | 12.7 | 178.1 | 171.2 | 11.1 | 165.5 | 186.4 | 9.6 | 152 | 203.4 | 8.1 | | | | |
| | 185 | 204.4 | 178.2 | 12.3 | 191.5 | 192.3 | 10.8 | 178 | 208.6 | 9.3 | 163.5 | 226.7 | 7.9 | | | | |
| | 200 | 224.2 | 198.4 | 12.1 | 210.1 | 213.4 | 10.6 | 195.5 | 230.8 | 9.2 | 179.3 | 250.2 | 7.9 | | | | |
| | 250 | 253.9 | 215.1 | 12.5 | 237.3 | 232.7 | 11 | 220.2 | 252.8 | 9.4 | 201.7 | 275.2 | 8 | | | | |
| | 275 | 285 | 238.8 | 12.7 | 266.8 | 258.6 | 11.1 | 248.1 | 281.3 | 9.6 | 227.9 | 306.5 | 8.1 | | | | |
| | 300 | 319.6 | 273.1 | 12.4 | 298.7 | 295.1 | 10.8 | 277 | 320.3 | 9.3 | 253.4 | 348.4 | 7.9 | | | | |
| | 350 | 383.9 | 321.4 | 12.6 | 359.5 | 347.9 | 11 | 334.3 | 378 | 9.6 | 307 | 411.6 | 8.1 | | | | |
| 46 | 140 | 164.2 | 137.3 | 12.6 | 153.3 | 148.4 | 11 | 142.1 | 161 | 9.5 | 130.2 | 175.2 | 8.1 | | | | |
| | 155 | 180.4 | 149 | 12.8 | 168.7 | 161.2 | 11.2 | 156.7 | 175.2 | 9.7 | 143.9 | 190.8 | 8.2 | | | | |
| | 170 | 197.7 | 161.1 | 13 | 185 | 174.4 | 11.3 | 172 | 189.7 | 9.8 | 158.2 | 206.7 | 8.3 | | | | |
| | 185 | 212.2 | 182 | 12.5 | 198.8 | 196.2 | 11 | 185 | 212.4 | 9.5 | 170 | 230.6 | 8.1 | | | | |
| | 200 | 232.5 | 202.7 | 12.3 | 218 | 217.8 | 10.8 | 202.9 | 235.2 | 9.4 | 186.3 | 254.7 | 8 | | | | |
| | 250 | 263.7 | 219.6 | 12.8 | 246.6 | 237.2 | 11.2 | 229 | 257.3 | 9.7 | 209.9 | 279.8 | 8.2 | | | | |
| | 275 | 295.9 | 243.7 | 12.9 | 277.1 | 263.6 | 11.3 | 257.8 | 286.2 | 9.8 | 237.1 | 311.5 | 8.3 | | | | |
| | 300 | 331.8 | 278.7 | 12.6 | 310.3 | 300.8 | 11 | 288 | 326 | 9.5 | 263.6 | 354.2 | 8.1 | | | | |
| | 350 | 398.3 | 328 | 12.9 | 373.2 | 354.5 | 11.3 | 347.3 | 384.7 | 9.8 | 319.1 | 418.4 | 8.3 | | | | |

Table 9. 60 Hz extra efficiency – I-P units (continued)

| Evap Leaving Water Temp (°F) | Unit Size | Cond Entering Air Temp (°F) | | | | | | | | | | | |
|---------------------------------------|--------------|-----------------------------|--------------------------|------------------|-------|--------------------------|------------------|-------|--------------------------|------------------|-------|--------------------------|------------------|
| | | 85 | | | 95 | | | 105 | | | 115 | | |
| | | Tons | kW Input ² | EER ³ | Tons | kW Input ² | EER ³ | Tons | kW Input ² | EER ³ | Tons | kW Input ² | EER ³ |
| 48 | 140 | 170.5 | 140.2 | 12.9 | 159.3 | 151.3 | 11.3 | 147.7 | 164 | 9.7 | 135.4 | 178.1 | 8.3 |
| | 155 | 187.2 | 152 | 13.1 | 175.2 | 164.3 | 11.4 | 162.8 | 178.3 | 9.9 | 149.6 | 194 | 8.4 |
| | 170 | 205.1 | 164.3 | 13.2 | 192.1 | 177.7 | 11.6 | 178.6 | 193 | 10 | 164.4 | 210.1 | 8.6 |
| | 185 | 220 | 185.9 | 12.7 | 206.2 | 200.1 | 11.2 | 192 | 216.4 | 9.7 | 176.6 | 234.6 | 8.3 |
| | 200 | 241 | 207.1 | 12.5 | 226.1 | 222.2 | 11 | 210.5 | 239.7 | 9.6 | 193.3 | 259.3 | 8.2 |
| | 250 | 273.7 | 224.1 | 13 | 256.1 | 241.8 | 11.4 | 237.9 | 262 | 9.9 | 218.3 | 284.5 | 8.4 |
| | 275 | 306.9 | 248.7 | 13.2 | 287.6 | 268.6 | 11.6 | 267.7 | 291.3 | 10 | 246.4 | 316.7 | 8.5 |
| | 300 | 344.3 | 284.4 | 12.8 | 322.1 | 306.6 | 11.3 | 299.1 | 331.9 | 9.8 | 273.9 | 360.1 | 8.3 |
| | 350 | 413 | 334.7 | 13.1 | 387.1 | 361.3 | 11.5 | 360.5 | 391.6 | 10 | 331.5 | 425.3 | 8.5 |

1. Rated in accordance with AHRI Standard 550/590 based on TOPSS version 140: sea level altitude, evaporator fouling factor of 0.0001°F-ft²/Btu, evaporator temperature drop of 10°F, and 2 pass evaporator configuration. Consult a Trane representative for additional performance information.
2. kW input is for compressors only.
3. EER = Energy Efficiency Ratio (Btu/watt-hour). Power inputs include compressors, condenser fans and control power.
4. Interpolation between points is permissible. Extrapolation is not permitted.



Performance Data

Table 10. AHRI and Part Load Performance – 60 Hz – I-P units

| Standard efficiency | | | | High efficiency | | | | Extra efficiency | | | |
|---------------------|----------------|---------------|------|-----------------|----------------|---------------|------|------------------|----------------|---------------|------|
| Unit Size | Full Load Tons | Full Load EER | IPLV | Unit Size | Full Load Tons | Full Load EER | IPLV | Unit Size | Full Load Tons | Full Load EER | IPLV |
| 140 | 138.3 | 9.7 | 13.6 | 140 | 142.0 | 10.2 | 13.8 | 140 | 147.5 | 10.8 | 14.3 |
| 155 | 151.9 | 9.8 | 14.0 | 155 | 157.3 | 10.4 | 14.5 | 155 | 162.4 | 10.9 | 14.9 |
| 170 | 166.1 | 9.9 | 14.0 | 170 | 171.3 | 10.5 | 14.5 | 170 | 178.1 | 11.1 | 14.9 |
| 185 | 182.0 | 9.8 | 13.9 | 185 | 188.2 | 10.4 | 14.3 | 185 | 191.4 | 10.8 | 14.8 |
| 200 | 198.9 | 9.7 | 13.6 | 200 | 206.1 | 10.3 | 14.1 | 200 | 210.1 | 10.6 | 14.1 |
| 225 | 218.6 | 9.7 | 13.9 | 225 | 223.2 | 10.1 | 14.1 | 250 | 237.3 | 11.0 | 14.8 |
| 250 | 240.1 | 9.7 | 13.7 | 250 | 246.3 | 10.2 | 14.0 | 275 | 266.8 | 11.1 | 15.2 |
| 275 | 266.2 | 9.8 | 14.6 | 275 | 275.5 | 10.5 | 14.8 | 300 | 298.7 | 10.8 | 14.8 |
| 300 | 298.9 | 9.7 | 14.2 | 300 | 308.9 | 10.3 | 14.4 | 350 | 359.5 | 11.0 | 15.3 |
| 350 | 340.0 | 9.6 | 14.3 | 350 | 346.5 | 10.5 | 15.4 | | | | |
| 400 | 401.3 | 9.7 | 14.7 | 400 | 415.6 | 10.2 | 14.7 | | | | |
| 450 | 441.8 | 9.6 | 15.0 | | | | | | | | |
| 500 | 483.9 | 9.6 | 15.0 | | | | | | | | |

1. IPLV values are rated in accordance with AHRI Standard 550/590 and based on TOPSS version 140.
2. EER and IPLV values include compressors, condenser fans, and control kW.

Table 11. 60 Hz standard efficiency – SI units

| Evap Leaving Water Temp (°C) | Cond Entering Air Temp (°C) | | | | | | | | | | | | | |
|--|-----------------------------|---------------|--------------------------|------------------|---------------|--------------------------|------------------|---------------|--------------------------|------------------|---------------|--------------------------|------------------|------|
| | Unit Size | 30 | | | 35 | | | 40 | | | 45 | | | |
| | | kW Cooling | kW Input ² | COP ³ | kW Cooling | kW Input ² | COP ³ | kW Cooling | kW Input ² | COP ³ | kW Cooling | kW Input ² | COP ³ | |
| 5 | 140 | 490.83 | 142.2 | 3.17 | 459.54 | 153.4 | 2.77 | 427.19 | 165.8 | 2.4 | 394.14 | 179.5 | 2.06 | |
| | 155 | 538.65 | 154.3 | 3.2 | 504.55 | 166.6 | 2.8 | 469.74 | 180.1 | 2.42 | 434.23 | 195.1 | 2.08 | |
| | 170 | 588.58 | 166.8 | 3.23 | 552.36 | 180.1 | 2.83 | 515.09 | 194.9 | 2.45 | 477.12 | 211.2 | 2.11 | |
| | 185 | 645.19 | 185.3 | 3.19 | 605.46 | 199.7 | 2.8 | 565.02 | 215.6 | 2.43 | 523.53 | 233.3 | 2.1 | |
| | 200 | 705.31 | 204.6 | 3.16 | 662.41 | 220 | 2.78 | 617.76 | 237.1 | 2.42 | 572.05 | 256.1 | 2.09 | |
| | 225 | 774.58 | 225.6 | 3.15 | 728.16 | 242.6 | 2.78 | 679.99 | 261.5 | 2.42 | 630.42 | 282.5 | 2.09 | |
| | 250 | 849.47 | 247.8 | 3.16 | 799.19 | 266.2 | 2.78 | 746.8 | 286.9 | 2.43 | 692.65 | 309.8 | 2.1 | |
| | 275 | 942.99 | 271.1 | 3.19 | 885.33 | 291.9 | 2.8 | 826.26 | 315.1 | 2.44 | 765.79 | 340.8 | 2.1 | |
| | 300 | 1059.72 | 310.2 | 3.13 | 995.03 | 333 | 2.76 | 928.93 | 358.6 | 2.41 | 860.72 | 386.9 | 2.08 | |
| | 350 | 1203.53 | 355 | 3.12 | 1131.8 | 380.8 | 2.75 | 1057.26 | 409.8 | 2.41 | 980.61 | 441.9 | 2.08 | |
| | 400 | 1423.28 | 417.1 | 3.13 | 1337.49 | 447.6 | 2.76 | 1248.88 | 481.7 | 2.41 | 1157.82 | 519.6 | 2.09 | |
| | 450 | 1565.32 | 461.6 | 3.12 | 1472.5 | 495.2 | 2.75 | 1376.51 | 532.9 | 2.41 | 1277.36 | 574.7 | 2.08 | |
| | 500 | 1713.35 | 507.4 | 3.11 | 1612.79 | 544 | 2.75 | 1508.01 | 585 | 2.41 | 1399.72 | 630.7 | 2.08 | |
| | 7 | 140 | 524.24 | 147.6 | 3.27 | 490.83 | 159 | 2.87 | 456.73 | 171.5 | 2.49 | 421.92 | 185.4 | 2.14 |
| | | 155 | 575.22 | 160.3 | 3.3 | 539.35 | 172.6 | 2.89 | 502.44 | 186.3 | 2.51 | 465.17 | 201.5 | 2.16 |
| 170 | | 627.96 | 173.2 | 3.33 | 589.63 | 186.6 | 2.92 | 550.61 | 201.6 | 2.54 | 510.88 | 218 | 2.19 | |
| 185 | | 687.73 | 192.6 | 3.28 | 645.89 | 207.1 | 2.89 | 603.35 | 223.2 | 2.52 | 559.4 | 241.1 | 2.17 | |
| 200 | | 751.72 | 212.9 | 3.25 | 706.01 | 228.4 | 2.86 | 659.25 | 245.7 | 2.5 | 610.73 | 264.9 | 2.16 | |
| 225 | | 825.21 | 234.7 | 3.24 | 775.98 | 251.9 | 2.86 | 725 | 271.2 | 2.5 | 672.61 | 292.5 | 2.16 | |
| 250 | | 905.37 | 257.9 | 3.24 | 851.93 | 276.7 | 2.86 | 796.37 | 297.8 | 2.5 | 738.36 | 321.2 | 2.16 | |
| 275 | | 1005.58 | 281.7 | 3.28 | 944.75 | 302.7 | 2.89 | 882.52 | 326.2 | 2.52 | 818.53 | 352.1 | 2.18 | |
| 300 | | 1128.99 | 322.8 | 3.22 | 1060.43 | 345.8 | 2.84 | 990.46 | 371.6 | 2.48 | 918.38 | 400.2 | 2.15 | |
| 350 | | 1282.64 | 369.7 | 3.2 | 1205.99 | 395.9 | 2.83 | 1126.88 | 425.3 | 2.48 | 1045.31 | 457.9 | 2.15 | |
| 9 | 140 | 1514.69 | 433.8 | 3.22 | 1423.98 | 464.7 | 2.84 | 1330.45 | 499.2 | 2.49 | 1234.12 | 537.4 | 2.15 | |
| | 155 | 1665.88 | 480.4 | 3.2 | 1567.43 | 514.5 | 2.83 | 1465.82 | 552.8 | 2.48 | 1360.34 | 595.2 | 2.15 | |
| | 170 | 1824.1 | 528.4 | 3.19 | 1717.22 | 565.7 | 2.83 | 1605.76 | 607.5 | 2.47 | 1490.43 | 654 | 2.14 | |
| | 185 | 1937.67 | 550.5 | 3.27 | 1824.1 | 588.4 | 2.89 | 1705.61 | 631 | 2.54 | 1567.78 | 668.8 | 2.21 | |
| | 200 | 558.34 | 153.4 | 3.37 | 523.18 | 164.8 | 2.96 | 487.32 | 177.5 | 2.57 | 450.4 | 191.4 | 2.21 | |
| | 155 | 612.49 | 166.5 | 3.4 | 574.87 | 178.9 | 2.98 | 536.19 | 192.8 | 2.6 | 496.46 | 208 | 2.24 | |
| | 170 | 668.39 | 179.8 | 3.42 | 628.31 | 193.4 | 3.01 | 587.17 | 208.5 | 2.63 | 544.98 | 225 | 2.27 | |
| | 185 | 731.33 | 200.1 | 3.37 | 687.38 | 214.8 | 2.97 | 642.37 | 231.1 | 2.59 | 596.31 | 249.1 | 2.25 | |
| | 200 | 798.84 | 221.4 | 3.33 | 750.67 | 237.1 | 2.94 | 701.09 | 254.6 | 2.57 | 650.46 | 273.9 | 2.23 | |
| | 225 | 876.89 | 244.2 | 3.32 | 825.21 | 261.7 | 2.93 | 771.06 | 281.2 | 2.57 | 715.51 | 302.8 | 2.22 | |

1. Ratings based on TOPSS version 140: evaporator fouling factor of 0.01761m²°C/kW, evaporator temperature drop of 5°C, and 2 pass evaporator configuration. Consult Trane representative for additional performance information.

2. kW input is for compressors only.

3. COP = Coefficient of Performance. Power inputs include compressors and control power.

4. Interpolation between points is permissible. Extrapolation is not permitted.



Performance Data

Table 12. 60 Hz high efficiency – SI units

| Evap Leaving Water Temp (°C) | Cond Entering Air Temp (°C) | | | | | | | | | | | | |
|--|-----------------------------|---------------|--------------------------|------------------|---------------|--------------------------|------------------|---------------|--------------------------|------------------|---------------|--------------------------|------------------|
| | 30 | | | 35 | | | 40 | | | 45 | | | |
| | Unit Size | kW Cooling | kW Input ² | COP ³ | kW Cooling | kW Input ² | COP ³ | kW Cooling | kW Input ² | COP ³ | kW Cooling | kW Input ² | COP ³ |
| 5 | 140 | 501.73 | 136.7 | 3.29 | 470.79 | 147.1 | 2.9 | 438.8 | 158.9 | 2.52 | 406.1 | 171.9 | 2.17 |
| | 155 | 555.88 | 147.8 | 3.37 | 521.77 | 159.4 | 2.96 | 486.97 | 172.3 | 2.58 | 451.1 | 186.6 | 2.22 |
| | 170 | 605.1 | 159.4 | 3.4 | 568.54 | 172 | 2.99 | 530.92 | 186.1 | 2.6 | 492.59 | 201.7 | 2.24 |
| | 185 | 664.52 | 178.3 | 3.35 | 624.79 | 191.8 | 2.95 | 584.01 | 206.9 | 2.58 | 542.17 | 223.8 | 2.23 |
| | 200 | 727.81 | 197.9 | 3.32 | 684.92 | 212.3 | 2.93 | 640.26 | 228.5 | 2.57 | 594.2 | 246.5 | 2.22 |
| | 225 | 786.88 | 219.7 | 3.27 | 741.52 | 235.5 | 2.89 | 694.41 | 253.3 | 2.53 | 645.54 | 273.3 | 2.2 |
| | 250 | 867.75 | 241 | 3.27 | 818.53 | 258.4 | 2.9 | 767.19 | 278 | 2.54 | 713.75 | 299.9 | 2.21 |
| | 275 | 972.53 | 260.6 | 3.37 | 914.51 | 280.2 | 2.97 | 854.74 | 302.2 | 2.6 | 793.91 | 326.8 | 2.25 |
| | 300 | 1090.31 | 299.7 | 3.3 | 1025.97 | 321 | 2.92 | 959.87 | 345.1 | 2.56 | 891.66 | 372.1 | 2.22 |
| | 350 | 1223.92 | 324.1 | 3.39 | 1151.14 | 349.1 | 2.98 | 1076.25 | 377.2 | 2.6 | 999.95 | 408.4 | 2.25 |
| 400 | 1467.93 | 403.6 | 3.29 | 1382.14 | 432.1 | 2.91 | 1293.19 | 464.3 | 2.55 | 1201.77 | 500.3 | 2.22 | |
| 7 | 140 | 537.25 | 141.8 | 3.41 | 504.55 | 152.3 | 3.01 | 470.79 | 164.2 | 2.62 | 435.98 | 177.3 | 2.27 |
| | 155 | 594.56 | 153.3 | 3.49 | 558.69 | 165 | 3.07 | 522.13 | 178 | 2.68 | 484.15 | 192.4 | 2.32 |
| | 170 | 647.3 | 165.3 | 3.52 | 608.62 | 178 | 3.1 | 568.89 | 192.2 | 2.71 | 528.46 | 207.9 | 2.34 |
| | 185 | 709.88 | 185.1 | 3.46 | 668.04 | 198.7 | 3.06 | 625.15 | 214 | 2.68 | 580.84 | 231 | 2.32 |
| | 200 | 777.39 | 205.7 | 3.42 | 731.68 | 220.2 | 3.03 | 684.57 | 236.6 | 2.66 | 636.04 | 254.8 | 2.31 |
| | 225 | 840.32 | 228.5 | 3.36 | 792.16 | 244.5 | 2.98 | 742.23 | 262.6 | 2.62 | 690.54 | 282.8 | 2.28 |
| | 250 | 926.82 | 250.8 | 3.37 | 874.43 | 268.4 | 2.99 | 819.93 | 288.3 | 2.63 | 762.97 | 310.5 | 2.28 |
| | 275 | 1039.68 | 270.7 | 3.48 | 978.15 | 290.4 | 3.08 | 915.22 | 312.6 | 2.7 | 850.52 | 337.3 | 2.34 |
| | 300 | 1164.15 | 311.7 | 3.4 | 1096.29 | 333.2 | 3.02 | 1025.97 | 357.5 | 2.65 | 953.89 | 384.6 | 2.3 |
| | 350 | 1306.9 | 336.1 | 3.5 | 1230.25 | 361.4 | 3.09 | 1151.49 | 389.7 | 2.7 | 1071.33 | 421.1 | 2.35 |
| 400 | 1566.03 | 419.7 | 3.38 | 1475.31 | 448.4 | 3.01 | 1381.44 | 480.8 | 2.64 | 1284.75 | 517.1 | 2.3 | |
| 9 | 140 | 573.81 | 147.1 | 3.53 | 539 | 157.8 | 3.11 | 503.49 | 169.7 | 2.72 | 466.92 | 182.9 | 2.36 |
| | 155 | 634.64 | 159 | 3.6 | 597.02 | 170.8 | 3.18 | 557.99 | 183.9 | 2.78 | 518.26 | 198.4 | 2.41 |
| | 170 | 690.54 | 171.5 | 3.63 | 649.76 | 184.3 | 3.21 | 608.27 | 198.6 | 2.81 | 565.72 | 214.4 | 2.44 |
| | 185 | 757 | 192.2 | 3.57 | 712.69 | 205.9 | 3.16 | 667.34 | 221.3 | 2.77 | 620.93 | 238.4 | 2.41 |
| | 200 | 828.37 | 213.9 | 3.52 | 780.2 | 228.5 | 3.12 | 730.27 | 245 | 2.75 | 678.94 | 263.3 | 2.39 |
| | 225 | 895.53 | 237.8 | 3.46 | 844.54 | 254 | 3.07 | 791.45 | 272.2 | 2.7 | 736.6 | 292.6 | 2.35 |
| | 250 | 987.29 | 261 | 3.46 | 932.09 | 278.8 | 3.08 | 874.08 | 299.1 | 2.71 | 813.6 | 321.7 | 2.36 |
| | 275 | 1108.6 | 281.2 | 3.59 | 1043.9 | 301.1 | 3.18 | 977.45 | 323.4 | 2.79 | 909.24 | 348.2 | 2.43 |
| | 300 | 1240.45 | 324.2 | 3.5 | 1168.37 | 345.8 | 3.11 | 1094.18 | 370.3 | 2.74 | 1018.23 | 397.5 | 2.39 |
| | 350 | 1393.04 | 348.6 | 3.61 | 1312.17 | 374.1 | 3.19 | 1229.55 | 402.6 | 2.8 | 1144.81 | 434.1 | 2.44 |
| 400 | 1666.94 | 436.4 | 3.48 | 1570.95 | 465.3 | 3.09 | 1471.8 | 498 | 2.73 | 1369.83 | 534.4 | 2.38 | |

1. Ratings based on TOPSS version 140: evaporator fouling factor of 0.01761m²°C/kW, evaporator temperature drop of 5°C, and 2 pass evaporator configuration. Consult Trane representative for additional performance information.
2. kW input is for compressors only.
3. COP = Coefficient of Performance. Power inputs include compressors and control power.
4. Interpolation between points is permissible. Extrapolation is not permitted.

Table 13. 60 Hz extra efficiency — SI units

| Evap Leaving Water Temp (°C) | Cond Entering Air Temp (°C) | | | | | | | | | | | | |
|--|-----------------------------|---------------|--------------------------|------------------|---------------|--------------------------|------------------|---------------|--------------------------|------------------|---------------|--------------------------|------------------|
| | 30 | | | 35 | | | 40 | | | 45 | | | |
| | Unit Size | kW Cooling | kW Input ² | COP ³ | kW Cooling | kW Input ² | COP ³ | kW Cooling | kW Input ² | COP ³ | kW Cooling | kW Input ² | COP ³ |
| 5 | 140 | 519.66 | 131.5 | 3.46 | 488.02 | 141.5 | 3.05 | 455.32 | 152.7 | 2.66 | 421.57 | 165.1 | 2.3 |
| | 155 | 572.05 | 142.8 | 3.51 | 537.95 | 153.8 | 3.1 | 502.44 | 166.2 | 2.7 | 466.22 | 180 | 2.34 |
| | 170 | 627.25 | 154.4 | 3.56 | 589.98 | 166.4 | 3.14 | 552.01 | 179.9 | 2.75 | 512.63 | 194.9 | 2.38 |
| | 185 | 674.02 | 173.9 | 3.45 | 634.64 | 186.7 | 3.05 | 594.2 | 201.1 | 2.68 | 552.01 | 217.1 | 2.32 |
| | 200 | 739.41 | 193.3 | 3.39 | 696.87 | 206.9 | 3.01 | 652.92 | 222.3 | 2.65 | 605.46 | 239.5 | 2.3 |
| | 250 | 835.75 | 210.2 | 3.51 | 785.83 | 226 | 3.1 | 734.14 | 243.9 | 2.71 | 680.35 | 263.8 | 2.34 |
| | 275 | 939.12 | 233.4 | 3.55 | 883.92 | 251.3 | 3.14 | 827.67 | 271.4 | 2.75 | 768.6 | 293.7 | 2.38 |
| | 300 | 1053.04 | 266.9 | 3.46 | 989.75 | 286.7 | 3.06 | 924.71 | 309.1 | 2.68 | 855.79 | 334 | 2.31 |
| 350 | 1266.11 | 314.2 | 3.54 | 1192.28 | 338 | 3.13 | 1116.33 | 364.9 | 2.74 | 1036.17 | 394.7 | 2.37 | |
| 7 | 140 | 557.64 | 136.4 | 3.6 | 524.24 | 146.4 | 3.18 | 489.43 | 157.6 | 2.78 | 453.92 | 170.2 | 2.41 |
| | 155 | 613.19 | 148 | 3.65 | 576.98 | 159 | 3.22 | 539.71 | 171.5 | 2.82 | 501.38 | 185.4 | 2.45 |
| | 170 | 671.91 | 160 | 3.7 | 632.88 | 172.1 | 3.27 | 592.45 | 185.7 | 2.87 | 551.31 | 200.8 | 2.49 |
| | 185 | 721.48 | 180.5 | 3.57 | 679.99 | 193.4 | 3.17 | 637.45 | 207.9 | 2.79 | 592.45 | 224.1 | 2.42 |
| | 200 | 791.1 | 200.9 | 3.51 | 746.1 | 214.6 | 3.12 | 699.33 | 230.1 | 2.75 | 649.05 | 247.4 | 2.4 |
| | 250 | 896.23 | 217.9 | 3.65 | 843.14 | 233.9 | 3.23 | 788.64 | 251.9 | 2.83 | 731.68 | 271.9 | 2.45 |
| | 275 | 1005.58 | 242 | 3.69 | 947.56 | 259.9 | 3.26 | 887.79 | 280.2 | 2.86 | 825.91 | 302.6 | 2.49 |
| | 300 | 1127.93 | 276.7 | 3.59 | 1061.13 | 296.6 | 3.18 | 992.22 | 319.2 | 2.79 | 919.43 | 344.2 | 2.42 |
| 350 | 1354.71 | 325.7 | 3.67 | 1277.01 | 349.6 | 3.25 | 1196.85 | 376.6 | 2.86 | 1112.46 | 406.6 | 2.48 | |
| 9 | 140 | 597.02 | 141.4 | 3.73 | 561.51 | 151.5 | 3.31 | 524.94 | 162.8 | 2.9 | 487.32 | 175.5 | 2.52 |
| | 155 | 655.73 | 153.4 | 3.78 | 617.41 | 164.5 | 3.35 | 578.38 | 177 | 2.94 | 537.6 | 191 | 2.56 |
| | 170 | 718.32 | 165.8 | 3.83 | 676.83 | 178 | 3.4 | 634.29 | 191.6 | 2.98 | 590.69 | 206.8 | 2.6 |
| | 185 | 770.71 | 187.4 | 3.69 | 727.11 | 200.4 | 3.28 | 681.75 | 214.9 | 2.89 | 634.29 | 231.2 | 2.52 |
| | 200 | 844.19 | 208.8 | 3.62 | 796.73 | 222.5 | 3.23 | 747.5 | 238.1 | 2.85 | 694.06 | 255.5 | 2.49 |
| | 250 | 958.46 | 226 | 3.78 | 902.56 | 242.1 | 3.35 | 845.25 | 260.1 | 2.94 | 784.77 | 280.2 | 2.56 |
| | 275 | 1074.84 | 250.9 | 3.82 | 1013.31 | 268.9 | 3.39 | 950.37 | 289.2 | 2.98 | 884.98 | 311.8 | 2.59 |
| | 300 | 1205.64 | 286.9 | 3.72 | 1135.32 | 307 | 3.3 | 1062.54 | 329.6 | 2.9 | 985.18 | 354.7 | 2.52 |
| 350 | 1446.48 | 337.6 | 3.8 | 1364.56 | 361.7 | 3.37 | 1280.18 | 388.8 | 2.97 | 1190.87 | 418.9 | 2.59 | |

1. Ratings based on TOPSS version 140: evaporator fouling factor of 0.01761m²°C/kW, evaporator temperature drop of 5°C, and 2 pass evaporator configuration. Consult Trane representative for additional performance information.

2. kW input is for compressors only.

3. COP = Coefficient of Performance. Power inputs include compressors and control power.

4. Interpolation between points is permissible. Extrapolation is not permitted.



Controls

LCD Touch Screen Display

The standard DynaView display provided with the Trane CH530 control panel features an LCD touch screen that is navigated by file tabs. This is an advanced interface that allows the user to access any important information concerning setpoints, active temperatures, modes, electrical data, pressure, and diagnostics. It uses full text display available in 19 languages.

Display Features Include:

- LCD touch screen with LED backlighting, for scrolling access to input and output operating information
- Single screen, folder/tab style display of all available information on individual components (evaporator, condenser, compressor, etc.)
- Password entry/lockout system to enable or disable display
- Automatic and immediate stop capabilities for standard or immediate manual shutdown
- Fast, easy access to available chiller data in tabbed format, including:
 - Modes of operation, including normal cooling as well as ice making
 - Water temperatures and setpoints
 - Loading and limiting status and setpoints
 - Outdoor air temperature
 - Start/stop differential timers
 - Pump status and override
 - Chilled water reset settings
- Optional external setpoints, including:
 - Chilled water, demand limit, ice building

Reports, listed on a single tabbed screen for easy access, including:

- ASHRAE, containing all guideline 3 report information
- Evaporator, condenser, compressor

Evaporator, condenser, and compressor reports containing all operational information on individual components, including:

- Water temperatures, refrigerant pressures, temperatures, and approach
- Flow switch status, EXV position, compressor starts and run time

Alarm and diagnostic information, including:

- Flashing alarms with touch screen button for immediate address of alarm condition
- Scrollable list of last ten active diagnostics
- Specific information on applicable diagnostic from list of over one hundred
- Automatic or manual resetting diagnostic types

Adaptive Controls

Adaptive Controls directly sense the control variables that govern the operation of the chiller: evaporator pressure and condenser pressure. When any one of these variables approaches a limit condition when damage may occur to the unit or shutdown on a safety, Adaptive Controls takes corrective action to avoid shutdown and keep the chiller operating. This happens through combined actions of compressor and/or fan staging. Whenever possible, the chiller is allowed to continue making chilled water. This keeps cooling capacity available until the problem can be solved. Overall, the safety controls help keep the building or process running and out of trouble.

Stand Alone Controls

Single chillers installed in applications without a building management system is simple to install and control: only a remote auto/stop for scheduling is required for unit operation. Signals from the chilled water pump contactor auxiliary, or a flow switch, are wired to the chilled water flow interlock. Signals from a time clock or some other remote device are wired to the external auto/stop input.

- External Auto/Stop - A job site provided contact closure will turn the unit on and off.
- Chilled Water Flow Interlock - A job site provided contact closure from a chilled water pump contactor or a flow switch is required and will allow unit operation if a load exists. This feature will allow the unit to run in conjunction with the pump system.
- External Interlock - A job site supplied contact opening wired to this input will turn the unit off and require a manual reset of the unit microcomputer. This closure is typically triggered by a job site supplied system such as a fire alarm.
- Chilled Water Pump Control - Unit controls provide an output to control the chilled water pump(s). One contact closure to the chiller is all that is required to initiate the chilled water system. Chilled water pump control by the chiller is a requirement on the Air-Cooled Series R.
- Chilled Water Temperature Reset - The reset can be based on return water temperature or outdoor air temperature.

Hardwire Points

Microcomputer controls allow simple interface with other control systems, such as time clocks, building automation systems, and ice storage systems via hardwire points. This means you have the flexibility to meet job requirements while not having to learn a complicated control system.

Remote devices are wired from the control panel to provide auxiliary control to a building automation system. Inputs and outputs can be communicated via a typical 4–20 mA electrical signal, an equivalent 2–10 Vdc signal, or by utilizing contact closures. Contact closures may be used to trigger job site supplied alarm lights or alarm bells.

This setup has the same features as a stand alone water chiller, with the possibility of having additional optional features:

- Circuit enable/disable
- Ice making enable/status
- External chilled water setpoint, external demand limit setpoint
- Alarm indication contacts provides three single pole double throw contact closures to indicate: compressor on/off status, compressor running at maximum capacity, failure has occurred (ckt 1/ckt 2)

BACnet Interface

BACnet interface capabilities are available, with communication link via single twisted-pair wiring to a factory-installed and tested communication board.

Required features:

- BACnet Interface (selectable option with chiller)

BACnet is a data communication protocol for building automation and control networks developed by American Society of Heating, Refrigerating and Air-Conditioning Engineers (ASHRAE).

LonTalk LCI-C Interface

LonTalk (LCI-C) communications capabilities are available, with communication link via single twisted pair wiring to factory installed, tested communication board.

- Required features: LonTalk/Tracer Summit Interface (selectable option with chiller)



Controls

LonTalk is a communications protocol developed by the Echelon Corporation. The LonMark association develops control profiles using the LonTalk communication protocol. LonTalk is a unit level communications protocol.

LonTalk Communications Interface for Chillers (LCI-C) provides a generic automation system with the LonMark chiller profile inputs/outputs. In addition to the standard points, Trane provides other commonly used network output variables for greater interoperability with any automation system. The complete reference list of Trane LonTalk points is available on the LonMark web site.

Trane controls or another vendor's system can use the predefined list of points with ease to give the operator a complete picture of how the system is running

Tracer Summit

The chiller plant control capabilities of the Trane Tracer Summit building automation system are unequaled in the industry. Trane's depth of experience in chillers and controls makes us a well qualified choice for automation of chiller plants using air-cooled chillers. Our chiller plant automation software is fully pre-engineered and tested.

Required features:

- LonTalk/Tracer Summit Interface (selectable option with chiller)
- Building Control Unit (external device required)

Energy Efficiency

- Sequences starting of chillers to optimize the overall chiller plant energy efficiency
 - Individual chillers operate as base, peak, or swing based on capacity and efficiency
 - Automatically rotates individual chiller operation to equalize runtime and wear between chillers.
 - Evaluates and selects the lowest energy consumption alternative from an overall system perspective.

Easy Operation and Maintenance

- Remote monitoring and control
- Displays both current operation conditions and scheduled automated control actions
- Concise reports assist in planning for preventative maintenance and verifying performance
- Alarm notification and diagnostic messages aid in quick and accurate troubleshooting

Tracer SC

The Tracer SC system controller acts as the central coordinator for all individual equipment devices on a Tracer building automation system. The Tracer SC scans all unit controllers to update information and coordinate building control, including building subsystems such as VAV and chiller water systems. With this system option, the full breadth of Trane's HVAC and controls experience are applied to offer solutions to many facility issues. The LAN allows building operators to manage these varied components as one system from any personal computer with web access. The benefits of this system are:

- Improved usability with automatic data collection, enhanced data logging, easier to create graphics, simpler navigation, pre-programmed scheduling, reporting, and alarm logs.
- Flexible technology allows for system sizes from 30-120 unit controllers with any combination of LonTalk or BACnet unit controllers.
- LEED certification through site commissioning report, energy data collection measurement, optimizing energy performance, and maintaining indoor air quality.
- Energy savings programs include: fan pressure optimization, ventilation reset, and chiller plant control (adds and subtracts chillers to meet cooling loads).



Electrical Data

Table 14. Standard efficiency – all ambient options

| Unit Size | Rated Voltage ¹ | # Power Conn ² | # Comp | # Fan Ckt1/ Ckt2 | Fan kW | Fan FLA | VFD Input | Cntrl kVA ³ | RLA ⁴ Ckt1/Ckt2 | XLRA ⁵ Ckt1/Ckt2 | YLRA ⁵ Ckt1/Ckt2 | MCA ⁶ Ckt1/ Ckt2 | MOP ⁷ Ckt1/ Ckt2 |
|-----------|----------------------------|---------------------------|--------|---------------------|--------|---------|-----------|------------------------|-------------------------------|--------------------------------|--------------------------------|-----------------------------------|-----------------------------------|
| 140 | 200/60/3 | 1 | 2 | 8 | 1.5 | 6.5 | 7.3 | 0.83 | 270/270 | 1845/1845 | 600/600 | 665 | 800 |
| | | 2 | 2 | 4/4 | 1.5 | 6.5 | 7.3 | 0.83 | 270/270 | 1845/1845 | 600/600 | 368/364 | 600/600 |
| | 230/60/3 | 1 | 2 | 8 | 1.5 | 6.5 | 7.3 | 0.83 | 235/235 | 1556/1556 | 506/506 | 586 | 800 |
| | | 2 | 2 | 4/4 | 1.5 | 6.5 | 7.3 | 0.83 | 235/235 | 1556/1556 | 506/506 | 324/321 | 500/500 |
| | 380/60/3 | 1 | 2 | 8 | 1.5 | 3.5 | 3.7 | 0.83 | 142/142 | 973/973 | 316/316 | 350 | 450 |
| | | 2 | 2 | 4/4 | 1.5 | 3.5 | 3.7 | 0.83 | 142/142 | 973/973 | 316/316 | 194/192 | 300/300 |
| | 460/60/3 | 1 | 2 | 8 | 1.5 | 3 | 3.7 | 0.83 | 118/118 | 774/774 | 252/252 | 293 | 400 |
| | | 2 | 2 | 4/4 | 1.5 | 3 | 3.7 | 0.83 | 118/118 | 774/774 | 252/252 | 162/160 | 250/250 |
| 575/60/3 | 1 | 2 | 8 | 1.5 | 2.5 | 3.0 | 0.83 | 94/94 | 631/631 | 205/205 | 234 | 300 | |
| | 2 | 2 | 4/4 | 1.5 | 2.5 | 3.0 | 0.83 | 94/94 | 631/631 | 205/205 | 129/128 | 200/200 | |
| 155 | 200/60/3 | 1 | 2 | 9 | 1.5 | 6.5 | 7.3 | 0.83 | 320/270 | 2156/1845 | 701/600 | 734 | 1000 |
| | 200/60/3 | 2 | 2 | 5/4 | 1.5 | 6.5 | 7.3 | 0.83 | 320/270 | 2156/1845 | 701/600 | 437/364 | 700/600 |
| | 230/60/3 | 1 | 2 | 9 | 1.5 | 6.5 | 7.3 | 0.83 | 278/235 | 1756/1556 | 571/506 | 646 | 800 |
| | 230/60/3 | 2 | 2 | 5/4 | 1.5 | 6.5 | 7.3 | 0.83 | 278/235 | 1756/1556 | 571/506 | 384/321 | 600/500 |
| | 380/60/3 | 1 | 2 | 9 | 1.5 | 3.5 | 3.7 | 0.83 | 168/142 | 1060/973 | 345/316 | 386 | 500 |
| | 380/60/3 | 2 | 2 | 5/4 | 1.5 | 3.5 | 3.7 | 0.83 | 168/142 | 1060/973 | 345/316 | 230/192 | 350/300 |
| | 460/60/3 | 1 | 2 | 9 | 1.5 | 3 | 3.7 | 0.83 | 139/118 | 878/774 | 285/252 | 322 | 450 |
| | 460/60/3 | 2 | 2 | 5/4 | 1.5 | 3 | 3.7 | 0.83 | 139/118 | 878/774 | 285/252 | 191/160 | 300/250 |
| | 575/60/3 | 1 | 2 | 9 | 1.5 | 2.5 | 3.0 | 0.83 | 111/94 | 705/631 | 229/205 | 258 | 350 |
| | 575/60/3 | 2 | 2 | 5/4 | 1.5 | 2.5 | 3.0 | 0.83 | 111/94 | 705/631 | 229/205 | 153/128 | 250/200 |
| 170 | 200/60/3 | 1 | 2 | 10 | 1.5 | 6.5 | 7.3 | 0.83 | 320/320 | 2156/2156 | 701/701 | 791 | 1000 |
| | 200/60/3 | 2 | 2 | 5/5 | 1.5 | 6.5 | 7.3 | 0.83 | 320/320 | 2156/2156 | 701/701 | 437/433 | 700/700 |
| | 230/60/3 | 1 | 2 | 10 | 1.5 | 6.5 | 7.3 | 0.83 | 278/278 | 1756/1756 | 571/571 | 696 | 800 |
| | 230/60/3 | 2 | 2 | 5/5 | 1.5 | 6.5 | 7.3 | 0.83 | 278/278 | 1756/1756 | 571/571 | 384/381 | 600/600 |
| | 380/60/3 | 1 | 2 | 10 | 1.5 | 3.5 | 3.7 | 0.83 | 168/168 | 1060/1060 | 345/345 | 416 | 500 |
| | 380/60/3 | 2 | 2 | 5/5 | 1.5 | 3.5 | 3.7 | 0.83 | 168/168 | 1060/1060 | 345/345 | 230/228 | 350/350 |
| | 460/60/3 | 1 | 2 | 10 | 1.5 | 3 | 3.7 | 0.83 | 139/139 | 878/878 | 285/285 | 346 | 450 |
| | 460/60/3 | 2 | 2 | 5/5 | 1.5 | 3 | 3.7 | 0.83 | 139/139 | 878/878 | 285/285 | 191/189 | 300/300 |
| | 575/60/3 | 1 | 2 | 10 | 1.5 | 2.5 | 3.0 | 0.83 | 111/111 | 705/705 | 229/229 | 277 | 350 |
| | 575/60/3 | 2 | 2 | 5/5 | 1.5 | 2.5 | 3.0 | 0.83 | 111/111 | 705/705 | 229/229 | 153/152 | 250/250 |
| 185 | 200/60/3 | 1 | 2 | 11 | 1.5 | 6.5 | 7.3 | 0.83 | 386/320 | 2525/2156 | 821/701 | 880 | 1200 |
| | 200/60/3 | 2 | 2 | 6/5 | 1.5 | 6.5 | 7.3 | 0.83 | 386/320 | 2525/2156 | 821/701 | 526/433 | 800/700 |
| | 230/60/3 | 1 | 2 | 11 | 1.5 | 6.5 | 7.3 | 0.83 | 336/278 | 2126/1756 | 691/571 | 775 | 1000 |
| | 230/60/3 | 2 | 2 | 6/5 | 1.5 | 6.5 | 7.3 | 0.83 | 336/278 | 2126/1756 | 691/571 | 463/381 | 700/600 |
| | 380/60/3 | 1 | 2 | 11 | 1.5 | 3.5 | 3.7 | 0.83 | 203/168 | 1306/1060 | 424/345 | 463 | 600 |
| | 380/60/3 | 2 | 2 | 6/5 | 1.5 | 3.5 | 3.7 | 0.83 | 203/168 | 1306/1060 | 424/345 | 277/228 | 450/350 |
| | 460/60/3 | 1 | 2 | 11 | 1.5 | 3 | 3.7 | 0.83 | 168/139 | 1065/878 | 346/285 | 385 | 500 |
| | 460/60/3 | 2 | 2 | 6/5 | 1.5 | 3 | 3.7 | 0.83 | 168/139 | 1065/878 | 346/285 | 231/189 | 350/300 |
| | 575/60/3 | 1 | 2 | 11 | 1.5 | 2.5 | 3.0 | 0.83 | 134/111 | 853/705 | 277/229 | 308 | 400 |
| | 575/60/3 | 2 | 2 | 6/5 | 1.5 | 2.5 | 3.0 | 0.83 | 134/111 | 853/705 | 277/229 | 184/152 | 300/250 |



Electrical Data

Table 14. Standard efficiency – all ambient options (continued)

| Unit Size | Rated Voltage ¹ | # Power Conn ² | # Comp | # Fan Ckt1/ Ckt2 | Fan kW | Fan FLA | VFD Input | Cntrl kVA ³ | RLA ⁴ Ckt1/Ckt2 | XLRA ⁵ Ckt1/Ckt2 | YLRA ⁵ Ckt1/Ckt2 | MCA ⁶ Ckt1/ Ckt2 | MOP ⁷ Ckt1/ Ckt2 |
|-----------|----------------------------|---------------------------|--------|---------------------|--------|---------|-----------|------------------------|-------------------------------|--------------------------------|--------------------------------|-----------------------------------|-----------------------------------|
| 200 | 200/60/3 | 1 | 2 | 12 | 1.5 | 6.5 | 7.3 | 0.83 | 386/386 | 2525/2525 | 821/821 | 952 | 1200 |
| | 200/60/3 | 2 | 2 | 6/6 | 1.5 | 6.5 | 7.3 | 0.83 | 386/386 | 2525/2525 | 821/821 | 526/522 | 800/800 |
| | 230/60/3 | 1 | 2 | 12 | 1.5 | 6.5 | 7.3 | 0.83 | 336/336 | 2126/2126 | 691/691 | 839 | 1000 |
| | 230/60/3 | 2 | 2 | 6/6 | 1.5 | 6.5 | 7.3 | 0.83 | 336/336 | 2126/2126 | 691/691 | 463/460 | 700/700 |
| | 380/60/3 | 1 | 2 | 12 | 1.5 | 3.5 | 3.7 | 0.83 | 203/203 | 1306/1306 | 424/424 | 501 | 700 |
| | 380/60/3 | 2 | 2 | 6/6 | 1.5 | 3.5 | 3.7 | 0.83 | 203/203 | 1306/1306 | 424/424 | 277/275 | 450/450 |
| | 460/60/3 | 1 | 2 | 12 | 1.5 | 3 | 3.7 | 0.83 | 168/168 | 1065/1065 | 346/346 | 417 | 500 |
| | 460/60/3 | 2 | 2 | 6/6 | 1.5 | 3 | 3.7 | 0.83 | 168/168 | 1065/1065 | 346/346 | 231/229 | 350/350 |
| | 575/60/3 | 1 | 2 | 12 | 1.5 | 2.5 | 3.0 | 0.83 | 134/134 | 853/853 | 277/277 | 334 | 450 |
| | 575/60/3 | 2 | 2 | 6/6 | 1.5 | 2.5 | 3.0 | 0.83 | 134/134 | 853/853 | 277/277 | 184/183 | 300/300 |
| 225 | 200/60/3 | 1 | 2 | 13 | 1.5 | 6.5 | 7.3 | 0.83 | 459/386 | 2525/2525 | 821/821 | 1050 | 1200 |
| | 200/60/3 | 2 | 2 | 7/6 | 1.5 | 6.5 | 7.3 | 0.83 | 459/386 | 2525/2525 | 821/821 | 624/522 | 1000/800 |
| | 230/60/3 | 1 | 2 | 13 | 1.5 | 6.5 | 7.3 | 0.83 | 399/336 | 2126/2126 | 691/691 | 924 | 1200 |
| | 230/60/3 | 2 | 2 | 7/6 | 1.5 | 6.5 | 7.3 | 0.83 | 399/336 | 2126/2126 | 691/691 | 549/460 | 800/700 |
| | 380/60/3 | 1 | 2 | 13 | 1.5 | 3.5 | 3.7 | 0.83 | 242/203 | 1306/1306 | 424/424 | 554 | 700 |
| | 380/60/3 | 2 | 2 | 7/6 | 1.5 | 3.5 | 3.7 | 0.83 | 242/203 | 1306/1306 | 424/424 | 329/275 | 500/450 |
| | 460/60/3 | 1 | 2 | 13 | 1.5 | 3 | 3.7 | 0.83 | 200/168 | 1065/1065 | 346/346 | 460 | 600 |
| | 460/60/3 | 2 | 2 | 7/6 | 1.5 | 3 | 3.7 | 0.83 | 200/168 | 1065/1065 | 346/346 | 274/229 | 450/350 |
| | 575/60/3 | 1 | 2 | 13 | 1.5 | 2.5 | 3.0 | 0.83 | 160/134 | 853/853 | 277/277 | 369 | 500 |
| | 575/60/3 | 2 | 2 | 7/6 | 1.5 | 2.5 | 3.0 | 0.83 | 160/134 | 853/853 | 277/277 | 219/183 | 350/300 |
| 250 | 200/60/3 | 1 | 2 | 14 | 1.5 | 6.5 | 7.3 | 0.83 | 459/459 | 2525/2525 | 821/821 | 1129 | 1200 |
| | 200/60/3 | 2 | 2 | 7/7 | 1.5 | 6.5 | 7.3 | 0.83 | 459/459 | 2525/2525 | 821/821 | 624/620 | 1000/1000 |
| | 230/60/3 | 1 | 2 | 14 | 1.5 | 6.5 | 7.3 | 0.83 | 399/399 | 2126/2126 | 691/691 | 994 | 1200 |
| | 230/60/3 | 2 | 2 | 7/7 | 1.5 | 6.5 | 7.3 | 0.83 | 399/399 | 2126/2126 | 691/691 | 549/545 | 800/800 |
| | 380/60/3 | 1 | 2 | 14 | 1.5 | 3.5 | 3.7 | 0.83 | 242/242 | 1306/1306 | 424/424 | 596 | 800 |
| | 380/60/3 | 2 | 2 | 7/7 | 1.5 | 3.5 | 3.7 | 0.83 | 242/242 | 1306/1306 | 424/424 | 329/327 | 500/500 |
| | 460/60/3 | 1 | 2 | 14 | 1.5 | 3 | 3.7 | 0.83 | 200/200 | 1065/1065 | 346/346 | 495 | 600 |
| | 460/60/3 | 2 | 2 | 7/7 | 1.5 | 3 | 3.7 | 0.83 | 200/200 | 1065/1065 | 346/346 | 274/272 | 450/450 |
| | 575/60/3 | 1 | 2 | 14 | 1.5 | 2.5 | 3.0 | 0.83 | 160/160 | 853/853 | 277/277 | 397 | 500 |
| | 575/60/3 | 2 | 2 | 7/7 | 1.5 | 2.5 | 3.0 | 0.83 | 160/160 | 853/853 | 277/277 | 219/218 | 350/350 |
| 275 | 200/60/3 | 1 | | | | | | | n/a | | | | |
| | 200/60/3 | 2 | 3 | 10/6 | 1.5 | 6.5 | 7.3 | 1.2 | 320-320/386 | 2156-2156/2525 | 701-701/821 | 791/526 | 1000/800 |
| | 230/60/3 | 1 | | | | | | | n/a | | | | |
| | 230/60/3 | 2 | 3 | 10/6 | 1.5 | 6.5 | 7.3 | 1.2 | 278-278/336 | 1756-1756/2126 | 571-571/691 | 696/463 | 800/700 |
| | 380/60/3 | 1 | | | | | | | n/a | | | | |
| | 380/60/3 | 2 | 3 | 10/6 | 1.5 | 3.5 | 3.7 | 1.2 | 168-168/203 | 1060-1060/1306 | 345-345/424 | 416/277 | 500/450 |
| | 460/60/3 | 1 | 3 | 16 | 1.5 | 3 | 3.7 | 1.2 | 139-139/168 | 878-878/1065 | 285-285/346 | 543 | 700 |
| | 460/60/3 | 2 | 3 | 10/6 | 1.5 | 3 | 3.7 | 1.2 | 139-139/168 | 878-878/1065 | 285-285/346 | 346/231 | 450/350 |
| | 575/60/3 | 1 | 3 | 16 | 1.5 | 2.5 | 3.0 | 1.2 | 111-111/134 | 705-705/853 | 229-229/277 | 436 | 500 |
| | 575/60/3 | 2 | 3 | 10/6 | 1.5 | 2.5 | 3.0 | 1.2 | 111-111/134 | 705-705/853 | 229-229/277 | 277/184 | 350/300 |



Electrical Data

Table 14. Standard efficiency – all ambient options (continued)

| Unit Size | Rated Voltage ¹ | # Power Conn ² | # Comp | # Fan Ckt1/Ckt2 | Fan kW | Fan FLA | VFD Input | Cntrl kVA ³ | RLA ⁴ Ckt1/Ckt2 | XLRA ⁵ Ckt1/Ckt2 | YLRA ⁵ Ckt1/Ckt2 | MCA ⁶ Ckt1/Ckt2 | MOP ⁷ Ckt1/Ckt2 |
|-----------|----------------------------|---------------------------|--------|-----------------|--------|---------|-----------|------------------------|----------------------------|-----------------------------|-----------------------------|----------------------------|----------------------------|
| 300 | 200/60/3 | 1 | | | | | | | n/a | | | | |
| | 200/60/3 | 2 | 3 | 12/6 | 1.5 | 6.5 | 7.3 | 1.2 | 386-386/386 | 2525-2525/2525 | 821-821/821 | 952/526 | 1200/800 |
| | 230/60/3 | 1 | | | | | | | n/a | | | | |
| | 230/60/3 | 2 | 3 | 12/6 | 1.5 | 6.5 | 7.3 | 1.2 | 336-336/336 | 2126-2126/2126 | 691-691/691 | 839/463 | 1000/700 |
| | 380/60/3 | 1 | | | | | | | n/a | | | | |
| | 380/60/3 | 2 | 3 | 12/6 | 1.5 | 3.5 | 3.7 | 1.2 | 203-203/203 | 1306-1306/1306 | 424-424/424 | 501/277 | 700/450 |
| | 460/60/3 | 1 | 3 | 18 | 1.5 | 3 | 3.7 | 1.2 | 168-168/168 | 1065-1065/1065 | 346-346/346 | 607 | 700 |
| | 460/60/3 | 2 | 3 | 12/6 | 1.5 | 3 | 3.7 | 1.2 | 168-168/168 | 1065-1065/1065 | 346-346/346 | 417/231 | 500/350 |
| | 575/60/3 | 1 | 3 | 18 | 1.5 | 2.5 | 3.0 | 1.2 | 134-134/134 | 853-853/853 | 277-277/277 | 487 | 600 |
| 575/60/3 | 2 | 3 | 12/6 | 1.5 | 2.5 | 3.0 | 1.2 | 134-134/134 | 853-853/853 | 277-277/277 | 334/184 | 450/300 | |
| 350 | 200/60/3 | 1 | | | | | | | n/a | | | | |
| | 200/60/3 | 2 | 3 | 14/6 | 1.5 | 6.5 | 7.3 | 1.2 | 459-459/386 | 2525-2525/2525 | 821-821/821 | 1129/526 | 1200/800 |
| | 230/60/3 | 1 | | | | | | | n/a | | | | |
| | 230/60/3 | 2 | 3 | 14/6 | 1.5 | 6.5 | 7.3 | 1.2 | 399-399/336 | 2126-2126/2126 | 691-691/691 | 994/463 | 1200/700 |
| | 380/60/3 | 1 | | | | | | | n/a | | | | |
| | 380/60/3 | 2 | 3 | 14/6 | 1.5 | 3.5 | 3.7 | 1.2 | 242-242/203 | 1306-1306/1306 | 424-424/424 | 596/277 | 800/450 |
| | 460/60/3 | 1 | 3 | 20 | 1.5 | 3 | 3.7 | 1.2 | 200-200/168 | 1065-1065/1065 | 346-346/346 | 684 | 800 |
| | 460/60/3 | 2 | 3 | 14/6 | 1.5 | 3 | 3.7 | 1.2 | 200-200/168 | 1065-1065/1065 | 346-346/346 | 495/231 | 600/350 |
| | 575/60/3 | 1 | 3 | 20 | 1.5 | 2.5 | 3.0 | 1.2 | 160-160/134 | 853-853/853 | 277-277/277 | 550 | 700 |
| 575/60/3 | 2 | 3 | 14/6 | 1.5 | 2.5 | 3.0 | 1.2 | 160-160/134 | 853-853/853 | 277-277/277 | 397/184 | 500/300 | |
| 400 | 200/60/3 | 1 | | | | | | | n/a | | | | |
| | 200/60/3 | 2 | 4 | 12/12 | 1.5 | 6.5 | 7.3 | 1.59 | 386-386/386-386 | 2525-2525/2525-2525 | 821-821/821-821 | 952/952 | 1200/1200 |
| | 230/60/3 | 1 | | | | | | | n/a | | | | |
| | 230/60/3 | 2 | 4 | 12/12 | 1.5 | 6.5 | 7.3 | 1.59 | 336-336/336-336 | 2126-2126/2126-2126 | 691-691/691-691 | 839/839 | 1000/1000 |
| | 380/60/3 | 1 | | | | | | | n/a | | | | |
| | 380/60/3 | 2 | 4 | 12/12 | 1.5 | 3.5 | 3.7 | 1.59 | 203-203/203-203 | 1306-1306/1306-1306 | 424-424/424-424 | 501/501 | 700/700 |
| | 460/60/3 | 1 | 4 | 24 | 1.5 | 3 | 3.7 | 1.59 | 168-168/168-168 | 1065-1065/1065-1065 | 346-346/346-346 | 793 | 800 |
| | 460/60/3 | 2 | 4 | 12/12 | 1.5 | 3 | 3.7 | 1.59 | 168-168/168-168 | 1065-1065/1065-1065 | 346-346/346-346 | 417/417 | 500/500 |
| | 575/60/3 | 1 | 4 | 24 | 1.5 | 2.5 | 3.0 | 1.59 | 134-134/134-134 | 853-853/853-853 | 277-277/277-277 | 637 | 700 |
| 575/60/3 | 2 | 4 | 12/12 | 1.5 | 2.5 | 3.0 | 1.59 | 134-134/134-134 | 853-853/853-853 | 277-277/277-277 | 334/334 | 450/450 | |
| 450 | 200/60/3 | 1 | | | | | | | n/a | | | | |
| | 200/60/3 | 2 | 4 | 14/12 | 1.5 | 6.5 | 7.3 | 1.59 | 459-459/386-386 | 2525-2525/2525-2525 | 821-821/821-821 | 1129/952 | 1200/1200 |
| | 230/60/3 | 1 | | | | | | | n/a | | | | |
| | 230/60/3 | 2 | 4 | 14/12 | 1.5 | 6.5 | 7.3 | 1.59 | 399-399/336-336 | 2126-2126/2126-2126 | 691-691/691-691 | 994/839 | 1200/1000 |
| | 380/60/3 | 1 | | | | | | | n/a | | | | |
| | 380/60/3 | 2 | 4 | 14/12 | 1.5 | 3.5 | 3.7 | 1.59 | 242-242/203-203 | 1306-1306/1306-1306 | 424-424/424-424 | 596/501 | 800/700 |
| | 460/60/3 | 1 | 4 | 26 | 1.5 | 3 | 3.7 | 1.59 | 200-200/168-168 | 1065-1065/1065-1065 | 346-346/346-346 | 871 | 1000 |
| | 460/60/3 | 2 | 4 | 14/12 | 1.5 | 3 | 3.7 | 1.59 | 200-200/168-168 | 1065-1065/1065-1065 | 346-346/346-346 | 495/417 | 600/500 |
| | 575/60/3 | 1 | 4 | 26 | 1.5 | 2.5 | 3.0 | 1.59 | 160-160/134-134 | 853-853/853-853 | 277-277/277-277 | 699 | 800 |
| 575/60/3 | 2 | 4 | 14/12 | 1.5 | 2.5 | 3.0 | 1.59 | 160-160/134-134 | 853-853/853-853 | 277-277/277-277 | 397/334 | 500/450 | |



Electrical Data

Table 14. Standard efficiency — all ambient options (continued)

| Unit Size | Rated Voltage ¹ | # Power Conn ² | # Comp | # Fan | | | VFD Input | Cntrl kVA ³ | RLA ⁴ Ckt1/Ckt2 | XLRA ⁵ Ckt1/Ckt2 | YLRA ⁵ Ckt1/Ckt2 | MCA ⁶ Ckt1/Ckt2 | MOP ⁷ Ckt1/Ckt2 |
|-----------|----------------------------|---------------------------|--------|-------|-----------|--------|-----------|------------------------|----------------------------|-----------------------------|-----------------------------|----------------------------|----------------------------|
| | | | | # | Ckt1/Ckt2 | Fan kW | | | | | | | |
| | 200/60/3 | 1 | | | | | | | n/a | | | | |
| | 200/60/3 | 2 | 4 | 14/14 | 1.5 | 6.5 | 7.3 | 1.59 | 459-459/ 459-459 | 2525-2525/ 2525-2525 | 821-821/ 821-821 | 1129/ 1129 | 1200/ 1200 |
| | 230/60/3 | 1 | | | | | | | n/a | | | | |
| | 230/60/3 | 2 | 4 | 14/14 | 1.5 | 6.5 | 7.3 | 1.59 | 399-399/ 399-399 | 2126-2126/ 2126-2126 | 691-691/ 691-691 | 994/994 | 1200/ 1200 |
| 500 | 380/60/3 | 1 | | | | | | | n/a | | | | |
| | 380/60/3 | 2 | 4 | 14/14 | 1.5 | 3.5 | 3.7 | 1.59 | 242-242/ 242-242 | 1306-1306/ 1306-1306 | 424-424/424-424 | 596/596 | 800/800 |
| | 460/60/3 | 1 | 4 | 28 | 1.5 | 3 | 3.7 | 1.59 | 200-200/ 200-200 | 1065-1065/ 1065-1065 | 346-346/346-346 | 941 | 1000 |
| | 460/60/3 | 2 | 4 | 14/14 | 1.5 | 3 | 3.7 | 1.59 | 200-200/ 200-200 | 1065-1065/ 1065-1065 | 346-346/346-346 | 495/495 | 600/600 |
| | 575/60/3 | 1 | 4 | 28 | 1.5 | 2.5 | 3.0 | 1.59 | 160-160/160-160 | 853-853/853-853 | 277-277/277-277 | 756 | 800 |
| | 575/60/3 | 2 | 4 | 14/14 | 1.5 | 2.5 | 3.0 | 1.59 | 160-160/160-160 | 853-853/853-853 | 277-277/277-277 | 397/397 | 500/500 |

Notes:

1. Voltage Utilization Range: +/- 10% of rated voltage. Rated voltage (use range): 200/60/3 (180-220), 230/60/3 (208-254), 380/60/3 (342-418), 460/60/3 (414-506), 575/60/3 (516-633)
2. As standard, 140-250 ton units have a single point power connection. Optional dual point power connections are available. As standard, 275-500 ton units have dual point power connections. Optional single point power connections are available on 460V and 575V/60 Hz units.
3. Control VA includes operational controls only. It does not include evaporator heaters. A separate 115/60/1, 20 amp customer provided power connection is required to power the evaporator heaters (1640 watts).
4. RLA - Rated Load Amps
5. XLRA - Locked Rotor Amps - based on full winding (x-line) start units). YLRA for wye-delta starters is ~1/3 of LRA of x-line units.
6. MCA - Minimum Circuit Ampacity - 125 percent of largest compressor RLA plus 100 percent of all other loads.
7. Max fuse or MOPD = 225 percent of the largest compressor RLA plus 100 percent of the second compressor RLA, plus the sum of the condenser fan FLA. (Use FLA per circuit, NOT FLA for the entire unit).
8. Local codes may take precedence.
9. All ambient means standard, low, high and wide ambient options.



Electrical Data

Table 15. High efficiency – standard and low ambient options

| Unit Size | Rated Voltage ¹ | # Power Conn ² | # Comp | # Fan Ckt1/Ckt2 | Fan kW | Fan FLA | VFD Input | Cntrl kVA ³ | RLA ⁴ Ckt1/Ckt2 | XLRA ⁵ Ckt1/Ckt2 | YLRA ⁵ Ckt1/Ckt2 | MCA ⁶ Ckt1/Ckt2 | MOP ⁷ Ckt1/Ckt2 |
|-----------|----------------------------|---------------------------|--------|-----------------|--------|---------|-----------|------------------------|----------------------------|-----------------------------|-----------------------------|----------------------------|----------------------------|
| 140 | 200/60/3 | 1 | 2 | 10 | 1.5 | 6.5 | 7.3 | 0.83 | 259/259 | 1845/1845 | 600/600 | 653 | 800 |
| | 200/60/3 | 2 | 2 | 5/5 | 1.5 | 6.5 | 7.3 | 0.83 | 259/259 | 1845/1845 | 600/600 | 361/357 | 600/600 |
| | 230/60/3 | 1 | 2 | 10 | 1.5 | 6.5 | 7.3 | 0.83 | 225/225 | 1556/1556 | 506/506 | 576 | 800 |
| | 230/60/3 | 2 | 2 | 5/5 | 1.5 | 6.5 | 7.3 | 0.83 | 225/225 | 1556/1556 | 506/506 | 318/315 | 500/500 |
| | 380/60/3 | 1 | 2 | 10 | 1.5 | 3.5 | 3.7 | 0.83 | 136/136 | 973/973 | 316/316 | 344 | 450 |
| | 380/60/3 | 2 | 2 | 5/5 | 1.5 | 3.5 | 3.7 | 0.83 | 136/136 | 973/973 | 316/316 | 190/188 | 300/300 |
| | 460/60/3 | 1 | 2 | 10 | 1.5 | 3 | 3.7 | 0.83 | 113/113 | 774/774 | 252/252 | 287 | 400 |
| | 460/60/3 | 2 | 2 | 5/5 | 1.5 | 3 | 3.7 | 0.83 | 113/113 | 774/774 | 252/252 | 159/157 | 250/250 |
| | 575/60/3 | 1 | 2 | 10 | 1.5 | 2.5 | 3.0 | 0.83 | 90/90 | 631/631 | 205/205 | 230 | 300 |
| | 575/60/3 | 2 | 2 | 5/5 | 1.5 | 2.5 | 3.0 | 0.83 | 90/90 | 631/631 | 205/205 | 127/126 | 200/200 |
| 155 | 200/60/3 | 1 | 2 | 11 | 1.5 | 6.5 | 7.3 | 0.83 | 305/259 | 2156/1845 | 701/600 | 717 | 1000 |
| | 200/60/3 | 2 | 2 | 6/5 | 1.5 | 6.5 | 7.3 | 0.83 | 305/259 | 2156/1845 | 701/600 | 425/357 | 700/600 |
| | 230/60/3 | 1 | 2 | 11 | 1.5 | 6.5 | 7.3 | 0.83 | 265/225 | 1756/1556 | 571/506 | 633 | 800 |
| | 230/60/3 | 2 | 2 | 6/5 | 1.5 | 6.5 | 7.3 | 0.83 | 265/225 | 1756/1556 | 571/506 | 375/315 | 600/500 |
| | 380/60/3 | 1 | 2 | 11 | 1.5 | 3.5 | 3.7 | 0.83 | 161/136 | 1060/973 | 345/316 | 378 | 500 |
| | 380/60/3 | 2 | 2 | 6/5 | 1.5 | 3.5 | 3.7 | 0.83 | 161/136 | 1060/973 | 345/316 | 225/188 | 350/300 |
| | 460/60/3 | 1 | 2 | 11 | 1.5 | 3 | 3.7 | 0.83 | 133/113 | 878/774 | 285/252 | 315 | 400 |
| | 460/60/3 | 2 | 2 | 6/5 | 1.5 | 3 | 3.7 | 0.83 | 133/113 | 878/774 | 285/252 | 187/157 | 300/250 |
| | 575/60/3 | 1 | 2 | 11 | 1.5 | 2.5 | 3.0 | 0.83 | 106/90 | 705/631 | 229/205 | 254 | 350 |
| | 575/60/3 | 2 | 2 | 6/5 | 1.5 | 2.5 | 3.0 | 0.83 | 106/90 | 705/631 | 229/205 | 149/126 | 250/200 |
| 170 | 200/60/3 | 1 | 2 | 12 | 1.5 | 6.5 | 7.3 | 0.83 | 305/305 | 2156/2156 | 701/701 | 770 | 1000 |
| | 200/60/3 | 2 | 2 | 6/6 | 1.5 | 6.5 | 7.3 | 0.83 | 305/305 | 2156/2156 | 701/701 | 425/421 | 700/700 |
| | 230/60/3 | 1 | 2 | 12 | 1.5 | 6.5 | 7.3 | 0.83 | 265/265 | 1756/1756 | 571/571 | 679 | 800 |
| | 230/60/3 | 2 | 2 | 6/6 | 1.5 | 6.5 | 7.3 | 0.83 | 265/265 | 1756/1756 | 571/571 | 375/371 | 600/600 |
| | 380/60/3 | 1 | 2 | 12 | 1.5 | 3.5 | 3.7 | 0.83 | 161/161 | 1060/1060 | 345/345 | 407 | 500 |
| | 380/60/3 | 2 | 2 | 6/6 | 1.5 | 3.5 | 3.7 | 0.83 | 161/161 | 1060/1060 | 345/345 | 225/222 | 350/350 |
| | 460/60/3 | 1 | 2 | 12 | 1.5 | 3 | 3.7 | 0.83 | 133/133 | 878/878 | 285/285 | 338 | 450 |
| | 460/60/3 | 2 | 2 | 6/6 | 1.5 | 3 | 3.7 | 0.83 | 133/133 | 878/878 | 285/285 | 187/185 | 300/300 |
| | 575/60/3 | 1 | 2 | 12 | 1.5 | 2.5 | 3.0 | 0.83 | 106/106 | 705/705 | 229/229 | 271 | 350 |
| | 575/60/3 | 2 | 2 | 6/6 | 1.5 | 2.5 | 3.0 | 0.83 | 106/106 | 705/705 | 229/229 | 149/148 | 250/250 |
| 185 | 200/60/3 | 1 | 2 | 13 | 1.5 | 6.5 | 7.3 | 0.83 | 373-305 | 2525/2156 | 821/701 | 861 | 1200 |
| | 200/60/3 | 2 | 2 | 7/6 | 1.5 | 6.5 | 7.3 | 0.83 | 373/305 | 2525/2156 | 821/701 | 517/421 | 800/700 |
| | 230/60/3 | 1 | 2 | 13 | 1.5 | 6.5 | 7.3 | 0.83 | 324-265 | 2126/1756 | 691/571 | 760 | 1000 |
| | 230/60/3 | 2 | 2 | 7/6 | 1.5 | 6.5 | 7.3 | 0.83 | 324/265 | 2126/1756 | 691/571 | 455/371 | 700/600 |
| | 380/60/3 | 1 | 2 | 13 | 1.5 | 3.5 | 3.7 | 0.83 | 196-161 | 1306/1060 | 424/345 | 454 | 600 |
| | 380/60/3 | 2 | 2 | 7/6 | 1.5 | 3.5 | 3.7 | 0.83 | 196/161 | 1306/1060 | 424/345 | 272/222 | 450/350 |
| | 460/60/3 | 1 | 2 | 13 | 1.5 | 3 | 3.7 | 0.83 | 162-133 | 1065/878 | 346/285 | 378 | 500 |
| | 460/60/3 | 2 | 2 | 7/6 | 1.5 | 3 | 3.7 | 0.83 | 162/133 | 1065/878 | 346/285 | 226/185 | 350/300 |
| | 575/60/3 | 1 | 2 | 13 | 1.5 | 2.5 | 3.0 | 0.83 | 130-106 | 853/705 | 277/229 | 305 | 400 |
| | 575/60/3 | 2 | 2 | 7/6 | 1.5 | 2.5 | 3.0 | 0.83 | 130/106 | 853/705 | 277/229 | 182/148 | 300/250 |



Electrical Data

Table 15. High efficiency — standard and low ambient options (continued)

| Unit Size | Rated Voltage ¹ | # Power Conn ² | # Comp | # Fan Ckt1/Ckt2 | Fan kW | Fan FLA | VFD Input | Cntrl kVA ³ | RLA ⁴ Ckt1/Ckt2 | XLRA ⁵ Ckt1/Ckt2 | YLRA ⁵ Ckt1/Ckt2 | MCA ⁶ Ckt1/Ckt2 | MOP ⁷ Ckt1/Ckt2 |
|-----------|----------------------------|---------------------------|--------|-----------------|--------|---------|-----------|------------------------|----------------------------|-----------------------------|-----------------------------|----------------------------|----------------------------|
| 200 | 200/60/3 | 1 | 2 | 14 | 1.5 | 6.5 | 7.3 | 0.83 | 373/373 | 2525/2525 | 821/821 | 936 | 1200 |
| | 200/60/3 | 2 | 2 | 7/7 | 1.5 | 6.5 | 7.3 | 0.83 | 373/373 | 2525/2525 | 821/821 | 517/513 | 800/800 |
| | 230/60/3 | 1 | 2 | 14 | 1.5 | 6.5 | 7.3 | 0.83 | 324/324 | 2126/2126 | 691/691 | 825 | 1000 |
| | 230/60/3 | 2 | 2 | 7/7 | 1.5 | 6.5 | 7.3 | 0.83 | 324/324 | 2126/2126 | 691/691 | 455/451 | 700/700 |
| | 380/60/3 | 1 | 2 | 14 | 1.5 | 3.5 | 3.7 | 0.83 | 196/196 | 1306/1306 | 424/424 | 493 | 600 |
| | 380/60/3 | 2 | 2 | 7/7 | 1.5 | 3.5 | 3.7 | 0.83 | 196/196 | 1306/1306 | 424/424 | 272/270 | 450/450 |
| | 460/60/3 | 1 | 2 | 14 | 1.5 | 3 | 3.7 | 0.83 | 162/162 | 1065/1065 | 346/346 | 410 | 500 |
| | 460/60/3 | 2 | 2 | 7/7 | 1.5 | 3 | 3.7 | 0.83 | 162/162 | 1065/1065 | 346/346 | 226/224 | 350/350 |
| | 575/60/3 | 1 | 2 | 14 | 1.5 | 2.5 | 3.0 | 0.83 | 130/130 | 853/853 | 277/277 | 331 | 450 |
| | 575/60/3 | 2 | 2 | 7/7 | 1.5 | 2.5 | 3.0 | 0.83 | 130/130 | 853/853 | 277/277 | 182/181 | 300/300 |
| 225 | 200/60/3 | 1 | 2 | 14 | 1.5 | 6.5 | 7.3 | 0.83 | 447/373 | 2525/2525 | 821/821 | 1028 | 1200 |
| | 200/60/3 | 2 | 2 | 8/6 | 1.5 | 6.5 | 7.3 | 0.83 | 447/373 | 2525/2525 | 821/821 | 615/506 | 1000/800 |
| | 230/60/3 | 1 | 2 | 14 | 1.5 | 6.5 | 7.3 | 0.83 | 388/324 | 2126/2126 | 691/691 | 904 | 1200 |
| | 230/60/3 | 2 | 2 | 8/6 | 1.5 | 6.5 | 7.3 | 0.83 | 388/324 | 2126/2126 | 691/691 | 541/445 | 800/700 |
| | 380/60/3 | 1 | 2 | 14 | 1.5 | 3.5 | 3.7 | 0.83 | 235/196 | 1306/1306 | 424/424 | 541 | 700 |
| | 380/60/3 | 2 | 2 | 8/6 | 1.5 | 3.5 | 3.7 | 0.83 | 235/196 | 1306/1306 | 424/424 | 324/266 | 500/450 |
| | 460/60/3 | 1 | 2 | 14 | 1.5 | 3 | 3.7 | 0.83 | 194/162 | 1065/1065 | 346/346 | 449 | 600 |
| | 460/60/3 | 2 | 2 | 8/6 | 1.5 | 3 | 3.7 | 0.83 | 194/162 | 1065/1065 | 346/346 | 268/221 | 450/350 |
| | 575/60/3 | 1 | 2 | 14 | 1.5 | 2.5 | 3.0 | 0.83 | 155/130 | 853/853 | 277/277 | 361 | 500 |
| | 575/60/3 | 2 | 2 | 8/6 | 1.5 | 2.5 | 3.0 | 0.83 | 155/130 | 853/853 | 277/277 | 215/178 | 350/300 |
| 250 | 200/60/3 | 1 | 2 | 16 | 1.5 | 6.5 | 7.3 | 0.83 | 447/447 | 2525/2525 | 821/821 | 1115 | 1200 |
| | 200/60/3 | 2 | 2 | 8/8 | 1.5 | 6.5 | 7.3 | 0.83 | 447/447 | 2525/2525 | 821/821 | 616/612 | 1000/1000 |
| | 230/60/3 | 1 | 2 | 16 | 1.5 | 6.5 | 7.3 | 0.83 | 388/388 | 2126/2126 | 691/691 | 982 | 1200 |
| | 230/60/3 | 2 | 2 | 8/8 | 1.5 | 6.5 | 7.3 | 0.83 | 388/388 | 2126/2126 | 691/691 | 541/538 | 800/800 |
| | 380/60/3 | 1 | 2 | 16 | 1.5 | 3.5 | 3.7 | 0.83 | 235/235 | 1306/1306 | 424/424 | 587 | 800 |
| | 380/60/3 | 2 | 2 | 8/8 | 1.5 | 3.5 | 3.7 | 0.83 | 235/235 | 1306/1306 | 424/424 | 324/322 | 500/500 |
| | 460/60/3 | 1 | 2 | 16 | 1.5 | 3 | 3.7 | 0.83 | 194/194 | 1065/1065 | 346/346 | 488 | 600 |
| | 460/60/3 | 2 | 2 | 8/8 | 1.5 | 3 | 3.7 | 0.83 | 194/194 | 1065/1065 | 346/346 | 269/267 | 450/450 |
| | 575/60/3 | 1 | 2 | 7/4 | 1.5 | 2.5 | 3.0 | 0.83 | 155/155 | 853/853 | 277/277 | 391 | 500 |
| | 575/60/3 | 2 | 2 | 8/8 | 1.5 | 2.5 | 3.0 | 0.83 | 155/155 | 853/853 | 277/277 | 216/214 | 350/350 |
| 275 | 200/60/3 | 1 | | | | | | | n/a | | | | |
| | 200/60/3 | 2 | 3 | 12/6 | 1.5 | 6.5 | 7.3 | 1.2 | 305-305/373 | 2156-2156/2525 | 701-701/821 | 770/510 | 1000/800 |
| | 230/60/3 | 1 | | | | | | | n/a | | | | |
| | 230/60/3 | 2 | 3 | 12/6 | 1.5 | 6.5 | 7.3 | 1.2 | 265-265/324 | 1756-1756/2126 | 571-571/691 | 679/448 | 800/700 |
| | 380/60/3 | 1 | | | | | | | n/a | | | | |
| | 380/60/3 | 2 | 3 | 12/6 | 1.5 | 3.5 | 3.7 | 1.2 | 161-161/196 | 1060-1060/1306 | 345-345/424 | 407/268 | 500/450 |
| | 460/60/3 | 1 | 3 | 18 | 1.5 | 3 | 3.7 | 1.2 | 133-133/162 | 878-878/1065 | 285-285/346 | 529 | 600 |
| | 460/60/3 | 2 | 3 | 12/6 | 1.5 | 3 | 3.7 | 1.2 | 133-133/162 | 878-878/1065 | 285-285/346 | 338/223 | 450/350 |
| | 575/60/3 | 1 | 3 | 18 | 1.5 | 2.5 | 3.0 | 1.2 | 106-106/130 | 705-705/853 | 229-229/277 | 426 | 500 |
| | 575/60/3 | 2 | 3 | 12/6 | 1.5 | 2.5 | 3.0 | 1.2 | 106-106/130 | 705-705/853 | 229-229/277 | 271/179 | 350/300 |



Electrical Data

Table 15. High efficiency – standard and low ambient options (continued)

| Unit Size | Rated Voltage ¹ | # Power Conn ² | # Comp | # Fan Ckt1/ Ckt2 | Fan kW | Fan FLA | VFD Input | Cntrl kVA ³ | RLA ⁴ Ckt1/Ckt2 | XLRA ⁵ Ckt1/Ckt2 | YLRA ⁵ Ckt1/Ckt2 | MCA ⁶ Ckt1/ Ckt2 | MOP ⁷ Ckt1/ Ckt2 |
|-----------|----------------------------|---------------------------|--------|---------------------|--------|---------|-----------|------------------------|-------------------------------|--------------------------------|--------------------------------|-----------------------------------|-----------------------------------|
| 300 | 200/60/3 | 1 | | | | | | | n/a | | | | |
| | 200/60/3 | 2 | 3 | 14/6 | 1.5 | 6.5 | 7.3 | 1.2 | 373-373/373 | 2525-2525/2525 | 821-821/821 | 936/510 | 1200/800 |
| | 230/60/3 | 1 | | | | | | | n/a | | | | |
| | 230/60/3 | 2 | 3 | 14/6 | 1.5 | 6.5 | 7.3 | 1.2 | 324-324/324 | 2126-2126/2126 | 691-691/691 | 825/448 | 1000/700 |
| | 380/60/3 | 1 | | | | | | | n/a | | | | |
| | 380/60/3 | 2 | 3 | 14/6 | 1.5 | 3.5 | 3.7 | 1.2 | 196-196/196 | 1306-1306/1306 | 424-424/424 | 493/268 | 600/450 |
| | 460/60/3 | 1 | 3 | 20 | 1.5 | 3 | 3.7 | 1.2 | 162-162/162 | 1065-1065/1065 | 346-346/346 | 592 | 700 |
| | 460/60/3 | 2 | 3 | 14/6 | 1.5 | 3 | 3.7 | 1.2 | 162-162/162 | 1065-1065/1065 | 346-346/346 | 410/223 | 500/350 |
| | 575/60/3 | 1 | 3 | 20 | 1.5 | 2.5 | 3.0 | 1.2 | 130-130/130 | 853-853/853 | 277-277/277 | 477 | 600 |
| | 575/60/3 | 2 | 3 | 14/6 | 1.5 | 2.5 | 3.0 | 1.2 | 130-130/130 | 853-853/853 | 277-277/277 | 330/179 | 450/300 |
| 350 | 200/60/3 | 1 | | | | | | | n/a | | | | |
| | 200/60/3 | 2 | 4 | 12/12 | 1.5 | 6.5 | 7.3 | 1.2 | 305-305/ 305-305 | 2156-2156/ 2156-2156 | 701-701/ 701-701 | 770/770 | 1000/1000 |
| | 230/60/3 | 1 | | | | | | | n/a | | | | |
| | 230/60/3 | 2 | 4 | 12/12 | 1.5 | 6.5 | 7.3 | 1.2 | 265-265/ 265-265 | 1756-1756/ 1756-1756 | 571-571/ 571-571 | 679/679 | 800/800 |
| | 380/60/3 | 1 | | | | | | | n/a | | | | |
| | 380/60/3 | 2 | 4 | 12/12 | 1.5 | 3.5 | 3.7 | 1.2 | 161-161/ 161-161 | 1060-1060/ 1060-1060 | 345-345/ 345-345 | 407/407 | 500/500 |
| | 460/60/3 | 1 | 4 | 24 | 1.5 | 3 | 3.7 | 1.2 | 133-133/ 133-133 | 878-878/878-878 | 285-285/ 285-285 | 644 | 700 |
| | 460/60/3 | 2 | 4 | 12/12 | 1.5 | 3 | 3.7 | 1.2 | 133-133/ 133-133 | 878-878/878-878 | 285-285/ 285-285 | 338/338 | 450/450 |
| | 575/60/3 | 1 | 4 | 24 | 1.5 | 2.5 | 3.0 | 1.2 | 106-106/ 106-106 | 705-705/705-705 | 229-229/ 229-229 | 515 | 600 |
| | 575/60/3 | 2 | 4 | 12/12 | 1.5 | 2.5 | 3.0 | 1.2 | 106-106/ 106-106 | 705-705/705-705 | 229-229/ 229-229 | 271/271 | 350/350 |
| 400 | 200/60/3 | 1 | | | | | | | n/a | | | | |
| | 200/60/3 | 2 | 4 | 14/14 | 1.5 | 6.5 | 7.3 | 1.59 | 373-373/ 373-373 | 2525-2525/ 2525-2525 | 821-821/ 821-821 | 936/936 | 1200/1200 |
| | 230/60/3 | 1 | | | | | | | n/a | | | | |
| | 230/60/3 | 2 | 4 | 14/14 | 1.5 | 6.5 | 7.3 | 1.59 | 324-324/ 324-324 | 2126-2126/ 2126-2126 | 691-691/ 691-691 | 825/825 | 1000/1000 |
| | 380/60/3 | 1 | | | | | | | n/a | | | | |
| | 380/60/3 | 2 | 4 | 14/14 | 1.5 | 3.5 | 3.7 | 1.59 | 196-196/ 196-196 | 1306-1306/ 1306-1306 | 424-424/ 424-424 | 493/493 | 600/600 |
| | 460/60/3 | 1 | 4 | 28 | 1.5 | 3 | 3.7 | 1.59 | 162-162/ 162-162 | 1065-1065/ 1065-1065 | 346-346/ 346-346 | 779 | 800 |
| | 460/60/3 | 2 | 4 | 14/14 | 1.5 | 3 | 3.7 | 1.59 | 162-162/ 162-162 | 1065-1065/ 1065-1065 | 346-346/ 346-346 | 410/410 | 500/500 |
| | 575/60/3 | 1 | 4 | 28 | 1.5 | 2.5 | 3.0 | 1.59 | 130-130/ 130-130 | 853-853/ 853-853 | 277-277/ 277-277 | 627 | 700 |
| | 575/60/3 | 2 | 4 | 14/14 | 1.5 | 2.5 | 3.0 | 1.59 | 130-130/ 130-130 | 853-853/ 853-853 | 277-277/ 277-277 | 330/330 | 450/450 |

Notes:

1. Voltage Utilization Range: +/- 10% of rated voltage. Rated voltage (use range): 200/60/3 (180-220), 230/60/3 (208-254), 380/60/3 (342-418), 460/60/3 (414-506), 575/60/3 (516-633)
2. As standard, 140-250 ton units have a single point power connection. Optional dual point power connections are available. As standard, 275-500 ton units have dual point power connections. Optional single point power connections are available on 460V and 575V/60 Hz units.
3. Control VA includes operational controls only. It does not include evaporator heaters. A separate 115/60/1, 20 amp customer provided power connection is required to power the evaporator heaters (1640 watts).
4. RLA - Rated Load Amps
5. XLRA - Locked Rotor Amps - based on full winding (x-line) start units). YLRA for wye-delta starters is ~1/3 of LRA of x-line units.
6. MCA - Minimum Circuit Ampacity - 125 percent of largest compressor RLA plus 100 percent of all other loads.
7. Max fuse or MOPD = 225 percent of the largest compressor RLA plus 100 percent of the second compressor RLA, plus the sum of the condenser fan FLA. (Use FLA per circuit, NOT FLA for the entire unit).
8. Local codes may take precedence.
9. All ambient means standard, low, high and wide ambient options.



Electrical Data

Table 16. High efficiency — high and wide ambient options

| Unit Size | Rated Voltage ¹ | # Power Conn ² | # Comp | # Fan Ckt1/ Ckt2 | Fan kW | Fan FLA | VFD Input | Cntrl kVA ³ | RLA ⁴ Ckt1/Ckt2 | XLRA ⁵ Ckt1/Ckt2 | YLRA ⁵ Ckt1/Ckt2 | MCA ⁶ Ckt1/ Ckt2 | MOP ⁷ Ckt1/ Ckt2 |
|-----------|----------------------------|---------------------------|--------|---------------------|--------|---------|-----------|------------------------|-------------------------------|--------------------------------|--------------------------------|-----------------------------------|-----------------------------------|
| 140 | 200/60/3 | 1 | 2 | 10 | 1.5 | 6.5 | 7.3 | 0.83 | 270/270 | 1845/1845 | 600/600 | 678 | 800 |
| | 200/60/3 | 2 | 2 | 5/5 | 1.5 | 6.5 | 7.3 | 0.83 | 270/270 | 1845/1845 | 600/600 | 375/371 | 600/600 |
| | 230/60/3 | 1 | 2 | 10 | 1.5 | 6.5 | 7.3 | 0.83 | 235/235 | 1556/1556 | 506/506 | 599 | 800 |
| | 230/60/3 | 2 | 2 | 5/5 | 1.5 | 6.5 | 7.3 | 0.83 | 235/235 | 1556/1556 | 506/506 | 331/327 | 500/500 |
| | 380/60/3 | 1 | 2 | 10 | 1.5 | 3.5 | 3.7 | 0.83 | 142/142 | 973/973 | 316/316 | 357 | 450 |
| | 380/60/3 | 2 | 2 | 5/5 | 1.5 | 3.5 | 3.7 | 0.83 | 142/142 | 973/973 | 316/316 | 197/195 | 300/300 |
| | 460/60/3 | 1 | 2 | 10 | 1.5 | 3 | 3.7 | 0.83 | 118/118 | 774/774 | 252/252 | 299 | 400 |
| | 460/60/3 | 2 | 2 | 5/5 | 1.5 | 3 | 3.7 | 0.83 | 118/118 | 774/774 | 252/252 | 165/163 | 250/250 |
| | 575/60/3 | 1 | 2 | 10 | 1.5 | 2.5 | 3.0 | 0.83 | 94/94 | 631/631 | 205/205 | 239 | 300 |
| | 575/60/3 | 2 | 2 | 5/5 | 1.5 | 2.5 | 3.0 | 0.83 | 94/94 | 631/631 | 205/205 | 132/131 | 225/225 |
| 155 | 200/60/3 | 1 | 2 | 11 | 1.5 | 6.5 | 7.3 | 0.83 | 320/270 | 2156/1845 | 701/600 | 747 | 1000 |
| | 200/60/3 | 2 | 2 | 6/5 | 1.5 | 6.5 | 7.3 | 0.83 | 320/270 | 2156/1845 | 701/600 | 444/371 | 700/600 |
| | 230/60/3 | 1 | 2 | 11 | 1.5 | 6.5 | 7.3 | 0.83 | 278/235 | 1756/1556 | 571/506 | 659 | 800 |
| | 230/60/3 | 2 | 2 | 6/5 | 1.5 | 6.5 | 7.3 | 0.83 | 278/235 | 1756/1556 | 571/506 | 391/327 | 600/500 |
| | 380/60/3 | 1 | 2 | 11 | 1.5 | 3.5 | 3.7 | 0.83 | 168/142 | 1060/973 | 345/316 | 393 | 500 |
| | 380/60/3 | 2 | 2 | 6/5 | 1.5 | 3.5 | 3.7 | 0.83 | 168/142 | 1060/973 | 345/316 | 233/195 | 400/300 |
| | 460/60/3 | 1 | 2 | 11 | 1.5 | 3 | 3.7 | 0.83 | 139/118 | 878/774 | 285/252 | 328 | 450 |
| | 460/60/3 | 2 | 2 | 6/5 | 1.5 | 3 | 3.7 | 0.83 | 139/118 | 878/774 | 285/252 | 194/163 | 300/250 |
| | 575/60/3 | 1 | 2 | 11 | 1.5 | 2.5 | 3.0 | 0.83 | 111/94 | 705/631 | 229/205 | 263 | 350 |
| | 575/60/3 | 2 | 2 | 6/5 | 1.5 | 2.5 | 3.0 | 0.83 | 111/94 | 705/631 | 229/205 | 156/131 | 250/200 |
| 170 | 200/60/3 | 1 | 2 | 12 | 1.5 | 6.5 | 7.3 | 0.83 | 320/320 | 2156/2156 | 701/701 | 804 | 1000 |
| | 200/60/3 | 2 | 2 | 6/6 | 1.5 | 6.5 | 7.3 | 0.83 | 320/320 | 2156/2156 | 701/701 | 444/440 | 700/700 |
| | 230/60/3 | 1 | 2 | 12 | 1.5 | 6.5 | 7.3 | 0.83 | 278/278 | 1756/1756 | 571/571 | 709 | 800 |
| | 230/60/3 | 2 | 2 | 6/6 | 1.5 | 6.5 | 7.3 | 0.83 | 278/278 | 1756/1756 | 571/571 | 391/387 | 600/600 |
| | 380/60/3 | 1 | 2 | 12 | 1.5 | 3.5 | 3.7 | 0.83 | 168/168 | 1060/1060 | 345/345 | 423 | 500 |
| | 380/60/3 | 2 | 2 | 6/6 | 1.5 | 3.5 | 3.7 | 0.83 | 168/168 | 1060/1060 | 345/345 | 233/231 | 400/350 |
| | 460/60/3 | 1 | 2 | 12 | 1.5 | 3 | 3.7 | 0.83 | 139/139 | 878/878 | 285/285 | 352 | 450 |
| | 460/60/3 | 2 | 2 | 6/6 | 1.5 | 3 | 3.7 | 0.83 | 139/139 | 878/878 | 285/285 | 194/192 | 300/300 |
| | 575/60/3 | 1 | 2 | 12 | 1.5 | 2.5 | 3.0 | 0.83 | 111/111 | 705/705 | 229/229 | 282 | 350 |
| | 575/60/3 | 2 | 2 | 6/6 | 1.5 | 2.5 | 3.0 | 0.83 | 111/111 | 705/705 | 229/229 | 156/154 | 250/250 |
| 185 | 200/60/3 | 1 | 2 | 13 | 1.5 | 6.5 | 7.3 | 0.83 | 386/320 | 2525/2156 | 821/701 | 893 | 1200 |
| | 200/60/3 | 2 | 2 | 7/6 | 1.5 | 6.5 | 7.3 | 0.83 | 386/320 | 2525/2156 | 821/701 | 533/440 | 800/700 |
| | 230/60/3 | 1 | 2 | 13 | 1.5 | 6.5 | 7.3 | 0.83 | 336/278 | 2126/1756 | 691/571 | 788 | 1000 |
| | 230/60/3 | 2 | 2 | 7/6 | 1.5 | 6.5 | 7.3 | 0.83 | 336/278 | 2126/1756 | 691/571 | 470/387 | 800/600 |
| | 380/60/3 | 1 | 2 | 13 | 1.5 | 3.5 | 3.7 | 0.83 | 203/168 | 1306/1060 | 424/345 | 470 | 600 |
| | 380/60/3 | 2 | 2 | 7/6 | 1.5 | 3.5 | 3.7 | 0.83 | 203/168 | 1306/1060 | 424/345 | 281/231 | 450/350 |
| | 460/60/3 | 1 | 2 | 13 | 1.5 | 3 | 3.7 | 0.83 | 168/139 | 1065/878 | 346/285 | 391 | 500 |
| | 460/60/3 | 2 | 2 | 7/6 | 1.5 | 3 | 3.7 | 0.83 | 168/139 | 1065/878 | 346/285 | 234/192 | 400/300 |
| | 575/60/3 | 1 | 2 | 13 | 1.5 | 2.5 | 3.0 | 0.83 | 134/111 | 853/705 | 277/229 | 313 | 450 |
| | 575/60/3 | 2 | 2 | 7/6 | 1.5 | 2.5 | 3.0 | 0.83 | 134/111 | 853/705 | 277/229 | 187/154 | 300/250 |



Electrical Data

Table 16. High efficiency — high and wide ambient options (continued)

| Unit Size | Rated Voltage ¹ | # Power Conn ² | # Comp | # Fan Ckt1/ Ckt2 | Fan kW | Fan FLA | VFD Input | Cntrl kVA ³ | RLA ⁴ Ckt1/Ckt2 | XLRA ⁵ Ckt1/Ckt2 | YLRA ⁵ Ckt1/Ckt2 | MCA ⁶ Ckt1/ Ckt2 | MOP ⁷ Ckt1/ Ckt2 |
|-----------|----------------------------|---------------------------|--------|---------------------|--------|---------|-----------|------------------------|-------------------------------|--------------------------------|--------------------------------|-----------------------------------|-----------------------------------|
| 200 | 200/60/3 | 1 | 2 | 14 | 1.5 | 6.5 | 7.3 | 0.83 | 386/386 | 2525/2525 | 821/821 | 965 | 1200 |
| | 200/60/3 | 2 | 2 | 7/7 | 1.5 | 6.5 | 7.3 | 0.83 | 386/386 | 2525/2525 | 821/821 | 533/529 | 800/800 |
| | 230/60/3 | 1 | 2 | 14 | 1.5 | 6.5 | 7.3 | 0.83 | 336/336 | 2126/2126 | 691/691 | 852 | 1000 |
| | 230/60/3 | 2 | 2 | 7/7 | 1.5 | 6.5 | 7.3 | 0.83 | 336/336 | 2126/2126 | 691/691 | 470/466 | 800/800 |
| | 380/60/3 | 1 | 2 | 14 | 1.5 | 3.5 | 3.7 | 0.83 | 203/203 | 1306/1306 | 424/424 | 508 | 700 |
| | 380/60/3 | 2 | 2 | 7/7 | 1.5 | 3.5 | 3.7 | 0.83 | 203/203 | 1306/1306 | 424/424 | 281/278 | 450/450 |
| | 460/60/3 | 1 | 2 | 14 | 1.5 | 3 | 3.7 | 0.83 | 168/168 | 1065/1065 | 346/346 | 423 | 500 |
| | 460/60/3 | 2 | 2 | 7/7 | 1.5 | 3 | 3.7 | 0.83 | 168/168 | 1065/1065 | 346/346 | 234/232 | 400/350 |
| | 575/60/3 | 1 | 2 | 14 | 1.5 | 2.5 | 3.0 | 0.83 | 134/134 | 853/853 | 277/277 | 339 | 450 |
| | 575/60/3 | 2 | 2 | 7/7 | 1.5 | 2.5 | 3.0 | 0.83 | 134/134 | 853/853 | 277/277 | 187/186 | 300/300 |
| 225 | 200/60/3 | 1 | 2 | 14 | 1.5 | 6.5 | 7.3 | 0.83 | 459/386 | 2525/2525 | 821/821 | 1056 | 1200 |
| | 200/60/3 | 2 | 2 | 8/6 | 1.5 | 6.5 | 7.3 | 0.83 | 459/386 | 2525/2525 | 821/821 | 631/522 | 1000/800 |
| | 230/60/3 | 1 | 2 | 14 | 1.5 | 6.5 | 7.3 | 0.83 | 399/336 | 2126/2126 | 691/691 | 931 | 1200 |
| | 230/60/3 | 2 | 2 | 8/6 | 1.5 | 6.5 | 7.3 | 0.83 | 399/336 | 2126/2126 | 691/691 | 555/460 | 800/700 |
| | 380/60/3 | 1 | 2 | 14 | 1.5 | 3.5 | 3.7 | 0.83 | 242/203 | 1306/1306 | 424/424 | 557 | 700 |
| | 380/60/3 | 2 | 2 | 8/6 | 1.5 | 3.5 | 3.7 | 0.83 | 242/203 | 1306/1306 | 424/424 | 333/275 | 500/450 |
| | 460/60/3 | 1 | 2 | 14 | 1.5 | 3 | 3.7 | 0.83 | 200/168 | 1065/1065 | 346/346 | 463 | 600 |
| | 460/60/3 | 2 | 2 | 8/6 | 1.5 | 3 | 3.7 | 0.83 | 200/168 | 1065/1065 | 346/346 | 277/229 | 450/350 |
| | 575/60/3 | 1 | 2 | 14 | 1.5 | 2.5 | 3.0 | 0.83 | 160/134 | 853/853 | 277/277 | 371 | 500 |
| | 575/60/3 | 2 | 2 | 8/6 | 1.5 | 2.5 | 3.0 | 0.83 | 160/134 | 853/853 | 277/277 | 222/183 | 350/300 |
| 250 | 200/60/3 | 1 | 2 | 16 | 1.5 | 6.5 | 7.3 | 0.83 | 459/459 | 2525/2525 | 821/821 | 1142 | 1600 |
| | 200/60/3 | 2 | 2 | 8/8 | 1.5 | 6.5 | 7.3 | 0.83 | 459/459 | 2525/2525 | 821/821 | 631/627 | 1000/1000 |
| | 230/60/3 | 1 | 2 | 16 | 1.5 | 6.5 | 7.3 | 0.83 | 399/399 | 2126/2126 | 691/691 | 1007 | 1200 |
| | 230/60/3 | 2 | 2 | 8/8 | 1.5 | 6.5 | 7.3 | 0.83 | 399/399 | 2126/2126 | 691/691 | 555/552 | 800/800 |
| | 380/60/3 | 1 | 2 | 16 | 1.5 | 3.5 | 3.7 | 0.83 | 242/242 | 1306/1306 | 424/424 | 603 | 800 |
| | 380/60/3 | 2 | 2 | 8/8 | 1.5 | 3.5 | 3.7 | 0.83 | 242/242 | 1306/1306 | 424/424 | 333/331 | 500/500 |
| | 460/60/3 | 1 | 2 | 16 | 1.5 | 3 | 3.7 | 0.83 | 200/200 | 1065/1065 | 346/346 | 501 | 700 |
| | 460/60/3 | 2 | 2 | 8/8 | 1.5 | 3 | 3.7 | 0.83 | 200/200 | 1065/1065 | 346/346 | 277/275 | 450/450 |
| | 575/60/3 | 1 | 2 | 16 | 1.5 | 2.5 | 3.0 | 0.83 | 160/160 | 853/853 | 277/277 | 402 | 500 |
| | 575/60/3 | 2 | 2 | 8/8 | 1.5 | 2.5 | 3.0 | 0.83 | 160/160 | 853/853 | 277/277 | 222/221 | 350/350 |
| 275 | 200/60/3 | 1 | | | | | | | n/a | | | | |
| | 200/60/3 | 2 | 3 | 12/6 | 1.5 | 6.5 | 7.3 | 1.2 | 320-320/386 | 2156-2156/2525 | 701-701/821 | 804/526 | 1000/800 |
| | 230/60/3 | 1 | | | | | | | n/a | | | | |
| | 230/60/3 | 2 | 3 | 12/6 | 1.5 | 6.5 | 7.3 | 1.2 | 278-278/336 | 1756-1756/2126 | 571-571/691 | 709/463 | 800/700 |
| | 380/60/3 | 1 | | | | | | | n/a | | | | |
| | 380/60/3 | 2 | 3 | 12/6 | 1.5 | 3.5 | 3.7 | 1.2 | 168-168/203 | 1060-1060/1306 | 345-345/424 | 423/277 | 500/450 |
| | 460/60/3 | 1 | 3 | 18 | 1.5 | 3 | 3.7 | 1.2 | 139-139/168 | 878-878/1065 | 285-285/346 | 549 | 700 |
| | 460/60/3 | 2 | 3 | 12/6 | 1.5 | 3 | 3.7 | 1.2 | 139-139/168 | 878-878/1065 | 285-285/346 | 352/231 | 450/350 |
| | 575/60/3 | 1 | 3 | 18 | 1.5 | 2.5 | 3.0 | 1.2 | 111-111/134 | 705-705/853 | 229-229/277 | 441 | 500 |
| | 575/60/3 | 2 | 3 | 12/6 | 1.5 | 2.5 | 3.0 | 1.2 | 111-111/134 | 705-705/853 | 229-229/277 | 282/184 | 350/300 |



Electrical Data

Table 16. High efficiency — high and wide ambient options (continued)

| Unit Size | Rated Voltage ¹ | # Power Conn ² | # Comp | # Fan Ckt1/Ckt2 | Fan kW | Fan FLA | VFD Input | Cntrl kVA ³ | RLA ⁴ Ckt1/Ckt2 | XLRA ⁵ Ckt1/Ckt2 | YLRA ⁵ Ckt1/Ckt2 | MCA ⁶ Ckt1/Ckt2 | MOP ⁷ Ckt1/Ckt2 |
|-----------|----------------------------|---------------------------|--------|-----------------|--------|---------|-----------|------------------------|----------------------------|-----------------------------|-----------------------------|----------------------------|----------------------------|
| 300 | 200/60/3 | 1 | | | | | | | n/a | | | | |
| | 200/60/3 | 2 | 3 | 14/6 | 1.5 | 6.5 | 7.3 | 1.2 | 386-386/386 | 2525-2525/2525 | 821-821/821 | 965/526 | 1200/800 |
| | 230/60/3 | 1 | | | | | | | n/a | | | | |
| | 230/60/3 | 2 | 3 | 14/6 | 1.5 | 6.5 | 7.3 | 1.2 | 336-336/336 | 2126-2126/2126 | 691-691/691 | 852/463 | 1000/700 |
| | 380/60/3 | 1 | | | | | | | n/a | | | | |
| | 380/60/3 | 2 | 3 | 14/6 | 1.5 | 3.5 | 3.7 | 1.2 | 203-203/203 | 1306-1306/1306 | 424-424/424 | 508/277 | 700/450 |
| | 460/60/3 | 1 | 3 | 20 | 1.5 | 3 | 3.7 | 1.2 | 168-168/168 | 1065-1065/1065 | 346-346/346 | 612 | 700 |
| | 460/60/3 | 2 | 3 | 14/6 | 1.5 | 3 | 3.7 | 1.2 | 168-168/168 | 1065-1065/1065 | 346-346/346 | 423/231 | 500/350 |
| | 575/60/3 | 1 | 3 | 20 | 1.5 | 2.5 | 3.0 | 1.2 | 134-134/134 | 853-853/853 | 277-277/277 | 490 | 600 |
| | 575/60/3 | 2 | 3 | 14/6 | 1.5 | 2.5 | 3.0 | 1.2 | 134-134/134 | 853-853/853 | 277-277/277 | 339/184 | 450/300 |
| 350 | 200/60/3 | 1 | | | | | | | n/a | | | | |
| | 200/60/3 | 2 | 4 | 12/12 | 1.5 | 6.5 | 7.3 | 1.2 | 320-320/320-320 | 2156-2156/2156-2156 | 701-701/701-701 | 804/804 | 1000/1000 |
| | 230/60/3 | 1 | | | | | | | n/a | | | | |
| | 230/60/3 | 2 | 4 | 12/12 | 1.5 | 6.5 | 7.3 | 1.2 | 278-278/278-278 | 1756-1756/1756-1756 | 571-571/571-571 | 709/709 | 800/800 |
| | 380/60/3 | 1 | | | | | | | n/a | | | | |
| | 380/60/3 | 2 | 4 | 12/12 | 1.5 | 3.5 | 3.7 | 1.2 | 168-168/168-168 | 1060-1060/1060-1060 | 345-345/345-345 | 423/423 | 500/500 |
| | 460/60/3 | 1 | 4 | 24 | 1.5 | 3 | 3.7 | 1.2 | 139-139/139-139 | 878-878/878-878 | 285-285/285-285 | 669 | 800 |
| | 460/60/3 | 2 | 4 | 12/12 | 1.5 | 3 | 3.7 | 1.2 | 139-139/139-139 | 878-878/878-878 | 285-285/285-285 | 352/352 | 450/450 |
| | 575/60/3 | 1 | 4 | 24 | 1.5 | 2.5 | 3.0 | 1.2 | 111-111/111-111 | 705-705/705-705 | 229-229/229-229 | 537 | 600 |
| | 575/60/3 | 2 | 4 | 12/12 | 1.5 | 2.5 | 3.0 | 1.2 | 111-111/111-111 | 705-705/705-705 | 229-229/229-229 | 282/282 | 350/350 |
| 400 | 200/60/3 | 1 | | | | | | | n/a | | | | |
| | 200/60/3 | 2 | 4 | 14/14 | 1.5 | 6.5 | 7.3 | 1.59 | 386-386/386-386 | 2525-2525/2525-2525 | 821-821/821-821 | 965/965 | 1200/1200 |
| | 230/60/3 | 1 | | | | | | | n/a | | | | |
| | 230/60/3 | 2 | 4 | 14/14 | 1.5 | 6.5 | 7.3 | 1.59 | 336-336/336-336 | 2126-2126/2126-2126 | 691-691/691-691 | 852/852 | 1000/1000 |
| | 200/60/3 | 1 | | | | | | | n/a | | | | |
| | 380/60/3 | 2 | 4 | 14/14 | 1.5 | 3.5 | 3.7 | 1.59 | 203-203/203-203 | 1306-1306/1306-1306 | 424-424/424-424 | 508/508 | 700/700 |
| | 460/60/3 | 1 | 4 | 28 | 1.5 | 3 | 3.7 | 1.59 | 168-168/168-168 | 1065-1065/1065-1065 | 346-346/346-346 | 804 | 1000 |
| | 460/60/3 | 2 | 4 | 14/14 | 1.5 | 3 | 3.7 | 1.59 | 168-168/168-168 | 1065-1065/1065-1065 | 346-346/346-346 | 423/423 | 500/500 |
| | 575/60/3 | 1 | 4 | 28 | 1.5 | 2.5 | 3.0 | 1.59 | 134-134/134-134 | 853-853/853-853 | 277-277/277-277 | 644 | 700 |
| | 575/60/3 | 2 | 4 | 14/14 | 1.5 | 2.5 | 3.0 | 1.59 | 134-134/134-134 | 853-853/853-853 | 277-277/277-277 | 339/339 | 450/450 |

Notes:

1. Voltage Utilization Range: +/- 10% of rated voltage. Rated voltage (use range): 200/60/3 (180-220), 230/60/3 (208-254), 380/60/3 (342-418), 460/60/3 (414-506), 575/60/3 (516-633)
2. As standard, 140-250 ton units have a single point power connection. Optional dual point power connections are available. As standard, 275-500 ton units have dual point power connections. Optional single point power connections are available on 460V and 575V/60 Hz units.
3. Control VA includes operational controls only. It does not include evaporator heaters. A separate 115/60/1, 20 amp customer provided power connection is required to power the evaporator heaters (1640 watts).
4. RLA - Rated Load Amps
5. XLRA - Locked Rotor Amps - based on full winding (x-line) start units). YLRA for wye-delta starters is ~1/3 of LRA of x-line units.
6. MCA - Minimum Circuit Ampacity - 125 percent of largest compressor RLA plus 100 percent of all other loads.
7. Max fuse or MOPD = 225 percent of the largest compressor RLA plus 100 percent of the second compressor RLA, plus the sum of the condenser fan FLA. (Use FLA per circuit, NOT FLA for the entire unit).
8. Local codes may take precedence.
9. All ambient means standard, low, high and wide ambient options.

Table 17. Extra efficiency – high and wide ambient

| Unit Size | Rated Voltage ¹ | # Power Conn ² | # Comp | # Fan Ckt1/ Ckt2 | Fan kW | Fan FLA | VFD Input | Cntrl kVA ³ | RLA ⁴ Ckt1/Ckt2 | XLRA ⁵ Ckt1/Ckt2 | YLRA ⁵ Ckt1/Ckt2 | MCA ⁶ Ckt1/ Ckt2 | MOP ⁷ Ckt1/ Ckt2 |
|-----------|----------------------------|---------------------------|--------|---------------------|--------|---------|-----------|------------------------|-------------------------------|--------------------------------|--------------------------------|-----------------------------------|-----------------------------------|
| 140 | 200/60/3 | 1 | 2 | 12 | 1.5 | 6.5 | 7.3 | 0.83 | 270/270 | 1845/1845 | 600/600 | 691 | 800 |
| | 200/60/3 | 2 | 2 | 6/6 | 1.5 | 6.5 | 7.3 | 0.83 | 270/270 | 1845/1845 | 600/600 | 381/377 | 600/600 |
| | 230/60/3 | 1 | 2 | 12 | 1.5 | 6.5 | 7.3 | 0.83 | 235/235 | 1556/1556 | 506/506 | 612 | 800 |
| | 230/60/3 | 2 | 2 | 6/6 | 1.5 | 6.5 | 7.3 | 0.83 | 235/235 | 1556/1556 | 506/506 | 337/334 | 500/500 |
| | 380/60/3 | 1 | 2 | 12 | 1.5 | 3.5 | 3.7 | 0.83 | 142/142 | 973/973 | 316/316 | 364 | 500 |
| | 380/60/3 | 2 | 2 | 6/6 | 1.5 | 3.5 | 3.7 | 0.83 | 142/142 | 973/973 | 316/316 | 201/199 | 300/300 |
| | 460/60/3 | 1 | 2 | 12 | 1.5 | 3 | 3.7 | 0.83 | 118/118 | 774/774 | 252/252 | 305 | 400 |
| | 460/60/3 | 2 | 2 | 6/6 | 1.5 | 3 | 3.7 | 0.83 | 118/118 | 774/774 | 252/252 | 168/166 | 250/250 |
| | 575/60/3 | 1 | 2 | 12 | 1.5 | 2.5 | 3.0 | 0.83 | 94/94 | 631/631 | 205/205 | 244 | 300 |
| | 575/60/3 | 2 | 2 | 6/6 | 1.5 | 2.5 | 3.0 | 0.83 | 94/94 | 631/631 | 205/205 | 134/133 | 225/225 |
| 155 | 200/60/3 | 1 | 2 | 13 | 1.5 | 6.5 | 7.3 | 0.83 | 320/270 | 2156/1845 | 701/600 | 760 | 1000 |
| | 200/60/3 | 2 | 2 | 7/6 | 1.5 | 6.5 | 7.3 | 0.83 | 320/270 | 2156/1845 | 701/600 | 450/377 | 700/600 |
| | 230/60/3 | 1 | 2 | 13 | 1.5 | 6.5 | 7.3 | 0.83 | 278/235 | 1756/1556 | 571/506 | 672 | 800 |
| | 230/60/3 | 2 | 2 | 7/6 | 1.5 | 6.5 | 7.3 | 0.83 | 278/235 | 1756/1556 | 571/506 | 397/334 | 600/500 |
| | 380/60/3 | 1 | 2 | 13 | 1.5 | 3.5 | 3.7 | 0.83 | 168/142 | 1060/973 | 345/316 | 400 | 500 |
| | 380/60/3 | 2 | 2 | 7/6 | 1.5 | 3.5 | 3.7 | 0.83 | 168/142 | 1060/973 | 345/316 | 237/199 | 400/300 |
| | 460/60/3 | 1 | 2 | 13 | 1.5 | 3 | 3.7 | 0.83 | 139/118 | 878/774 | 285/252 | 334 | 450 |
| | 460/60/3 | 2 | 2 | 7/6 | 1.5 | 3 | 3.7 | 0.83 | 139/118 | 878/774 | 285/252 | 197/166 | 300/250 |
| | 575/60/3 | 1 | 2 | 13 | 1.5 | 2.5 | 3.0 | 0.83 | 111/94 | 705/631 | 229/205 | 268 | 350 |
| | 575/60/3 | 2 | 2 | 7/6 | 1.5 | 2.5 | 3.0 | 0.83 | 111/94 | 705/631 | 229/205 | 158/133 | 250/225 |
| 170 | 200/60/3 | 1 | 2 | 14 | 1.5 | 6.5 | 7.3 | 0.83 | 320/320 | 2156/2156 | 701/701 | 817 | 1000 |
| | 200/60/3 | 2 | 2 | 7/7 | 1.5 | 6.5 | 7.3 | 0.83 | 320/320 | 2156/2156 | 701/701 | 450/446 | 700/700 |
| | 230/60/3 | 1 | 2 | 14 | 1.5 | 6.5 | 7.3 | 0.83 | 278/278 | 1756/1756 | 571/571 | 722 | 800 |
| | 230/60/3 | 2 | 2 | 7/7 | 1.5 | 6.5 | 7.3 | 0.83 | 278/278 | 1756/1756 | 571/571 | 397/394 | 600/600 |
| | 380/60/3 | 1 | 2 | 14 | 1.5 | 3.5 | 3.7 | 0.83 | 168/168 | 1060/1060 | 345/345 | 430 | 500 |
| | 380/60/3 | 2 | 2 | 7/7 | 1.5 | 3.5 | 3.7 | 0.83 | 168/168 | 1060/1060 | 345/345 | 237/235 | 400/400 |
| | 460/60/3 | 1 | 2 | 14 | 1.5 | 3 | 3.7 | 0.83 | 139/139 | 878/878 | 285/285 | 358 | 450 |
| | 460/60/3 | 2 | 2 | 7/7 | 1.5 | 3 | 3.7 | 0.83 | 139/139 | 878/878 | 285/285 | 197/195 | 300/300 |
| | 575/60/3 | 1 | 2 | 14 | 1.5 | 2.5 | 3.0 | 0.83 | 111/111 | 705/705 | 229/229 | 287 | 350 |
| | 575/60/3 | 2 | 2 | 7/7 | 1.5 | 2.5 | 3.0 | 0.83 | 111/111 | 705/705 | 229/229 | 158/157 | 250/250 |
| 185 | 200/60/3 | 1 | 2 | 14 | 1.5 | 6.5 | 7.3 | 0.83 | 386/320 | 2525/2156 | 821/701 | 899 | 1200 |
| | 200/60/3 | 2 | 2 | 8/6 | 1.5 | 6.5 | 7.3 | 0.83 | 386/320 | 2525/2156 | 821/701 | 539/440 | 800/700 |
| | 230/60/3 | 1 | 2 | 14 | 1.5 | 6.5 | 7.3 | 0.83 | 336/278 | 2126/1756 | 691/571 | 794 | 1000 |
| | 230/60/3 | 2 | 2 | 8/6 | 1.5 | 6.5 | 7.3 | 0.83 | 336/278 | 2126/1756 | 691/571 | 476/387 | 800/600 |
| | 380/60/3 | 1 | 2 | 14 | 1.5 | 3.5 | 3.7 | 0.83 | 203/168 | 1306/1060 | 424/345 | 473 | 600 |
| | 380/60/3 | 2 | 2 | 8/6 | 1.5 | 3.5 | 3.7 | 0.83 | 203/168 | 1306/1060 | 424/345 | 284/231 | 450/350 |
| | 460/60/3 | 1 | 2 | 14 | 1.5 | 3 | 3.7 | 0.83 | 168/139 | 1065/878 | 346/285 | 394 | 500 |
| | 460/60/3 | 2 | 2 | 8/6 | 1.5 | 3 | 3.7 | 0.83 | 168/139 | 1065/878 | 346/285 | 237/192 | 400/300 |
| | 575/60/3 | 1 | 2 | 14 | 1.5 | 2.5 | 3.0 | 0.83 | 134/111 | 853/705 | 277/229 | 316 | 450 |
| | 575/60/3 | 2 | 2 | 8/6 | 1.5 | 2.5 | 3.0 | 0.83 | 134/111 | 853/705 | 277/229 | 189/154 | 300/400 |



Electrical Data

Table 17. Extra efficiency – high and wide ambient

| Unit Size | Rated Voltage ¹ | # Power Conn ² | # Comp | # Fan Ckt1/ Ckt2 | Fan kW | Fan FLA | VFD Input | Cntrl kVA ³ | RLA ⁴ Ckt1/Ckt2 | XLRA ⁵ Ckt1/Ckt2 | YLRA ⁵ Ckt1/Ckt2 | MCA ⁶ Ckt1/ Ckt2 | MOP ⁷ Ckt1/ Ckt2 |
|-----------|----------------------------|---------------------------|--------|---------------------|--------|---------|-----------|------------------------|-------------------------------|--------------------------------|--------------------------------|-----------------------------------|-----------------------------------|
| 200 | 200/60/3 | 1 | 2 | 16 | 1.5 | 6.5 | 7.3 | 0.83 | 386/386 | 2525/2525 | 821/821 | 978 | 1200 |
| | 200/60/3 | 2 | 2 | 8/8 | 1.5 | 6.5 | 7.3 | 0.83 | 386/386 | 2525/2525 | 821/821 | 539/535 | 800/800 |
| | 230/60/3 | 1 | 2 | 16 | 1.5 | 6.5 | 7.3 | 0.83 | 336/336 | 2126/2126 | 691/691 | 865 | 1200 |
| | 230/60/3 | 2 | 2 | 8/8 | 1.5 | 6.5 | 7.3 | 0.83 | 336/336 | 2126/2126 | 691/691 | 476/473 | 800/800 |
| | 380/60/3 | 1 | 2 | 16 | 1.5 | 3.5 | 3.7 | 0.83 | 203/203 | 1306/1306 | 424/424 | 515 | 700 |
| | 380/60/3 | 2 | 2 | 8/8 | 1.5 | 3.5 | 3.7 | 0.83 | 203/203 | 1306/1306 | 424/424 | 284/282 | 450/450 |
| | 460/60/3 | 1 | 2 | 16 | 1.5 | 3 | 3.7 | 0.83 | 168/168 | 1065/1065 | 346/346 | 429 | 500 |
| | 460/60/3 | 2 | 2 | 8/8 | 1.5 | 3 | 3.7 | 0.83 | 168/168 | 1065/1065 | 346/346 | 237/235 | 400/400 |
| | 575/60/3 | 1 | 2 | 16 | 1.5 | 2.5 | 3.0 | 0.83 | 134/134 | 853/853 | 277/277 | 344 | 450 |
| | 575/60/3 | 2 | 2 | 8/8 | 1.5 | 2.5 | 3.0 | 0.83 | 134/134 | 853/853 | 277/277 | 189/188 | 300/300 |
| 250 | 200/60/3 | 1 | | | | | | | | n/a | | | |
| | 200/60/3 | 2 | 3 | 12/6 | 1.5 | 6.5 | 7.3 | 1.2 | 270-270/386 | 1845-1845/2525 | 600-600/821 | 691/526 | 800/800 |
| | 230/60/3 | 1 | | | | | | | | n/a | | | |
| | 230/60/3 | 2 | 3 | 12/6 | 1.5 | 6.5 | 7.3 | 1.2 | 235-235/336 | 1556-1556/2126 | 506-506/691 | 612/463 | 700/700 |
| | 380/60/3 | 1 | | | | | | | | n/a | | | |
| | 380/60/3 | 2 | 3 | 12/6 | 1.5 | 3.5 | 3.7 | 1.2 | 142-142/203 | 973-973/1306 | 316-316/424 | 364/277 | 450/450 |
| | 460/60/3 | 1 | 3 | 18 | 1.5 | 3 | 3.7 | 1.2 | 118-118/168 | 774-774/1065 | 252-252/346 | 507 | 600 |
| | 460/60/3 | 2 | 3 | 12/6 | 1.5 | 3 | 3.7 | 1.2 | 118-118/168 | 774-774/1065 | 252-252/346 | 305/231 | 350/350 |
| | 575/60/3 | 1 | 3 | 18 | 1.5 | 2.5 | 3.0 | 1.2 | 94-94/134 | 631-631/853 | 205-205/277 | 407 | 500 |
| | 575/60/3 | 2 | 3 | 12/6 | 1.5 | 2.5 | 3.0 | 1.2 | 94-94/134 | 631-631/853 | 205-205/277 | 244/184 | 300/300 |
| 275 | 200/60/3 | 1 | | | | | | | | n/a | | | |
| | 200/60/3 | 2 | 3 | 14/6 | 1.5 | 6.5 | 7.3 | 1.2 | 320-320/386 | 2156-2156/2525 | 701-701/821 | 817/526 | 1000/800 |
| | 230/60/3 | 1 | | | | | | | | n/a | | | |
| | 230/60/3 | 2 | 3 | 14/6 | 1.5 | 6.5 | 7.3 | 1.2 | 278-278/336 | 1756-1756/2126 | 571-571/691 | 722/463 | 800/700 |
| | 380/60/3 | 1 | | | | | | | | n/a | | | |
| | 380/60/3 | 2 | 3 | 14/6 | 1.5 | 3.5 | 3.7 | 1.2 | 168-168/203 | 1060-1060/1306 | 345-345/424 | 430/277 | 500/450 |
| | 460/60/3 | 1 | 3 | 20 | 1.5 | 3 | 3.7 | 1.2 | 139-139/168 | 878-878/1065 | 285-285/346 | 555 | 700 |
| | 460/60/3 | 2 | 3 | 14/6 | 1.5 | 3 | 3.7 | 1.2 | 139-139/168 | 878-878/1065 | 285-285/346 | 358/231 | 450/350 |
| | 575/60/3 | 1 | 3 | 20 | 1.5 | 2.5 | 3.0 | 1.2 | 111-111/134 | 705-705/853 | 229-229/277 | 446 | 500 |
| | 575/60/3 | 2 | 3 | 14/6 | 1.5 | 2.5 | 3.0 | 1.2 | 111-111/134 | 705-705/853 | 229-229/277 | 287/184 | 350/300 |
| 300 | 200/60/3 | 1 | | | | | | | | n/a | | | |
| | 200/60/3 | 2 | 4 | 12/12 | 1.5 | 6.5 | 7.3 | 1.2 | 270-270/ 270-270 | 1845-1845/ 1845-1845 | 600-600/ 600-600 | 691/691 | 800/800 |
| | 230/60/3 | 1 | | | | | | | | n/a | | | |
| | 230/60/3 | 2 | 4 | 12/12 | 1.5 | 6.5 | 7.3 | 1.2 | 235-235/ 235-235 | 1556-1556/ 1556-1556 | 506-506/ 506-506 | 612/612 | 800/800 |
| | 380/60/3 | 1 | | | | | | | | n/a | | | |
| | 380/60/3 | 2 | 4 | 12/12 | 1.5 | 3.5 | 3.7 | 1.2 | 142-142/ 142-142 | 973-973/ 973-973 | 316-316/ 316-316 | 364/364 | 500/500 |
| | 460/60/3 | 1 | 4 | 24 | 1.5 | 3 | 3.7 | 1.2 | 118-118/ 118-118 | 774-774/ 774-774 | 252-252/ 252-252 | 580 | 600 |
| | 460/60/3 | 2 | 4 | 12/12 | 1.5 | 3 | 3.7 | 1.2 | 118-118/ 118-118 | 774-774/ 774-774 | 252-252/ 252-252 | 305/305 | 400/400 |
| | 575/60/3 | 1 | 4 | 24 | 1.5 | 2.5 | 3.0 | 1.2 | 94-94/ 94-94 | 631-631/ 631-631 | 205-205/ 205-205 | 464 | 500 |
| | 575/60/3 | 2 | 4 | 12/12 | 1.5 | 2.5 | 3.0 | 1.2 | 94-94/ 94-94 | 631-631/ 631-631 | 205-205/ 205-205 | 244/244 | 300/300 |



Electrical Data

Table 17. Extra efficiency – high and wide ambient

| Unit Size | Rated Voltage ¹ | # Power Conn ² | # Comp | # Fan Ckt1/ Ckt2 | Fan kW | Fan FLA | VFD Input | Cntrl kVA ³ | RLA ⁴ Ckt1/Ckt2 | XLRA ⁵ Ckt1/Ckt2 | YLRA ⁵ Ckt1/Ckt2 | MCA ⁶ Ckt1/ Ckt2 | MOP ⁷ Ckt1/ Ckt2 |
|------------|----------------------------|---------------------------|--------|---------------------|--------|---------|-----------|------------------------|-------------------------------|--------------------------------|--------------------------------|-----------------------------------|-----------------------------------|
| 350 | 200/60/3 | 1 | | | | | | | | n/a | | | |
| | 200/60/3 | 2 | 4 | 14/14 | 1.5 | 6.5 | 7.3 | 1.59 | 320-320/ 320-320 | 2156-2156/ 2156-2156 | 701-701/ 701-701 | 817/817 | 1000/1000 |
| | 230/60/3 | 1 | | | | | | | | n/a | | | |
| | 230/60/3 | 2 | 4 | 14/14 | 1.5 | 6.5 | 7.3 | 1.59 | 278-278/ 278-278 | 1756-1756/ 1756-1756 | 571-571/ 571-571 | 722/722 | 1000/1000 |
| | 380/60/3 | 1 | | | | | | | | n/a | | | |
| | 380/60/3 | 2 | 4 | 14/14 | 1.5 | 3.5 | 3.7 | 1.59 | 168-168/ 168-168 | 1060-1060/ 1060-1060 | 345-345/ 345-345 | 430/430 | 500/500 |
| | 460/60/3 | 1 | 4 | 28 | 1.5 | 3 | 3.7 | 1.59 | 139-139/ 139-139 | 878-878/ 878-878 | 285-285/ 285-285 | 681 | 700 |
| | 460/60/3 | 2 | 4 | 14/14 | 1.5 | 3 | 3.7 | 1.59 | 139-139/ 139-139 | 878-878/ 878-878 | 285-285/ 285-285 | 358/358 | 450/450 |
| | 575/60/3 | 1 | 4 | 28 | 1.5 | 2.5 | 3.0 | 1.59 | 111-111/ 111-111 | 705-705/ 705-705 | 229-229/ 229-229 | 547 | 600 |
| | 575/60/3 | 2 | 4 | 14/14 | 1.5 | 2.5 | 3.0 | 1.59 | 111-111/ 111-111 | 705-705/ 705-705 | 229-229/ 229-229 | 287/287 | 350/350 |

Notes:

1. Voltage Utilization Range: +/- 10% of rated voltage. Rated voltage (use range): 200/60/3 (180-220), 230/60/3 (208-254), 380/60/3 (342-418), 460/60/3 (414-506), 575/60/3 (516-633)
2. As standard, 140-250 ton units have a single point power connection. Optional dual point power connections are available. As standard, 275-500 ton units have dual point power connections. Optional single point power connections are available on 460V and 575V/60 Hz units.
3. Control VA includes operational controls only. It does not include evaporator heaters. A separate 115/60/1, 20 amp customer provided power connection is required to power the evaporator heaters (1640 watts).
4. RLA - Rated Load Amps
5. XLRA - Locked Rotor Amps - based on full winding (x-line) start units). YLRA for wye-delta starters is ~1/3 of LRA of x-line units.
6. MCA - Minimum Circuit Ampacity - 125 percent of largest compressor RLA plus 100 percent of all other loads.
7. Max fuse or MOPD = 225 percent of the largest compressor RLA plus 100 percent of the second compressor RLA, plus the sum of the condenser fan FLA. (Use FLA per circuit, NOT FLA for the entire unit).
8. Local codes may take precedence.
9. All ambient means standard, low, high and wide ambient options.



Electrical Data

Table 18. Customer wire selection — standard efficiency

| Unit Size | Volt | Single point power | | | Dual point power - Ckt 1 | | | Dual point power - Ckt 2 | | |
|------------|------|---------------------|--|--|--------------------------|--|--|--------------------------|--|--|
| | | Term | Disc | Circuit Breaker | Term | Disc | Circuit Breaker | Term | Disc | Circuit Breaker |
| 140 | 200 | (2) 4 AWG - 500 MCM | (3) 3/0 - 500 MCM | (3) 3/0 - 500 MCM | (2) 4 AWG - 500 MCM | (2) 2/0 - 500 MCM | (2) 2/0 - 500 MCM | (2) 4 AWG - 500 MCM | (2) 2/0 - 500 MCM | (2) 2/0 - 500 MCM |
| | 230 | (2) 4 AWG - 500 MCM | (3) 3/0 - 500 MCM | (3) 3/0 - 500 MCM | (2) 4 AWG - 500 MCM | (2) 2/0 - 500 MCM | (2) 2/0 - 500 MCM | 4 AWG - 500 MCM | (2) 2/0 - 500 MCM | (2) 2/0 - 500 MCM |
| | 380 | (2) 4 AWG - 500 MCM | (2) 2/0 - 500 MCM | (2) 2/0 - 500 MCM | 4 AWG - 500 MCM | (1) 1 AWG - 600 MCM or (2) 1 AWG - 250 MCM | (1) 1 AWG - 600 MCM or (2) 1 AWG - 250 MCM | 4 AWG - 500 MCM | (1) 1 AWG - 600 MCM or (2) 1 AWG - 250 MCM | (1) 1 AWG - 600 MCM or (2) 1 AWG - 250 MCM |
| | 460 | 4 AWG - 500 MCM | (1) 1 AWG - 600 MCM or (2) 1 AWG - 250 MCM | (1) 1 AWG - 600 MCM or (2) 1 AWG - 250 MCM | 4 AWG - 500 MCM | 3/0-350MCM | 3/0-500MCM | 4 AWG - 500 MCM | 3/0-350MCM | 3/0-500MCM |
| | 575 | 4 AWG - 500 MCM | (1) 1 AWG - 600 MCM or (2) 1 AWG - 250 MCM | (1) 1 AWG - 600 MCM or (2) 1 AWG - 250 MCM | 4 AWG - 500 MCM | 3/0-350MCM | 3/0-500MCM | 4 AWG - 500 MCM | 3/0-350MCM | 3/0-500MCM |
| 155 | 200 | (2) 4 AWG - 500 MCM | (4) 3/0 - 500 MCM | (4) 3/0 - 500 MCM | (2) 4 AWG - 500 MCM | (3) 3/0 - 500 MCM | (3) 3/0 - 500 MCM | (2) 4 AWG - 500 MCM | (2) 2/0 - 500 MCM | (2) 2/0 - 500 MCM |
| | 230 | (2) 4 AWG - 500 MCM | (3) 3/0 - 500 MCM | (3) 3/0 - 500 MCM | (2) 4 AWG - 500 MCM | (2) 2/0 - 500 MCM | (2) 2/0 - 500 MCM | 4 AWG - 500 MCM | (2) 2/0 - 500 MCM | (2) 2/0 - 500 MCM |
| | 380 | (2) 4 AWG - 500 MCM | (2) 2/0 - 500 MCM | (2) 2/0 - 500 MCM | 4 AWG - 500 MCM | (1) 1 AWG - 600 MCM or (2) 1 AWG - 250 MCM | (1) 1 AWG - 600 MCM or (2) 1 AWG - 250 MCM | 4 AWG - 500 MCM | (1) 1 AWG - 600 MCM or (2) 1 AWG - 250 MCM | (1) 1 AWG - 600 MCM or (2) 1 AWG - 250 MCM |
| | 460 | 4 AWG - 500 MCM | (2) 2/0 - 500 MCM | (2) 2/0 - 500 MCM | 4 AWG - 500 MCM | (1) 1 AWG - 600 MCM or (2) 1 AWG - 250 MCM | (1) 1 AWG - 600 MCM or (2) 1 AWG - 250 MCM | 4 AWG - 500 MCM | 3/0-350MCM | 3/0-500MCM |
| | 575 | 4 AWG - 500 MCM | (1) 1 AWG - 600 MCM or (2) 1 AWG - 250 MCM | (1) 1 AWG - 600 MCM or (2) 1 AWG - 250 MCM | 4 AWG - 500 MCM | 3/0-350MCM | 3/0-500MCM | 4 AWG - 500 MCM | 3/0-350MCM | 3/0-500MCM |
| 170 | 200 | (4) 2 AWG - 600 MCM | (4) 3/0 - 500 MCM | (4) 3/0 - 500 MCM | (2) 4 AWG - 500 MCM | (3) 3/0 - 500 MCM | (3) 3/0 - 500 MCM | (2) 4 AWG - 500 MCM | (3) 3/0 - 500 MCM | (3) 3/0 - 500 MCM |
| | 230 | (2) 4 AWG - 500 MCM | (3) 3/0 - 500 MCM | (3) 3/0 - 500 MCM | (2) 4 AWG - 500 MCM | (2) 2/0 - 500 MCM | (2) 2/0 - 500 MCM | (2) 4 AWG - 500 MCM | (2) 2/0 - 500 MCM | (2) 2/0 - 500 MCM |
| | 380 | (2) 4 AWG - 500 MCM | (2) 2/0 - 500 MCM | (2) 2/0 - 500 MCM | 4 AWG - 500 MCM | (1) 1 AWG - 600 MCM or (2) 1 AWG - 250 MCM | (1) 1 AWG - 600 MCM or (2) 1 AWG - 250 MCM | 4 AWG - 500 MCM | (1) 1 AWG - 600 MCM or (2) 1 AWG - 250 MCM | (1) 1 AWG - 600 MCM or (2) 1 AWG - 250 MCM |
| | 460 | (2) 4 AWG - 500 MCM | (2) 2/0 - 500 MCM | (2) 2/0 - 500 MCM | 4 AWG - 500 MCM | (1) 1 AWG - 600 MCM or (2) 1 AWG - 250 MCM | (1) 1 AWG - 600 MCM or (2) 1 AWG - 250 MCM | 4 AWG - 500 MCM | (1) 1 AWG - 600 MCM or (2) 1 AWG - 250 MCM | (1) 1 AWG - 600 MCM or (2) 1 AWG - 250 MCM |
| | 575 | 4 AWG - 500 MCM | (1) 1 AWG - 600 MCM or (2) 1 AWG - 250 MCM | (1) 1 AWG - 600 MCM or (2) 1 AWG - 250 MCM | 4 AWG - 500 MCM | 3/0-350MCM | 3/0-500MCM | 4 AWG - 500 MCM | 3/0-350MCM | 3/0-500MCM |



Electrical Data

Table 18. Customer wire selection — standard efficiency (continued)

| Unit Size | Volt | Single point power | | | Dual point power - Ckt 1 | | | Dual point power - Ckt 2 | | |
|-----------|------|--------------------|------|---------------------|--------------------------|--|--|--------------------------|--|--|
| | | Term | Disc | Circuit Breaker | Term | Disc | Circuit Breaker | Term | Disc | Circuit Breaker |
| 275 | 200 | | n/a | | (4) 4 AWG - 500 MCM | (4) 3/0 - 500 MCM | (4) 3/0 - 500 MCM | (2) 4 AWG - 500 MCM | (3) 3/0 - 500 MCM | (3) 3/0 - 500 MCM |
| | 230 | | n/a | | (2) 4 AWG - 500 MCM | (3) 3/0 - 500 MCM | (3) 3/0 - 500 MCM | 4 AWG - 500 MCM | (3) 3/0 - 500 MCM | (3) 3/0 - 500 MCM |
| | 380 | | n/a | | (2) 4 AWG - 500 MCM | (2) 2/0 - 500 MCM | (2) 2/0 - 500 MCM | 4 AWG - 500 MCM | (2) 2/0 - 500 MCM | (2) 2/0 - 500 MCM |
| | 460 | n/a | | (4) 2 AWG - 600 MCM | (2) 4 AWG - 500 MCM | (2) 2/0 - 500 MCM | (2) 2/0 - 500 MCM | 4 AWG - 500 MCM | (1) 1 AWG - 600 MCM or (2) 1 AWG - 250 MCM | (1) 1 AWG - 600 MCM or (2) 1 AWG - 250 MCM |
| | 575 | n/a | | (4) 2 AWG - 600 MCM | 4 AWG - 500 MCM | (1) 1 AWG - 600 MCM or (2) 1 AWG - 250 MCM | (1) 1 AWG - 600 MCM or (2) 1 AWG - 250 MCM | 4 AWG - 500 MCM | (1) 1 AWG - 600 MCM or (2) 1 AWG - 250 MCM | (1) 1 AWG - 600 MCM or (2) 1 AWG - 250 MCM |
| 300 | 200 | | n/a | | (4) 2 AWG - 600 MCM | (4) 3/0 - 500 MCM | (4) 3/0 - 500 MCM | (2) 4 AWG - 500 MCM | (3) 3/0 - 500 MCM | (3) 3/0 - 500 MCM |
| | 230 | | n/a | | (4) 2 AWG - 600 MCM | (4) 3/0 - 500 MCM | (4) 3/0 - 500 MCM | (2) 4 AWG - 500 MCM | (3) 3/0 - 500 MCM | (3) 3/0 - 500 MCM |
| | 380 | | n/a | | (2) 4 AWG - 500 MCM | (3) 3/0 - 500 MCM | (3) 3/0 - 500 MCM | 4 AWG - 500 MCM | (2) 2/0 - 500 MCM | (2) 2/0 - 500 MCM |
| | 460 | n/a | | (4) 2 AWG - 600 MCM | (2) 4 AWG - 500 MCM | (2) 2/0 - 500 MCM | (2) 2/0 - 500 MCM | 4 AWG - 500 MCM | (1) 1 AWG - 600 MCM or (2) 1 AWG - 250 MCM | (1) 1 AWG - 600 MCM or (2) 1 AWG - 250 MCM |
| | 575 | n/a | | (4) 2 AWG - 600 MCM | (2) 4 AWG - 500 MCM | (2) 2/0 - 500 MCM | (2) 2/0 - 500 MCM | 4 AWG - 500 MCM | (1) 1 AWG - 600 MCM or (2) 1 AWG - 250 MCM | (1) 1 AWG - 600 MCM or (2) 1 AWG - 250 MCM |
| 350 | 200 | | n/a | | (4) 2 AWG - 600 MCM | (4) 3/0 - 500 MCM | (4) 3/0 - 500 MCM | (2) 4 AWG - 500 MCM | (3) 3/0 - 500 MCM | (3) 3/0 - 500 MCM |
| | 230 | | n/a | | (4) 2 AWG - 600 MCM | (4) 3/0 - 500 MCM | (4) 3/0 - 500 MCM | (2) 4 AWG - 500 MCM | (3) 3/0 - 500 MCM | (3) 3/0 - 500 MCM |
| | 380 | | n/a | | (2) 4 AWG - 500 MCM | (3) 3/0 - 500 MCM | (3) 3/0 - 500 MCM | 4 AWG - 500 MCM | (2) 2/0 - 500 MCM | (2) 2/0 - 500 MCM |
| | 460 | n/a | | (4) 2 AWG - 600 MCM | (2) 4 AWG - 500 MCM | (2) 2/0 - 500 MCM | (2) 2/0 - 00 MCM | 4 AWG - 500 MCM | (1) 1 AWG - 600 MCM or (2) 1 AWG - 250 MCM | (1) 1 AWG - 600 MCM or (2) 1 AWG - 250 MCM |
| | 575 | n/a | | (4) 2 AWG - 600 MCM | (2) 4 AWG - 500 MCM | (2) 2/0 - 500 MCM | (2) 2/0 - 500 MCM | 4 AWG - 500 MCM | (1) 1 AWG - 600 MCM or (2) 1 AWG - 250 MCM | (1) 1 AWG - 600 MCM or (2) 1 AWG - 250 MCM |
| 400 | 200 | | n/a | | (4) 2 AWG - 600 MCM | (4) 3/0 - 500 MCM | (4) 3/0 - 500 MCM | (4) 2 AWG - 600 MCM | (4) 3/0 - 500 MCM | (4) 3/0 - 500 MCM |
| | 230 | | n/a | | (4) 2 AWG - 600 MCM | (4) 3/0 - 500 MCM | (4) 3/0 - 500 MCM | (4) 2 AWG - 600 MCM | (4) 3/0 - 500 MCM | (4) 3/0 - 500 MCM |
| | 380 | | n/a | | (2) 4 AWG - 500 MCM | (3) 3/0 - 00 MCM | (3) 3/0 - 500 MCM | (2) 4 AWG - 500 MCM | (3) 3/0 - 500 MCM | (3) 3/0 - 500 MCM |
| | 460 | n/a | | (4) 2 AWG - 600 MCM | (2) 4 AWG - 500 MCM | (2) 2/0 - 500 MCM | (2) 2/0 - 500 MCM | (2) 4 AWG - 500 MCM | (2) 2/0 - 500 MCM | (2) 2/0 - 500 MCM |
| | 575 | n/a | | (4) 2 AWG - 600 MCM | (2) 4 AWG - 500 MCM | (2) 2/0 - 00 MCM | (2) 2/0 - 500 MCM | 4 AWG - 500 MCM | (2) 2/0 - 500 MCM | (2) 2/0 - 500 MCM |

Table 18. Customer wire selection — standard efficiency (continued)

| Unit Size | Volt | Single point power | | | Dual point power - Ckt 1 | | | Dual point power - Ckt 2 | | |
|-----------|------|--------------------|------|---------------------|--------------------------|-------------------|-------------------|--------------------------|-------------------|-------------------|
| | | Term | Disc | Circuit Breaker | Term | Disc | Circuit Breaker | Term | Disc | Circuit Breaker |
| 450 | 200 | | n/a | | (4) 2 AWG - 600 MCM | (4) 3/0 - 500 MCM | (4) 3/0 - 500 MCM | (4) 2 AWG - 600 MCM | (4) 3/0 - 500 MCM | (4) 3/0 - 500 MCM |
| | 230 | | n/a | | (4) 2 AWG - 600 MCM | (4) 3/0 - 500 MCM | (4) 3/0 - 500 MCM | (4) 2 AWG - 600 MCM | (4) 3/0 - 500 MCM | (4) 3/0 - 500 MCM |
| | 380 | | n/a | | (2) 4 AWG - 500 MCM | (3) 3/0 - 500 MCM | (3) 3/0 - 500 MCM | (2) 4 AWG - 500 MCM | (3) 3/0 - 500 MCM | (3) 3/0 - 500 MCM |
| | 460 | | n/a | (4) 2 AWG - 600 MCM | (2) 4 AWG - 500 MCM | (2) 2/0 - 500 MCM | (2) 2/0 - 500 MCM | (2) 4 AWG - 500 MCM | (2) 2/0 - 500 MCM | (2) 2/0 - 500 MCM |
| | 575 | | n/a | (4) 2 AWG - 600 MCM | (2) 4 AWG - 500 MCM | (2) 2/0 - 500 MCM | (2) 2/0 - 500 MCM | 4 AWG - 500 MCM | (2) 2/0 - 500 MCM | (2) 2/0 - 500 MCM |
| 500 | 200 | | n/a | | (4) 2 AWG - 600 MCM | (4) 3/0 - 500 MCM | (4) 3/0 - 500 MCM | (4) 2 AWG - 600 MCM | (4) 3/0 - 500 MCM | (4) 3/0 - 500 MCM |
| | 230 | | n/a | | (4) 2 AWG - 600 MCM | (4) 3/0 - 500 MCM | (4) 3/0 - 500 MCM | (4) 2 AWG - 600 MCM | (4) 3/0 - 500 MCM | (4) 3/0 - 500 MCM |
| | 380 | | n/a | | (2) 4 AWG - 500 MCM | (3) 3/0 - 500 MCM | (3) 3/0 - 500 MCM | (2) 4 AWG - 500 MCM | (3) 3/0 - 500 MCM | (3) 3/0 - 500 MCM |
| | 460 | | n/a | (4) 2 AWG - 600 MCM | (2) 4 AWG - 500 MCM | (2) 2/0 - 500 MCM | (2) 2/0 - 500 MCM | (2) 4 AWG - 500 MCM | (2) 2/0 - 500 MCM | (2) 2/0 - 500 MCM |
| | 575 | | n/a | (4) 2 AWG - 600 MCM | (2) 4 AWG - 500 MCM | (2) 2/0 - 500 MCM | (2) 2/0 - 500 MCM | (2) 4 AWG - 500 MCM | (2) 2/0 - 500 MCM | (2) 2/0 - 500 MCM |

1. Non-fused unit disconnect and circuit breaker are optional.
2. Copper wire only, based on nameplate minimum circuit ampacity (MCA).
3. Circuit breaker sizes are for factory mounted only.
4. n/a - not available



Electrical Data

Table 19. Customer wire selection — high efficiency

| Unit Size | Volt | Ambient | Single point power | | | Dual point power - Ckt 1 | | | Dual point power - Ckt 2 | | |
|------------|------|------------|---------------------|--|--|--------------------------|--|--|--------------------------|--|--|
| | | | Term | Disc | Circuit Breaker | Term | Disc | Circuit Breaker | Term | Disc | Circuit Breaker |
| 140 | 200 | All | (2) 4 AWG - 500 MCM | (3) 3/0 - 500 MCM | (3) 3/0 - 500 MCM | (2) 4 AWG - 500 MCM | (2) 2/0 - 500 MCM | (2) 2/0 - 500 MCM | (2) 4 AWG - 500 MCM | (2) 2/0 - 500 MCM | (2) 2/0 - 500 MCM |
| | 230 | All | (2) 4 AWG - 500 MCM | (3) 3/0 - 500 MCM | (3) 3/0 - 500 MCM | (2) 4 AWG - 500 MCM | (2) 2/0 - 500 MCM | (2) 2/0 - 500 MCM | 4 AWG - 500 MCM | (2) 2/0 - 500 MCM | (2) 2/0 - 500 MCM |
| | 380 | All | (2) 4 AWG - 500 MCM | (2) 2/0 - 500 MCM | (2) 2/0 - 500 MCM | 4 AWG - 500 MCM | (1) 1 AWG - 600 MCM or (2) 1 AWG - 250 MCM | (1) 1 AWG - 600 MCM or (2) 1 AWG - 250 MCM | 4 AWG - 500 MCM | (1) 1 AWG - 600 MCM or (2) 1 AWG - 250 MCM | (1) 1 AWG - 600 MCM or (2) 1 AWG - 250 MCM |
| | 460 | Std, Low | 4 AWG - 500 MCM | (1) 1 AWG - 600 MCM or (2) 1 AWG - 250 MCM | (1) 1 AWG - 600 MCM or (2) 1 AWG - 250 MCM | 4 AWG - 500 MCM | 3/0-350MCM | 3/0-350MCM | 4 AWG - 500 MCM | 3/0-350MCM | 3/0-350MCM |
| | 460 | High, Wide | 4 AWG - 500 MCM | (2) 2/0 - 500 MCM | (2) 2/0 - 500 MCM | 4 AWG - 500 MCM | 3/0-350MCM | 3/0-350MCM | 4 AWG - 500 MCM | 3/0-350MCM | 3/0-350MCM |
| | 575 | All | 4 AWG - 500 MCM | (1) 1 AWG - 600 MCM or (2) 1 AWG - 250 MCM | (1) 1 AWG - 600 MCM or (2) 1 AWG - 250 MCM | 4 AWG - 500 MCM | 3/0-350MCM | 3/0-350MCM | 4 AWG - 500 MCM | 3/0-350MCM | 3/0-350MCM |
| 155 | 200 | All | (2) 4 AWG - 500 MCM | (4) 3/0 - 500 MCM | (4) 3/0 - 500 MCM | (2) 4 AWG - 500 MCM | (3) 3/0 - 500 MCM | (3) 3/0 - 500 MCM | (2) 4 AWG - 500 MCM | (2) 2/0 - 500 MCM | (2) 2/0 - 500 MCM |
| | 230 | All | (2) 4 AWG - 500 MCM | (3) 3/0 - 500 MCM | (3) 3/0 - 500 MCM | (2) 4 AWG - 500 MCM | (2) 2/0 - 500 MCM | (2) 2/0 - 500 MCM | 4 AWG - 500 MCM | (2) 2/0 - 500 MCM | (2) 2/0 - 500 MCM |
| | 380 | All | (2) 4 AWG - 500 MCM | (2) 2/0 - 500 MCM | (2) 2/0 - 500 MCM | 4 AWG - 500 MCM | (1) 1 AWG - 600 MCM or (2) 1 AWG - 250 MCM | (1) 1 AWG - 600 MCM or (2) 1 AWG - 250 MCM | 4 AWG - 500 MCM | (1) 1 AWG - 600 MCM or (2) 1 AWG - 250 MCM | (1) 1 AWG - 600 MCM or (2) 1 AWG - 250 MCM |
| | 460 | Std, Low | 4 AWG - 500 MCM | (1) 1 AWG - 600 MCM or (2) 1 AWG - 250 MCM | (1) 1 AWG - 600 MCM or (2) 1 AWG - 250 MCM | 4 AWG - 500 MCM | (1) 1 AWG - 600 MCM or (2) 1 AWG - 250 MCM | (1) 1 AWG - 600 MCM or (2) 1 AWG - 250 MCM | 4 AWG - 500 MCM | 3/0-350MCM | 3/0-350MCM |
| | 460 | High, Wide | 4 AWG - 500 MCM | (2) 2/0 - 500 MCM | (2) 2/0 - 500 MCM | 4 AWG - 500 MCM | (1) 1 AWG - 600 MCM or (2) 1 AWG - 250 MCM | (1) 1 AWG - 600 MCM or (2) 1 AWG - 250 MCM | 4 AWG - 500 MCM | 3/0-350MCM | 3/0-350MCM |
| | 575 | All | 4 AWG - 500 MCM | (1) 1 AWG - 600 MCM or (2) 1 AWG - 250 MCM | (1) 1 AWG - 600 MCM or (2) 1 AWG - 250 MCM | 4 AWG - 500 MCM | 3/0-350MCM | 3/0-350MCM | 4 AWG - 500 MCM | 3/0-350MCM | 3/0-350MCM |
| 170 | 200 | All | (4) 2 AWG - 600 MCM | (4) 3/0 - 500 MCM | (4) 3/0 - 500 MCM | (2) 4 AWG - 500 MCM | (3) 3/0 - 500 MCM | (3) 3/0 - 500 MCM | (2) 4 AWG - 500 MCM | (3) 3/0 - 500 MCM | (3) 3/0 - 500 MCM |
| | 230 | All | (2) 4 AWG - 500 MCM | (3) 3/0 - 500 MCM | (3) 3/0 - 500 MCM | (2) 4 AWG - 500 MCM | (2) 2/0 - 500 MCM | (2) 2/0 - 500 MCM | (2) 4 AWG - 500 MCM | (2) 2/0 - 500 MCM | (2) 2/0 - 500 MCM |
| | 380 | All | (2) 4 AWG - 500 MCM | (2) 2/0 - 500 MCM | (2) 2/0 - 500 MCM | 4 AWG - 500 MCM | (1) 1 AWG - 600 MCM or (2) 1 AWG - 250 MCM | (1) 1 AWG - 600 MCM or (2) 1 AWG - 250 MCM | 4 AWG - 500 MCM | (1) 1 AWG - 600 MCM or (2) 1 AWG - 250 MCM | (1) 1 AWG - 600 MCM or (2) 1 AWG - 250 MCM |
| | 460 | All | (2) 4 AWG - 500 MCM | (2) 2/0 - 500 MCM | (2) 2/0 - 500 MCM | 4 AWG - 500 MCM | (1) 1 AWG - 600 MCM or (2) 1 AWG - 250 MCM | (1) 1 AWG - 600 MCM or (2) 1 AWG - 250 MCM | 4 AWG - 500 MCM | (1) 1 AWG - 600 MCM or (2) 1 AWG - 250 MCM | (1) 1 AWG - 600 MCM or (2) 1 AWG - 250 MCM |
| | 575 | All | 4 AWG - 500 MCM | (1) 1 AWG - 600 MCM or (2) 1 AWG - 250 MCM | (1) 1 AWG - 600 MCM or (2) 1 AWG - 250 MCM | 4 AWG - 500 MCM | 3/0-350MCM | 3/0-350MCM | 4 AWG - 500 MCM | 3/0-350MCM | 3/0-350MCM |



Electrical Data

Table 19. Customer wire selection — high efficiency (continued)

| Unit Size | Volt | Ambient | Single point power | | | Dual point power - Ckt 1 | | | Dual point power - Ckt 2 | | |
|-----------|------|------------|--------------------|---------------------|---------------------|--------------------------|--|--|--------------------------|--|--|
| | | | Term | Disc | Circuit Breaker | Term | Disc | Circuit Breaker | Term | Disc | Circuit Breaker |
| 275 | 200 | All | | n/a | | (4) 4 AWG - 600 MCM | (4) 3/0 - 500 MCM | (4) 3/0 - 500 MCM | (2) 4 AWG - 500 MCM | (3) 3/0 - 500 MCM | (3) 3/0 - 500 MCM |
| | 230 | All | | n/a | | (2) 4 AWG - 500 MCM | (3) 3/0 - 500 MCM | (4) 3/0 - 500 MCM | (4) 3/0 - 500 MCM | (3) 3/0 - 500 MCM | (3) 3/0 - 500 MCM |
| | 380 | All | | n/a | (4) 2 AWG - 600 MCM | (2) 4 AWG - 500 MCM | (2) 2/0 - 500 MCM | (2) 2/0 - 500 MCM | 4 AWG - 500 MCM | (2) 2/0 - 500 MCM | (2) 2/0 - 500 MCM |
| | 460 | All | | n/a | (4) 2 AWG - 600 MCM | (2) 4 AWG - 500 MCM | (2) 2/0 - 500 MCM | (2) 2/0 - 500 MCM | 4 AWG - 500 MCM | (1) 1 AWG - 600 MCM or (2) 1 AWG - 250 MCM | (1) 1 AWG - 600 MCM or (2) 1 AWG - 250 MCM |
| | 575 | All | | n/a | (4) 2 AWG - 600 MCM | 4 AWG - 500 MCM | (1) 1 AWG - 600 MCM or (2) 1 AWG - 250 MCM | (1) 1 AWG - 600 MCM or (2) 1 AWG - 250 MCM | 4 AWG - 500 MCM | (1) 1 AWG - 600 MCM or (2) 1 AWG - 250 MCM | (1) 1 AWG - 600 MCM or (2) 1 AWG - 250 MCM |
| 300 | 200 | All | | n/a | | (4) 4 AWG - 600 MCM | (4) 3/0 - 500 MCM | (4) 3/0 - 500 MCM | (2) 4 AWG - 500 MCM | (3) 3/0 - 500 MCM | (3) 3/0 - 500 MCM |
| | 230 | All | | n/a | | (4) 4 AWG - 600 MCM | (4) 3/0 - 500 MCM | (4) 3/0 - 500 MCM | (2) 4 AWG - 500 MCM | (3) 3/0 - 500 MCM | (3) 3/0 - 500 MCM |
| | 380 | Std, Low | | n/a | (4) 2 AWG - 600 MCM | (2) 4 AWG - 500 MCM | (2) 2/0 - 500 MCM | (2) 2/0 - 500 MCM | 4 AWG - 500 MCM | (2) 2/0 - 500 MCM | (2) 2/0 - 500 MCM |
| | 380 | High, Wide | | n/a | (4) 2 AWG - 600 MCM | (2) 4 AWG - 500 MCM | (3) 3/0 - 500 MCM | (3) 3/0 - 500 MCM | 4 AWG - 500 MCM | (2) 2/0 - 500 MCM | (2) 2/0 - 500 MCM |
| | 460 | All | | n/a | (4) 2 AWG - 600 MCM | (2) 4 AWG - 500 MCM | (2) 2/0 - 500 MCM | (2) 2/0 - 500 MCM | 4 AWG - 500 MCM | (1) 1 AWG - 600 MCM or (2) 1 AWG - 250 MCM | (1) 1 AWG - 600 MCM or (2) 1 AWG - 250 MCM |
| 350 | 200 | All | | n/a | | (4) 4 AWG - 600 MCM | (4) 3/0 - 500 MCM | (4) 3/0 - 500 MCM | (4) 2 AWG - 600 MCM | (4) 3/0 - 500 MCM | (4) 3/0 - 500 MCM |
| | 230 | All | | n/a | | (2) 4 AWG - 500 MCM | (3) 3/0 - 500 MCM | (3) 3/0 - 500 MCM | (2) 4 AWG - 500 MCM | (3) 3/0 - 500 MCM | (3) 3/0 - 500 MCM |
| | 380 | All | | n/a | (4) 2 AWG - 600 MCM | (2) 4 AWG - 500 MCM | (2) 2/0 - 500 MCM | (2) 2/0 - 500 MCM | (2) 4 AWG - 500 MCM | (2) 2/0 - 500 MCM | (2) 2/0 - 500 MCM |
| | 460 | All | | n/a | (4) 2 AWG - 600 MCM | (2) 4 AWG - 500 MCM | (2) 2/0 - 500 MCM | (2) 2/0 - 500 MCM | (2) 4 AWG - 500 MCM | (2) 2/0 - 500 MCM | (2) 2/0 - 500 MCM |
| | 575 | All | | n/a | (4) 2 AWG - 600 MCM | 4 AWG - 500 MCM | (1) 1 AWG - 600 MCM or (2) 1 AWG - 250 MCM | (1) 1 AWG - 600 MCM or (2) 1 AWG - 250 MCM | 4 AWG - 500 MCM | (1) 1 AWG - 600 MCM or (2) 1 AWG - 250 MCM | (1) 1 AWG - 600 MCM or (2) 1 AWG - 250 MCM |
| 400 | 200 | All | | n/a | | (4) 4 AWG - 600 MCM | (4) 3/0 - 500 MCM | (4) 3/0 - 500 MCM | (4) 2 AWG - 600 MCM | (4) 3/0 - 500 MCM | (4) 3/0 - 500 MCM |
| | 230 | All | | n/a | | (4) 4 AWG - 600 MCM | (4) 3/0 - 500 MCM | (4) 3/0 - 500 MCM | (4) 2 AWG - 600 MCM | (4) 3/0 - 500 MCM | (4) 3/0 - 500 MCM |
| | 380 | Std, Low | | n/a | | (2) 4 AWG - 500 MCM | (2) 2/0 - 500 MCM | (2) 2/0 - 500 MCM | (2) 4 AWG - 500 MCM | (2) 2/0 - 500 MCM | (2) 2/0 - 500 MCM |
| | 380 | High, Wide | | n/a | | (2) 4 AWG - 500 MCM | (3) 3/0 - 500 MCM | (3) 3/0 - 500 MCM | (2) 4 AWG - 500 MCM | (3) 3/0 - 500 MCM | (3) 3/0 - 500 MCM |
| | 460 | All | | n/a | (4) 2 AWG - 600 MCM | (2) 4 AWG - 500 MCM | (2) 2/0 - 500 MCM | (2) 2/0 - 500 MCM | (2) 4 AWG - 500 MCM | (2) 2/0 - 500 MCM | (2) 2/0 - 500 MCM |
| 575 | All | | n/a | (4) 2 AWG - 600 MCM | (2) 4 AWG - 500 MCM | (2) 2/0 - 500 MCM | (2) 2/0 - 500 MCM | (2) 4 AWG - 500 MCM | (2) 2/0 - 500 MCM | (2) 2/0 - 500 MCM | |

1. Non-fused unit disconnect and circuit breaker are optional.
2. Copper wire only, based on nameplate minimum circuit ampacity (MCA).
3. Circuit breaker sizes are for factory mounted only.
4. n/a - not available

Table 20. Customer wire selection – extra efficiency

| Unit Size | Volt | Single point power | | | Dual point power - Ckt 1 | | | Dual point power - Ckt 2 | | |
|------------|------|---------------------|--------------------------------------|--------------------------------------|--------------------------|--------------------------------------|--------------------------------------|--------------------------|--------------------------------------|--------------------------------------|
| | | Term | Disc | Circuit Breaker | Term | Disc | Circuit Breaker | Term | Disc | Circuit Breaker |
| 140 | 200 | (2) 4 AWG - 500 MCM | (3) 3/0 - 500 MCM | (3) 3/0 - 500 MCM | (2) 4 AWG - 500 MCM | (2) 2/0 - 500 MCM | (2) 2/0 - 500 MCM | (2) 4 AWG - 500 MCM | (2) 2/0 - 500 MCM | (2) 2/0 - 500 MCM |
| | 230 | (2) 4 AWG - 500 MCM | (3) 3/0 - 500 MCM | (3) 3/0 - 500 MCM | (2) 4 AWG - 500 MCM | (2) 2/0 - 500 MCM | (2) 2/0 - 500 MCM | 4 AWG - 500 MCM | (2) 2/0 - 500 MCM | (2) 2/0 - 500 MCM |
| | 380 | (2) 4 AWG - 500 MCM | (2) 2/0 - 500 MCM | (2) 2/0 - 500 MCM | 4 AWG - 500 MCM | (1) #1 - 600 MCM or (2) #1 - 250 MCM | (1) #1 - 600 MCM or (2) #1 - 250 MCM | 4 AWG - 500 MCM | (1) #1 - 600 MCM or (2) #1 - 250 MCM | (1) #1 - 600 MCM or (2) #1 - 250 MCM |
| | 460 | 4 AWG - 500 MCM | (1) #1 - 600 MCM or (2) #1 - 250 MCM | (1) #1 - 600 MCM or (2) #1 - 250 MCM | 4 AWG - 500 MCM | 3/0-350MCM | 3/0-350MCM | 4 AWG - 500 MCM | 3/0-350MCM | 3/0-350MCM |
| | 575 | 4 AWG - 500 MCM | (1) #1 - 600 MCM or (2) #1 - 250 MCM | (1) #1 - 600 MCM or (2) #1 - 250 MCM | 4 AWG - 500 MCM | 3/0-350MCM | 3/0-350MCM | 4 AWG - 500 MCM | 3/0-350MCM | 3/0-350MCM |
| 155 | 200 | (2) 4 AWG - 500 MCM | (4) 3/0 - 500 MCM | (4) 3/0 - 500 MCM | (2) 4 AWG - 500 MCM | (3) 3/0 - 500 MCM | (3) 3/0 - 500 MCM | (2) 4 AWG - 500 MCM | (2) 2/0 - 500 MCM | (2) 2/0 - 500 MCM |
| | 230 | (2) 4 AWG - 500 MCM | (3) 3/0 - 500 MCM | (3) 3/0 - 500 MCM | (2) 4 AWG - 500 MCM | (2) 2/0 - 500 MCM | (2) 2/0 - 500 MCM | 4 AWG - 500 MCM | (2) 2/0 - 500 MCM | (2) 2/0 - 500 MCM |
| | 380 | (2) 4 AWG - 500 MCM | (2) 2/0 - 500 MCM | (2) 2/0 - 500 MCM | 4 AWG - 500 MCM | (1) #1 - 600 MCM or (2) #1 - 250 MCM | (1) #1 - 600 MCM or (2) #1 - 250 MCM | 4 AWG - 500 MCM | (1) #1 - 600 MCM or (2) #1 - 250 MCM | (1) #1 - 600 MCM or (2) #1 - 250 MCM |
| | 460 | 4 AWG - 500 MCM | (2) 2/0 - 500 MCM | (2) 2/0 - 500 MCM | 4 AWG - 500 MCM | (1) #1 - 600 MCM or (2) #1 - 250 MCM | (1) #1 - 600 MCM or (2) #1 - 250 MCM | 4 AWG - 500 MCM | 3/0-350MCM | 3/0-500MCM |
| | 575 | 4 AWG - 500 MCM | (1) #1 - 600 MCM or (2) #1 - 250 MCM | (1) #1 - 600 MCM or (2) #1 - 250 MCM | 4 AWG - 500 MCM | 3/0-350MCM | 3/0-350MCM | 4 AWG - 500 MCM | 3/0-350MCM | 3/0-350MCM |
| 170 | 200 | (4) 2 AWG - 600 MCM | (4) 3/0 - 500 MCM | (4) 3/0 - 500 MCM | (2) 4 AWG - 500 MCM | (3) 3/0 - 500 MCM | (3) 3/0 - 500 MCM | (2) 4 AWG - 500 MCM | (3) 3/0 - 500 MCM | (3) 3/0 - 500 MCM |
| | 230 | (2) 4 AWG - 500 MCM | (3) 3/0 - 500 MCM | (3) 3/0 - 500 MCM | (2) 4 AWG - 500 MCM | (2) 2/0 - 500 MCM | (2) 2/0 - 500 MCM | (2) 4 AWG - 500 MCM | (2) 2/0 - 500 MCM | (2) 2/0 - 500 MCM |
| | 380 | (2) 4 AWG - 500 MCM | (2) 2/0 - 500 MCM | (2) 2/0 - 500 MCM | 4 AWG - 500 MCM | (1) #1 - 600 MCM or (2) #1 - 250 MCM | (1) #1 - 600 MCM or (2) #1 - 250 MCM | 4 AWG - 500 MCM | (1) #1 - 600 MCM or (2) #1 - 250 MCM | (1) #1 - 600 MCM or (2) #1 - 250 MCM |
| | 460 | (2) 4 AWG - 500 MCM | (2) 2/0 - 500 MCM | (2) 2/0 - 500 MCM | 4 AWG - 500 MCM | (1) #1 - 600 MCM or (2) #1 - 250 MCM | (1) #1 - 600 MCM or (2) #1 - 250 MCM | 4 AWG - 500 MCM | (1) #1 - 600 MCM or (2) #1 - 250 MCM | (1) #1 - 600 MCM or (2) #1 - 250 MCM |
| | 575 | 4 AWG - 500 MCM | (1) #1 - 600 MCM or (2) #1 - 250 MCM | (1) #1 - 600 MCM or (2) #1 - 250 MCM | 4 AWG - 500 MCM | 3/0-350MCM | 3/0-350MCM | 4 AWG - 500 MCM | 3/0-350MCM | 3/0-350MCM |



Electrical Data

Table 20. Customer wire selection – extra efficiency (continued)

| Unit Size | Volt | Single point power | | | Dual point power - Ckt 1 | | | Dual point power - Ckt 2 | | |
|-----------|------|---------------------|--------------------------------------|--------------------------------------|--------------------------|--------------------------------------|--------------------------------------|--------------------------|--------------------------------------|--------------------------------------|
| | | Term | Disc | Circuit Breaker | Term | Disc | Circuit Breaker | Term | Disc | Circuit Breaker |
| 185 | 200 | (4) 2 AWG - 600 MCM | (4) 3/0 - 500 MCM | (4) 3/0 - 500 MCM | (2) 4 AWG - 500 MCM | (3) 3/0 - 500 MCM | (3) 3/0 - 500 MCM | (2) 4 AWG - 500 MCM | (3) 3/0 - 500 MCM | (3) 3/0 - 500 MCM |
| | 230 | (4) 2 AWG - 600 MCM | (4) 3/0 - 500 MCM | (4) 3/0 - 500 MCM | (2) 4 AWG - 500 MCM | (3) 3/0 - 500 MCM | (3) 3/0 - 500 MCM | (2) 4 AWG - 500 MCM | (2) 2/0 - 500 MCM | (2) 2/0 - 500 MCM |
| | 380 | (2) 4 AWG - 500 MCM | (2) 2/0 - 500 MCM | (2) 2/0 - 500 MCM | 4 AWG - 500 MCM | (2) 2/0 - 500 MCM | (2) 2/0 - 500 MCM | 4 AWG - 500 MCM | (1) #1 - 600 MCM or (2) #1 - 250 MCM | (1) #1 - 600 MCM or (2) #1 - 250 MCM |
| | 460 | (2) 4 AWG - 500 MCM | (2) 2/0 - 500 MCM | (2) 2/0 - 500 MCM | 4 AWG - 500 MCM | (1) #1 - 600 MCM or (2) #1 - 250 MCM | (1) #1 - 600 MCM or (2) #1 - 250 MCM | 4 AWG - 500 MCM | (1) #1 - 600 MCM or (2) #1 - 250 MCM | (1) #1 - 600 MCM or (2) #1 - 250 MCM |
| | 575 | 4 AWG - 500 MCM | (1) #1 - 600 MCM or (2) #1 - 250 MCM | (1) #1 - 600 MCM or (2) #1 - 250 MCM | 4 AWG - 500 MCM | (1) #1 - 600 MCM or (2) #1 - 250 MCM | (1) #1 - 600 MCM or (2) #1 - 250 MCM | 4 AWG - 500 MCM | 3/0-350MCM | 3/0-500MCM |
| 200 | 200A | (4) 2 AWG - 600 MCM | (4) 3/0 - 500 MCM | (4) 3/0 - 500 MCM | (2) 4 AWG - 500 MCM | (3) 3/0 - 500 MCM | (3) 3/0 - 500 MCM | (2) 4 AWG - 500 MCM | (3) 3/0 - 500 MCM | (3) 3/0 - 500 MCM |
| | 230A | (4) 2 AWG - 600 MCM | (4) 3/0 - 500 MCM | (4) 3/0 - 500 MCM | (2) 4 AWG - 500 MCM | (3) 3/0 - 500 MCM | (3) 3/0 - 500 MCM | (2) 4 AWG - 500 MCM | (3) 3/0 - 500 MCM | (3) 3/0 - 500 MCM |
| | 380A | (2) 4 AWG - 500 MCM | (3) 3/0 - 500 MCM | (3) 3/0 - 500 MCM | 4 AWG - 500 MCM | (2) 2/0 - 500 MCM | (2) 2/0 - 500 MCM | 4 AWG - 500 MCM | (2) 2/0 - 500 MCM | (2) 2/0 - 500 MCM |
| | 460A | (2) 4 AWG - 500 MCM | (2) 2/0 - 500 MCM | (2) 2/0 - 500 MCM | 4 AWG - 500 MCM | (1) #1 - 600 MCM or (2) #1 - 250 MCM | (1) #1 - 600 MCM or (2) #1 - 250 MCM | 4 AWG - 500 MCM | (1) #1 - 600 MCM or (2) #1 - 250 MCM | (1) #1 - 600 MCM or (2) #1 - 250 MCM |
| | 575A | (2) 4 AWG - 500 MCM | (2) 2/0 - 500 MCM | (2) 2/0 - 500 MCM | 4 AWG - 500 MCM | (1) #1 - 600 MCM or (2) #1 - 250 MCM | (1) #1 - 600 MCM or (2) #1 - 250 MCM | 4 AWG - 500 MCM | (1) #1 - 600 MCM or (2) #1 - 250 MCM | (1) #1 - 600 MCM or (2) #1 - 250 MCM |
| 250 | 200A | | n/a | | (2) 4 AWG - 500 MCM | (3) 3/0 - 500 MCM | (3) 3/0 - 500 MCM | (2) 4 AWG - 500 MCM | (3) 3/0 - 500 MCM | (3) 3/0 - 500 MCM |
| | 230A | | n/a | | (2) 4 AWG - 500 MCM | (3) 3/0 - 500 MCM | (3) 3/0 - 500 MCM | (2) 4 AWG - 500 MCM | (3) 3/0 - 500 MCM | (3) 3/0 - 500 MCM |
| | 380A | n/a | | (4) 2 AWG - 600 MCM | (2) 4 AWG - 500 MCM | (2) 2/0 - 500 MCM | (2) 2/0 - 500 MCM | 4 AWG - 500 MCM | (2) 2/0 - 500 MCM | (2) 2/0 - 500 MCM |
| | 460A | n/a | | (4) 2 AWG - 600 MCM | 4 AWG - 500 MCM | (2) 2/0 - 500 MCM | (1) #1 - 600 MCM or (2) #1 - 250 MCM | 4 AWG - 500 MCM | (1) #1 - 600 MCM or (2) #1 - 250 MCM | (1) #1 - 600 MCM or (2) #1 - 250 MCM |
| | 575A | n/a | | (4) 2 AWG - 600 MCM | 4 AWG - 500 MCM | (1) #1 - 600 MCM or (2) #1 - 250 MCM | (1) #1 - 600 MCM or (2) #1 - 250 MCM | 4 AWG - 500 MCM | (1) #1 - 600 MCM or (2) #1 - 250 MCM | (1) #1 - 600 MCM or (2) #1 - 250 MCM |
| 275 | 200A | | n/a | | (4) 2 AWG - 600 MCM | (4) 3/0 - 500 MCM | (4) 3/0 - 500 MCM | (2) 4 AWG - 500 MCM | (3) 3/0 - 500 MCM | (3) 3/0 - 500 MCM |
| | 230A | | n/a | | (2) 4 AWG - 500 MCM | (3) 3/0 - 500 MCM | (3) 3/0 - 500 MCM | (2) 4 AWG - 500 MCM | (3) 3/0 - 500 MCM | (3) 3/0 - 500 MCM |
| | 380A | | n/a | | (2) 4 AWG - 500 MCM | (2) 2/0 - 500 MCM | (2) 2/0 - 500 MCM | 4 AWG - 500 MCM | (2) 2/0 - 500 MCM | (2) 2/0 - 500 MCM |
| | 460A | n/a | | (4) 2 AWG - 600 MCM | (2) 4 AWG - 500 MCM | (2) 2/0 - 500 MCM | (2) 2/0 - 500 MCM | 4 AWG - 500 MCM | (1) #1 - 600 MCM or (2) #1 - 250 MCM | (1) #1 - 600 MCM or (2) #1 - 250 MCM |
| | 575A | n/a | | (4) 2 AWG - 600 MCM | 4 AWG - 500 MCM | (1) #1 - 600 MCM or (2) #1 - 250 MCM | (1) #1 - 600 MCM or (2) #1 - 250 MCM | 4 AWG - 500 MCM | (1) #1 - 600 MCM or (2) #1 - 250 MCM | (1) #1 - 600 MCM or (2) #1 - 250 MCM |

Table 20. Customer wire selection – extra efficiency (continued)

| Unit Size | Volt | Single point power | | | Dual point power - Ckt 1 | | | Dual point power - Ckt 2 | | |
|-----------|------|--------------------|------|---------------------|--------------------------|--------------------------------------|--------------------------------------|--------------------------|--------------------------------------|--------------------------------------|
| | | Term | Disc | Circuit Breaker | Term | Disc | Circuit Breaker | Term | Disc | Circuit Breaker |
| 300 | 200A | | n/a | | (2) 4 AWG - 500 MCM | (3) 3/0 - 500 MCM | (3) 3/0 - 500 MCM | (2) 4 AWG - 500 MCM | (3) 3/0 - 500 MCM | (3) 3/0 - 500 MCM |
| | 230A | | n/a | | (2) 4 AWG - 500 MCM | (3) 3/0 - 500 MCM | (3) 3/0 - 500 MCM | (2) 4 AWG - 500 MCM | (3) 3/0 - 500 MCM | (3) 3/0 - 500 MCM |
| | 380A | | n/a | (4) 2 AWG - 600 MCM | (2) 4 AWG - 500 MCM | (2) 2/0 - 500 MCM | (2) 2/0 - 500 MCM | (2) 4 AWG - 500 MCM | (2) 2/0 - 500 MCM | (2) 2/0 - 500 MCM |
| | 460A | | n/a | (4) 2 AWG - 600 MCM | 4 AWG - 500 MCM | (1) #1 - 600 MCM or (2) #1 - 250 MCM | (1) #1 - 600 MCM or (2) #1 - 250 MCM | 4 AWG - 500 MCM | (1) #1 - 600 MCM or (2) #1 - 250 MCM | (1) #1 - 600 MCM or (2) #1 - 250 MCM |
| | 575A | | n/a | (4) 2 AWG - 600 MCM | 4 AWG - 500 MCM | (1) #1 - 600 MCM or (2) #1 - 250 MCM | (1) #1 - 600 MCM or (2) #1 - 250 MCM | 4 AWG - 500 MCM | (1) #1 - 600 MCM or (2) #1 - 250 MCM | (1) #1 - 600 MCM or (2) #1 - 250 MCM |
| 350 | 200A | | n/a | | (4) 2 AWG - 600 MCM | (4) 3/0 - 500 MCM | (4) 3/0 - 500 MCM | (4) 2 AWG - 600 MCM | (4) 3/0 - 500 MCM | (4) 3/0 - 500 MCM |
| | 230A | | n/a | | (2) 4 AWG - 500 MCM | (3) 3/0 - 500 MCM | (3) 3/0 - 500 MCM | (2) 4 AWG - 500 MCM | (3) 3/0 - 500 MCM | (3) 3/0 - 500 MCM |
| | 380A | | n/a | | (2) 4 AWG - 500 MCM | (2) 2/0 - 500 MCM | (2) 2/0 - 500 MCM | (2) 4 AWG - 500 MCM | (2) 2/0 - 500 MCM | (2) 2/0 - 500 MCM |
| | 460A | | n/a | (4) 2 AWG - 600 MCM | (2) 4 AWG - 500 MCM | (2) 2/0 - 500 MCM | (2) 2/0 - 500 MCM | (2) 4 AWG - 500 MCM | (2) 2/0 - 500 MCM | (2) 2/0 - 500 MCM |
| | 575A | | n/a | (4) 2 AWG - 600 MCM | 4 AWG - 500 MCM | (1) #1 - 600 MCM or (2) #1 - 250 MCM | (1) #1 - 600 MCM or (2) #1 - 250 MCM | 4 AWG - 500 MCM | (1) #1 - 600 MCM or (2) #1 - 250 MCM | (1) #1 - 600 MCM or (2) #1 - 250 MCM |

1. Non-fused unit disconnect and circuit breaker are optional.
2. Copper wire only, based on nameplate minimum circuit ampacity (MCA).
3. Circuit breaker sizes are for factory mounted only.
4. n/a - not available



Electrical Connection

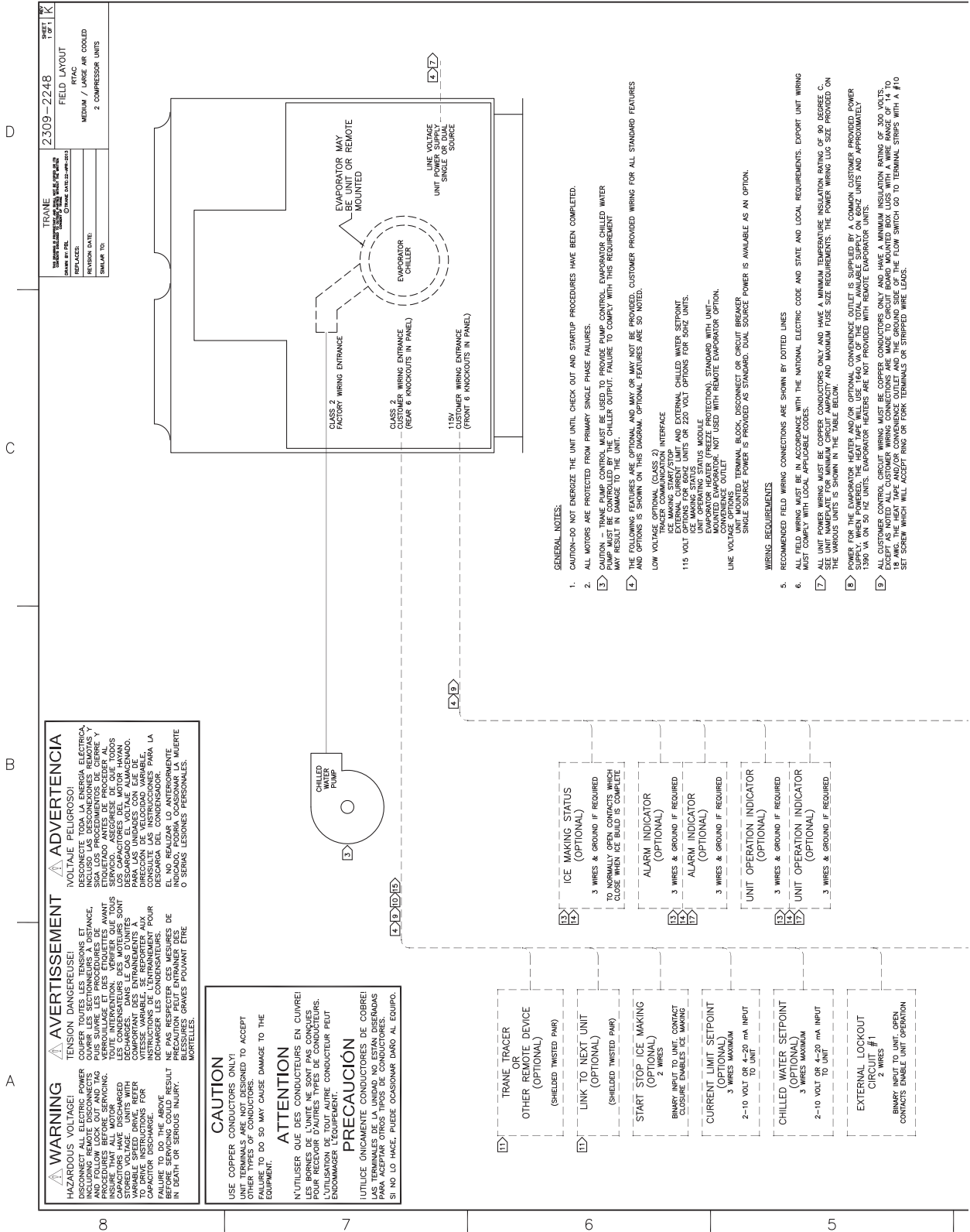

- 10) DO NOT RUN LOW VOLTAGE CONTROL WIRING (20 VOLTS OR LESS) IN CONDUIT WITH 110 VOLT OR HIGHER WIRING. DO NOT EXCEED THE FOLLOWING MAXIMUM RUN LENGTHS FOR A GIVEN SIZE: 14 AWG, 5000 FT; 16 AWG, 2000 FT; 18 AWG, 1000FT
- 11) SHIELDED TWISTED PAIR LEADS ARE REQUIRED FOR CONNECTIONS TO THE COMMUNICATIONS INTERFACE MODULE (1UB OR 1U24). THE SHIELD SHOULD BE GROUND AT THE RAC CONTROL PANEL END.
- 12) THE CONTACTS FOR THESE FEATURES ARE JUMPERED AT THE FACTORY BY JUMPERS W1 & W2 TO ENABLE UNIT OPERATION. IF REMOTE CONTROL IS DESIRED REMOVE THE NOTED JUMPERS AND CONNECT TO THE DESIRED CONTROL CIRCUIT.
- 13) FIELD PROVIDED 120 VOLT 60 HZ OR 220 VOLT 50 HZ CONTROL POWER SUPPLIES ARE REQUIRED. THE MAX FUSE SIZE FOR EVAPORATOR LEADER ALL OTHER FIELD PROVIDED CIRCUITS IS 15 AMPS. GROUND ALL CUSTOMER PROVIDED POWER SUPPLIES AS REQUIRED BY CODE. GREEN GROUND SCREWS ARE PROVIDED IN UNIT CONTROL PANEL.
- 14) CONTACT RATINGS AND REQUIREMENTS
- 15) UNIT PROVIDED DRY CONTACTS FOR THE EVAPORATOR PUMP CONTROL, THE UNIT OPERATING STATUS RELAYS AND ICE MAKING STATUS RELAY GENERAL PURPOSE JURY AT 240 VOLTS.
- 16) CUSTOMER SUPPLIED CONTACTS FOR ALL CLASS 2 CONNECTIONS MUST BE COMPATIBLE WITH DRY CIRCUIT 24 VOLTS DC FOR A 12 mA RESISTIVE LOAD. SILVER OR GOLD PLATED CONTACTS ARE RECOMMENDED.
- 17) FLOW SWITCH & INTERLOCK CONTACTS MUST BE ACCEPTABLE FOR USE IN A 24 VOLT 12 mA CIRCUIT.

THE NORMALLY OPEN CONTACTS ON EACH RELAY OPERATE AS FOLLOWS:
 1) THE UNIT OPERATING STATUS RELAY IS NORMALLY OPEN. IT CLOSURES WHEN THE UNIT OPERATING INDICATOR CLOSES WHEN ANY COMPRESSOR IS RUNNING.
 2) THE MAX UNIT CAPACITY INDICATOR CLOSE WHEN ANY COMPRESSOR IS RUNNING.
 CONTACTS TO THE LIMITED UNIT OPERATION INDICATOR CLOSE IF NORMAL UNIT OPERATION IS RESTRICTED BY SOME OPERATING PARAMETERS.

| REPLACEMENT FUSE SIZES | | | | |
|--|------------|-----------------|----------------|-------|
| FUSE PROTECT FUNCTION | UNIT SIZE | UNIT VOLTAGE/HZ | VOLTS | CLASS |
| CONDENSER FANS | 120 TO 250 | ALL | 1F1 THRU 1F12 | CC |
| | 200/60 | ALL | 1F1 THRU 1F12 | CC |
| | 230/60 | ALL | 1F1 THRU 1F12 | CC |
| CONTROL POWER TRANSFORMER PRIMARY | ALL | ALL | 1F13, 1F14 | CC |
| | ALL | ALL | 1F13, 1F14 | CC |
| CONTROL POWER TRANSFORMER 1S, 1S1, SEC. | ALL | ALL | 1F15 | CC |
| | ALL | ALL | 1F15 | CC |
| CONTROL POWER TRANSFORMER 2A, 1S1, SEC. | ALL | ALL BUT 575/60 | 1F16 & 1F17 | CC |
| | ALL | ALL | 1F16 & 1F17 | CC |
| INVERTER DRIVE AND/OR INVERTER TRANSFORMER PH. | ALL | ALL BUT 575/60 | 1F18 THRU 1F23 | CC |
| | ALL | ALL | 1F18 THRU 1F23 | CC |

- 12) EXTERNAL LOCKOUT CIRCUIT #2
BINARY INPUT TO UNIT. OPEN CONTACTS ENABLE UNIT OPERATION
- 13) AUTO STOP
2 WIRES
- 14) EMERGENCY STOP
2 WIRES
- 15) CHILLED WATER PUMP SWITCH INTERLOCKS
(OPTIONAL)
3 WIRES
- 16) BINARY INPUT TO UNIT. CONTACT CLOSURE INDICATES CHILLED WATER LOW
- 17) MAXIMUM UNIT CAPACITY INDICATOR (OPTIONAL)
3 WIRES & GROUND IF REQUIRED
- 18) LIMITED UNIT OPERATION INDICATOR (OPTIONAL)
3 WIRES & GROUND IF REQUIRED
- 19) EVAPORATOR HEATER AND/OR CONVENIENCE OUTLET (OPTIONAL)
2 WIRES & GROUND IF REQUIRED
- 20) TRANE CHILLED WATER PUMP CONTROL
3 WIRES MINIMUM & GROUND IF REQUIRED

WIRE SIZE RANGE FOR FACTORY PROVIDED LUGS FOR CUSTOMER POWER WIRING CONNECTIONS

| VOLTAGE | SINGLE SOURCE POWER ELECTRICAL CIRCUIT 1 & 2 | | ELECTRICAL CIRCUIT 1 DUAL SOURCE POWER | | ELECTRICAL CIRCUIT 2 DUAL SOURCE POWER | |
|----------|--|-------------------------|--|-----------------------|--|-----------------------|
| | UNIT SIZE (TONS) & EFFICIENCY SE, HE & XE | LUG WIRE SIZE RANGE | UNIT SIZE (TONS) & EFFICIENCY SE, HE & XE | LUG WIRE SIZE RANGE | UNIT SIZE (TONS) & EFFICIENCY SE, HE & XE | LUG WIRE SIZE RANGE |
| 200/60/3 | 140, 155, 170, 185, 200 SE/HE/XE; 225, 250 SE/HE | THREE 1/0 AWG - 500 MCM | 140, 155, 170, 185, 200 SE/HE/XE; 225, 250 SE/HE | TWO 3/0 AWG - 500 MCM | 140, 155, 170, 185, 200 SE/HE/XE; 225, 250 SE/HE | TWO 3/0 AWG - 500 MCM |
| 230/60/3 | 140, 155, 170, 185, 200 SE/HE/XE; 225, 250 SE/HE | THREE 1/0 AWG - 500 MCM | 140, 155, 170, 185, 200 SE/HE/XE; 225, 250 SE/HE | TWO 3/0 AWG - 500 MCM | 140, 155, 170, 185, 200 SE/HE/XE; 225, 250 SE/HE | TWO 3/0 AWG - 500 MCM |
| 360/60/3 | 140, 155, 170, 185, 200 SE/HE/XE; 225, 250 SE/HE | THREE 1/0 AWG - 500 MCM | 140, 155, 170, 185, 200 SE/HE/XE; 225, 250 SE/HE | TWO 3/0 AWG - 500 MCM | 140, 155, 170, 185, 200 SE/HE/XE; 225, 250 SE/HE | TWO 3/0 AWG - 500 MCM |
| 460/60/3 | 140, 155, 170, 185, 200 SE/HE/XE; 225, 250 SE/HE | THREE 1/0 AWG - 500 MCM | 140, 155, 170, 185, 200 SE/HE/XE; 225, 250 SE/HE | TWO 3/0 AWG - 500 MCM | 140, 155, 170, 185, 200 SE/HE/XE; 225, 250 SE/HE | TWO 3/0 AWG - 500 MCM |
| 575/60/3 | 140, 155, 170, 185, 200 SE/HE/XE; 225, 250 SE/HE | THREE 1/0 AWG - 500 MCM | 140, 155, 170, 185, 200 SE/HE/XE; 225, 250 SE/HE | TWO 3/0 AWG - 500 MCM | 140, 155, 170, 185, 200 SE/HE/XE; 225, 250 SE/HE | TWO 3/0 AWG - 500 MCM |
| 400/50/3 | 140, 155, 170, 185, 200 SE/HE/XE; 225, 250 SE/HE | THREE 1/0 AWG - 500 MCM | 140, 155, 170, 185, 200 SE/HE/XE; 225, 250 SE/HE | TWO 3/0 AWG - 500 MCM | 140, 155, 170, 185, 200 SE/HE/XE; 225, 250 SE/HE | TWO 3/0 AWG - 500 MCM |
| 200/60/3 | 140, 155, 170, 185, 200 SE/HE/XE; 225, 250 SE/HE | THREE 1/0 AWG - 500 MCM | 140, 155, 170, 185, 200 SE/HE/XE; 225, 250 SE/HE | TWO 3/0 AWG - 500 MCM | 140, 155, 170, 185, 200 SE/HE/XE; 225, 250 SE/HE | TWO 3/0 AWG - 500 MCM |
| 230/60/3 | 140, 155, 170, 185, 200 SE/HE/XE; 225, 250 SE/HE | THREE 1/0 AWG - 500 MCM | 140, 155, 170, 185, 200 SE/HE/XE; 225, 250 SE/HE | TWO 3/0 AWG - 500 MCM | 140, 155, 170, 185, 200 SE/HE/XE; 225, 250 SE/HE | TWO 3/0 AWG - 500 MCM |
| 360/60/3 | 140, 155, 170, 185, 200 SE/HE/XE; 225, 250 SE/HE | THREE 1/0 AWG - 500 MCM | 140, 155, 170, 185, 200 SE/HE/XE; 225, 250 SE/HE | TWO 3/0 AWG - 500 MCM | 140, 155, 170, 185, 200 SE/HE/XE; 225, 250 SE/HE | TWO 3/0 AWG - 500 MCM |
| 460/60/3 | 140, 155, 170, 185, 200 SE/HE/XE; 225, 250 SE/HE | THREE 1/0 AWG - 500 MCM | 140, 155, 170, 185, 200 SE/HE/XE; 225, 250 SE/HE | TWO 3/0 AWG - 500 MCM | 140, 155, 170, 185, 200 SE/HE/XE; 225, 250 SE/HE | TWO 3/0 AWG - 500 MCM |
| 575/60/3 | 140, 155, 170, 185, 200 SE/HE/XE; 225, 250 SE/HE | THREE 1/0 AWG - 500 MCM | 140, 155, 170, 185, 200 SE/HE/XE; 225, 250 SE/HE | TWO 3/0 AWG - 500 MCM | 140, 155, 170, 185, 200 SE/HE/XE; 225, 250 SE/HE | TWO 3/0 AWG - 500 MCM |
| 400/50/3 | 140, 155, 170, 185, 200 SE/HE/XE; 225, 250 SE/HE | THREE 1/0 AWG - 500 MCM | 140, 155, 170, 185, 200 SE/HE/XE; 225, 250 SE/HE | TWO 3/0 AWG - 500 MCM | 140, 155, 170, 185, 200 SE/HE/XE; 225, 250 SE/HE | TWO 3/0 AWG - 500 MCM |

SE = STANDARD EFFICIENCY UNITS / HE = HIGH EFFICIENCY UNITS / XE = EXTRA EFFICIENCY UNITS

Electrical Connection

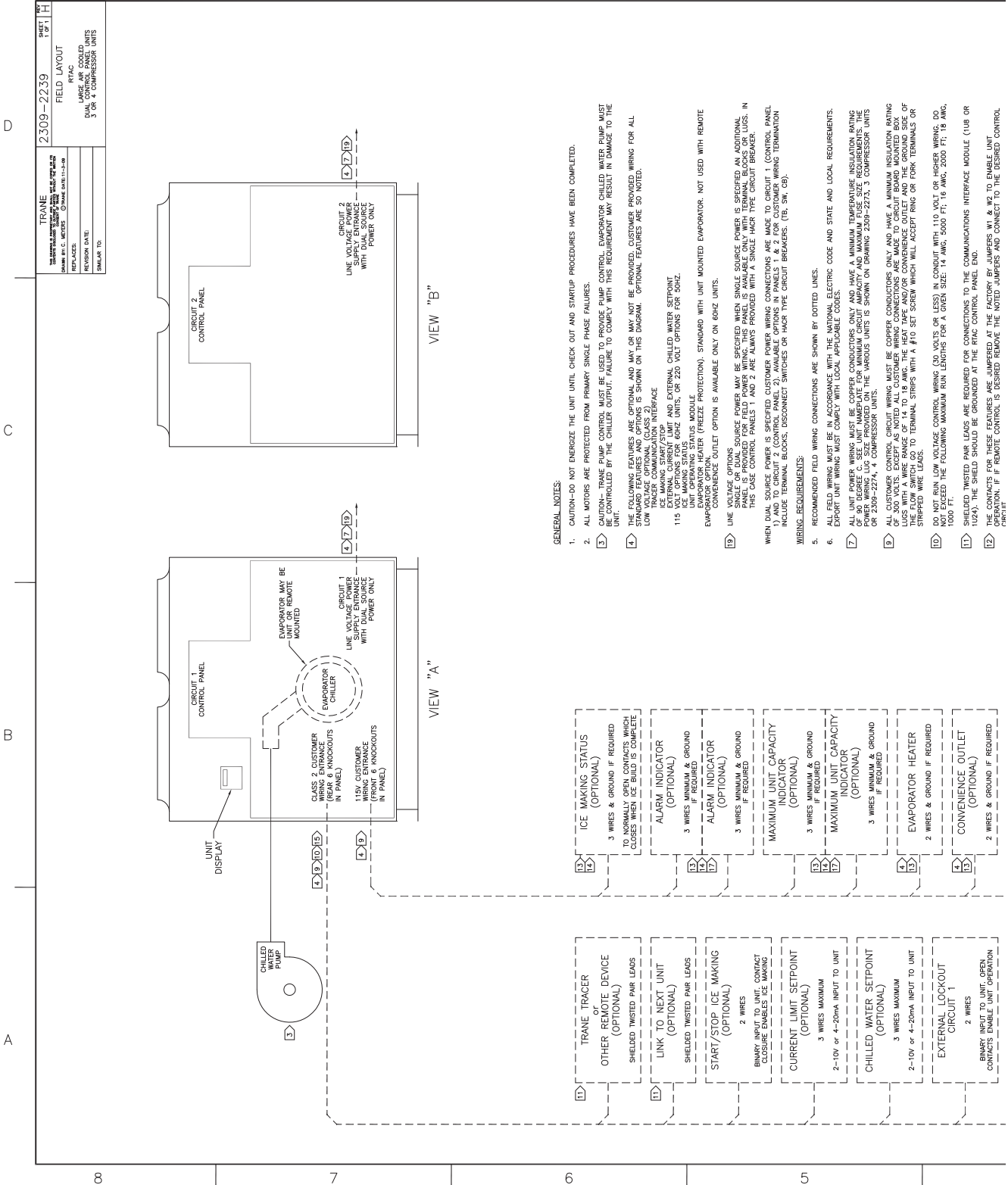

NOT EXCEED THE FOLLOWING MAXIMUM RIVAL LENGTHS FOR A GIVEN SIZE: 14 AWG, 5000 FT; 16 AWG, 2000 FT; 18 AWG, 1000 FT.

- 17 SHIELDED TWISTED PAIR LEADS ARE REQUIRED FOR CONNECTIONS TO THE COMMUNICATIONS INTERFACE MODULE (CIB OR IUA). THE SHIELD SHOULD BE GROUND AT THE RTAC CONTROL PANEL END.
- 18 THE CONTACTS FOR THESE FEATURES ARE JUMPERED AT THE FACTORY BY JUMPERS W1 & W2 TO ENABLE UNIT OPERATION. IF REMOTE CONTROL IS DESIRED REMOVE THE NOTED JUMPERS AND CONNECT TO THE DESIRED CONTROL CIRCUIT.
- 19 FIELD PROVIDED 115 VOLT 60HZ OR 220 VOLT 50HZ CONTROL POWER SUPPLIES ARE REQUIRED. THE MAX FUSE SIZE FOR EVAPORATOR HEATER IS 20 AMPS ON 115 VOLT 60HZ PRODUCTS AND 15 AMPS ON 220 VOLT 50 HZ PRODUCTS. SUPPLIES AS REQUIRED BY CODE. GREEN GROUND SCHEMS ARE PROVIDED IN UNIT CONTROL PANEL.

CONTACT RATINGS AND REQUIREMENTS:

- 14 UNIT PROVIDED FRY CHARACTER FOR THE COMPRESSOR PUMP CONTROL. THE UNIT OPERATING STATUS RELAYS AND ICE MAKING STATUS RELAY ARE RATED FOR 2.2 AMPS RESISTIVE, 2.48 AMPS PILOT DUTY, ON 1/3 HP, 7.2 FLA AT 220 VOLTS 60 HZ. CONTACTS ARE RATED FOR 5 AMPS GENERAL PURPOSE DUTY AT 240 VOLTS.
- 15 CUSTOMER SUPPLIED CONTACTS FOR ALL CLASS 2 CONNECTIONS MUST BE COMPATIBLE WITH DRY CIRCUIT 24 VOLTS DC FOR A 12 MA RESISTIVE LOAD. SILVER OR GOLD PLATED CONTACTS ARE RECOMMENDED.
- 16 FLOW SWITCH & INTERLOCK CONTACTS MUST BE ACCEPTABLE FOR USE IN A 24 VOLT 12 mA CIRCUIT OR A 220 VOLT 2 mA CIRCUIT.

FIELD PROVIDED INDICATORS MAY BE RELAYS, LIGHTS OR AUDIBLE DEVICES. FOUR DUPLICATE INDICATOR FUNCTIONS ARE PROVIDED FOR EACH OF THE 4 SPOT RELAYS ON THE OPTIONAL UNIT OPERATING STATUS MODULE. NORMALLY CLOSED RELAY CONTACTS OF EACH OF THE 4 SPOT RELAYS ON THE OPTIONAL UNIT OPERATING STATUS MODULE. THE FUNCTIONS OF THE OPERATING STATUS MODULE RELAYS ARE PROGRAMMABLE. SEE IOM FOR DETAILS. DEFAULT FUNCTIONS ARE SHOWN.

THE NORMALLY OPEN CONTACTS ON EACH RELAY OPERATE AS FOLLOWS:
 1. MAXIMUM UNIT CAPACITY INDICATOR CLOSE WHEN UNIT CAPACITY IS REACHED.
 2. MAXIMUM UNIT CAPACITY INDICATOR CLOSE WHEN ANY COMPRESSOR IS RUNNING.
 3. CONTACTS TO THE MAX UNIT CAPACITY INDICATOR CLOSE WHEN ALL UNIT COMPRESSORS ARE FULLY LOADED.
 4. MAXIMUM UNIT OPERATION INDICATOR CLOSE IF NORMAL UNIT OPERATION IS RESTRICTED BY SOME OPERATING PARAMETER.

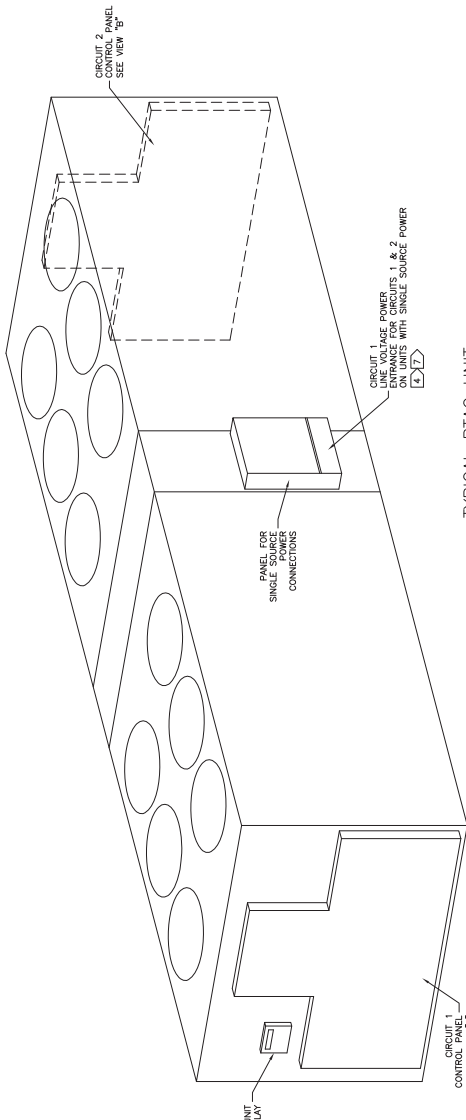
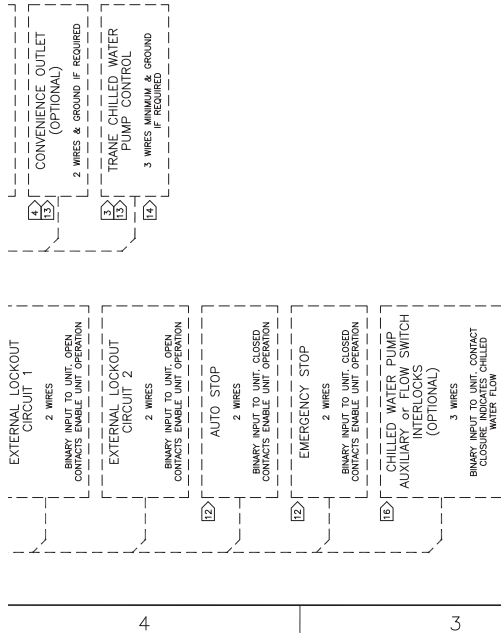

TYPICAL RTAC UNIT

Electrical Connection

Release on:

| | |
|---------------------------------|--------------|
| TRANE 2309-2208 | FIELD WIRING |
| DATE: 01-11-14 | REV: 01 |
| DESCRIPTION: 2 COMPRESSOR UNITS | |
| REVISIONS: | |
| REV. NO. | DATE |
| 1 | |

HAZARDOUS VOLTAGE
DISCONNECT ALL ELECTRIC POWER AND FOLLOW LOCK-OUT AND TAG-OUT PROCEDURES BEFORE WORKING ON THIS EQUIPMENT. YOU MAY BE EXPOSED TO HAZARDOUS VOLTAGE. ALWAYS WEAR APPROPRIATE SAFETY EQUIPMENT. ALWAYS USE THE CORRECT TOOLS AND TECHNIQUES FOR THE JOB. ALWAYS USE THE CORRECT WIRING METHODS. ALWAYS USE THE CORRECT WIRING MATERIALS. ALWAYS USE THE CORRECT WIRING METHODS. ALWAYS USE THE CORRECT WIRING MATERIALS.

AVVERTIMENTO
TENSIONE DANGEROSE
DISCONNETTARE TUTTA LA ENERGIA ELETTRICA E SEGUIRE LE PROCEDURE DI BLOCCO E TAGGARE PRIMA DI LAVORARE SU QUESTO EQUIPAGGIAMENTO. POTRETE ESSERE ESPOSTI A TENSIONI PERICOLOSE. SEMPRE USARE LA CORRETTA ATTREZZATURA E LE CORRETTI METODI DI LAVORO. SEMPRE USARE I MATERIALI E I METODI DI LAVORO CORRETTI. SEMPRE USARE I MATERIALI E I METODI DI LAVORO CORRETTI.

CAUTION
USE CORRECT WIRING METHODS TO AVOID DAMAGE TO THE EQUIPMENT. FAILURE TO DO SO MAY CAUSE DAMAGE TO THE EQUIPMENT.

ATTENTION
UTILISER LES METHODES CORRECTES DE BRANCHEMENT POUR EVITER LES DOMMAGES A L'EQUIPEMENT. UNE MAUVAISE BRANCHEMENT PEUT ENDOMMAGER L'EQUIPEMENT.

PRECAUTION
UTILICE UNICAMENTE CONDUCTORES DE COPRE PARA HACER LAS CONEXIONES. LOS CABLES DE ALUMINIO NO SON APTOS PARA ADEPTAR OTROS TIPOS DE CONDUCTORES. SI NO LO HACE, PUEDE OCASIONAR DAÑO AL EQUIPO.

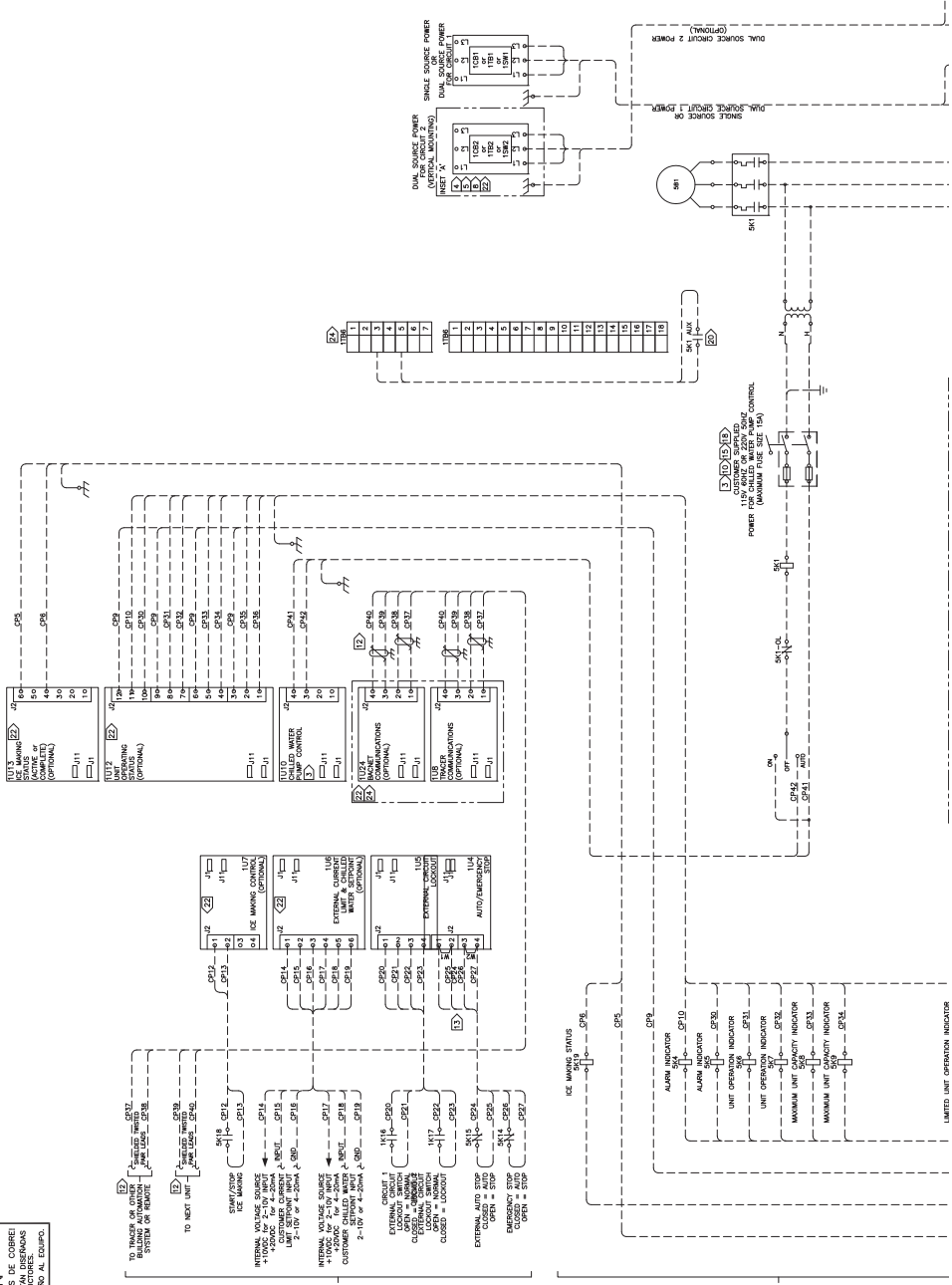

Electrical Connection

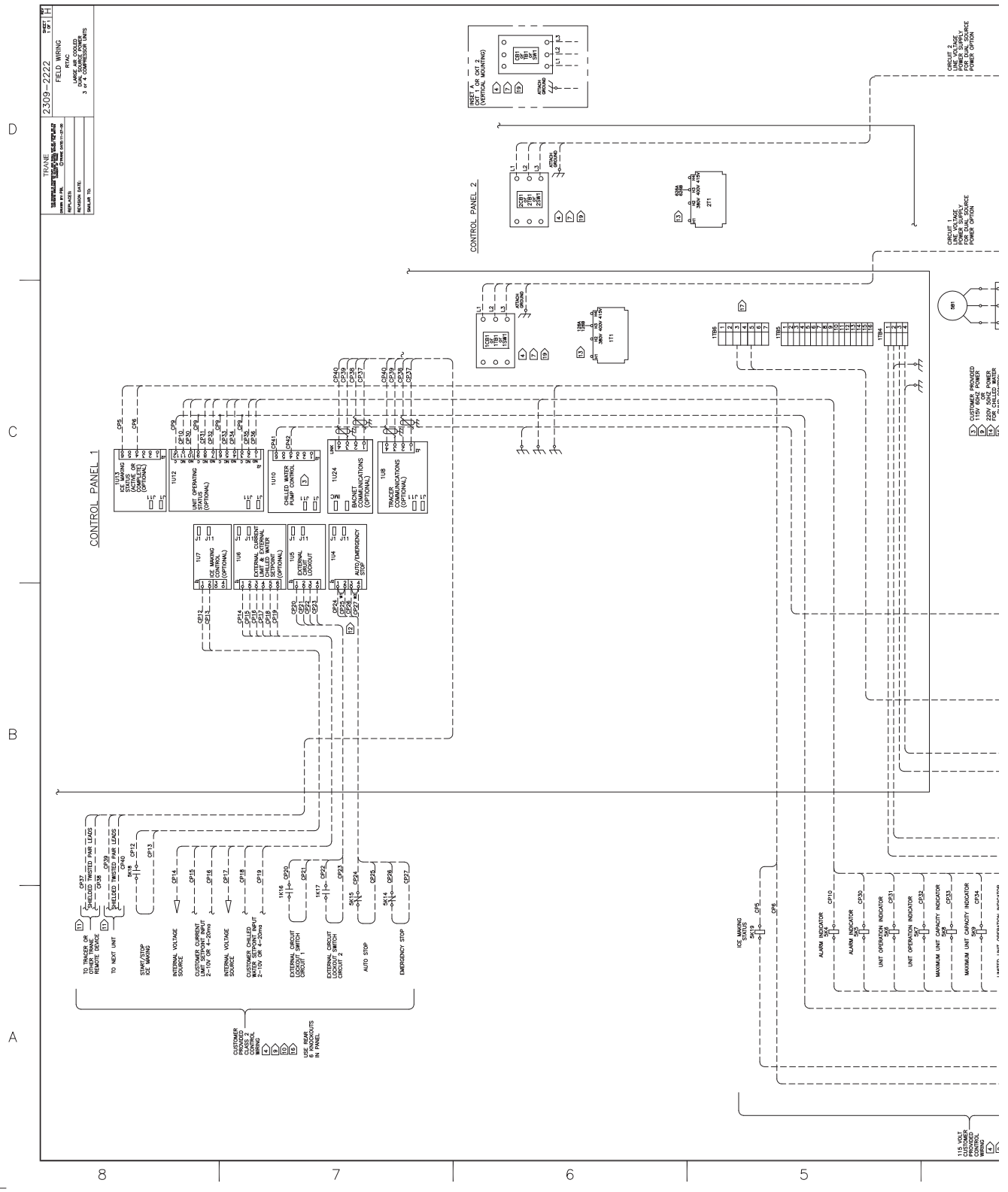

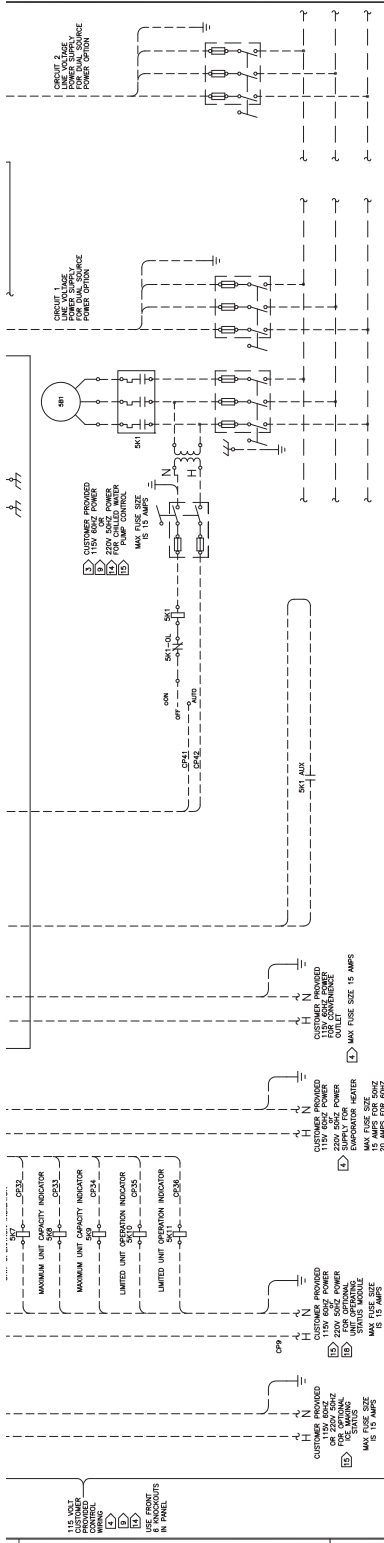

- GENERAL NOTES:**
- CAUTION-DO NOT ENERGIZE THE UNIT UNTIL CHECK OUT AND STARTUP PROCEDURES HAVE BEEN COMPLETED.
 - ALL MOTORS ARE PROTECTED FROM PRIMARY SINGLE PHASE FAILURES.
 - DO NOT DISCONNECT THE UNIT FROM THE MAIN SUPPLY UNTIL THE UNIT IS STOPPED. THE UNIT WILL RESTART AUTOMATICALLY WHEN POWER IS RESTORED.
 - DO NOT DISCONNECT THE UNIT FROM THE MAIN SUPPLY UNTIL THE UNIT IS STOPPED. THE UNIT WILL RESTART AUTOMATICALLY WHEN POWER IS RESTORED.
 - WARNING: THE UNIT MUST BE PROTECTED FROM OVERCURRENT BY A CIRCUIT BREAKER OR FUSE. THE UNIT MUST BE PROTECTED FROM OVERCURRENT BY A CIRCUIT BREAKER OR FUSE. THE UNIT MUST BE PROTECTED FROM OVERCURRENT BY A CIRCUIT BREAKER OR FUSE.
 - WARNING: THE UNIT MUST BE PROTECTED FROM OVERCURRENT BY A CIRCUIT BREAKER OR FUSE. THE UNIT MUST BE PROTECTED FROM OVERCURRENT BY A CIRCUIT BREAKER OR FUSE. THE UNIT MUST BE PROTECTED FROM OVERCURRENT BY A CIRCUIT BREAKER OR FUSE.
 - WARNING: THE UNIT MUST BE PROTECTED FROM OVERCURRENT BY A CIRCUIT BREAKER OR FUSE. THE UNIT MUST BE PROTECTED FROM OVERCURRENT BY A CIRCUIT BREAKER OR FUSE. THE UNIT MUST BE PROTECTED FROM OVERCURRENT BY A CIRCUIT BREAKER OR FUSE.

| UNIT SIZE | UNIT VOLTAGE | DESIGNATION | VOLTS | CLASS | AMPS |
|-----------|--------------|---------------------|-------|-------|------|
| ALL | 230/0 | 1F1-1F2/2F1-2F2 | 230 | | 30 |
| ALL | 230/0 | | 230 | | 30 |
| ALL | 460/0 | 1F13,1F14/2F13,2F14 | 460 | | 30 |
| ALL | 460/0 | | 460 | | 30 |
| 250 TON | 575/0 | | 575 | CC | 4 |
| 500 TON | 575/0 | 1F15,2F15 | 575 | | 10 |
| 500 TON | 575/0 | 1F16,17/2F16-17 | 575 | | 10 |
| 500 TON | 575/0 | 1F18-1F23/2F18-2F23 | 575 | | 10 |
| 500 TON | 575/0 | | 575 | | 6.25 |

CAUTION
 USE COPPER CONDUCTORS ONLY.
 UNIT TERMINALS ARE NOT DESIGNED TO ACCEPT
 ALUMINUM WIRE. FAILURE TO DO SO MAY CAUSE DAMAGE TO THE
 EQUIPMENT.

ATTENTION
 NE PAS UTILISER D'ALUMINIUM POUR LES CÂBLES.
 LES BORNES DE L'UNITÉ NE SONT PAS CONÇUES
 POUR RECEVOIR D'AUTRES TYPES DE CONDUCTEURS.
 L'UTILISATION D'UN AUTRE TYPE DE CONDUCTEUR PEUT
 ENDOMMAGER L'ÉQUIPEMENT.

PRECAUTION
 UTILISEZ UNICAMENTE CONDUCTORES DE COBRE
 PARA LA UNIDAD. EL USO DE ALUMINIO O OTROS TIPOS DE
 CABLES EN LOS TERMINALES DE LA UNIDAD PUEDE
 DAÑAR EL EQUIPO.

Dimensions

Note: Mounting location dimensions may vary on units with seismic rating. See unit submittals..

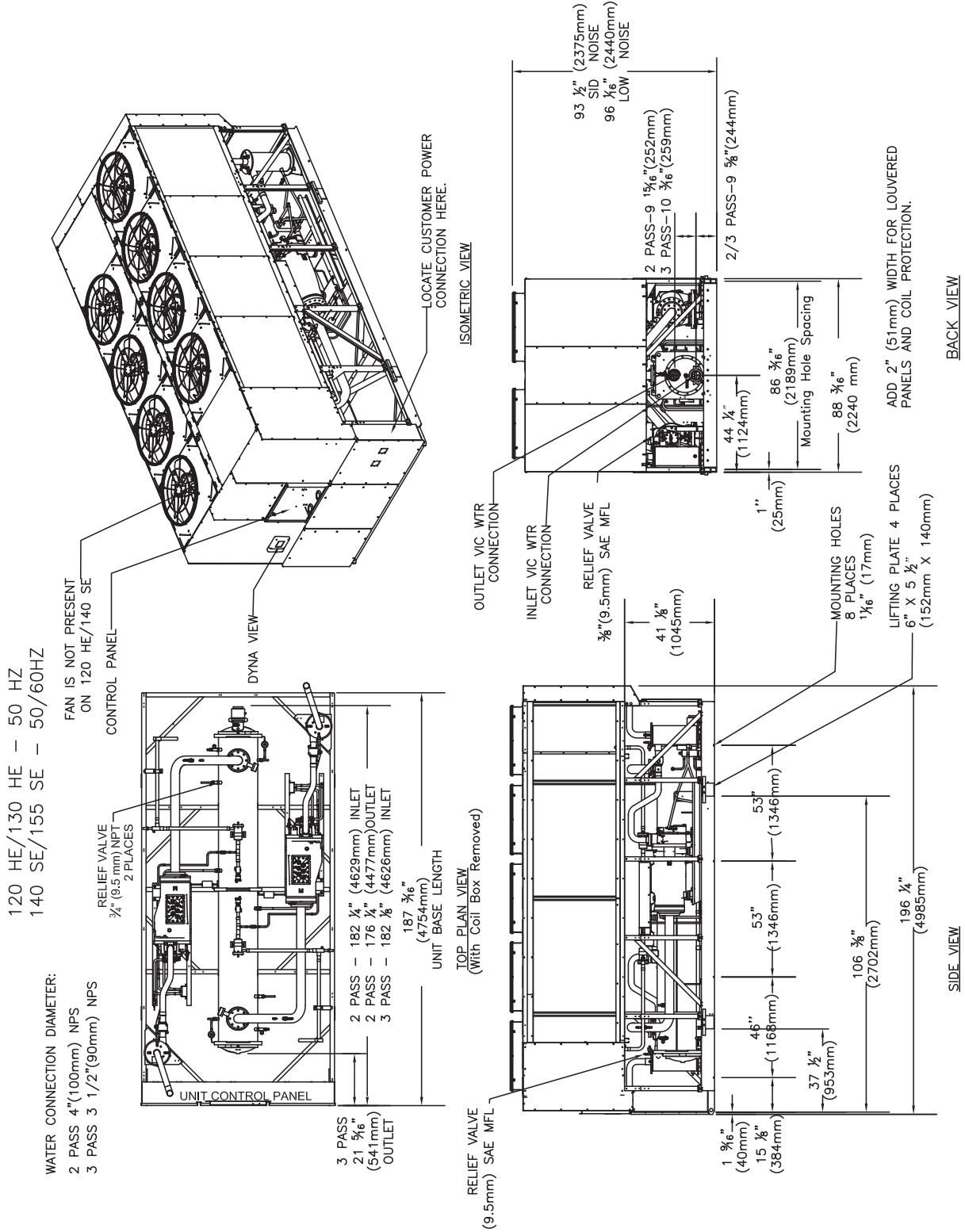

140 HE/170SE - 50 / 60HZ

WATER CONNECTION DIAMETER:
 2 PASS - 6" (150mm) NPS
 3 PASS - 4" (100mm) NPS

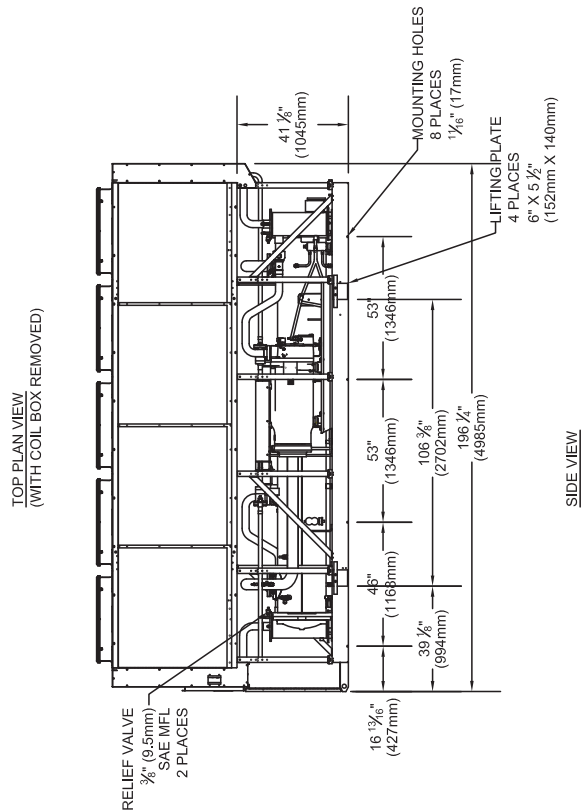
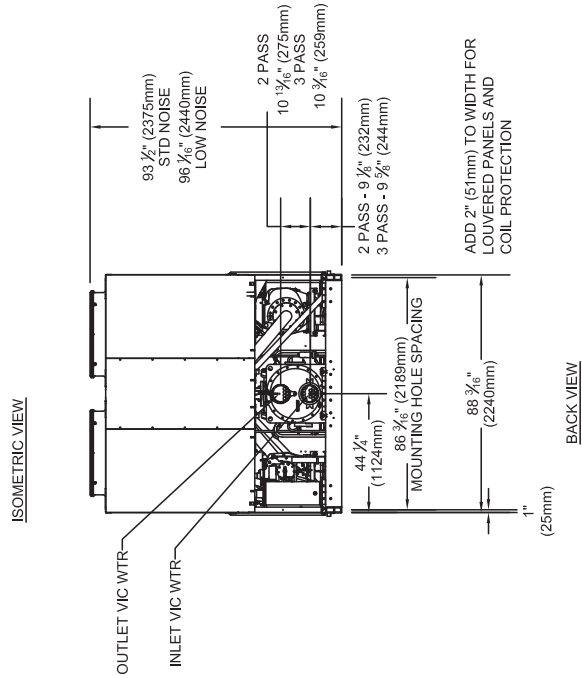
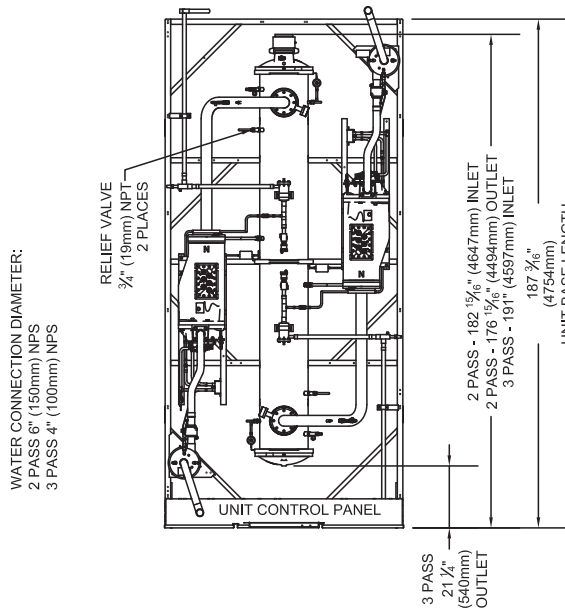
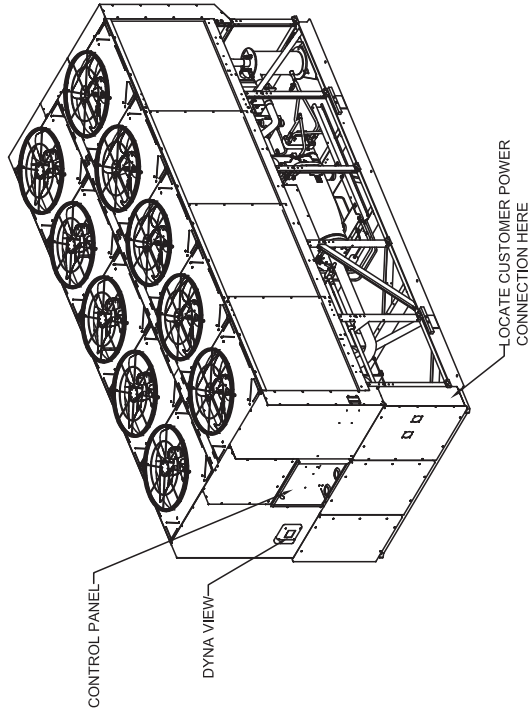

Dimensions

155, 170 HE/185, 200 SE - 50 / 60HZ
140 XE - 60 HZ

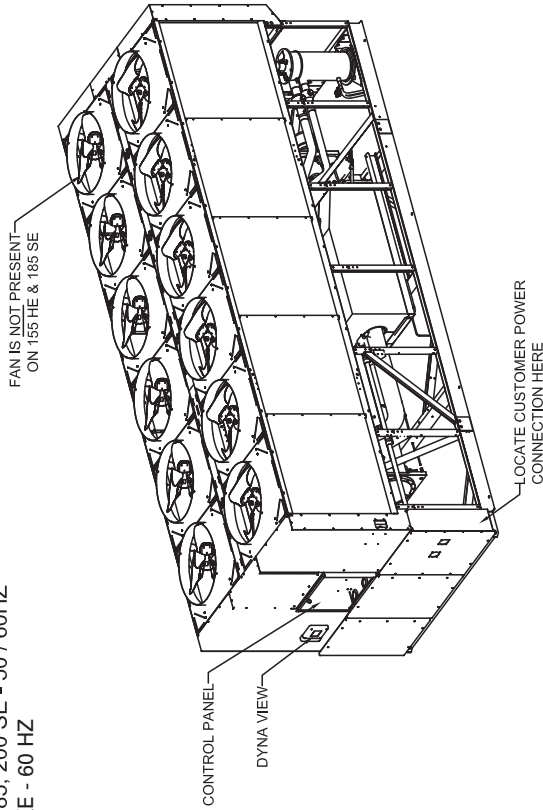

WATER CONNECTION DIAMETER:
2 PASS 6" (150mm) NPS
3 PASS 4" (100mm) NPS

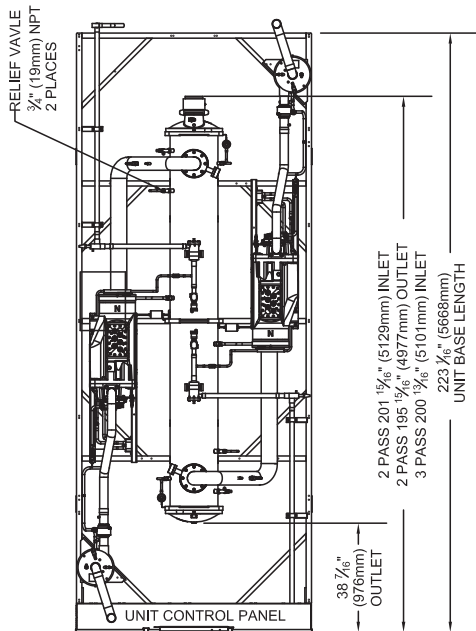

TOP PLAN VIEW
(WITH COIL BOX REMOVED)

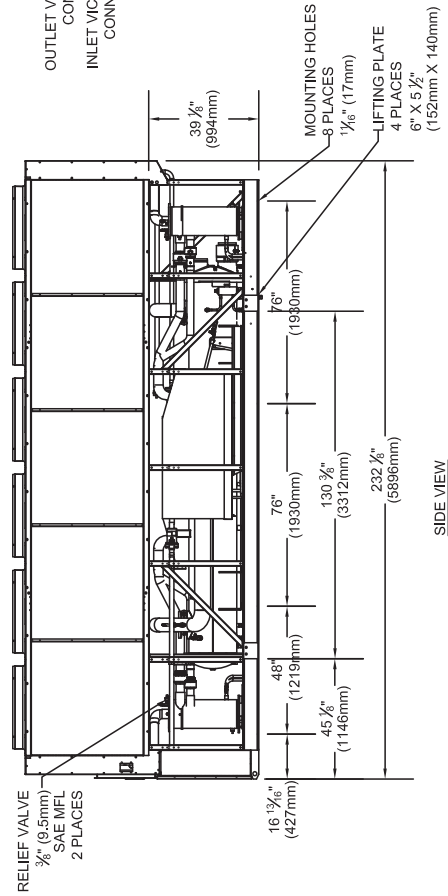

ISOMETRIC VIEW

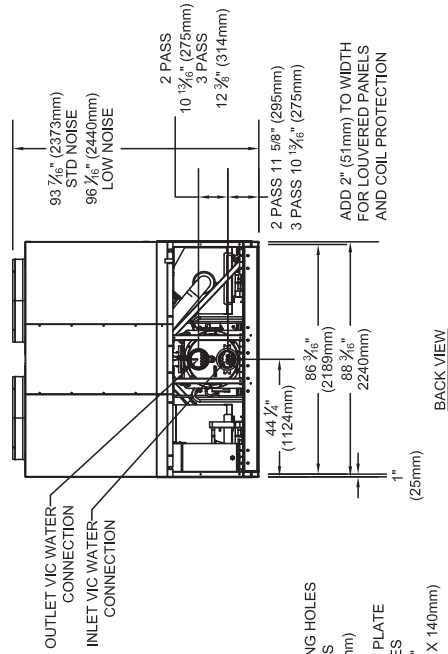

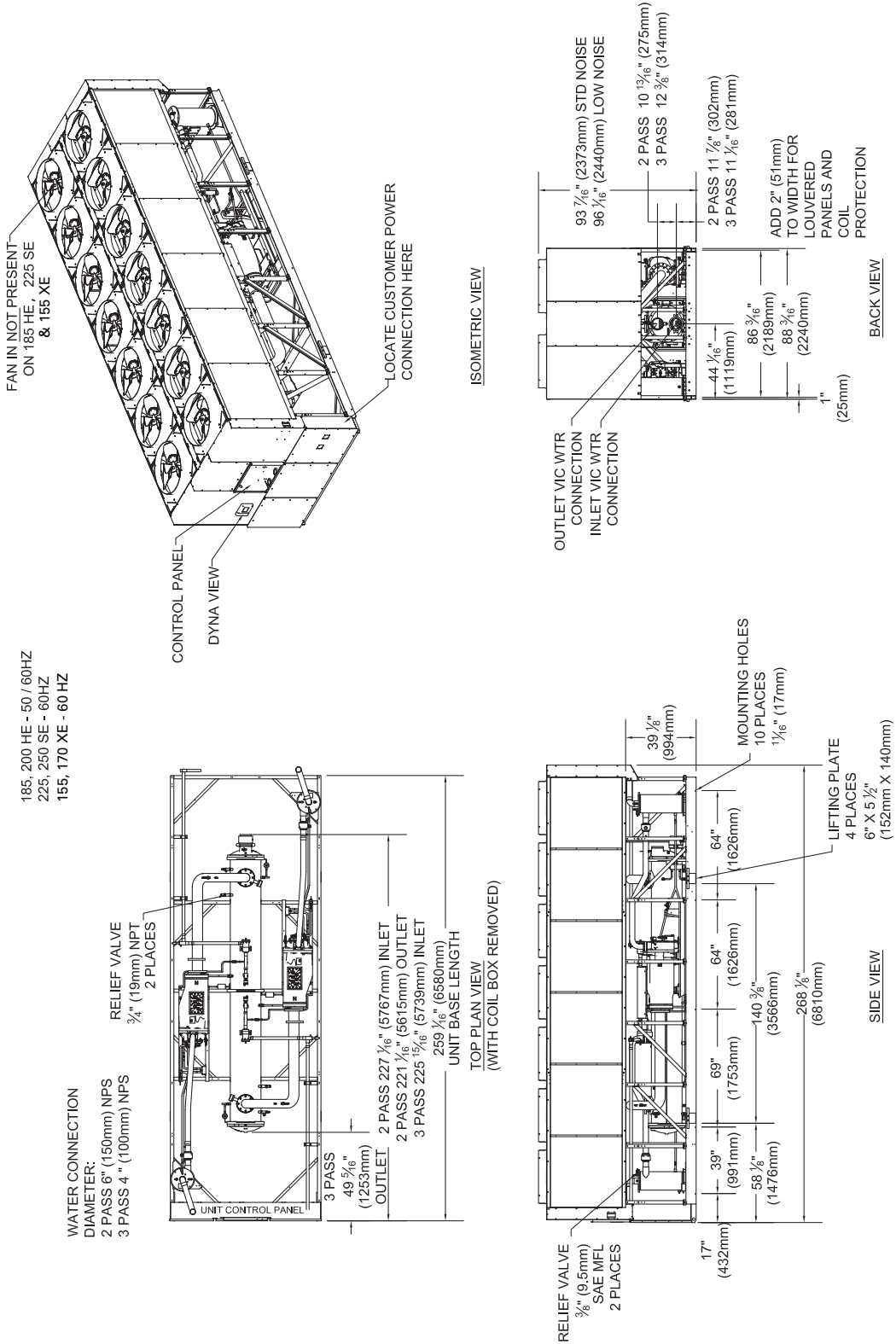

Dimensions

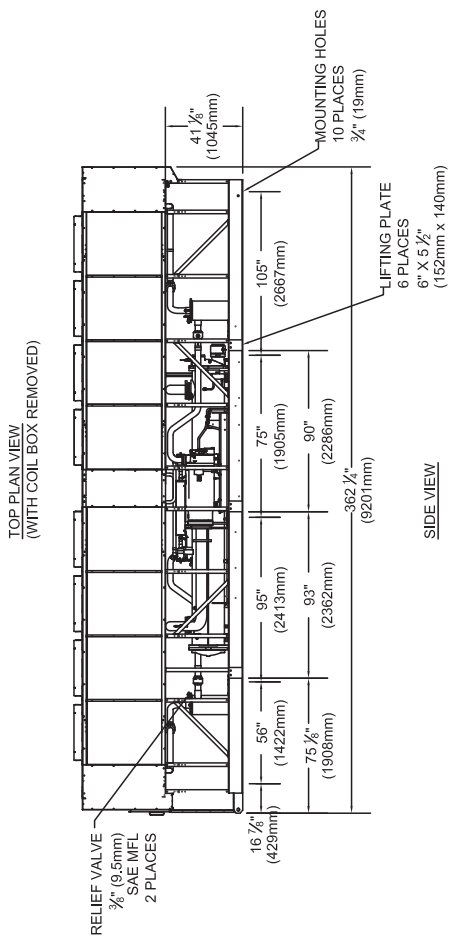
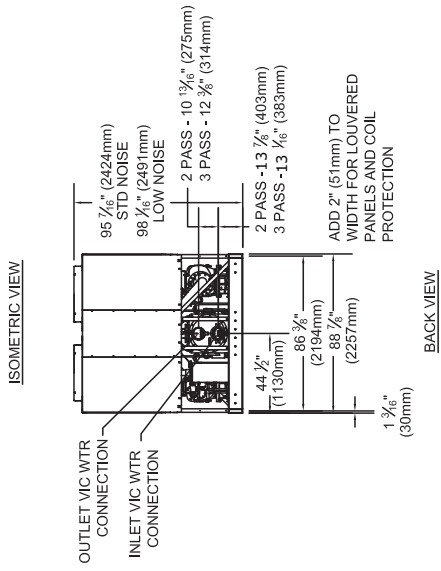
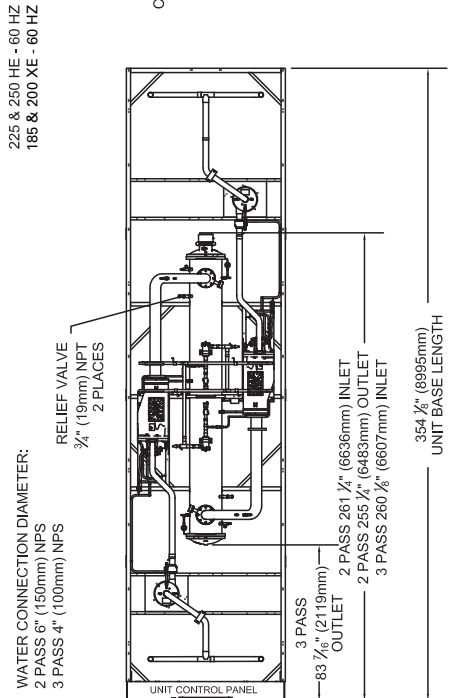
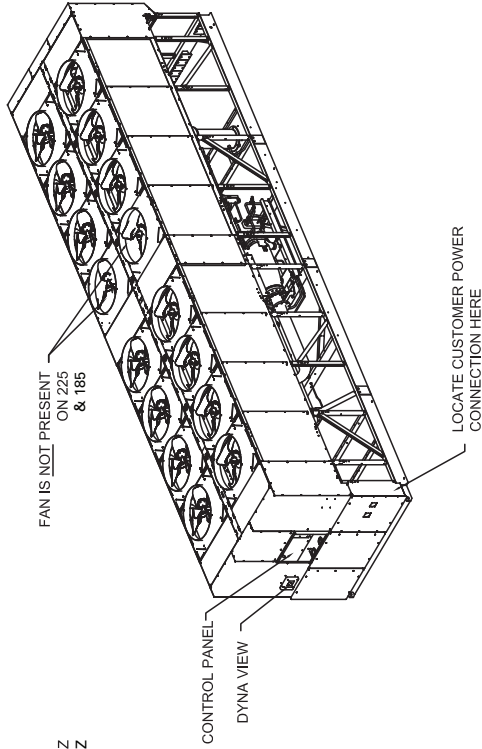

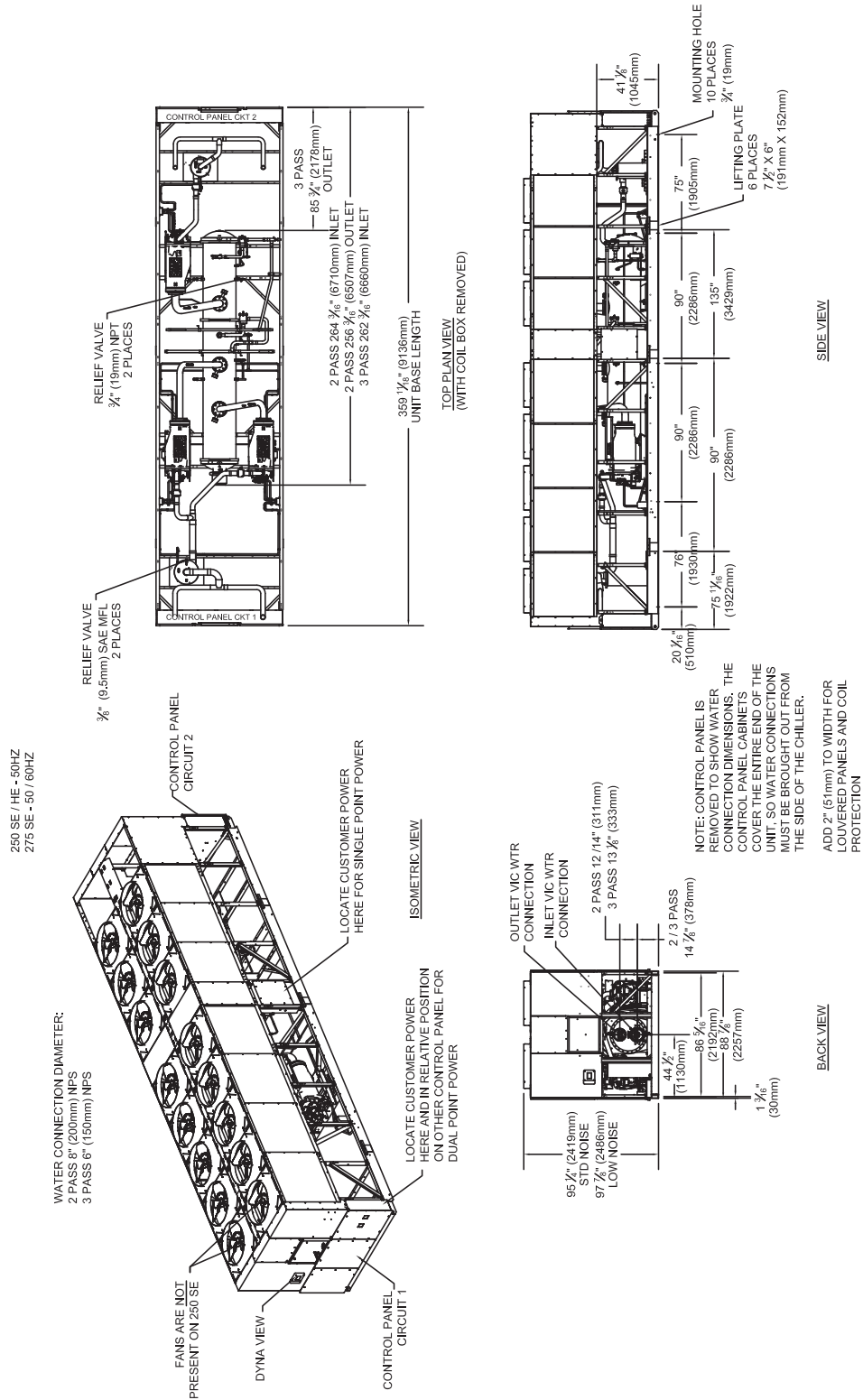

Dimensions

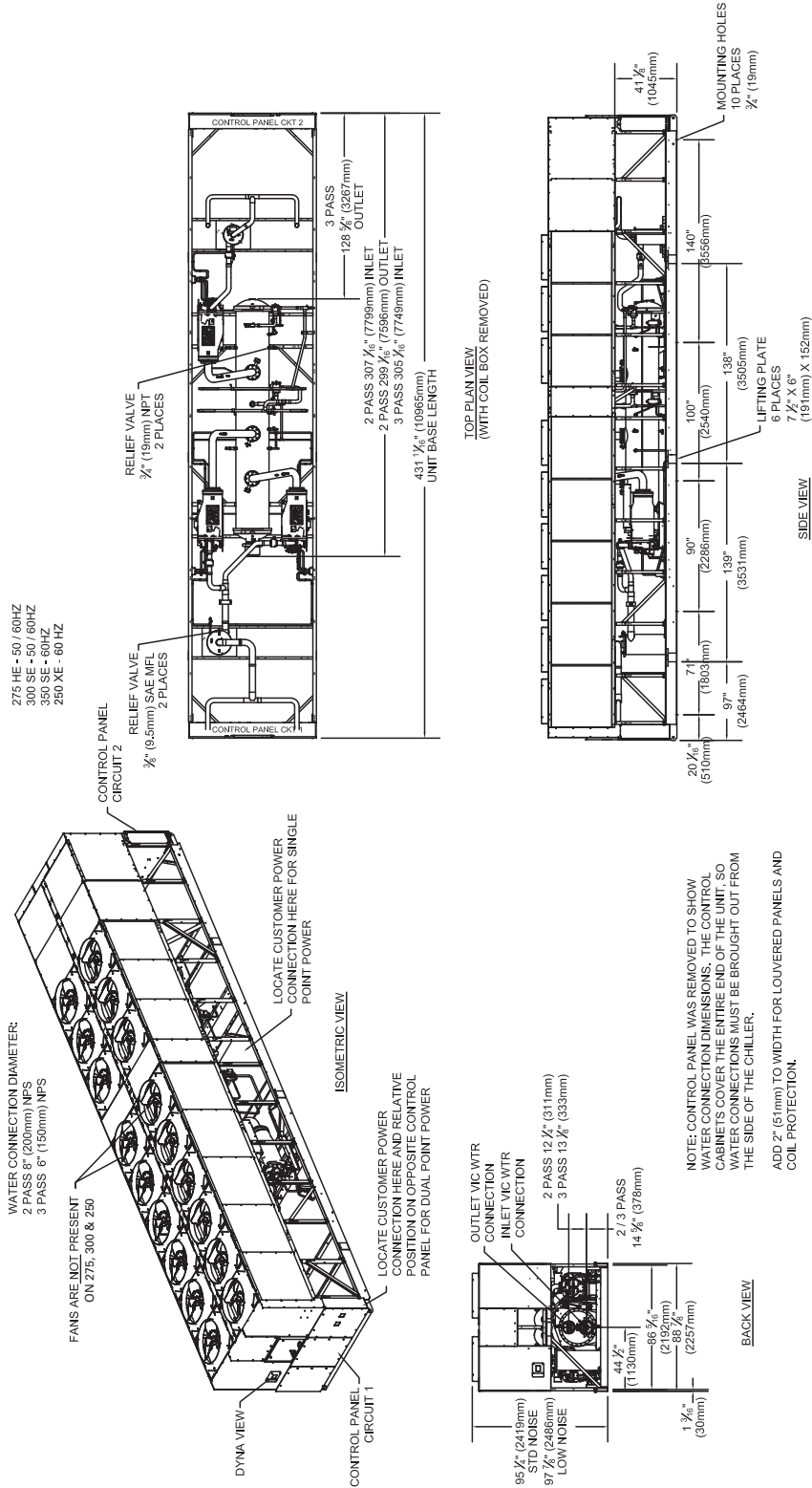

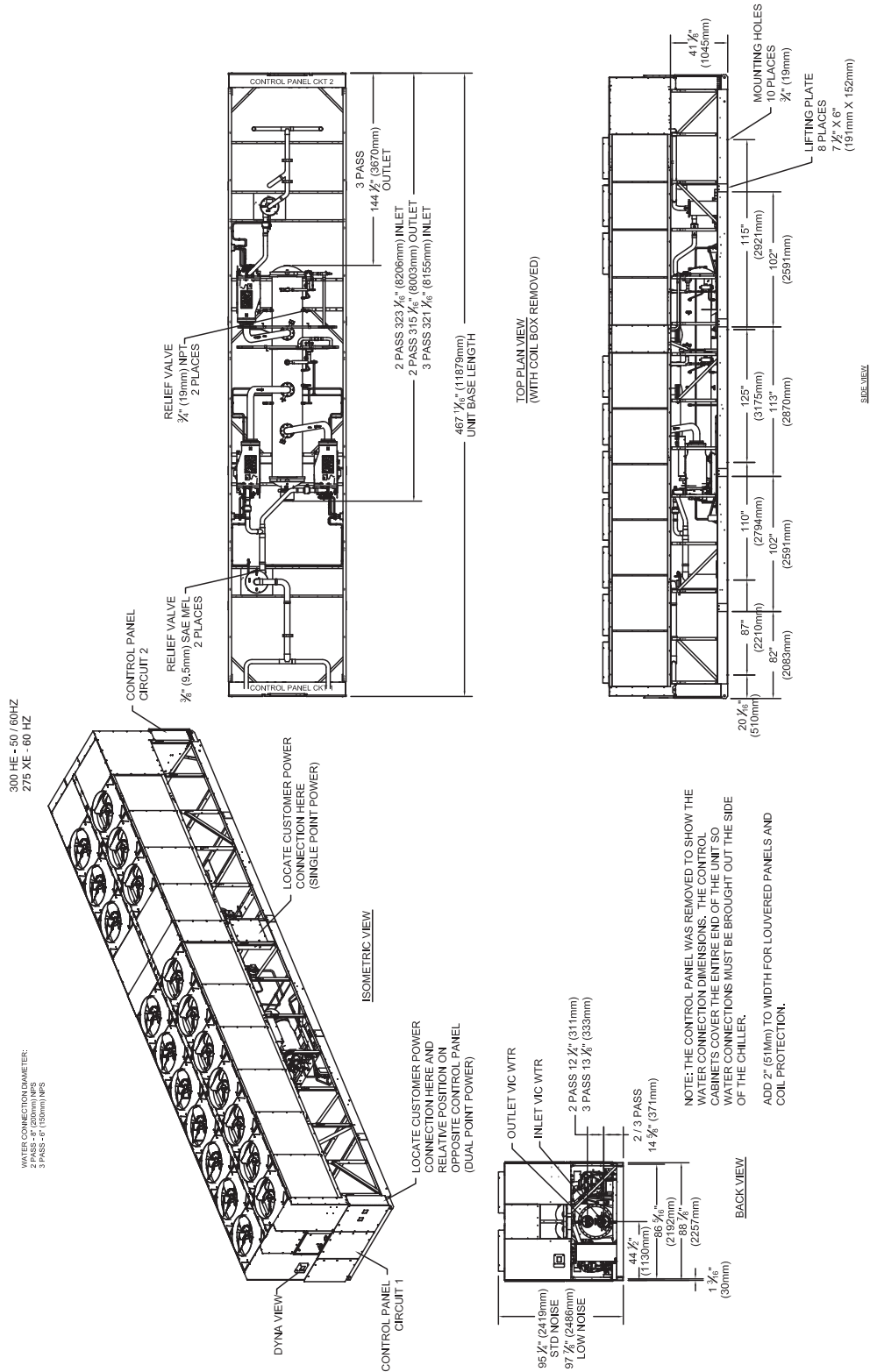

Dimensions

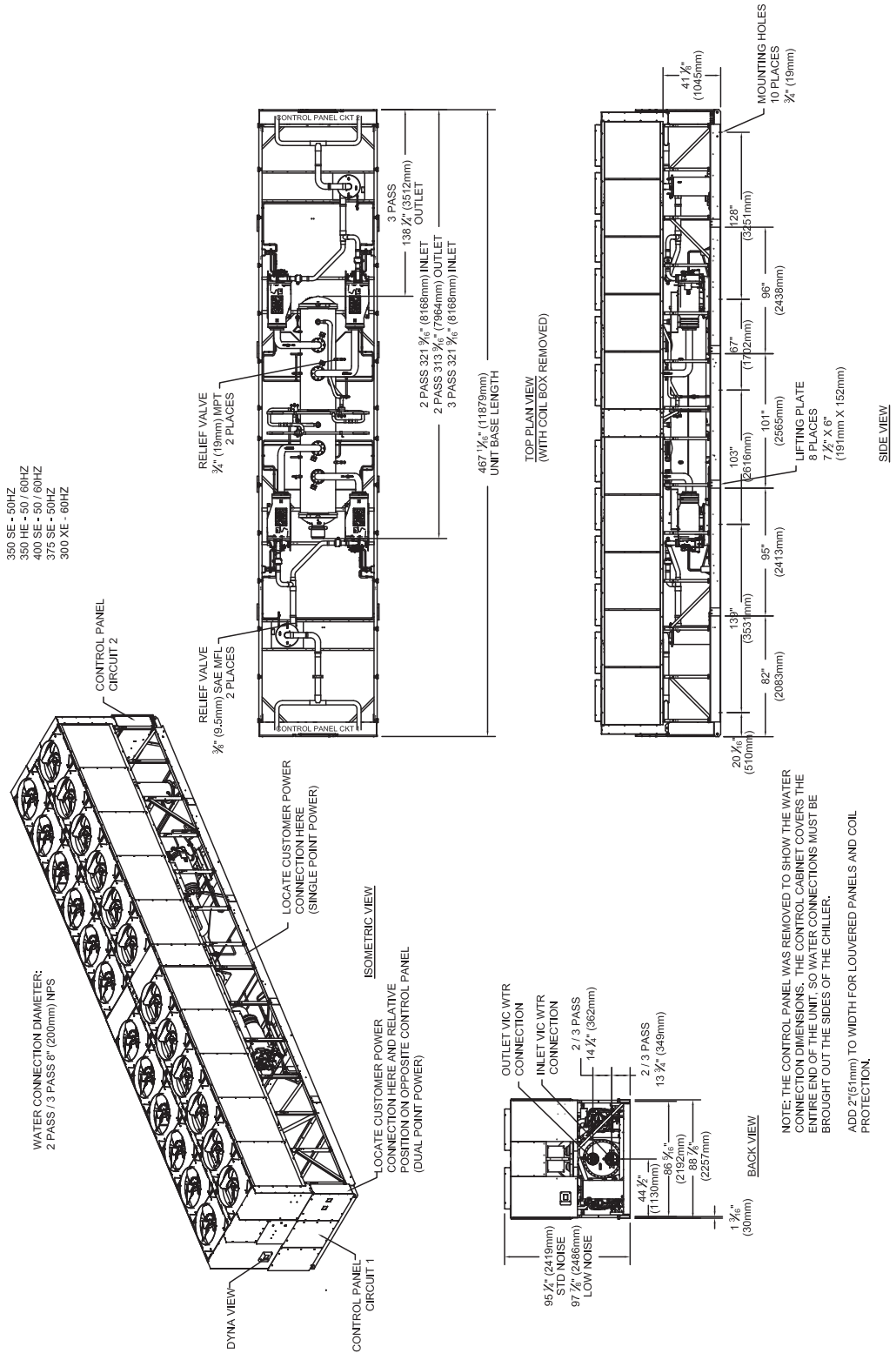

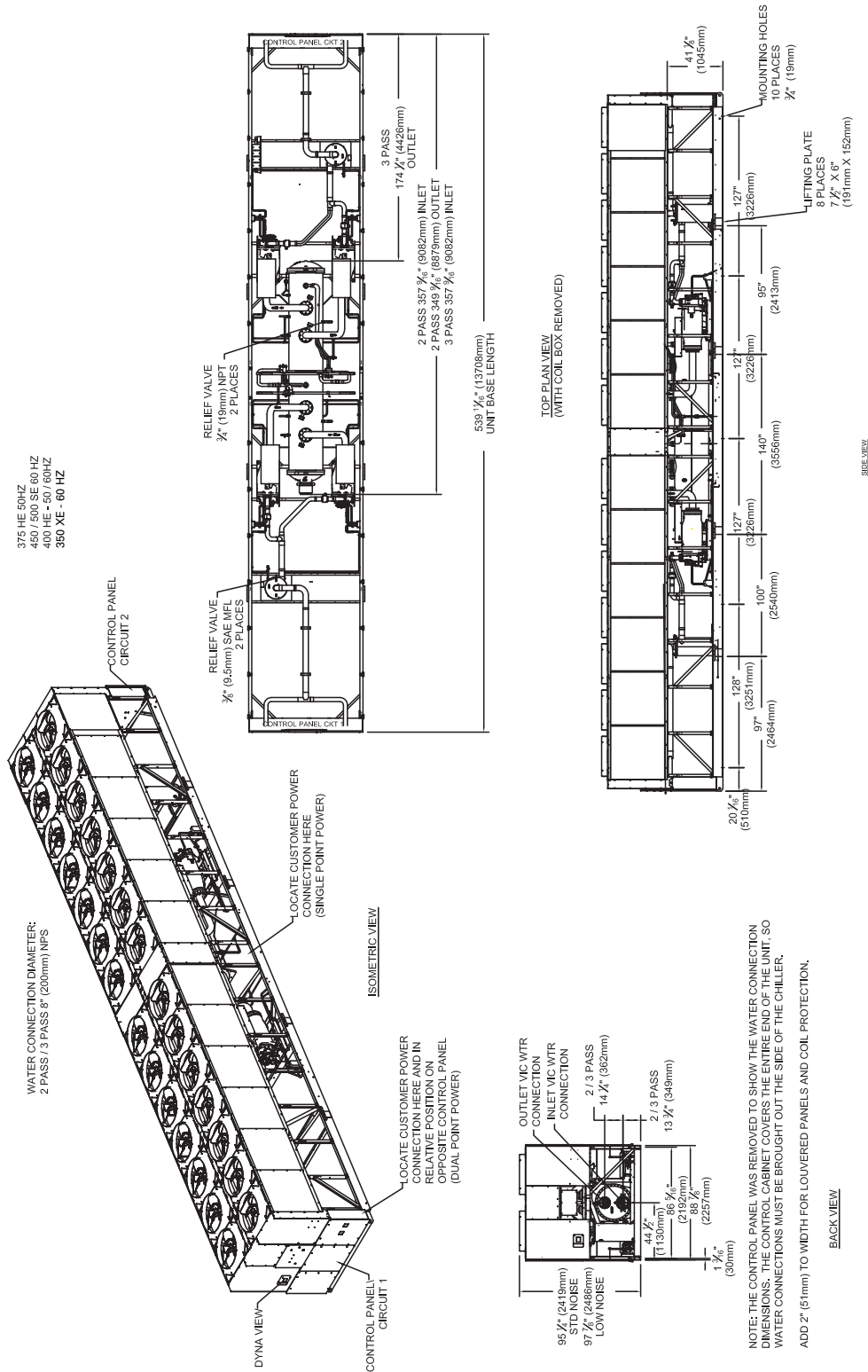



Weights

Non-Seismically Rated Units

Table 21. Weight - packaged units - 60 Hz - aluminum or CompleteCoat coils

| Unit Size (tons) | Standard Efficiency | | | | High Efficiency | | | | Extra Efficiency | | | |
|------------------|---------------------|-------|-----------|-------|-----------------|-------|-----------|-------|------------------|-------|-----------|-------|
| | Shipping | | Operating | | Shipping | | Operating | | Shipping | | Operating | |
| | lb | kg | lb | kg | lb | kg | lb | kg | lb | kg | lb | kg |
| 140 | 10832 | 4913 | 11146 | 5056 | 10859 | 4926 | 11160 | 5062 | 12171 | 5521 | 12585 | 5708 |
| 155 | 10910 | 4949 | 11146 | 5056 | 12114 | 5495 | 12445 | 5645 | 13984 | 6343 | 14293 | 6483 |
| 170 | 10877 | 4934 | 11218 | 5088 | 12171 | 5521 | 12585 | 5708 | 14454 | 6556 | 14721 | 6677 |
| 185 | 12479 | 5660 | 12899 | 5851 | 13984 | 6343 | 14293 | 6483 | 15915 | 7219 | 16413 | 7445 |
| 200 | 12884 | 5844 | 13193 | 5984 | 14454 | 6556 | 14721 | 6677 | 16016 | 7265 | 16413 | 7445 |
| 225 | 14635 | 6638 | 14966 | 6788 | 15915 | 7219 | 16413 | 7445 | n/a | | | |
| 250 | 14916 | 6766 | 15191 | 6890 | 16016 | 7265 | 16413 | 7445 | 20476 | 9288 | 21048 | 9547 |
| 275 | 19025 | 8630 | 19685 | 8929 | 20393 | 9250 | 21048 | 9547 | 21667 | 9828 | 22160 | 10052 |
| 300 | 20699 | 9389 | 21214 | 9622 | 21667 | 9828 | 22160 | 10052 | 24073 | 10919 | 24700 | 11204 |
| 350 | 21550 | 9775 | 22005 | 9981 | 24073 | 10919 | 24700 | 11204 | 27136 | 12309 | 27750 | 12587 |
| 400 | 25409 | 11525 | 25854 | 11727 | 27136 | 12309 | 27750 | 12587 | n/a | | | |
| 450 | 26816 | 12163 | 27393 | 12425 | n/a | | | | n/a | | | |
| 500 | 27136 | 12309 | 27912 | 12661 | n/a | | | | n/a | | | |

1. Operating weight includes refrigerant and water.
2. Shipping weight includes refrigerant.
3. All weights +/- 3%.

Table 22. Weight - packaged units - 60 Hz - copper coils

| Unit Size (tons) | Standard Efficiency | | | | High Efficiency | | | | Extra Efficiency | | | |
|------------------|---------------------|-------|-----------|-------|-----------------|-------|-----------|-------|------------------|-------|-----------|-------|
| | Shipping | | Operating | | Shipping | | Operating | | Shipping | | Operating | |
| | lb | kg | lb | kg | lb | kg | lb | kg | lb | kg | lb | kg |
| 140 | 13407 | 6081 | 13734 | 6230 | 13426 | 6090 | 13734 | 6230 | 15590 | 7071 | 15998 | 7257 |
| 155 | 13420 | 6087 | 13734 | 6230 | 15647 | 7097 | 15854 | 7191 | 18250 | 8278 | 18613 | 8443 |
| 170 | 13442 | 6097 | 13733 | 6229 | 15590 | 7071 | 15998 | 7257 | 18701 | 8483 | 18958 | 8599 |
| 185 | 15870 | 7198 | 16253 | 7372 | 18250 | 8278 | 18613 | 8443 | 20794 | 9432 | 21290 | 9657 |
| 200 | 16304 | 7395 | 16630 | 7543 | 18701 | 8483 | 18958 | 8599 | 20881 | 9471 | 21290 | 9657 |
| 225 | 18739 | 8500 | 18156 | 8235 | 20794 | 9432 | 21290 | 9657 | n/a | | | |
| 250 | 18905 | 8575 | 19223 | 8719 | 20881 | 9471 | 21290 | 9657 | 26017 | 11801 | 26558 | 12046 |
| 275 | 23905 | 10843 | 24608 | 11162 | 26017 | 11801 | 26558 | 12046 | 27660 | 12546 | 28182 | 12783 |
| 300 | 26039 | 11811 | 26580 | 12056 | 27660 | 12546 | 28182 | 12783 | 30848 | 13992 | 31431 | 14257 |
| 350 | 27395 | 12426 | 27920 | 12664 | 30848 | 13992 | 31431 | 14257 | 35166 | 15951 | 35688 | 16188 |
| 400 | 32216 | 14613 | 32723 | 14843 | 35014 | 15882 | 35688 | 16188 | n/a | | | |
| 450 | 32682 | 14824 | 33178 | 15049 | n/a | | | | n/a | | | |
| 500 | 35014 | 15882 | 35787 | 16233 | n/a | | | | n/a | | | |

1. Operating weight includes refrigerant and water.
2. Shipping weight includes refrigerant.
3. All weights +/- 3%.

Seismically Rated Units

Table 23. Weight - seismically rated - packaged units - 60 Hz - aluminum or CompleteCoat coils

| Unit Size (tons) | Standard Efficiency | | | | High Efficiency | | | | Extra Efficiency | | | |
|------------------|---------------------|-------|-----------|-------|-----------------|-------|-----------|-------|------------------|-------|-----------|-------|
| | Shipping | | Operating | | Shipping | | Operating | | Shipping | | Operating | |
| | lb | kg | lb | kg | lb | kg | lb | kg | lb | kg | lb | kg |
| 140 | 11374 | 5159 | 11646 | 5283 | 11402 | 5172 | 11711 | 5312 | 12780 | 5797 | 13185 | 5981 |
| 155 | 11456 | 5196 | 11703 | 5308 | 12720 | 5770 | 13067 | 5927 | 14683 | 6660 | 15021 | 6813 |
| 170 | 11421 | 5180 | 11779 | 5343 | 12780 | 5797 | 13214 | 5994 | 15177 | 6884 | 15433 | 7000 |
| 185 | 13103 | 5943 | 13544 | 6143 | 14683 | 6660 | 15008 | 6807 | 16711 | 7580 | 17234 | 7817 |
| 200 | 13528 | 6136 | 13853 | 6284 | 15177 | 6884 | 15457 | 7011 | 16817 | 7628 | 17234 | 7817 |
| 225 | 15367 | 6970 | 15714 | 7128 | 16711 | 7580 | 17234 | 7817 | n/a | | | |
| 250 | 15662 | 7104 | 15951 | 7235 | 16817 | 7628 | 17234 | 7817 | 21500 | 9752 | 22100 | 10025 |
| 275 | 19976 | 9061 | 20669 | 9375 | 21413 | 9713 | 22100 | 10025 | 22750 | 10319 | 23268 | 10554 |
| 300 | 21734 | 9858 | 22275 | 10104 | 22750 | 10319 | 23268 | 10554 | 25277 | 11465 | 25935 | 11764 |
| 350 | 22628 | 10264 | 23105 | 10480 | 25277 | 11465 | 25935 | 11764 | 28493 | 12924 | 29138 | 13216 |
| 400 | 26679 | 12102 | 27147 | 12313 | 28493 | 12924 | 29138 | 13216 | n/a | | | |
| 450 | 28157 | 12772 | 28763 | 13046 | n/a | | | | n/a | | | |
| 500 | 28493 | 12924 | 29308 | 13294 | n/a | | | | n/a | | | |

1. Operating weight includes refrigerant and water.
2. Shipping weight includes refrigerant.
3. All weights +/- 3%.



Mechanical Specifications

General

Units are leak and pressure tested at 390 psig high side, 250 psig low side, then evacuated and charged. All Air-Cooled Series R Chillers are factory tested prior to shipment. Packaged units ship with a full operating charge of oil and refrigerant. Unit panels, structural elements and control boxes are constructed of galvanized steel and mounted on a welded structural steel base. Unit panels and control boxes are finished with a baked on powder paint, and the structural base with an air dry paint. All paint meets the requirement for outdoor equipment of the US Navy and other federal government agencies.

Evaporator

The evaporator is a tube-in-shell heat exchanger design with internally and externally finned copper tubes roller expanded into the tube sheet. The evaporator is designed, tested and stamped in accordance with ASME for a refrigerant side working pressure of 200 psig. The evaporator is designed for a water side working pressure of 150 psig. Water connections are grooved pipe. Each shell includes a vent, a drain and fittings for temperature control sensors and is insulated with 3/4 inch equal insulation (K=0.28). Evaporator heaters with thermostat are provided to help protect the evaporator from freezing at ambient temperatures down to -20°F (-29°C). Factory installed flow switch is installed on a pipe stub in the evaporator inlet.

Condenser and Fans

Air-cooled condenser coils have aluminum fins mechanically bonded to internally finned seamless copper tubing. The condenser coil has an integral subcooling circuit. Condensers are factory proof and leak tested at 506 psig. Direct drive vertical discharge condenser fans are dynamically balanced. Totally enclosed air over motors completely seal the motor windings to prevent exposure to ambient conditions. Three-phase condenser fan motors with permanently lubricated ball bearings and internal thermal overload protection are provided. Standard units will start and operate between 25 to 115°F (-4 to 46°C) ambient.

Compressor and Lube Oil System

The rotary screw compressor is semi-hermetic, direct drive, 3600 rpm, 60 Hz, with capacity control slide valve, a load/unload valve, rolling element bearings, differential refrigerant pressure oil pump and oil heater. The motor is a suction gas cooled, hermetically sealed, two-pole squirrel cage induction motor. Oil separator and filtration devices are provided separate from the compressor. Check valves in the compressor discharge and lube oil system and a solenoid valve in the lube system are also provided.

Refrigeration Circuits

Each unit has two refrigerant circuits, with one or two rotary screw compressors per circuit. Each refrigerant circuit includes a compressor suction and discharge service valve, liquid line shutoff valve, removable core filter, liquid line sight glass with moisture indicator, charging port and an electronic expansion valve. Fully modulating compressors and electronic expansion valves provide variable capacity modulation over the entire operating range.

Unit Controls

All unit controls are housed in an outdoor rated weather tight enclosure with removable plates to allow for customer connection of power wiring and remote interlocks. All controls, including sensors, are factory mounted and tested prior to shipment. Microcomputer controls provide all control functions including startup and shut down, leaving chilled water temperature control, evaporator flow proving, compressor and electronic expansion valve modulation, fan sequencing, anti-recycle logic, automatic lead/lag compressor starting and load limiting. The unit control module, utilizing Adaptive Control™ microprocessor, automatically takes action to avoid unit shutdown due to abnormal operating conditions associated with low refrigerant pressure, high condensing pressure and motor current overload. Should the abnormal operating condition continue until a protective limit is violated, the unit will be shut down. Unit protective functions

include loss of chilled water flow, evaporator freezing, loss of refrigerant, low refrigerant pressure, high refrigerant pressure, reverse rotation, compressor starting and running over current, phase loss, phase imbalance, phase reversal, and loss of oil flow. A digital display indicates chilled water setpoint and leaving chilled water temperature as standard. While current limit setpoint, evaporator and condenser refrigerant pressures, and electrical information are an option. Both standard and optional displays can be viewed on the unit without opening any control panel doors. Standard power connections include main three phase power to the compressors, condenser fans and control power transformer and optional connections are available for the 115 volt/60 Hz single phase power for freeze protection on the evaporator heaters.

Starters

Starters are housed in a weather tight enclosure with removable cover plate to allow for customer connection of power wiring. Across-the-line starters are standard on all 380-575/60 volt units. Wye Delta closed transition starters (33 percent of LRA inrush) are optional on 380-575/60 volt units and standard on 200-230/60 Hz volt units. Typically, Trane helical rotary screw compressors are up to full speed in one second when started across-the-line and have equivalent inrush with similar size reciprocating compressor with part wind starters.

Chilled Water Reset

This provides the control logic and factory installed sensors to reset leaving chilled water temperature. The setpoint can be reset based on ambient temperature or return evaporator water temperature.

Flow Control

The factory installed flow switch is provided with the control logic and relays to turn the chilled water flow on and off as the chiller requires for operation and protection. This function is a requirement on the Air-Cooled Series R Chiller.

Options

Applications Options

High Efficiency/Performance Option

High efficiency option provides an increase in efficiency over standard efficiency by providing oversized heat exchangers for two purposes. One, it allows the unit to be more energy efficient. Two, the unit will have enhanced operation in high ambient conditions.

Extra Efficiency/Performance Option

Extra efficiency option provides an increase in efficiency over the high efficiency unit by providing oversized heat exchangers for two purposes. One, it allows the unit to be more energy efficient. Two, the unit will have enhanced operation in high ambient conditions.

Ice Making

The ice making option provides special control logic and oil coolers to handle low temperature brine applications (less than 40°F [4.4°C] leaving evaporator temperature) for thermal storage applications.

Low Temperature Brine

The low temperature option provides special control logic and oil coolers to handle low temperature brine applications (less than 40°F [4.4°C] leaving evaporator temperature).

Options

Low Ambient Option

The low ambient option provides special control logic, oil coolers, and variable frequency drives on the condenser fan circuits to permit low temperature startup and operation down to 0°F (-18°C).

High Ambient Option

The high ambient option consists of special control logic and oil coolers to permit high ambient (up to 125°F [51°C]) operation. This option offers the best performance when coupled with the high efficiency performance option.

Remote Evaporator

The remote evaporator option is available on the RTAC 140-250 ton units. This option provides a pre-engineered method of installing the evaporator and all related components indoors. Remote evaporator installations allow the water loop to remain indoors to prevent freezing, thus eliminating the addition of glycol to the system and the resulting performance degradation. Please contact your Trane Sales Representative for split system design guidelines found in Engineering Bulletin RLC-PRB014-EN.

Electrical Options

Circuit Breaker

A HACR rated molded case capacity circuit breaker (UL approved) is available. The circuit breaker can also be used to disconnect the chiller from main power with a through the door handle and comes pre-wired from the factory with terminal block power connections. The external operator handle is lockable.

Non-Fused Power Disconnect Switch

The non-fused molded case disconnect switch (UL approved) is used to disconnect the chiller from main power and comes pre-wired from the factory with terminal block power connections. The external operator handle is lockable.

Single/Dual Incoming Power Line Connection

Single or dual points of termination are available for incoming power line connections*. Units with 3-4 compressors must order circuit breakers with the single point connection option.*Some restrictions may apply.

Wye-Delta Compressor Start Type

This option provides a reduced inrush starter. Wye-Delta starters are standard on 200-230 volt machines.

Control Options

BACnet Communications Interface

Allows the user to easily interface with BACnet via a single twisted pair wiring to a factory installed and tested communication board.

LonTalk (LCI-C) Communications Interface

Provides the LonMark chiller profile inputs/outputs for use with a generic building automation system.

Remote Input Options

Permits remote chilled liquid setpoint, remote current limit setpoint, or both by accepting a 4-20 mA or 2-10 Vdc analog signal.

Remote Output Options

Permits alarm relay outputs, ice making outputs, or both.

Tracer Summit Communication Interface

Permits bi-directional communication to the Tracer Summit system.

Other Options**Architectural Louvered Panels**

Louvered panels cover the complete condensing coil and service area beneath the condenser.

Coil Protection

Louvered panels protect the condenser coils only.

Compressor Sound Enhancement

Factory installed weatherproof compressor enclosure to reduce compressor sound levels.

Condenser Corrosion Protection

Copper fins and CompleteCoat are available on all size units for corrosion protection. Job site conditions should be matched with the appropriate condenser fin materials to inhibit coil corrosion and ensure extended equipment life. The CompleteCoat option provides fully assembled coils with a flexible dip and bake epoxy coating.

Convenience Outlet

Provides a 15 amp, 115 volt (60 Hz) convenience outlet on the unit.

Flange Kit

Provides a raised face flange kit that converts the grooved pipe evaporator water connections to flange connectors.

Insulation for High Humidity

The evaporator is covered with factory-installed 1.25 inch (31.8 mm) Armaflex II or equal (k=0.28) insulation. Foam insulation is used on the suction line.

Low Noise Fans

Complete fan assembly combining ultra quiet nine blade fans and TEAO fan motors to provide sound reductions with no performance degradation to the unit. The fan blades are heavy-duty molded plastic with wavy edges to reduce airflow turbulence.

Isolators - Neoprene

Isolators provide isolation between chiller and structure to help eliminate vibration transmission. Neoprene isolators are more effective and recommended over spring isolators.

Elastomeric Isolation Pads - Seismically Rated

Elastomeric isolation pads are designed and tested to control the motion of the chiller during a seismic event.

Isolators - Seismically Rated

Spring isolators are designed and tested to control the motion of the chiller during a seismic event.

Seismically Rated Unit - IBC & OSHPD

Unit is built and certified for seismic applications in accordance with OSHPD and the following International Building Code (IBC) releases: 2000, 2003, 2006 and 2009.



Options

Performance Tests

Performance and witness tests are available, based on requested operating points, to certify chiller performance in accordance with AHRI Standard 550/590.

Rapid Restart Test

After completion of a standard full load witness test, power to the chiller will be cut and then reapplied to demonstrate the chiller's rapid restart capabilities for disaster relief.

Tarp

The unit will be covered at the factory with a PVC coated polyester tarp that is tied to the chiller base to help protect the chiller from debris during shipment especially in the winter months and on shipping vessels. This option may also be helpful if the chiller will be stored at the jobsite before use.

| To Convert From: | To: | Multiply By: | To Convert From: | To: | Multiply By: |
|----------------------------------|---|--------------|--|---------------------------------|--------------------------|
| Length | | | | | |
| Feet (ft) | meters (m) | 0.30481 | British Thermal Units (BTUH) | Kilowatt (kW) | 0.000293 |
| Inches (In) | millimeters (mm) | 25.4 | British Thermal Units (BTU) | KCalorie (Kcal) | 0.252 |
| Area | | | | | |
| Square Feet (ft ²) | square meters (m ²) | 0.093 | Tons (refrig. effect) | Kilowatt (refrig. effect) | 3.516 |
| Square Inches (In ²) | square millimeters (mm ²) | 645.2 | Tons (refrig. effect) | Kilocalories per hour (Kcal/hr) | 3024 |
| Volume | | | | | |
| Cubic Feet (ft ³) | Cubic meters (m ³) | 0.0283 | Horsepower | Kilowatt (kW) | 0.7457 |
| Cubic Inches (In ³) | Cubic mm (mm ³) | 16387 | Pressure | | |
| Gallons (gal) | litres (l) | 3.785 | Feet of water (ftH ₂ O) | Pascals (PA) | 2990 |
| Gallons (gal) | cubic meters (m ³) | 0.003785 | Inches of water (inH ₂ O) | Pascals (PA) | 249 |
| Flow | | | | | |
| Cubic feet/min (cfm) | cubic meters/second (m ³ /s) | 0.000472 | Pounds per square inch (PSI) | Pascals (PA) | 6895 |
| Cubic Feet/min (cfm) | cubic meters/hr (m ³ /hr) | 1.69884 | PSI | Bar or KG/CM ² | 6.895 x 10 ⁻² |
| Gallons/minute (GPM) | cubic meters/hr (m ³ /hr) | 0.2271 | Weight | | |
| Gallons/minute (GPM) | litres/second (l/s) | 0.06308 | Ounces (oz) | Kilograms (kg) | 0.02835 |
| Velocity | | | | | |
| Feet per minute (ft/m) | meters per second (m/s) | 0.00508 | Pounds (lbs) | Kilograms (Kg) | 0.4536 |
| Feet per second (ft/s) | meters per second (m/s) | 0.3048 | Fouling factors for heat exchangers | | |
| | | | 0.00075 ft ² °F hr/BTU | = 0.132 m ² ° K/kW | |
| | | | 0.00025 ft ² °F hr/BTU | = 0.044 m ² ° K/kW | |

Temperature - Centigrade (°C) Versus Fahrenheit (°F)

Note: The center columns of numbers, referred to as BASE TEMP, is the temperature in either degrees Fahrenheit (°F) or Centigrade (°C), whichever is desired to convert into the other. If degrees Centigrade is given, read degrees Fahrenheit to the right. If degrees Fahrenheit is given, read degrees Centigrade to the left.

| Temperature | | | Temperature | | | Temperature | | | Temperature | | | Temperature | | |
|-------------|--------|-------|-------------|--------|--------|-------------|--------|--------|-------------|--------|--------|-------------|--------|--------|
| °C | C or F | °F | °C | C or F | °F | °C | C or F | °F | °C | C or F | °F | °C | C or F | °F |
| -40.0 | -40 | -40.0 | -15.0 | +5 | +41.0 | +10.0 | +50 | +122.0 | +35.0 | +95 | +203.0 | +60.0 | +140 | +284.0 |
| -39.4 | -39 | -38.2 | -14.4 | +6 | +42.8 | +10.6 | +51 | +123.8 | +35.6 | +96 | +204.8 | +60.6 | +141 | +285.8 |
| -38.9 | -38 | -36.4 | -13.9 | +7 | +44.6 | +11.1 | +52 | +125.6 | +36.1 | +97 | +206.6 | +61.1 | +142 | +287.6 |
| -38.3 | -37 | -34.6 | -13.3 | +8 | +46.4 | +11.7 | +53 | +127.4 | +36.7 | +98 | +208.4 | +61.7 | +143 | +289.4 |
| -37.8 | -36 | -32.8 | -12.8 | +9 | +48.2 | +12.2 | +54 | +129.2 | +37.2 | +99 | +210.2 | +62.2 | +144 | +291.2 |
| | | | | | | | | | | | | | | |
| -37.2 | -35 | -31.0 | -12.2 | +10 | +50.0 | +12.8 | +55 | +131.0 | +37.8 | +100 | +212.0 | +62.8 | +145 | +293.0 |
| -36.7 | -34 | -29.2 | -11.7 | +11 | +51.8 | +13.3 | +56 | +132.8 | +38.3 | +101 | +213.8 | +63.3 | +146 | +294.8 |
| -36.1 | -33 | -27.4 | -11.1 | +12 | +53.6 | +13.9 | +57 | +134.6 | +38.9 | +102 | +215.6 | +63.9 | +147 | +296.6 |
| -35.6 | -32 | -25.6 | -10.6 | +13 | +55.4 | +14.4 | +58 | +136.4 | +39.4 | +103 | +217.4 | +64.4 | +148 | +298.4 |
| -35.0 | -31 | -23.8 | -10.0 | +14 | +57.2 | +15.0 | +59 | +138.2 | +40.0 | +104 | +219.2 | +65.0 | +149 | +300.2 |
| | | | | | | | | | | | | | | |
| -34.4 | -30 | -22.0 | -9.4 | +15 | +59.0 | +15.6 | +60 | +140.0 | +40.6 | +105 | +221.0 | +65.6 | +150 | +302.0 |
| -33.9 | -29 | -20.2 | -8.9 | +16 | +60.8 | +16.1 | +61 | +141.8 | +41.1 | +106 | +222.8 | +66.1 | +151 | +303.8 |
| -33.3 | -28 | -18.4 | -8.3 | +17 | +62.6 | +16.7 | +62 | +143.6 | +41.7 | +107 | +224.6 | +66.7 | +152 | +305.6 |
| -32.8 | -27 | -16.6 | -7.8 | +18 | +64.4 | +17.2 | +63 | +145.4 | +42.2 | +108 | +226.4 | +67.2 | +153 | +307.4 |
| -32.2 | -26 | -14.8 | -7.2 | +19 | +66.2 | +17.8 | +64 | +147.2 | +42.8 | +109 | +228.2 | +67.8 | +154 | +309.2 |
| | | | | | | | | | | | | | | |
| -31.7 | -25 | -13.0 | -6.7 | +20 | +68.0 | +18.3 | +65 | +149.0 | +43.3 | +110 | +230.0 | +68.3 | +155 | +311.0 |
| -31.1 | -24 | -11.2 | -6.1 | +21 | +69.8 | +18.9 | +66 | +150.8 | +43.9 | +111 | +231.8 | +68.9 | +156 | +312.8 |
| -30.6 | -23 | -9.4 | -5.5 | +22 | +71.6 | +19.4 | +67 | +152.6 | +44.4 | +112 | +233.6 | +69.4 | +157 | +314.6 |
| -30.0 | -22 | -7.6 | -5.0 | +23 | +73.4 | +20.0 | +68 | +154.4 | +45.0 | +113 | +235.4 | +70.0 | +158 | +316.4 |
| -29.4 | -21 | -5.8 | -4.4 | +24 | +75.2 | +20.6 | +69 | +156.2 | +45.6 | +114 | +237.2 | +70.6 | +159 | +318.2 |
| | | | | | | | | | | | | | | |
| -28.9 | -20 | -4.0 | -3.9 | +25 | +77.0 | +21.1 | +70 | +158.0 | +46.1 | +115 | +239.0 | +71.1 | +160 | +320.0 |
| -28.3 | -19 | -2.2 | -3.3 | +26 | +78.8 | +21.7 | +71 | +159.8 | +46.7 | +116 | +240.8 | +71.7 | +161 | +321.8 |
| -27.8 | -18 | -0.4 | -2.8 | +27 | +80.6 | +22.2 | +72 | +161.6 | +47.2 | +117 | +242.6 | +72.2 | +162 | +323.6 |
| -27.2 | -17 | +1.4 | -2.2 | +28 | +82.4 | +22.8 | +73 | +163.4 | +47.8 | +118 | +244.4 | +72.8 | +163 | +325.4 |
| -26.7 | -16 | +3.2 | -1.7 | +29 | +84.2 | +23.3 | +74 | +165.2 | +48.3 | +119 | +246.2 | +73.3 | +164 | +327.2 |
| | | | | | | | | | | | | | | |
| -26.1 | -15 | +5.0 | -1.1 | +30 | +86.0 | +23.9 | +75 | +167.0 | +48.9 | +120 | +248.0 | +73.9 | +165 | +329.0 |
| -25.6 | -14 | +6.8 | -0.6 | +31 | +87.8 | +24.4 | +76 | +168.8 | +49.4 | +121 | +249.8 | +74.4 | +166 | +330.8 |
| -25.0 | -13 | +8.6 | 0.0 | +32 | +89.6 | +25.0 | +77 | +170.6 | +50.0 | +122 | +251.6 | +75.0 | +167 | +332.6 |
| -24.4 | -12 | +10.4 | +0.6 | +33 | +91.4 | +25.6 | +78 | +172.4 | +50.6 | +123 | +253.4 | +75.6 | +168 | +334.4 |
| -23.9 | -11 | +12.2 | +1.1 | +34 | +93.2 | +26.1 | +79 | +174.2 | +51.1 | +124 | +255.2 | +76.1 | +169 | +336.2 |
| | | | | | | | | | | | | | | |
| -23.3 | -10 | +14.0 | +1.7 | +35 | +95.0 | +26.7 | +80 | +176.0 | +51.7 | +125 | +257.0 | +76.7 | +170 | +338.0 |
| -22.8 | -9 | +15.8 | +2.2 | +36 | +96.8 | +27.2 | +81 | +177.8 | +52.2 | +126 | +258.8 | +77.2 | +171 | +339.8 |
| -22.2 | -8 | +17.6 | +2.8 | +37 | +98.6 | +27.8 | +82 | +179.6 | +52.8 | +127 | +260.6 | +77.8 | +172 | +341.6 |
| -21.7 | -7 | +19.4 | +3.3 | +38 | +100.4 | +28.3 | +83 | +181.4 | +53.3 | +128 | +262.4 | +78.3 | +173 | +343.4 |
| -21.1 | -6 | +21.2 | +3.9 | +39 | +102.2 | +28.9 | +84 | +183.2 | +53.9 | +129 | +264.2 | +78.9 | +174 | +345.2 |
| | | | | | | | | | | | | | | |
| -20.6 | -5 | +23.0 | +4.4 | +40 | +104.0 | +29.4 | +85 | +185.0 | +54.4 | +130 | +266.0 | +79.4 | +175 | +347.0 |
| -20.0 | -4 | +24.8 | +5.0 | +41 | +105.8 | +30.0 | +86 | +186.8 | +55.0 | +131 | +267.8 | +80.0 | +176 | +348.8 |
| -19.4 | -3 | +26.6 | +5.5 | +42 | +107.6 | +30.6 | +87 | +188.6 | +55.6 | +132 | +269.6 | +80.6 | +177 | +350.6 |
| -18.9 | -2 | +28.4 | +6.1 | +43 | +109.4 | +31.1 | +88 | +190.4 | +56.1 | +133 | +271.4 | +81.1 | +178 | +352.4 |
| -18.3 | -1 | +30.2 | +6.7 | +44 | +111.2 | +31.7 | +89 | +192.2 | +56.7 | +134 | +273.2 | +81.7 | +179 | +354.2 |
| | | | | | | | | | | | | | | |
| -17.8 | 0 | +32.0 | +7.2 | +45 | +113.0 | +32.2 | +90 | +194.0 | +57.2 | +135 | +275.0 | +82.2 | +180 | +356.0 |
| -17.2 | +1 | +33.8 | +7.8 | +46 | +114.8 | +32.8 | +91 | +195.8 | +57.8 | +136 | +276.8 | +82.8 | +181 | +357.8 |
| -16.7 | +2 | +35.6 | +8.3 | +47 | +116.6 | +33.3 | +92 | +197.6 | +58.3 | +137 | +278.6 | +83.3 | +182 | +359.6 |
| -16.1 | +3 | +37.4 | +8.9 | +48 | +118.4 | +33.9 | +93 | +199.4 | +58.9 | +138 | +280.4 | +83.9 | +183 | +361.4 |
| -15.6 | +4 | +39.2 | +9.4 | +49 | +120.2 | +34.4 | +94 | +201.2 | +59.4 | +139 | +282.2 | +84.4 | +184 | +363.2 |

FOR INTERPOLATION IN THE ABOVE TABLE USE:

| | | | | | | | | | | |
|-----------------------------|------|------|------|------|------|------|------|------|------|------|
| BASE TEMPERATURE (°F or °C) | 1 | 2 | 3 | 4 | 5 | 6 | 7 | 8 | 9 | 10 |
| DEGREES CENTIGRADE: | 0.56 | 1.11 | 1.67 | 2.22 | 2.78 | 3.33 | 3.89 | 4.44 | 5.00 | 5.56 |
| DEGREES FAHRENHEIT: | 1.8 | 3.6 | 5.4 | 7.2 | 9.0 | 10.8 | 12.6 | 14.4 | 16.2 | 18.0 |



Trane optimizes the performance of homes and buildings around the world. A business of Ingersoll Rand, the leader in creating and sustaining safe, comfortable and energy efficient environments, Trane offers a broad portfolio of advanced controls and HVAC systems, comprehensive building services, and parts. For more information, visit www.Trane.com.

Trane has a policy of continuous product and product data improvement and reserves the right to change design and specifications without notice.