



**AZTEC
OWNER'S HANDBOOK**



753-709

AZTEC C

PA-23-250 (six place)

**This handbook for airplanes with serial nos.
27-3050, 27-3154 and up**

Owner's Handbook



**Piper Aircraft Corporation, Lock Haven, Pa.
U. S. A.**

NOTICE

THIS HANDBOOK IS NOT DESIGNED, NOR CAN ANY HANDBOOK SERVE, AS A SUBSTITUTE FOR ADEQUATE AND COMPETENT FLIGHT INSTRUCTION, OR KNOWLEDGE OF THE CURRENT AIRWORTHINESS DIRECTIVES, THE APPLICABLE FEDERAL AIR REGULATIONS, AND ADVISORY CIRCULARS. IT IS NOT INTENDED TO BE A GUIDE OF BASIC FLIGHT INSTRUCTION, NOR A TRAINING MANUAL.

THE HANDBOOK IS DESIGNED:

1. TO HELP YOU OPERATE YOUR AZTEC WITH SAFETY AND CONFIDENCE.
2. TO MORE FULLY ACQUAINT YOU WITH THE BASIC PERFORMANCE AND HANDLING CHARACTERISTICS OF THE AIRPLANE.
3. TO MORE FULLY EXPLAIN YOUR AZTEC'S OPERATION THAN IS PERMISSIBLE TO SET FORTH IN THE AIRPLANE FLIGHT MANUAL.

IF THERE IS ANY INCONSISTENCY BETWEEN THIS HANDBOOK AND THE AIRPLANE FLIGHT MANUAL APPROVED BY THE F.A.A., THE AIRPLANE FLIGHT MANUAL SHALL GOVERN.

Revised text and illustrations shall be indicated by a black vertical line in the margin opposite the change.

Additional copies of this manual, Part No. 753 709, may be obtained from your Piper Dealer.

Published by
PUBLICATIONS DEPARTMENT
Piper Aircraft Corporation
753 709
Issued: February 1966
Revised: April 1973

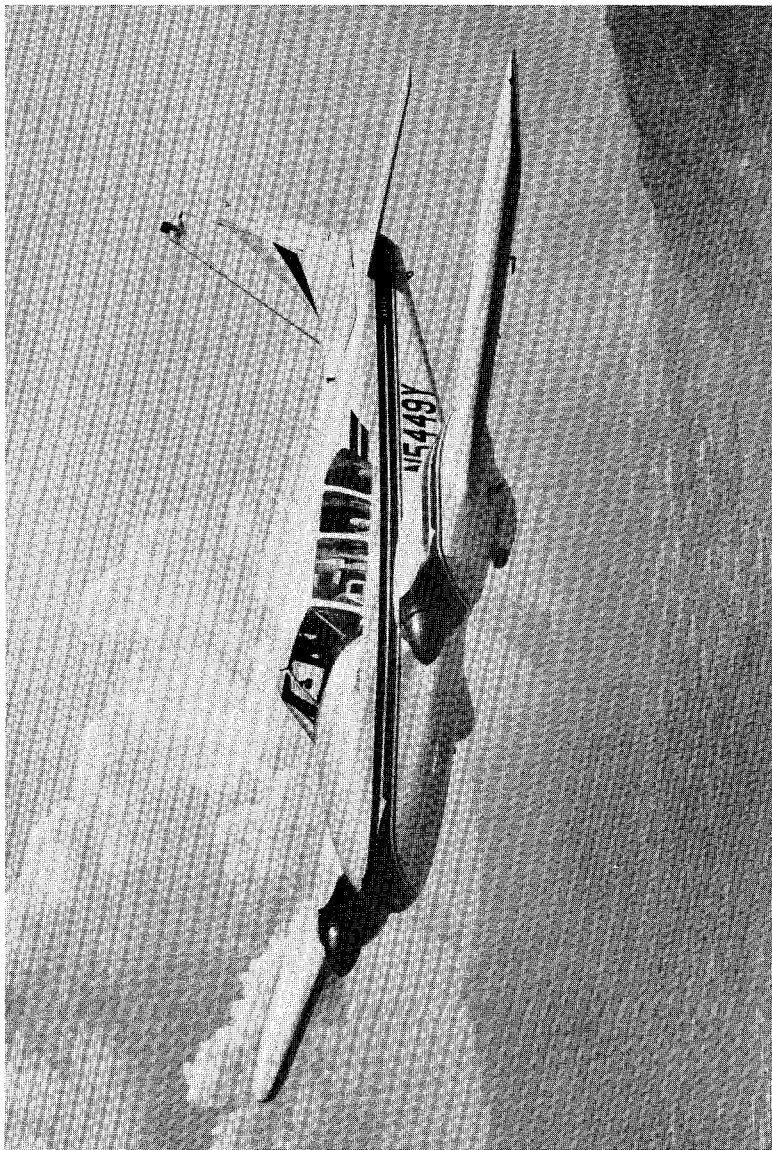

INDEX (cont)

SECTION V	Page
General Maintenance:	63
Hydraulic System Service	63
Landing Gear Service	63
Brake Service	66
Tire Inflation	67
Care of Windshield and Windows	67
Battery Service	68
Fuel and Oil Requirements	71
Care of Air Filter	71
Propeller Service	72
Leveling and Rigging	73
Serial Number Plate	74

INDEX (cont)

SECTION III (cont)	Page
Warm-Up and Ground Check	33
Take-Off	34
Stalls	35
Climb	36
Cruising	36
Approach and Landing	37
Stopping the Engines	38
Emergency Procedures	38
Ground Handling and Mooring	44
Weight and Balance	44
Operating Tips	45
Radio Operation	46

SECTION IV

Performance Charts:	48
Take-off Distance Over 50-Foot Obstacle	48
Take-off Distance vs Density Altitude	49
Climb Rate vs Density Altitude	50
Single Engine Climb Rate and Airspeed	51
Single Engine Service Ceiling vs Distance Traveled	52
True Airspeed vs Density Altitude	53
Range vs Density Altitude	54
Landing Distance Over 50 Feet	55
Landing Distance vs Density Altitude	56
Accelerate - Stop Distance	57
Altitude Conversion Chart	58
Power Chart, Lycoming IO-540-C Series.	59
Normally Aspirated Fuel Consumption	60
Power Setting Table, Lycoming IO-540-C Series	61
Fuel - Air Ratio	62

SECTION I SPECIFICATIONS

Performance	1
Weights	2
Power Plant	2
Fuel and Oil	3
Baggage	3
Dimensions	3
Landing Gear	3

INDEX

SECTION I	Page
Specifications:	1
Performance	1
Weights	2
Power Plant	2
Fuel and Oil.	3
Baggage	3
Dimensions	3
Landing Gear	3
 SECTION II	
Design Information:	6
Engine and Propeller	6
Fuel Injection	7
Fuselage and Wing Structures	9
Landing Gear	10
Hydraulic System	12
Control System and Surfaces	14
Fuel System	15
Electrical System	19
Finish.	22
Instrument Panel	23
Radio Equipment	25
Seats	25
Baggage Compartments	26
Cabin Features	26
Heating and Ventilating System	26
 SECTION III	
Operating Instructions:	31
Preflight	31
Starting	32

SECTION I

SPECIFICATIONS

PERFORMANCE

Performance figures are based on tests conducted on an airplane equipped for cross-country transportation under standard conditions as defined by F.A.A. Any deviation from standard equipment may result in changes in performance.

Take-off Run (ft) (short field)	820
Take-off Run over 50-ft barrier (short field)	1250
Minimum Controllable Single Engine Speed (mph)	80
Best Rate of Climb Speed (mph)	120
Rate of Climb (ft per min)	1490
Best Angle of Climb Speed (mph)	107
Best Single Engine Rate of Climb Speed (mph)	102
Single Engine Rate of Climb (left engine out) (ft per min)	240
Absolute Ceiling (ft)	21,100
Service Ceiling (ft)	19,800
Single Engine Absolute Ceiling (left engine out) (ft)	6,400
Single Engine Service Ceiling (left engine out) (ft)	5,000
Top Speed (mph)	216
Optimum Cruising Speed (75% power at 7,500) (mph)	206
Cruising Speed (65% power at 10,000 ft) (mph)	201
Sea Level Cruise Speed (75% power) (mph)	193
Stalling Speed (mph) (flaps down)	68

SPECIFICATIONS (cont):

NOTES

PERFORMANCE

Landing Roll (ft) (short field)	860
Landing over 50-ft barrier (short field)	1680
Accelerate-Stop Distance (ft)	2220
Fuel Consumption (gal per hr at 75% power) (gph)	27.4
Fuel Consumption (gal per hr at 65% power) (gph)	24.8
Cruising Range (maximum at 75% power at 7,500 ft) (mi)	1055
Cruising Range (maximum at 65% power at 10,000 ft) (mi)	1180
Cruising Range (45% power at 16,000 ft)	1305

WEIGHTS

Gross Weight (lbs)	5200
Maximum Landing Weight (lbs)	4940
Empty Weight (Standard) (lbs)	2933
USEFUL LOAD (Standard) (lbs)	2267

POWER PLANT

Engine (Lycoming)	IO-540-C4B5
Rated Horsepower	250
Rated Speed (rpm)	2575
Bore (inches)	5-1/8
Stroke (inches)	4-3/8
Displacement (cubic inches)	541.5
Compression Ratio	8.5:1
Dry Weight (pounds)	402

LEVELING AND RIGGING (cont):**Rigging Instructions:**

Although the fixed flight surfaces on the Aztec obviously cannot be adjusted in position for rigging purposes, it may be necessary on occasion to check the positions of these surfaces. The movable control surfaces, with the exception of the flaps, all have adjustable stops, as well as adjustments on their cables or push-pull connections, so that their range of movement can be altered. The positions and travels of the various surfaces are as follows:

1. Wings: 5° dihedral, washout 1° in 70" of distance along the front spar. (Total washout approximately 2°.)
2. Stabilator: No dihedral. Incidence is 0° in relation to horizontal. (Neutral position.)
3. Fin: Should be vertical and in line with centerline of fuselage.
4. Ailerons: Travel - 30° up, 15° down.
5. Flaps: Travel - 50° down.
6. Stabilator 9° up, 9° down.
7. Rudder: Travel - 30° left and 35° right.

For the purpose of adjusting the lateral trim on the Aztec, aileron tabs are incorporated on both ailerons. These tabs can be bent to position the aileron in flight, changing the lateral trim as desired.

SERIAL NUMBER PLATE

The serial number plate on the Aztec is located on the top of the tail stinger underneath the rudder, or underneath the aft section of the airplane on the fuselage. The serial number of the plane should always be used in referring to the airplane on service or warranty matters.

SPECIFICATIONS (cont):**FUEL AND OIL**

Fuel Capacity (U.S. gal)	144 *
Fuel, Aviation Grade (octane)	91/96
Oil Capacity (U.S. qts) (each engine)	12

* 140 gallons usable

BAGGAGE

Maximum Baggage (lbs) Forward Compartment	150
Maximum Baggage (lbs) Rear Compartment	150
Baggage Space (cubic ft) Forward Compartment	17.4
Baggage Space (cubic ft) Rear Compartment	23.2
Baggage Door Size (in) Forward Compartment	19.5 x 30.5
Baggage Door Size (in) Rear Compartment	30 x 31

DIMENSIONS

Wing Span (ft)	37
Wing Area (sq ft)	207.56
Length (ft)	30.2
Height (ft)	10.3
Wing Loading (lbs per sq ft)	25.05
Power Loading (lbs per hp)	10.4
Propeller Diameter (maximum) (in)	77

LANDING GEAR

Wheel Base (ft)	7.5
Wheel Tread	11.3

SPECIFICATIONS (cont):

LANDING GEAR

Tire Pressure	Nose	27
	Main	46
Tire Size	Nose (four ply rating)	600 x 6
	Main (eight ply rating)	700 x 6

HC-E2YK-2RB or HC-E2YR-2RB			
Temp. °F	Press. (psi)	Temp. °F	Press. (psi)
100	188	30	165
90	185	20	162
80	182	10	159
70	178	0	154
60	175	-10	152
50	172	-30	146

NOTE:
Do not check pressure or charge with propeller in feather position.

LEVELING AND RIGGING

Leveling the Aztec for purposes of reweighing or rigging is accomplished as follows:

1. Partially withdraw the two machine screws located on the side of the fuselage just forward of the right stabilator. These screws are leveling points, and the airplane is longitudinally level when indicated by the leveling instrument placed on the screws.

2. Put the airplane on jacks to obtain the longitudinally level position.

3. To level the airplane laterally and with the airplane on jacks, place a bubble-protractor on a straight edge held along the front spar on the under surface of the wing. Obtain an indication of five degrees dihedral on the protractor by lowering or raising the wing by the use of the jacks. After checking the first wing at five degrees dihedral, the opposite wing should be checked to make sure it has equal dihedral.

fluid.)

2. If the filter is found to be in good condition and is not obstructed after being properly cleaned, reinstall filter.

PROPELLER SERVICE

The air charge in the propeller cylinder should be kept at the pressure specified on the placard located in the spinner cap or on the cylinder unit. The pressure in the cylinder will vary due to temperature change, increasing about 1/3 psi for each degree Fahrenheit increase in temperature. This effect of temperature should be taken into account when checking the pressure from time to time, as a misleading interpretation might otherwise be made.

The air charge should be free from excessive moisture. Use dry nitrogen gas if available. An excess of water in the cylinder may freeze the piston during cold weather.

The Aztec may be equipped with HC-E2YK-2RB, HC-E2YR-2RB, HC-E2YK-2RBS, or HC-E2YR-2RBS propellers. The propellers with designations ending with "S" contain springs, to safeguard against an overspeed due to loss of the air charge. This spring produces sufficient force to control propeller rpm, within normal operating range, provided airspeed is reduced and power is applied slowly. When servicing propellers make certain that the propellers have the proper air charge, according to the following charts.

CHAMBER PRESSURE REQUIREMENTS WITH TEMPERATURE

HC-E2YK-2RBS or HC-E2YR-2RBS

Temp. ° F	Press. (psi)
100	74
70	70
40	66
10	62
-20	58

NOTE:

Do not check pressure or charge with propeller in feather position.

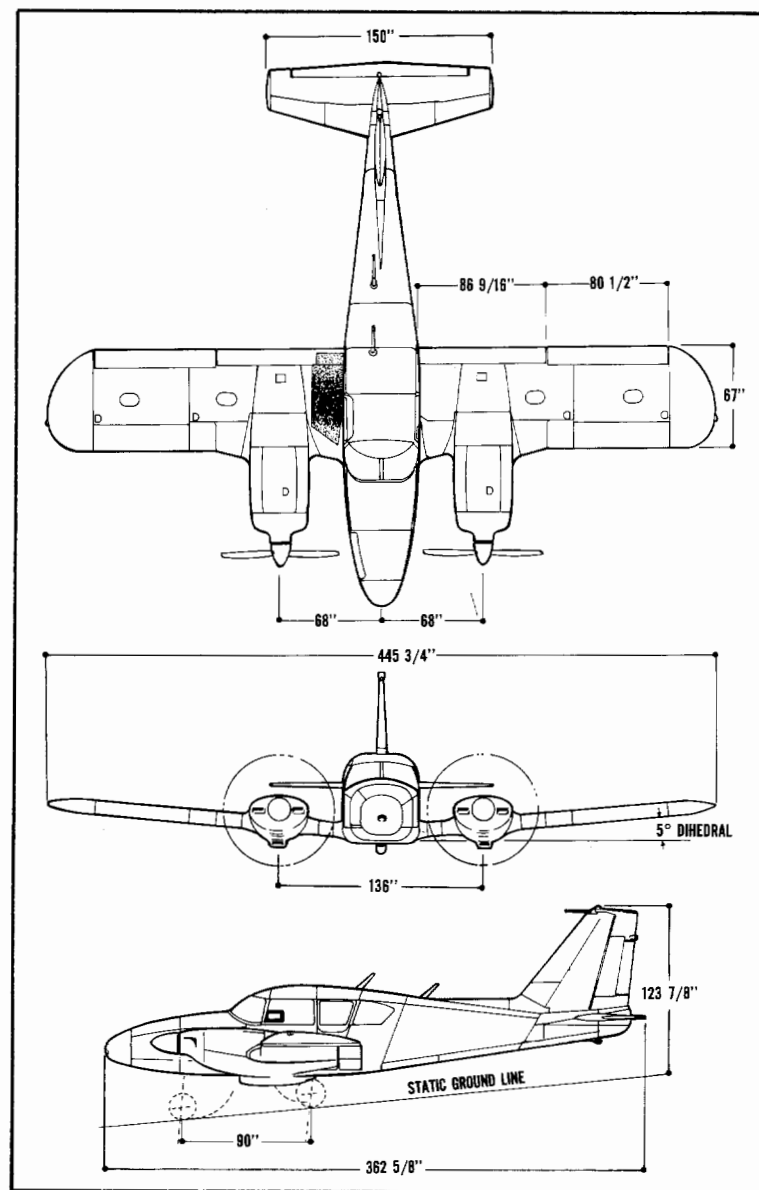

FUEL AND OIL REQUIREMENTS

Aviation grade 91/96 (minimum) octane should be used in the Aztec. The use of lower grades of fuel can cause serious engine damage in a very short period of time, and is considered of such importance that the engine warranty is invalidated by such use.

The oil capacity of the Lycoming IO-540 engine is 12 quarts. It is recommended that engine oil and oil filter element be changed every 50 flying hours, sooner under unfavorable conditions. The minimum safe quantity of oil required is 3 quarts. The following grades are required for the specified temperatures:

Temperatures above 60° F S.A.E. 50

Temperatures between 30° F and 90° F S.A.E. 40

Temperatures between 0° F and 70° F S.A.E. 30

Temperatures below 10° F S.A.E. 20

CARE OF AIR FILTER

The injector air filters must be cleaned at least once every fifty hours and depending on the type of condition existing, it may be necessary to clean the filters daily. Extra filters are inexpensive and should be kept on hand and used for rapid replacement.

The following cleaning procedure is recommended by the manufacturer of the filter:

1. Remove filter, inspect and clean by tapping it against a hard surface to remove grit, sand and dirt. (Do not blow out with an air hose, soak in oil, or cleaning

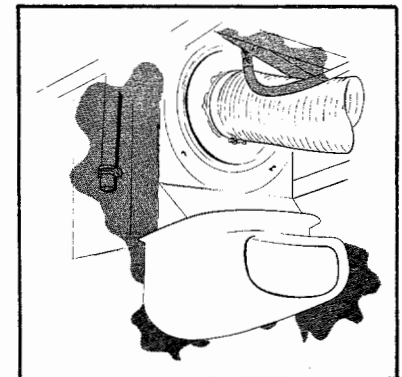

Air Filter

NOTE

Do not use gasoline, alcohol, benzene, carbon tetrachloride, lacquer thinner, or window cleaning sprays.

4. After cleaning, apply a thin coat of hard polishing wax. Rub lightly with a soft dry cloth.

5. A severe scratch or mar can be removed by using jeweler's rouge to rub out scratch, smooth on both sides and apply wax.

BATTERY SERVICE

Access to the 12 volt, 35 ampere hour battery is obtained by removing a quickly detachable access plate on the right side of the nose section. The battery is installed in a sealed stainless steel box, opened by removing wing nuts. The box has a plastic drain tube which is normally closed off with a clamp and which should be opened occasionally to drain off any accumulation of liquid.

The battery should be checked frequently for proper fluid level, but must be clean and tight. The battery and box should be flushed with soda and water in the event of any seepage from the battery.

If the battery is not up to proper charge, recharge starting with a charging rate of 4 amps and finishing with 2 amps. Quick charges are not recommended.

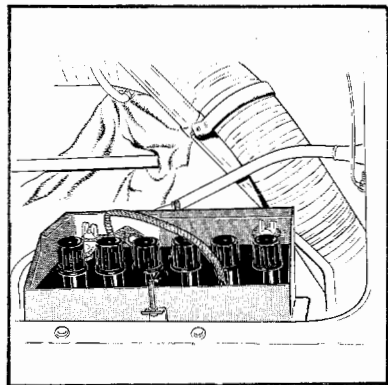

Battery Installation

SECTION II**DESIGN INFORMATION****ENGINE AND PROPELLER**

The Lycoming IO-540-C4B5 engines in the Aztec are rated at 250 HP at 2575 RPM. These engines have a compression ratio of 8.5:1 and use 91/96 minimum octane aviation fuel.

Both engines on the Aztec are equipped with a geared starter, alternator, vacuum pump, fuel injectors, two magnetos, shielded ignition system, diaphragm fuel pump, propeller governor and an oil thermostat. The left engine is equipped with a hydraulic pump.

Engine mounts are of steel tubing construction and incorporate vibration absorbing Lord mounts. Engine cowls are cantilever structures, attached at the firewall. Side panels are quickly removable by means of quick release fasteners. The nose section is split for quick removal.

The exhaust system is a crossover type with exhaust gases directed outboard at the bottom of the nacelles in the area of the cowl flaps. The cowl flaps, located on the bottom of the engine nacelles provide additional cooling for ground operation or high temperature conditions. They are manually operated by push-pull controls located in the cabin, on the fuel control panel located between the front seats.

Efficient aluminum oil coolers are mounted on a rear baffle of each engine. Engine oil drainage is accomplished with quick oil drain valves located on the inboard rear corner of the engine crankcases.

The "Compact" Hartzell HC-E2YK-2RB, HC-E2YR-2RB, HC-E2YK-2RBS, or HC-E2YR-2RBS propellers are constant speed, full feathering units which represent new concepts in basic design. They are low in weight with simplicity of design and ruggedly constructed.

The propellers with designations ending in "S" contain springs, to safeguard against an overspeed due to loss of the air charge. This spring

produces sufficient force to control propeller rpm, within normal operating range, provided airspeed is reduced and power is applied slowly. The propellers are controlled by the levers in the center of the control quadrant. Feathering of the propellers, which takes approximately three to ten seconds, is accomplished by moving the controls fully aft through the low RPM detent into the feathering position. A propeller is unfeathered by moving the prop control ahead and engaging the starter. (See Section III, for complete feathering and unfeathering instructions.)

FUEL INJECTION

The Bendix RSA-5 Type Fuel Injection System installed in the Aztec is based on the principle of measuring airflow and using the airflow signals to operate a servo valve. The accurately regulated fuel pressure established by the servo valve, when applied across a fuel control (jetting system), makes fuel flow proportional to airflow.

Fuel pressure regulation, by means of a servo valve, necessitates only a minimum fuel pressure drop through the entire metering system. This makes it possible to maintain metering pressure above vapor forming conditions, and at the same time does not require a high inlet fuel pressure. An inherent feature of the Servo System is self-purging, which eliminates any possibility of vapor lock and the associated problem of difficult starting.

The Airflow Sensing System, which is incorporated in the Servo Regulator, consists of the throttle body containing the throttle valve and venturi. The differential pressure between the entrance and the throat of the venturi is a measurement of air entering the engine. These pressures are applied to an air diaphragm in the Servo Regulator to create a force across the diaphragm. A change in power will change the airflow to the engine which in turn will change the force across the air diaphragm in the Servo Regulator.

The air diaphragm in the Servo Regulator converts the

axle. The nose wheel is removed by taking off the hub nut and withdrawing the axle bolt, the axle retainer cups, and the axle from the nose wheel fork.

Tires are dismounted from the wheels by deflating the tube, then removing the wheel through-bolts, allowing the wheel halves to be separated. In reassembling the wheels, care should be taken to torque the bolts properly, according to instruction on the wheels and reassembling for proper balance.

TIRE INFLATION

For maximum service from the tires, keep the Aztec main tire inflated to 46 lbs. and the nose tire to 27 lbs. When inflating tires, visually inspect them for cracks and breaks. Reverse the tires on the wheels, if necessary, to produce even wear. All Aztec wheels and tires are balanced before original installation, and the relationship of tire, tube and wheel should be maintained upon reinstallation. Out-of-balance wheels can cause extreme vibration in the landing gear during take-off and landing.

CARE OF WINDSHIELD AND WINDOWS

The windshield and windows are made of plexiglas and a certain amount of care is required to keep them clean and clear. The following procedure is suggested:

1. Flush with clean water and dislodge excess dirt, mud, etc., with your hand.
2. Wash with mild soap and warm water. Use a soft cloth or sponge. (Do not rub.)
3. Remove oil, grease or sealing compounds with a cloth soaked in kerosene.

In the event the oleo strut slowly loses pressure and extension, the most probable source of trouble is the air valve attachment to the leg, or the core of the air valve. These parts should be checked first to determine whether or not air leaks are occurring. If hydraulic fluid is evident on the exposed chrome plated oleo strut, the "O" rings on the piston tube bearing units may need to be replaced.

BRAKE SERVICE

The brake system is filled with MIL-H-5606 (Petroleum base, red) hydraulic brake fluid. This should be checked at every 100 hours inspection and replenished when necessary.

Do not use vegetable base brake fluids (blue) when refilling the system. When it is necessary to add fluid, open the left nose access panel, exposing the brake reservoir. Then add fluid to the reservoir, bringing the fluid to the indicated level.

If it is necessary to bleed the brake system to get air out of the lines, fluid should be added under pressure at the bleeder attachment on the brake unit.

No adjustment of brake clearances is necessary on the Aztec brakes. If after extended service, braking action requires

too much movement of the toe pedal, new brake linings can easily be installed by removing the four bolts which attach the brake units, then replacing the brake linings held in place by brass rivets.

Main wheels are quickly removed by first cutting the safety wire and removing eight bolts to drop the brake lining. Remove the dust cover, hub cap, cotter pin and axle nut. The wheel will slip off the

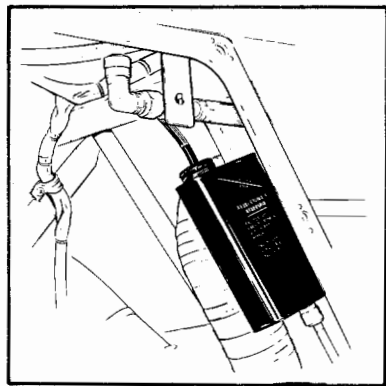

Brake Reservoir

airflow measuring signals into an air metering force. Fuel inlet pressure is applied to one side of the fuel diaphragm and the pressure of the fuel, after it passes through the fuel control (metered fuel pressure), is applied to the other side of the diaphragm. This creates a force across the diaphragm which is referred to as fuel metering force. Relatively low airflow signals develop high fuel metering forces by virtue of the diaphragm areas selected. The requirement for low airflow signals makes possible the use of a relatively large venturi which keeps engine induction system air losses to a minimum. During idle operation, when air intake is too small to create pressure differential required for operation of the diaphragm, a constant head idle spring is used to operate the diaphragm and supply the required fuel for idle.

The fuel control system, which is also incorporated in the Servo Regulator, consists of an inlet fuel screen, a rotary idle valve and a rotary mixture control valve. The idle valve is adjustable to obtain good idling characteristics without affecting metering at higher power settings. The mixture control valve gives full rich mixture on one stop and a progressively leaner mixture as it is moved toward the idle cut-off stop. The setting incorporated in the fuel control system is worked out to meet the engine requirement for all power settings without compromise. The full rich stop defines sea level requirements, and the mixture control provides altitude leaning.

The Flow Divider, which is mounted on top of the engine, is provided as a fuel distributor point. Six individual lines are connected to the Flow Divider, then routed to the cylinders. The Flow Divider contains a spring loaded positive shut-off valve and is ported to accurately divide fuel flow to the nozzle lines.

Located in each cylinder are the airbleed nozzles. The continuous flow airbleed nozzles incorporate provisions to eliminate the adverse effect of low manifold pressure at idle. Through this, lines can be maintained full of fuel to provide good distribution and acceleration characteristics. Actual fuel metering is provided by the Servo Regulator, not the nozzles, which permits leaner operation for economy and longer engine life due

to uniform cylinder head temperatures.

Installed in the instrument panel is a Fuel Flow Indicator. This instrument is connected to the Flow Divider and monitors fuel pressure. The instrument converts fuel pressure to an accurate indication of fuel flow in gallons per hour, percentage of cruise power, and properly leaned mixture for take-off at various altitudes.

NOTE

An increasing or abnormally high fuel flow indication is a possible symptom of restricted injector lines or nozzles.

Induction air for the engine enters a large air duct at the rear of the bottom cowl. The air is directed through a filter and on to the Servo Regulator. An alternate air source is incorporated to provide airflow to the engine in case the normal flow of air through the filter is restricted. The alternate air door is spring loaded and will remain closed during normal operation. In case of normal airflow restriction, the suction from the engine will open the door. The door can also be operated manually by a separate push-pull control for each engine located on the control pedestal.

FUSELAGE AND WING STRUCTURES

The Aztec fuselage is a composition of four basic units; the sheet metal tail cone, cabin section, nose section, and the steel tubular structure which extends from the tail cone to the nose wheel. The steel tube unit is intended to withstand the high loads imposed on the center section region of the airplane, and provides an extra safety factor in this area.

Finish on the tubular unit, as on all steel tube structures is zinc chromate primer with synthetic enamel.

The steering arms from the rudder pedals to the nose wheel steering torque shaft arm are adjusted at the rudder pedals or at the torque shaft rollers by turning in or out the threaded rod end bearings. Adjustment is normally accomplished at the forward end of the rods, and should be done in such a way that the nose wheel is in line with the fore and aft axis of the plane when the rudder pedals and rudder are centered. Alignment of the nose wheel can be checked by pushing the airplane back and forth with the rudder centered to determine that the plane follows a perfectly straight line. The turning arc of the nose wheel is 15 degrees in either direction and is factory adjusted at stops on the bottom of the forging. The turning radius is twenty-eight feet.

In adjusting the steering arm stops, care should be taken to see that the nose wheel reaches its full travel just after the rudder hits its stops. This guarantees that the rudder will be allowed to move through its full travel.

Adjustable rod end bearings are present on each hydraulic cylinder that actuate the landing gear struts. These rod ends should be set so that the cylinders move the landing gear retracting links just far enough to engage the spring loaded down locks and make contact at the stops. Too much extension of the adjusting screws will overload the links, and too little extension will prevent the links from traveling to the required past-center position.

Incorporated with each gear assembly is a micro-switch which closes after full movement of the gear is down. The down switches are connected individually to green indicator lights on the pedestal. The up switches are in series and make contact after each gear door is closed. When this circuit is complete, the amber "gear up" light on the pedestal lights up. The micro-switches must be adjusted carefully so that contact is made just as the gear and gear door reaches the required position.

Located in the control pedestal below the throttles are three micro-switches. These switches operate the warning horn (located in the pedestal) and the red light in the gear handle. When one throttle is retarded and the gear is up, the red light in the gear handle will flash. When both throttles are retarded, and gear is up the warning light and horn will operate.

The operation of the landing gear oleos is standard for the air-oil type; hydraulic fluid passing through an orifice serves as the major shock absorber while air compressed statically acts as a taxiing spring. The piston tube has a total travel of 8", and about 3" of tube should be exposed under normal static loads.

All of the oleos are inflated through readily accessible valves on the top of the unit, at the front. The nose wheel unit is steerable through the rudder pedals, and incorporates a shimmy dampening device at the bottom of the outer housing. All major attachments and actuating bearings are equipped with grease fittings for lubrication of the bearing surfaces, and should be lubricated periodically. (See Lubrication Chart.)

To add air to the oleo struts, a strut pump is attached at the air valve and the oleo pumped up until 3" of piston tube is exposed with normal static weight on the gears. To add oil, first release all the air through the valves, allowing the oleo to extend fully. Next remove the air valve and fill the unit through this opening. Compress the oleo again to within 1/4 inch of full compression, allowing excess oil to overflow and working out trapped air. Then reinsert the valve core and pump up the strut.

If a landing gear oleo has been completely emptied of oil during servicing, the following procedure should be used to refill it, to make sure that no air remains trapped in the unit. First, a clear plastic tube should be attached to the valve stem, from which the core has been removed. The other end of the tube should be placed in a container of hydraulic fluid. When the oleo is extended, fluid will be sucked into the oleo cylinder. The oleo should be compressed and extended until it is full of fluid and no more air bubbles appear in the plastic tube. About one pint of fluid is required to fill the oleo.

To check shimmy of the nose wheel, if it should develop, tighten the bolt on the dampening device at the base of the nose wheel forging. The bolt should be tightened just enough to keep the nose wheel from moving freely, but not enough to require excessive pressure to move the wheel by hand. It may be necessary to remove shims from the shimmy dampening collar to permit tightening of the device.

The wing structure is lightweight but rugged, and consists of a massive stepped-down main spar, a front and rear spar, lateral stringers, longitudinal ribs, stressed skin sheets, and a readily detachable wing tip section. The rectangular plan form of the wing permits the use of many interchangeable parts and simplifies the construction while providing for excellent stability and performance characteristics.

The wings are attached to the fuselage steel tubular structure with fittings at the sides and in the center of this structure, and the main spars are bolted to each other with high strength butt fittings in the center of the fuselage, making in effect a continuous main spar. This arrangement combines high strength and lightweight qualities, since heavy wing hinge fittings on the spars and fuselage are eliminated and an elaborate carry-through structure through the center section of the fuselage is no longer needed.

LANDING GEAR

All three landing gear units on the Aztec incorporate the same soft acting air-oil struts, and contain many directly interchangeable parts. (See Section V, for gear maintenance.)

Main wheels are 600 x 6 Cleveland Aircraft Products units with disc type brakes and 700 x 6 tires with an eight ply rating. The nose wheel is a Cleveland 600 x 6 model fitted with a 600 x 6 tire with a four ply rating. All tires have tubes. (See Section V, for tire service.)

Main gear brakes are actuated by toe brake pedals on the left set of rudder pedals. Hydraulic brake cylinders located in front of the left rudder pedals are readily accessible in the cockpit for servicing. Toe brakes for the right side are available as optional equipment. A brake fluid reservoir, which is connected to the brake cylinders with flexible lines provides a reserve of fluid for the brake system, and is mounted on the fuselage structure inside the left nose access panel. (See Section V, for brake service.)

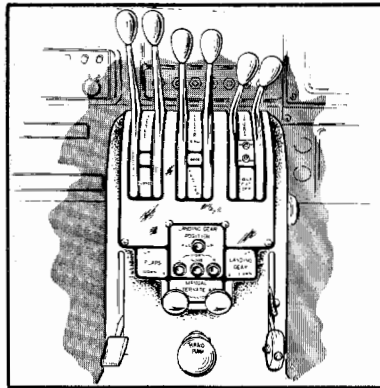

Control Pedestal

pedal action with the gear retracted is not impeded by nose gear operation.

The position of the landing gear is indicated by four light bulbs located on the pedestal. When the three green lights are on, all three legs of the gear are down and locked; when the amber light is on, the gear is entirely up and enclosed by the gear doors. When no light is on, the gear is in an intermediate position. **GEAR INDICATION LIGHTS ARE AUTOMATICALLY DIMMED WHEN THE POST LIGHT CONTROL IS TURNED ON.**

A red light in the landing gear control knob flashes when the gear is up and either one of the throttles is pulled back. When both throttles are closed beyond a given power setting, approximately 12 inches of manifold pressure with wheels not down, the landing gear warning horn sounds.

To guard against inadvertent retraction of the landing gear on the ground, a mechanical latch, which must be operated before the landing gear control can be moved upward, is positioned just above the control lever. The control knob is in the shape of a wheel to differentiate from the flap control knob, which has an air-foil shape. There is also an anti-retraction valve located on the left main gear which prevents a build-up of hydraulic pressure in the retraction system while the weight of the airplane is resting on its wheels.

SECTION V

GENERAL MAINTENANCE

HYDRAULIC SYSTEM SERVICE

The hydraulic system is filled through a filler tube located inside the left nose access panel. Only petroleum base hydraulic fluid, MIL-H-5606, should be used.

To add fluid to the system, remove the cap from the filler neck and fill the system completely while holding the filler tube extension level. Then turn the elbow on the filler tube down until the excess oil has drained out.

LANDING GEAR SERVICE

In jacking up the Aztec for landing gear and other service, a jack kit (available through the Piper Distributor Service Department) should be used. This kit includes two hydraulic jacks and a tail support; jacks are placed under jack pads on the front wing spar, and the tail support attached to the tail skid.

Approximately 250 lbs. of ballast should be placed on the base of the tail support to hold the tail down. Then the jacks should be raised until all three wheels are clear of the floor.

The right and left landing gear units on the Aztec are completely interchangeable by reversing the torque links on the gears and changing the anti-retraction valve. The oleo unit on the nose wheel gear contains parts that are also entirely interchangeable with the oleo parts on the main gears, although the oleo housing forging and the fork and axle are different on the nose wheel unit. The torque link parts and all inside components are identical on both nose and main gears.

A tow bar is provided with each airplane. When not in use, it is stowed in the forward baggage compartment.

When towing with power equipment, caution should be used not to turn the nose gear beyond its 30 degree arc as this may cause damage to the nose gear and steering mechanism.

HYDRAULIC SYSTEM

The hydraulic system is used for the extension and retraction of both the landing gear and flaps. The operation of these units is accomplished by the landing gear and flap selectors of the hydraulic control unit which is housed within the control pedestal under the engine controls. Pressure is supplied to the control unit from an engine-driven pump mounted on the left engine.

To effect extension or retraction of the gear and flaps, the controls which protrude through the face of the pedestal are moved from the center "OFF" in the desired direction. When the selected component is fully extended or retracted, hydraulic pressure within the control unit forces the control back to a "Neutral" or "Off" position, which allows the hydraulic fluid to circulate freely between the pump and the control unit. Also, it isolates the activating cylinders and associated lines from the hydraulic fluid supply. This prevents complete loss of fluid in the event of a leak in the lines between the control unit and the component or at the actuating cylinders. The return of the control handle to the "OFF" position is also a secondary indication that the components have reached full extension or retraction. The landing gear position lights and the flap indication should be used as primary indications.

Gear retraction and extension will occur normally in 14 to 16 seconds. Flap operation requires about 4 seconds.

The emergency hydraulic hand pump, which is integral with the control unit, is used to obtain hydraulic pressure in

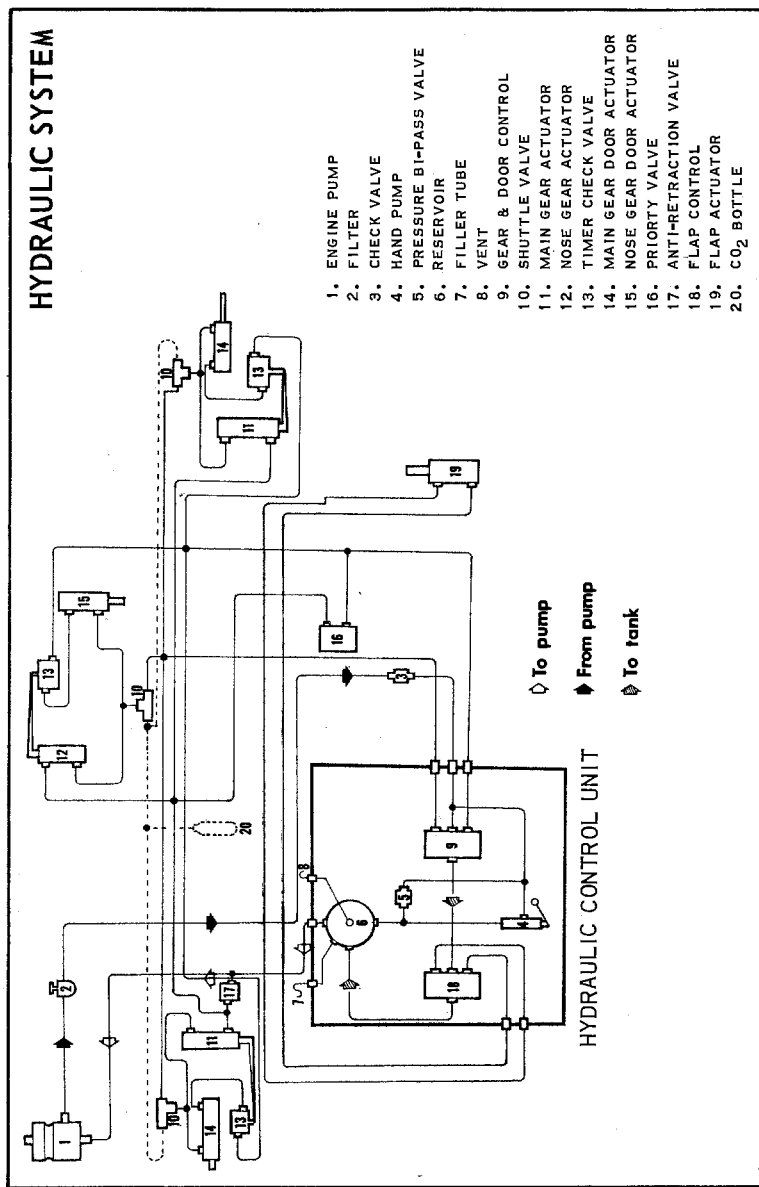

SECTION V
GENERAL MAINTENANCE

Hydraulic System Service	63
Landing Gear Service	63
Brake Service	66
Tire Inflation	67
Care of Windshield and Windows	67
Battery Service	68
Fuel and Oil Requirements	71
Care of Air Filter	71
Propeller Service	72
Leveling and Rigging	73
Serial Number Plate	74

event of failure of the hydraulic pump on the left engine. To operate the emergency pump, the handle should be extended to its full length by pulling aft and positioning the control handle as desired, 30 to 40 up and down pump strokes are required to raise or lower the landing gear.

For emergency extension of the landing gear, if failure of the hydraulic system should occur due to line breakage or hydraulic control unit malfunction, an independent CO₂ system is available to extend the landing gear.

Included on the left main gear is an oleo actuated by-pass valve which makes it impossible to retract the landing gear while the weight of the airplane is on the gear. This valve is open when the oleo strut is compressed and by-passes all hydraulic fluid, on the pressure side of the system, to the return side, preventing any pressure build-up in the retraction system. When the oleo strut is extended as in flight, or when the aircraft is on jacks, the valve is closed permitting the system to operate in the normal manner.

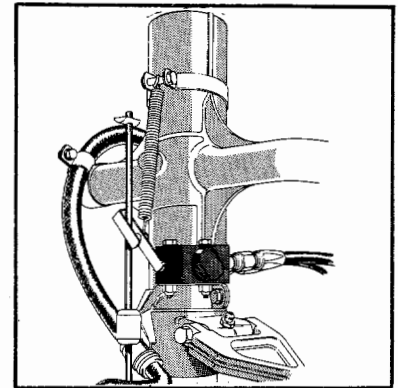

Anti-Retracton Valve

CONTROL SYSTEM AND SURFACES

Dual flight controls are provided in the Aztec as standard equipment. All controls are light, yet solid and effective in flight at all speeds down through the stalling speed. The nose wheel is steerable on the ground through the rudder pedals.

All control surfaces are cable controlled and are conventional sheet metal structures, fitted with aluminum hinges and needle bearings. The flaps are actuated by a hydraulic

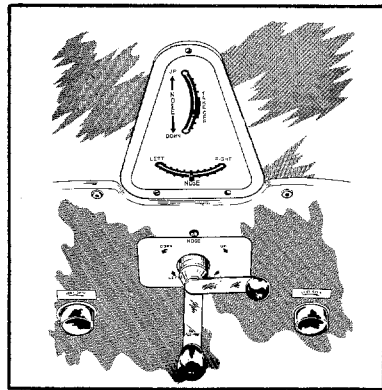

Overhead Trim Control

cylinder located in the right side of the cabin wall. Access to this cylinder is obtained by the removal of the upholstered interior panel directly aft of the entrance door, under the side windows.

The ailerons and rudder are connected by cables with the control wheel and rudder pedals. The rudder has a servo tab which also acts as a directional trim tab, actuated by a crank in the center

of the forward cabin ceiling.

The horizontal tail is a stabilator, with an anti-servo tab which also acts as longitudinal trim tab, actuated by a larger crank adjacent to the rudder tab crank in the center of the forward cabin ceiling. The stabilator provides extra stability and controllability with less size, drag and weight than with conventional horizontal tail surfaces.

FUEL SYSTEM

Four thirty-six gallon flexible fuel cells located outboard of the engines provide fuel storage in the Aztec. The cells should be kept full of fuel during storage of the airplane to prevent accumulation of moisture, and to prevent deterioration of the cells. For storage of more than ten days without fuel, the cells should be coated with light engine oil to keep from drying out.

The fuel system in the Aztec is simple, but completely effective. Fuel can be pumped from any tank to both engines, through use of the engine-driven and/or electric fuel pumps.

For normal operation, fuel is pumped by the engine-driven pumps from the tanks directly to the adjacent fuel injector. The fuel valves can be left on at all times and the crossfeed left in

PA-23-250
AZTEC C

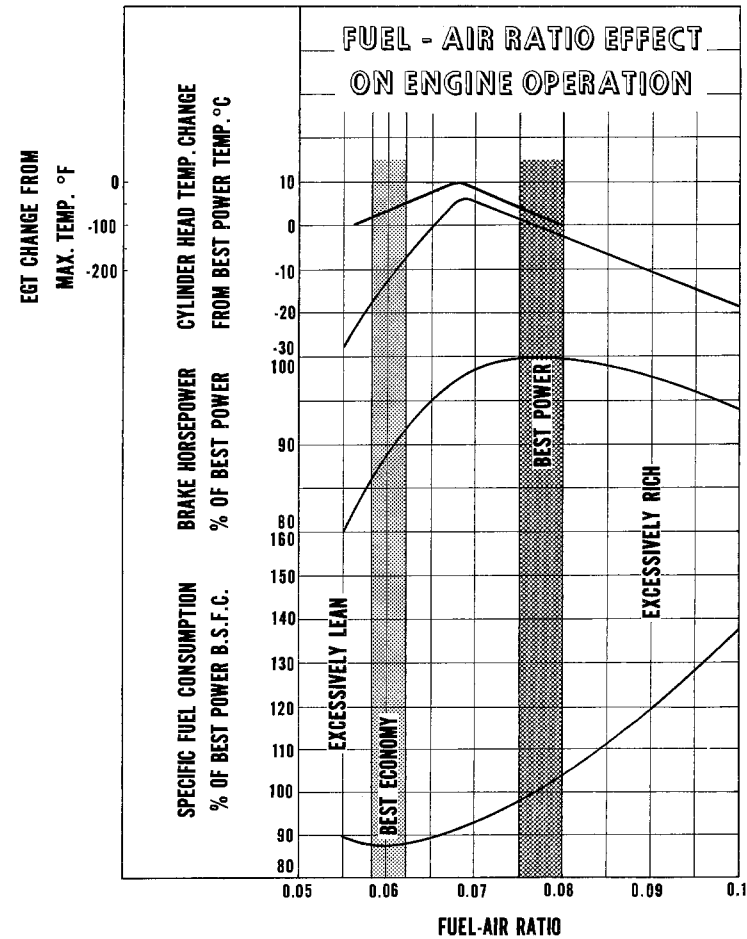

Power Chart, Lycoming IO-540-C

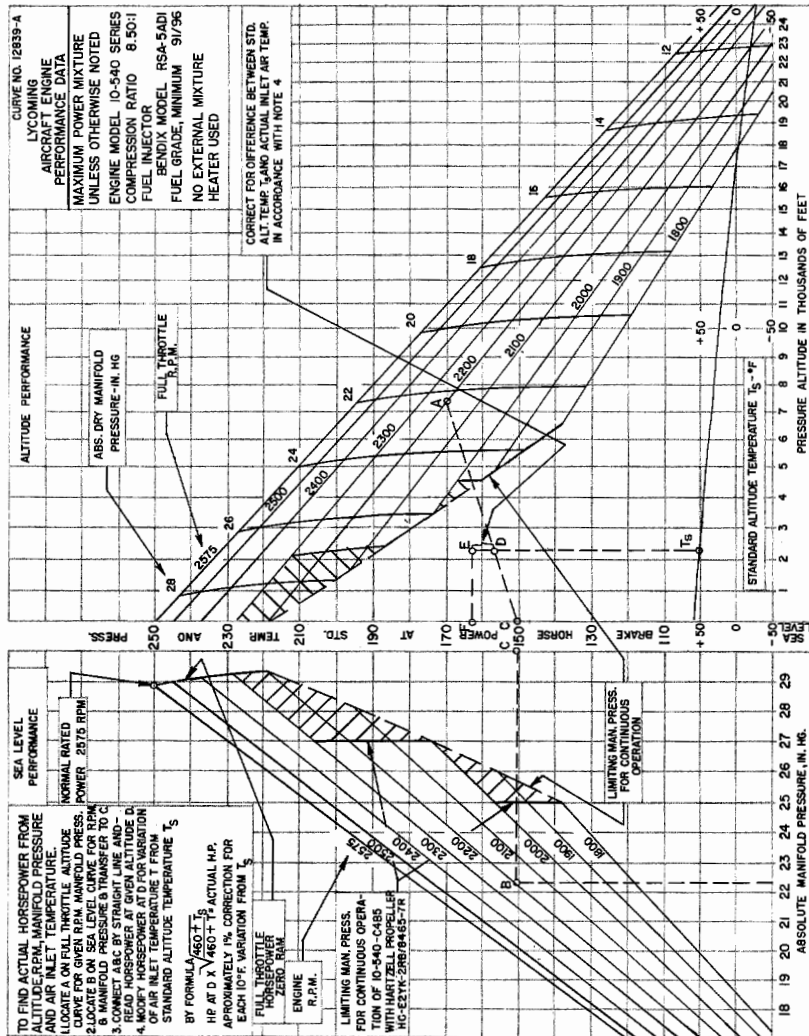

the off position. Electric auxiliary fuel pumps, located in the engine nacelles, are installed in by-pass fuel lines between the tanks and the engine-driven pumps. The electric pumps can be used to provide pressure in the event of failure of the engine-driven pumps. They are normally turned on to check their operation before starting the engines, turned off after starting, to check engine-driven pumps and left on during take-off and landing, to preclude the possibility of fuel pressure loss due to pump failure at critical times.

If one of the engine-driven pumps fails, the electric pump to that engine can be turned on to supply the fuel. However, if desired, the fuel can be pumped by the operating engine-driven pump to the failed pump engine simply by turning on the crossfeed. The good pump will then be supplying both engines from its tank. If this tank runs low on fuel, fuel can be drawn from the opposite tank by turning on the electric pump on the failed pump side, leaving the crossfeed on, and turning the fuel valve on the empty side off. Then the electric pump on the failed pump side will be supplying both engines from its tank.

Fuel can thus be used from one tank or the other, by shutting off one main valve and turning on the crossfeed, to balance fuel loads or for other purposes. For all normal operation, it is recommended that fuel be pumped directly from the tanks to their respective engines, with the crossfeed off.

The fuel valve controls and crossfeed control are located in the fuel control panel between the front seats. Two electric fuel gauges in the engine gauge cluster on the instrument panel indicate the fuel quantity in each tank. The electric fuel gauges indicate the fuel quantity in the tank selected by the fuel selector handle, located in

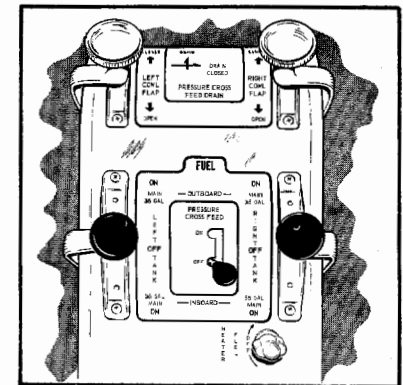

Fuel Selector

the fuel control box. The electric fuel pump switches are on the lower left side of the instrument panel.

A crossfeed line drain valve control is mounted on the front face of the fuel control panel box. This valve should be opened occasionally, with the crossfeed on, the left electric fuel pump on, and then the right electric fuel pump on to allow any water that might accumulate at that point to be drained out. The heater fuel control is also placed on the fuel control panel, so that fuel to the heater can be turned off if necessary.

The fuel strainers and fuel line drain valves are located in the inboard sides of the main wheel wells. They are fitted with quick drains and should be drained regularly through their small access ports. In order to check the fuel system for possible moisture content, each fuel cell quick drain valve should be opened and drained and the quick drain valve on the fuel strainer should be opened and drained. This procedure should be accomplished at the three quick drain valves located in each main wheel well. Fuel screens are provided at the tank outlets, in the injectors and in the fuel filter bowls.

Idle cut-offs are incorporated in the injectors and should always be used to stop the engines. This is accomplished by pulling the mixture control levers to the rearmost position.

ELECTRICAL SYSTEM

The electrical system for the Aztec includes a 12 volt 35 ampere hour battery, enclosed in a sealed stainless steel battery box. (See Section V, for battery service.) Two 12 volt 70 ampere alternators are installed as standard equipment. They are paralleled by the use of one voltage regulator to control field voltage of both units. Also, incorporated in the system is an over-voltage relay. Its function is to open and remove field voltage to the unregulated alternators in the event of a failure of the voltage regulator, thus preventing an over-voltage condition which could damage the electrical equipment.

As an added safety feature, to provide for complete dual

PA-23-250 AZTEC C

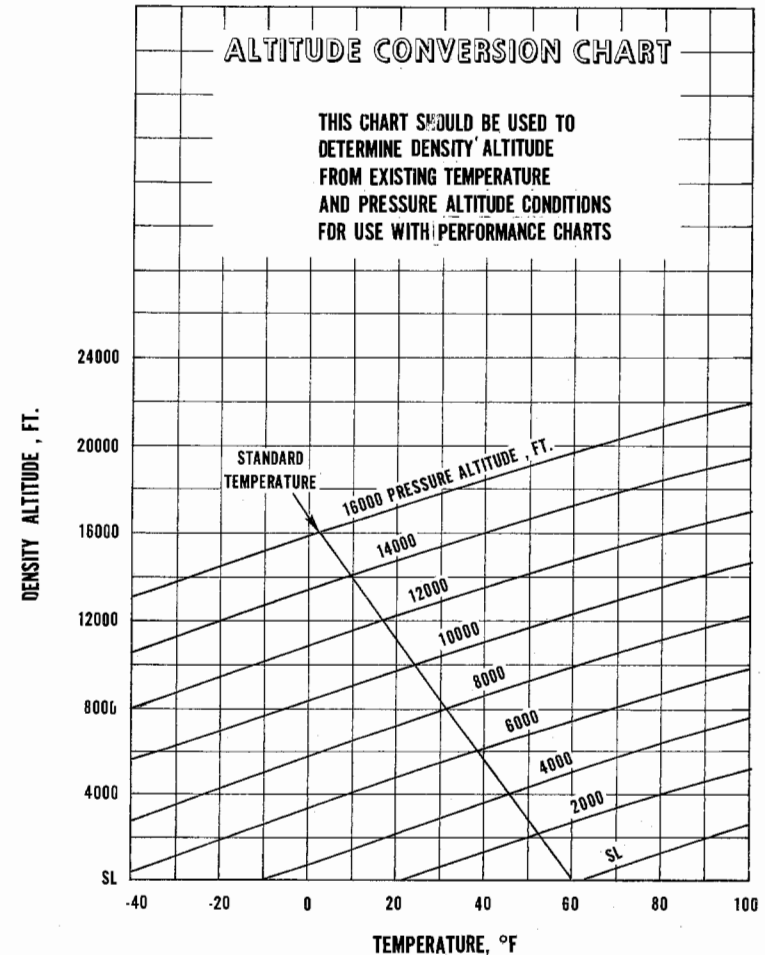

PA-23-250 AZTEC C

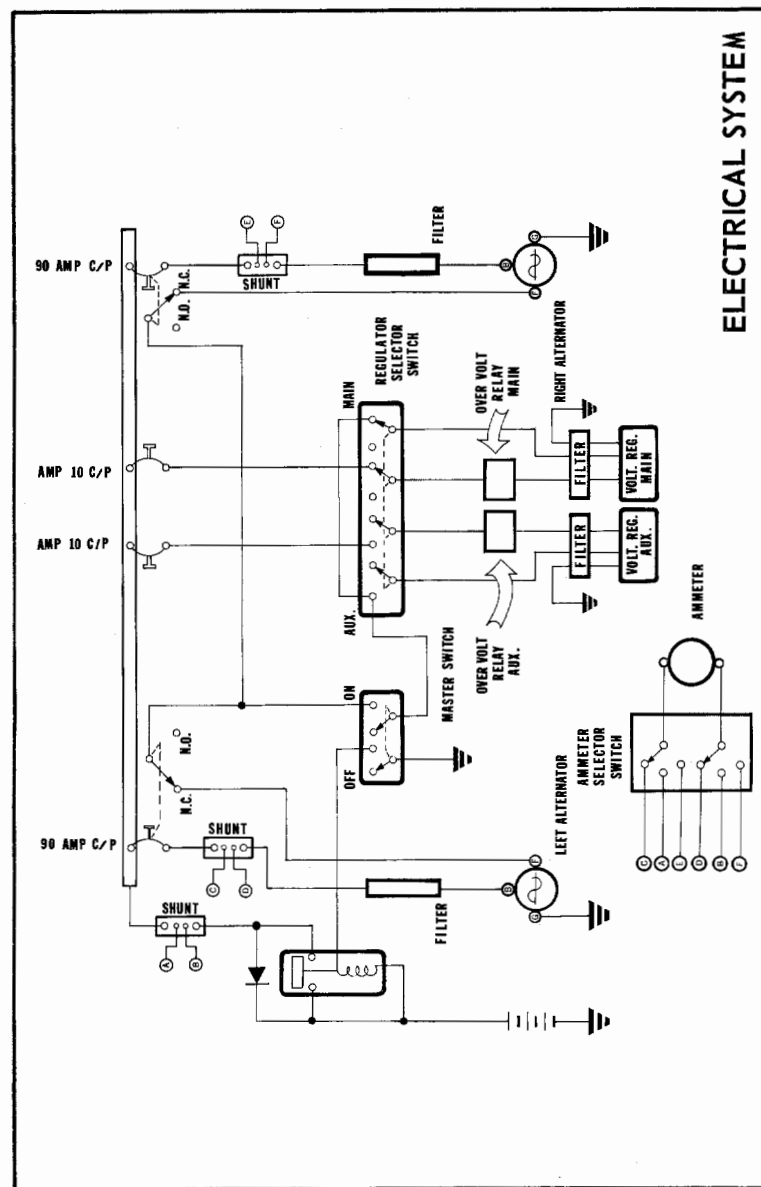
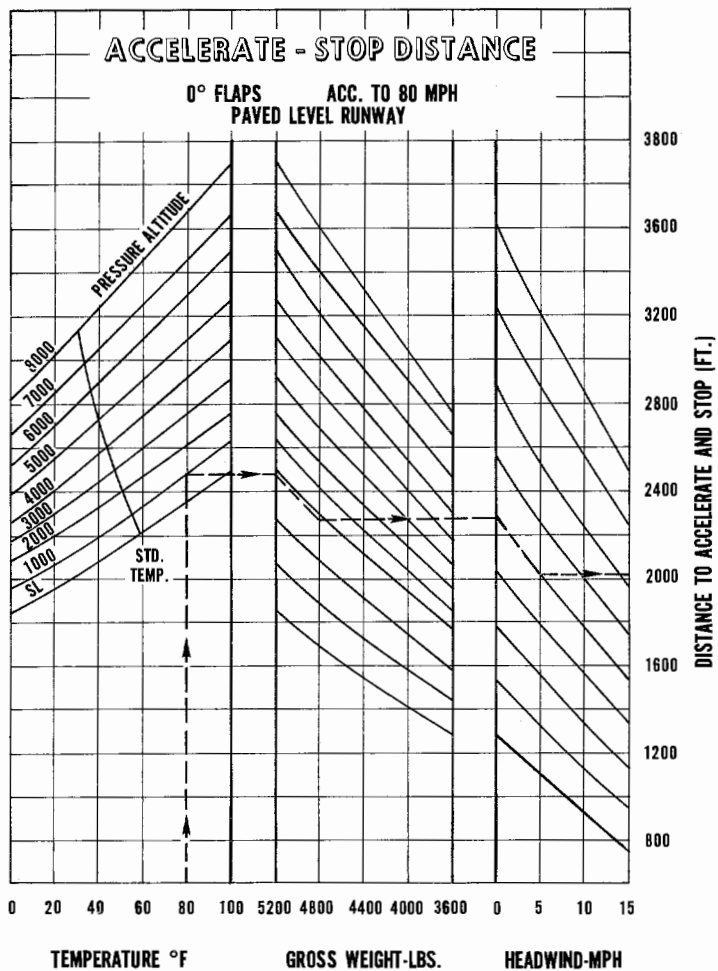

system reliability, an auxiliary voltage regulator and over-voltage relay has been installed. Each set of regulators and relays is controlled by a switch located on the pedestal. The switch is placarded "Voltage Regulator Selector", "Main", and "Auxiliary". The switch should normally be in the "Main" position. The operation of the alternators may be checked by an ammeter switch located directly under the ammeter.

Electrical switches for the various systems, including the master switch, are located on the lower left side of the instrument panel. The circuit breakers, located below the electrical switches, automatically break the electrical circuit if an overload should occur. To reset the circuit breakers simply push in the reset button. It may be necessary to allow approximately two minutes before resetting the breakers. Corrective action should be taken in event of continual circuit breaker popping. The alternator circuit breakers, mounted on the same panel, are of the switch type and should not be turned off while the engines are running.

Instrument lighting is provided by two spot lights (equipped with red lenses) installed in the center of the cabin ceiling. These lights are operated by a rheostat switch which is located directly aft of the lights. The lights are turned on with the first movement of the rheostat knob and the light intensity increased by further rotation of the control. Provided as optional equipment are individual post lamps mounted on the panel adjacent to each instrument. These lights are controlled by a rheostat switch located on the panel with the other electrical switches. Operation of the rheostat is the same as for the spot lights. Located in the cabin ceiling just aft of the windshield, on both the right and left sides, are two map lights equipped with clear lenses. Each light is operated by the switch located adjacent to the unit. For the passengers, reading lights are installed over each seat. A separate switch is incorporated for each of these units.

An overhead light is installed in both the forward and aft baggage compartments that will turn on automatically with the opening of the baggage door and turn off with the closing of the

PA-23-250 AZTEC C

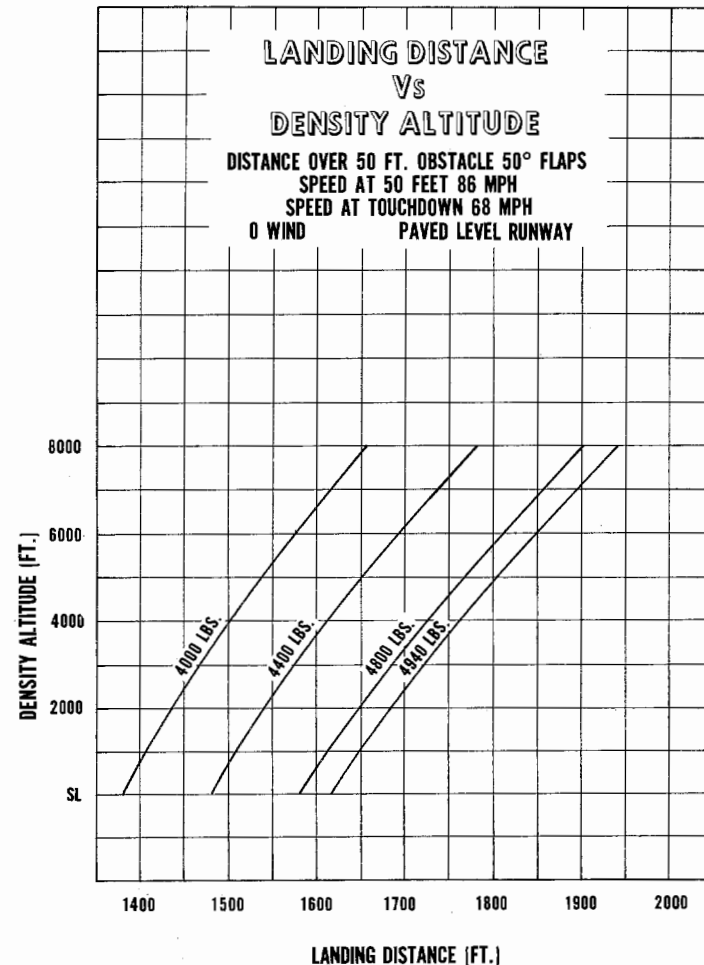

PA-23-250 AZTEC C

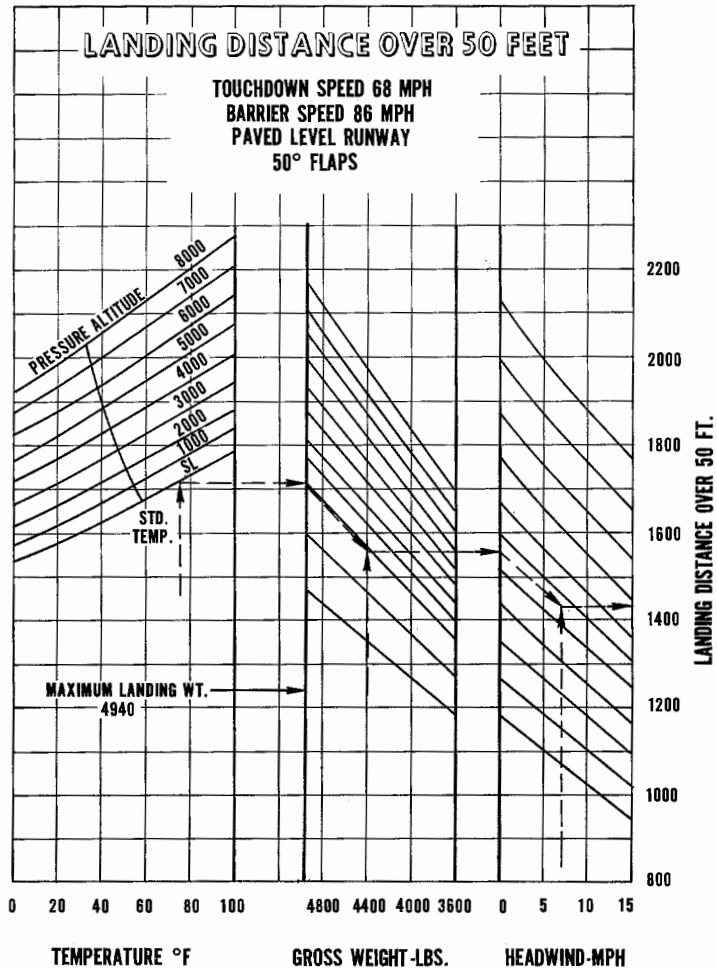

door. Should the forward baggage door not be completely closed and latched, a red warning light labeled "Door Ajar", located adjacent to the master switch will show an indication of this hazard when the master switch is on.

CAUTION

Do not leave either baggage compartment door open for extended periods.

The starter switch is located immediately above the parking brake handle on the extreme left side of the instrument panel. This switch is spring loaded and locks in the center "Off" position. To operate, pull on the switch lever and hold to left or right as desired. After starting, release the switch and it will return to the off and locked position.

As optional equipment for starting, an external power receptacle is available.

FINISH

All aluminum sheet components of the Aztec are carefully finished inside and outside to assure maximum service life. Both sides of all pieces are alodine treated, and sprayed with zinc chromate primer. External surfaces are coated with durable acrylic lacquer in attractive high gloss colors. The application of primer to interior surfaces prevents corrosion of structural and non-structural parts where inaccessible for normal maintenance.

INSTRUMENT PANEL

The instrument panel of the Aztec has been designed to accommodate all of the customary advanced flight instruments on the left side in front of the pilot, and all required engine instruments on the right side. Provisions for extra instruments have been made in both sections. The flight instrument group is shock mounted in an easily removed sub-panel. All instruments are accessible for maintenance by removing the instrument access panel over the instruments. Also the right and left instrument panels have been constructed so that they may be removed if desired for ease of maintenance.

The Artificial Horizon and Directional Gyro in the flight group are vacuum operated through use of vacuum pumps installed on both engines. A check valve is installed in the vacuum system so that in case of a pump failure the system will automatically continue to operate on the remaining vacuum source. The Turn and Bank is an electrically operated instrument and serves as a standby for the Gyros in case of vacuum system failure. The vacuum gauge in the engine instrument group should indicate 4.8 to 5.1 inches of mercury suction, required to operate the gyros when drawing air through the central filter system.

Two recording tachometers are provided to eliminate the need for constant reference to aircraft and engine log books. An engine instrument cluster, at the bottom of the engine group, includes two oil pressures, two oil temperatures, two cylinder head temperatures and two fuel quantity gauges. The gauges in this cluster can be replaced individually by removing the column of four gauges in which the defective unit is incorporated, then detaching the proper gauge from this column.

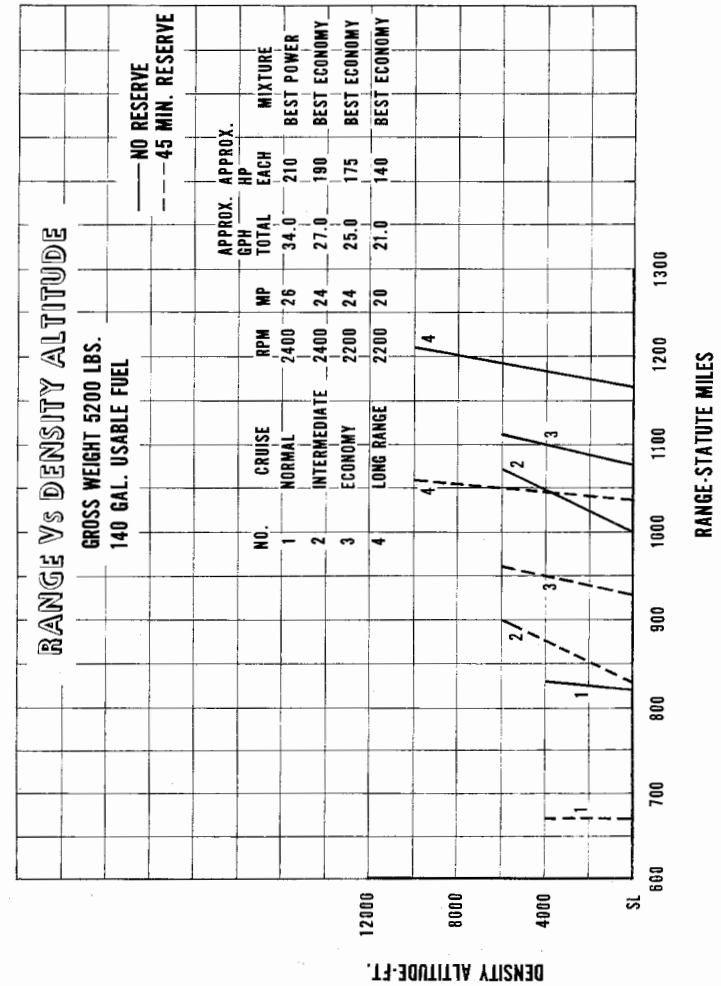
PA-23-250
AZTEC C

PA-23-250 AZTEC C

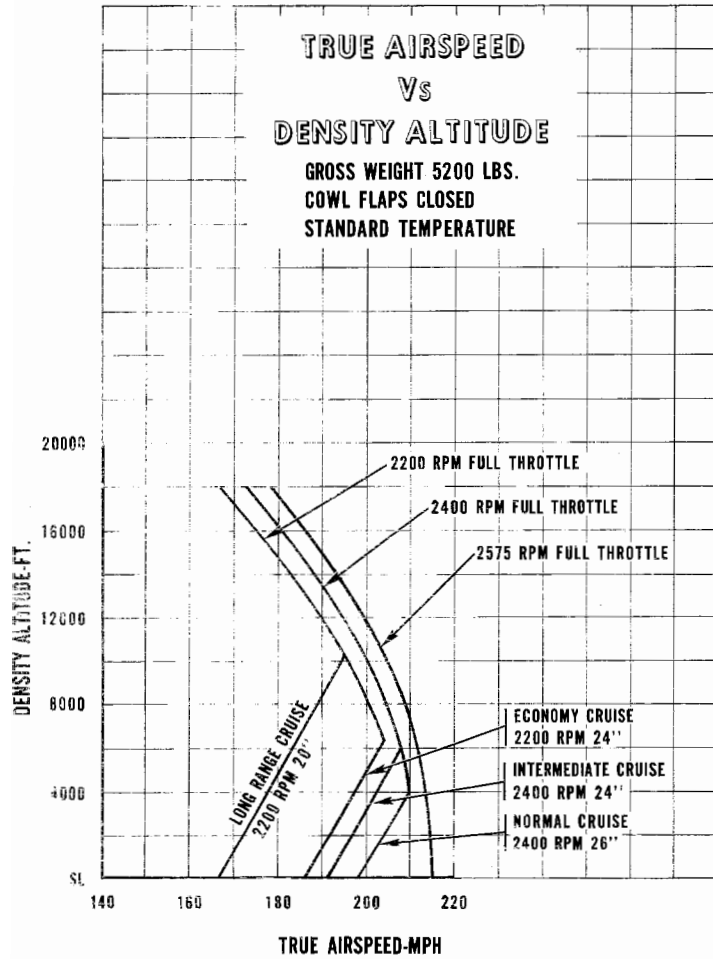

RADIO EQUIPMENT

In the standard model of the Aztec, provisions for radio installations include dual microphone and headset jacks, a microphone and headset mounting bracket, a loud speaker, wiring to these units and panel space for at least four radio sets. Radios, in different combinations, are available and are specifically chosen to provide in the Aztec all of the most recent radio developments normally desired in this type of aircraft.

Located to the rear of the forward baggage compartment is a shelf to provide ample room for the installation of power supplies, etc. for the various radios that are installed.

SEATS

All seats in the Aztec are constructed of steel tubing, with no-sag springs and foam cushions. The front seats are adjustable fore and aft through a seven inch range by operation of a release control on the front of each seat. The right front seat is also adjustable aft beyond the normal range to provide ease of entry to the pilot's seat. Both front seats are easily removed by taking out the lower bolts in the stop plates at the rear of the seat structure, swinging the stop plates laterally and sliding the seats forward off their tracks.

The rear seat area is equipped with two individual bucket type seats and a couch type seat across the full width of the cabin which will accommodate two people. To remove the two rear bucket seats, stop plates on the track are taken off, and the seats moved fore or aft as required to disengage from their tracks. The rear seat can easily be removed for added cabin space. The back of the seat is removed first by pulling it forward, then lifting it out. The bottom of the seat is pulled forward to disengage pins at the rear, then pushed back to disengage seat supports from the floorboards.

The four reclining seats are provided with headrests.

PA-23-250 AZTEC C

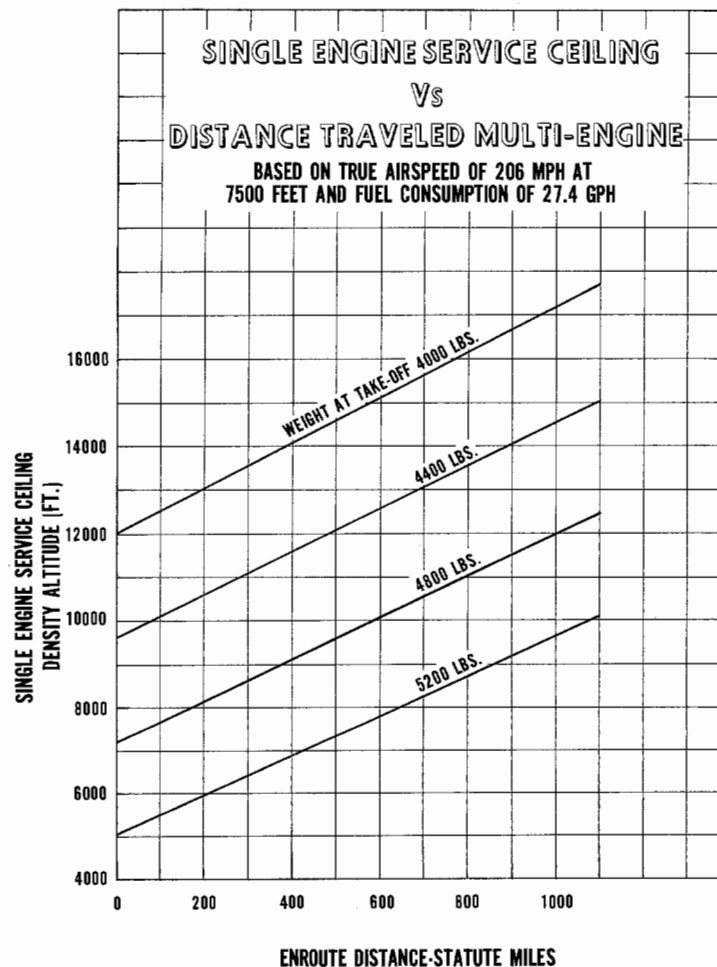

PA-23-250 AZTEC C

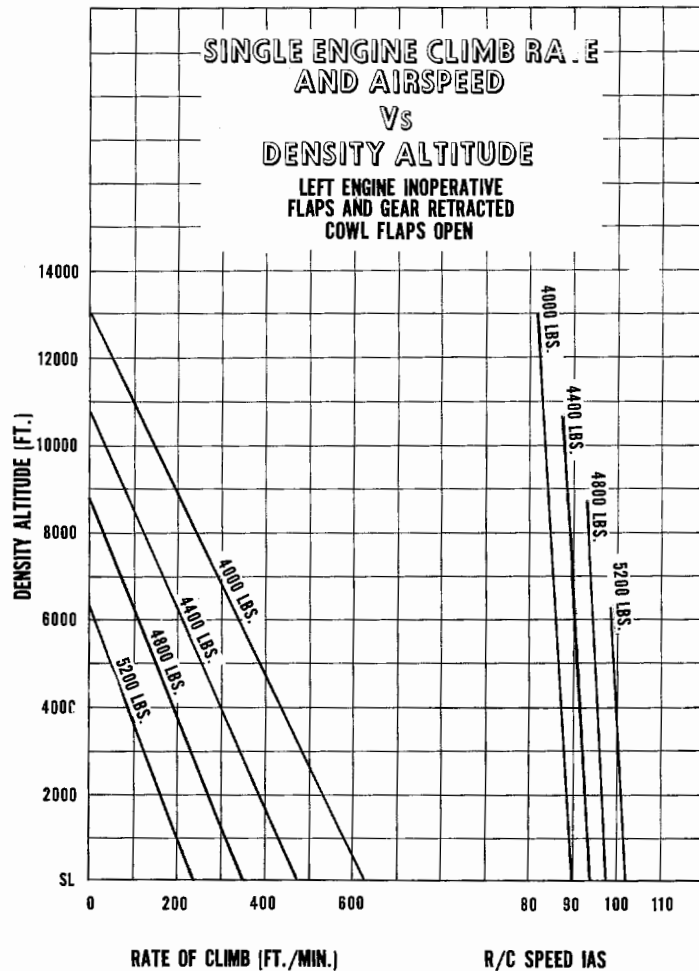

BAGGAGE COMPARTMENTS

There are two large baggage compartments, each compartment is placarded for 150 pounds. The forward compartment provides 17.4 cubic feet of space accessible through a rectangular door measuring 19.5 x 30.5 inches. The rear compartment has a volume of 23.2 cubic feet with a 30 x 31 inch door hinged on the forward side.

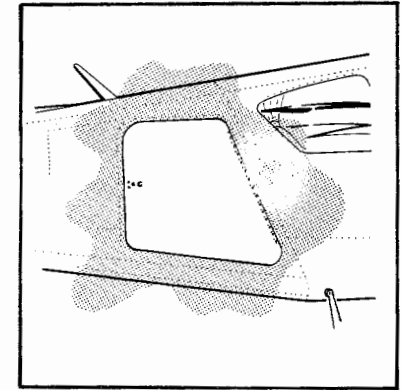

Rear Baggage Door

CABIN FEATURES

Arm rests for front and middle seats, coat hangers, ash trays, a cigarette lighter, a map drawer, reading lights and pilots map pocket are all standard. The cabin door and baggage doors are equipped with locks. The locks on both baggage doors are operated by one key, while the cabin door has a separate key.

HEATING AND VENTILATING SYSTEM

The flow of air for cooling or heating the Aztec cabin is controlled by the five knobs on the cabin air control panel located at the bottom of the control pedestal.

The left control regulates air flowing to the front seat through the heater system and the second knob from the left controls air flowing to the rear seat through this system. The middle knob controls the heater thermostat. The second knob from the right is the defroster control and the right hand control supplies additional cold air to the front seat through a vent on the bulkhead.

Cabin air enters the heater system through an inlet below

the landing light, and when the heater is not in operation, the inlet can serve as a source for cool air by pulling out the heater controls.

A 35,000 B.T.U. Janitrol heater installed in the nose section furnishes a source of hot air for cabin heating and windshield defrosting.

Operation of the heater is controlled by a three position switch located on the right side of the instrument panel, labeled "FAN", "OFF" and "HEAT". The "FAN" position will operate the vent blower only and may be used for cabin ventilation on the ground or windshield defogging when heat is not desired.

For heat the manual heater fuel valve located on the fuel selector panel must be on and the three position switch turned to "HEAT". This will start fuel flow and ignite the burner simultaneously. With instant starting and no need for priming, heat should be felt within a few seconds.

Regulation of heat, airflow and defroster operation is controlled by the push-pull knobs on the cabin air control panel. The middle knob is connected to an adjustable thermostat which makes it possible to select a desired temperature of heated air through a wide range.

Cabin temperature and air circulation can be maintained by using various combinations of knob settings, to suit individual

desires. To minimize the feeling of drafts, a low air flow-high heat combination should be used.

Windshield defrosting may be regulated by various settings of the defroster knob and in severe windshield fogging or icing conditions, it may be desirable to restrict the heater air, since this will drive more air through the defrosters.

When heat is no longer

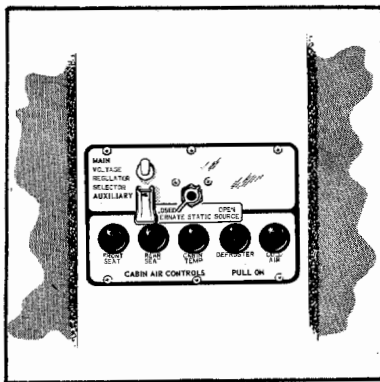

Heating And Vent Controls

PA-23-250 AZTEC C

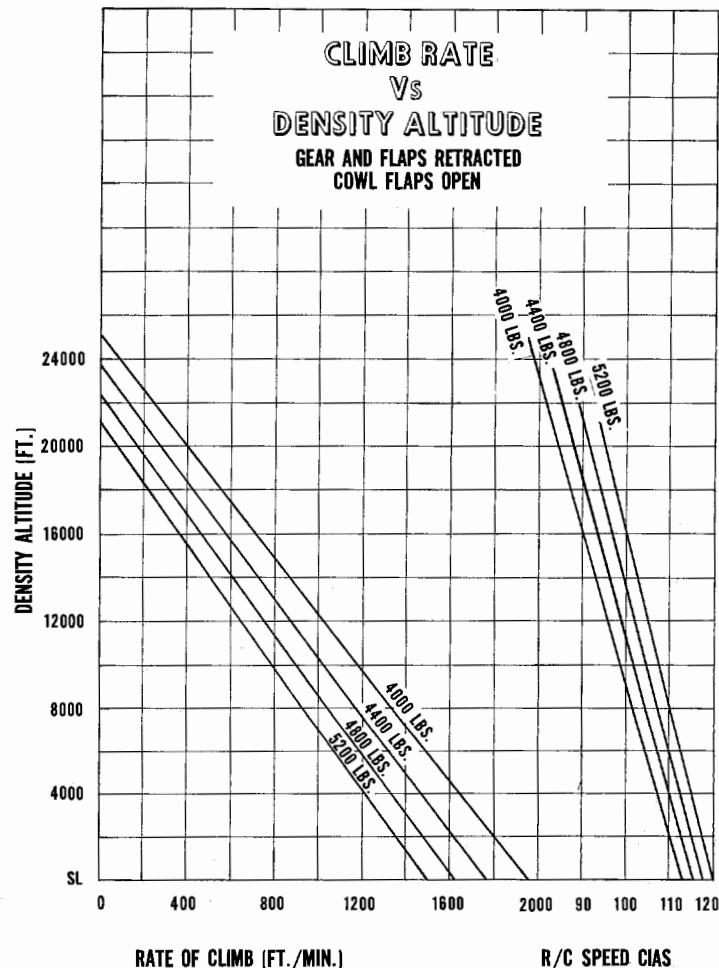

DENSITY ALTITUDE (FT.)

RATE OF CLIMB (FT./MIN.)

R/C SPEED CIAS

PA-23-250 AZTEC C

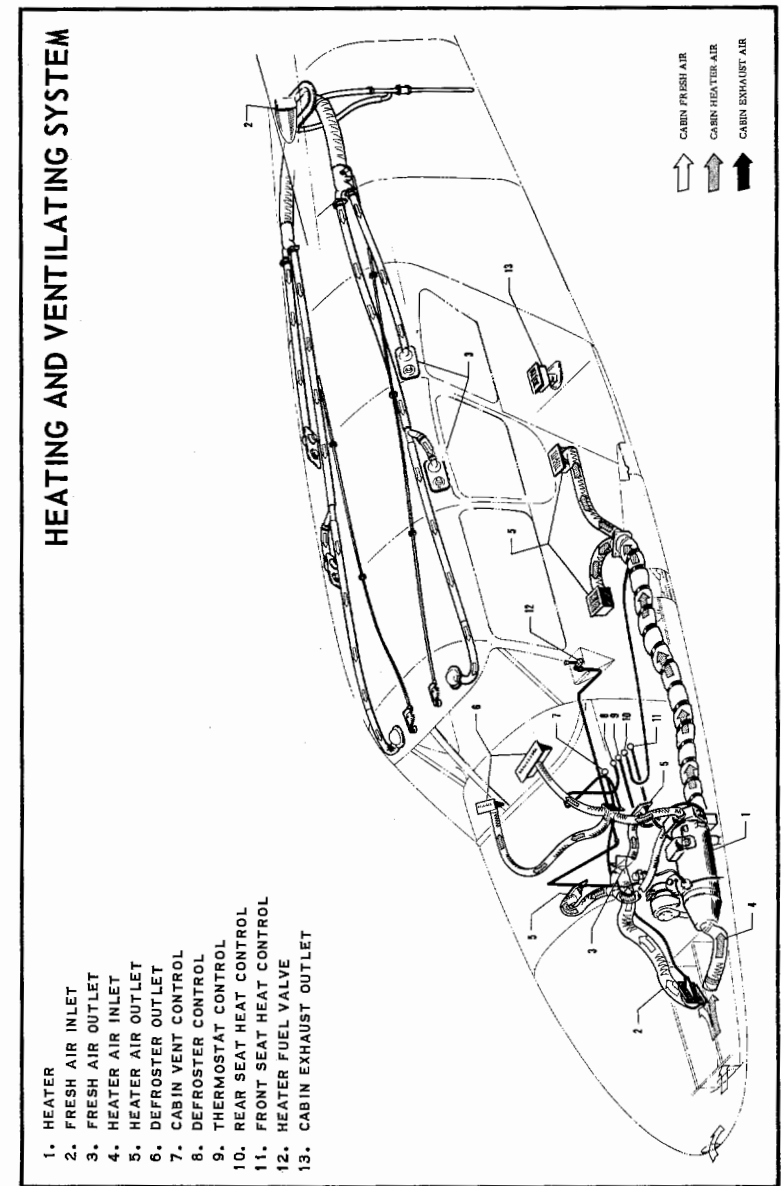
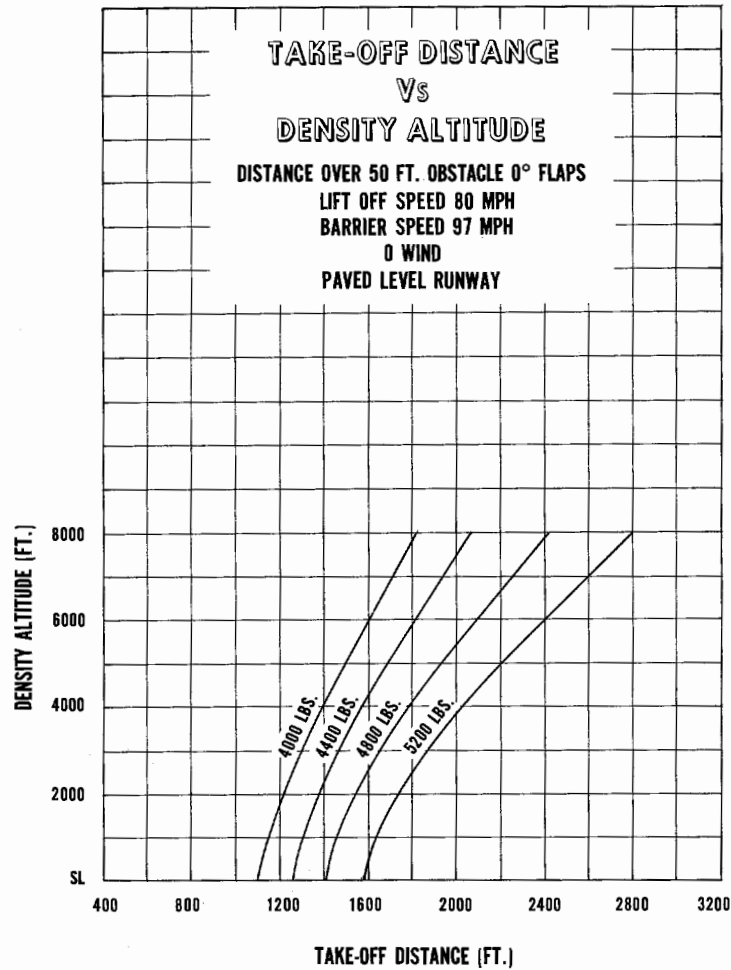

desired, the three position switch may be turned to the "OFF" position and the manual fuel valve closed. It is desirable that when the heater has been operating with the airplane on the ground, to turn the switch to "FAN" for several minutes to cool the heater and then to turn it to the "OFF" position.

Heat may be supplied to warm the cabin before flight by turning on the master switch, the left auxiliary fuel pump, and starting the heater. It should not be used in such a way as to deplete the battery.

The cabin heater uses gasoline from the left main fuel tank when the crossfeed is off and from both tanks when the crossfeed is on.

Located in the heater is a heat limit switch, which acts as a safety device to render the heater system inoperative if a malfunction should occur causing excessively high temperatures. This control is located in the down-stream end of the vent jacket, with the reset button on the heater shroud. It is reached only through the access panel in the left side of the nose section to insure that the malfunction causing the overheat condition is corrected prior to further heater operation.

For fresh air ventilation, an air scoop is mounted on the dorsal fin which draws air into the cabin through overhead vents in the ceiling. Each individual vent is adjustable for desired air flow as well as a master control regulating air from the right and left air source. These two knobs are located in the ceiling just aft of the windshield. Air is exhausted through an outlet on the floor of the aft baggage compartment.

PA-23-250 AZTEC C

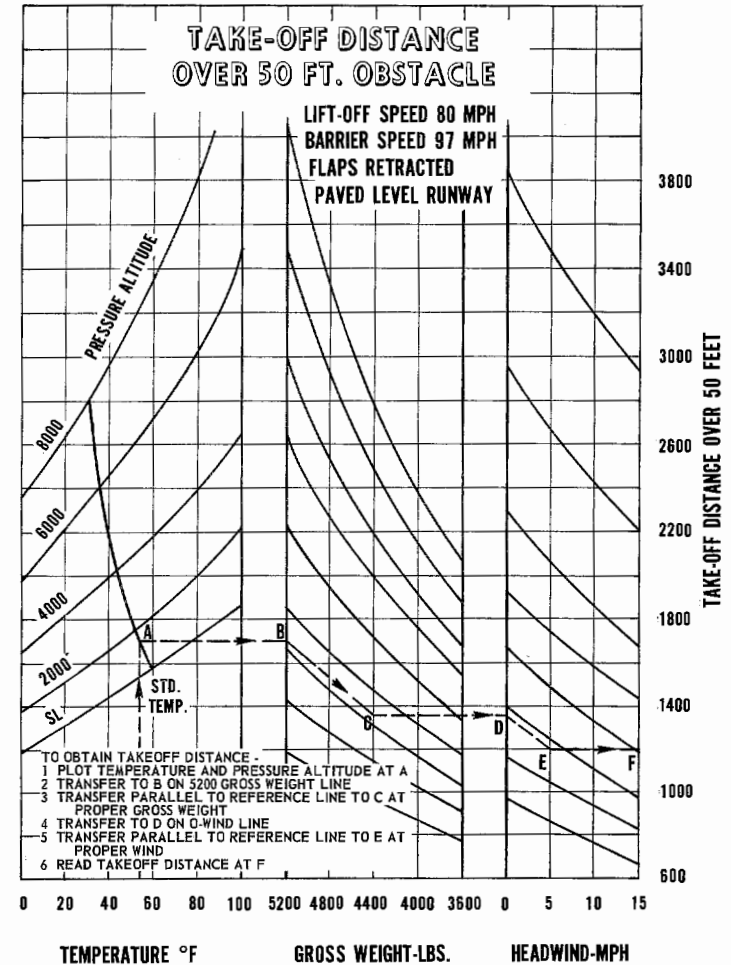

NOTES

SECTION IV

PERFORMANCE CHARTS

Take-off Distance Over 50-Foot Obstacle	48
Take-off Distance vs Density Altitude	49
Climb Rate vs Density Altitude	50
Single Engine Climb Rate and Airspeed	51
Single Engine Service Ceiling vs Distance Traveled	52
True Airspeed vs Density Altitude	53
Range vs Density Altitude	54
Landing Distance Over 50 Feet	55
Landing Distance vs Density Altitude	56
Accelerate - Stop Distance.	57
Altitude Conversion Chart	58
Power Chart, Lycoming IO-540-C Series	59
Normally Aspirated Fuel Consumption	60
Power Setting Table, Lycoming IO-540-C Series .	61
Fuel - Air Ratio	62

SECTION III
OPERATING INSTRUCTIONS

Preflight	31
Starting	32
Warm-Up and Ground Check	33
Take-Off.	34
Stalls	35
Climb	36
Cruising	36
Approach and Landing	37
Stopping the Engines	38
Emergency Procedures	38
Ground Handling and Mooring	44
Weight and Balance	44
Operating Tips	45
Radio Operation	46

A separate three position audio selector switch is provided for each receiver. Each receiver audio output may be connected to either the speaker or the headset. In addition they may be placed in the "OFF" or standby position. To receive audio through the speaker from the Marker Beacon and DME, the top radio must be in operation. This radio need not be on when headphones are connected to the Marker Beacon or DME.

Two or more sets may be simultaneously connected to either the headset or speaker position by placing the selector switches in the desired combination. For example, the A.D.F. and the top radio may be selected to operate on the speaker and the lower radio may be selected for headset operation. If desired the pilot may listen to the speaker and the copilot the headset.

10. Remember that when the post lights are on, the gear position lights are very dim.

11. Before starting the engines ascertain that all radio switches, light switches, and the pitot heat switch are in the off position so as not to create an overloaded condition when the starter is engaged.

12. The trim tab on the Aztec is very responsive and a small adjustment in trim control gives a rapid trim change attitude.

13. A high fuel pressure indication on the fuel flow indicator is a possible indication of restricted airbleed nozzles.

14. The shape of the wing fuel tanks is such that in certain maneuvers the fuel may move away from the tank outlet. If the outlet is uncovered, the fuel flow will be interrupted and a temporary loss of power may result. Pilots can prevent inadvertent uncovering of the outlet by having adequate fuel in the tank selected and avoiding maneuvers which could result in uncovering the outlet.

Normal takeoffs are not to be made when the tank selected is less than one-quarter full.

Running turning takeoffs should be avoided as fuel flow interruption may occur when the tank selected is less than half full.

Prolonged slips or skids in any pitch attitude or other unusual or abrupt maneuvers which could cause uncovering of the fuel outlet must be avoided when the tank selected is less than half full.

RADIO OPERATION

Communication and navigational equipment controls are located in the center of the instrument panel. Associated auxiliary switches are located on a separate panel to the lower left of the radio stack. Circuit breakers for the radios are located below the radio stack.

All sets are turned "ON" by the switch located on the control head of each particular unit, with the exception of the marker beacon and glide slope power switches which are located on the Audio Selector Switch Panel.

After power is supplied, the pilot may wish to operate one of the two transmitters by moving the transmitter selector switch to the proper position. The switch is located on the selector switch panel.

SECTION III OPERATING INSTRUCTIONS

PREFLIGHT

The following safety procedure instructions must become an integral part of the pilot's operational routine and preflight inspection.

Given below is an outline for preflighting the Aztec:

1. Ignition and battery switches "**OFF**".
2. a. Check for external damage or operational interference

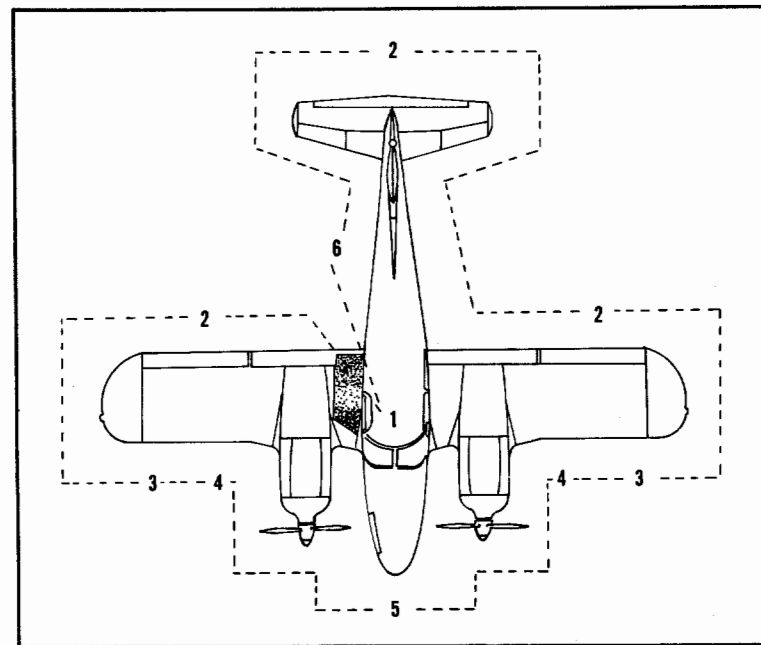

to the control surfaces, wings or fuselage.

b. Check for snow, ice or frost on the wings or control surfaces.

3. a. Check fuel supply.

b. Check fuel cell caps and covers for security (adjust caps to maintain tight seal).

c. Fuel system vents open.

4. a. Landing gear shock struts properly inflated (approximately 3" piston exposed).

b. Tires satisfactorily inflated and not excessively worn.

c. Drain fuel strainers and lines.

d. Cowling, landing gear doors and inspection covers properly attached and secured.

e. Propellers free of detrimental nicks.

f. No obvious fuel or oil leaks.

g. Engine oil at the proper level.

5. a. Windshield clean and free of defects.

b. Tow-bar and control locks detached and properly stowed. Check that baggage doors are secured.

6. a. Upon entering the airplane, ascertain that all controls operate normally.

b. Check that the landing gear selector and the other controls are in their proper position.

c. Close and secure the cabin door.

d. Check that required papers are in order and in the airplane.

STARTING

Starting Engine When Cold:

1. Magneto switches - "ON".

2. Electric fuel pump - "ON".

3. Open throttle 1/2 inch.

4. Mixture full rich. Return to idle cut-off after fuel flow indicated. Engine primed.

5. Engage starter.

OPERATING TIPS

In the operation of the Aztec, as in that of any other type of airplane, there are a few points of technique and information that apply particularly to this model. The following Operating Tips may be helpful in the operation of the Aztec:

1. Learn to trim for takeoff so that only a very light back pressure on the wheel is required to lift the airplane off the ground.

2. Due to the very rapid feathering action of the propeller on the Aztec, it will be necessary when feathering during ground check to move the propeller control in and out of feather position very quickly in order to prevent the RPM from dropping more than 500 RPM and causing excessive manifold pressure.

3. On takeoff, do not retract the gear prematurely. The airplane may settle and make contact with the ground because of lack of flying speed, atmospheric conditions or rolling terrain.

4. The best speed for takeoff is at about 80 MPH under normal conditions. Trying to pull the airplane off the ground at too low an airspeed decreases the controllability of the airplane in event of engine failure. (Minimum controllable single engine airspeed is 80 MPH.)

5. In high density areas where high traffic pattern speeds are necessary or when it is advantageous to extend the gear, it is permissible to extend the landing gear at speeds up to 150 MPH; however, it is recommended the landing gear should normally be extended at speeds below 150 MPH.

6. Flaps may be lowered at airspeeds indicated in the Airplane Flight Manual. To reduce flap operating loads, it is desirable to have the airplane at a slower speed before extending the flaps.

7. Before attempting to reset any circuit breaker, allow a two to five minute cooling off period.

8. Always ascertain position of landing gear by checking the gear position light.

9. To prevent tripping the overheat lockout switch and to get best service life from the heater components, it is recommended that the heater switch be turned to "FAN" about two minutes before stopping the engines and turning off the master switch. This is normally done during taxiing after landing.

- e. Recover power and airspeed.

Other conditions, take-off, landing approach, and general low altitude flight, will require action at the discretion of the pilot.

7. Emergency Exit Window:

Provided in the left side of the fuselage adjacent to the left center seat is an emergency exit window. The window is sealed when installed and should be removed only in case of emergency.

To remove window:

- a. Remove plastic placard.
- b. Turn handle.
- c. With hands apart on bottom sill, apply a steady sustained pressure outward until window is dislodged.

GROUND HANDLING AND MOORING

The Aztec should be moved on the ground with the aid of the nose wheel steering bar provided with each plane and installed in the baggage compartment.

Tie down ropes for mooring the airplane can be fastened to the wing tie down rings and at the tail skid.

The aileron and stabilator controls should be secured by means of a safety belt or control locks to prevent control surface damage. The rudder is held in position by its connections with the steerable nose wheel and does not need to be secured except under unusually high wind conditions.

WEIGHT AND BALANCE

It is the responsibility of the owner and pilot to determine that the airplane remains within the allowable weight vs. center of gravity envelope while in flight. For weight and balance data see the Airplane Flight Manual and Weight and Balance form supplied with each airplane.

- 6. Mixture full rich when engine fires.
- 7. Check oil pressure.
- 8. Electric fuel pump - "OFF".

If engine does not fire within 5-10 seconds, disengage starter and reprime.

Starting Engine When Hot:

- 1. Magneto switches - "ON".
- 2. Electric fuel pump - "OFF".
- 3. Open throttle 1/2 inch.
- 4. Mixture in idle cut-off.
- 5. Engage starter.
- 6. Mixture full rich when engine fires.
- 7. Check oil pressure.

Starting Engine When Flooded:

- 1. Magneto switches - "ON".
- 2. Throttle full open.
- 3. Mixture - idle cut-off.
- 4. Electric fuel pump - "OFF".
- 5. Engage starter - retard throttle and advance mixture when engine fires.

Starter manufacturers recommend that cranking periods be limited to thirty seconds with a two minute rest between cranking periods. Longer cranking periods will shorten the life of the starter.

WARM-UP AND GROUND CHECK

As soon as the engines start, the oil pressure should be checked. If no pressure is indicated within thirty seconds, stop the engine and determine the trouble. (If a very cold temperature exists (10° F or below) a little longer period of time may be necessary.)

Warm up the engines at 1000 to 1400 RPM for not more than two minutes in warm weather, four minutes in cold weather. Avoid prolonged idling at low RPM as this practice may result in fouled spark plugs. The magnetos should be checked individually with the propeller at minimum blade angle (maximum RPM). Set throttle to produce 2200 RPM. The drop should not exceed 125 RPM. The difference in drop off between both magnetos should not exceed 50 RPM.

Operation on one magneto should not exceed 10 seconds.

The propeller controls should be moved through their complete ranges during the warm-up to check for proper operation, then left in the full low pitch positions. Full feathering checks on the ground are not recommended because of the excessive vibration caused in the power plant installation. However, feathering action can be checked by running the engine between 1000 and 1500 RPM, then momentarily pulling the propeller control into the feathering position. Do not allow the RPM to drop more than 500 RPM. Also do not feather the propeller on the ground when operating at a high manifold pressure.

The electric fuel pumps should be turned off after starting or during warm-up to make sure that the engine-driven pumps are operating. Prior to take-off the electric pumps should be turned on again to prevent loss of power during take-off should an engine-driven pump fail. The engines are warm enough for take-off when the throttle can be opened without engine faltering. Do not take-off with a dead battery as some voltage is needed to excite the alternator.

TAKE-OFF

Before take-off the following should be checked:

- | | |
|------------------------------|---------------------------|
| 1. Seat belts fastened. | 7. Flaps set. |
| 2. Seats locked in position. | 8. Trim set. |
| 3. Controls free. | 9. Mixture rich.* |
| 4. Fuel on. | 10. Propeller set. |
| 5. Cowl flaps open. | 11. Engine gauges normal. |
| 6. Electric fuel pump on. | 12. Door locked. |

is located beneath a small cover plate under the pilot's seat. When this control is pulled, CO₂ flows from a cylinder under the floorboards through separate lines to shuttle valves adjacent to the gear extension cylinders. The gas pressure opens the shuttle valves, allowing CO₂ to enter the gear cylinders, extending the gears.

WARNING

The landing gear control on the selector valve must be in the "down" position when the gear extender control is pulled, in order to allow the gear to be extended properly.

The Emergency Gear Extender should only be used when all other means of lowering the landing gear have failed, and only when the gear can be left down for landing.

CAUTION

When the Extender has been used, the landing gear or flaps must not be actuated hydraulically in any way until the extension system has been returned to its normal condition.

6. In-Flight Cabin Door Closing Procedure:

In the event the cabin door is inadvertently unlocked in flight or should the handle not be pushed forward and locked before take-off and becomes dislodged from its latching mechanism, the following procedure has been determined to be practicable for closing the cabin door while in flight, assuming adequate altitude has been attained.

- Retard throttles.
- Reduce airspeed to 90 MPH or less.
- Open storm window (left of pilot).
- Close door.

restarted.

d. Single engine operation must be practiced only with a well qualified twin engine rated pilot, familiar with Aztec characteristics and procedures in one of the pilot's seats.

4. Emergency Landings:

On a wheels-up landing, the airplane will tend to settle down at the rear when the landing speed is decreasing, and full forward control wheel pressure should be used to hold the tail up as long as possible. The flaps should not be extended because they will contact the ground first, causing damage to the flap and the wing. The propellers should be feathered and stopped in a horizontal position. Fuel valves and electrical switches should be turned to off position.

A wheels-up landing should only be made during an emergency when the surface is too soft or too rough to permit a gear-down landing, or when an emergency water landing is necessary.

5. Emergency Landing Gear Extension:

Should the left engine or engine-driven hydraulic pump fail, extension of the landing gear or flaps is accomplished by supplying hydraulic pressure with the manual hydraulic pump. With the gear or flap control in the desired position, 30-40 strokes of the pump handle will raise or lower the landing gear, and 12 strokes will raise or extend the flaps.

In the event of hydraulic system failure caused by a line breaking or the powerpak malfunctioning, the landing gear can be lowered by using the Emergency Gear Extender. The control for the extender

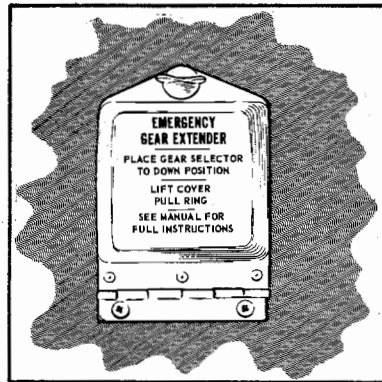

Emergency Gear Extender

During a normal take-off, with the full power at 2575 RPM and full rich mixture, the pointer on the fuel flow meter will stabilize between the sea level mark and the red line. This setting gives a slightly rich mixture to aid in cooling the engine and is recommended for normal take-off at sea level.

*When taking off from a high altitude field, (example 4,000 feet), the mixture should be leaned to obtain maximum power. This is done during the pretake-off check. Apply full throttle, then move mixture control towards the lean position until the fuel flow pointer has stabilized at the 4,000 foot mark, located approximately at the 18 gallon mark. Leave the mixture in this position and proceed with the take-off. Caution should be used when operating with the mixture leaned so that the engine is not overheated.

After the take-off has proceeded to the point where a landing can no longer be made wheels-down in event of power failure, the wheels should be retracted. When the wheels are up, the throttles should be brought back to climbing power, 24 inches of manifold pressure, and the RPM reduced to 2400. Minimum single engine speed (80 MPH) should be attained before take-off.

STALLS

All controls are effective at speeds down through the stalling speed, and stalls are gentle and easily controlled.

STALL SPEED TABLE	
Configuration	(Power Off)
Gear and Flaps Up	74 MPH
Gear and Flaps Down (Full)	68 MPH
These figures are at gross weight of 5200 lbs.	

Lazy eights and chandelles may be performed provided a 60° angle of bank or a 30° angle of pitch is not exceeded.

CLIMB

The best rate of climb is obtained at 120 MPH, but to give a high forward speed as well as a good rate of climb, a cruising climb speed of 135 MPH is recommended. Turn the electric fuel pump off after climb out.

CRUISING

The revised cruise power concept applicable to the Aztec "C" permits more efficient use of the available horsepower with no decrease in warranty. Simplified power management allows a more constant manifold pressure and eliminates continual reference to power charts. The following cruise settings are recommended:

	MP	RPM	Altitude	Speed
Normal	26	2400	4000	210
Intermediate	24	2400	6000	208
Economy	24	2200	6400	204
Long Range	20	2200	10,200	195

Refer to Power and Performance charts for other power settings. Do not exceed 27 inches of manifold pressure below 2300 RPM or 25 inches of manifold pressure below 2000 RPM.

To INCREASE power, first increase RPM; then increase manifold pressure.

To DECREASE power, first decrease manifold pressure; then decrease RPM.

To obtain the desired cruise, set the manifold pressure and RPM according to the power setting table.

For information on leaning procedure see Avco Lycoming Operator's Manual.

g. To prevent shake, close throttle until propeller is completely out of feather.

h. Resynchronize engines.

If the engine has been inoperative for several minutes, particularly in low temperatures, prime by turning the boost pump "ON" and moving the mixture control forward until the first indication of fuel pressure, then return to "IDLE CUT-OFF". Leave boost pump "ON" and start as in (c).

The standard Aztec, operating at gross weight under optimum conditions of turbulence and pilot technique, and under standard conditions of temperature and altitude, has a single engine absolute ceiling of 6400 feet at 5200 pounds and maximum obtainable power.

Under ideal conditions, the Aztec can be expected to maintain approximately the stated maximum altitudes. When adverse conditions of turbulence, temperature, altitude, pilot technique, or airplane condition or equipment is encountered, the absolute ceiling will be reduced. These factors must be taken into consideration in the single engine operation of any twin engine airplane.

Pilots of this airplane should remain reasonably proficient in single engine flight. In many cases, "simulated" single engine operation (zero thrust condition, approximately 10 inches of manifold pressure and 2200 RPM) will be preferable, but actual single engine operation should be practiced occasionally. The following precautions should be exercised in actual single engine flight:

a. Do not feather a propeller if there is reason to suspect that the starting characteristics of the engine are not normal and that restarting in the air may be difficult or impossible.

b. Do not feather a propeller in conditions of temperature, altitude, weight or turbulence which may prevent single engine flight at altitudes well above the local ground elevation.

c. Do not feather a propeller at any time when conditions of terrain or other conditions may prevent the airplane from reaching an airport easily, in case the dead engine cannot be

pump if left engine is out). If enough altitude has been reached for reaching the airport with the gear extended, leave the landing gear in the down position.

d. Maintain a best rate of climb airspeed of 102 MPH.

e. Trim directionally with rudder trim.

f. As the airport is approached for landing, reduce power on the good engine and gradually retrim with the rudder tab. When it is obvious that the airport can be reached easily, lower the landing gear and check the indicators to make sure it is down and locked. Maintain a little extra altitude and speed during the approach, keeping in mind that the landing should be made right the first time, and that either undershooting or overshooting may require the use of full power on the good engine, making control more difficult. Lower the flaps at the last moment if desired.

NOTE

If the left engine is inoperative the gear and flaps must be pumped down by hand.

3. Unfeathering:

It is not recommended that propeller feathering and unfeathering be practiced on the ground because of the excessive vibration that occurs in the engine installation. In flight, feathering should be practiced only to familiarize the pilot with the proper procedures. To unfeather a propeller in flight, the following technique is recommended:

- a. Turn fuel "ON".
- b. Mixture control to idle cut-off.
- c. Propeller control forward to cruise setting.
- d. Turn electric fuel pump "ON".
- e. Rotate engine with starter until it will windmill by itself.
- f. Ignition switches to "ON".

APPROACH AND LANDING

During the approach, the gear can be lowered at speeds under 150 MPH and the flaps at speeds listed on the landing check list below. As the speed decreases, the flaps can be lowered slowly to counteract pitch trim changes and little or no trim will be necessary. Normally about 12 inches of manifold pressure should be maintained to give a reasonable approach angle. RPM should be left at high cruising RPM or approximately 2400. This propeller setting gives ample power for an emergency go-around and will prevent over-speeding of the engines if the throttles are advanced sharply. The mixture control should be kept in full rich position to insure maximum acceleration if it should be necessary to open throttle again.

The amount of flap used during landings and the speed of the airplane at contact should be varied according to the wind, the landing surface, and other factors. It is always best to contact the ground at the minimum practicable speed consistent with landing conditions.

Normally, the best technique for short and slow landings is to use full flap and a small amount of power, holding the nose up as long as possible before and after ground contact. In high wind conditions, particularly in strong crosswinds, it may be desirable to approach the ground at higher than normal speeds, with half or no flaps.

Landing check list:

1. Mixtures "RICH".
2. Electric fuel pumps "ON".
3. Fuel selectors on proper tanks.
4. Propellers at high cruising RPM.
5. Landing gear "DOWN" (under 150 MPH), check green indicator lights on, landing gear warning horn off, and flashing

red light in gear handle off.

6. Flaps full down or as desired.

Full Flap	125 MPH (max)
1/2 Flap	140 MPH (max)
1/4 Flap	160 MPH (max)

When selecting less than full flap, the flap selector handle must be manually returned to neutral position when the desired amount of flap has been extended. Due to the immediate response of the flap operating mechanism, partial flap positions can be best obtained by successive rapid cycling of the flap selector handle.

If, for any reason, it becomes necessary to "go-around" apply full power, retract the landing gear, and put the flaps up as quickly as possible.

STOPPING THE ENGINES

During the landing roll, the flaps should be raised, the heater turned to "FAN", and the electric fuel pumps off. After parking, the radios should be turned off and the engines stopped by pulling the mixture controls aft to idle cut-off. The throttles should be left full aft to avoid engine vibration while stopping. Then the ignition and master switches must be turned off, and the parking brakes set.

EMERGENCY PROCEDURES

1. Engine Failure:

An engine failure on the Aztec during cruising flight presents very minor operational problems. As the engine loses power, a slight yaw in the direction of the dead engine will occur, which can be corrected easily with the rudder or the rudder trim tab. While the plane is slowing down to the single engine cruising speed of about 138 MPH at low altitudes and at

moderate power settings, the propeller on the dead engine should be feathered by pulling the throttle to idling position and the prop pitch control back fully; then the mixture should be set at idle cut-off and the ignition off. Best single engine performance will be obtained with the dead engine wing held up about 3 degrees higher than level to help counteract the tendency to turn in that direction.

CAUTION

If the left engine has failed, the hydraulic pump will not be functioning. If it is necessary to lower the landing gear or flaps with the left engine dead, the hydraulic hand pump located in the pedestal is used. (See 5, this section.)

2. Feathering:

The Hartzell feathering propellers can only be feathered while the failed engine is rotating, and not if the engine drops below 1000 RPM, because the centrifugal force due to rotation is necessary to hold out a stop-pin which keeps the propeller from feathering each time the engine is stopped on the ground. Therefore, if an engine freezes up, it will not be possible to feather its propeller. In that case, single engine flight can be maintained with the dead engine propeller unfeathered, although a noticeable decrease in single engine performance will take place.

If an engine failure occurs during take-off run, the power on the good engine should be cut and the airplane stopped straight ahead. If it occurs after leaving the ground, but with sufficient landing area still ahead, a landing should be effected immediately. If no landing can be made directly after the failure, the following steps should be followed:

- Apply full power to good engine.
- Feather dead engine.
- Retract landing gear and flaps, if extended (using hand

Power Setting Table (Cruise) - Lycoming Model IO-540-C4B5, 250 HP Engine

Normal Cruise		Intermediate Cruise		Economy Cruise		Long Range Cruise	
RPM	MP	RPM	MP	RPM	MP	RPM	MP
2400	26.0	2200	26.0	2200	24.0	2100	21.0
		2300	25.0	2300	23.2	2200	20.0
		2400	24.0	2400	22.4	2300	19.3

1. To maintain constant Power, correct manifold pressure approximately 0.17" Hg. for each 10° F variation in induction air temperature from standard altitude temperature. Add manifold pressure for air temperatures above standard; subtract for temperatures below standard.
2. To determine fuel consumption for these power settings refer to the Fuel Consumption Chart.
3. When using Hartzell Propeller HC-E2YK-2RB/8465-7R or HC-E2YK-2RBS/8465-7R or HC-E2YR-2RB/8465-7R or HC-E2YR-2RBS/8465-7R with IO-540-C4B5 engine. DO NOT EXCEED 27" MANIFOLD PRESSURE BELOW 2300 RPM or 25" BELOW 2000 RPM.

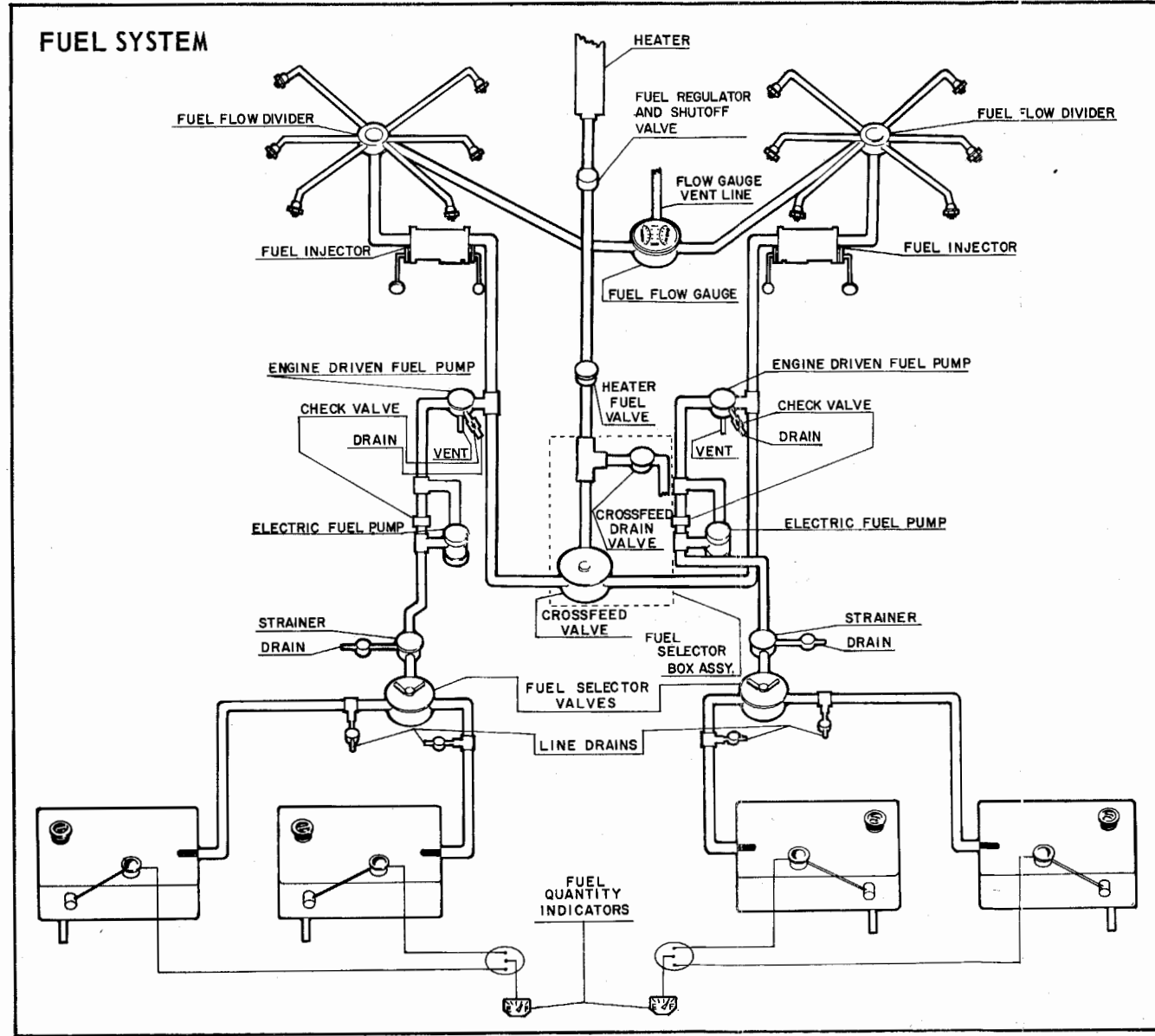

PA-23-250 AZTEC C

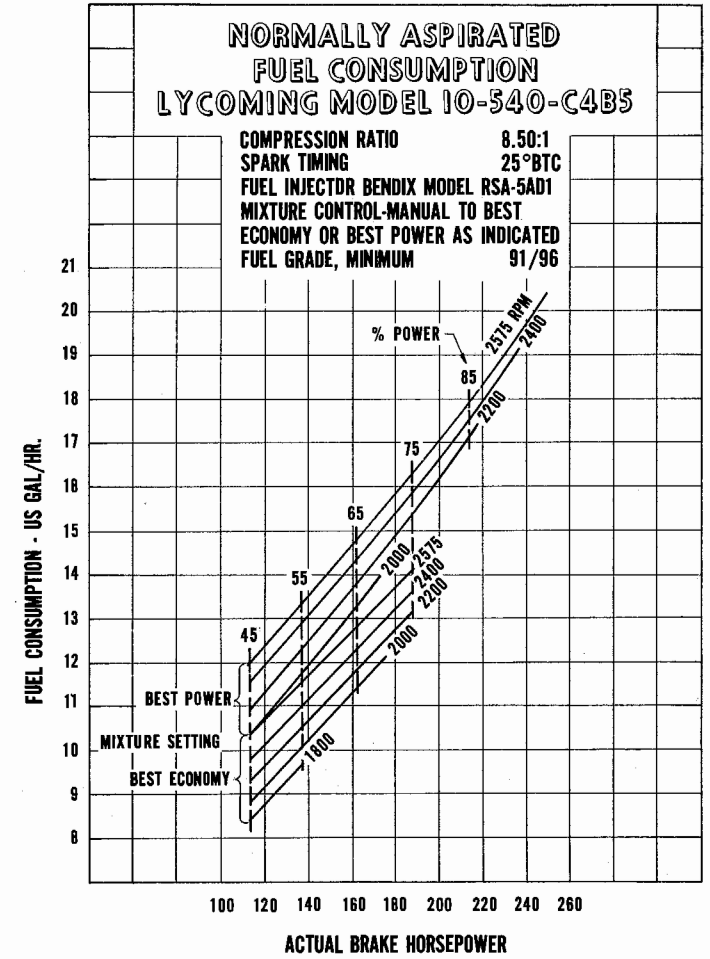

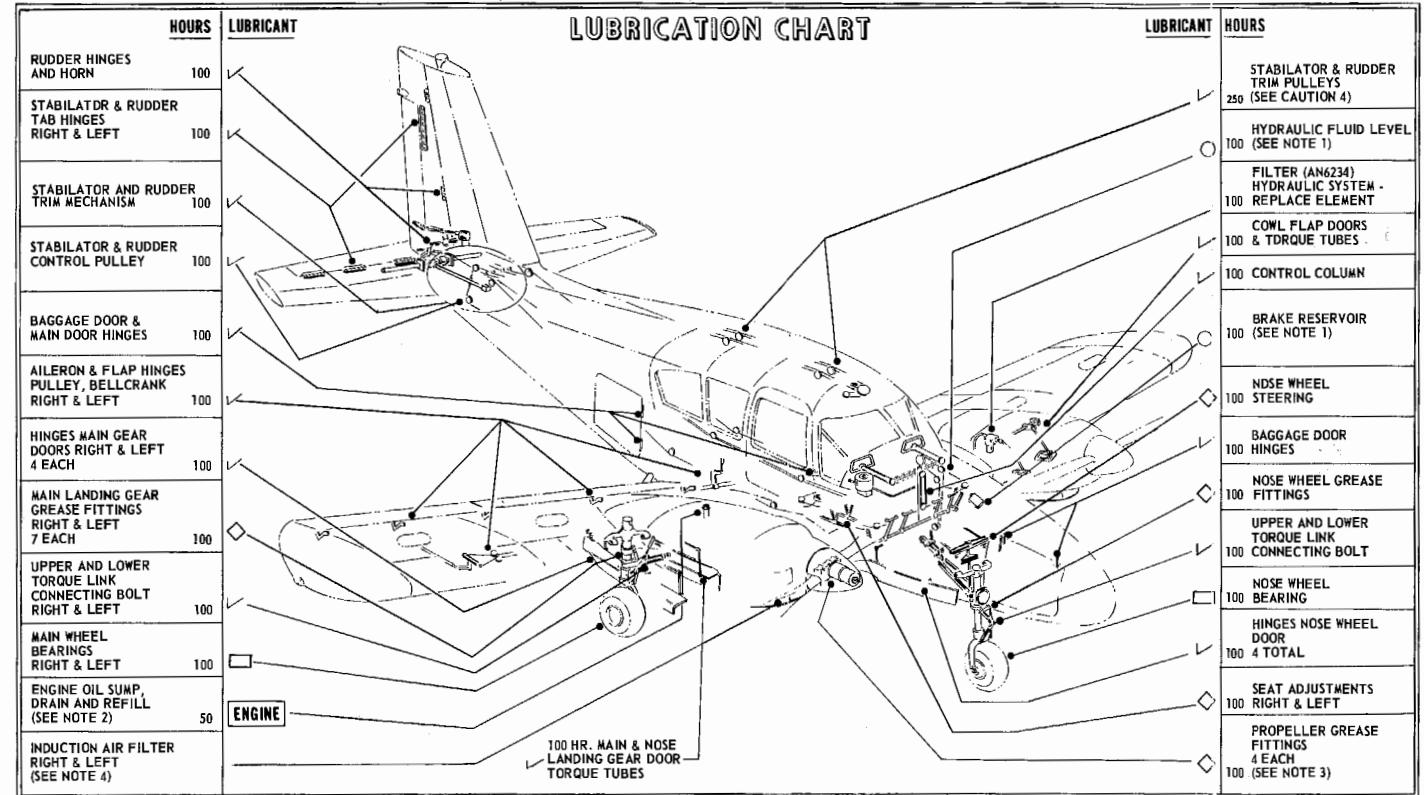

- NOTES**
1. OLEO STRUTS, POWER PACK RESERVOIR AND BRAKE RESERVOIR - FILL PER INSTRUCTIONS ON UNIT OR CONTAINER, OR REFER TO SERVICE MANUAL, SECTION II.
 2. INTERVALS BETWEEN OIL CHANGES CAN BE INCREASED AS MUCH AS 100% ON ENGINES EQUIPPED WITH FULL FLOW (CARTRIDGE TYPE) OIL FILTERS - PROVIDED THE ELEMENT IS REPLACED EACH 50 HOURS OF OPERATION.
 3. PROPELLER - REMOVE ONE OF THE TWO GREASE FITTINGS FOR EACH BLADE. APPLY GREASE THROUGH FITTING UNTIL FRESH GREASE APPEARS AT HOLE OF REMOVED FITTING.
 4. INDUCTION AIR FILTER - CLEAN AIR FILTER PER SERVICE MANUAL OR OWNER'S HANDBOOK. REPLACE WHEN NECESSARY.
 5. LUBRICATION POINTS - WIPE ALL LUBRICATION POINTS CLEAN OF OLD GREASE, OIL, DIRT, ETC. BEFORE RELUBRICATING.

- LEGEND**
- ◇ MIL-G-23827 GREASE, AIRCRAFT, INSTRUMENTS, GEAR ACTUATOR SCREW
 - ∨ MIL-L-7870 OIL - GENERAL PURPOSE LOW TEMP. LUBRICATION
 - MIL-L-3545 GREASE - LUBRICATION HIGH TEMPERATURE
 - MIL-H-5606 HYDRAULIC FLUID (RED)
 - ENGINE SAE 50 ABOVE 60° F AIR TEMP
 - ENGINE SAE 40 BETWEEN 30° F AND 90° F AIR TEMP
 - ENGINE SAE 30 BETWEEN 0° F AND 70° F AIR TEMP
 - ENGINE SAE 20 BELOW 10° F AIR TEMP
 - SEE LYCOMING SERVICE INSTRUCTIONS NO. 1014 FOR USE OF DETERGENT OIL.

- CAUTIONS**
1. DO NOT USE A HYDRAULIC FLUID WITH A CASTOR OIL OR ESTER BASE.
 2. DO NOT OVER-LUBRICATE PEDESTAL CONTROLS.
 3. DO NOT APPLY LUBRICANT TO RUBBER PARTS.
 4. UNDER NO CIRCUMSTANCES SHOULD THE CABLES FROM THE COCKPIT TO THE REAR OF THE FUSELAGE BE LUBRICATED AS THIS MAY CAUSE SLIPPAGE.
 5. REMOVE ALL EXCESS GREASE FROM GREASE FITTINGS.

SECTION II
DESIGN INFORMATION

Engine and Propeller	6
Fuel Injection	7 ⁵
Fuselage and Wing Structures	9 ⁸
Landing Gear	10
Hydraulic System	12
Control System and Surfaces	14
Fuel System	15
Electrical System	19
Finish	22
Instrument Panel	23
Radio Equipment	25
Seats	25
Baggage Compartments	26
Cabin Features	26
Heating and Ventilating System	26