



Quality Management in the Bosch Group

# 14. Failure Mode and Effects Analysis

## **FMEA**



**BOSCH**

Invented for life



## Table of contents

<b>1.</b>	<b>Introduction</b>	<b>3</b>
1.1.	Aims	3
1.2.	History	3
1.3.	Benefits	3
1.4.	Success factors	4
1.5.	Legal aspects of the FMEA	5
<b>2.</b>	<b>Basics</b>	<b>6</b>
2.1.	Product FMEA	6
2.2.	Process FMEA	6
2.3.	Trigger and timing of the FMEA	6
2.4.	FMEA team	7
2.5.	FMEA work plan	8
2.6.	Systematic preparation	9
2.6.1.	Definition of tasks	9
2.6.2.	Preparation for an FMEA meeting	11
2.6.3.	Special Characteristics	12
2.6.4.	Prioritizing the scope of observation	12
2.7.	Cooperation with externals	12
2.7.1.	Joint FMEA with customers	13
2.7.2.	FMEA presentation to the customer	13
2.7.3.	Cooperation with suppliers	13
2.7.4.	Cooperation with external service providers	14
<b>3.</b>	<b>Creation and actualization of an FMEA</b>	<b>15</b>
3.1.	Structural analysis	15
3.1.1.	Structure of the Product FMEA	15
3.1.2.	Structure of the Process FMEA	16
3.2.	Functional analysis	18
3.2.1.	Requirements	18
3.2.2.	Functions	19
3.2.3.	Function net	22
3.3.	Failure analysis	25
3.3.1.	Failures/malfunctions	25
3.3.2.	Failure effects and failure modes	27
3.4.	Action analysis	29
3.4.1.	Severity (S)	29
3.4.2.	Probability of occurrence (O)	29
3.4.3.	Probability of detection (D)	29
3.4.4.	Risk evaluation	33



## Failure Mode and Effects Analysis (FMEA)

3.5.	Optimization	34
3.5.1.	Criteria for the determination of actions	34
3.5.2.	Selection of actions	34
3.5.3.	Decision on actions to be implemented	35
3.6.	Documentation and release	35
<b>4.</b>	<b>Special Applications</b>	<b>36</b>
4.1.	FMEA for customer operation	36
4.2.	Product FMEA and diagnosis	36
4.3.	FMEA and DRBFM	36
<b>5.</b>	<b>FMEA software</b>	<b>38</b>
<b>6.</b>	<b>References</b>	<b>39</b>
<b>7.</b>	<b>Appendix</b>	<b>40</b>

2020-04-06 - SOCCS



## 1. Introduction

### 1.1. Aims

The FMEA (Failure Mode and Effects Analysis) is an analytical method of preventive quality management in product and process development.

It is used to identify and evaluate risks in good time, and to propose and implement suitable actions with the aim of improving products or processes and avoiding failure costs (recalls, yield).

The FMEA is applied in the knowledge that systematic analyses of potential failures and their documentation help to avoid failures [7]. The early and therefore preventive application of the FMEA helps to bring flawless products onto the market, thereby contributing to the safeguarding of corporate success in the long term.

The FMEA is an internationally recognized method of qualitative risk analysis [1], [2], [6]. At Bosch, it is enshrined in the product engineering process, and is used for the optimization of products and processes. Risk analysis requirements are described in ISO 9001 and ISO/TS 16949 [15], among others.

This document describes the Failure Mode and Effects Analysis (FMEA) as a method of quality management for risk analysis.

The objective is to provide a description of the methodology and a guide for the uniform procedure of FMEA creation at Bosch [3], which takes various customer requirements concerning FMEA creation (incl. DIN EN 60812, VDA Volume 4 [2] or AIAG [1]) into consideration to a large extent.

### 1.2. History

The history of the development of the FMEA goes back over 60 years. The following milestones are important for the method:

- 1949 First description of the method for the US military (MIL-P-1629)
- 1955 Widespread use of the "Analysis of Potential Problems (APP)" by Kepner/Tregoe
- 1963 Development and use by NASA (Apollo project)
- 1965 Widespread use in the aviation and aerospace technology, food industry, nuclear technology
- 1977 Beginning of its use in the automotive industry
- 1980 Standardization in Germany (DIN 25448)
- 1986 Standardization for German car manufacturers and parts suppliers (VDA Volume 4)
- 1993 Harmonization of FMEA guidelines of Chrysler, Ford and GM ("FMEA Reference Manual") and publication of US standard SAEJ1739
- 1996 Description of an improved methodology by VDA
- 2001 International standardization (IEC 60812)
- 2006 3rd edition of VDA Volume 4, "Product and Process FMEA"
- 2008 4th edition of "FMEA Reference Manual" (AIAG)

### 1.3. Benefits

The FMEA is a method of analyzing risks posed by individual failures (see also Chapter 3.3). In this process, the individual risks are prioritized so that focal points can be identified and suitable failure prevention actions determined.



## Failure Mode and Effects Analysis (FMEA)

The FMEA must be created alongside development/production planning as early as possible, to attain the greatest benefits. It is vital that the results can be incorporated in the product engineering process, so that unnecessary repeats and delays can be avoided.

The FMEA is created by an interdisciplinary team working together.

Advantages of the FMEA are, for example:

- Possible failures in products and processes are avoided.
- The functional safety and reliability of products and processes is increased [7] [16].
- It assists the achievement of a robust design and stable, capable processes.
- Subsequent product modifications are minimized and thereby costs reduced.
- Internal and external failure costs are reduced.
- Exoneration provided in claims for product liability.
- Disturbances at the SOP are avoided.
- Communication in the customer/supplier chain is optimized.
- A knowledge base is built up in the company.
- Coordination of information among those involved in the project from all areas (product and process experts, including responsible management) at an early stage.
- Involved parties gain improved understanding of the system.

In the application of the FMEA, the limits of the method must be borne in mind:

- The FMEA is a method for analyzing individual failures (not an examination of failure combinations).
- The FMEA is a qualitative, not a quantitative method. The results of the risk evaluation should be regarded as relative estimates, not as an absolute measure. For this reason, evaluations from different FMEA cannot be compared with one another.
- Quantitative statements on the failure behavior of products cannot be made.

Instead, the Fault Tree Analysis (FTA) [6] is suitable for investigating failure combinations and making quantitative statements on the failure behavior of products.

### 1.4. Success factors

The following success factors are critical for the quality of the FMEA:

- Definition of aim and scope of the FMEA (contracting),
- Team size and composition,
- Good team spirit,
- FMEA resources (personnel, infrastructure) must be available and included in project – planning,
- Knowledge of the FMEA method,
- Qualified moderator,
- Performance alongside development, so that findings and improvements can be put to use at an early stage,
- Project-neutral moderators.



## Failure Mode and Effects Analysis (FMEA)

A prerequisite for an effective FMEA is the existence of:

- Complete requirements and functions,
- A system concept and its suitable partitioning according to PE-objectives into components, assemblies and design elements.

The Management is responsible for providing the necessary resources in order that the FMEA can be performed successfully and in good time. During creation of the FMEA, the Management lends active support by attending meetings and reviewing the results.

### 1.5. Legal aspects of the FMEA

The competent performance of an FMEA and the proper implementation of its results are among the duties to ensure road safety of every manufacturer of products for the automotive industry. The violation of this duty to ensure road safety can result in civil liability (in cases of product liability) on the part of the manufacturer and, in the event of personal fault, claims of criminal liability (in cases of physical injury/death resulting from negligence) against the responsible associates.

Every Bosch product requires an FMEA that also sets out the specific risks. The analysis must take into consideration the product's operating conditions during its useful life, particularly in respect of safety risks and anticipated misuse. When reference is made to an existing FMEA during the release of a new product or changes to a product/process, this must be documented in writing such that it can be traced.

When an FMEA is performed, the following must be observed from a legal point of view:

The FMEA must be:

- **Clear**, i.e. the description of possible failures, of actions evaluated as reasonable and of persons responsible for performing these actions must be completely free from possible misunderstanding. Here, technically precise wording must be used, enabling a specialist to assess failures and possible consequences. "Elastic" or emotionally laden terms (dangerous, intolerable, irresponsible, etc.) must absolutely be avoided.
- **True**, i.e. possible failures must not be downplayed, even if the consequences may sometimes be disagreeable (re-development, delivery backlog, etc.).
- **Complete**, i.e. detected possible failures must not be concealed. Concern about revealing too much know-how by creating a correct and competent FMEA must not lead to any restricted representation. Completeness refers to the entirety of the product/process under analysis (system elements and functions); the depth of detail depends on the risk involved. C/MSA Central Directive R05 [4] must be observed in respect of passing FMEA on to customers.

All failure possibilities addressed in the FMEA must be dealt with, i.e. it is necessary to document in a traceable manner either that actions to reduce the risk are not being implemented, or which actions have been performed when and by whom.

New technical developments, new requirements or the introduction of new products may mean that an FMEA has to be performed again, even though changes have not been made to the actual product in question.

For details, see [14] Legal aspects of the FMEA.



## 2. Basics

In the application of the FMEA, it is distinguished between the Product FMEA and the Process FMEA.

Product and Process FMEA cover all terms appertaining to the FMEA, such as system, interface, design, production, assembly, logistics and machine FMEA, for example.

The FMEA may also be universally used for non-technical processes.

### 2.1. Product FMEA

The Product FMEA analyzes the design of products, product parts and their interfaces in terms of their quality throughout the entire lifecycle of the product (production, start-up, use, maintenance, right up to disposal).

### 2.2. Process FMEA

The Process FMEA analyzes the design of processes in terms of quality, from incoming goods to delivery to the customer.

### 2.3. Trigger and timing of the FMEA

The FMEA covers:

- a) For a new FMEA, the complete product and/or the entire manufacturing process.
- b) For variants or modifications, the part of the product and/or production process affected by the variants or modifications. With regard to the unmodified part, reference will be made to an existing FMEA, whereby interactions must be taken into consideration.

The FMEA is created by the team **as early as possible**. The FMEA must be carried out alongside the product and process development project. The performance of the FMEA will be set out in project time schedules.

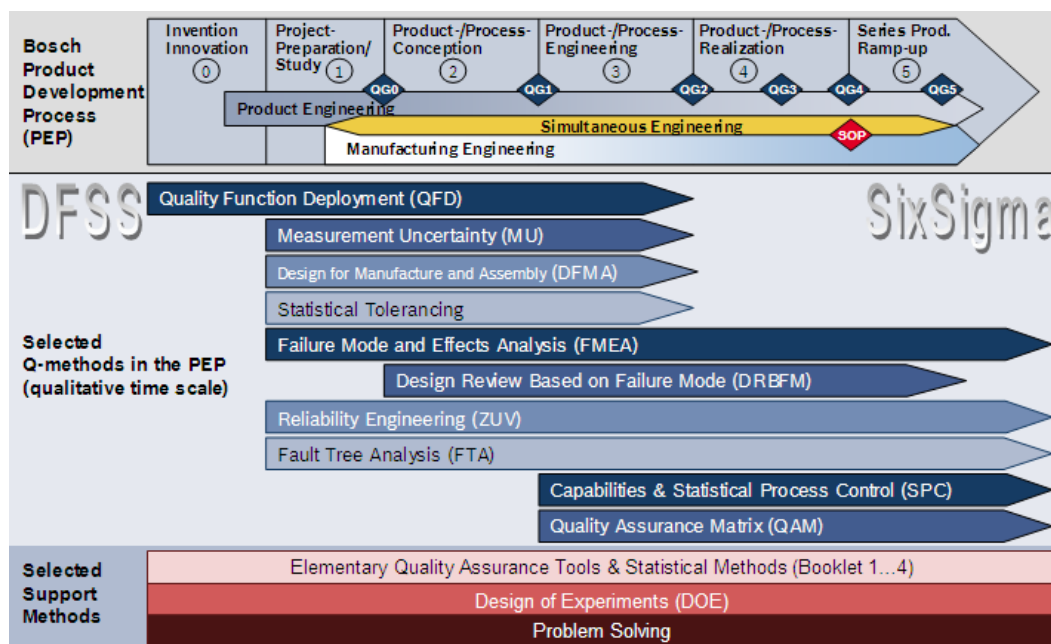

**Figure 1:** Incorporation of the FMEA in the product engineering process

The status of the FMEA procedure will be checked and evaluated in quality gates.



## Failure Mode and Effects Analysis (FMEA)

FMEA must be updated until the product is discontinued if one of the following points applies:

- Changed requirements or modifications to products or processes,
- Changes to the operating conditions,
- Requirements changed by law or by the customer,
- Plant, 0 mileage or field experience (e.g. internal/external complaints),
- Changes to the hazard analysis (ISO 26262).

Following the update, a new FMEA release must be created and approved.

### 2.4. FMEA team

Interdisciplinary task forces, comprising specialists from the responsible functional units, create the FMEA with the assistance of a specialist in the methodology (moderator). To ensure efficiency, a core team with 3 to 5 members is established, to ensure a coordinated and harmonized FMEA procedure. The members of the core team come from various functional units (see Figure 2). Further experts may be involved if necessary. The use of a moderator ensures systematic and efficient working.

The Project Manager is responsible for selecting the right participants. Knowledge of the FMEA method is vital for working in the team.

Some advantages of interdisciplinary task forces are, e.g.:

- The knowledge and experience of associates from different specialist units is put to use.
- The acceptance and quality of the created FMEA is increased.
- Cross-divisional communication and cooperation is encouraged.

As a rule, participants from the following units are involved (sometimes temporarily):

Product FMEA	Process FMEA
Development	Production Planning
Application	Production Execution
Quality	Logistics
Service	System Planning
Sales	Quality
Production	Development
Purchasing	Purchasing
Testing	

**Figure 2:** Possible team members





## 2.5. FMEA work plan

The table below shows the individual work steps of the FMEA, with the tasks of the various parties.

	Input	Activity	Output
<pre> graph TD     Start((Start)) --&gt; S0[Step 0: FMEA preparation]     S0 --&gt; S1[Step 1: Structural analysis]     S1 --&gt; S2[Step 2: Functional analysis]     S2 --&gt; S3[Step 3: Failure analysis]     S3 --&gt; S4[Step 4: Action analysis]     S4 --&gt; S5[Step 5: Optimization]     S5 --&gt; D1{Implement proposed measures?}     D1 -- No --&gt; S5     D1 -- Yes --&gt; U1[Update measure status in the FMEA]     U1 --&gt; D2{Remaining risk accepted?}     D2 -- No --&gt; S5     D2 -- Yes --&gt; D3[Document and approve FMEA release]     D3 --&gt; End((End))         </pre>	Customer specifications, external (legal) and internal specifications; work documents Rationale for FMEA application, technical circumstances, existing FMEA	Contracting, define FMEA team; define technical scope Clarify customer requirements Check existing FMEA, adopt relevant content	Scope, objectives, schedule, team, coordinated customer requirements, confirmed FMEA test result
	Concepts, drafts, models, requirements, functions	Define design principle, develop product structure / process structure	Product structure / process structure (also higher-level system as far as vehicle level)
	Quantified requirements and functions of the next-higher system element, product structure	Describe functions and characteristics of system elements taking into account interactions and link in the functional network	Functional relationships (functional network) with detailed descriptions of functions / product characteristics / process characteristics
	Functional relationships (functional network) with detailed descriptions of functions / product or process characteristics, lessons learned	Describe detailed, where appropriate quantified, malfunctions based on the functions and under consideration of the operating and environmental conditions, link failure network based on functional network	Potential failures, failure causes, and failure effects, Cause-effect relationships (failure network)
	Malfunctions / failure network, knowledge of comparable products, if available	Describe and evaluate measures to prevent and identify failures (actual status)	Risk assessment of the current development phase, measures (actual status)
	Risk assessment of the current development phase, measures (actual status)	Sort risks, identify improvement measures, if necessary effect on steps 1 - 4, evaluate remaining risk,	Further improvement measures, anticipated reduced risk
	Further improvement measures, anticipated reduced risk, information on costs, time, and strategy	Decision on whether the proposed measures should be implemented	Decision on which of the proposed measures are to be implemented
	Decision on which of the proposed measures are to be implemented	Update FMEA with the implemented and rejected measures	Updated FMEA status
	Updated FMEA status	Decision on whether the remaining risk is accepted	FMEA release ready to be signed
	FMEA release ready to be signed	Document and approve FMEA release, e.g. as part of an FMEA review	Approved FMEA release

To ensure an efficient FMEA procedure, the first steps (0 – 2) may be prepared by a reduced team. The steps of the FMEA are not dealt with purely in sequential order for all system elements; they may overlap in the context of simultaneous engineering. All five steps are dealt with for prioritized topics, resulting in an iterative procedure.



## 2.6. Systematic preparation

This section defines preparatory tasks and responsibilities, which are necessary in order to ensure the successful performance of an FMEA in accordance with the work plan (section 2.5).

### 2.6.1. Definition of tasks

	GB FMEA Coordinator	Business Area FMEA Coordinator (if defined)	FMEA Moderator	Sales	Project/Subproject Manager or Product/Process responsible	Purchasing	Team contact person	FMEA team	Head of Department	Plant/BU Management
FMEA planning in project schedule (initial draft and update)		I	I	S	R	S			A	
Contracting of FMEA Moderator and client contact person		I	C	S	R	S	C		A	
FMEA planning with customers		I	S	R	C		C		A	I
FMEA planning with suppliers		I	S		C	R	S		A	I
Appointment of FMEA team			C		R		C	I	C	
Coordination of project-specific customer requirements for FMEA	S	S	C	C	R		I	I		
Preparation of technical requirements (customer specification, performance specification, Special Characteristics)			I	C	R		C	I		
Examination of contents used from existing FMEA			C		R			S	A	
Provision of necessary documents and samples			I	S	C	S	R	S		
Coordination of schedule and invitation to FMEA meetings			C	S	I	S	R	S		

**Figure 3:** Assignment of tasks to responsibilities

Systematic preparation considerably reduces the time spent on FMEA creation. During the planning phase, FMEA-specific requirements (internal or from the customer), such as evaluation criteria or presentation deadlines, must be taken into consideration.



## Failure Mode and Effects Analysis (FMEA)

The performance of an FMEA must be agreed between the client and the FMEA Moderator. This may be accomplished by means of a contracting list, for example (see Appendix 3).

The use of other methods (e.g. DRBFM, FTA) should also be discussed. Interfaces between the methods must be defined. The incorporation of DRBFM results must be clarified in advance

In the Product FMEA, the scope of analysis can be presented in the form of a block diagram or a 3D model. Here, the boundaries of analysis and the interfaces are identified and established (see Figure 4). In the Process FMEA (see Figure 5), a process flow chart may be used, for example.

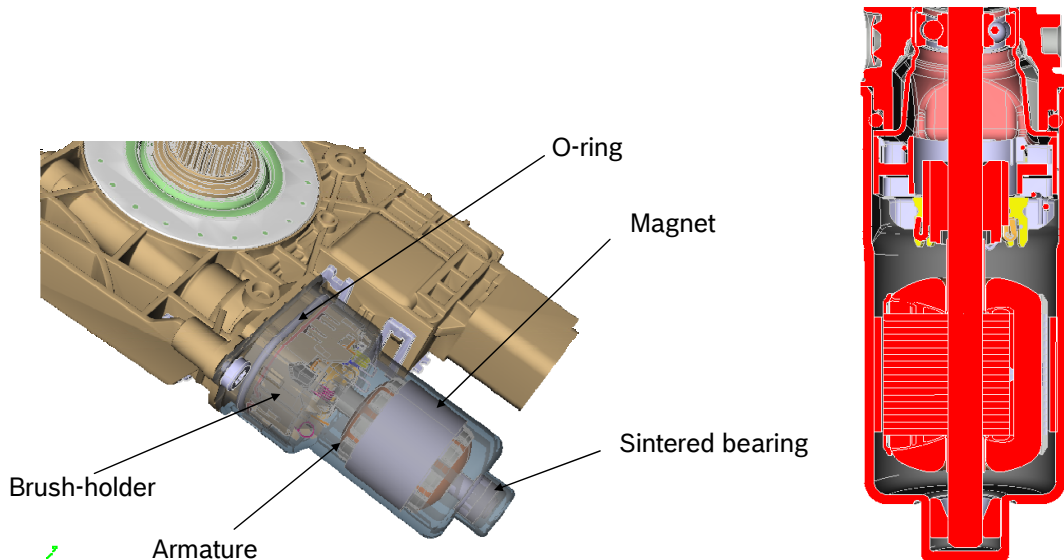

Figure 4: Example 3D models

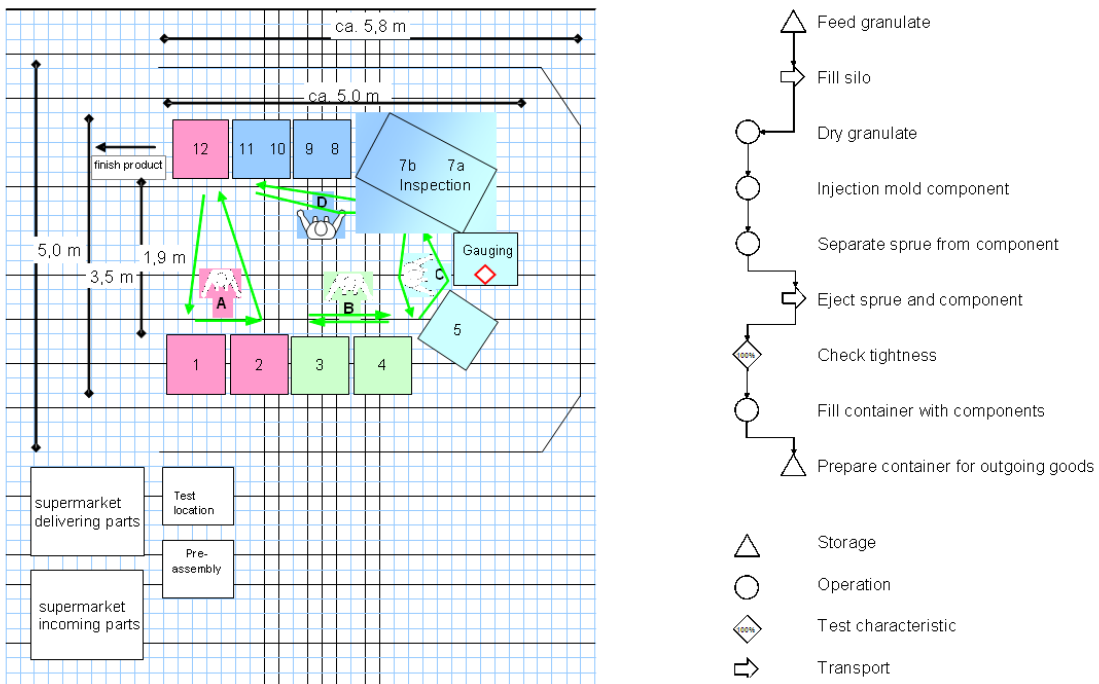

Figure 5: Example of a process layout and flow chart



### 2.6.2. Preparation for an FMEA meeting

During FMEA preparation, all technical requirements for the product, process or scope in question must be checked in detail. These requirements must be available in complete, unambiguous and quantified form. Requirement engineering methods, such as QFD (Quality Function Deployment), for example, are used to document the requirements and product functions. In addition, the use of international and national standards and guidelines, e.g. "Cleanliness of components and installation" as per VDA 19/1 and /2 and ISO16232 (see Appendix 5, best practice example) must be ensured.

To reduce time and expenditure, the following documents (if available) should be procured before the FMEA meetings and used during the FMEA. Unresolved items must be clarified by the Project Manager.

#### Product FMEA:

- Requirements documentation, e.g. customer specification, performance specification, technical customer documentation (TCU), offer drawing, results from QFD, DFMA (Design for Manufacturing and Assembly), engineering change requests,
- Functional description,
- Structure (e.g. block diagram),
- Parts lists and drawings,
- Existing FMEA (comparable products/processes, etc.),
- Project schedule,
- Agreed S evaluation criteria (e.g. from customer),
- "Special Characteristics" defined by the customer,
- Design verification plan (test sheet),
- Failure statistics,
- Internal failure rates, 0 mileage and field failure statistics from comparable products,
- Samples and 3D models,
- Test results.

#### Process FMEA:

- Product FMEA,
- Work plan/control plan,
- Parts lists and production drawings,
- Prepared structure and functional analysis (steps 1 and 2),
- Existing FMEA (comparable processes, etc.),
- Project schedule,
- Manufacturing instructions,
- Machine and process capability data,
- Process trial results,
- Samples,
- Technical customer documents (TCU),
- Internal failure rates, 0 mileage and field failure statistics from comparable products,
- DFMA.



### 2.6.3. Special Characteristics

Special Characteristics are product characteristics or production process parameters, which may have an effect on safety or compliance with legal provisions, for example, on the fit, the function, the performance or further processing of the product.

Bosch divides these into three categories:

- “S” Safety requirement/product safety/safety-relevant consequences.
- “G” Legal, statutory and official requirements in place at the time the product was launched.  
These include issues relevant to approval and certification.
- “F” Further important functions and features (fit, form, function).

#### Notes

- Special Characteristics are determined and identified in accordance with Central Directive [5].
- Special Characteristics must be documented in the FMEA through the identification of the relevant functions/characteristics.

### 2.6.4. Prioritizing the scope of observation

The order of processing and the depth of analysis can be managed by means of prioritization. This prioritization can take place on the basis of components or functions. A complete risk analysis (steps 1 – 5) is performed for prioritized scopes, then the remaining scopes are analyzed (iterative procedure).

Prioritization of the FMEA can be achieved by means of a focus area analysis based on the criteria “New development” and “Not fully understood cause-effect relationships”.

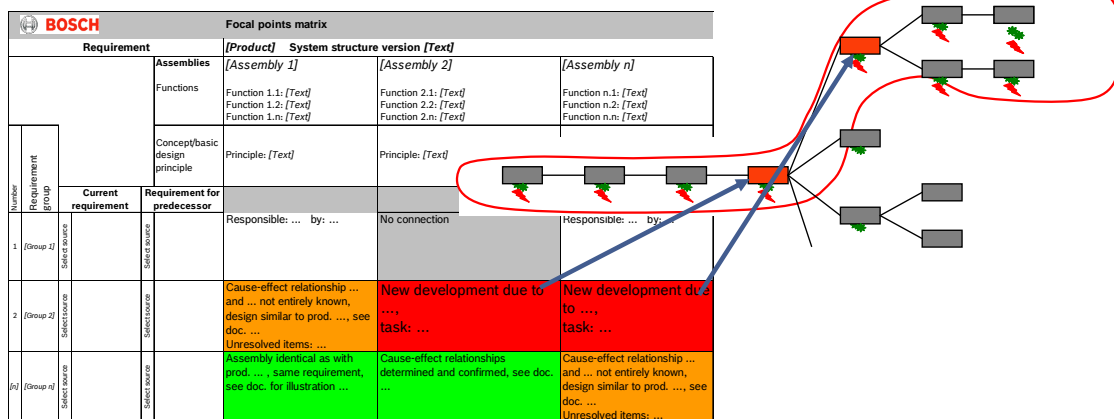

Figure 6: Prioritizing the scope of observation

### 2.7. Cooperation with externals

In the automotive sector, requests to view or hand-over an FMEA or to create an FMEA jointly are subject to the C/MSA Central Directive R05 “Customer Communication of FMEA/FTA/FMEDA/DRBFM/Control Plan/QAM/ISO26262 Safety Case” [4] and the Bosch Directive “Transmission of Classified Information to External Parties” [11].



### 2.7.1. Joint FMEA with customers

A Product FMEA created jointly with a customer investigates the interaction of input and output functions between Bosch and customer components to ensure correct overall function [8].

The FMEA team may be led by FMEA moderators from Bosch or from the customer. Endeavors must be made to ensure good preparation and structuring of FMEA to be created jointly. First of all, jointly recognized rating tables and Special Characteristics [5] must be agreed.

Creation of a Product FMEA (system and/or interfaces) together with a customer must be approved by the responsible manager [4].

#### Product FMEA: Extracts from the customer

If no jointly created Product FMEA (system and/or interfaces) exists, Sales obtains extracts from the customer's FMEA in good time and forwards them to the persons responsible for the component/product. If the customer has no FMEA, it makes sense to harmonize Bosch's own drafts with the customer [8].

### 2.7.2. FMEA presentation to the customer

FMEA presentations to customers are organized by Sales. The presentation is carried out by the responsible department. In the case of a Product FMEA, this is usually the task of Development; with a Process FMEA, Production Preparation. Quality management must be incorporated in the flow of information.

When presenting an FMEA for the first time, the general Bosch procedure for FMEA creation, and the rating tables used, should be explained. Special Characteristics [5] can be determined and identified at the customer's request.

Updates or minor changes since the first presentation can be explained to the customer by the Project Manager or Sales, e.g. within the framework of general development discussions.

The FMEA evaluations (e.g. differential analysis, frequency analysis) can be handed to the customer upon request, under consideration of Central Directive R05.

### 2.7.3. Cooperation with suppliers

Bosch Directive "Purchasing" [13] forms the basis for cooperation with suppliers. Our suppliers are under obligation to adhere strictly to the agreed product quality. The application of the principle "failure prevention not failure detection", and the use of an effective quality management system by suppliers, form the basis of our business cooperation [9].

To guarantee the quality of supplied parts, Bosch demands that its suppliers create and present FMEA, among other things [9]. Suppliers can be given extracts from the Bosch FMEA relevant to them for this purpose, as this will ensure consistency, particularly of information on the failure effect chain and the evaluation of the Product FMEA and Process FMEA. If extracts from Bosch FMEA handed over in this way are subject to 'protection of expertise', a nondisclosure/reservation of rights agreement must be concluded with the supplier [4].

The rating tables and the procedure for Special Characteristics [5] must be agreed with the supplier.

#### Procedure for the Product FMEA

After the supplier has created a draft, the Bosch Development department asks the supplier to permit Bosch associates (Development, Purchasing, Quality Management) to view the Product FMEA, and to discuss it with the supplier. The inspection and discussion of the Product FMEA machine is carried out by Bosch Production Planning or MAE Project Planning and MAE Purchasing together with the supplier



## Failure Mode and Effects Analysis (FMEA)

### Procedure for the Process FMEA

After the supplier has planned the production process, Bosch Purchasing asks the supplier to permit Bosch associates (Production, Quality Management, Purchasing) to view the Process FMEA and discuss it with the supplier.

#### Information on an FMEA provided by Bosch clients:

- Product, assembly and parts drawings and part numbers,
- Bosch specification and list of Special Characteristics,
- Information/instructions on the application-specific severity of failure effects and classification of these effects (possibly extracts from Bosch FMEA),
- Set deadline for FMEA creation and discussion.

#### Criteria for an FMEA discussion with the supplier:

- See example of an evaluation checklist in the Appendix.

### 2.7.4. Cooperation with external service providers

External service providers (FMEA moderators, translation agencies) are suppliers who have a direct or indirect effect on the quality of a product. Therefore, where external service providers are to be used, particular attention must be paid to their selection. The basis for this process is Bosch Directive "Decisions on In-House Sourcing from Outside Suppliers" [12] and Bosch Directive "Release of Classified Information to Third Parties" [11].

Decisions on in-house provision or contracting are, to a particular extent, decisive in terms of competition, and therefore determine our success. They have a major influence on the further development and protection of our expertise.

It is a fundamental rule that moderated FMEA discussions and translations may only be carried out by external service providers with whom the relevant confidentiality agreements have been concluded.

We recommend documenting translations in the same IQ-RM file as the original FMEA. Changes/updates can then be easily recognized and updated.



### 3. Creation and actualization of an FMEA

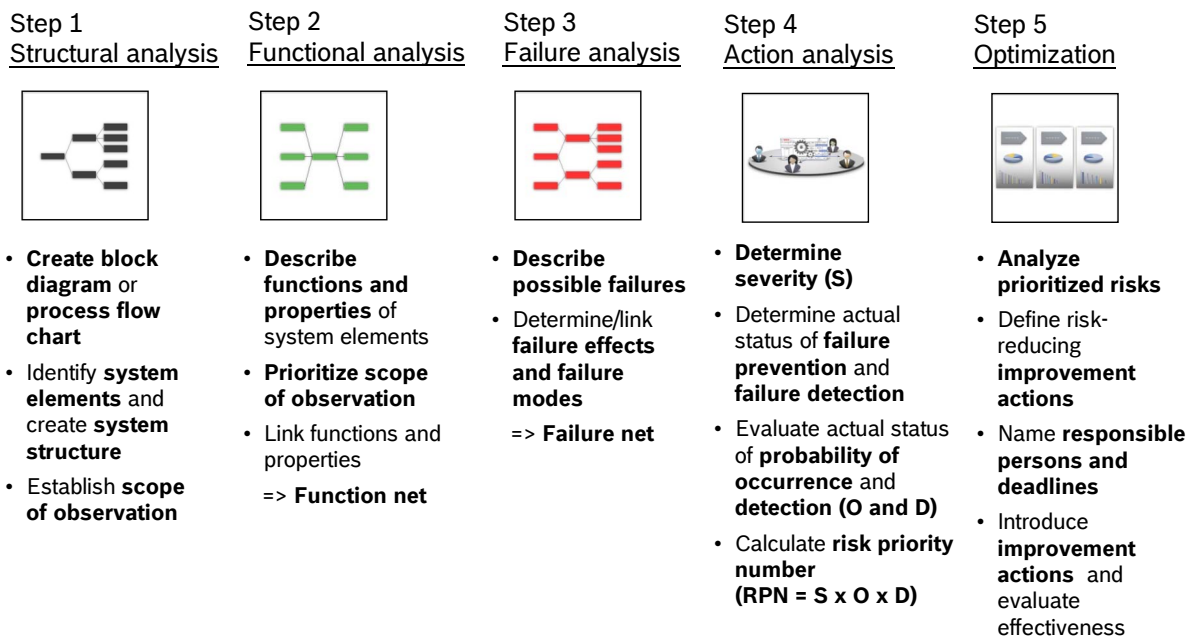

Figure 7: The 5 steps for creating an FMEA

#### 3.1. Structural analysis

The structural analysis is used to illustrate the constituents of the product or process, including system boundaries, clearly and completely.

The structure of a Product/Process FMEA is made up of individual system elements. These describe the structural dependencies in an overall system, and are presented in a tree structure. The first element of the tree structure is the uppermost level of the scope under analysis (product/process), on which the functions of the system in question and failure effects for customers are described and evaluated. The uppermost level is dependent upon the amount of knowledge the team has about the intended purpose of the product.

The details of the tree structure can vary, depending on the scope under analysis.

##### 3.1.1. Structure of the Product FMEA

Depending on the scope under observation, the system elements of a Product FMEA structure can consist of a system, subsystems, components, assemblies, right down to individual parts and their detailed design details. Complex structures may be split into several structures (work packages) and analyzed separately for organizational reasons or to ensure sufficient clarity.

Sources include:

- Quality Function Deployment,
- Block diagram of system/software,
- List of the scope of delivery,
- Parts lists.

Figure 7 shows a possible overall structure for a Product FMEA from a vehicle to the design details of the individual parts.





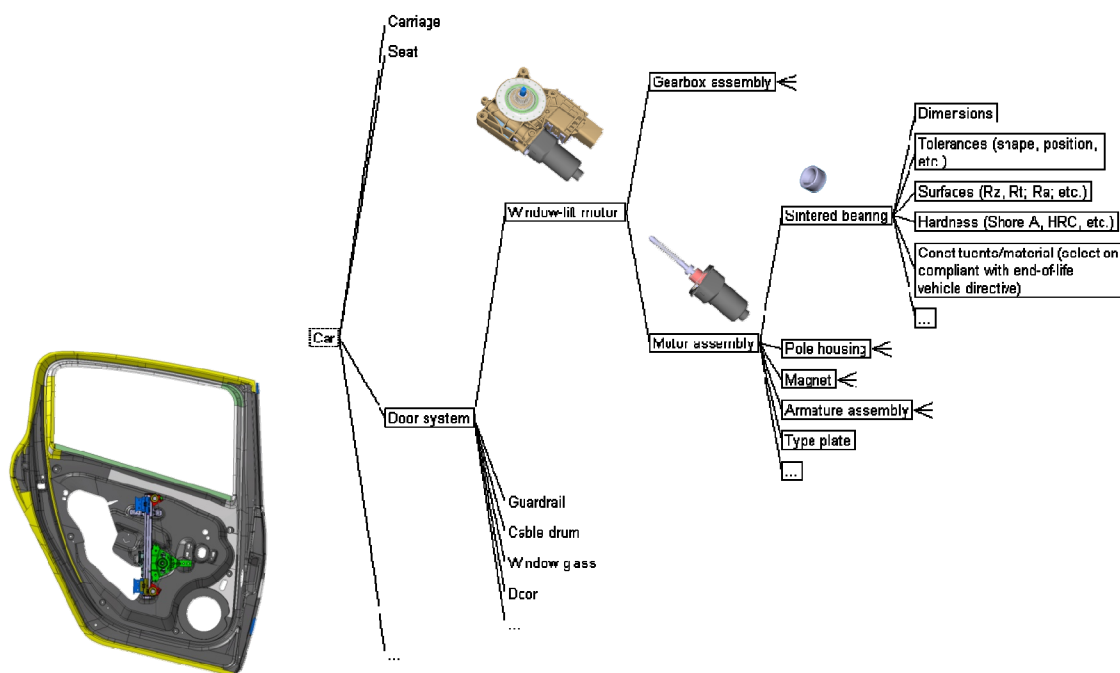

Figure 8: Overall structure for a Product FMEA

### 3.1.2. Structure of the Process FMEA

Depending on the scope under observation, the system elements of a Process FMEA structure can consist of the overall production process or individual process stations/sub-processes, and can be assigned to the lowest level of the 5M categories (Man, Machine, Method, Material, Milieu). Complex structures may be split into several structures (work packages) and analyzed separately for organizational reasons or to ensure sufficient clarity.

Reference documents include:

- Line layout diagram,
- Control plan (CP)/process flow chart,
- Material flow charts.

The process structure illustrates the process steps, e.g. the assembly stations according to the line layout. The Process FMEA is based on the Product FMEA, i.e. the information described in the Product FMEA at component level (functions, characteristics, failures, etc.) is linked to the product and process characteristics on the process level.

Figure 8 shows a possible overall structure for the Process FMEA.



# Failure Mode and Effects Analysis (FMEA)

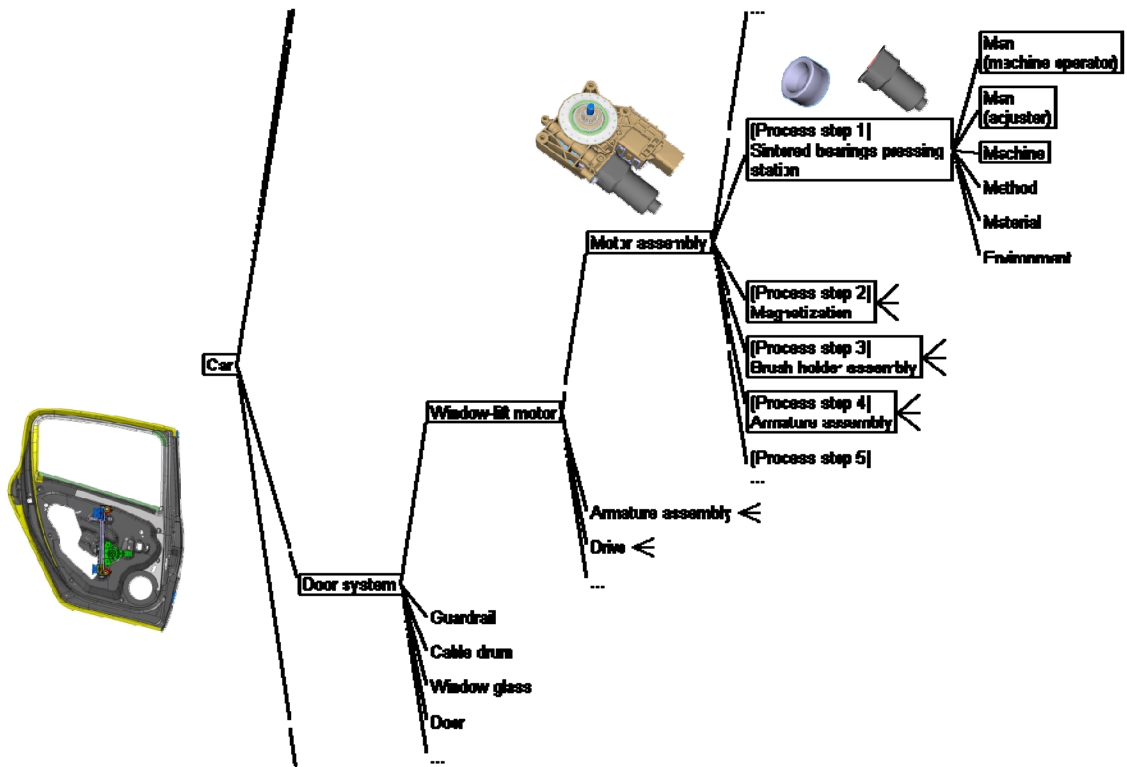

**Figure 9:** Overall structure for a Process FMEA

Figure 9 shows an example relationship between the different scopes of analysis of the Product and Process FMEA. The FMEA of the complete product/process can be dealt with in different work packages to reduce technical and organizational complexity. At the agreed interfaces between the individual areas of responsibility the contents have to be adjusted.

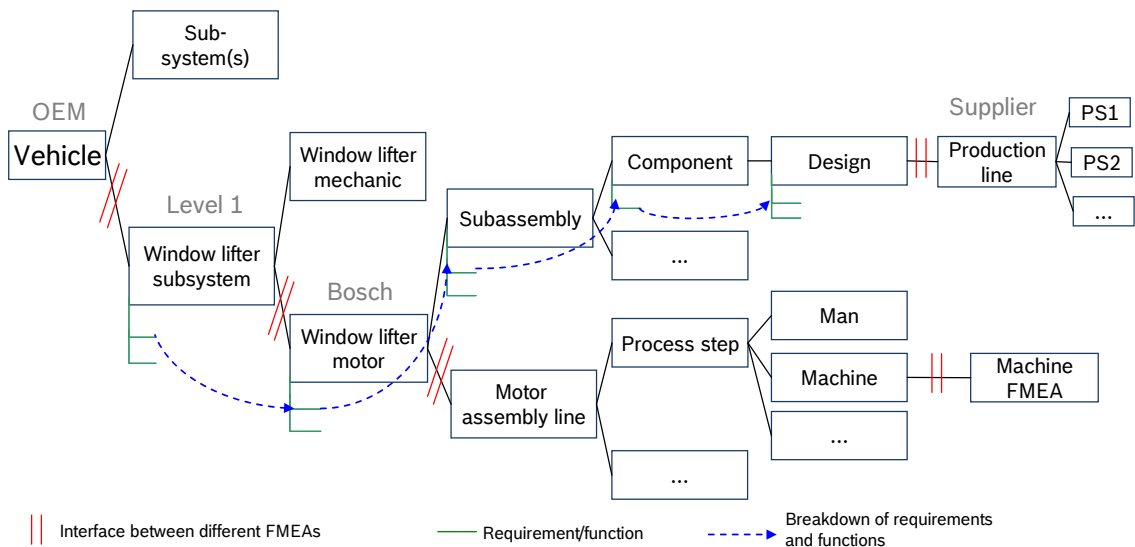

**Figure 10:** Example relationship between different FMEA and their interfaces



## 3.2. Functional analysis

In the second step of the FMEA, the functionality of the product/process is analyzed. A prerequisite for this step are requirements and a functional description, available in their entirety. In order to analyze functions under consideration of inputs and outputs, extensive knowledge of the system, the product or process and its ambient conditions, operating conditions and interactions with other system elements (e.g. temperature, dust, splash water, salt, ice, vibrations, electrical interference, acceleration influences, full load, part load) is required.

Linking the functions together to form a function net reveals functional dependencies. This is the basis for the subsequent failure analysis, and results in better understanding of the system among all involved parties.

### 3.2.1. Requirements

Requirements are demands or expectations that are presumed or binding. They comprise:

- Legal requirements,
- Standards,
- Customer agreements (e.g. QM, product),
- RB stipulations,
- Production-specific requirements.

Once requirements have been fully ascertained, the functions are derived from them. This takes place in requirement engineering (e.g. with QFD) and provides the necessary input for the functional analysis of the FMEA.

The requirements analysis has a different focus depending on whether it is a Product or a Process FMEA.

**Product FMEA:** Analysis of all implicit and explicit requirements (customer, law, Bosch) for the product, including precise specifications (e.g. tolerances) and information on intended ambient/operating conditions (e.g. temperature, pressure, humidity, incoming electromagnetic radiation).

**Process FMEA:** Analysis of all implicit and explicit requirements (customer, law, Bosch e.g. BPS) for the process, including information on expected process boundary conditions (e.g. clean room).



	Product-FMEA	Process-FMEA
Legal requirements	e.g. environmentally friendly product design, suitable for recycling, safe in the event of potential misuse by the operator, non-flammable	e.g. compliance with designated health & safety and environmental protection regulations
Customer requirements	Explicit (e.g. in customer specification) and implicit (e.g. freedom from prohibited materials) – under all specified ambient conditions	(as per customer specification), e.g. adherence to required quality, manufacture of product(s) in time x and quantity y (output z/hour)
Internal requirements	e.g. manufacturability, suitability for testing, compatibility with other existing products, reusability, cleanliness (generation, entry and spreading of particles)	e.g. manufacture of the product in process cycle, compliance with expected production costs (e.g. limited rejects, no corrective work), BPS principles, process quality and cleanliness instructions

**Figure 11:** Origin of product and process requirements

The requirements analysis is not a task of the FMEA. It is an input prerequisite for performance of the FMEA. As part of the FMEA, the existence and completeness of all requirements and functions is implicitly checked, and any unresolved items dealt with.

### 3.2.2. Functions

A system is described by its defining properties. These properties fall into two groups: Functional characteristics (functions) and non-functional characteristics (qualities). Characteristics have a significance (quality) and a degree (quantity).

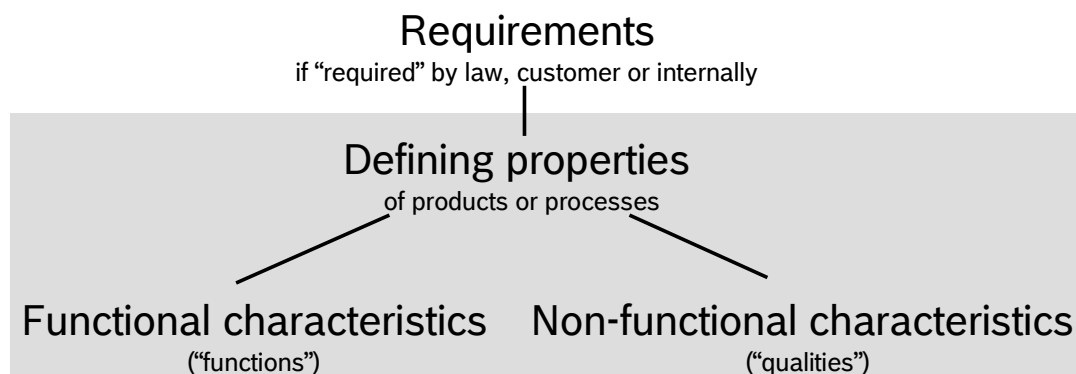

**Figure 12:** Characteristics of products and processes

Both functional and non-functional characteristics are analyzed in the FMEA.



## Failure Mode and Effects Analysis (FMEA)

Functions describe the relationship between the input and output of a system/element with the aim of fulfilling a task, Figure 13.

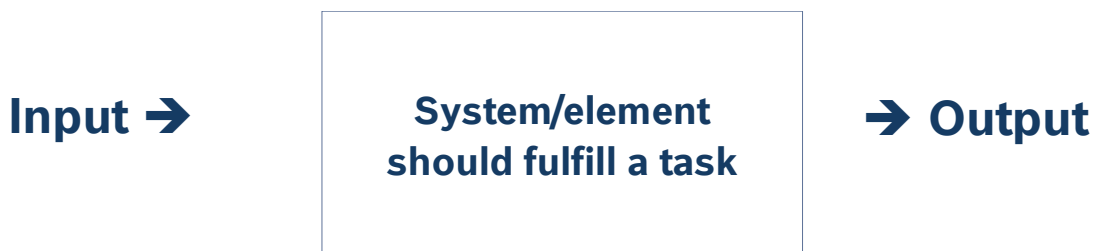

**Figure 13:** Functional description of a system

The functional analysis of the FMEA is created on the basis of the existing functional description. The functional model below serves as a basis for the FMEA:

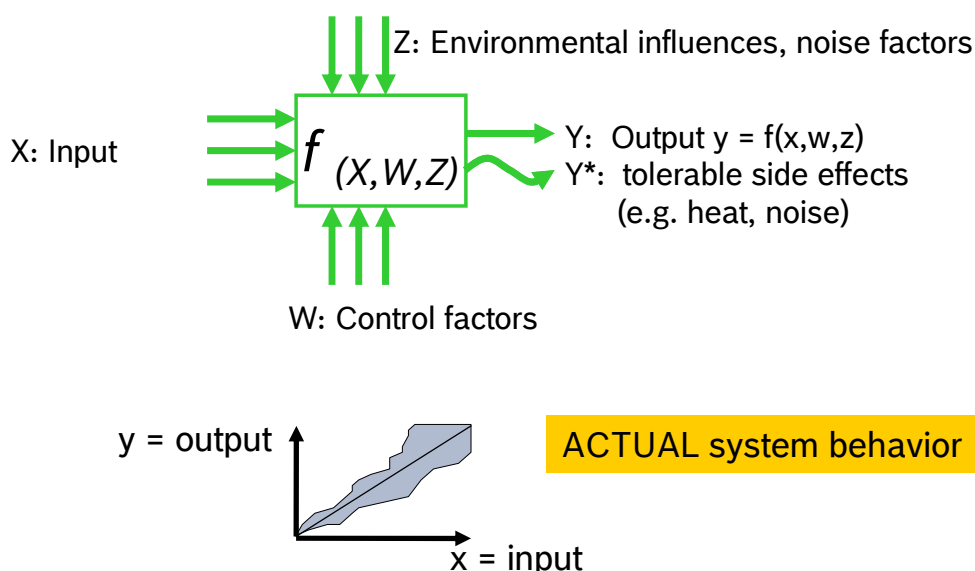

**Figure 14:** Functional model

Using this model, the individual functions with the necessary inputs and outputs can be represented and discussed. Control factors assigned to the functions are also presented. Particular attention must be paid to all noise factors, such as ambient conditions. These are the reason why, in reality, a function often deviates from the description. In addition to the desired output, undesirable side effects may occur, which must be taken into account in the analysis.

The Product FMEA covers all functions of considered system on the basis of the requirements, taking operating states and conditions into consideration.

The Process FMEA covers all functions of process steps/work operations on the basis of the process requirements, taking operating conditions into consideration.

The complete functional description forms the basis for subsequent failure analysis and action analysis.

Functions must be described with a noun, verb and quantification. The following pages contain further examples of complete functional descriptions.



## Failure Mode and Effects Analysis (FMEA)

Noun + verb in active form + quantified		Parameters that influence system behavior	Effects from the environment	Effects on
Output $Y=f(xwz)$	Input $x$	Control factor $w$	Noise factors $z$	Tolerable side effects $Y^*$

**Figure 15:** Parts of a complete functional description

In the following some examples of a complete functional description are given.

A water pump as an example:

**Y, x:** Pumps drinking water from the intake side to the pressure side (operating time 200 h) at a flow rate of 45 l/h to 100 l/h as per curve 4711 inside the tolerances

**w:** Depending on the switch setting of the pump

**z:** At ambient temperature 0°C/+85°C

**Y\*:** In compliance with noise limit values <40dB(A).

The corresponding functional model of the water pump can be described as follows.

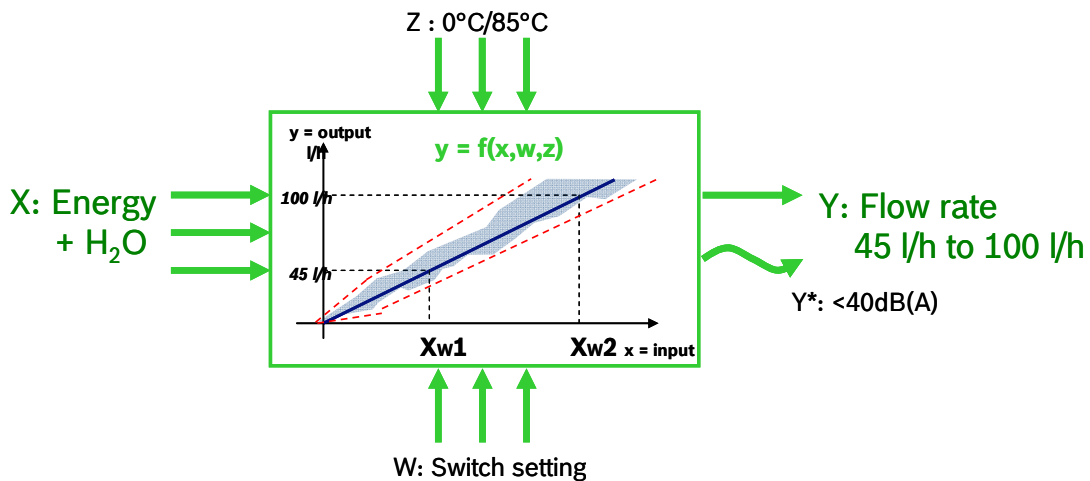

Pumps drinking water from the intake side to the pressure side (operating time 200 h) at a flow rate of 45 l/h to 100 l/h as per curve 4711 inside the tolerances, depending on the switch setting of the pump, at ambient temperature °C/+85°C in compliance with noise limit values <40dB(A).

**Figure 16:** Example functional description with ambient conditions

The example of a functional description of a window lift in a product FMEA can be found in the following Figure.



## Failure Mode and Effects Analysis (FMEA)

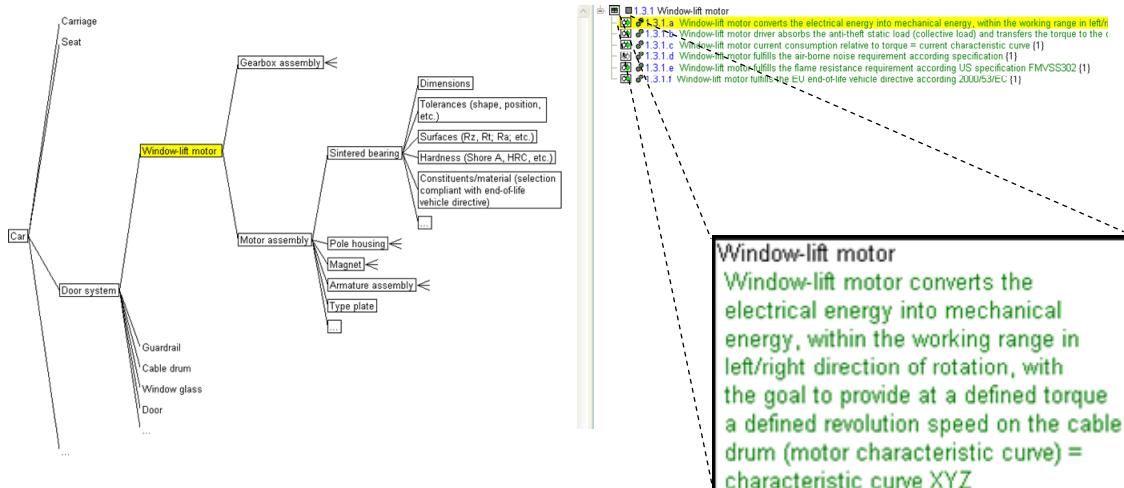

Figure 17: Example functional description for a Product FMEA

The example of a functional description of a pneumatic gripper in a process FMEA can be found in the following Figure.

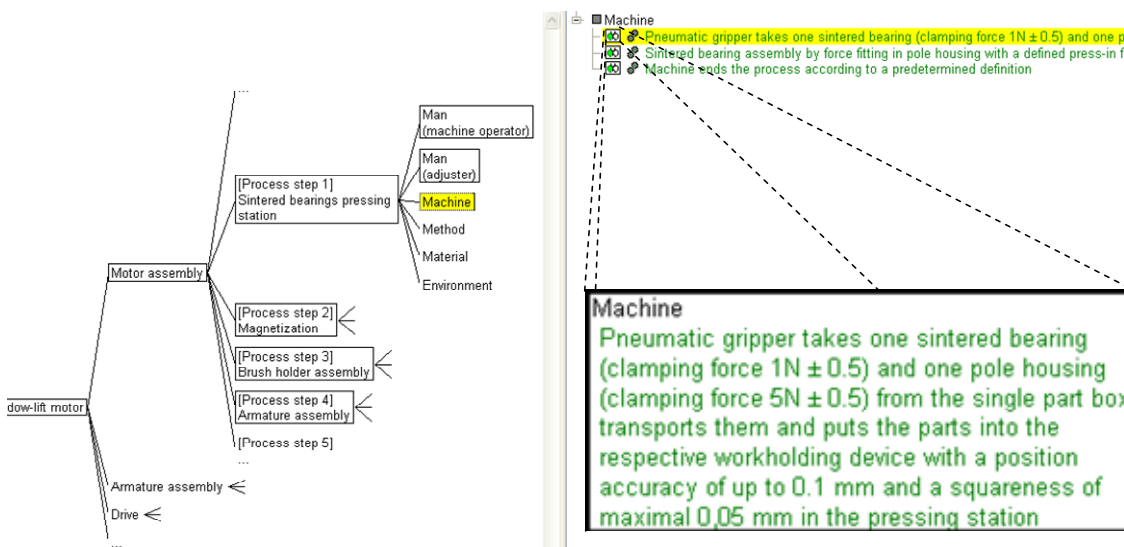

Figure 18: Example functional description for a Process FMEA

### 3.2.3. Function net

The interaction of system element functions is set out in the function net. Sub-functions that, in total, fulfill a higher-level function, are logically interlinked to create a function net (AND operation).

Functional dependencies (contributions to function, means to purpose relationship) are presented, not process flows.

The completeness of functions and the consistency of functional descriptions (e.g. input conditions) are checked and any unresolved items dealt with. The function net leads to better understanding of the system and assists with failure analysis.



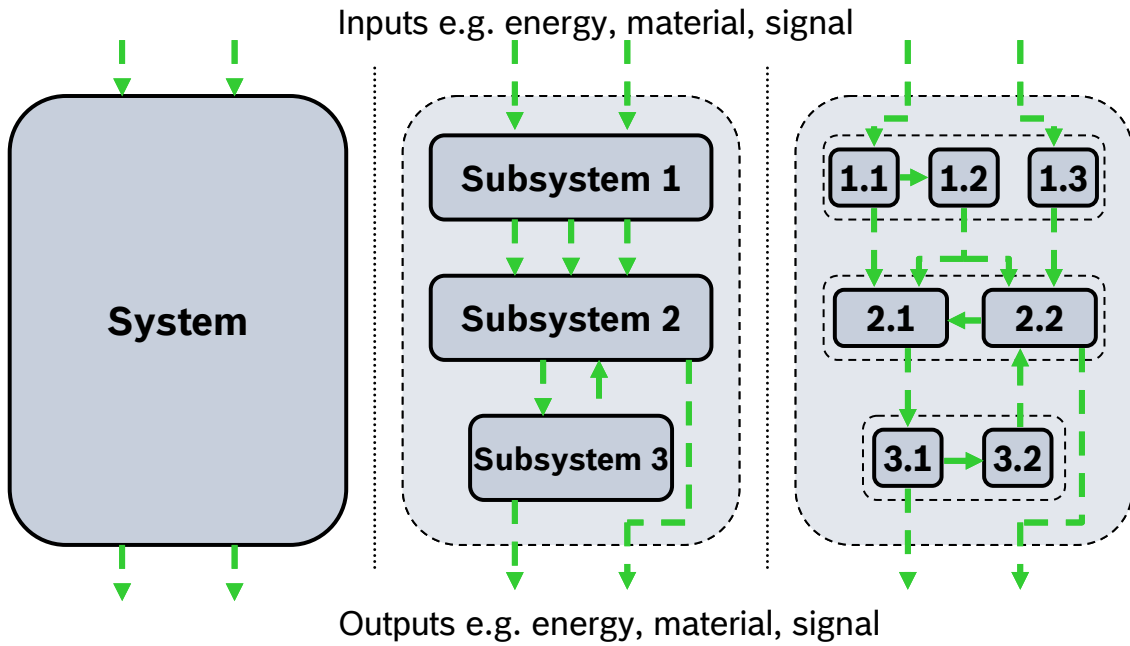

**Figure 19:** Presentation of the functional sequence

The relationship between several functions and input or output can be presented in a flow chart. This diagram can also be used to describe how the output conditions of a function can act as input conditions on another function.

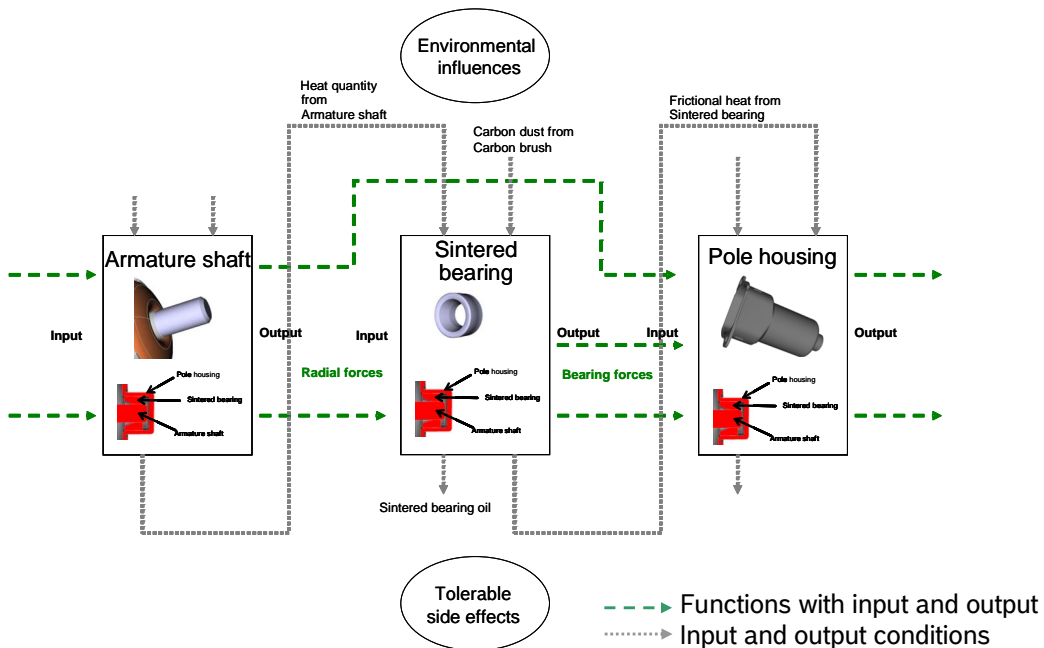

**Figure 20:** Example of energy flow in a component





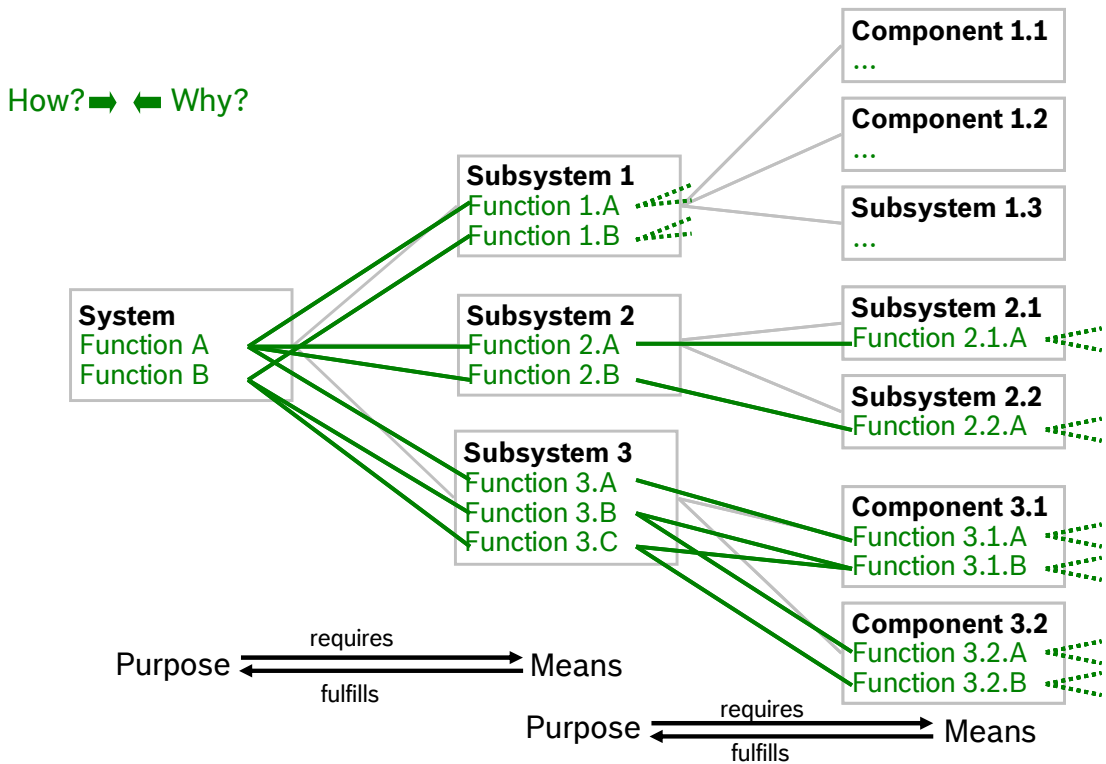

Figure 21: Means to purpose relationship in the function net

The function net in Figure 19 for the initial system function states that system function B can only be fulfilled if contributing subsystem functions 1.B, 3.B and 3.C are satisfied. Moreover, contributing subsystem function 3.B can only be fulfilled if contributing individual component functions 3.1.B and 3.2.A are satisfied.

See Figures 20 and 21 for example function nets for the Product and Process FMEA.

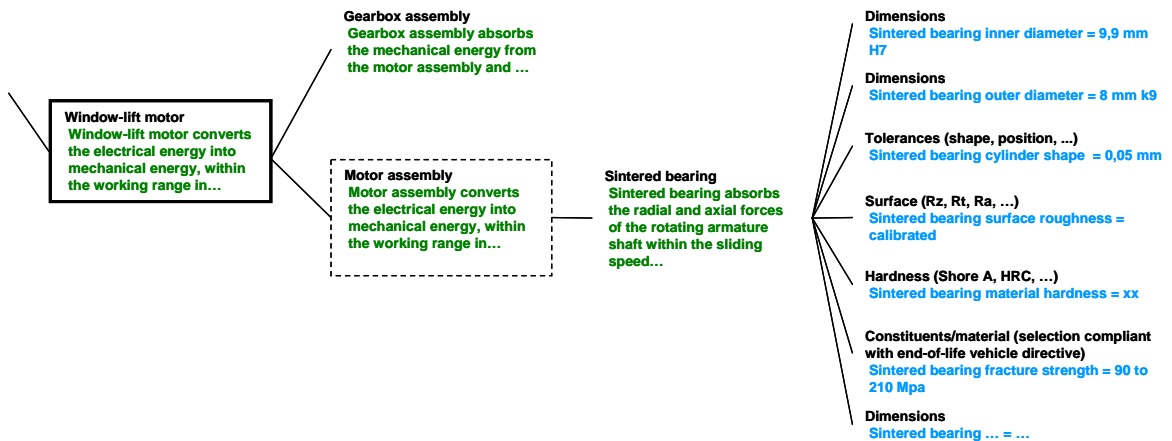

Figure 22: Function net for Product FMEA (extract)



## Failure Mode and Effects Analysis (FMEA)

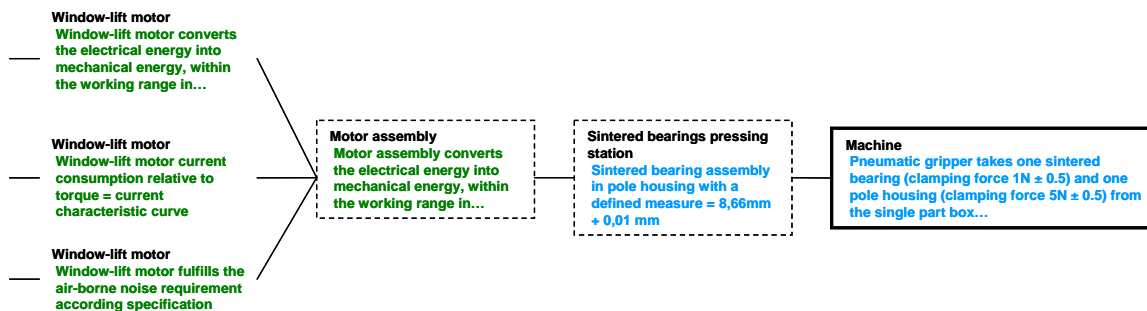

Figure 23: Function net for Process FMEA (extract)

### 3.3. Failure analysis

The failure analysis is used to ascertain possible failures. One or more failures are derived for each function determined in the scope of analysis.

Failures in the system under observation that constitute non-fulfillment of functions (malfunction) – or of output conditions that are also to be complied with – are investigated.

The following prerequisites must be fulfilled:

- Failures in the higher-level system are analyzed in the FMEA of the higher-level system.
- Input conditions from the higher-level system are taken as given.
- An input which is conform to the specification is assumed. Exceptions may be made if past findings exist concerning incorrect input.
- If failures are detected in the FMEA that were not analyzed on the higher level, these must be communicated to the higher level [1].
- Individual failures are considered. In contrast, multiple failures consider the logical combination of failures, which is not analyzing in a FMEA framework. Such analysis can be performed for instance by FTA.

#### 3.3.1. Failures/malfunctions

A malfunction describes the manner in which a function or characteristic cannot be fulfilled (deviation from a given function).

Like functions, the possible failures are described precisely (noun + verb + adjective/adverb), and quantified with concrete facts, figures and data.



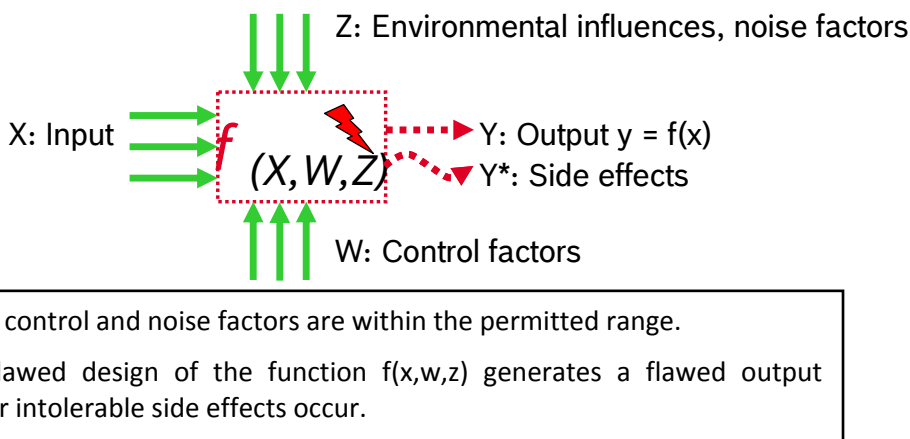

Figure 24: Failure

The following variations are possible:

**No function:** Product does not function at all, breaks down.

**Partial/excessive/deteriorated function (quantitative deviation):** Fulfillment of the function is unsatisfactory. Not all the required characteristics or attributes of specifications are satisfied; this may also include excessive function (too strong, too much) and function that declines over time (too little, too few).

**Temporarily suspended function (temporary deviation):** Satisfies the requirements, but loses some functional capability or cuts out completely (too early, too late, misfiring) from time to time due to external influences (e.g. temperature, humidity).

**Unintended function:** Describes interactions between several system elements that function correctly on their own, but have an undesirable effect on the overall performance of the product or process. The combination of individual performances leads to an unsatisfactory overall performance.

**Impermissible side effects:** Side effects from the system (e.g. noise, heat) exceed tolerances, i.e. the output conditions are violated.

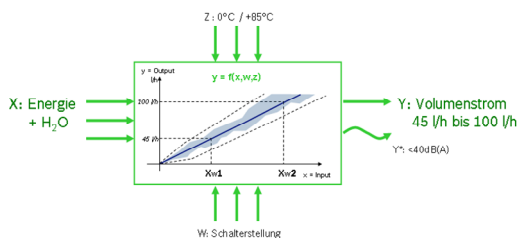

Pumps drinking water from the intake side to the pressure side (operating time 200 h) at a flow rate of 45 l/h to 100 l/h as per curve 4711 inside the tolerances, depending on the switch setting of the pump, at ambient temperature °C/+85°C in compliance with noise limit values <40dB(A).

**Example of possible failures**

- Pump does not convey any drinking water
- Pump exceeds the upper tolerance for the flow rate in the operating range
- Pump falls below the lower tolerance for the flow rate in the operating range
- Pump conveys drinking water but exceeds the noise limits
- Pump does not convey at a constant flow rate
- Pump conveys water in the wrong direction

Figure 25: Example of possible failures



### 3.3.2. Failure effects and failure modes

From the failures, failure effects and failure causes are then derived.

The possible failure effects are failures that occur in higher-level system elements. Failure effects must be precisely described up to the highest system level (e.g. end customer, vehicle).

Possible failure causes are conceivable failures of lower-level system elements.

A failure can be examined as a failure cause, failure mode or failure effect, depending on the focus.

Figures 24 and 25 show sections from the structure of a Product or Process FMEA with functions and possible failures.

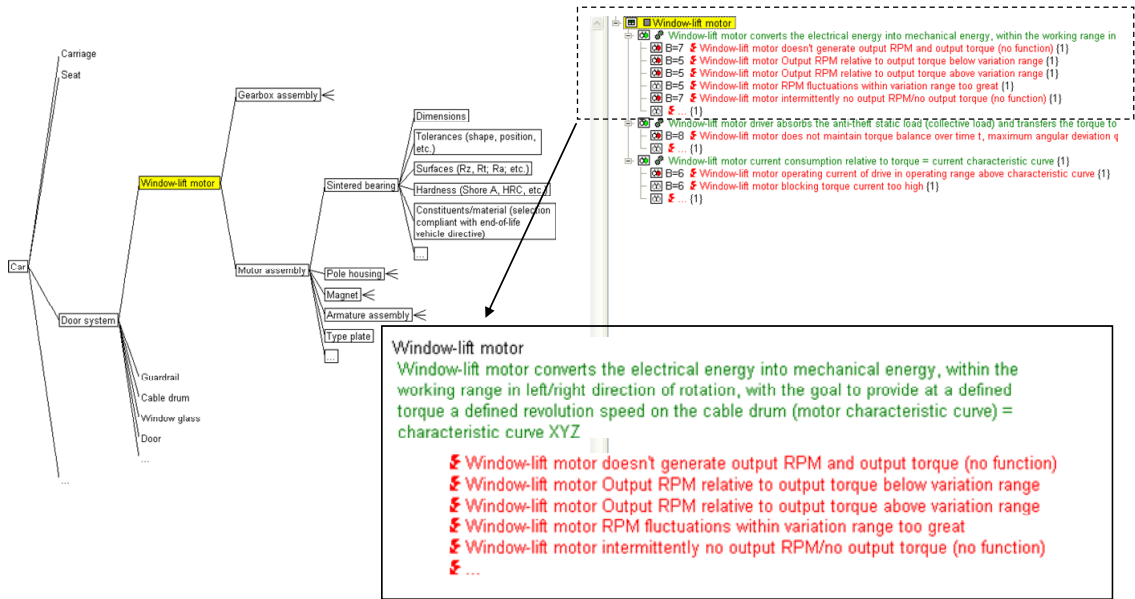

Figure 26: Failure description in the Product FMEA

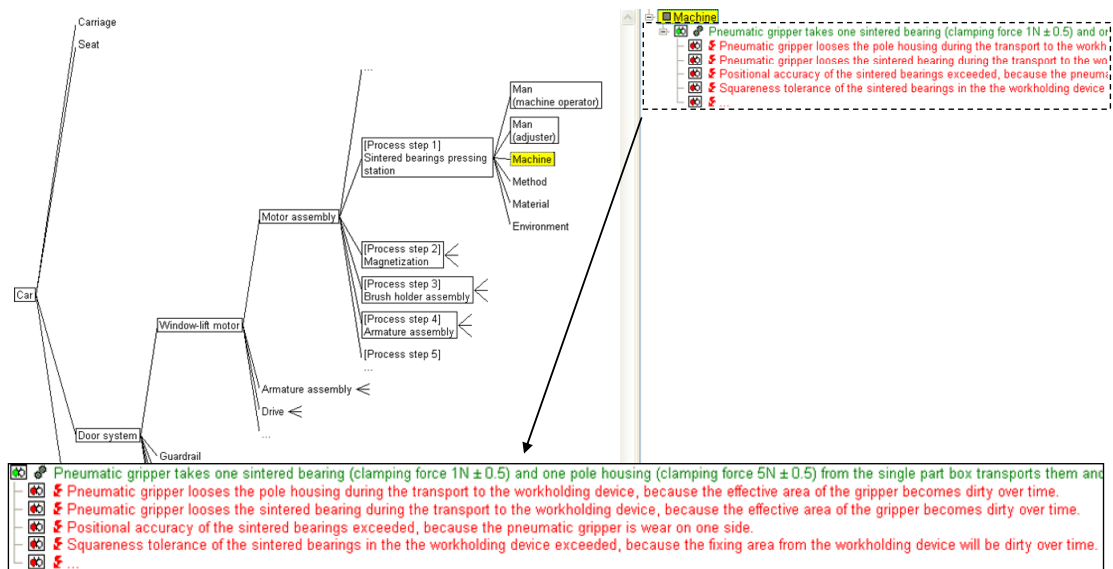

Figure 27: Failure description in the Process FMEA

In the failure net, the failures ascertained in this way are linked to produce a cause-effect presentation (logic OR operation). The functions and the function net provide the basis for this. See Figures 26 and 27 for example failure nets for the Product and Process FMEA.



# Failure Mode and Effects Analysis (FMEA)

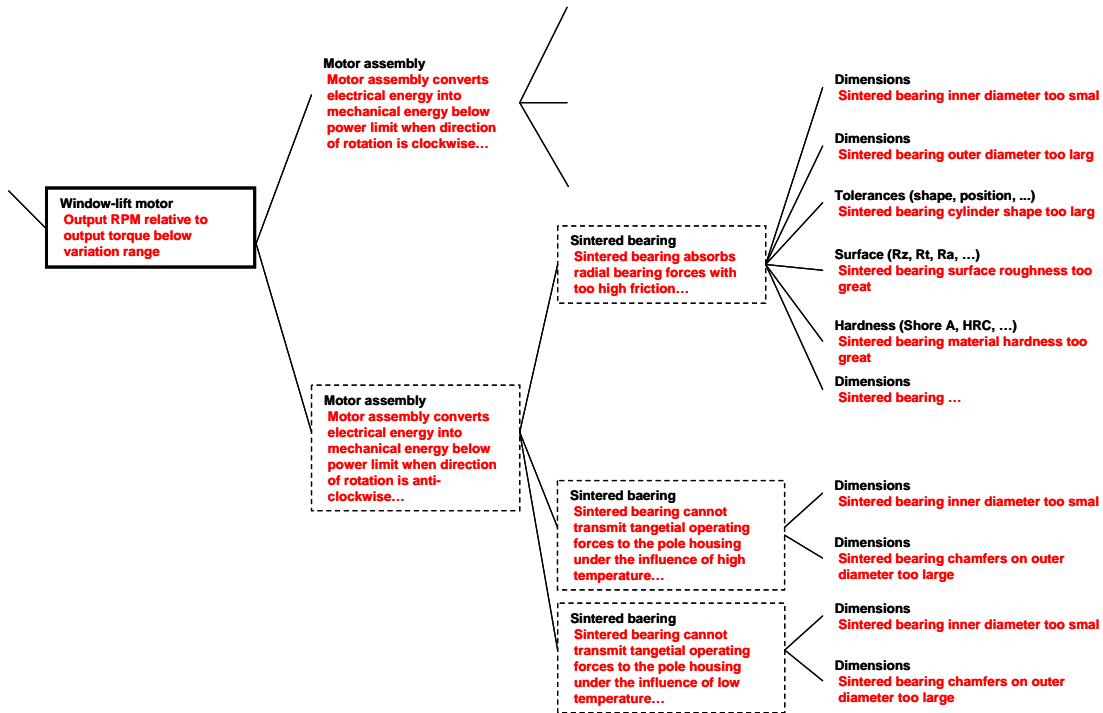

Figure 28: Failure net for Product FMEA (extract)

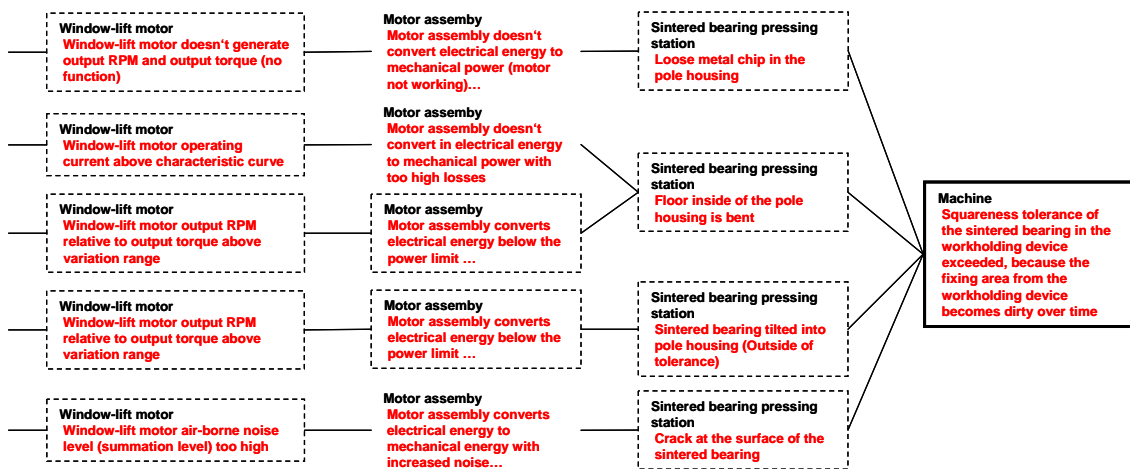

Figure 29: Failure net for Process FMEA (extract)



### 3.4. Action analysis

The current state of development, together with already introduced preventive and detective actions, are described on the basis of available results from product/process development. Under consideration of these actions, the risk of the cause-effect chains, comprising possible failure effect, possible failure and possible failure cause, is estimated by evaluating:

- the severity of the failure effect,
- the probability of occurrence of the failure cause, and
- the probability of detection in the cause-effect chain.

Multiplying the three individual evaluations enables us to calculate the so-called risk priority number (RPN). Along with further key figures, this is used to prioritize the risks, with the aim of determining optimization measures in the next step of the FMEA.

#### 3.4.1. Severity (S)

The severity of a failure effect on the uppermost level of the scope of analysis or on the defined interface to the higher-level system is rated by means of the figure "S". This evaluation takes place independently from the probability of occurrence (O) and probability of detection (D). The S rating is ascertained on the basis of product or industry-specific rating tables. Examples are the rating criteria set out in VDA or AIAG [2], [1] in the automotive sector. Descriptions and evaluations of failure effects are adjusted for Product and Process FMEA.

Example rating tables can be found in the Appendix.

#### 3.4.2. Probability of occurrence (O)

The "O" rating reflects the probability with which a possible failure cause will occur. Here, the actions implemented for preventing the cause of failure are taken into consideration. The effectiveness of these preventive actions must be verified. If no preventive action is described, the rating will be O=10.

The "O" rating should be seen as a relative estimate rather than an absolute measure. It takes into account the product lifecycle (Product FMEA), or time aspects in the case of processes (Process FMEA).

**Failure prevention** is taken to mean all preventive actions that have been employed in the product/process design with the aim of avoiding failure causes or reducing their probability of occurrence. The Product FMEA takes account of introduced actions that prevent or minimize design failures; the Process FMEA those that prevent or minimize process failures. The probability of occurrence rating therefore allows the design quality to be evaluated.

Failure prevention actions must be described in a way that the failures being prevented are clearly traceable. In respect of failure prevention measures, reference must be made to documents containing the results of the introduced actions, e.g. tolerance calculation, test report, 8D report.

Example rating tables can be found in the Appendix.

#### 3.4.3. Probability of detection (D)

The "D" rating reflects the probability with which the failure in the cause-effect chain (failure net) will be detected before handover to the customer using the described investigative measures. It therefore allows the effectiveness of the introduced detective actions to be evaluated. The customer is the organization that receives the results of the work.



## Failure Mode and Effects Analysis (FMEA)

**Failure detection action** is taken to mean all actions that are suitable for detecting a potential failure when it occurs.

In the Product FMEA, these are trials, experiments and tests with subsequent analyses until release is achieved.

In the Process FMEA, these are all tests and possibilities of detection until delivery to the customer. The suitability of process monitoring must be evaluated. Random sample tests are suitable only to a limited extent for detecting sporadically occurring failures or preventing the further processing of flawed parts in downstream processes.

Detective actions should focus on the failure cause, if possible. Detection at the failure source is preferable. Detection of the failure in the cause-effect chain may also be useful for technical and/or financial reasons. The actions must be worded in a clear and traceable manner, with reference to a document if necessary.

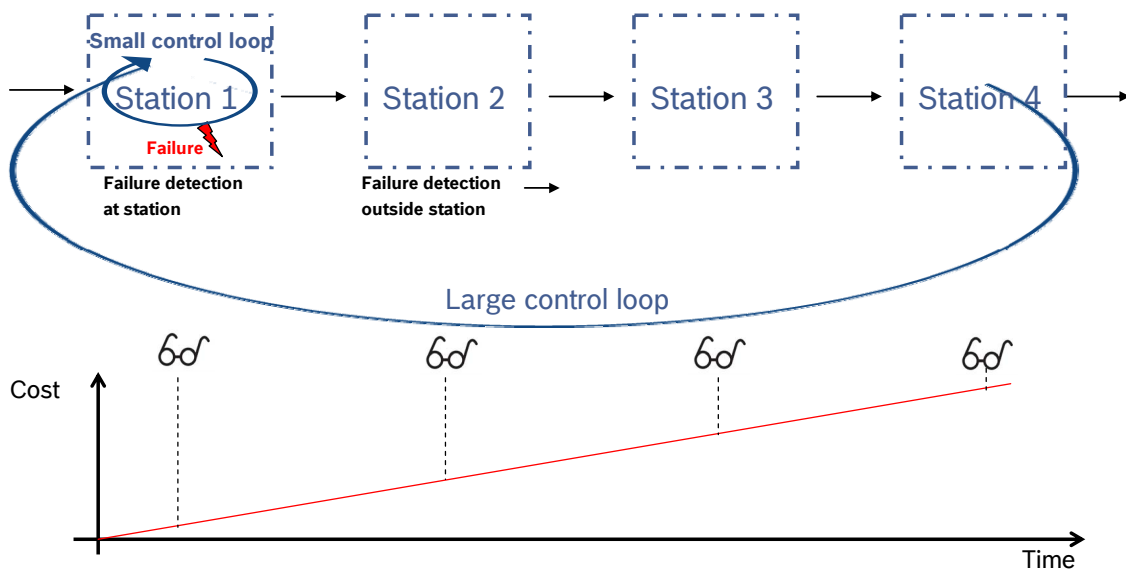

**Figure 30:** “Rapid reaction” Q control loop (aim: detection at the place of origin!)

If no detective action is described, the rating will be D=10.

**Failure detection actions** must be described such that it is clear which failures are being detected. In respect of failure detection actions, reference must be made to the item in the test sheet, capability test documentation, tests in the process or descriptions of other tests.

Example rating tables can be found in the Appendix.

The following diagram summarizes the interpretation of O and D ratings in the Product and Process FMEA.



	<b>O</b> Probability of occurrence	<b>D</b> Probability of detection
<b>Product FMEA</b>	Evaluation of the <b>quality of design</b> to prevent the failure	Evaluation of the <b>quality of verification</b> of the established design to prevent the failure
<b>Process FMEA</b>	Evaluation of the <b>quality of design of the process</b> to prevent the (production) failure	Evaluation of the <b>quality of detection</b> of the (production) failure

**Figure 31:** Overview of O and D

The illustrations below explain the distinction between preventive and detective actions in the Product or Process FMEA.

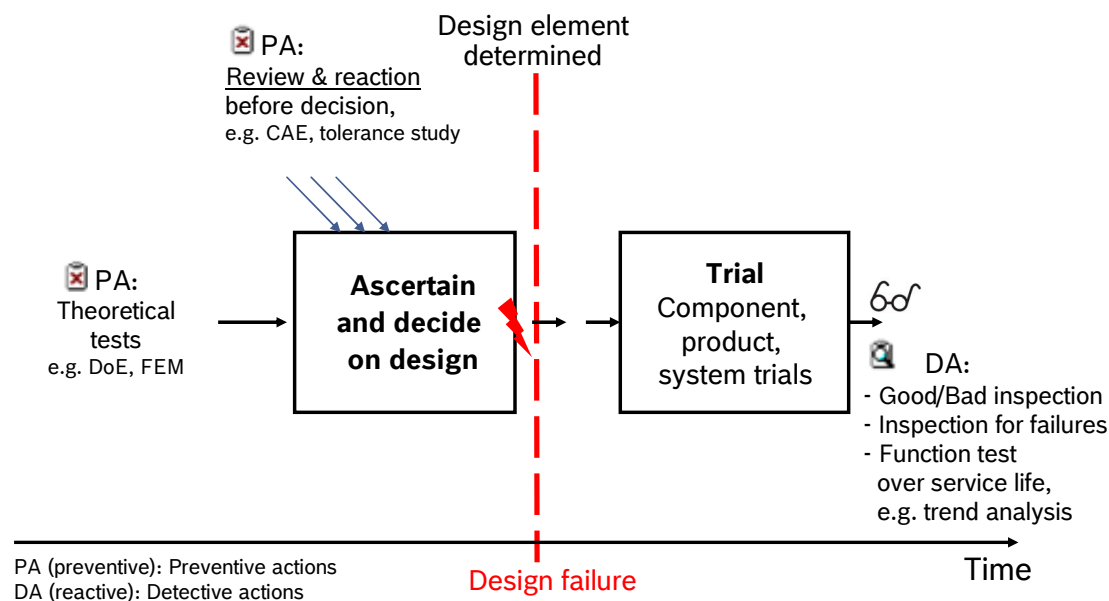

**Figure 32:** Prevention and detection in the Product FMEA

2020-04-06 - SOCOS





## Failure Mode and Effects Analysis (FMEA)

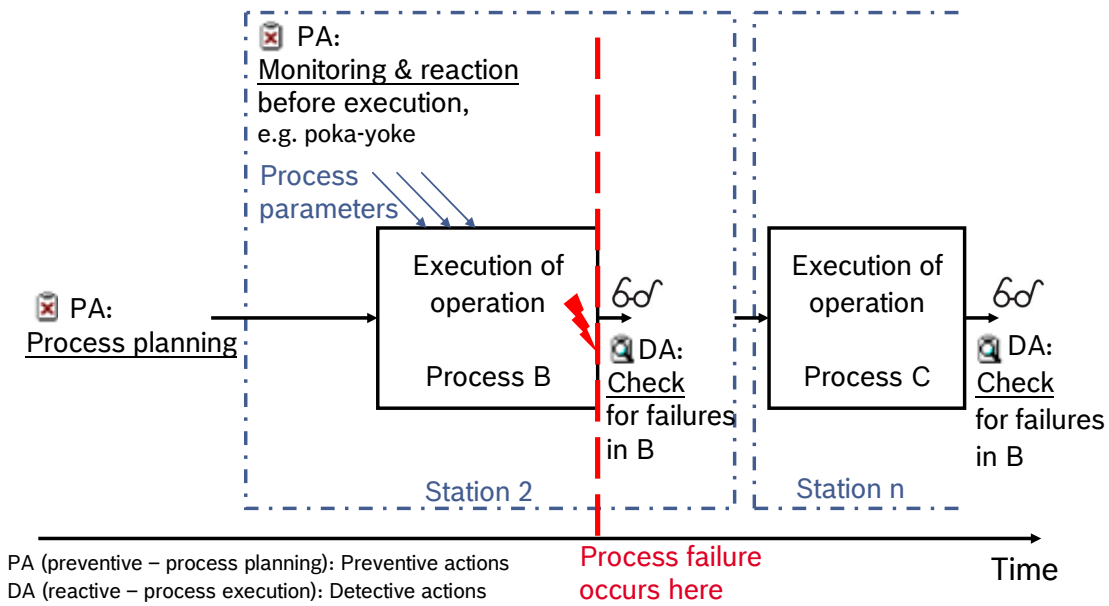

**Figure 33:** Prevention and detection in the Process FMEA

The following criteria must be considered for the description of actions:

- What is being prevented or detected (logical relationship between failure and action)?
- Where does prevention or detection take place?
- How large is the test interval and scope?
- What tools/resources are used to perform the action?
- Who or what performs the action?
- Where is the result documented?
- Where are the instructions for the action described?
- What is the reaction to the result of the action?

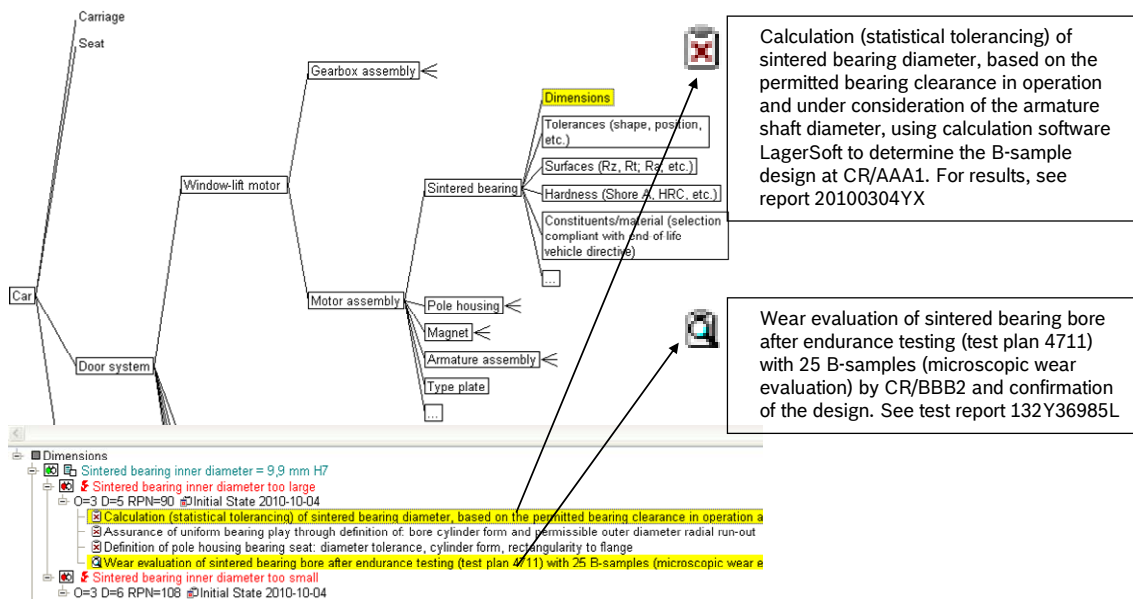

**Figure 34:** Example description of actions in the Product FMEA



## Failure Mode and Effects Analysis (FMEA)

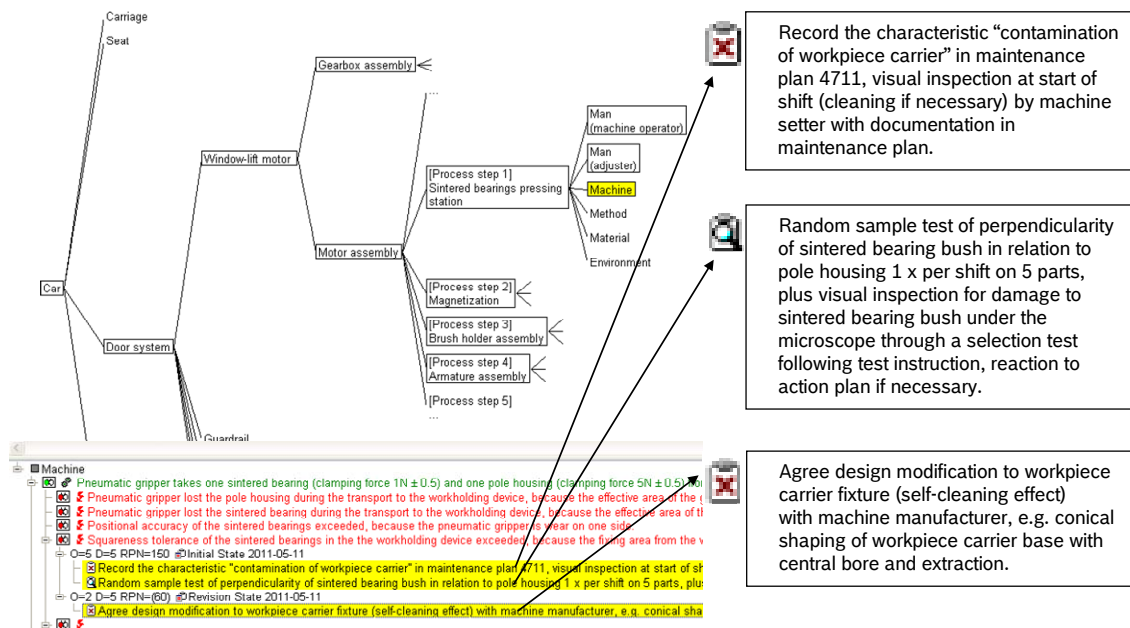

Figure 35: Example description of actions in the Process FMEA

### 3.4.4. Risk evaluation

The aim of the risk evaluation, with ratings S, O and D, is to prioritize potential weak points in order to find starting points for optimization in the next step of the FMEA.

Here, the following rules to ensure critical evaluation are a prerequisite for an effective FMEA:

- Evaluations must be agreed in the team.
- Obtain rating table from 10 (worst case) to 1.
- Only downgrade ratings with good reason.
- If the team is not unanimous, use the highest rating in each case.
- Avoid dual ratings. For instance, a very good detection (D = 1, failure does not reach the customer) must not result in a severity rating of S = 1.

Apply the rating benchmarks in a uniform manner.

The so-called risk priority number (RPN) is the product of the individual ratings:  $RPN = S \times O \times D$ . It is calculated in the FMEA as standard and automatically, if software is used. Further specific criteria (e.g.  $S \times O$  or  $O \times D$ ) may be established, however, for different applications.

At this point, we wish to point out that the results of the risk evaluation should be interpreted as relative estimates, not as absolute measures. The evaluations of different FMEA are not mutually comparable. Likewise, limit values for the risk priority number (RPN) are not suitable on their own as an evaluation criterion for determining improvement actions in the FMEA.



### 3.5. Optimization

On the basis of the evaluated status of development, the ascertained product/process risks are examined for possible improvements.

Step 5 can therefore also be described as an iterative development process (PDCA – Plan, Do, Check, Act) to improve the product/process through targeted actions to lower the current individual S, O or D rating, with subsequent effectiveness check and renewed decision about target achievement.

The procedure is divided into the following steps:

- The risks of the analyzed product/process are prioritized, i.e. sorting takes place e.g. on the basis of individual ratings, RPN, SxO or OxD.
- If the prioritized risks are unacceptable, new actions are proposed. These new actions are evaluated beforehand, allotted responsible persons and deadlines and put forward for a decision. An expected rating for the planned action is entered in round brackets ().
- Following implementation of the actions, an effectiveness check is performed with reference to the previous evaluation, and the evaluation is checked. If it turns out that the action has not achieved the desired result, the evaluation must be adapted accordingly and optimization repeated until an acceptable result has been reached.
- The result of the implemented actions must be described in the FMEA in a traceable manner. Reference may be made to further documents, e.g. reports of the results.

#### 3.5.1. Criteria for the determination of actions

The following criteria assist with the decision as to whether new actions should be determined:

- In the case of safety-relevant failure effects or non-compliance with legal regulations, -actions must be introduced, if possible, which reduce the severity of the failure effect.
- Agreed customer stipulations must be taken into consideration. Customer requirements must be agreed in accordance with internal regulations [8].
- The RPN provides information about prioritization, but does not suffice on its own as the basis for a decision.
- If individual ratings are high, improvement actions must be examined and introduced if necessary.
- Specific criteria (e.g. SxO, OxD) can be determined for different applications.
- The criteria for defining optimization actions in the FMEA are set out in the Central Directive [3] and can be expressed in greater detail for specific projects.

#### 3.5.2. Selection of actions

Actions are selected according to the following order of priority:

- Modification of the concept, to exclude the failure cause and/or obtain a failure effect with lower severity.
- Improvement of the design of product/process elements, to minimize the probability of occurrence of the failure cause.
- More effective detection of failures.



### Notes:

- In the event of modifications to the concept, all five steps of the FMEA will be repeated for the affected sub-areas.
- Failure prevention is more cost effective than failure detection.
- Failure detection at the source of failure (place of origin) is the ideal, as this prevents failures from spreading and avoids the waste of resources (rejects, corrective work, additional value enhancement).

### **3.5.3. Decision on actions to be implemented**

The FMEA team has the task of flagging up technical risks in products and processes and proposing possible solutions to reduce the risk.

Where the introduction of improvement actions is concerned, financial, time-based and strategic aspects must be taken into consideration as well as purely technical ones

The decision about the time and expenditure to be invested can only be made by the FMEA team itself within a certain framework. Decisions outside this framework are the responsibility of the decision makers. A presentation of FMEA results is recommended as the basis for this decision.

### **3.6. Documentation and release**

FMEA are confidential documents. They may be available in printed form or as a file.

For each FMEA printout, a set of documents must be compiled containing the following:

- Document with basic FMEA information (e.g. FMEA cover sheet),
- Proof of approval,
- FMEA forms (RB form or form with comparable content),
- Rating tables used.

An example of the FMEA cover sheet can be found in Appendix 2.

FMEA documents must be kept and archived in accordance with regulations [10].

FMEA must be created in IQ-RM and filed electronically. This facilitates the exchange of information between FMEA users. The Project Manager decides which documents are also to be archived as hard copies.

The signature beneath the FMEA is proof of agreement with the entire FMEA content. Additionally, the responsible persons decide whether the remaining risk is acceptable and document this by their signature on the cover sheet.

Once the FMEA printout has been fully completed or updated:

- The presentation of results is prepared,
- Approval is obtained through signatures of management.



## 4. Special Applications

### 4.1. FMEA for customer operation

The FMEA is utilized at an early stage of the product engineering process. It examines the status of development or planning applicable at this time for possible failures, with the aim of introducing actions to prevent them. Mechatronic systems, which contain sensors, control units and actuators, mostly feature integrated diagnostic and monitoring functions, with which the system can diagnose failures. Information about such failures detected during customer operation can be used to lessen failure effects (limp-home mode), to inform the driver and facilitate diagnosis and correction by Service personnel. The “customer operation” and “service” observation levels can therefore be included in the FMEA, but must be presented separately.

If the customer operation is analyzed in the Product FMEA a specific rating table for the probability of detection is employed (see Appendix).

### 4.2. Product FMEA and diagnosis

The Product FMEA contains important information that is relevant to diagnosis and can be used as input information for the diagnostic development process. For example, failure analysis data can be employed in the creation of diagnostic flow charts, and the structural analysis can provide an insight into the smallest replaceable unit. Comparison between the Product FMEA and the diagnostic flow chart helps to achieve a complete diagnosis.

Instructions for the creation of FMEA that are optimized for diagnosis:

- Group the structure into service-relevant components (smallest replaceable unit).
- Uniform descriptions of failure effects and severity ratings at vehicle level in different corresponding FMEA; pay attention to the propagation of failure effects beyond system borders.
- Workshop-relevant failure effects should be available and at vehicle level.
- Uniform presentation of failure effects at vehicle level showing symptoms that can be perceived by the driver (the technical description often does not match the customer’s description).

### 4.3. FMEA and DRBFM

DRBFM (Design Review Based on Failure Mode) is a systematic procedure for understanding and analyzing products during the course of their development. It focuses on potentially critical changes to an existing design and their influence on functions (description with limits and conditions), and resulting potential problems. The DRBFM enables the detailed examination of technical risks and the elaboration of solutions, with the aim of robust design. In design reviews, the developer explains to critical specialists why and how his design works.

The FMEA and DRBFM mutually complement one another and work closely together as preventive methods alongside development, with the aim of seeking out potential problems at an early stage and defining preventive actions. Whereas with the FMEA a product is continuously monitored, the DRBFM focuses on potential critical changes to a product compared with a predecessor or comparable product. The use and scope of analysis of the DRBFM is determined during product development, in order to prevent work being duplicated in the FMEA. Use of the DRBFM cannot replace use of the FMEA, as the scope of analysis and the content are not identical.



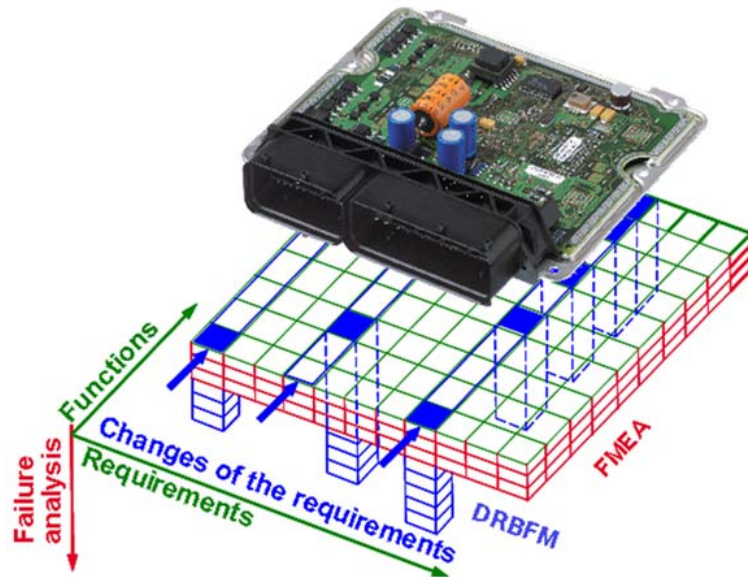

**Figure 36:** Relationship between FMEA and DRBFM

Results that have been achieved with one of these two methods can also be used for the other. Results may be documented in a common database.



## 5. FMEA software

The IQ-RM software tool assists the user with the structured acquisition, presentation and evaluation of the information to be processed. Use of the prescribed methodology is required to use the program.

Here is an overview of the features of IQ-RM relevant to the FMEA:

- Tree structures,
- Function nets,
- Failure nets,
- FMEA forms,
- Actions/schedules,
- Statistical analyses.

The current version can be installed via PeaCy, or downloaded from the intranet on the homepage of the C/QM corporate department. Robert-Bosch GmbH incl. subsidiaries with shares >50% hold a corporate license, which permits worldwide use and the exchange of data.

Knowledge of IQ-RM is taught in the TQ012 seminar.



## 6. References

- [1] Chrysler, Ford, General Motors: Potential Failure Mode and Effects Analysis, AIAG Manual, Ed. 4, 2008
- [2] Quality Assurance prior to Serial Application – FMEA , VDA Volume 4/3, 2006
- [3] CDQ 0305 Failure Mode and Effects Analysis (FMEA)
- [4] C/MSA Central Directive R05: Handling of FMEA/FTA/FMEDA/DRBFM/Control Plan/ QAM/ISO26262 Safety Case towards customer
- [5] CDQ 0306 Dealing with “Special Characteristics”
- [6] Quality Assurance prior to Serial Application – Fault Tree Analysis (FTA) VDA Volume 4/4
- [7] CDQ 0303 Technical Safety Requirements
- [8] CDQ 1105 Processing of Quality Management Requirements in the Automotive Industry Supply Chain
- [9] B1.300 Agreements with Suppliers on Quality Assurance
- [10] CDQ 0206 Control of Documents
- [11] RB/GF 108 Release of Classified Information to Third Parties
- [12] RB/GF 146 Decisions on In-House Sourcing from Outside Suppliers
- [13] RB/GF 169 Purchasing and Logistics
- [14] FMEA – Legal Aspects, C/LSK Letter dated 21.10.2010 (see intranet C/QM-FMEA)
- [15] ISO/TS 16949
- [16] ISO 26262





## **7. Appendix**

Appendix 1: Rating tables

Appendix 2: Cover sheet

Appendix 3: Contracting checklist

Appendix 4: Checklist for evaluation

Appendix 5: Example FMEA “Cleanliness concept”



Appendix 1 Rating tables

<p align="center"><b>General Evaluation Criteria for Severity S of Failure Effects in Product and Process FMEA (Effect on Customer and Manufacture/Assembly)</b></p>	<p align="center"><b>Evaluation S</b></p>
<p><b>Extremely serious failure</b> Which affects safety and / or compliance with legal regulations, without warning. Operators at the machine or in assembly may be endangered without advance warning.</p>	<p align="center">10</p>
<p><b>Extremely serious failure</b> Which affects safety and / or compliance with legal regulations, with warning. Operators on the machine or assembly line may be endangered with advance warning.</p>	<p align="center">9</p>
<p><b>Serious failure</b> Failure of primary functions, e.g. vehicle not ready for driving: Immediate workshop visit required. 100% of the product must be scrapped or product cannot be delivered.</p>	<p align="center">8</p>
<p><b>Severe failure</b> Functional capability of vehicle severely restricted: Immediate workshop visit required. Products must be sorted and &lt; 100% of the product must be scrapped, or severely delayed delivery, or reduced cycle time, or increased working effort.</p>	<p align="center">7</p>
<p><b>Medium failure</b> Functional capability of vehicle restricted due to failure of important control and comfort systems: Immediate workshop visit not required. 100% of production must be reworked (outside production line).</p>	<p align="center">6</p>
<p><b>Medium failure</b> Functional capability of vehicle restricted due to functional impairment of important control and comfort systems: Immediate workshop visit not required. A part of the production must be reworked (outside production line).</p>	<p align="center">5</p>
<p><b>Medium failure</b> Minor functional impairment in control and comfort systems; noticeable by any driver: Immediate workshop visit not required. Fitting characteristics and outward performance, squealing and rattling behavior do not correspond with the requirements. Fault is noticed by most customers (&gt; 75%). 100% of production must be reworked (at processing station before next process step).</p>	<p align="center">4</p>
<p><b>Insignificant failure</b> Customer is only slightly inconvenienced and will probably only notice a slight impairment; noticeable by average driver. Fitting characteristics and outward performance, squealing and rattling behavior do not correspond with the requirements. Fault is noticed by 50% of customers. A part of the production must be reworked (at processing station before next process step).</p>	<p align="center">3</p>
<p><b>Very minor failure</b> It is unlikely that the failure will have a perceptible effect on the behavior of the vehicle. Only noticeable by qualified personnel or practiced / experienced drivers. Fitting characteristics and outward performance, squealing and rattling behavior do not correspond with the requirements. Fault is noticed by individual customers (&lt; 25%). Process or operation slightly hindered, or slight inconvenience of the operator.</p>	<p align="center">2</p>
<p><b>No effect</b> No perceptible consequences. Very slight functional impairment, only noticeable by qualified personnel. No recognizable effects.</p>	<p align="center">1</p>

2020-04-06 - SOCCOS



## Failure Mode and Effects Analysis (FMEA)

Evaluation O	General Criteria for Product and Process FMEA
10	<b>Very high</b> It is almost certain that the failure cause / mode will occur very frequently.
9	New development of systems / components with no experience or under unclear operating conditions. Known system with problems. New process without experience.
8	<b>High</b> The failure cause / mode will occur repeatedly.
7	New development of systems / components using new technologies or use of problematic technologies. Known system with problems. New process with known but problematic processes.
6	<b>Moderate</b> The failure cause / mode will occur occasionally.
5	New development of systems / components with experience or changes to details of previous developments under comparable operating conditions. Proven system / component with years of fault-free series production experience under changed operating conditions.
4	New process with adoption of known processes. Proven process with positive series production experience under changed conditions.
3	<b>Low</b> The occurrence of the failure cause / mode is low. New development of systems / components with predictable positive testing method – not all certifications available yet. Changes to details of proven systems / components with years of fault-free series production experience under comparable operating conditions. Changes to details of proven processes with positive series production experience under comparable conditions – not all certifications available yet.
2	<b>Very low</b> The occurrence of the failure cause / mode is very low. New development of systems / components with a positively completed testing method. Changes to details of proven systems / components with years of fault-free series production experience under comparable operating conditions. Changes to details of proven processes with positive series production experience under comparable conditions.
1	<b>Unlikely</b> The occurrence of the failure cause / mode is unlikely or excluded. New development or proven system/component with experience under comparable operating conditions with positive results to verification procedure. Proven system / component with years of fault-free series production experience under comparable operating conditions. New process under changed conditions with positive results to machine/process aptitude verification. Proven process with positive series production experience under comparable conditions on comparable equipment. Failure is excluded by effective preventive action(s).

2020-04-06 - SOCOS



## Failure Mode and Effects Analysis (FMEA)

Evaluation criteria for "design detection" (for system, subsystem, component package, design)	Evaluation D	Evaluation criteria for detection "in customer operation" (for system, subsystem, component package)
<p><b>Unlikely</b></p> <p>The malfunction or failure mechanism will not be proved.</p> <p>It is unlikely that the detection actions in development will detect a possible malfunction or fault mechanism.</p> <p>The robustness / reliability of the design cannot be proved.</p>	10	<p><b>Unlikely</b></p> <p>It is impossible or unlikely that the failure will be detected at all or in time.</p> <ul style="list-style-type: none"> <li>- No monitoring / diagnosis of the functions to be monitored by the system.</li> <li>- Detection during diagnosis unlikely or only with very significant effort.</li> </ul>
	9	
<p><b>Low</b></p> <p>Low probability of detection of malfunction or failure mechanism as testing method is uncertain or no experience with the testing method available.</p>	8	<p><b>Low</b></p> <p>Low probability that the failure will be detected at all or in time.</p> <ul style="list-style-type: none"> <li>- Monitoring / diagnosis of some of the functions to be monitored or only under certain operating conditions by the system or the user</li> <li>- Changed function, e.g. convenient back-up mode</li> <li>- Detectable during diagnosis with significant effort only</li> </ul>
	7	
<p><b>Moderate</b></p> <p>Moderate probability of detection of the malfunction or failure mechanism. Proven verification method from comparable products under new operating/boundary conditions.</p>	6	<p><b>Moderate</b></p> <p>There is a moderate probability that the failure will be detected at all or in time.</p> <ul style="list-style-type: none"> <li>- Monitoring / diagnosis of some of the functions to be monitored by the system</li> <li>- Failure of function / back-up mode and / or with warning for user, e.g. statically actuated warning lamp</li> <li>- Detectable during diagnosis with reasonable effort</li> </ul>
	5	
	4	
<p><b>High</b></p> <p>High probability of detection of the malfunction or failure mechanism using proven verification method. The effectiveness of the detective action has been proven for this product.</p>	3	<p><b>High</b></p> <p>There is a high probability that the failure will be detected in time.</p> <ul style="list-style-type: none"> <li>- Monitoring and diagnosis of the functions to be monitored by the system</li> <li>- Failure of function and back-up mode with clearly perceptible impairment and / or warning for user, e.g. flashing warning lamp</li> <li>- Definitely detectable during diagnosis with minimal effort, e.g. using service routine</li> </ul>
	2	
<p><b>Certain</b></p> <p>Very high probability of detection of malfunction or failure mechanism using proven testing method on predecessor generations. The effectiveness of the detective action has been proven for this product.</p>	1	<p><b>Certain</b></p> <p>The failure will definitely be detected in time.</p> <ul style="list-style-type: none"> <li>- High-quality and independent monitoring and diagnosis of the functions to be monitored by the system</li> <li>- No common cause effects between failure cause and detection conceivable</li> </ul> <p>Failure of function / back-up mode with very clearly perceptible impairment and / or with clearly perceptible warning for the user, e.g. acoustic signal.</p> <ul style="list-style-type: none"> <li>- Definitely detectable by user or in diagnosis using self-diagnosis / indication without additional testing equipment</li> </ul>

2020-04-06 - SOCCOS



Failure Mode and Effects Analysis (FMEA)

<b>D</b>	<b>Probability of detection</b>	<b>Evaluation criteria</b>
<b>10</b>	<b>None</b>	The failure will not or cannot be detected as no testing method has been established or is known.
<b>9</b>	<b>Very low</b>	Test result uncertain or no experience with the defined testing method.
<b>8</b>		
<b>7</b>	<b>Low</b>	Testing method not yet proven or little experience with the defined testing method.
<b>6</b>		
<b>5</b>	<b>Moderate</b>	Proven testing method from comparable processes under new operating/boundary conditions (machines, material).
<b>4</b>		
<b>3</b>	<b>High</b>	Proven testing method. The required aptitude of this testing process has been confirmed.
<b>2</b>		
<b>1</b>	<b>Certain</b>	It is certain that the failure will be detected.

2020-04-06 - SOCCOS



Appendix 2 Cover sheet

 <p><b>BOSCH</b> QUALITY ASSURANCE</p>	<p align="center"><b>Cover sheet</b></p> <p align="center">Failure Mode and Effects Analysis</p>			<p>FMEA No.: ABC-123 FMEA pages: Edition: 1 Date: 30.11.2006</p>
<p>Distributor: <b>Departments/associates, who need the FMEA for project work</b> <b>The FMEA mailing list is determined for specific GBs</b></p>	<p>Product: [derived from the structure] Item number: [derived from the structure] Customer:</p>			
<p>Original file: <b>Place of original file storage</b></p>	<p>1. Task:</p> <ul style="list-style-type: none"> <li><b>Reason for FMEA creation, such as new product and/or process, modifications to product and/or process, etc.</b></li> <li><b>Scope of analysis</b></li> <li><b>GB agreement if nec. for cross-GB projects</b></li> <li><b>Reference to other applicable FMEA</b></li> </ul> <p>2. Result:</p> <ul style="list-style-type: none"> <li><b>Results from the analysis, such as highlights, top risks such as number of Special Characteristics, evaluations</b></li> <li><b>Justified statements about possible non-compliance with RB or GB FMEA rules, see Appendix</b></li> <li><b>Description of "Special Characteristics" internally defined and agreed with the customer, plus reference to separate list, with explanation</b></li> </ul> <p>3. Actions:</p> <ul style="list-style-type: none"> <li><b>Number of defined actions</b></li> <li><b>Special features of the actions to be introduced</b></li> <li><b>Number of pending actions</b></li> <li><b>Conclusion of all actions</b></li> </ul> <p>4. Appendices:</p> <ul style="list-style-type: none"> <li><b>Lists of attached FMEA analyses (frequency analysis and schedule)</b></li> <li><b>Reference FMEA</b></li> <li><b>List of documents (e.g. drawings, standards) that are necessary for understanding the FMEA</b></li> <li><b>Other, different evaluation tables</b></li> <li><b>Agreement with customer, failure numbers, etc.</b></li> </ul> <p>5. Remarks (optional):</p> <ul style="list-style-type: none"> <li><b>Explanations of the above points.</b></li> </ul>			
<p>FMEA team: <b>All team members without moderator</b></p>				
<p align="center"><b>Build</b></p>	<p align="center"><b>Approval</b></p>			<p align="center"><b>Realization</b></p>
<p align="center"><b>Moderator</b></p> <p>Name: Dept.: Date: Signature:</p>	<p>Dept.: Date: Signature:</p>	<p>Dept.: Date: Signature:</p>	<p>Dept.: Date: Signature:</p>	<p align="center"><b>Responsible Head of Dept.</b></p> <p>Dept.:</p>
<p align="center"><b>Work group contact person</b></p> <p>Name: Dept.: Date: Signature:</p>	<p>Dept.: Date: Signature:</p>	<p>Dept.: Date: Signature:</p>	<p>Dept.: Date: Signature:</p>	<p align="center"><b>Responsible for tracking and updating</b></p> <p>Name: Dept.:</p>

(C) Robert Bosch GmbH reserves all rights, including in the case of industrial property rights. We reserve all rights of disposal, including copyright and right of distribution.

2020-04-06 - SOCCOS



### Appendix 3 Contracting checklist

Contracting participants:	Name				
	Department				

#### 1. Order framework

Product or Process FMEA/Project	
Account no. (development order, PSP element)	
Project-specific outline deadlines (e.g. QGs, design freeze, SOP, ...)	(schedule with FMEA deadlines attached)
Start time of FMEA	
Deadlines for internal and external presentations	
Estimated time required (incl. preparation/follow-up work, e.g. in hours)	
Language (FMEA facilitation, documentation, translation)	

#### 2. Determination of the FMEA scope of observation

Scope of analysis (e.g. boundaries, responsibilities, internal/external interfaces, depth of analysis, prioritization)
Description of tasks (e.g. new FMEA, version of existing FMEA, interface to another FMEA, update, detailed analysis, ...)
Boundary conditions (e.g. use/coordination with other methods, such as QFD, FTA, DRBFM ...)

#### 3. FMEA team (for team composition, see Booklet 14 or documented GB procedures)

Name	Department	Task (role) in the team
		Moderator
		Team contact person

2020-04-06 - SOCOS



4. FMEA requirements and work documents

Requirement	Remarks	Available/Required?		
		Yes (document)	Not re-quired	No (Available by)
Specific customer requirements for FMEA methodology		<input type="checkbox"/>	<input type="checkbox"/>	<input type="checkbox"/>
Specific customer requirements for rating tables		<input type="checkbox"/>	<input type="checkbox"/>	<input type="checkbox"/>
Specific customer requirements for RPN limits		<input type="checkbox"/>	<input type="checkbox"/>	<input type="checkbox"/>
List of internal/external Special Characteristics		<input type="checkbox"/>	<input type="checkbox"/>	<input type="checkbox"/>
Agreement of failure effects incl. S ratings with customer		<input type="checkbox"/>	<input type="checkbox"/>	<input type="checkbox"/>
Agreement of evaluation lists between customer and Bosch (reference table)		<input type="checkbox"/>	<input type="checkbox"/>	<input type="checkbox"/>
Customer specifications, confirmed TKU		<input type="checkbox"/>	<input type="checkbox"/>	<input type="checkbox"/>
Performance specification		<input type="checkbox"/>	<input type="checkbox"/>	<input type="checkbox"/>
Parts lists and drawings		<input type="checkbox"/>	<input type="checkbox"/>	<input type="checkbox"/>
Flow chart/block diagram/process flow chart/control plan		<input type="checkbox"/>	<input type="checkbox"/>	<input type="checkbox"/>
Work schedule		<input type="checkbox"/>	<input type="checkbox"/>	<input type="checkbox"/>
		<input type="checkbox"/>	<input type="checkbox"/>	<input type="checkbox"/>

5. Acceptance of FMEA contracting

Yes	No (reason)	Resubmit by
<input type="checkbox"/>	<input type="checkbox"/>	<input type="checkbox"/>

Place/date

Project Manager (client)

FMEA Moderator





# Failure Mode and Effects Analysis (FMEA)

## Appendix 4 Checklist for evaluation (example)

Product/process:		FMEA No.:	
SOP:			
Remarks:			
<b>Part 1 (after compilation)</b>			
<b>0</b>	<b>Organization</b>	Completed Yes/No*	<b>Remarks/reason</b>
0.1	Define scope of observation and tasks involved in analysis.		Also see contracting, if necessary, documented on cover sheet
0.2	Establish FMEA team as per CDQ 0305 Item 3.1.2		Also see contracting, if necessary, documented on cover sheet
0.3	Compile FMEA to reflect the current status of product development/ process planning.		State reference documents with date and status on cover sheet?
0.4	Set up FMEA in the database and upload files (.fme and .xml).		If database exists
<b>1</b>	<b>System structure</b>		<b>Remarks/reason</b>
1.1	Check that requirements are complete and traceable.		Customer specifications, drawings, functional descriptions, design plans, structure, etc.
1.2	Create structure in accordance with the established scope and depth of observation		Reason for reduced scope/depth required; describe selection criteria, if applied
<b>2</b>	<b>Functional analysis</b>		<b>Remarks/reason</b>
2.1	Individually name functions. Provide concrete values and tolerances for parameters vital to function, or enter a reference to them.		Describe functions with a noun, verb and object References to drawings, customer specifications, etc. are required.
2.2	Logically interlink functions.		Create function trees/function grids
<b>3</b>	<b>Failure analysis</b>		<b>Remarks/reason</b>
3.1	Assign several malfunctions to each function.		Simply stating the negation of a function is mostly insufficient (take account of partial, unwanted and intermittent function)
3.2	Describe malfunctions in a clear and traceable manner.		List positive and negative tolerances individually if they produce different failure effects.
3.3	Logically interlink malfunctions.		Produce failure grids
3.4	Examine actual failure modes (root causes).		
3.5	Note the "Legal aspects" (C/LSK letter on "FMEA – Legal aspects")?		<a href="https://inside-ws.bosch.com/FIRSTspitWeb/pamlink/wcms_copyright_Guidelines_Information-EN">Legal aspects https://inside-ws.bosch.com/FIRSTspitWeb/pamlink/wcms_copyright_Guidelines_Information-EN</a>
<b>4/5</b>	<b>Risk analysis/optimization</b>		<b>Remarks/reason</b>
4.1	Make use of evaluation lists for severity, probability of occurrence and probability of detection.		Documentation of different evaluation lists; rate O and D with 10 if no action taken
4.2	Rate the same failure effects with the same severity (S) in the system under analysis.		Apply rating benchmarks uniformly
4.3	Assess severity of the failure effect for the product/process under observation and agree with customer if necessary.		
4.4	Comply with criteria for the introduction of improvement actions.		
4.5	Check the effectiveness of preventive/detective actions and describe their relationship to the documents in a traceable manner.		Reports, test reports, etc.
4.6	Appoint responsible persons and deadlines for planned actions.		
4.7	Incorporate and mark Special Characteristics required by the customer in the FMEA.		
4.8	Identify and document Special Characteristics from the FMEA analysis (CDQ 0306).		

\* A reason is required if the answer is "no"!

Place/date Signature: Project Manager Team Contact Person FMEA Facilitator

### Part 2 (after trials)

<b>6</b>	<b>Update</b>	Completed Yes/No*	<b>Remarks/reason</b>
6.1	Implement decided actions in compliance with deadlines.		
6.2	Check effectiveness of actions after trials.		
6.3	Define new actions if results are negative.		
6.4	Update FMEA within the required time frame.		For updating, see PEP Manual CDQ0304, CDQ0305 items 3.4

\* A reason is required if the answer is "no"!

Place/date Signature: Project Manager Team Contact Person FMEA Facilitator



Failure Mode and Effects Analysis (FMEA)

Appendix 5 Examples of FMEA "Cleanliness concept"

 <b>BOSCH</b>		KONSTRUKTIONS-FMEA							SEITE: 1/1				
QUALITÄTSSICHERUNG		ERZEUGNIS: Beispiel für Heft14 SACH-NR: 012345		ABT.: GS/XY		FMEA-NR.: Y 123 456		DATUM: 11.05.2011		MASSNAHMEN V:/T:			
NR.	KOMPONENTE PROZESS	FUNKTION	FEHLER-ART	FEHLER-FOLGE	K	FEHLER-URSACHE	FEHLER-VERMEIDUNG	FEHLER-ENTDECKUNG	B	A	E	RPZ	MASSNAHMEN V:/T:
040010	Ventil komplett	Spraygeometrie nach TKU 267356 erzeugen	Strahlwinkel außerhalb Toleranz	Abgas außer Tol. mit Fahrerwarnung		Eingespülte Partikel aus Leitungssystem beschädigen den Ventilsitz	Filtersieb mit 12 Maschen pro µm <sup>2</sup> am Ventilanschluß	Analyse der Funktionsmuster aus Musterbau nach Schmutzdauerlauf (Erprobungsblatt EB383)  Ergebnisse: Dauerlauf wurden durchgeführt. Bei A-Mustern keine erhöhten Ausfälle durch Partikel im Sitz.	9	3	6	[162]	
								Sauberkeits-Prüfvorschrift (PV F00V_H00_472) für die Einzelteile der Ventilgruppe (Partikelverteilung, Eingriffsgrenzen) festgelegt T: 01.03.2011	9	3	6	[162]	
								Sauberkeitsniveau bei Herstellung der Einzelteile in Prüfmethodenblatt mit Werk-QMM definieren und abstimmen T: 14.05.2011	9	3	6	162	

 <b>BOSCH</b>		Prozess-FMEA							SEITE: 1/1				
QUALITÄTSSICHERUNG		ERZEUGNIS: Beispiel für Heft14 ARBEITSGANG-NR: 1010		ABT.: Fertigungsplanungsabteilung XY		FMEA-NR.: GW 1234		DATUM: 10.03.2011		MASSNAHMEN V:/T:			
NR.	KOMPONENTE PROZESS	FUNKTION	FEHLER-ART	FEHLER-FOLGE	K	FEHLER-URSACHE	FEHLER-VERMEIDUNG	FEHLER-ENTDECKUNG	B	A	E	RPZ	MASSNAHMEN V:/T:
200.1010.1	Station 200  Ultraschallreinigungsbad (Tauchwaschanlage)	AG 1010  Teile in Waschrahmen (Reihenrost oder Steckrahmen) von anhaftenden Partikeln reinigen: -Ventilgehäuse -Gehäusedeckel -Ausgleichring	Restschmutzmenge größer als 3 Partikel pro cm <sup>2</sup>	Leckage am Ventilsitz  >> Abgasgrenzwerte außer Toleranz mit Fahrerwarnung		Badverschmutzung (Medium und Badoberfläche)	Eingriffsgrenzen und Medium in Wartungsplan Nr. A9468 für Anlage festgelegt  Mediumfiltration mit Filterüberwachung (Magnetkerzen...) VE-Wasser Kaskade Integrierte Ölabscheidung in Reinigungsbad  Verfahren und Einstelldaten in RA 1218 mit Berücksichtigung von VDA Band 19 festgelegt	5 Teile pro Schicht nach Waschen auf Sauberkeit prüfen gemäß PV 740237  Regelmäßiges Monitoring des Reinigungsmediums nach Prüfmethodenblatt Nr. 26943  100% autom. Dichtheitsprüfungen	9	2	3	54	
200.1010.2		Grenzen: - Partikeln größer als 12µm - Erlaubte Restschmutzmenge: 3 Partikel pro cm <sup>2</sup> - ölfrei Bedingungen: Reinigung gemäß Waschprogramm der einzelnen Teile (Reinigungszeit, Mediumtemperatur, Ultraschallfrequenz)				Teilspezifisches Waschprogramm wechselt	MA-Unterweisung nach Einarbeitungsplan EP952  Überprüfung des eingestellten Waschprogramms durch 4 - Augenprinzip (Bediener und Einsteller)	5 Teile pro teilspezifischer Waschablauf auf Sauberkeit prüfen gemäß PV 740237  100% autom. Dichtheitsprüfungen	9	2	3	54	
200.1010.3						Konzentration des Reinigungsmediums abweichend von der Spezifikation (Siehe RA 1218)	Nachdosierung der Bäder bei Bedarf nach wochentlicher Kontrolle der Konzentration des Mediums	Stichprobeprüfung der Konzentration des Reinigers (Titration) nach PV 740237	9	1	8	72	
200.1010.4						Teile nicht entmagnetisiert (Defekt am Gerät)	Entmagnetisiergerät überprüft (regelmäßig) MA-Unterweisung nach Einarbeitungsplan EP952	5 Teile pro teilspezifischer Waschablauf auf Sauberkeit prüfen gemäß PV 740237  100% autom. Dichtheitsprüfungen	9	2	3	54	
200.1010.n						und weitere Ursachen.....			9				

2020-04-06 - SOCOS



2020-04-06 - SOCOS

