

CATALOG

Ocal®

Corrosion-resistant conduit systems



Ocal® PVC-coated conduit and fittings represent a complete corrosion protection package for your entire conduit system.

With Ocal® PVC-coated conduit and fittings, you get corrosion protection that will help extend the life of your electrical raceway system for years and years.

Table of contents

004–005	ABB Services
006–011	Overview
012–021	PVC-coated conduit and accessories
022–042	PVC-coated conduit bodies and fittings
043–044	PVC-coated boxes and covers
045–052	PVC-coated hazardous location fittings
053–059	PVC-coated strut and accessories
060–073	Ocal® installation products
074–087	Technical Information

ABB Services

Ocal® PVC-coated conduit and fittings and other ABB products – better by design to stand up to your most demanding corrosive environments.

When you're dealing with the world's most corrosive environments, just any PVC-coated conduit won't do.

- OCal® is among the industry leaders offering thread protection through a hot-dipped galvanizing process, and industry leading UL® Listed Type 4X PVC-coated conduit bodies.
- OCal® offers a full undisturbed zinc coating under the PVC coating, fulfilling the requirement of NEMA RN-1 regarding the restriction of harmed or eroded zinc coating over the conduit.
- OCal® is UL® Listed with both the zinc coating and the PVC coating investigated and listed per UL6.
- OCal® is UL® Listed including UV resistance testing
- OCal® has “Double-Coat” coated fittings, enhancing corrosion protection by applying coating to the interior and exterior of the fittings before PVC coating.

At ABB, we're committed to:

- Convenience of single-order, single shipment to your site for thousands of stocking items
- Expert local point of contact for clear, consistent information regarding training, codes and standards
- Quality brands that have proven themselves over time
- Inventive design and manufacture of problem-solving products
- Offering a superior warranty and returns policy
- Uniform carton labeling with additional bar-coding for convenient inventory management
- Nationwide network of stocking electrical distributors
- Outstanding customer service capability
- Supplying you with the right products, convenient packaging, on-time delivery and competitive pricing

Which line of PVC-coated conduit, fittings and accessories can you trust to provide a complete corrosion-protection package for your entire electrical raceway system, extending its life for years to come? Ocal-Blue®.

We deliver the solutions that make your job easier and offer the power to bring it all together in one package. Call us today and let us help you profit from sourcing your electrical products from the leader, ABB.





Customer service

Phone: +1-800-816-7809

Fax: +1-800-816-7810

Email: generalcustomerserviceteam@tnb.com

Customer service specialists personally serve your account and can answer questions about products, order status, price and availability and other service-related inquiries.

ABB Access®

tnbaccess.tnb.com

ABB Access® is a multi-lingual, 24-hour, seven day-a-week global sales tool for our distributor partners that offers: quote requests, stock checks, pricing inquiries, cross reference, order entry and resolution, shipping status, document and web catalog look-up, automatic order receiving, item history search, multiple-location user search, context-sensitive help, shipping confirmation and tracking, expediting, returns processing, quality issues, customer report cards. Language options in English, French, and Spanish.

Technical services

Phone: 1-888-862-3289

Call our technical services department and speak LIVE to an expert who'll answer questions and concerns regarding all aspects of our products and services.

Tool services

Phone: +1-800-284-TOOL

ABB's dedicated tool services department answers all questions regarding tool applications, repair,

warranties, sales/lease/rental and technical information. Ask about our specialized services, including customer/sales training, demos and calibration/certification of tools.

Web catalog

www.tnb.com/webcatalog

Search for technical information by catalog number, UPC code, competitor cross-reference, keyword search, product category and/or brand. Use the "where to buy" function to locate an ABB local distributor and/or other support services.

Web CAD library

www.tnb.com/CADLibrary

The ABB CAD library is an online source of 2D and 3D CAD models, available FREE to customers who register. This valuable tool allows CAD designers, OEMs and engineering firms to quickly locate and download ABB drawings into their projects. Over 4,000 drawings of ABB Fittings, PMA® Cable Protection, Kindorf®, Red Dot® and Superstrut® products, as well as Steel City® and Carlon® Floor Boxes are currently available.

BIM library*

Now available to you through Autodesk® Seek (seek.autodesk.com), our BIM (building information modeling) objects can easily be imported to your Revit® models. These BIM objects are fully standards compliant, Revit® certified and completely configurable.

Overview

Ocal® – better by design

Ocal® PVC-coated conduit and fittings represent a complete corrosion protection package for your entire conduit system. This extensive product line includes an extensive number of items in stock along with corrosion resistant supports and patching compounds. With Ocal® PVC-coated conduit and fittings, you get corrosion protection that will help extend the life of your electrical raceway system for years and years.

A complete corrosion protection solutions

- UL® Listed with both the zinc coating and the PVC coating investigated and listed per UL6.
- Industry leading thread protection through a hot-dipped galvanizing process, and industry leading UL® Listed Type 4X PVC-coated conduit bodies.
- A full undisturbed zinc coating under the PVC coating, meeting the requirement of NEMA RN-1 regarding the restriction of harmed or eroded zinc coating over the conduit.
- Meets the requirements of NEMA RN-1* without exception.
- UL® Listed including UV resistance testing.
- “Double-Coat” coated fittings, enhancing corrosion protection by applying coating to the interior and exterior of the fittings before PVC coating.
- Custom colors.

- On-site installation training and certification, and extended warranty on installations conducted by certified installers.

Standards met

- ANSI C80.1
- Federal Specification WW-C-581
- NEMA RN-1*
- UL6

* Current as of publication of catalog



Overview

What is corrosion?

Corrosion is the gradual destruction of materials (usually a metal) by chemical and/or electrochemical reaction with their environment. This effect of corrosion is felt through millions of dollars in lost time, damaged materials, and labor costs.

Corrosion protection of electrical conduit systems

Corrosion protection options

Chemical Category	Chemical Examples	Compatibility Rating							
		PVC	URETHANE	304 Stainless Steel	316 Stainless Steel	Poly Carbonate	Cast Iron	Brass	Aluminum
Solvents (excluding alcohols and aliphatic)	Acetone, toluene, ketones, etc.	NR	NR	L	L	NR	L	L	L
Fuels	Jet fuel (alcohol based and aliphatic solvent based)	L	L	L	L	L	L	L	L
Plating Solutions	Chrome, nickel, copper, brass, gold, zinc, etc.	L	F	F	F	F	NR	NR	NR
Salts and Alkaline Materials	Caustic soda, caustic potash, alkaline cleaners, etc.	L	F	L	L	F	NR	NR	NR
Mild Acids	Low-concentration hydrochloric, sulfuric, fruit acids, glycolic, citric, etc.	L	S	L	L	S	NR	NR	NR
Strong or High-Purity Acids	Nitric, hydrofluoric, etc.	S	S	F	F	S	NR	NR	NR
Oxidizing Agents	Bleach, chlorine, hydrogen peroxide, etc.	L	S	L	L	S	NR	NR	NR

Chemical compatibility legend

Suitability Description	Compatibility Rating
Rated for all Fumes, Splash & Liquid	L
Rated only for Fumes & Splash	S
Rated for Fumes only	F
Not Recommended	NR

The chart above provides a general guide for selection of the most suitable material for corrosion protection. Compatibility with chemical environment should be thoroughly evaluated for each installation.

PVC-coated conduit and fittings are suitable for almost all applications. When it comes to PVCcoated conduit systems, you can count on Ocal's® quality.

Examples of corrosion



Overview

Ocal® manufacturing process

The Ocal® PVC-coated conduit system fully complies with all standards for proper use and protection in corrosive environments mandated by UL6, NEMA RN-1* and ANSI C80.1. Ocal® is manufactured right here in the United States by ABB in our Jonesboro, AR facility.

The process of manufacturing PVC-coated conduit

01 The process begins with 20-foot sticks of raw steel shell.

02 The steel shell is cut, threaded and prepared for the hot-dip galvanizing process.

03 The threaded shell is immersed in a molten zinc bath. This hot-dip galvanizing process enables the zinc to penetrate the steel, providing the best possible protection. After the conduit is extracted from the zinc bath, superheated steam is blown through the interior and over the outside of the conduit to remove any slag. The ends of the conduit are heated enough to blow excess zinc out of the thread cavities. ABB manufactures steel conduit that hot-dip galvanizes the threads as well as the conduit itself. Other methods such as "hot galvanizing" provide only a sprayed-on zinc coating.

04 Prior to the exterior PVC coating, 2 mils (nominal) of blue urethane is applied to the inside diameter as well as the threads of each conduit. After priming, the conduit is heated and then rolled through liquid plastisol, achieving complete coverage of 40 mils in thickness.

05 Standard colors include gray, white and blue. 5 Custom colors also available.



01



02



03



04

Ocal® offers

- Plant walk-throughs
- Installation training and certification
- Installation tools
- The expertise to ensure that you get the maximum benefit of the Ocal-Blue® total protection system
- Manufacturing capabilities that ensure unmatched delivery time on custom orders, special colors or large quantities
- Protection of each shipment with special packaging to help provide damage-free delivery

Superior Service

Our reputation for dependability and customer service has made Ocal® one of the most trusted names in corrosion protection for the electrical industry.



* Current as of publication of catalog

Overview

Complete corrosion protection

Ocal® has developed a process for coating the interior and exterior of all fittings with a nominal .002" (2 mils) of blue urethane, which is baked on. This proprietary application of urethane enhances the corrosion protection of your system, even if you accidentally nick or cut the PVC coating during installation. Flexible, overlapping sleeves on all Ocal® fittings provide protection with a vapor- and moisture-tight seal at every connection.

The process of manufacturing PVC-coated fittings

- Fittings are cleaned and then sprayed inside and outside with 2 mils (nominal) of blue urethane
- This gives the fittings corrosion protection on the exterior as well as the interior – all fittings are “double-coated”
- 40 mils of PVC is applied to the exterior of the fitting
- Covers are coated with a molded flange and molded integral O-ring seal for 2½" - 4" Form 8 and all Form 7. Conduit bodies are molded with a flat surface to ensure a superior seal
- Standard colors include gray, white and blue. Custom colors also available

ABB takes pride in providing PVC-coated conduit and fittings compliant with industry wide recognized standards. It is this dedication to superior quality that makes Ocal “Better by Design.”

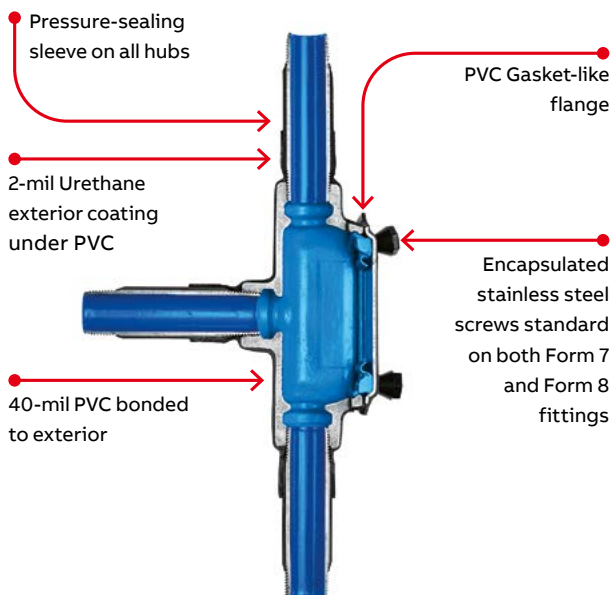

Ocal supplies encapsulated screws on both Form 7 and Form 8 fittings.

Ocal-Blue® Double-coat UL® Listed Type 4X and NEMA 4X Form 8 conduit bodies

For the conduit system that has to stand up to a corrosive environment, the newly designed Ocal-Blue® Type 4X Form 8 conduit body is up to the challenge. The key is in the cover. Ocal® takes a cast cover and then injection molds a PVC coating around it with an integral O-ring seal.

There's no need for tools or gaskets. To meet the harsh requirements of the UL® Type 4X listing, you need only hand-tighten the stainless steel encapsulated screws to 15 in.-lbs. of torque – as compared to the 35 in.-lbs. of torque required to tighten cover screws on other conduit bodies.

Ideal for providing corrosion-resistant performance in washdown and other tough applications, Ocal-Blue® Type 4X Form 8 PVC-coated cast-iron conduit bodies are now available in sizes up to 2". Look for the blue to know it's a high-quality ABB product.

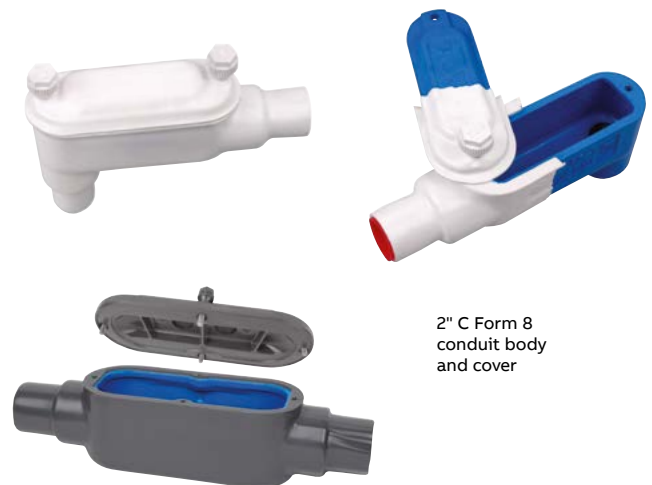

2" C Form 8 conduit body and cover

Overview

Evaluating corrosion protection of PVC-coated conduit

01 Example of Hot-Dip Galvanized Threads after 42-day salt-fog test

02 Example showing how a Zinc coating surpasses the requirement for corrosion resistance

When evaluating any electrical raceway conduit or fittings, applicable standards should be referenced.

The three standards that address the design and performance of PVC-coated rigid steel conduit are ANSI C80.1, UL6 and NEMA RN-1. ANSI C80.1, UL® and NEMA have determined the appropriate ASTM standards and test methods that apply.

Hot-Dip Galvanized Threads

Since electrical conduit systems breathe, the threads will be exposed to the corrosive environment for the duration of the installation. NEMA RN-1-2005 is the electrical industry's standard for PVC externally coated galvanized rigid steel conduit. Section 2.1 of this standard states, "Where unusually corrosive environments are encountered, it is recommended that threads be given additional protection suitable for the intended application." Hot-dip galvanizing is the process through which the steel shell is dipped in molten zinc, causing the zinc to penetrate the steel. Ocal® hot-dip galvanizes the threads of the conduit, in addition to the conduit itself. This gives the threads the protection recommended in corrosive environments.

The standard for rigid metal conduit, UL6, sets out ASTM B117, a salt-fog test as the standard corrosion test. The photographs below present compelling evidence of the protection hot-dip galvanizing provides against the corrosive agent, salt.



01

Galvanized conduit underneath the PVC coating – Preece test

With much riding on the integrity of electrical conduit systems, facilities need the superior protection offered by the ABB Ocal® PVC-coated conduit which comply with the current design and performance standards for PVC-coated conduit set forth by UL6, NEMA RN-1 and ANSI C80.1. ANSI C80.1, UL6 and NEMA RN-1 have established the appropriate ASTM standards and test methods. The Preece test must be passed to be in full compliance.

Why is the Preece test relevant to PVC-coated conduit?

In cases where the PVC protection is accidentally breached, resulting from cuts, scrapes, etc., it is critical to have a second line of defense – a zinc, or galvanized, coating. The zinc coating will significantly slow corrosion before failure occurs. Conduit systems without adequate zinc protection underneath the PVC coating are most likely to suffer catastrophic corrosion damage. This is why NEMA RN-1 section 3.1.1 requires the proper and correct treatment of galvanized conduit before it is PVC coated. It states, "The surface shall be cleaned in such a manner that the galvanized surface of the conduit is not harmed or eroded."



02

The Preece test evaluates the zinc coating on galvanized rigid conduit to ensure adequate protection from corrosion per UL6.2.2. The test will also determine if the surface of the conduit has been damaged as a result of preparation for PVC coating.

In evaluating the test results, the conduit receives a passing grade when the sample does not show a bright, adherent deposit of copper after four 60-second immersions in the copper sulfate solution. The conduit showing the bright, firmly adhering copper has failed to provide adequate zinc protection against corrosion.

The Preece test follows procedures set forth by UL6.2.2 and ASTM A239 and is the test recognized by UL6, NEMA RN-1 and ANSI C80.1 to adequately assess zinc protection for rigid steel conduit. The Ocal® line of PVC-coated conduit systems, manufactured by ABB, currently complies with UL6, NEMA RN-1 and ANSI C80.1 without exception.

Overview

Adhesion test

01 **Step 1** consists of two cuts through the plastic to the substrate along the length of the conduit, approximately 1/2" apart and 3" to 4" in length. A third, perpendicular cut crosses the lengthwise parallel cuts.

02 **Step 2** calls for the edge of the PVC that was cut on the perpendicular to be carefully lifted to form a plastic tab.

03 **Step 3** the tab is pulled perpendicular to the conduit with a pair of pliers. The plastic tab will tear off rather than having any peeling effect or the coating separating from the substrate.

04 **Step 4** is the evaluation of the test, which in this case, results in a passing grade for Ocal. This result is more testimony to the fact that Ocal is "Better by Design."

The evaluation process for adhesion of PVC coating on conduit is governed by NEMA RN-1 section 3.8, Adhesion, which states, "The adhesion of the PVC coating to the conduit shall be greater than the strength of the coating itself." This adhesion test is straightforward and simple.

There are no specialized conditions necessary to perform this test. Ocal® routinely performs quality-control testing – including the adhesion test – on conduit as it rolls off the line. Conduit that passes this test demonstrates that the adhesion will provide years of trouble-free service.

The following demonstration shows Ocal® PVC-coated conduit being subjected to the adhesion test.



01



02



03



04

Results

With Ocal® PVC-coated conduit and fittings, you get corrosion protection that will extend the life of your electrical raceway systems for years and years.

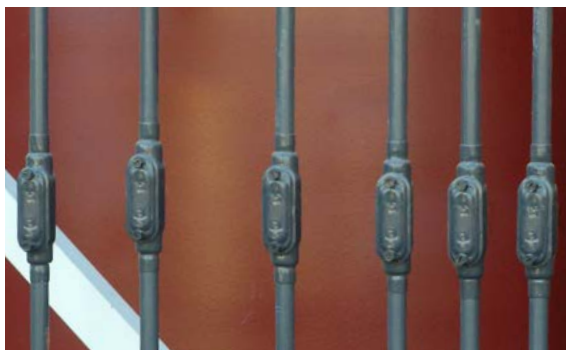

Ocal-Blue® Conduit

The ultimate in corrosion protection



Product features

- Hot-dip galvanized steel or aluminum conduit
- Nominal .002" (2 mil) blue urethane coating on interior
- Hot-dipped galvanized threads (steel)
- Minimum .040" (40 mil) PVC coating on exterior – in your choice of blue, white, gray or custom colors
- Color-coded thread protectors
- Couplings shipped with conduit are packaged separately

Ocal-Blue® conduit



Product Code		Pipe Size (in.) Metric Size Designator*	Outside Diameter Steel Only (in.) (mm)	Outside Diameter with PVC (in.) (mm)	Nominal Wall Thickness Steel Only (in.) (mm)	Nominal Wall Thickness with PVC (in.) (mm)	Nominal Inside Diameter (in.) (mm)	Cross Section Area in Square (in.) (mm)	Length without Couplings (ft) (m)	Minimum Weight per Foot Steel only (lbs) (kg)
COND1/2-	COND1/2SA-	1/2	0.84	0.92	0.10	0.14	0.63	0.30	9'11 1/4"	0.79
		16	21.3	23.3	2.64	3.56	16.1	7.72	3.03	0.36
COND3/4-	COND3/4SA-	3/4	1.05	1.13	0.11	0.15	0.84	0.53	9'11 1/4"	1.05
		21	26.70	28.70	2.71	3.73	21.20	13.53	3.03	0.48
COND1-	COND1SA-	1	1.32	1.40	0.13	0.17	1.06	0.86	9'11"	1.53
		27	33.4	35.4	3.20	4.21	27.00	21.94	3.02	0.69
COND1-1/4-	COND1-1/4SA-	1 1/4	1.66	1.74	0.13	0.17	1.39	1.50	9'11"	2.01
		35	42.20	44.10	3.37	4.39	35.40	37.97	3.02	0.91
COND1-1/2-	COND1-1/2SA-	1 1/2	1.90	1.98	0.14	0.18	1.62	2.04	9'11"	2.40
		41	48.30	50.20	3.50	4.52	41.20	51.71	3.02	1.09
COND2-	COND2SA-	2	2.38	2.46	0.15	0.19	2.08	3.36	9'11"	3.32
		53	60.30	62.30	3.70	4.72	52.90	85.21	3.02	1.51
COND2-1/2-	COND2-1/2SA-	2 1/2	2.88	2.96	0.19	0.23	2.49	4.80	9'10 1/2"	5.27
		63	73.00	75.00	4.90	5.91	63.20	121.61	3.01	2.39
COND3-	COND3SA-	3	3.50	3.58	0.21	0.25	3.09	7.39	9'10 1/2"	6.83
		78	88.9	90.9	5.20	6.22	78.50	187.80	3.01	3.10
COND3-1/2-	COND3-1/2SA-	3 1/2	4.00	4.08	0.22	0.26	3.57	9.87	9'10 1/4"	8.31
		91	101.6	103.6	5.46	6.47	90.70	250.60	3.00	3.77
COND4-	COND4SA-	4	4.50	4.58	0.23	0.27	4.05	12.73	9'10 1/4"	9.73
		103	114.30	116.30	5.71	6.73	102.90	323.34	3.00	4.41
COND5-	COND5SA-	5	5.56	5.64	0.25	0.29	5.07	20.01	9'10"	13.14
		129	141.3	143.3	6.22	7.23	128.90	508.15	3.00	5.96
COND6-	COND6SA-	6	6.63	6.71	0.27	0.31	6.09	28.89	9'10"	17.46
		155	168.30	170.30	6.75	7.87	154.80	733.83	3.00	7.92

Note – Inches, feet and pounds are indicated in bold type. Metric measure is directly below bold type.
 * Metric size designator (ANSI C80.1-1994).

Product Code	Size	Material	Colour
COND	3/4	SA -	---
		Blank = Steel	_ = space for color identifier
		SA = Aluminum	G = Gray
			W = White
			B = Blue

Catalog No. Example:
COND3/4-G is 3/4" steel conduit coated in gray PVC. Custom colors also available.



Ocal-Blue® Couplings

Corrosion-protected connections for conduit sections



Product features

- Nominal .002" (2 mil) blue urethane coating on interior and threads
- Minimum .040" (40 mil) PVC coating bonded to exterior – in your choice of blue, white, gray or custom colors
- Straight threads (NPS)
- Molded ribs on outer coating for easy installation
- (up to and including 4" trade size)
- Pressure-sealing sleeves protect your connection

Ocal-Blue® couplings

Product Code		Coupling Size (in.) Metric Size Designator*	Minimum Length of Metal (in.) (mm)	Total Minimum Length Including Sleeve (in.) (mm)	Weight Steel only (lbs) (kg)
Steel	Aluminium				
CPL1/2- <u> </u>	CPL1/2SA- <u> </u>	1/2 16	1.50 38.10	3.75 95.25	0.13 0.06
CPL3/4- <u> </u>	CPL3/4SA- <u> </u>	3/4 21	1.53 38.91	3.75 95.25	0.19 0.85
CPL1- <u> </u>	CPL1SA- <u> </u>	1 27	1.91 48.41	4.94 139.7	0.33 0.15
CPL1-1/4- <u> </u>	CPL1-1/4SA- <u> </u>	1 1/4 35	1.91 48.41	5.50 139.7	0.43 0.19
CPL1-1/2- <u> </u>	CPL1-1/2SA- <u> </u>	1 1/2 41	1.91 48.41	5.75 146.05	0.56 0.25
CPL2- <u> </u>	CPL2SA- <u> </u>	2 53	1.94 49.19	5.94 150.79	0.77 0.35
CPL2-1/2- <u> </u>	CPL2-1/2SA- <u> </u>	2 1/2 63	2.88 73.10	6.88 174.70	1.85 0.83
CPL3- <u> </u>	CPL3SA- <u> </u>	3 78	3.03 76.98	7.03 178.58	2.70 1.22
CPL3-1/2- <u> </u>	CPL3-1/2SA- <u> </u>	3 1/2 91	3.09 78.58	7.09 180.18	3.78 1.70
CPL4- <u> </u>	CPL4SA- <u> </u>	4 103	3.19 80.97	7.19 182.57	3.08 1.39
CPL5- <u> </u>	CPL5SA- <u> </u>	5 129	3.37 85.69	7.37 187.29	5.00 2.25
CPL6- <u> </u>	CPL6SA- <u> </u>	6 155	3.44 87.29	7.44 188.89	8.00 3.60

Note – Inches, feet and pounds are indicated in bold type. Metric measure is directly below bold type.

* Metric size designator (ANSI C80.1-1994).

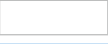
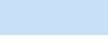
Product Code	Size	Material	Colour
CPL	1	SA-	—
		Blank = Steel	_ = space for color identifier
		SA = Aluminium	G = Gray 
			W = White 
			B = Blue 
Catalog No. Example:			
CPL1SA-B is a 1" aluminum coupling coated in blue PVC.			
Custom colors also available.			

Ocal-Blue® Double-coat split couplings

Join threaded conduit where you can't use a standard coupling



TCC Split Coupling

Split couplings serve as speed unions for cost-effective joining of two separate lengths of threaded conduit. Like other Ocal® fittings, they're double coated in urethane and PVC to help safeguard your entire conduit system against corrosion.

Product features

- Malleable iron construction
- Nominal .002" (2 mil) blue urethane on both interior and exterior
- Minimum .040" (40 mil) PVC bonded to exterior
- PVC coating in your choice of blue, white and gray standard colors with custom colors available on request
- Stainless steel hardware included separately

Ocal-Blue® double-coat split couplings

Product Code	Pipe Size (in.)	Metric Size Designator*
TCC1- <u> </u>	1/2	16
TCC2- <u> </u>	3/4	21
TCC3- <u> </u>	1	27
TCC4- <u> </u>	1 1/4	35
TCC5- <u> </u>	1 1/2	41
TCC6- <u> </u>	2	53

* Metric size designator (ANSI C80.1-1994).

Product Code	Pipe Size (in.)	Metric Size Designator*
TCC7- <u> </u>	2 1/2	63
TCC8- <u> </u>	3	78
TCC9- <u> </u>	3 1/2	91
TCC10- <u> </u>	4	103
TCC12- <u> </u>	5	129
TCC14- <u> </u>	6	155

* Metric size designator (ANSI C80.1-1994).

Product Code	Size	Colour
TCC	1	

 = space for color identifier

G = Gray 

W = White 

B = Blue 

Custom colors also available.

Note: The use of standard couplings is recommended whenever possible due to better overall corrosion protection..

Ocal-Blue® Nipples

Speed up your field installations with pre-threaded conduit nipples





Product features

- Made from Ocal® PVC-coated steel or aluminum conduit
- Blue urethane coating over threads
- Nominal .002" (2 mil) blue urethane on interior
- Minimum .040" (40 mil) PVC coating on exterior – choose blue, white, gray or custom colors
- Color-coded thread protectors for easy identification of conduit size
- Available in 11 standard lengths – close and 2" to 12" with custom lengths available on request
- Close nipples are coated only in urethane

PVC-coated conduit nipples – steel

Pipe Size (in.) Metric Size*	Nipple Length (in.) (mm)										
	Close	2" 50.8	2½" 63.5	3" 76.2	3½" 88.9	4" 101.6	5" 127.0	6" 152.4	8" 203.2	10" 254.0	12" 304.8
½" 16	CLNPL1/2- ₋	NPL1/2X2- ₋	NPL1/2X21/2- ₋	NPL1/2X3- ₋	NPL1/2X31/2- ₋	NPL1/2X4- ₋	NPL1/2X5- ₋	NPL1/2X6- ₋	NPL1/2X8- ₋	NPL1/2X10- ₋	NPL1/2X12- ₋
¾" 21	CLNPL3/4- ₋	NPL3/4X2- ₋	NPL3/4X21/2- ₋	NPL3/4X3- ₋	NPL3/4X31/2- ₋	NPL3/4X4- ₋	NPL3/4X5- ₋	NPL3/4X6- ₋	NPL3/4X8- ₋	NPL3/4X10- ₋	NPL3/4X12- ₋
1" 27	CLNPL1- ₋	NPL1X2- ₋	NPL1X21/2- ₋	NPL1X3- ₋	NPL1X31/2- ₋	NPL1X4- ₋	NPL1X5- ₋	NPL1X6- ₋	NPL1X8- ₋	NPL1X10- ₋	NPL1X12- ₋
1¼" 35	CLNPL1¼/4- ₋	NPL1¼/4X2- ₋	NPL1¼/4X21/2- ₋	NPL1¼/4X3- ₋	NPL1¼/4X31/2- ₋	NPL1¼/4X4- ₋	NPL1¼/4X5- ₋	NPL1¼/4X6- ₋	NPL1¼/4X8- ₋	NPL1¼/4X10- ₋	NPL1¼/4X12- ₋
1½" 41	CLNPL1½/2- ₋	NPL1½/2X2- ₋	NPL1½/2X21/2- ₋	NPL1½/2X3- ₋	NPL1½/2X31/2- ₋	NPL1½/2X4- ₋	NPL1½/2X5- ₋	NPL1½/2X6- ₋	NPL1½/2X8- ₋	NPL1½/2X10- ₋	NPL1½/2X12- ₋
2" 53	CLNPL2- ₋	—	NPL2X21/2- ₋	NPL2X3- ₋	NPL2X31/2- ₋	NPL2X4- ₋	NPL2X5- ₋	NPL2X6- ₋	NPL2X8- ₋	NPL2X10- ₋	NPL2X12- ₋
2½" 63	CLNPL2½/2- ₋	—	—	—	NPL2½/2X31/2- ₋	NPL2½/2X4- ₋	NPL2½/2X5- ₋	NPL2½/2X6- ₋	NPL2½/2X8- ₋	NPL2½/2X10- ₋	NPL2½/2X12- ₋
3" 78	CLNPL3- ₋	—	—	—	NPL3X31/2- ₋	NPL3X4- ₋	NPL3X5- ₋	NPL3X6- ₋	NPL3X8- ₋	NPL3X10- ₋	NPL3X12- ₋
3½" 91	CLNPL3½/2- ₋	—	—	—	—	NPL3½/2X4- ₋	NPL3½/2X5- ₋	NPL3½/2X6- ₋	NPL3½/2X8- ₋	NPL3½/2X10- ₋	NPL3½/2X12- ₋
4" 103	CLNPL4- ₋	—	—	—	—	NPL4X4- ₋	NPL4X5- ₋	NPL4X6- ₋	NPL4X8- ₋	NPL4X10- ₋	NPL4X12- ₋
5" 129	CLNPL5- ₋	—	—	—	—	—	NPL5X5- ₋	NPL5X6- ₋	NPL5X8- ₋	NPL5X10- ₋	NPL5X12- ₋
6" 155	CLNPL6- ₋	—	—	—	—	—	NPL6X5- ₋	NPL6X6- ₋	NPL6X8- ₋	NPL6X10- ₋	NPL6X12- ₋

* Metric size designator (ANSI C80.1-1994).

Product Code	Size x Length	Material	Colour
NPL	3/4 x 6	—	—
		Blank = Steel	_ = space for color identifier
		SA = Aluminum	G = Gray 
			W = White 
			B = Blue 
Catalog No. Example:			
NPL3/4X6-G is a ¾" x 6" long steel nipple coated in gray PVC.			
Custom colors also available.			



Ocal-Blue® Nipples (continued)



PVC-coated conduit nipples – Aluminum

Pipe Size (in.) Metric Size*	Nipple Length (in.) (mm)										
	Close	2" 50.8	2½" 63.5	3" 76.2	3½" 88.9	4" 101.6	5" 127.0	6" 152.4	8" 203.2	10" 254.0	12" 304.8
½"	CLNPL1/2SA-	NPL1/2X2SA-	NPL1/2X21/2SA-	NPL1/2X3SA-	NPL1/2X31/2SA-	NPL1/2X4SA-	NPL1/2X5SA-	NPL1/2X6SA-	NPL1/2X8SA-	NPL1/2X10SA-	NPL1/2X12SA-
16											
¾"	CLNPL3/4SA-	NPL3/4X2SA-	NPL3/4X21/2SA-	NPL3/4X3SA-	NPL3/4X31/2SA-	NPL3/4X4SA-	NPL3/4X5SA-	NPL3/4X6SA-	NPL3/4X8SA-	NPL3/4X10SA-	NPL3/4X12SA-
21											
1"	CLNPL1SA-	NPL1X2SA-	NPL1X21/2SA-	NPL1X3SA-	NPL1X31/2SA-	NPL1X4SA-	NPL1X5SA-	NPL1X6SA-	NPL1X8SA-	NPL1X10SA-	NPL1X12SA-
27											
1¼"	CLNPL11/4SA-	NPL11/4X2SA-	NPL11/4X21/2SA-	NPL11/4X3SA-	NPL11/4X31/2SA-	NPL11/4X4SA-	NPL11/4X5SA-	NPL11/4X6SA-	NPL11/4X8SA-	NPL11/4X10SA-	NPL11/4X12SA-
35											
1½"	CLNPL11/2SA-	NPL11/2X2SA-	NPL11/2X21/2SA-	NPL11/2X3SA-	NPL11/2X31/2SA-	NPL11/2X4SA-	NPL11/2X5SA-	NPL11/2X6SA-	NPL11/2X8SA-	NPL11/2X10SA-	NPL11/2X12SA-
41											
2"	CLNPL2SA-	—	NPL2X21/2SA-	NPL2X3SA-	NPL2X31/2SA-	NPL2X4SA-	NPL2X5SA-	NPL2X6SA-	NPL2X8SA-	NPL2X10SA-	NPL2X12SA-
53											
2½"	CLNPL21/2SA-	—	—	—	NPL21/2X31/2SA-	NPL21/2X4SA-	NPL21/2X5SA-	NPL21/2X6SA-	NPL21/2X8SA-	NPL21/2X10SA-	NPL21/2X12SA-
63											
3"	CLNPL3SA-	—	—	—	NPL3X31/2SA-	NPL3X4SA-	NPL3X5SA-	NPL3X6SA-	NPL3X8SA-	NPL3X10SA-	NPL3X12SA-
78											
3½"	CLNPL31/2SA-	—	—	—	—	NPL31/2X4SA-	NPL31/2X5SA-	NPL31/2X6SA-	NPL31/2X8SA-	NPL31/2X10SA-	NPL31/2X12SA-
91											
4"	CLNPL4SA-	—	—	—	—	NPL4X4SA-	NPL4X5SA-	NPL4X6SA-	NPL4X8SA-	NPL4X10SA-	NPL4X12SA-
103											
5"	CLNPL5SA-	—	—	—	—	—	NPL5X5SA-	NPL5X6SA-	NPL5X8SA-	NPL5X10SA-	NPL5X12SA-
129											
6"	CLNPL6SA-	—	—	—	—	—	NPL6X5SA-	NPL6X6SA-	NPL6X8SA-	NPL6X10SA-	NPL6X12SA-
155											

* Metric size designator (ANSI C80.1-1994).

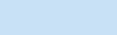
Product Code	Size x Length	Material	Colour
NPL	3/4 x 6	—	—
		Blank = Steel	— = space for color identifier
		SA = Aluminum	G = Gray 
			W = White 
			B = Blue 
Catalog No. Example:	NPL3/4X6-G is a ¾" x 6" long steel nipple coated in gray PVC.		
	Custom colors also available.		

Ocal-Blue® Standard-radius elbows

Factory bent to save time and materials.





Product features

- Fabricated from Ocal® PVC-coated conduit
- Standard radii in 30°, 45°, 60° and 90° available for immediate shipment
- Color-coded thread protectors for easy identification of conduit size

Ocal-Blue® Standard-radius elbows

Product Code		Pipe Size		Radius "R"		Offset "C"		Straight End "D"		Unbent Length		Weight Steel only	
Steel	Aluminium	(in.)	Metric Size Designator*	(in.)	(mm)	(in.)	(mm)	(in.)	(mm)	(in.)	(mm)	(lbs)	(kg)
ELL1/2-_-	ELL1/2-_-SA-	1/2	16	4.00	101.60	6.00	152.40	2.00	50.80	10.28	261.19	0.67	16.95
ELL3/4-_-	ELL3/4-_-SA-	3/4	21	4.50	114.30	6.50	165.10	2.00	50.80	11.07	281.14	0.95	24.07
ELL1-_-	ELL1-_-SA-	1	27	5.75	146.05	8.00	203.20	2.25	57.15	13.53	343.71	1.77	44.97
ELL11/4-_-	ELL11/4-_-SA-	1 1/4	35	7.25	184.15	9.50	241.30	2.25	57.15	15.89	403.56	2.55	64.80
ELL11/2-_-	ELL11/2-_-SA-	1 1/2	41	8.25	209.55	11.00	279.40	2.75	69.85	18.46	468.86	3.98	101.13
ELL2-_-	ELL2-_-SA-	2	53	9.50	241.30	13.00	330.20	3.50	88.90	21.92	556.83	6.33	160.86
ELL21/2-_-	ELL21/2-_-SA-	2 1/2	63	10.50	266.70	14.00	355.60	3.50	88.90	23.49	596.73	9.65	245.09
ELL3-_-	ELL3-_-SA-	3	78	13.00	330.20	16.50	419.10	3.50	88.90	27.42	696.48	15.42	391.77
ELL31/2-_-	ELL31/2-_-SA-	3 1/2	91	15.00	381.00	20.75	527.05	5.75	146.05	35.06	890.57	23.30	591.84
ELL4-_-	ELL4-_-SA-	4	103	16.00	406.40	21.75	552.45	5.75	146.05	36.63	930.47	29.68	753.80
ELL5-_-	ELL5-_-SA-	5	129	24.00	609.60	31.00	787.40	7.00	177.80	51.70	1313.16	60.82	1544.89
ELL6-_-	ELL6-_-SA-	6	155	30.00	762.00	39.00	990.60	9.00	228.60	65.12	1654.15	85.69	2176.51

* Metric size designator (ANSI C80.1-1994).

Product Code	Pipe Size	Angle	Material	Colour
ELL	3/4-	-	-	-
		30 = 30°	Blank = Steel	
		45 = 45°	SA = Aluminum	G = Gray 
		60 = 60°		W = White 
		Blank = 90°		B = Blue 
Catalog No. Example:				
NPL3/4X6-G is a 3/4" trade size 90° aluminum elbow coated in white PVC.				
Custom colors also available.				

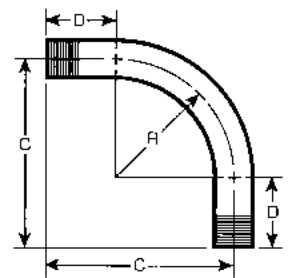

Ocal-Blue® Large-radius elbows

Choose the size and angle to meet your exact requirements





Product features

- Fabricated from Ocal® PVC-coated conduit
- Large radius in 90° available for immediate shipment
- Special radii and angles not listed available upon request
- Color-coded thread protectors for easy identification of conduit size

Ocal-Blue® Large-radius elbows

Product Code		Pipe Size (in.)	Metric Size Designator*	Radius "R"		Offset "C"		Straight End "D"		Unbent Length (mm)	
Steel	Aluminium			(in.)	(mm)	(ft/in.)	(mm)	(in.)	(mm)		(ft/in.)
LRELL_X12-_-	LRELL_X12-_-SA-_-	1-2½	27-63	12.00	304.80	1' 9"	533.40	9.00	228.60	3' 0"	914.40
LRELL_X15-_-	LRELL_X15-_-SA-_-	1-3	27-78	15.00	381.00	2' 0"	609.60	9.00	228.60	3' 6"	1066.80
LRELL_X18-_-	LRELL_X18-_-SA-_-	1-4	27-103	18.00	457.20	2' 4"	711.20	10.00	254.00	4' 0"	1219.20
LRELL_X24-_-	LRELL_X24-_-SA-_-	1-4	27-103	24.00	609.60	2' 11"	889.00	11.00	279.40	4' 11"	1498.60
LRELL_X30-_-	LRELL_X30-_-SA-_-	1-5	27-129	30.00	762.00	3' 5"	1041.40	11.00	279.40	5' 9"	1752.60
LRELL_X36-_-	LRELL_X36-_-SA-_-	1-6	27-155	36.00	914.40	3' 11"	1193.80	11.00	279.40	6' 6"	1981.20
LRELL_X42-_-	LRELL_X42-_-SA-_-	1-6	27-155	42.00	1066.80	4' 6"	1371.60	12.00	304.80	7' 6"	2286.00
LRELL_X48-_-	LRELL_X48-_-SA-_-	1-6	27-155	48.00	1219.20	5' 0"	1524.00	12.00	304.80	8' 6"	2590.80

* Metric size designator (ANSI C80.1-1994).

Product Code	Pipe Size	Radius	Angle	Material	Colour
LRELL	__X	12-	__-	__-	__
			30 = 30°	Blank = Steel	
			45 = 45°	SA = Aluminum	G = Gray 
			60 = 60°		W = White 
			Blank = 90°		B = Blue 

Catalog No. Example:
LRELL3X18-45-G is a 3" trade size steel elbow with radius of 18" and an angle of 45°, coated in gray PVC.
 Custom colors also available.

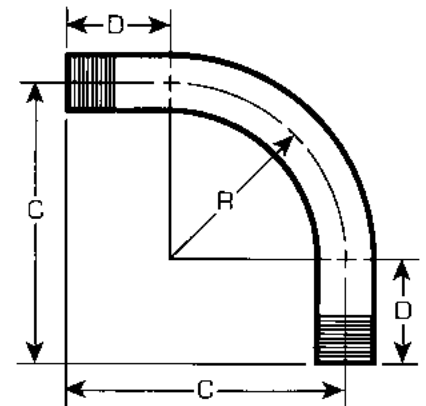

Ocal® PVC-coated beam clamps and U-bolts

PVC coating evenly molded around saddle prevents exposure of metal – an Ocal® exclusive



Parallel (PAR)



Edge (EC)

Product features

- Beam clamps support and attach conduit runs to structural beams
- Molded right-angle beam clamps and U-bolts provide extra protection
- Encapsulated, hex-shaped nuts fit standard wrenches
- Stainless steel hardware included
- Parallel (PAR) and edge (EC) clamps feature nominal .015" (15 mil) PVC coating for corrosion protection
- Right-Angle clamps (RA) and U-Bolts (UB) feature nominal .040" (40 mil) PVC coating for corrosion protection

PVC-coated beam clamps

Product Code			Pipe Size (in.)	Metric Size Designator*
Right Angle	Parallel	Edge		
RA1/2- <u> </u>	PAR1/2- <u> </u>	EC1/2- <u> </u>	1/2	16
RA3/4- <u> </u>	PAR3/4- <u> </u>	EC3/4- <u> </u>	3/4	21
RA1- <u> </u>	PAR1- <u> </u>	EC1- <u> </u>	1	27
RA1-1/4- <u> </u>	PAR1-1/4- <u> </u>	EC1-1/4- <u> </u>	1 1/4	35
RA1-1/2- <u> </u>	PAR1-1/2- <u> </u>	EC1-1/2- <u> </u>	1 1/2	41
RA2- <u> </u>	PAR2- <u> </u>	EC2- <u> </u>	2	53
RA2-1/2- <u> </u>	PAR2-1/2- <u> </u>	—	2 1/2	63
RA3- <u> </u>	PAR3- <u> </u>	—	3	78
RA3-1/2- <u> </u>	PAR3-1/2- <u> </u>	—	3 1/2	91
RA4- <u> </u>	PAR4- <u> </u>	—	4	103

PVC-coated U-bolts

Product Code	Pipe Size (in.)	Metric Size Designator*	"A" Dimension	
			(in.)	(mm)
UB1/2- <u> </u>	1/2	16	1.38	34.93
UB3/4- <u> </u>	3/4	21	1.56	39.69
UB1- <u> </u>	1	27	1.84	46.83
UB1-1/4- <u> </u>	1 1/4	35	2.19	55.56
UB1-1/2- <u> </u>	1 1/2	41	2.50	63.5
UB2- <u> </u>	2	53	2.97	75.41
UB2-1/2- <u> </u>	2 1/2	63	3.47	88.11
UB3- <u> </u>	3	78	4.09	103.98
UB3-1/2- <u> </u>	3 1/2	91	4.59	116.68
UB4- <u> </u>	4	103	5.09	129.38
UB5- <u> </u>	5	129	6.63	168.28
UB6- <u> </u>	6	155	8.00	203.2

Product Code Colour

RA1-

 = space for color identifier

G = Gray

W = White

B = Blue

Custom colors also available.



Right Angle (RA)

Product Code Size Colour

UB 1-

 = space for color identifier

G = Gray

W = White

B = Blue

Custom colors also available.



U-Bolt (UB)

Pipe Straps

Support conduit on walls and structures



Two-hole PVC-coated pipe strap



One-hole PV coated pipe strap

Product features

- Available in malleable iron/stamped steel with nominal .015" (15 mil) PVC coating in your choice of blue, white or gray or in 303 stainless steel
- Choose one- or two-hole versions
- Sized to allow for the extra thickness of the PVC coating

PVC-coated pipe straps

Product Code		Pipe Size (in.)	Metric Size Designator*
One-Hole Malleable Iron	Two-Hole Stamped Steel		
1HMS1/2-_-	2HS1/2-_-	1/2	16
1HMS3/4-_-	2HS3/4-_-	3/4	21
1HMS1-_-	2HS1-_-	1	27
1HMS1-1/4-_-	2HS1-1/4-_-	1 1/4	35
1HMS1-1/2-_-	2HS1-1/2-_-	1 1/2	41
1HMS2-_-	2HS2-_-	2	53
1HMS2-1/2-_-	2HS2-1/2-_-	2 1/2	63
1HMS3-_-	2HS3-_-	3	78
1HMS3-1/2-_-	2HS3-1/2-_-	3 1/2	91
1HMS4-_-	2HS4-_-	4	103



Two-hole stainless steel pipe strap



One-hole stainless steel pipe strap

303 Stainless steel pipe straps for PVC-coated conduit

Product Code		Pipe Size (in.)	Metric Size Designator*	Conduit Strap I.D.		PVC-Coated Conduit O.D.	
One-Hole 303 S.S. Strap	Two-Hole 303 S.S. Strap			(in.)	(mm)	(in.)	(mm)
TS102-SS	TS902-SS	1/2	16	0.92	23.37	0.92	23.37
TS103-SS	TS903-SS	3/4	21	1.16	29.46	1.13	28.70
TS104-SS	TS904-SS	1	27	1.51	38.35	1.40	35.56
TS105-SS	TS905-SS	1 1/4	35	1.74	44.20	1.74	44.20
TS106-SS	TS906-SS	1 1/2	41	2.20	55.88	1.98	50.29
HS107-SS	HS907-SS	2	53	2.88	73.15	2.46	62.48
HS108-SS	HS908-SS	2 1/2	63	3.50	88.90	2.96	75.18
HS109-SS	HS909-SS	3	78	4.00	101.60	3.98	101.09
HS110-SS	HS910-SS	3 1/2	91	4.50	114.30	4.08	103.63

Ocal® PVC-coated clamp-back spacers
 Use as spacers with one-hole pipe straps



Product features

- Provides space for air flow between conduit and mounting surface
- Nominal .015" (15 mil) PVC coating for corrosion protection

Ocal® PVC-coated clamp-back spacers

Product Code	Pipe Size (in.)	Metric Size Designator*
CB1/2- <u> </u>	1/2	16
CB3/4- <u> </u>	3/4	21
CB1- <u> </u>	1	27
CB1-1/4- <u> </u>	1 1/4	35
CB1-1/2- <u> </u>	1 1/2	41
CB2- <u> </u>	2	53
CB2-1/2- <u> </u>	2 1/2	63
CB3- <u> </u>	3	78
CB3-1/2- <u> </u>	3 1/2	91
CB4- <u> </u>	4	103

Product Code	Colour
--------------	--------

CB1-

 = space for color identifier

G = Gray 

W = White 

B = Blue 

Custom colors also available.

Ocal-Blue® Double-coat conduit bodies

Easy access for pulling, splicing, mounting and maintenance

With Ocal-Blue® Double-Coat Conduit Bodies, you can connect sections of conduit – with or without 90° bends – and provide easy access for wire pulling, making splices in branch conductors and for maintenance and future system changes. Conduit bodies can also serve as mounting outlets for wiring devices and lighting fixtures.

01 3/4" T Form 8 conduit body and cover

02 3/4" X Form 7 conduit body and cover

03 2 1/2" LB Form 8 conduit body and cover

04 2 1/2" LB Form 7 conduit body and cover

05 3/4" LB Mark 9 conduit body and cover

Product features

- Type 4X Form 8 (1/2"-2") conduit bodies have injection-molded PVC-coated cover with integral O-ring seal
- Flat surface molded on conduit body seals with molded flange on cover on 2 1/2"-4" Form 8 and all Form 7
- Available in Form 7 and Form 8 ferrous as well as Mark 9 and Form 7 aluminum
- All Ocal-Blue® conduit bodies offer double corrosion protection – both bodies and covers coated inside and out with a nominal .002" (2 mil) blue urethane, then exterior coated with a nominal .040" (40 mil) PVC
- PVC coating in your choice of blue, gray or white with custom colors available

- All threaded hubs fitted with pressure-sealing sleeves
- Conduit bodies ship complete with covers and encapsulated stainless steel screws
- Covers also sold separately for replacement or retrofit purposes

Product Code	Material	Colour
--------------	----------	--------

LB27-

Blank = Ferrous _ = space for color identifier

SA = Aluminum G = Gray

W = White

B = Blue

Catalog No. Example:

LB27-W is a 3/4" LB ferrous conduit body and cover coated in white PVC.

Custom colors also available.



01



02



03



04











05

Ocal-Blue® Conduit bodies





Quick reference guide

Ocal-Blue® Conduit bodies and covers - quick reference

Shape	Style	Size (Inch and Metric Size Designator*)									
		1/2" 16	3/4" 21	1" 27	1 1/4" 35	1 1/2" 41	2" 53	2 1/2" 63	3" 78	3 1/2" 91	4" 103
Ocal-Blue® Conduit bodies											
	Form 7	C17-_	C27-_	C37-_	C47-_	C57-_	C67-_	C77-_	C87-_	—	—
	Form 8	C18-4X-_	C28-4X-_	C38-4X-_	C448-4X-_	C58-4X-_	C68-4X-_	C78-_	C88-_	—	—
	Mark 9	C19-_	C29-_	C39-_	C49-_	C59-_	C69-_	C789-_	C889-_	C989-_	C1089-_
	Form 7 Aluminum	C17SA-_	C27SA-_	C37SA-_	C47SA-_	C57SA-_	C67SA-_	C77SA-_	C87SA-_	—	—
	Form 7	LU17-_	LU27-_	LU37-_	LU47-_	LU57-_	LU67-_	—	—	—	—
	Form 8	LU18-4X-_	LU28-4X-_	LU38-4X-_	LU448-4X-_	LU58-4X-_	LU68-4X-_	—	—	—	—
	Form 7	LB17-_	LB27-_	LB37-_	LB47-_	LB57-_	LB67-_	LB777-_	LB87-_	LB97-_	LB107-_
	Form 8	LB18-4X-_	LB28-4X-_	LB38-4X-_	LB448-4X-_	LB58-4X-_	LB68-4X-_	LB78-_	LB888-_	LB98-_	LB108-_
	Mark 9	LB19-_	LB29-_	LB39-_	LB49-_	LB59-_	LB69-_	LB789-_	LB889-_	LB989-_	LB1089-_
	Form 7 Aluminum	LB17SA-_	LB27SA-_	LB37SA-_	LB47SA-_	LB57SA-_	LB67SA-_	LB777SA-_	LB87SA-_	LB97SA-_	LB107SA-_
	Form 7	LL17-_	LL27-_	LL37-_	LL47-_	LL57-_	LL67-_	LL777-_	LL87-_	LL97-_	LL107-_
	Form 8	LL18-4X-_	LL28-4X-_	LL38-4X-_	LL448-4X-_	LL58-4X-_	LL68-4X-_	LL78-_	LL888-_	—	—
	Mark 9	LL19-_	LL29-_	LL39-_	LL49-_	LL59-_	LL69-_	LL789-_	LL889-_	LL989-_	LL1089-_
	Form 7 Aluminum	LL17SA-_	LL27SA-_	LL37SA-_	LL47SA-_	LL57SA-_	LL67SA-_	LL777SA-_	LL87SA-_	LL97SA-_	LL107SA-_
	Form 7	LR17-_	LR27-_	LR37-_	LR47-_	LR57-_	LR67-_	LR777-_	LR87-_	LR97-_	LR107-_
	Form 8	LR18-4X-_	LR28-4X-_	LR38-4X-_	LR448-4X-_	LR58-4X-_	LR68-4X-_	LR78-_	LR888-_	—	—
	Mark 9	LR19-_	LR29-_	LR39-_	LR49-_	LR59-_	LR69-_	LR789-_	LR889-_	LR989-_	LR1089-_
	Form 7 Aluminum	LR17SA-_	LR27SA-_	LR37SA-_	LR47SA-_	LR57SA-_	LR67SA-_	LR777SA-_	LR87SA-_	LR97SA-_	LR107SA-_
	Form 7	T17-_	T27-_	T37-_	T47-_	T57-_	T67-_	T77-_	T87-_	T97-_	T107-_
	Form 8	T18-4X-_	T28-4X-_	T38-4X-_	T448-4X-_	T58-4X-_	T68-4X-_	T78-_	T88-_	—	—
	Mark 9	T19-_	T29-_	T39-_	T49-_	T59-_	T69-_	T789-_	T889-_	T989-_	T1089-_
	Form 7 Aluminum	T17SA-_	T27SA-_	T37SA-_	T47SA-_	T57SA-_	T67SA-_	T77SA-_	T87SA-_	T97SA-_	T107SA-_
	Form 7	TB17-_	TB27-_	TB37-_	TB47-_	TB57-_	TB67-_	—	—	—	—
	Form 8	TB18-4X-_	TB28-4X-_	TB38-4X-_	TB448-4X-_	TB58-4X-_	TB68-4X-_	—	—	—	—
	Mark 9	TB19-_	TB29-_	TB39-_	TB49-_	—	—	—	—	—	—
	Form 7 Aluminum	TB17SA-_	TB27SA-_	TB37SA-_	TB47SA-_	TB57SA-_	TB67SA-_	—	—	—	—
	Form 7	X17-_	X27-_	X37-_	X47-_	X57-_	X67-_	—	—	—	—
	Form 8	X18-4X-_	X28-4X-_	X38-4X-_	X448-4X-_	X58-4X-_	X68-4X-_	—	—	—	—
	Mark 9	X19-_	X29-_	X39-_	—	—	—	—	—	—	—
	Form 7 Aluminum	X17SA-_	X27SA-_	X37SA-_	X47SA-_	X57SA-_	X67SA-_	—	—	—	—

Note - Fittings shown uncoated

Ocal-Blue® Conduit body covers

	Form 7	170F-_	270F-_	370F-_	470F-_	570F-_	670F-_	870F-_	870F-_	970F-_	970F-_
	Form 8	180F-4X-_	280F-4X-_	380F-4X-_	480F-4X-_	580F-4X-_	680F-4X-_	880F-_	880F-_	980F-_	980F-_
	Mark 9	190-_	290-_	390-_	490-_	590-_	690-_	889-_	889-_	989-_	989-_
	Form 7 Aluminum	170SA-_	270SA-_	370SA-_	470SA-_	570SA-_	670SA-_	870SA-_	870SA-_	970SA-_	970SA-_

* Metric size designator (ANSI C80.1-1994).

Ocal-Blue® Conduit bodies

With covers – C shape

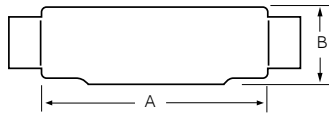

C

C Form 7 Ferrous conduit bodies with covers

Product Code	Hub Size*	Dimensions (in. and mm)**					Vol. Cap. (cu.in./cu.cm.)
		A	B	C	D	E	
C17-	1/2"	5.45	1.40	1.45	0.95	3.20	4.00
	16	138.43	35.56	36.83	24.13	81.28	65.55
C27-	3/4"	6.05	1.60	1.65	1.15	3.80	6.6
	21	153.67	40.64	41.91	29.21	96.52	108.15
C37-	1"	6.75	1.90	1.8	1.35	4.55	10.6
	27	171.45	48.26	45.72	34.29	115.57	173.7
C47-	1 1/4"	7.30	2.30	2.20	1.80	5.00	18.8
	35	185.42	58.42	55.88	45.72	127.00	308.08
C57-	1 1/2"	8.60	2.60	2.45	2.05	5.45	26.4
	41	218.44	66.04	62.23	52.07	138.43	432.62
C67-	2"	9.50	3.20	3.05	2.45	6.40	51.00
	53	241.3	81.28	77.47	62.23	162.56	835.74
C77-	2 1/2"	12.10	3.65	4.25	3.60	8.40	102.00
	63	307.34	92.71	107.95	91.44	213.36	1671.48
C87-	3"	12.10	4.40	4.25	3.60	8.40	132.00
	78	307.34	111.76	107.95	91.44	213.36	2163.09

C Form 8 Ferrous conduit bodies with covers

Product Code	Hub Size*	Dimensions (in. and mm)**					Vol. Cap. (cu.in./cu.cm.)
		A	B	C	D	E	
C18-4X-	1/2"	5.53	1.44	1.38	1.00	3.31	4.90
	16	140.49	36.51	34.93	25.4	84.14	80.3
C28-4X-	3/4"	6.28	1.53	1.19	1.19	3.94	8.00
	21	159.54	38.89	30.16	30.16	100.01	131.1
C38-4X-	1"	7.31	1.94	1.75	1.38	4.56	13.00
	27	185.74	49.21	44.45	34.93	115.89	213.03
C448-4X-	1 1/4"	8.50	2.38	2.19	1.75	5.31	23.50
	35	215.9	60.33	55.56	44.45	134.94	385.1
C58-4X-	1 1/2"	10.38	2.78	2.75	2.13	6.50	45.00
	41	263.53	70.64	69.85	53.98	165.1	737.42
C68-4X-	2"	12.25	3.56	3.75	3.00	8.56	88.00
	53	311.15	90.49	95.25	76.2	217.49	1442.06
C78-	2 1/2"	15.63	4.44	5.00	4.25	10.88	110.00
	63	396.88	112.71	127.00	107.95	276.23	1802.58
C88-	3"	15.63	4.81	5.00	4.25	10.88	110.00
	78	396.88	122.24	127.00	107.95	276.23	1802.58

* Metric size designator (ANSI C80.1-1994).

** Dimensions shown are for uncoated conduit bodies.

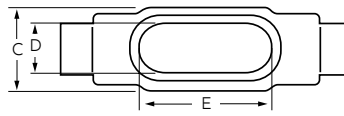

C

C Mark 9 Aluminum conduit bodies with covers

Product Code	Hub Size*	Dimensions (in. and mm)**					Vol. Cap. (cu.in./cu.cm.)
		A	B	C	D	E	
C19-	1/2"	5.00	1.38	1.38	1.19	3.31	—
	16	127	35.05	35.05	30.23	84.07	—
C29-	3/4"	5.69	1.63	1.56	1.38	3.94	—
	21	144.53	41.4	39.62	35.05	100.08	—
C39-	1"	6.59	1.88	1.75	1.50	4.56	—
	27	167.39	47.75	44.45	38.10	115.82	—
C49-	1 1/4"	7.50	2.50	2.19	1.94	5.31	—
	35	190.5	63.5	55.63	49.28	134.87	—
C59-	1 1/2"	8.25	2.75	2.50	2.25	6.00	—
	41	209.55	69.85	63.5	57.15	152.4	—
C69-	2"	10.50	3.44	3.19	2.88	8.06	—
	53	266.7	87.38	81.03	73.15	204.72	—
C789-	2 1/2"	15.63	4.44	5.00	4.25	10.88	—
	63	397.00	112.78	127.00	107.95	276.35	—
C889-	3"	15.63	4.81	5.00	4.25	10.88	—
	78	397.00	122.17	127.00	107.95	276.35	—
C989-	3 1/2"	18.75	5.69	6.25	5.44	13.44	—
	91	476.25	144.53	158.75	138.18	341.38	—
C1089-	4"	18.75	5.94	6.25	5.44	13.44	—
	103	476.25	150.88	158.75	138.18	341.38	—

C Form 7 Aluminum conduit bodies with covers

Product Code	Hub Size*	Dimensions (in. and mm)**					Vol. Cap. (cu.in./cu.cm.)
		A	B	C	D	E	
C17SA-	1/2"	5.45	1.40	1.45	0.95	3.20	4.00
	16	138.43	35.56	36.83	24.13	81.28	65.55
C27SA-	3/4"	6.05	1.60	1.65	1.15	3.80	6.60
	21	153.67	40.64	41.91	29.21	96.52	108.15
C37SA-	1"	6.75	1.90	1.80	1.35	4.55	10.60
	27	171.45	48.26	45.72	34.29	115.57	173.7
C47SA-	1 1/4"	7.30	2.30	2.20	1.80	5.00	18.80
	35	185.42	58.42	55.88	45.72	127.00	308.08
C57SA-	1 1/2"	8.60	2.60	2.45	2.05	5.45	26.40
	41	218.44	66.04	62.23	52.07	138.43	432.62
C67SA-	2"	9.50	3.20	3.05	2.45	6.40	51.00
	53	241.30	81.28	77.47	62.23	162.56	835.74
C77SA-	2 1/2"	12.10	3.65	4.25	3.60	8.40	102.00
	63	307.34	92.71	107.95	91.44	213.36	1671.48
C87SA-	3"	12.10	4.40	4.25	3.60	8.40	132.00
	78	307.34	111.76	107.95	91.44	213.36	2163.09

Ocal-Blue® Conduit bodies

With covers – LB shape

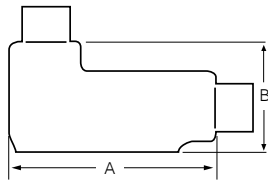

LB

LB Form 7 Ferrous conduit bodies with covers

Product Code	Hub Size*	Dimensions (in. and mm)**					Vol. Cap. (cu.in./cu/cm.)
		A	B	C	D	E	
LB17-_	1/2"	4.60	2.20	1.35	0.95	3.20	4.00
	16	116.84	55.88	34.29	24.13	81.28	65.55
LB27-_	3/4"	5.25	2.40	1.65	1.15	3.80	6.60
	21	133.35	60.96	41.91	29.21	96.52	108.15
LB37-_	1"	6.00	2.65	1.80	1.35	4.55	10.6
	27	152.4	67.31	45.72	34.29	115.57	173.7
LB47-_	1 1/4"	6.45	3.20	2.20	1.80	5.00	18.80
	35	163.83	81.28	55.88	45.72	127.00	308.08
LB57-_	1 1/2"	7.25	3.90	2.45	2.05	5.45	26.400
	41	184.15	99.06	62.23	52.07	138.43	432.62
LB67-_	2"	8.30	4.45	3.10	2.45	6.40	51.00
	53	210.82	113.03	78.74	62.23	162.56	835.74
LB777-_	2 1/2"	10.55	5.20	4.25	3.60	8.40	102.00
	63	267.97	132.08	107.95	91.44	213.36	1671.48
LB87-_	3"	10.55	5.95	4.25	3.60	8.40	132.00
	78	267.97	151.13	107.95	91.44	213.36	2163.09
LB97-_	3 1/2"	12.85	6.70	5.25	4.55	10.25	210.00
	91	326.39	170.18	133.35	115.57	260.35	3441.28
LB107-_	4"	12.85	7.20	5.25	4.55	10.25	243.00
	103	326.39	182.88	133.35	115.57	260.35	3982.06

LB Form 8 Ferrous conduit bodies with covers

Product Code	Hub Size*	Dimensions (in. and mm)**					Vol. Cap. (cu.in./cu/cm.)
		A	B	C	D	E	
LB18-4X-_	1/2"	4.94	2.22	1.38	1.00	3.31	4.90
	16	125.41	56.36	34.93	25.4	84.14	80.3
LB28-4X-_	3/4"	5.56	2.44	1.56	1.19	3.31	8.00
	21	141.29	61.93	39.69	30.16	84.14	131.1
LB38-4X-_	1"	6.50	2.81	1.75	1.38	4.56	13.00
	27	165.1	71.45	44.45	34.93	115.89	213.03
LB448-4X-_	1 1/4"	7.53	3.34	2.19	1.75	5.31	23.50
	35	191.29	84.93	55.56	44.45	134.94	385.1
LB58-4X-_	1 1/2"	9.13	4.03	2.75	2.13	6.50	45.00
	41	231.78	102.39	69.85	53.98	165.1	737.42
LB68-4X-_	2"	11.00	4.41	3.75	3.00	8.56	88.00
	53	279.4	111.92	95.25	76.2	217.49	1442.06
LB78-_	2 1/2"	13.94	6.13	5.00	4.25	10.88	110.00
	63	354.01	155.58	127.00	107.95	276.23	1802.58
LB888-_	3"	13.94	6.50	5.00	4.25	10.88	110.00
	78	354.01	165.1	127.00	107.95	276.23	1802.58
LB98-_	3 1/2"	16.88	7.56	6.25	5.44	13.44	250.00
	91	428.63	192.09	158.75	138.11	341.31	4096.77
LB108-_	4"	16.88	7.81	6.25	5.44	13.44	250.00
	103	428.63	198.44	158.75	138.11	341.31	4096.77

* Metric size designator (ANSI C80.1-1994).

** Dimensions shown are for uncoated conduit bodies.

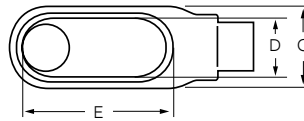

LB

LB Mark 9 Aluminum conduit bodies with covers

Product Code	Hub Size*	Dimensions (in. and mm)**					Vol. Cap. (cu.in./cu/cm.)
		A	B	C	D	E	
LB19-_	1/2"	4.59	2.13	1.38	1.19	3.31	—
	16	116.68	53.98	34.93	30.16	84.14	—
LB29-_	3/4"	5.25	2.41	1.56	1.38	3.94	—
	21	133.35	61.12	39.69	34.93	100.01	—
LB39-_	1"	6.09	2.84	1.75	1.5	4.56	—
	27	154.78	72.23	44.45	38.1	115.89	—
LB49-_	1 1/4"	7.03	3.47	2.19	1.94	5.31	—
	35	178.59	88.11	55.56	49.21	134.94	—
LB59-_	1 1/2"	7.75	3.75	2.50	2.25	6.00	—
	41	196.85	95.25	63.5	57.15	152.4	—
LB69-_	2"	10.03	4.47	3.19	2.88	8.06	—
	53	254.79	113.51	80.96	73.03	204.79	—
LB789-_	2 1/2"	13.94	6.13	5.00	4.25	10.88	—
	63	354.01	155.58	127.00	107.95	276.23	—
LB889-_	3"	13.94	6.50	5.00	4.25	10.88	—
	78	354.01	165.1	127.00	107.95	276.23	—
LB989-_	3 1/2"	16.88	7.56	6.25	5.44	13.44	—
	91	428.63	192.09	158.75	138.11	341.31	—
LB1089-_	4"	16.88	7.81	6.25	5.44	13.44	—
	103	428.63	198.44	158.75	138.11	341.31	—

LB Form 7 Aluminum conduit bodies with covers

Product Code	Hub Size*	Dimensions (in. and mm)**					Vol. Cap. (cu.in./cu/cm.)
		A	B	C	D	E	
LB175A-_	1/2"	4.60	2.20	1.35	0.95	3.20	4.00
	16	116.84	55.88	34.29	24.13	81.28	65.55
LB275A-_	3/4"	5.25	2.40	1.65	1.15	3.80	6.60
	21	133.35	60.96	41.91	29.21	96.52	108.15
LB375A-_	1"	6.00	2.65	1.80	1.35	4.55	10.60
	27	152.4	67.31	45.72	34.29	115.57	173.7
LB475A-_	1 1/4"	6.45	3.20	2.20	1.80	5.00	18.80
	35	163.83	81.28	55.88	45.72	127.00	308.08
LB575A-_	1 1/2"	7.25	3.90	2.45	2.05	5.45	26.40
	41	184.15	99.06	62.23	52.07	138.43	432.62
LB675A-_	2"	8.30	4.45	3.10	2.45	6.40	51.00
	53	210.82	113.03	78.74	62.23	162.56	835.74
LB7775A-_	2 1/2"	10.55	5.20	4.25	3.60	8.40	102.00
	63	267.97	132.08	107.95	91.44	213.36	1671.48
LB875A-_	3"	10.55	5.95	4.25	3.60	8.40	132.00
	78	267.97	151.13	107.95	91.44	213.36	2163.09
LB975A-_	3 1/2"	12.85	6.70	5.25	4.55	10.25	210.00
	91	326.39	170.18	133.35	115.57	260.35	3441.28
LB1075A-_	4"	12.85	7.20	5.25	4.55	10.25	243.00
	103	326.39	182.88	133.35	115.57	260.35	3982.06

Ocal-Blue® Conduit bodies

With covers – LL shape

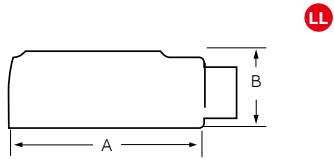

LL Form 7 Ferrous conduit bodies with covers

Product Code	Hub Size*	Dimensions (in. and mm)**					Vol. Cap. (cu.in./cu.cm.)
		A	B	C	D	E	
LL17-_	1/2"	4.60	1.40	1.45	0.95	3.20	4.00
	16	116.84	35.56	36.83	24.13	81.28	65.55
LL27-_	3/4"	5.25	1.60	1.65	1.15	3.80	6.60
	21	133.35	40.64	41.91	29.21	96.52	108.15
LL37-_	1"	6.00	1.90	2.60	1.35	4.55	10.60
	27	152.40	48.26	66.04	34.29	115.57	173.70
LL47-_	1 1/4"	6.45	2.30	3.05	1.80	5.00	18.60
	35	163.83	58.42	77.47	45.72	127.00	304.8
LL57-_	1 1/2"	7.90	2.60	3.80	2.05	5.45	26.40
	41	200.66	66.04	96.52	52.07	138.43	432.62
LL67-_	2"	8.30	3.20	4.25	2.45	6.40	51.00
	53	210.82	81.28	107.95	62.23	162.56	835.74
LL777-_	2 1/2"	10.55	3.65	5.80	3.60	8.40	102.00
	63	267.97	92.71	147.32	91.44	213.36	1671.48
LL87-_	3"	10.55	4.40	5.80	3.60	8.40	132.00
	78	267.97	111.76	147.32	91.44	213.36	2163.09
LL97-_	3 1/2"	12.85	4.90	7.03	4.55	10.25	210.00
	91	326.39	124.46	178.56	115.57	260.35	3441.28
LL107-_	4"	12.85	5.40	7.03	4.55	10.25	243.00
	103	326.39	137.16	178.56	115.57	260.35	3982.06

LL Form 8 Ferrous conduit bodies with covers

Product Code	Hub Size*	Dimensions (in. and mm)**					Vol. Cap. (cu.in./cu.cm.)
		A	B	C	D	E	
LL18-4X-_	1/2"	4.94	1.44	2.16	1.00	3.31	4.90
	16	125.41	36.51	54.77	25.40	84.14	80.30
LL28-4X-_	3/4"	5.56	1.69	2.31	1.19	3.94	8.00
	21	141.29	42.86	58.74	30.16	100.01	131.10
LL38-4X-_	1"	6.47	1.94	2.63	1.38	4.56	13.00
	27	164.31	49.21	66.68	34.93	115.89	213.03
LL448-4X-_	1 1/4"	7.53	2.38	3.16	1.75	5.31	23.50
	35	191.29	60.33	80.17	44.45	134.94	385.10
LL58-4X-_	1 1/2"	9.13	2.78	4.00	2.13	6.50	45.00
	41	231.78	70.64	101.6	53.98	165.10	737.42
LL68-4X-_	2"	11.00	3.56	5.00	3.00	8.56	88.00
	53	279.4	90.49	127.00	76.20	217.49	1442.06
LL78-_	2 1/2"	13.94	4.44	6.69	4.25	10.88	110.00
	63	354.01	112.71	169.86	107.95	276.23	1802.58
LL888-_	3"	13.94	4.81	6.69	4.25	10.88	110.00
	78	354.01	122.24	169.86	107.95	276.23	1802.58

* Metric size designator (ANSI C80.1-1994).

** Dimensions shown are for uncoated conduit bodies.

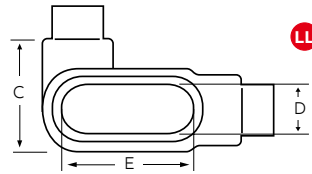

LL Mark 9 Aluminum conduit bodies with covers

Product Code	Hub Size*	Dimensions (in. and mm)**					Vol. Cap. (cu.in./cu.cm.)
		A	B	C	D	E	
LL19-_	1/2"	4.59	1.38	2.13	1.19	3.31	—
	16	116.68	34.93	53.98	30.16	84.14	—
LL29-_	3/4"	5.25	1.63	2.38	1.38	3.94	—
	21	133.35	41.28	60.33	34.93	100.01	—
LL39-_	1"	6.09	1.88	2.63	1.50	4.56	—
	27	154.78	47.63	66.68	38.1	115.89	—
LL49-_	1 1/4"	7.03	2.50	3.09	1.94	5.31	—
	35	178.59	63.5	78.58	49.21	134.94	—
LL59-_	1 1/2"	7.75	2.75	3.44	2.25	6.00	—
	41	196.85	69.85	87.31	57.15	152.4	—
LL69-_	2"	10.03	3.44	4.13	2.88	8.06	—
	53	254.79	87.31	104.78	73.03	204.79	—
LL789-_	2 1/2"	13.94	4.44	6.69	4.25	10.88	—
	63	354.01	112.71	169.86	107.95	276.23	—
LL889-_	3"	13.94	4.81	6.69	4.25	10.88	—
	78	354.08	122.24	169.93	107.95	276.35	—
LL989-_	3 1/2"	16.88	5.69	8.13	5.44	13.44	—
	91	428.63	144.46	206.38	138.11	341.31	—
LL1089-_	4"	16.88	5.94	8.13	5.44	13.44	—
	103	428.63	150.81	206.38	138.11	341.31	—

LL Form 7 Aluminum conduit bodies with covers

Product Code	Hub Size*	Dimensions (in. and mm)**					Vol. Cap. (cu.in./cu.cm.)
		A	B	C	D	E	
LL17SA-_	1/2"	4.60	1.40	1.45	0.95	3.20	4.00
	16	116.84	35.56	36.83	24.13	81.28	65.55
LL27SA-_	3/4"	5.25	1.60	1.65	1.15	3.80	6.60
	21	133.35	40.64	41.91	29.21	96.52	108.15
LL37SA-_	1"	6.00	1.90	2.60	1.35	4.55	10.60
	27	152.40	48.26	66.04	34.29	115.57	173.7
LL47SA-_	1 1/4"	6.45	2.30	3.05	1.80	5.00	18.60
	35	163.83	58.42	77.47	45.72	127.00	304.8
LL57SA-_	1 1/2"	7.90	2.60	3.80	2.05	5.45	26.40
	41	200.66	66.04	96.52	52.07	138.43	432.62
LL67SA-_	2"	8.30	3.20	4.25	2.45	6.40	51.00
	53	210.82	81.28	107.95	62.23	162.56	835.74
LL777SA-_	2 1/2"	10.55	3.65	5.80	3.60	8.40	102.00
	63	267.97	92.71	147.32	91.44	213.36	1671.48
LL87SA-_	3"	10.55	4.40	5.80	3.60	8.40	132.00
	78	267.97	111.76	147.32	91.44	213.36	2163.09
LL97SA-_	3 1/2"	12.85	4.90	7.03	4.55	10.25	210.00
	91	326.39	124.46	178.56	115.57	260.35	3441.28
LL107SA-_	4"	12.85	5.40	7.03	4.55	10.25	243.00
	103	326.39	137.16	178.56	115.57	260.35	3982.06

Ocal-Blue® Conduit bodies

With covers – LR shape

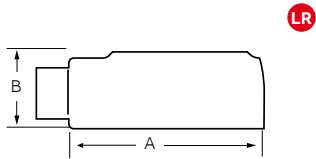

LR Form 7 Ferrous conduit bodies with covers

Product Code	Hub Size*	Dimensions (in. and mm)**					Vol. Cap. (cu.in./cu.cm.)
		A	B	C	D	E	
LR17-	1/2"	4.60	1.40	1.45	0.95	3.20	4.00
	16	116.84	35.56	36.83	24.13	81.28	65.55
LR27-	3/4"	5.25	1.60	1.65	1.15	3.80	6.60
	21	133.35	40.64	41.91	29.21	96.52	108.15
LR37-	1"	6.00	1.90	2.60	1.35	4.55	10.60
	27	152.4	48.26	66.04	34.29	115.57	173.70
LR47-	1 1/4"	6.45	2.30	3.05	1.80	5.00	18.80
	35	163.83	58.42	77.47	45.72	127.00	308.08
LR57-	1 1/2"	7.90	2.60	3.80	2.05	5.45	26.40
	41	200.66	66.04	96.52	52.07	138.43	432.62
LR67-	2"	8.30	3.20	4.25	2.45	6.40	51.00
	53	210.82	81.28	107.95	62.23	162.56	835.74
LR777-	2 1/2"	10.55	3.65	5.80	3.60	8.40	102.00
	63	267.97	92.71	147.32	91.44	213.36	1671.48
LR87-	3"	10.55	4.40	5.80	3.60	8.40	132.00
	78	267.97	111.76	147.32	91.44	213.36	2163.09
LR97-	3 1/2"	12.85	4.90	7.03	4.55	10.25	210.00
	91	326.39	124.46	178.56	115.57	260.35	3441.28
LR107-	4"	12.85	5.40	7.03	4.55	10.25	243.00
	103	326.39	137.16	178.56	115.57	260.35	3982.06

LR Form 8 Ferrous conduit bodies with covers

Product Code	Hub Size*	Dimensions (in. and mm)**					Vol. Cap. (cu.in./cu.cm.)
		A	B	C	D	E	
LR18-4X-	1/2"	4.94	1.44	2.16	1.00	3.31	4.90
	16	125.41	36.51	54.77	25.4	84.14	80.30
LR28-4X-	3/4"	5.56	1.69	2.31	1.19	3.94	8.00
	21	141.29	42.86	58.74	30.16	100.01	131.10
LR38-4X-	1"	6.47	1.94	2.63	1.38	4.56	13.00
	27	164.31	49.21	66.68	34.93	115.89	213.03
LR448-4X-	1 1/4"	7.53	2.38	3.16	1.75	5.31	23.50
	35	191.29	60.33	80.17	44.45	134.94	385.10
LR58-4X-	1 1/2"	9.13	2.78	4.00	2.13	6.50	45.00
	41	231.78	70.64	101.6	53.98	165.10	737.42
LR68-4X-	2"	11.00	3.56	5.00	3.00	8.56	88.00
	53	279.40	90.49	127.00	76.2	217.49	1442.06
LR78-	2 1/2"	13.94	4.44	6.69	4.25	10.88	110.00
	63	354.01	112.71	169.86	107.95	276.23	1802.58
LR888-	3"	13.94	4.81	6.69	4.25	10.88	110.00
	78	354.01	122.24	169.86	107.95	276.23	1802.58

* Metric size designator (ANSI C80.1-1994).

** Dimensions shown are for uncoated conduit bodies.

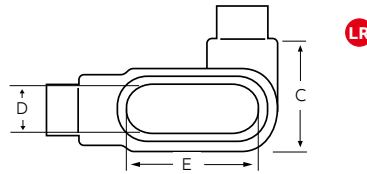

LR Mark 9 Aluminum conduit bodies with covers

Product Code	Hub Size*	Dimensions (in. and mm)**					Vol. Cap. (cu.in./cu.cm.)
		A	B	C	D	E	
LR19-	1/2"	4.59	1.38	2.13	1.19	3.31	—
	16	116.68	34.93	53.98	30.16	84.14	—
LR29-	3/4"	5.25	1.63	2.38	1.38	3.94	—
	21	133.35	41.28	60.33	34.93	100.01	—
LR39-	1"	6.09	1.88	2.63	1.50	4.56	—
	27	154.78	47.63	66.68	38.1	115.89	—
LR49-	1 1/4"	7.03	2.50	3.09	1.94	5.31	—
	35	178.59	63.5	78.58	49.21	134.94	—
LR59-	1 1/2"	7.75	2.75	3.44	2.25	6.00	—
	41	196.85	69.85	87.31	57.15	152.4	—
LR69-	2"	10.03	3.44	4.13	2.88	8.06	—
	53	254.79	87.31	104.78	73.03	204.79	—
LR789-	2 1/2"	13.94	4.44	6.69	4.25	10.88	—
	63	354.01	112.71	169.86	107.95	276.23	—
LR889-	3"	13.94	4.81	6.69	4.25	10.88	—
	78	354.08	122.24	169.93	107.95	276.35	—
LR989-	3 1/2"	16.88	5.69	8.13	5.44	13.44	—
	91	428.63	144.46	206.38	138.11	341.31	—
LR1089-	4"	16.88	5.94	8.13	5.44	13.44	—
	103	428.63	150.81	206.38	138.11	341.31	—

LR Form 7 Aluminum conduit bodies with covers

Product Code	Hub Size*	Dimensions (in. and mm)**					Vol. Cap. (cu.in./cu.cm.)
		A	B	C	D	E	
LR17SA-	1/2"	4.60	1.40	1.45	0.95	3.20	4.00
	16	116.84	35.56	36.83	24.13	81.28	65.55
LR27SA-	3/4"	5.25	1.60	1.65	1.15	3.80	6.60
	21	133.35	40.64	41.91	29.21	96.52	108.15
LR37SA-	1"	6.00	1.90	2.60	1.35	4.55	10.60
	27	152.4	48.26	66.04	34.29	115.57	173.70
LR47SA-	1 1/4"	6.45	2.30	3.05	1.80	5.00	18.80
	35	163.83	58.42	77.47	45.72	127.00	308.08
LR57SA-	1 1/2"	7.9	2.60	3.80	2.05	5.45	26.40
	41	200.66	66.04	96.52	52.07	138.43	432.62
LR67SA-	2"	8.30	3.20	4.25	2.45	6.40	51.00
	53	210.82	81.28	107.95	62.23	162.56	835.74
LR777SA-	2 1/2"	10.55	3.65	5.80	3.60	8.40	102.00
	63	267.97	92.71	147.32	91.44	213.36	1671.48
LR87SA-	3"	10.55	4.40	5.80	3.60	8.40	132.00
	78	267.97	111.76	147.32	91.44	213.36	2163.09
LR97SA-	3 1/2"	12.85	4.9	7.03	4.55	10.25	210.00
	91	326.39	124.46	178.56	115.57	260.35	3441.28
LR107SA-	4"	12.85	5.40	7.03	4.55	10.25	243.00
	103	326.39	137.16	178.56	115.57	260.35	3982.06

Ocal-Blue® Conduit bodies

With covers – T shape

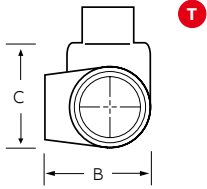

T Form 7 Ferrous conduit bodies with covers

Product Code	Hub Size*	Dimensions (in. and mm)**					Vol. Cap. (cu.in./cu/cm.)
		A	B	C	D	E	
T17_-	1/2"	5.60	1.80	2.35	0.95	3.20	6.00
	16	142.24	45.72	59.69	24.13	81.28	98.32
T27_-	3/4"	6.20	2.00	2.60	1.15	3.80	9.10
	21	157.48	50.80	66.04	29.21	96.52	149.12
T37_-	1"	7.35	2.30	3.10	1.35	4.55	16.90
	27	186.69	58.42	78.74	34.29	115.57	276.94
T47_-	1 1/4"	7.30	2.30	3.05	1.80	5.00	19.30
	35	185.42	58.42	77.47	45.72	127.00	316.27
T57_-	1 1/2"	8.60	2.60	3.80	2.05	5.45	27.50
	41	218.44	66.04	96.52	52.07	138.43	450.64
T67_-	2"	9.50	3.20	4.25	2.45	6.40	50.00
	53	241.3	81.28	107.95	62.23	162.56	819.35
T77_-	2 1/2"	12.10	3.65	5.80	3.60	8.40	102.00
	63	307.34	92.71	147.32	91.44	213.36	1671.48
T87_-	3"	12.10	4.40	5.80	3.60	8.40	132.00
	78	307.34	111.76	147.32	91.44	213.36	2163.09
T97_-	3 1/2"	14.65	4.90	7.05	4.55	10.25	210.00
	91	372.11	124.46	179.07	115.57	260.35	3441.28
T107_-	4"	14.65	5.40	7.05	4.55	10.25	243.00
	103	372.11	137.16	179.07	115.57	260.35	3982.06

T Form 8 Ferrous conduit bodies with covers

Product Code	Hub Size*	Dimensions (in. and mm)**					Vol. Cap. (cu.in./cu/cm.)
		A	B	C	D	E	
T18-4X_-	1/2"	5.69	1.75	2.16	1.00	3.31	6.00
	16	144.46	44.45	54.77	25.4	84.14	98.32
T28-4X_-	3/4"	6.28	2.00	2.31	1.19	3.94	9.00
	21	159.54	50.8	58.74	30.16	100.01	147.48
T38-4X_-	1"	7.31	2.25	2.63	1.38	4.56	15.00
	27	185.74	57.15	66.68	34.93	115.89	245.81
T448-4X_-	1 1/4"	8.50	2.63	3.16	1.75	5.31	24.00
	35	215.9	66.68	80.17	44.45	134.94	393.29
T58-4X_-	1 1/2"	10.38	2.78	4.00	2.13	6.50	46.50
	41	263.53	70.64	101.6	53.98	165.10	762.00
T68-4X_-	2"	12.25	3.56	5.00	3.00	8.56	88.00
	53	311.15	90.49	127.00	76.20	217.49	1442.06
T78_-	2 1/2"	15.63	4.44	6.69	4.25	10.88	110.00
	63	396.88	112.71	169.86	107.95	276.23	1802.58
T88_-	3"	15.63	4.81	6.69	4.25	10.88	110.00
	78	396.88	122.24	169.86	107.95	276.23	1802.58

* Metric size designator (ANSI C80.1-1994).
 ** Dimensions shown are for uncoated conduit bodies.

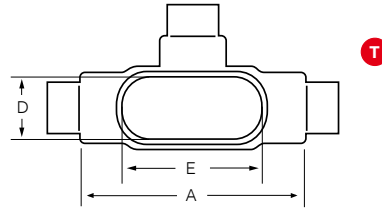

T Mark 9 Aluminum conduit bodies with covers

Product Code	Hub Size*	Dimensions (in. and mm)**					Vol. Cap. (cu.in./cu/cm.)
		A	B	C	D	E	
T19_-	1/2"	50.00	1.38	2.13	1.19	3.31	—
	16	127	34.93	53.98	30.16	84.14	—
T29_-	3/4"	5.69	1.63	2.38	1.38	3.94	—
	21	144.46	41.28	60.33	34.93	100.01	—
T39_-	1"	6.59	1.88	2.63	1.50	4.56	—
	27	167.48	47.63	66.68	38.1	115.89	—
T49_-	1 1/4"	7.50	2.50	3.09	1.94	5.31	—
	35	190.5	63.5	78.58	49.21	134.94	—
T59_-	1 1/2"	8.25	2.75	3.44	2.25	6.00	—
	41	209.55	69.85	87.31	57.15	152.4	—
T69_-	2"	10.5	3.44	4.13	2.88	8.06	—
	53	266.7	87.31	104.78	73.03	204.79	—
T789_-	2 1/2"	15.63	4.44	6.69	4.25	10.88	—
	63	396.88	112.71	169.86	107.95	276.23	—
T889_-	3"	15.63	4.81	6.69	4.25	10.88	—
	78	396.88	122.24	169.86	107.95	276.23	—
T989_-	3 1/2"	18.75	5.69	8.13	5.44	13.44	—
	91	476.25	144.46	206.38	138.11	341.31	—
T1089_-	4"	18.75	5.94	8.13	5.44	13.44	—
	103	476.25	150.81	206.38	138.11	341.31	—

T Form 7 Aluminum conduit bodies with covers

Product Code	Hub Size*	Dimensions (in. and mm)**					Vol. Cap. (cu.in./cu/cm.)
		A	B	C	D	E	
T17SA_-	1/2"	5.60	1.80	2.35	0.95	3.20	6.00
	16	142.24	45.72	59.69	24.13	81.28	98.32
T27SA_-	3/4"	6.20	2.00	2.60	1.15	3.80	9.10
	21	157.48	50.8	66.04	29.21	96.52	149.12
T37SA_-	1"	7.35	2.30	3.10	1.35	4.55	16.90
	27	186.69	58.42	78.74	34.29	115.57	276.94
T47SA_-	1 1/4"	7.30	2.30	3.05	1.80	5.00	19.3
	35	185.42	58.42	77.47	45.72	127	316.27
T57SA_-	1 1/2"	8.60	2.60	3.80	2.05	5.45	27.50
	41	218.44	66.04	96.52	52.07	138.43	450.64
T67SA_-	2"	9.50	3.20	4.25	2.45	6.4	50.00
	53	241.3	81.28	107.95	62.23	162.56	819.35
T77SA_-	2 1/2"	12.10	3.65	5.80	3.60	8.40	102.00
	63	307.34	92.71	147.32	91.44	213.36	1671.48
T87SA_-	3"	12.1	4.40	5.80	3.60	8.40	132.00
	78	307.34	111.76	147.32	91.44	213.36	2163.09
T97SA_-	3 1/2"	14.65	4.90	7.05	4.55	10.25	210.00
	91	372.11	124.46	179.07	115.57	260.35	3441.28
T107SA_-	4"	14.65	5.40	7.05	4.55	10.25	243.00
	103	372.11	137.16	179.07	115.57	260.35	3982.06

Ocal-Blue® Conduit bodies

With covers – TB and LU shapes

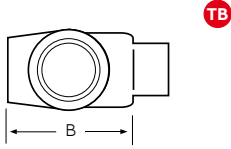

TB

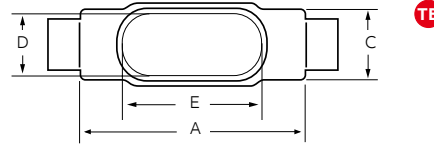

TB

TB Form 7 Ferrous conduit bodies with covers

Product Code	Hub Size*	Dimensions (in. and mm)**					Vol. Cap. (cu.in./cu/cm.)
		A	B	C	D	E	
TB17- ₋	1/2"	5.60	2.06	1.63	0.95	3.20	6.00
	16	142.24	52.32	41.4	24.13	81.28	98.32
TB27- ₋	3/4"	6.20	2.31	1.81	1.15	3.80	9.10
	21	157.48	58.67	45.97	29.21	96.52	149.12
TB37- ₋	1"	7.35	2.50	2.31	1.35	4.55	16.90
	27	186.69	63.5	58.67	34.29	115.57	276.94
TB47- ₋	1 1/4"	7.30	3.19	2.25	1.80	5.00	19.30
	35	185.42	81.03	57.15	45.72	127.00	316.27
TB57- ₋	1 1/2"	8.60	3.91	2.42	2.05	5.45	27.50
	41	218.44	99.31	61.47	52.07	138.43	450.64
TB67- ₋	2"	9.50	4.50	3.06	2.45	6.40	52.80
	53	241.30	114.30	77.72	62.23	162.56	865.24

TB Mark 9 Aluminum conduit bodies with covers

Product Code	Hub Size*	Dimensions (in. and mm)**					Vol. Cap. (cu.in./cu/cm.)
		A	B	C	D	E	
TB19- ₋	1/2"	5.00	2.13	1.38	1.19	3.31	—
	16	127.00	53.98	34.93	30.16	84.14	—
TB29- ₋	3/4"	5.69	2.41	1.56	1.38	3.94	—
	21	144.46	61.12	39.69	34.93	100.01	—
TB39- ₋	1"	6.59	2.84	1.75	1.50	4.56	—
	27	167.48	72.23	44.45	38.1	115.89	—
TB49- ₋	1 1/4"	7.50	3.47	2.19	1.94	5.31	—
	35	190.50	88.11	55.56	49.21	134.94	—

TB Form 8 Ferrous conduit bodies with covers

Product Code	Hub Size*	Dimensions (in. and mm)**					Vol. Cap. (cu.in./cu/cm.)
		A	B	C	D	E	
TB18-4X- ₋	1/2"	5.69	2.63	1.38	1.00	3.31	6.00
	16	144.46	66.68	34.93	25.40	84.14	98.32
TB28-4X- ₋	3/4"	6.28	2.88	1.19	1.19	3.94	9.00
	21	159.54	73.03	30.16	30.16	100.01	147.48
TB38-4X- ₋	1"	7.31	3.25	1.75	1.38	4.56	15.00
	27	185.74	82.55	44.45	34.93	115.89	245.81
TB448-4X- ₋	1 1/4"	8.50	3.31	2.19	1.75	5.31	24.00
	35	215.90	84.14	55.56	44.45	134.94	393.29
TB58-4X- ₋	1 1/2"	10.38	3.69	2.75	2.13	6.50	46.05
	41	263.53	93.66	69.85	53.98	165.10	762.00
TB68-4X- ₋	2"	12.25	4.25	3.75	3.00	8.56	88.00
	53	311.15	107.95	95.25	76.2	217.49	1442.06

TB Form 7 Aluminum conduit bodies with covers

Product Code	Hub Size*	Dimensions (in. and mm)**					Vol. Cap. (cu.in./cu/cm.)
		A	B	C	D	E	
TB17SA- ₋	1/2"	5.60	2.06	1.63	0.95	3.20	6.00
	16	142.24	52.32	41.4	24.13	81.28	98.32
TB27SA- ₋	3/4"	6.20	2.31	1.81	1.15	3.80	9.10
	21	157.48	58.67	45.97	29.21	96.52	149.12
TB37SA- ₋	1"	7.35	2.50	2.31	1.35	4.55	16.90
	27	186.69	63.5	58.67	34.29	115.57	276.94
TB47SA- ₋	1 1/4"	7.30	3.19	2.25	1.80	5.00	19.30
	35	185.42	81.03	57.15	45.72	127.00	316.27
		8.60	3.91	2.42	2.05	5.45	27.50
		218.44	99.31	61.47	52.07	138.43	450.64
		9.50	4.50	3.06	2.45	6.40	52.80
		241.3	114.3	77.72	62.23	162.56	865.24

* Metric size designator (ANSI C80.1-1994).

** Dimensions shown are for uncoated conduit bodies.

LU Form 7 Ferrous conduit bodies with covers

Product Code	Hub Size*	Dimensions (in.)					cu.in.
		A	B	C	D	E	
LU17- ₋	1/2"	5.54	1.45	2.72	0.95	3.20	4.80
LU27- ₋	3/4"	6.22	1.70	3.07	1.15	3.80	7.60
LU37- ₋	1"	7.34	1.97	3.52	1.35	4.55	13.4
LU47- ₋	1 1/4"	8.40	2.47	4.21	1.80	5.00	23.00
LU57- ₋	1 1/2"	8.95	2.72	4.44	2.05	5.45	28.30
LU67- ₋	2"	10.61	3.43	5.43	2.45	6.40	56.00

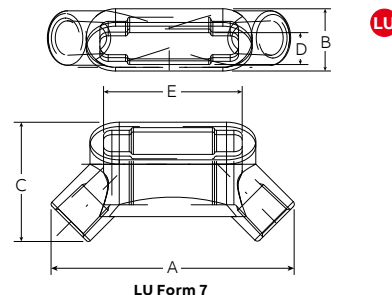

LU

LU Form 7

Ocal-Blue® Conduit bodies

With covers – X shape

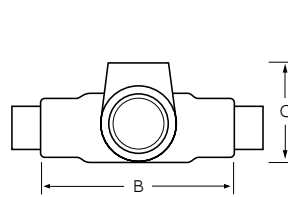
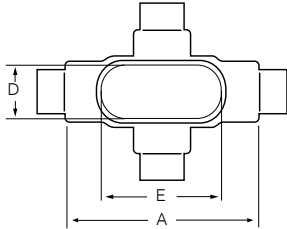

X Form 7 Ferrous conduit bodies with covers

Product Code	Hub Size*	Dimensions (in. and mm)**					Vol. Cap. (cu.in./cu/cm.)
		A	B	C	D	E	
X17- ₋	1/2"	5.60	1.80	3.05	0.95	3.20	6.00
	16	142.24	45.72	77.47	24.13	81.28	98.32
X27- ₋	3/4"	6.20	2.00	3.30	1.15	3.80	9.10
	21	157.48	50.8	83.82	29.21	96.52	149.12
X37- ₋	1"	7.35	2.30	3.80	1.35	4.55	16.90
	27	186.69	58.42	96.52	34.29	115.57	276.94
X47- ₋	1 1/4"	7.30	2.30	3.85	1.80	5.00	19.30
	35	185.42	58.42	97.79	45.72	127.00	316.27
X57- ₋	1 1/2"	8.60	2.60	5.05	2.05	5.45	27.50
	41	218.44	66.04	128.27	52.07	138.43	450.64
X67- ₋	2"	9.50	3.20	5.45	2.45	6.40	52.80
		241.3	81.28	138.43	62.23	162.56	865.24

X Mark 9 Aluminum conduit bodies with covers

Product Code	Hub Size*	Dimensions (in. and mm)**					Vol. Cap. (cu.in./cu/cm.)
		A	B	C	D	E	
X19- ₋	1/2"	5.69	2.91	1.75	1.00	3.31	—
	16	144.46	73.82	44.45	25.40	84.14	—
X29- ₋	3/4"	6.28	3.06	2.00	1.19	3.94	—
	21	159.54	77.79	50.8	30.16	100.01	—
X39- ₋	1"	7.31	3.50	2.25	1.38	4.56	—
	27	185.74	88.9	57.15	34.93	115.89	—

X Form 8 Ferrous conduit bodies with covers

Product Code	Hub Size*	Dimensions (in. and mm)**					Vol. Cap. (cu.in./cu/cm.)
		A	B	C	D	E	
X18-4X- ₋	1/2"	5.69	1.75	2.91	1.00	3.31	6.00
	16	144.46	44.45	73.82	25.4	84.14	98.32
X28-4X- ₋	3/4"	6.28	2.00	3.06	1.38	3.94	9.00
	21	159.54	50.8	77.79	34.93	100.01	147.48
X38-4X- ₋	1"	7.31	2.25	3.50	1.38	4.56	15.00
	27	185.74	57.15	88.9	34.93	115.89	245.81
X448-4X- ₋	1 1/4"	8.50	2.63	4.13	1.75	5.31	24.00
	35	215.9	66.68	104.78	44.45	134.94	393.29
X58-4X- ₋	1 1/2"	10.38	2.47	5.25	2.13	6.50	46.50
	41	263.53	62.71	133.35	53.98	165.1	762.00
X68-4X- ₋	2"	12.25	3.56	6.25	3.00	8.56	88.00
	53	311.15	90.49	158.75	76.20	217.49	1442.06

X Form 7 Aluminum conduit bodies with covers

Product Code	Hub Size*	Dimensions (in. and mm)**					Vol. Cap. (cu.in./cu/cm.)
		A	B	C	D	E	
X17SA- ₋	1/2"	5.60	1.80	3.05	0.95	3.20	6.00
	16	142.24	45.72	77.47	24.13	81.28	98.32
X27SA- ₋	3/4"	6.20	2.00	3.30	1.15	3.80	9.10
	21	157.48	50.80	83.82	29.21	96.52	149.12
X37SA- ₋	1"	7.35	2.30	3.80	1.35	4.55	16.90
	27	186.69	58.42	96.52	34.29	115.57	276.94
X47SA- ₋	1 1/4"	7.30	2.30	3.85	1.80	5.00	19.30
	35	185.42	58.42	97.79	45.72	127.00	316.27
X57SA- ₋	1 1/2"	8.60	2.60	5.05	2.05	5.45	27.50
	41	218.44	66.04	128.27	52.07	138.43	450.64
X67SA- ₋	2"	9.50	3.20	5.45	2.45	6.40	52.80
	53	241.3	81.28	138.43	62.23	162.56	865.24

* Metric size designator (ANSI C80.1-1994).

** Dimensions shown are for uncoated conduit bodies.

Ocal-Blue® Double-coat pulling elbows

Make 90° bends while allowing straight pulls



LBD2200-G

LBD and LBH bodies are installed at 90° bends in rigid conduit to act as pull outlets for conductors that are stiff due to large size or type of insulation and to make 90° bends in conduit system while allowing straight wire pulls in either direction.

Product features

- Choose LBD series for ordinary locations and LBH series for hazardous locations
- Coated with a nominal .002" (2 mil) blue urethane on both interior and exterior
- Nominal .040" (40 mil) PVC coating bonded to exterior
- Pressure-sealing sleeves seal connections

Ocal-Blue® Double-coat pulling elbows

Ordinary LBD Series Product Code	Hazardous LBH Series** Product Code	Pipe Size (in.)	Metric Size Designator*
LBD1100- <u> </u>	LBH10- <u> </u>	1/2	16
LBD2200- <u> </u>	LBH20- <u> </u>	3/4	21
LBD3300- <u> </u>	LBH30- <u> </u>	1	27
LBD4400- <u> </u>	LBH40- <u> </u>	1 1/4	35
LBD5500- <u> </u>	LBH50- <u> </u>	1 1/2	41
LBD6600- <u> </u>	LBH60- <u> </u>	2	53
LBD7700- <u> </u>	LBH70- <u> </u>	2 1/2	63
LBD8800- <u> </u>	LBH80- <u> </u>	3	78
LBD9900- <u> </u>	LBH90- <u> </u>	3 1/2	91
LBD10900- <u> </u>	LBH100- <u> </u>	4	103
LBD012- <u> </u>	—	5	129
LBD014- <u> </u>	—	6	15

* Metric size designator (ANSI C80.1-1994).

** Ratings prior to PVC coating

Product Code Colour

LBD1100-

 = space for color identifier

G = Gray

W = White

B = Blue

Custom colors also available.

Ocal-Blue® Double-coat mogul fittings

Make 90° bends while allowing straight pulls



BC3-G Mogul



BLB4-G Mogul



BUB3-G Mogul



BG48-G Replacement Cover

Install mogul fittings in conduit systems to act as pull outlets for conductors that are stiff due to large size or type of installation, to provide the longer openings needed when pulling large conductors, to prevent sharp bends and kinks in large conductors or to provide more splicing space.

Product features

- Nominal .002" (2 mil) blue urethane on both interior and exterior
- Nominal .040" (40 mil) PVC coating bonded to exterior
- Pressure-sealing sleeves protect connections

Ocal-Blue® Double-coat mogul fittings

MOGUL FITTING WITH COVER AND GASKET

BC Product Code	BLB Product Code	BUB Product Code	BLB Product Code	Replacement Cover Bg Product Code	Pipe Size (in.)	Metric Size Designator*
BC3- _	BLB3- _	BUB3- _	BT3- _	BG48- _	1	27
BC4- _	BLB4- _	BUB4- _	BT4- _	BG48- _	1¼	35
BC5- _	BLB5- _	BUB5- _	BT5- _	BG68- _	1½	41
BC6- _	BLB6- _	BUB6- _	BT6- _	BG68- _	2	53
BC7- _	BLB7- _	BUB7- _	BT7- _	BG88- _	2½	63
BC8- _	BLB8- _	BUB8- _	BT8- _	BG88- _	3	78
BC9- _	BLB9- _	BUB9- _	BT9- _	BG98- _	3½	91
BC10- _	BLB10- _	BUB10- _	BT10- _	BG98- _	4	103

* Metric size designator (ANSI C80.1-1994).

Product Code	Colour
--------------	--------

BC3-

_ = space for color identifier

G = Gray 

W = White 

B = Blue 

Custom colors also available.

Ocal-Blue® Double-coat service entrance elbows

Make 90° bends in limited space



LBY25-G

LBY Series elbows are installed in conduit systems to make 90° bends where space is limited, to act as pull outlets and to provide access to conductors for maintenance and future system changes.

Product features

- Nominal .002" (2 mil) blue urethane on both interior and exterior
- Nominal .040" (40 mil) PVC coating bonded to exterior
- Pressure-sealing sleeves protect connections

Ocal-Blue® Double-coat service entrance elbows



Product Code	Pipe Size (in.)	Metric Size Designator*
LBY15- <u> </u>	1/2	16
LBY25- <u> </u>	3/4	21
LBY35- <u> </u>	1	27
LBY45- <u> </u>	1 1/4	35
LBY55- <u> </u>	1 1/2	41

* Metric size designator (ANSI C80.1-1994).

Product Code Colour

LBY15-

 = space for color identifier

- G = Gray 
- W = White 
- B = Blue 

Custom colors also available.

Ocal-Blue® Double-coat malleable elbows

End or change directions in conduit runs



Ocal-Blue® Double-coat malleable elbows

90° Male Product Code	90° Female Product Code	90° Male-Female Product Code	45° Female Product Code	Pipe Size (in.)	Metric Size Designator*
EL195- <u> </u>	EL19- <u> </u>	EL196- <u> </u>	EL1- <u> </u>	1/2	16
EL295- <u> </u>	EL29- <u> </u>	EL296- <u> </u>	EL2- <u> </u>	3/4	21
EL395- <u> </u>	EL39- <u> </u>	EL396- <u> </u>	EL3- <u> </u>	1	27
	EL49- <u> </u>	EL496- <u> </u>	EL4- <u> </u>	1 1/4	35
	EL59- <u> </u>		EL5- <u> </u>	1 1/2	41
	EL69- <u> </u>		EL6- <u> </u>	2	53
	EL79- <u> </u>		EL7- <u> </u>	2 1/2	63
			EL8- <u> </u>	3	78
LBY45- <u> </u>			EL9- <u> </u>	3 1/2	91
LBY55- <u> </u>			EL10- <u> </u>	4	103

* Metric size designator (ANSI C80.1-1994).

EL Series elbows are installed at the end of conduit runs, in a box or a fitting hub to allow direction change in threaded rigid conduit run by 45° or 90° or when terminating at a box or fitting.

Product features

- Nominal .002" (2 mil) blue urethane on both interior and exterior
- Nominal .040" (40 mil) PVC coating bonded to exterior
- Pressure-sealing sleeves protect connections

Product Code Colour

EL195-

 = space for color identifier

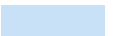
- G = Gray 
- W = White 
- B = Blue 

Custom colors also available.

Ocal-Blue® Double-coat

Unique sealing ring and groove design for optimum performance



HUB1-1/4-G
PVC-Coated Zinc Hub

STG6-G
PVC-Coated Zinc Grounded Hub

Product features

- Captive sealing ring won't buckle or slip during installation and provides a complete 360° seal – even when conduit isn't perpendicular to the enclosure
- Hexagonal/splined body and locknut enable fast and easy installation
- Insulated throat molded from 105° C-rated thermoplastic, UL94V0 flammability rated
- Sharper and deeper teeth provide a more penetrating bite for improved bonding to the enclosure
- Zinc or copper-free aluminum with a nominal .040" (40 mil) PVC coating bonded to exterior – in blue, white, gray or custom colors
- Pressure-sealing sleeves help protect your connections

Knockout hubs

PVC Coated Zinc Hub Product Code	PVC Coated Aluminum Hub Product Code	PVC Coated Zinc Grounded Hub Product Code	Pipe Size (in.)	Metric Size Designator*	Dimensions (Uncoated Hub)									
					A (Overall Diameter)		B		C		D (Max. Panel Thickness)		E (Throat Diameter)	
(in.)	(mm)	(in.)	(mm)	(in.)	(mm)	(in.)	(mm)	(in.)	(mm)	(in.)	(mm)	(in.)	(mm)	
HUB1/2-	HUB1/2SA-	STG1-	1/2	16	1.44	36.58	1.56	39.62	0.88	22.35	0.19	4.83	0.59	14.99
HUB3/4-	HUB3/4SA-	STG2-	3/4	21	1.44	36.58	1.59	40.39	0.91	23.11	0.19	4.83	0.78	19.81
HUB1-	HUB1SA-	STG3-	1	27	2.00	50.80	1.81	45.97	1.06	26.92	0.25	6.35	1.00	25.40
HUB1-1/4-	HUB1-1/4SA-	STG4-	1 1/4	35	2.38	60.45	1.88	47.75	1.06	26.92	0.25	6.35	1.31	33.27
HUB1-1/2-	HUB1-1/2SA-	STG5-	1 1/2	41	2.75	69.85	1.88	47.75	1.06	26.92	0.25	6.35	1.53	38.86
HUB2-	HUB2SA-	STG6-	2	53	3.25	82.55	1.94	49.28	1.16	29.46	0.25	6.35	1.97	50.04
HUB2-1/2-	HUB2-1/2SA-	STG7-	2 1/2	63	3.75	95.25	2.56	65.02	1.56	39.62	0.25	6.35	2.41	61.21
HUB3-	HUB3SA-	STG8-	3	78	4.38	111.25	2.44	61.98	1.59	40.39	0.25	6.35	2.97	75.44
HUB3-1/2-	HUB3-1/2SA-	STG9-	3 1/2	91	5.00	127.00	2.72	69.09	1.63	41.40	0.25	6.35	3.41	86.61
HUB4-	HUB4SA-	STG10-	4	103	5.50	139.70	2.72	69.09	1.63	41.40	0.25	6.35	3.88	98.55
HUB5-	HUB5SA-	STG11-	5	129	6.88	174.75	3.03	76.96	1.94	49.28	0.25	6.35	4.94	125.48
HUB6-	HUB6SA-	STG12-	6	155	7.69	195.33	3.16	80.26	2.00	50.80	0.31	7.87	6.00	152.40

Product Code Colour

HUB1-

_ = space for color identifier

G = Gray

W = White

B = Blue

Custom colors also available.



ABB Grounding and bonding locknuts for hubs



Product features

- Available in zinc, copper-free aluminum
- UL® File No. E-3060, CSA File No. 4484
- Use as replacement locknuts for the hubs featured opposite

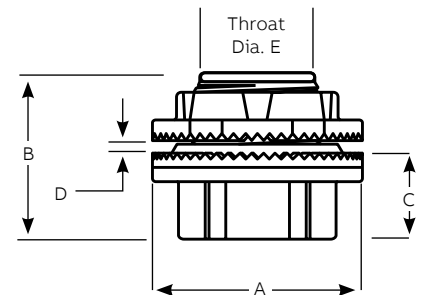
ABB Grounding and bonding locknuts for hubs



Zinc Product Code	Aluminum Product Code	Pipe Size (in.)	Metric Size Designator*	Diameter		Height		Ground Screw	Max. Cond. Size	
				(in.)	(mm)	(in.)	(mm)		AWG	(sq. mm)
L050GR-TB	L050GRA-TB	1/2	16	1.50	38.10	0.41	10.41	#10-32 x 1/4"	#10	6
L075GR-TB	L075GRA-TB	3/4	21	1.69	42.93	0.41	10.41	#10-32 x 1/4"	#10	6
L100GR-TB	L100GRA-TB	1	27	2.00	50.80	0.41	10.41	#10-32 x 1/4"	#10	6
L125GR-TB	L125GRA-TB	1 1/4	35	2.38	60.45	0.47	11.94	1/4-20 x 1/4"	#10	6
L150GR-TB	L150GRA-TB	1 1/2	41	2.75	69.85	0.47	11.94	1/4-20 x 5/16"	#8	10
L200GR-TB	L200GRA-TB	2	53	3.25	82.55	0.47	11.94	1/4-20 x 5/16"	#8	10
L250GR-TB	L250GRA-TB	2 1/2	63	3.75	95.25	0.69	17.53	1/4-20 x 5/16"	#6	16
L300GR-TB	L300GRA-TB	3	78	4.38	111.25	0.72	18.29	1/4-20 x 5/16"	#6	16
L350GR-TB	L350GRA-TB	3 1/2	91	5.00	127.00	0.72	18.29	1/4-20 x 5/16"	#6	16
L400GR-TB	L400GRA-TB	4	103	5.50	139.70	0.72	18.29	1/4-20 x 5/16"	#4	25
L500GR-TB	L500GRA-TB	5	129	6.63	168.40	0.72	18.29	3/8-16 x 3/8"	#2	35
L600GR-TB	L600GRA-TB	6	155	7.69	195.33	0.72	18.29	3/8-16 x 3/8"	#1	50

Ocal® PVC-coated bulkhead fittings

In bulkhead and through-bulkhead styles



STTB2-G Bulkhead fitting

Product features

- Zinc body and locknut with thermoplastic insulating throat and nitrile sealing ring
- Nominal .040" (40 mil) PVC coating bonded to exterior – in blue, white, gray or custom colors
- Pressure-sealing sleeves protect your connections

Ocal® PVC-coated bulkhead fittings

Bulkhead Fitting Product Code	Through Bulkhead Fitting Product Code	Pipe Size (in.)	Metric Size Designator*	Thread	Height		Diameter		Across Flats		A		B	
					(in.)	(mm)	(in.)	(mm)	(in.)	(mm)	(in.)	(mm)	(in.)	(mm)
STTB1-__	STTTB1-__	1/2	16	1/2-14	1.41	35.72	1.44	36.51	1.00	25.40	.75	19.05	.50	12.70
STTB2-__	STTTB2-__	3/4	21	3/4-14	1.47	37.31	1.69	42.86	1.25	31.75	.78	19.84	.53	13.49
STTB3-__	STTTB3-__	1	27	1-11 1/2	1.69	42.86	2.00	50.80	1.53	38.89	.91	23.02	.59	15.08
STTB4-__	STTTB4-__	1 1/4	35	1 1/4-11 1/2	1.78	45.24	2.38	60.33	1.84	46.83	.91	23.02	.66	16.67
STTB5-__	STTTB5-__	1 1/2	41	1 1/2-11 1/2	1.81	46.04	2.75	69.85	1.13	28.58	.91	23.02	.66	16.67
STTB6-__	STTTB6-__	2	53	2-11 1/2	1.84	46.83	3.25	29.46	2.63	66.68	.94	23.81	.66	16.67
STTB7-__	—	2 1/2	63	2 1/2-8	2.28	57.94	3.75	82.55	3.13	79.38	1.22	30.96	.88	22.23
STTB8-__	—	3	78	3-8	2.56	65.09	4.38	111.13	3.78	96.04	1.19	30.16	.91	23.02
STTB9-__	—	3 1/2	91	3 1/2-8	2.56	65.09	5.00	127.00	4.28	108.74	1.38	34.93	.88	22.23
STTB10-__	—	4	103	4-8	2.56	65.09	5.50	139.70	4.84	123.03	1.38	34.93	.88	22.23
STTB11-__	—	5	129	5-8	2.72	69.06	6.63	168.28	5.91	150.02	1.47	37.31	.88	22.23
STTB12-__	—	6	155	6-8	3.00	76.20	7.69	195.26	7.03	178.58	1.50	38.10	.97	24.61

* Metric size designator (ANSI C80.1-1994). Dimensions shown are for uncoated fittings.

Product Code	Colour
STTB1-	
__ = space for color identifier	
G = Gray	
W = White	
B = Blue	

Custom colors also available.

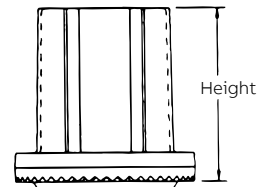
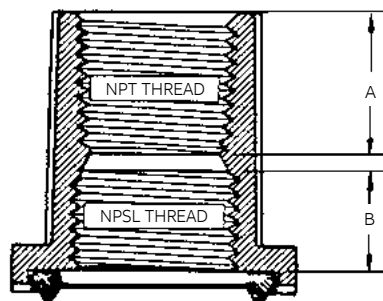

Bulkhead Fitting

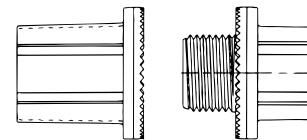

Through-Bulkhead Fitting

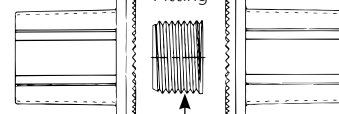

Nipple Nut Not Included

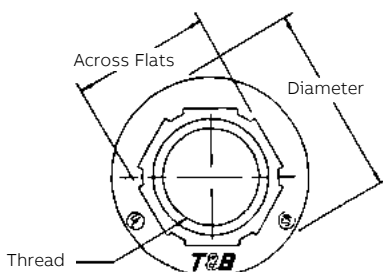

Ocal-Blue® Double-coat reducing couplings

Easily join two different sizes of conduit



REC21-G

Product features

- Integral bushings in both ends prevent damage to wires
- Funnel-shaped interior guides wires from large to small conduit, making them easier to pull
- Nominal .002" (2 mil) blue urethane coating on both interior and exterior
- Nominal .040" (40 mil) PVC coating bonded to exterior
- Pressure-sealing sleeves protect connections

Ocal-Blue® Double-coat reducing couplings

Product Code	Pipe Size (in.)	Metric Size Designator*	Pipe Size (in.)	Metric Size Designator*
	A		B	
REC21-__	3/4	21	1/2	16
REC31-__	1	27	1/2	16
REC32-__	1	27	3/4	21
REC42-__	1 1/4	35	3/4	21
REC43-__	1 1/4	35	1	27
REC52-__	1 1/2	41	3/4	21
REC53-__	1 1/2	41	1	27
REC54-__	1 1/2	41	1 1/4	35
REC602-__	2	53	3/4	21

Product Code	Pipe Size (in.)	Metric Size Designator*	Pipe Size (in.)	Metric Size Designator*
	A		B	
REC603-__	2	21	1	27
REC604-__	2	27	1 1/4	35
REC605-__	2	27	1 1/2	41
REC75-__	2 1/2	35	1 1/2	41
REC86-__	3	35	2	53
REC97-__	3 1/2	41	2 1/2	63
REC108-__	4	41	3	78
REC01210-__	5	53	4	103

* Metric size designator (ANSI C80.1-1994).

Product Code	Colour
REC21-	
_ = space for color identifier	
G = Gray	
W = White	
B = Blue	
Custom colors also available.	

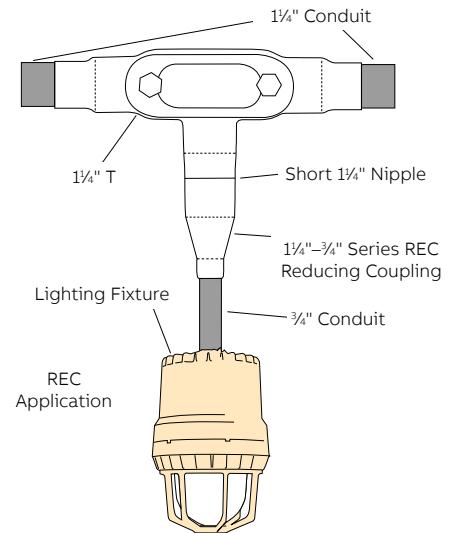

Ocal Blue® Urethane-coated reducing bushings

Reduce a conduit hub to a smaller size



RE32-G

Ocal-Blue® Urethane-coated reducing bushings

Product Code	Pipe Size (in.)	Metric Size Designator*	Pipe Size (in.)	Metric Size Designator*
	A - Male		B - Female	
RE21-G	3/4	21	1/2	16
RE31-G	1	27	1/2	16
RE32-G	1	27	3/4	21
RE41-G	1 1/4	35	1/2	16
RE42-G	1 1/4	35	3/4	21
RE43-G	1 1/4	35	1	21
RE51-G	1 1/2	41	1/2	16
RE52-G	1 1/2	41	3/4	21

Product Code	Pipe Size (in.)	Metric Size Designator*	Pipe Size (in.)	Metric Size Designator*
	A - Male		B - Female	
RE74-G	2 1/2	63	1 1/4	35
RE75-G	2 1/2	63	1 1/2	41
RE76-G	2 1/2	63	2	53
RE83-G	3	78	1	27
RE84-G	3	78	1 1/4	35
RE85-G	3	78	1 1/2	41
RE86-G	3	78	2	53
RE87-G	3	78	2 1/2	63

Product Code	Pipe Size (in.)	Metric Size Designator*	Pipe Size (in.)	Metric Size Designator*
	A - Male		B - Female	
RE53-G	1 1/2	41	1	27
RE54-G	1 1/2	41	1 1/4	16
RE61-G	2	53	1/2	16
RE62-G	2	53	3/4	21
RE63-G	2	53	1	27
RE64-G	2	53	1 1/4	16
RE65-G	2	53	1 1/2	41
RE73-G	2 1/2	63	1	27

Product Code	Pipe Size (in.)	Metric Size Designator*	Pipe Size (in.)	Metric Size Designator*
	A - Male		B - Female	
RE96-G	3 1/2	91	2	53
RE97-G	3 1/2	91	2 1/2	63
RE98-G	3 1/2	91	3	78
RE106-G	4	103	2	53
RE107-G	4	103	2 1/2	63
RE108-G	4	103	3	78

* Metric size designator (ANSI C80.1-1994).

Ocal® PVC-coated XJG rigid conduit expansion coupling

No disassembly required

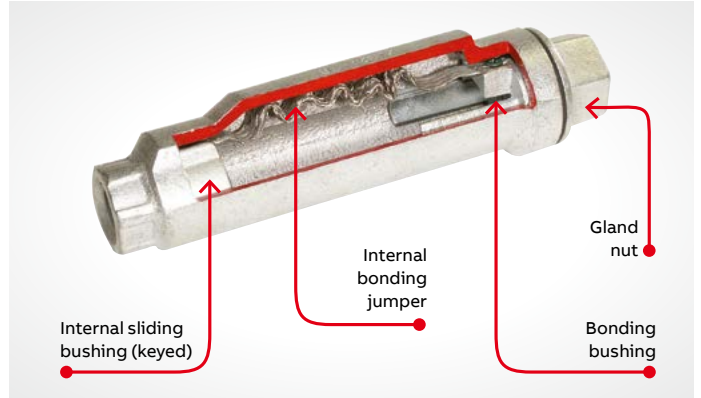

01 Slide the fitting onto the conduit until it stops at the internal sliding bushing. Tighten and you're ready. No parts to reassemble!

02 With a wrench, tighten the gland nut to create a rain-tight seal around the conduit.

03 Thread the next length of conduit into the other end of the fitting and tighten. You're done!

When you install a rigid expansion coupling in a long conduit run, you normally need three hands, two strong backs and lots of patience. Now you can relax.

With the no-hassle XJG Rigid Conduit Expansion Coupling, installation's just a few turns and you're done.

The XJG Rigid Conduit Expansion Coupling features innovations that provide convenience to the installer, saving time and money on the job. No disassembly is needed during installation, requiring fewer tools and less opportunity for lost pieces. It also features a true internal bonding jumper, eliminating the need for external jumpers, so there are fewer parts to buy and install.

If you need a fitting that can give and take without a lot of hassle, reach for the XJG Rigid Conduit Expansion Coupling. It's the latest breakthrough in the industry's leading line of conduit fittings.

Innovative design makes installations easier.

- No disassembly necessary to install
- Fast, simple and requires fewer steps
- True internal bonding jumper – no external grounding strap required
- Tamper-proof internal jumper protected from the environment
- Exceeds code requirements for long conduit runs to permit linear movement



01



02



03

Ocal PVC-coated XJG rigid conduit expansion coupling



XJG24-G
4" Movement



Standard materials/finish

- Body/Finish: Ductile iron with nominal 40-mil PVC exterior coating
- Internal Bonding Jumper: Copper braid

Ocal® PVC-coated XJG rigid conduit expansion coupling

Product Code	Pipe Size (in.)	Metric Size Designator*	Movement		A Diameter		B Length		C Height	
			(in.)	(mm)	(in.)	(mm)	(in.)	(mm)	(in.)	(mm)
XJG24- <u> </u>	3/4	21	4.00	101.60	2.43	61.72	10.00	254.00	2.75	69.85
XJG28- <u> </u>	3/4	21	8.00	203.20	2.43	61.72	14.00	355.60	2.75	69.85
XJG34- <u> </u>	1	27	4.00	101.60	2.67	61.72	10.00	254.00	2.99	75.95
XJG38- <u> </u>	1	27	8.00	203.20	2.67	61.72	14.00	355.60	2.99	75.95
XJG44- <u> </u>	1 1/4	35	4.00	101.60	3.36	85.34	10.56	268.22	3.68	93.47
XJG48- <u> </u>	1 1/4	35	8.00	M1040	3.36	85.34	14.56	369.82	3.68	93.47
XJG54- <u> </u>	1 1/2	41	4.00	101.60	3.36	85.34	10.56	268.22	3.68	93.47
XJG58- <u> </u>	1 1/2	41	8.00	203.20	3.36	85.34	14.56	369.82	3.68	93.47
XJG64- <u> </u>	2	53	4.00	101.60	3.86	98.04	11.25	285.75	4.18	106.17
XJG68- <u> </u>	2	53	8.00	203.20	3.86	98.04	15.25	387.35	4.18	106.17
XJG74- <u> </u>	2 1/2	63	4.00	101.60	4.96	125.98	12.12	307.85	5.25	133.35
XJG78- <u> </u>	2 1/2	63	8.00	203.20	4.96	125.98	16.12	409.45	5.25	133.35
XJG84- <u> </u>	3	78	4.00	101.60	4.96	125.98	12.12	307.85	5.25	133.35
XJG88- <u> </u>	3	78	8.00	203.20	4.96	125.98	16.12	409.45	5.25	133.35
XJG94- <u> </u>	3 1/2	91	4.00	101.60	6.37	161.80	12.87	326.90	6.75	171.45
XJG98- <u> </u>	3 1/2	91	8.00	203.20	6.37	161.80	16.87	428.50	6.75	171.45
XJG104- <u> </u>	4	103	4.00	101.60	6.37	161.80	12.87	326.90	6.75	171.45
XJG108- <u> </u>	4	103	8.00	203.20	6.37	161.80	16.87	428.50	6.75	171.45
XJG1208- <u> </u>	5	129	8.00	203.20	7.99	202.94	18.87	479.30	8.56	217.42

* Metric size designator (ANSI C80.1-1994).
Dimensions shown are for uncoated coupling.

Product Code	Colour
XJG24-	
<u> </u>	= space for color identifier
G = Gray	
W = White	
B = Blue	
Custom colors also available.	

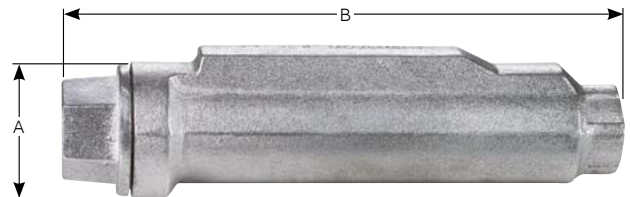

Coupling shown uncoated

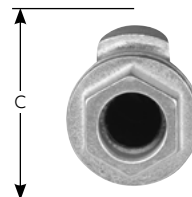

Ocal PVC-coated XD expansion/deflection coupling

Watertight, flexible connections support movement and thermal expansion.

Use the ABB XD expansion/deflection coupling to join two conduit runs in applications where movement in any direction is required.

The coupling provides a flexible, watertight connection, accommodating axial or parallel movement of up to ¾" and angular movement of up to 30° from normal.

- Ideal for use in bridges, tunnels, interbuilding walkways, docks and piers, wastewater and water treatment facilities and other applications in which conduit runs are subject to movement due to external forces or temperature changes
- Suitable for use indoors, outdoors, direct buried or embedded in concrete
- Watertight, flexible neoprene outer jacket, zinc-plated and acrylic-painted hubs and stainless steel tamperproof straps ensure superior corrosion resistance -ideal for use in harsh environments
- Copper ground mounting plates and grounding bonding jumper both entirely enclosed to safeguard against theft
- Includes an Erickson® type conduit union for faster, easier installation to help reduce labor costs
- Durable stainless steel inner sleeve provides a constant, smooth inner diameter in any position to ease wire pulling and protect wire insulation from damage
- NPT threaded hubs fit standard threaded rigid metal conduit
- Can also be used with rigid PVC conduit with the use of standard adapters (not supplied)

Listings/compliances

- UL listed to UL 514B and CSA certified to C22.2 No. 18.3, suitable for wet locations (hub sizes 1"-6")
- Watertight-NEMA 4
- NEC® Article 250.98 and 300.4(A) compliant

Standard materials/finish

- Hub: ductile cast iron, zinc-plated and aluminum acrylic painted
- Inner sleeve: stainless steel
- Internal grounding bonding jumper: flexible copper braid
- Ground mounting plates: copper
- Hub rings: zinc-plated steel
- Outer jacket: molded neoprene (natural black)
- Jacket straps: stainless steel

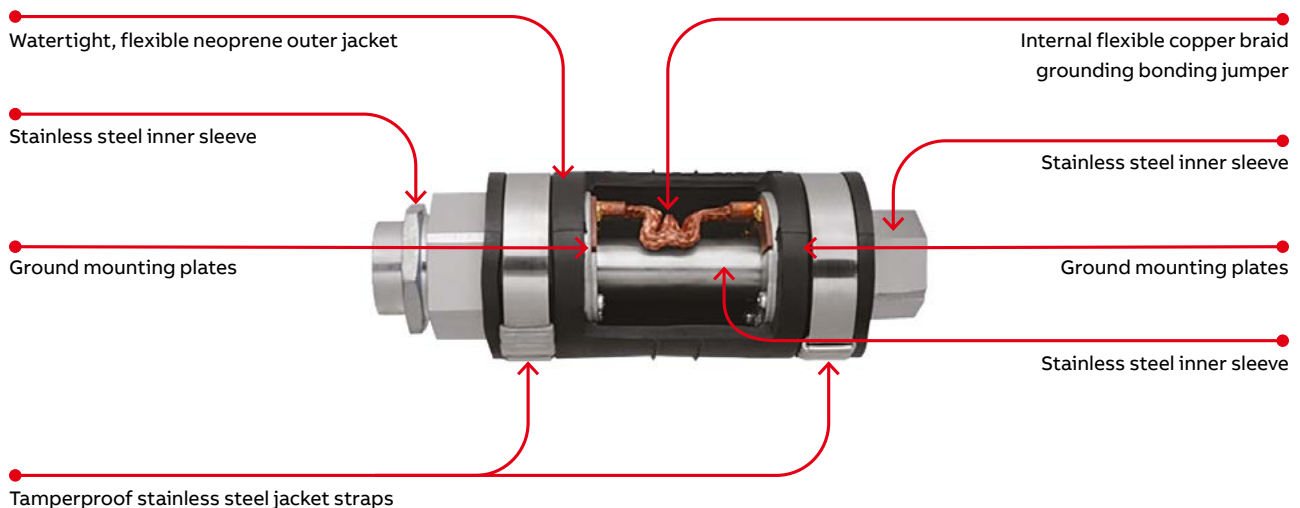

Ocal PVC-coated XD expansion/deflection coupling



XD expansion/deflection coupling

Product Code	Hub Size (in.)	Dimensions (in.)			
		A	B	C	D
XD3- <u> </u>	1	9 ¹³ / ₁₆	8 ¹⁵ / ₃₂	6 ⁷ / ₁₆	3 ¹¹ / ₃₂
XD4- <u> </u>	1 ¹ / ₄	9 ³ / ₁₆	8 ³ / ₈	6 ⁷ / ₈	3 ⁷ / ₈
XDS- <u> </u>	1 ¹ / ₂	9 ¹ / ₄	8 ⁷ / ₃₂	6 ³ / ₄	4 ⁵ / ₃₂
XD6- <u> </u>	2	9 ³ / ₄	8 ²¹ / ₃₂	7 ¹ / ₄	4 ¹¹ / ₁₆
XD7- <u> </u>	2 ¹ / ₂	11 ³ / ₄	11 ³ / ₈	9 ¹ / ₂	4 ⁷ / ₈
XDS- <u> </u>	3	10 ¹ / ₂	9 ²¹ / ₃₂	7 ²¹ / ₃₂	5 ¹⁵ / ₁₆
XD9- <u> </u>	3 ¹ / ₂	10 ⁹ / ₁₆	9 ³ / ₄	7 ³ / ₄	6 ⁵ / ₈
XD010- <u> </u>	4	13 ³ / ₁₆	11 ²⁷ / ₃₂	8 ⁷ / ₈	7 ⁹ / ₃₂
XD012- <u> </u>	5	14	12 ¹⁵ / ₁₆	11	8 ⁹ / ₃₂
XD014- <u> </u>	6	14 ⁵ / ₁₆	13 ³ / ₈	11 ¹ / ₂	9 ¹⁹ / ₃₂

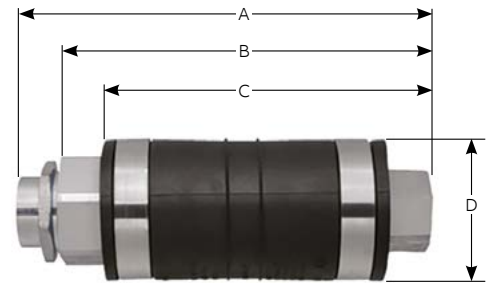

Product Code	Colour
XD3-	
<u> </u>	= space for color identifier
G = Gray	
W = White	
B = Blue	
Custom colors also available.	

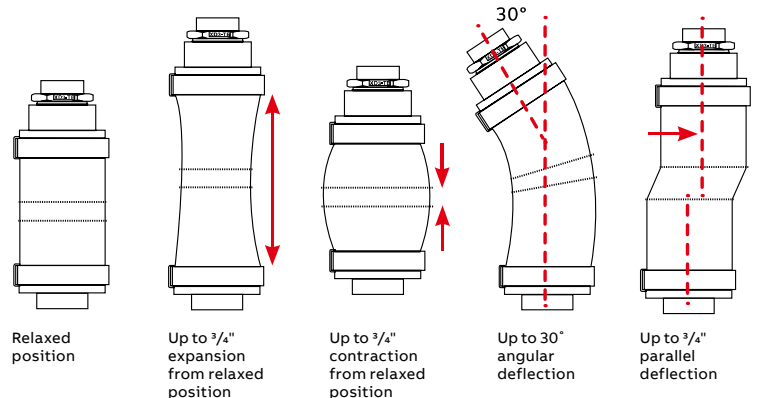

Ocal PVC-coated liquidtight conduit connectors

The ultimate liquidtight solution for corrosive environments



ST3/490-G 90° Angled

ST3/4-Straight

ST3/445-45° Angled

Product features

- Nominal .040" (40 mil) PVC coating bonded to exterior – available in gray, white, blue or custom colors
- Pressure-sealing sleeves protect the connection
- Ocal® uses only genuine ABB liquidtight fittings to ensure quality installations
- Ground ring meets UL 467 for grounding and bonding
- Ground ring made with naval brass

Non-grounding connectors

PVC-Coated Steel Straight Product Code	PVC-Coated Aluminum Straight Product Code	PVC-Coated Steel 45° Product Code	PVC-Coated Steel 90° Product Code	PVC-Coated Aluminum 90° Product Code	Pipe Size (in.)	Metric Size Designator*
ST3/8-	ST3/8SA-	ST3/845-	ST3/890-	ST3/890SA-	3/8	12
ST1/2-	ST1/2SA-	ST1/245-	ST1/290-	ST1/290SA-	1/2	16
ST3/4-	ST3/4SA-	ST3/445-	ST3/490-	ST3/490SA-	3/4	21
ST1-	ST1SA-	ST145-	ST190-	ST190SA-	1	27
ST1-1/4-	ST1-1/4SA-	ST1-1/445-	ST1-1/490-	ST1-1/490SA-	1 1/4	35
ST1-1/2-	ST1-1/2SA-	ST1-1/245-	ST1-1/290-	ST1-1/290SA-	1 1/2	41
ST2-	ST2SA-	ST245-	ST290-	ST290SA-	2	53
ST2-1/2-	ST2-1/2SA-	ST2-1/245-	ST2-1/290-			
ST3-	ST3SA-	ST345-	ST390-			
ST4-	ST4SA-	ST445-	ST490-			

* Metric size designator (ANSI C80.1-1994).



T3/490GR-G 90° Angled

T3/4GR-G-Straight

ST3/445GR-G-45° Angled

Connectors with grounding ring

PVC-Coated Steel Straight Product Code	PVC-Coated Aluminum Straight Product Code	PVC-Coated Steel 45° Product Code	Pipe Size (in.)	Metric Size Designator*
ST1/2GR-	ST1/245GR-	ST1/290GR-	1/2	16
ST3/4GR-	ST3/445GR-	ST3/490GR-	3/4	21
ST1GR-	ST145GR-	ST190GR-	1	27
ST1-1/4GR-	ST1-1/445GR-	ST1-1/490GR-	1 1/4	35
ST1-1/2GR-	ST1-1/245GR-	ST1-1/290GR-	1 1/2	41
ST2GR-	ST245GR-	ST290GR-	2	53
ST2-1/2GR-	ST2-1/245GR-	ST2-1/290GR-	2 1/2	63
ST3GR-	ST345GR-	ST390GR-	3	78
ST4GR-	ST445GR-	ST490GR-	4	103

* Metric size designator (ANSI C80.1-1994).

Product Code	Material	Colour
ST3/4	-	-
	Blank =	
	Steel/Iron	G = Gray
	SA =	W = White
	Aluminum	B = Blue
GR in Product Code designates ground ring.		Custom colors also available.

Ocal-Blue® Double-coat Star Teck Extreme®

STE series fittings for ordinary locations

The ideal fitting for jacketed metal-clad cable in ordinary locations



Product features

- Provides a means for passing armored and metal-clad jacketed cables through a bulkhead or enclosure
- Forms a mechanical grip and water- and/or oil-resistant termination
- Provides grounding continuity of cable armor
- Removable armor stop accommodates a wide range of cable sizes
- Features built-in sealing device and jacket stripping gauge, elastomeric collar ring/bushing and grounding ring
- Aluminum construction
- Nominal .002" (2 mil) blue urethane coating on both interior and exterior
- Nominal .040" (40 mil) PVC coating bonded to exterior

Ocal-Blue® Double-coat Star Teck Extreme® STE series fittings

Product Code	Hub Size (in.) and Metric Size Designator*	Strip Length (in.) (mm)	Gland Torque (lb.-in.) (nm)	Range Over Jacket				Range Over Armor				A1: Throat Dia. Min. with End Stop		A2: Throat Dia. Min. w/o End Stop		B Overall Height		C Max. Width	
				Min. (in.) (mm)	Max. (in.) (mm)	Min. (in.) (mm)	Max. (in.) (mm)	Min. (in.) (mm)	Max. (in.) (mm)	(in.) (mm)	(in.) (mm)	(in.) (mm)	(in.) (mm)	(in.) (mm)	(in.) (mm)				
ST050-462-_*	1/2"	16 1.25 31.75	300 33.90	.53 13.46	.65 16.51	.42 10.67	.57 14.48	N/A***	N/A***	.40 10.16	2.02 51.31	2.22 56.39	1.65 41.91	2.00 50.80	4.12 104.65	3.60 91.44	30.99		
STE050-_*	1/2"	16 1.25 31.75	300 33.90	.60 15.24	.99 25.15	.52 13.21	.90 22.86	.51 12.95	.61 15.49	2.65 67.31	1.63 41.40	2.22 56.39	1.65 41.91	2.42 61.47	5.32 135.13	4.75 120.65	41.40		
STE075-_*	3/4"	21 1.25 31.75	600 67.79	.86 21.84	1.21 30.73	.78 19.81	1.13 28.70	.66 16.76	.82 20.83	2.90 73.66	2.08 52.83	2.22 56.39	1.65 41.91	2.89 73.41	5.40 137.16	5.40 137.16	52.83		
STE100-_*	1"	27 1.25 31.75	700 79.09	.95 24.13	1.38 35.05	.87 22.10	1.30 33.02	.79 20.07	1.04 26.42	3.02 76.71	2.30 58.42	2.22 56.39	1.65 41.91	3.02 76.71	5.40 137.16	5.40 137.16	58.42		
STE125-_*	1 1/4"	35 1.25 31.75	1000 112.98	1.15 29.21	1.63 41.40	.99 25.15	1.47 37.34	.97 24.64	1.25 31.75	4.01 101.85	2.82 71.63	2.22 56.39	1.65 41.91	3.46 87.88	5.36 136.14	5.90 149.86	71.63		
STE150-_*	1 1/2"	41 1.75 44.45	1200 135.58	1.44 36.58	1.97 50.04	1.28 32.51	1.81 45.97	1.26 32.00	1.56 39.62	4.29 108.97	3.25 82.55	2.22 56.39	1.65 41.91	4.29 108.97	5.40 137.16	6.40 162.56	82.55		
STE200-_*	2"	53 1.75 44.45	1600 180.78	1.83 46.48	2.38 60.45	1.67 42.42	2.22 56.39	1.65 41.91	2.00 50.80	4.12 104.65	3.60 91.44	2.22 56.39	1.65 41.91	4.12 104.65	5.40 137.16	6.40 162.56	91.44		
STE250-_*	2 1/2"	63 2.50 63.50	1600 180.78	2.27 57.66	2.81 71.37	2.11 53.59	2.68 68.07	2.08 52.83	2.42 61.47	5.32 135.13	4.75 120.65	2.22 56.39	1.65 41.91	5.32 135.13	5.40 137.16	6.40 162.56	120.65		
STE300-_*	3"	78 2.50 63.50	1600 180.78	2.67 67.82	3.27 83.06	2.55 64.77	3.15 80.01	2.53 64.26	2.89 73.41	5.40 137.16	5.40 137.16	2.22 56.39	1.65 41.91	5.40 137.16	5.40 137.16	6.40 162.56	137.16		
STE350-_*	3 1/2"	91 2.50 63.50	1600 180.78	3.22 81.79	3.87 98.30	3.09 78.49	3.64 92.46	3.07 77.98	3.46 87.88	5.36 136.14	5.90 149.86	2.22 56.39	1.65 41.91	5.36 136.14	5.40 137.16	6.40 162.56	149.86		
STE400-_*	4"	103 2.50 63.50	1600 180.78	3.67 93.22	4.34 110.27	3.55 90.17	4.23 107.44	3.53 89.66	3.94 100.08	5.42 137.67	6.40 162.56	2.22 56.39	1.65 41.91	5.42 137.67	5.40 137.16	6.40 162.56	162.56		

* These products are UL® Listed UL84H3 and watertight NEMA Type 6P.

**Metric size designator (ANSI C80.1-1994).

***This fitting does not have a removable armor stop.

Product Code	Colour
STE050-	
_ = space for color identifier	
G = Gray	
W = White	
B = Blue	
Custom colors also available.	

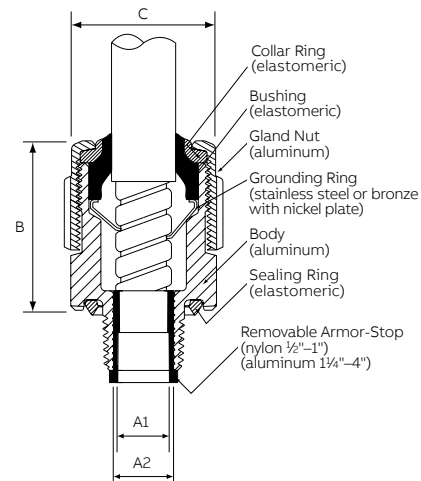

Ocal-Blue® Double-coat FS and FD series device boxes

Variety of styles offers versatility



Install these boxes in conduit systems to accommodate wiring devices, act as pull boxes for conductors, provide openings to make splices and taps and provide access to conductors for maintenance and future system changes.



Product features

- Cast class 30 gray iron alloy boxes
- Coated with a nominal .002" (2 mil) blue urthane on both the interior and exterior before PVC coating is applied
- Nominal .040" (40 mil) PVC coating bonded to exterior
- PVC coating available in your choice of blue, white or gray with custom colors available on request
- Pressure-sealing sleeves protect connections with conduit

Ocal-blue® Double-coat FS and FD series device boxes

Dead End Product Code	Feed-Thru Product Code	Hub Right Product Code	Hub Left Product Code	Style	Pipe Size (in.)	Metric Size Designator*
Single-Gang						
FS1- <u> </u>	FSC1- <u> </u>	FSR1- <u> </u>	FSL1- <u> </u>	Shallow	1/2	16
FS2- <u> </u>	FSC2- <u> </u>	FSR2- <u> </u>	FSL2- <u> </u>	Shallow	3/4	21
FS3- <u> </u>	FSC3- <u> </u>	—	—	Shallow	1	27
FD1- <u> </u>	FDC1- <u> </u>	FDR1- <u> </u>	FDL1- <u> </u>	Deep	1/2	16
FD2- <u> </u>	FDC2- <u> </u>	FDR2- <u> </u>	FDL2- <u> </u>	Deep	3/4	21
FD3- <u> </u>	FDC3- <u> </u>	—	—	Deep	1	27
—	FSCC2- <u> </u>	—	—	Shallow	3/4	21
—	FDCC2- <u> </u>	—	—	Deep	3/4	21
FSS2- <u> </u>	—	—	—	Shallow	3/4	21
FDD2- <u> </u>	—	—	—	Deep	3/4	21
Double-Gang						
FS22- <u> </u>	—	—	—	Shallow	3/4	21
FD22- <u> </u>	—	—	—	Deep	3/4	21
FSS222- <u> </u>	—	—	—	Shallow	3/4	21
FDS222- <u> </u>	—	—	—	Deep	3/4	21
—	FSC222- <u> </u>	—	—	Shallow	3/4	21
—	FDC222- <u> </u>	—	—	Deep	3/4	21

*Metric size designator (ANSI C80.1-1994).

Product Code	Colour
FS1-	
<u> </u>	= space for color identifier
G = Gray	
W = White	
B = Blue	

Custom colors also available.

Ocal Blue® Double-coat FS and FD series covers



Designed for use with Ocal® FS and FD series boxes



Ocal-Blue® Double-coat FS and FD series covers

Product Code	Description	Material
Single-gang		
DS23-__	Duplex Receptacle Cover	Steel
DS21G-__	Round Flush Receptacle Cover	Iron
DS32G-__	Toggle Switch Cover	Iron
DS100G-__	Blank Cover	Aluminum
Single-gang — NEMA 3R Raintight when used with appropriate Ocal® boxes		
WLRD1-__	Duplex Receptacle Cover – Box Mount – Horizontal	Aluminum
FSK1VDR-__	Duplex Receptacle Cover – Box Mount – Vertical	Aluminum
WLGFFS-__	GFCI Receptacle Cover – Box Mount – Horizontal	Aluminum
CFSRG-__	GFCI Receptacle Cover – Box Mount – Vertical	Aluminum
DS185-__	Front Lever Switch Cover – Box Mount – NEMA 4	Aluminum
Double-gang		
S1002G-__	Blank Cover	Iron
S322G-__	2-Toggle Switch Cover	Iron
S232-__	2-Duplex Receptacle Cover	Stamped Steel
S232GFI-__	2-GFCI Receptacle Cover	Steel
Double-gang — NEMA 3R Raintight when used with appropriate Ocal® boxes		
DS1282-__	2-Plunger-Style Switch Cover	Aluminum

PVC-coated covers in other styles and materials are available upon request. Contact Technical Services for more information.

Product Code	Colour
DS23-	
__ = space for color identifier	
G = Gray	
W = White	
B = Blue	

Custom colors also available.

Ocal-Blue® Double-coat Star Teck Extreme® STEX series fittings for hazardous locations

Specially designed for hazardous locations

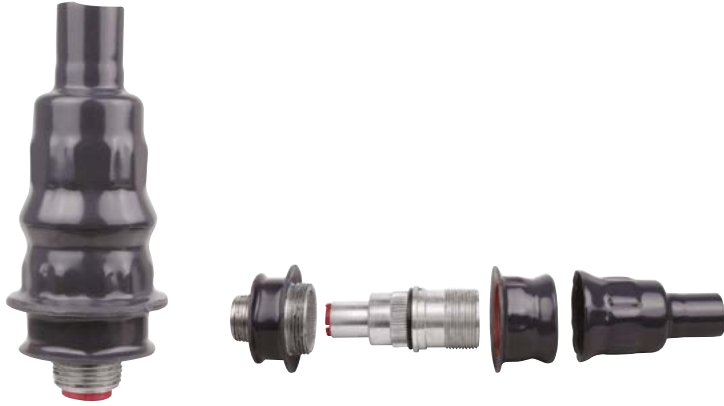

Product features

- Offers all the features of the STE Series
- Classified for Class I, Division 1, Groups A, B, C, D and Class II, Division 1, Groups E, F, G environments with approved metal-clad cable installed in accordance with NEC®/CEC requirements††
- Requires ABB® sealing compound for use in hazardous locations

Ocal-Blue® Double-coat Star Teck Extreme® STE series fittings

Product Code	Hub Size (in.)	Metric Size Designator*	Strip Length (in.)	(mm)	(lb.-in.)	Gland Torque (nm)	Range Over Jacket				Range Over Armor				A1: Throat Dia. Min. with End Stop		A2: Throat Dia. Min. w/o End Stop		B Overall Height		C Max. Width		
							Min.	Max.	Min.	Max.	Min.	Max.	(in.)	(mm)	(in.)	(mm)	(in.)	(mm)	(in.)	(mm)	(in.)	(mm)	
STX050-462-_*	1/2	16	1.25	31.75	300	33.90	.53	13.46	.65	16.51	.42	10.67	.57	14.48	N/A***	N/A***	.40	10.16	2.50	63.50	1.63	41.40	
STX050-464-_*	1/2	16	1.25	31.75	300	33.90	.60	15.24	.76	19.30	.49	12.45	.68	17.27	N/A***	N/A***	.49	12.45	2.53	64.26	1.63	41.40	
STEX075-_*	3/4	21	1.25	31.75	600	67.79	.60	15.24	.99	25.15	.52	13.21	.90	22.86	.50	12.70	.68	17.27	3.40	86.36	1.82	46.23	
STEX100-_*	1	27	1.25	31.75	700	79.09	.86	21.84	1.21	30.73	.78	19.81	1.13	28.70	.65	16.51	.83	21.08	3.58	90.93	2.30	58.42	
STEX125-_*	1 1/4	35	1.25	31.75	1000	112.98	.95	24.13	1.38	35.05	.87	22.10	1.30	33.02	.83	21.08	1.07	27.18	3.92	99.57	2.51	63.75	
STEX150-_*	1 1/2	41	1.75	44.45	1200	135.58	1.15	29.21	1.63	41.40	.99	25.15	1.47	37.34	.96	24.38	1.27	32.26	5.02	127.51	3.26	82.80	
STEX200-_*	2	53	1.75	44.45	1600	180.78	1.44	36.58	1.97	50.04	1.28	32.51	1.81	45.97	1.25	31.75	1.56	39.62	5.12	130.05	3.62	91.95	
STEX250-_†	2 1/2	63	2.50	63.50	1600	180.78	1.83	46.48	2.38	60.45	1.67	42.42	2.22	56.39	1.64	41.66	2.00	50.80	5.17	131.32	4.58	116.33	
STEX300-_†	3	78	2.50	63.50	1600	180.78	2.27	57.66	2.81	71.37	2.11	53.59	2.68	68.07	2.08	52.83	2.46	62.48	6.61	167.89	5.10	129.54	
STEX350-_†	3 1/2	91	2.50	63.50	1600	180.78	2.67	67.82	3.27	83.06	2.55	64.77	3.15	80.01	2.53	64.26	2.86	72.64	7.38	167.89	5.79	147.07	
STEX400-_†	4	103	2.50	63.50	1600	180.78	3.22	81.79	3.87	98.30	3.09	78.49	3.64	92.46	3.06	77.72	3.46	87.88	7.65	194.31	6.19	157.23	
STX400-484-_†	4	103	—	—	1600	180.78	3.81	96.77	4.03	102.36	3.68	93.47	3.87	98.30	—	—	—	—	—	—	—	—	—
STX400-485-_†	4	103	—	—	1600	180.78	3.97	100.84	4.19	106.43	3.84	97.54	4.03	102.36	—	—	—	—	—	—	—	—	—

* These products are UL® Listed UL84H3 and watertight NEMA Type 6P.

**Metric size designator (ANSI C80.1-1994).

***This fitting does not have a removable armor stop.

†CSA approved for hazardous locations.

††Ratings prior to PVC coating.

ABB Sealing Compounds -used for hazardous locations

Product code	Description	Volume
SC4-KIT	Liquid-Type Sealing Compound for Use in Control Cable Applications	2.8 fl. oz.
SC65	Putty-Type Sealing Compound	60 grams

Ocal-Blue® Double-coat conduit unions

Explosion-proof, dust-ignition-proof three-piece couplings



Product features

- Install in threaded thick-wall conduit systems in hazardous areas
- Use UNY male unions to connect conduit to a conduit fitting, junction box or device enclosure
- Use UNF female unions to connect conduit to conduit or to provide means for future modifications to the conduit system
- Nominal .002" (2 mil) blue urethane on interior and exterior
- Nominal .040" (40 mil) PVC coating bonded to exterior
- Pressure-sealing sleeves to help protect your connection
- Explosion-proof, dust-ignitionproof and suitable for use in the following environments:[†]
 - Class I, Division 1 & 2, Groups A, B, C, D
 - Class II, Division 1, Groups E, F, G
 - Class III, Division 1 & 2

UNY Male unions

	Product Code	Pipe Size (in.)	Metric Size Designator*	Overall Length		Overall Dimensions	
				(in.)	(mm)	(in.)	(mm)
	UNY105- _	1/2	16	2.39	60.71	1.50	38.10
	UNY205- _	3/4	21	2.44	61.98	1.81	45.97
	UNY305- _	1	27	2.75	69.85	2.00	50.80
	UNY405- _	1 1/4	35	3.06	77.72	2.75	69.85
	UNY505- _	1 1/2	41	3.63	92.20	3.06	77.72
	UNY605- _	2	53	3.50	88.90	3.81	96.77
	UNY705- _	2 1/2	63	4.81	122.17	4.31	109.47
	UNY805- _	3	78	5.34	135.64	5.06	128.52
	UNY905- _	3 1/2	91	5.50	139.70	5.69	144.53
	UNY1005- _	4	103	5.63	143.00	6.19	157.23
	UNY012- _	5	129	5.25	133.35	8.19	208.03
	UNY014- _	6	155	5.38	136.65	9.31	236.47

UNY Male 5"-6"
(shown uncoated)

UNY Female unions

	Product Code	Pipe Size (in.)	Metric Size Designator*	Overall Length		Overall Dimensions	
				(in.)	(mm)	(in.)	(mm)
	UNF105- _	1/2	16	1.88	47.75	1.50	38.10
	UNF205- _	3/4	21	2.13	54.10	1.81	45.97
	UNF305- _	1	27	2.16	54.86	2.00	50.80
	UNF405- _	1 1/4	35	2.25	57.15	2.75	69.85
	UNF505- _	1 1/2	41	2.75	69.85	3.06	77.72
	UNF605- _	2	53	2.50	63.50	3.81	96.77
	UNF705- _	2 1/2	63	3.50	88.90	4.31	109.47
	UNF805- _	3	78	4.00	101.60	5.06	128.52
	UNF905- _	3 1/2	91	4.16	105.66	5.69	144.53
	UNF1005- _	4	103	4.25	107.95	6.19	157.23
	UNF012- _	5	129	3.81	96.77	8.19	208.03
	UNF014- _	6	155	3.81	96.77	9.31	236.47

UNF Female 5"-6"
(shown uncoated)

* Metric size designator (ANSI C80.1-1994). † Ratings prior to PVC coating.

Product Code	Colour
UNF105-	
_ = space for color identifier	
G = Gray	
W = White	
B = Blue	
Custom colors also available.	

Ocal-Blue® Double-coat GUA series conduit boxes

Provides access to wiring, directional changes in conduit and more



GUA series conduit boxes are installed in hazardous areas to protect conductors, act as pull and splice boxes, provide access to conductors for maintenance and future system changes, act as mounting outlets for fixtures (with proper covers) or change conduit direction.

Product features

- Grade 60-45-10 ductile iron bodies and cast aluminum covers (iron covers also available)
- Nominal .002" (2 mil) blue urethane coating on both interior and exterior and nominal .040" (40 mil) PVC coating bonded to exterior
- All hubs have minimum five full threads, integral bushing and pressure-sealing sleeves
- All units furnished with internal grounding screw and ship complete with aluminum cover with O-ring gasket (covers also sold separately for replacement purposes)
- Explosion-proof, dust-ignitionproof and suitable for use in the following environments:[†]
 - Class I, Division 1 & 2, Groups A, B, C, D
 - Class II, Division 1, Groups E, F, G
 - Class III, Division 1 & 2

Listings/Certifications[†]

- UL514A Wet Locations (when used with gasketed covers)
- UL886
- CSA C22.2 No. 30



Ocal-Blue® Double-coat GUA series conduit boxes

Product Code					Aluminum Cover Only	Iron Cover Only	Pipe Size (in.)	Metric Size Designator*	Cover Opening (in.) (mm)	
GUA	GUAC	GUAT	GUAX	GUAB						
GUA14-	GUAC14-	GUAT14-	GUAX14-	GUAB14-	GUA04-	GUA04WOD-	1/2	16	2.00	50.80
GUA24-	GUAC24-	GUAT24-	GUAX24-	GUAB24-	GUA04-	GUA04WOD-	3/4	21	2.00	50.80
GUA16-	GUAC16-	GUAT16-	GUAX16-	GUAB16-	GUA06-	GUA06WOD-	1/2	16	3.00	76.20
GUA26-	GUAC26-	GUAT26-	GUAX26-	GUAB26-	GUA06-	GUA06WOD-	3/4	21	3.00	76.20
GUA36-	GUAC36-	GUAT36-	GUAX36-	GUAB36-	GUA06-	GUA06WOD-	1	27	3.00	76.20
—	—	GUAT37-	GUAX37-	—	GUA07-	GUA07WOD-	1	27	3.63	92.20
GUA47-	GUAC47-	GUAT47-	GUAX47-	GUAB47-	GUA07-	GUA07WOD-	1 1/4	35	3.63	92.20
—	GUAC49-	GUAT49-	GUAX49-	—	GUA09-	GUA09WOD-	1 1/4	35	5.00	127.00
GUA59-	GUAC59-	GUAT59-	GUAX59-	GUAB59-	GUA09-	GUA09WOD-	1 1/2	41	5.00	127.00
—	GUAC69-	GUAT69-	GUAX69-	GUAB69-	GUA09-	GUA09WOD-	2	53	5.00	127.00

[†] Ratings prior to PVC coating.

Product Code **Colour**

GUA14-

_ = space for color identifier

G = Gray

W = White

B = Blue

Custom colors also available.

Ocal-Blue® Double-coat GUA series conduit boxes (continued)

Provides access to wiring, directional changes in conduit and more



Ocal-Blue® Double-coat GUA series conduit boxes



Product Code							Aluminum Cover Only	Iron Cover Only	Pipe Size (in.)	Metric Size Designator*	Cover Opening (in.) (mm)	
GUA	GUAC	GUAT	GUAX	GUAB								
GUAD14-	GUAL14-	GUAM14-	GUAN14-	GUAW14-	GUA04-	GUA04WOD-	1/2	16	2.00	50.80		
GUAD24-	GUAL24-	GUAM24-	GUAN24-	GUAW24-	GUA04-	GUA04WOD-	3/4	21	2.00	50.80		
GUAD16-	GUAL16-	GUAM16-	GUAN16-	GUAW16-	GUA06-	GUA06WOD-	1/2	16	3.00	76.20		
GUAD26-	GUAL26-	GUAM26-	GUAN26-	GUAW26-	GUA06-	GUA06WOD-	3/4	21	3.00	76.20		
GUAD36-	GUAL36-	GUAM36-	GUAN36-	—	GUA06-	GUA06WOD-	1	27	3.00	76.20		
—	GUAL47-	GUAM47-	GUAN47-	—	GUA07-	GUA07WOD-	1 1/4	35	3.63	92.20		
GUAD49-	GUAL49-	—	—	—	GUA09-	GUA09WOD-	1 1/4	35	5.00	127.00		
—	GUAL59-	—	GUAN59-	—	GUA09-	GUA09WOD-	1 1/2	41	5.00	127.00		
—	GUAL69-	GUAM69-	GUAN69-	—	GUA09-	GUA09WOD-	2	53	5.00	127.00		

* Ratings prior to PVC coating.

Product Code **Colour**

GUAD14-

_ = space for color identifier

G = Gray

W = White

B = Blue

Custom colors also available.

Ocal-Blue® Double-coat external Aluminum hubs with covers and installed green ground screw

Junction boxes for branch conduits in hazardous locations



GAC



GAE



GALB



GAT



GAL

Product features

- Accessible wiring chamber provides a convenient location to maintain or change a system, pull conductors and make splices
- Unique mounting pads and rugged protective housing ideal for installation of OEM devices or instruments
- Die-cast copper-free aluminum alloy A360 construction with precision cast and machined surfaces
- Precision NPT threaded hubs to facilitate trouble-free field installation
- Nominal .002" (2 mil) blue urethane coating on both interior and exterior and nominal .040" (40 mil) PVC coating bonded to exterior
- Explosion-proof, dust-ignition-proof and suitable for use in the following environments:^{††}
 - Class I, Division 1 & 2, Groups C, D
 - Class II, Division 1, Groups E, F, G
 - Class III, Division 1 & 2
 - NEMA 3, 4, 7 CD, 9 EFG (NEMA 4 rated when ordered with O-ring installed)

Ocal-Blue® Double-coat external Aluminum hubs with covers and installed green ground screw



Product Code

Through-Feed W/Surf. Cover	Dead End W/Surf. Cover	L-Style W/Surf. Cover	LB-Style W/Surf. Cover	T-Style W/Surf. Cover	Surface Cover Only	Pipe Size (in.)	Metric Size Designator*	Cover Opening (in.) (mm)	
GAC	GAE	GAL	GALB	GAT	GAS				
GAC-1- _†	GAE-1- _†	GAL-1- _†	GALB-1- _†	GAT-1- _†	GAS-123- _•	1/2	16	3.69	93.73
GAC-2- _†	GAE-2- _†	GAL-2- _†	GALB-2- _†	GAT-2- _†	GAS-123- _•	3/4	21	3.69	93.73
GAC-3- _{†•}	GAE-3- _{†•}	GAL-3- _{†•}	GALB-3- _†	GAT-3- _†	GAS-123- _•	1	27	3.69	93.73
GAC-4- _{†•}	—	GAL-4- _{†•}	GALB-4- _†	GAT-4- _†	GAS-4- _•	1 1/4	35	3.91	99.31
GAC-5- _{†•}	—	GAL-5- _{†•}	GALB-5- _{†•}	GAT-5- _†	GAS-56- _•	1 1/2	41	5.19	131.83
GAC-6- _{†•}	—	GAL-6- _{†•}	GALB-6- _{†•}	GAT-6- _†	GAS-56- _•	2	53	5.19	131.83

* Metric size designator (ANSI C80.1-1994).

• Made-to-order item. Consult factory for lead time and minimum quantities.

† Ratings prior to PVC coating.

†† Ratings prior to PVC coating.

Product Code Colour

GAC-1-

= space for color identifier

G = Gray

W = White

B = Blue

Custom colors also available.

Ocal-Blue® Double-coat external Aluminum hubs with covers and installed green ground screw (continued)

Junction boxes for branch conduits in hazardous locations



GAX



GAFX



GAJU
(shown uncoated)



GAS



GAD



GAJ

Ocal-Blue® Double-coat external Aluminum hubs with covers and installed green ground screw



Product code

X-Style W/Surf. Cover	X-Style W/ Flange & Surf. Cover	U-Style Surface W/ Canopy Cover	Surface Cover Only	Dome Cover Only (Class I, GR. D)	Canopy Cover Only	Pipe Size (in.)	Metric Size Designator*	Cover Opening (in.) (mm)	
GAX	GAFX	GAJU	GAS	GAD	GAJ				
GAX-1- _†	GAFX-1- _†	GAJU-1- _•	GALB-1- _†	GAD-123- _•	GAJ-123- _•	1/2	16	3.69	93.73
GAX-2- _†	GAFX-2- _†	GAJU-2- _•	GALB-2- _†	GAD-123- _•	GAJ-123- _•	3/4	21	3.69	93.73
GAX-3- _{†•}	GAFX-3- _†	GAJU-3- _•	GALB-3- _†	GAD-123- _•	GAJ-123- _•	1	27	3.69	93.73
GAX-4- _{†•}	—	—	GALB-4- _†	—	GAJ-4- _•	1 1/4	35	3.91	99.31
GAX-5- _{†•}	—	GAJU-5- _•	GALB-5- _{†•}	—	GAJ-56- _•	1 1/2	41	5.19	131.83
GAX-6- _{†•}	—	GAJU-6- _•	GALB-6- _{†•}	—	GAJ-56- _•	2	53	5.19	131.83

* Metric size designator (ANSI C80.1-1994).

• Made-to-order item. Consult factory for lead time and minimum quantities.

† Ratings prior to PVC coating.

†† Ratings prior to PVC coating.

Product Code **Colour**

GAX-1

_ = space for color identifier

G = Gray

W = White

B = Blue

Custom colors also available.

Ocal-Blue® Double-coat sealing fittings

Restrict the passage of gases, vapors and flames at atmospheric pressure and normal ambient temperatures



EYD



EYS

Product features

- Helps prevent pre-compression or “pressure piling” in conduit systems
- Gray iron alloy body construction coated with nominal .002” (2 mil) blue urethane on both interior and exterior
- Nominal .040” (40 mil) PVC coating bonded to exterior – available in gray, white, blue or custom colors
- Explosion-proof, dust-ignition-proof and suitable for use in the following environments:†
 - Class I, Division 1 & 2, Groups C, D
 - Class II, Division 1, Groups E, F, G
 - Class III, Division 1 & 2

EYD Series drain sealing fittings

Female Product Code	Male & Female Product Code	Pipe Size (in.)	Metric Size Designator*	Dimensions				Turning Radius	
				A		B		(in.)	(mm)
				(in.)	(mm)	(in.)	(mm)	(in.)	(mm)
EYD1-	EYD16-	1/2	16	3.81	96.77	1.50	38.10	1.75	44.45
EYD2-	EYD26-	3/4	21	4.08	103.63	1.75	44.45	1.98	50.29
EYD3-	EYD36-	1	27	4.85	123.19	2.19	55.63	2.19	55.63
EYD4-	EYD46-	1 1/4	35	5.00	127.00	2.25	57.15	1.80	45.72
EYD5-	EYD56-	1 1/2	41	5.44	138.18	2.44	61.98	2.00	50.80
EYD6-	EYD66-	2	53	6.25	158.75	3.00	76.20	2.32	58.93
EYD7-	EYD76-	2 1/2	63	7.50	190.50	3.50	88.90	2.69	68.33
EYD8-	EYD86-	3	78	8.50	215.90	4.25	107.95	3.15	80.01
EYD9-	EYD96-	3 1/2	91	9.19	233.43	4.75	120.65	3.38	85.85
EYD10-	EYD106-	4	103	9.75	247.65	5.25	133.35	3.64	92.46

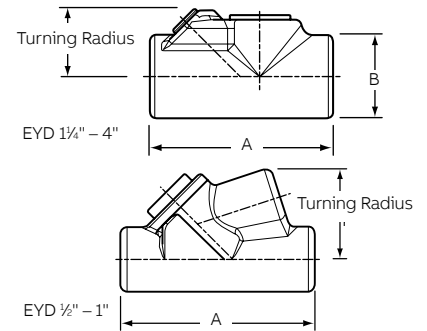

EYS Series sealing fittings

Female Product Code	Male & Female Product Code	Pipe Size (in.)	Metric Size Designator*	Dimensions						Turning Radius	
				A		B		C		(in.)	(mm)
				(in.)	(mm)	(in.)	(mm)	(in.)	(mm)	(in.)	(mm)
Vertical Only											
EYS1-	EYS116-	1/2	16	3.31	84.07	1.25	31.75	1.50	38.10	1.66	42.16
EYS2-	EYS26-	3/4	21	3.65	92.71	1.50	38.10	1.75	44.45	1.96	49.78
EYS3-	EYS36-	1	27	4.25	107.95	1.75	44.45	2.19	55.63	2.40	60.96
Vertical or Horizontal											
EYS11-	EYS116-	1/2	16	3.63	92.20	1.25	31.75	—	—	1.09	27.69
EYS21-	EYS216-	3/4	21	3.66	92.96	1.50	38.10	—	—	1.25	31.75
EYS31-	EYS316-	1	27	4.25	107.95	1.75	44.45	—	—	1.59	40.39
EYS4-	EYS46-	1 1/4	35	5.00	127.00	2.25	57.15	—	—	1.81	45.97
EYS5-	EYS56-	1 1/2	41	5.44	138.18	2.44	61.98	—	—	2.00	50.80
EYS6-	EYS66-	2	53	6.25	158.75	3.00	76.20	—	—	2.31	58.67
EYS7-	EYS76-	2 1/2	63	7.50	190.50	3.50	88.90	—	—	2.56	65.02
EYS8-	EYS86-	3	78	8.50	215.90	4.25	107.95	—	—	3.09	78.49
EYS9-	EYS96-	3 1/2	91	9.19	233.43	4.75	120.65	—	—	3.38	85.85
EYS10-	EYS106-	4	103	9.75	247.65	5.25	133.35	—	—	3.53	89.66

† Ratings prior to PVC coating.

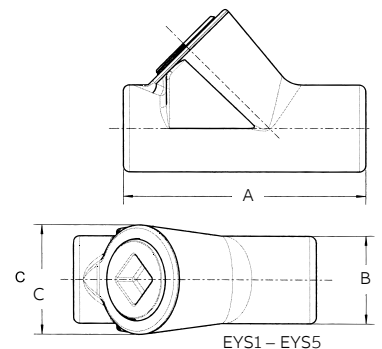
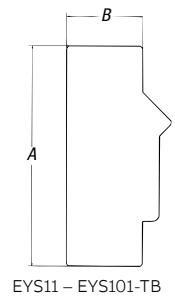

Ocal-Blue® Double-coat sealing fittings (continued)

Restrict the passage of gases, vapors and flames at atmospheric pressure and normal ambient temperatures



EZS



EZD



EZD
With inspection cover off

EZS Series sealing fittings

Female Product Code	Male & Female Product Code	Pipe Size (in.)	Metric Size Designator*
EZS1-_	EZS16-_	1/2	16
EZS2-_	EZS26-_	3/4	21
EZS3-_	EZS36-_	1	27
EZS4-_	EZS46-_	1 1/4	35
EZS5-_	EZS56-_	1 1/2	41
EZS6-_	EZS66-_	2	53
EZS7-_	EZS76-_	2 1/2	63
EZS8-_	EZS86-_	3	78

* Metric size designator (ANSI C80.1-1994).
† Ratings prior to PVC coating.

EZD Series sealing fittings

Product Code	Pipe Size (in.)	Metric Size Designator*
EZD111-_	1/2	16
EZD211-_ 3/4	3/4	21
EZD311-_	1	27
EZD411-_	1 1/4	35
EZD511-_	1 1/2	41
EZD611-_	2	53

* Metric size designator (ANSI C80.1-1994).

Product Code	Colour
EZS1-	
_	= space for color identifier
G = Gray	
W = White	
B = Blue	
Custom colors also available.	

Chico® Sealing compound and fiber

Ensures proper functioning of EYS sealing fittings.



SEAL-A3



EZD

Ocal-Blue® Double-Coat EYS Sealing Fittings require fiber filler and sealing compound to function properly. Use Chico® X Fiber Filler to form a dam around the sealing fitting's integral bushing, as well as at the end of the conduit and around conductors entering the hub. Chico® A Sealing Compound expands slightly while hardening and bonds to the inner walls of the sealing fitting.

Product features

- Sealing compound mixes with water, pours easily and hardens in 60–70 minutes
- Fiber filler mineral wool holds sealing compound in place while it hardens

Chico® Sealing compound and fiber

Product Code	Description
SEAL-A3	Chico® A Sealing Compound, 1 lb. net wt./23 cu.in. vol.
FIBER-X6	Chico® X Fiber Filler, 8 oz.
SEALKIT-A4	Chico® A Sealing Compound, 1 lb. net wt./23 cu.in. vol., with 1 oz. Chico® X Fiber Filler

Chico® is a registered trademark of Cooper Crouse-Hinds.

Ocal® PVC-coated steel strut

Rugged steel channels protected by corrosion-resistant PVC

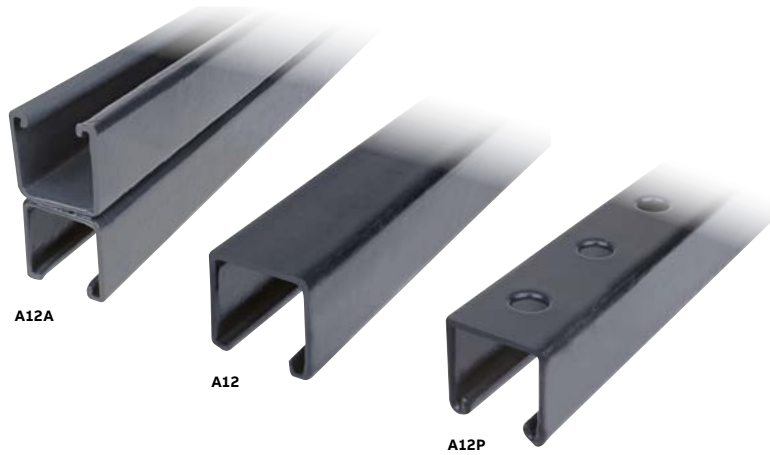

Product features

- Electro-galvanized zinc plated
- Nominal .007 - .015" (7 - 15 mil) PVC coating
- PVC coating available in your choice of blue, white or gray standard colors
- Custom colors also available on request
- Sold in 10-ft. (3.048m) lengths with standard length tolerance of $\pm 1/8$ " (3.18mm)
- Choose between standard $1\frac{5}{8}$ " (41.28mm) and shallow $1\frac{3}{16}$ " (20.64mm) depths
- Available in both solid and punched styles
- Not recommended for vertical applications

Ocal® PVC-coated steel strut

Product Code	Style	Steel Thickness		Width x Height	
		Gauge	(mm)	(in.)	(mm)
A12- <u> </u>	Standard	12	2.65	1.63 x 1.63	41.28 x 41.28
A12A- <u> </u>	Back to Back	12	2.65	1.63 x 3.25	41.28 x 82.55
A12P- <u> </u>	Standard Punched	12	2.65	1.63 x 1.63	41.28 x 41.28
C14- <u> </u>	Shallow	14	1.89	1.63 x .81	41.28 x 20.64
C14P- <u> </u>	Shallow Punched	14	1.89	1.63 x .81	41.28 x 20.64

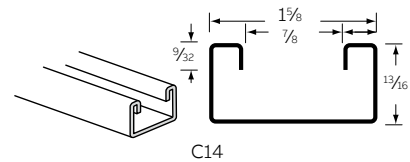
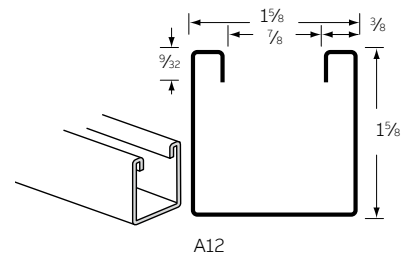

Product Code	Colour
--------------	--------

A12-

 = space for color identifier

G = Gray

W = White

B = Blue

Custom colors also available.

Stainless steel strut

Type 304 or Type 316 stainless – cold-roll formed for strength



Product features

- 12- or 14-gauge Type 304 or Type 316 stainless steel
- Available in 10-ft. (3.048m) and 20-ft. (6.096m) lengths with standard length tolerance of $\pm 1/8$ " (3.18mm)
- Choose standard or shallow and solid or half-slot style

Stainless steel strut

Type 304 Stainless Product Code	Type 316 Stainless Product Code	Style	Steel Thickness		Length		Width x Height	
			Gauge	(mm)	(ft.)	(m)	(in.)	(in.) (mm)
A1200 10SS	A120010T316SS	Standard	12	2.65	10	3.05	1.63 x 1.63	41.28 x 41.28
A1200 20SS	A120020T316SS	Standard	12	2.65	20	6.10	1.63 x 1.63	41.28 x 41.28
A1200HS 10SS	A1200HS10T316SS	Standard Half-Slot	12	2.65	10	3.05	1.63 x 1.63	41.28 x 41.28
A1200HS 20SS	A1200HS20T316SS	Standard Half-Slot	12	2.65	20	6.10	1.63 x 1.63	41.28 x 41.28
B1400 10SS	B140010T316SS	Shallow	14	1.89	10	3.05	1.63 x .81	41.28 x 22.23
B1400 20SS	B140020T316SS	Shallow	14	1.89	20	6.10	1.63 x .81	41.28 x 22.23
A1202HS10SS	A1202HS10T316SS	Back-to-Back Half-Slot	12	2.65	10	3.05	1.63 x 3.25	41.28 x 82.55
A1202HS20SS	A1202HS20T316SS	Back-to-Back Half-Slot	12	2.65	20	6.10	1.63 x 3.25	41.28 x 82.55

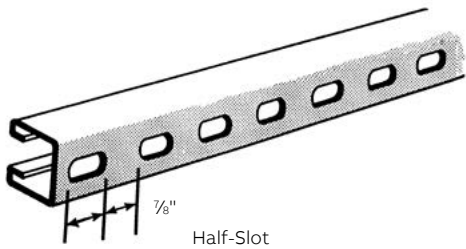
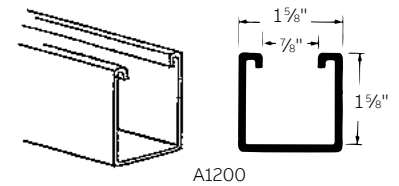
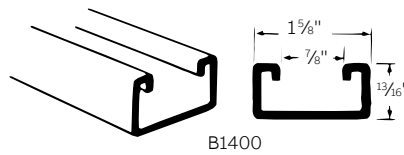
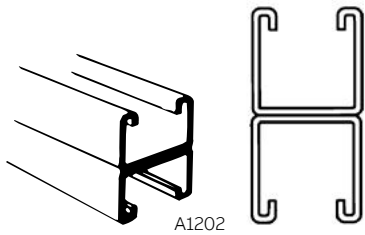

Stainless steel hardware accessories

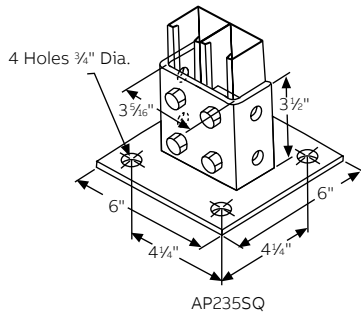
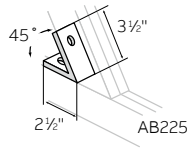
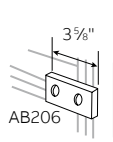
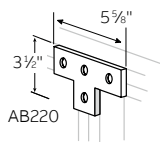
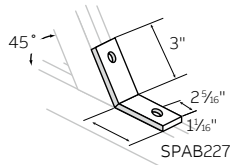
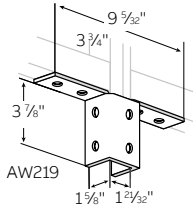
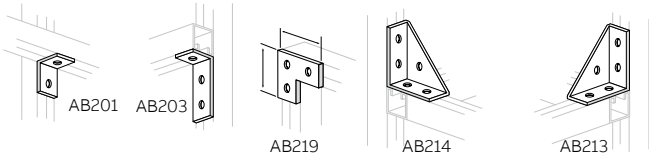

**E142
Hex Head
Cap Screw**



**H119
Rod Coupling**



**E145
Hex Nut**



**EF147
Fender Washer**



**AB241
Square Washer**

Type 304 Stainless Product Code	Type 316 Stainless Product code	Size (in.)
Flat Plate Fittings		
AB220SS	AB220SS316	5 5/8 x 3 1/2
AB207SS	AB207SS6C	5 3/8
X207SS	X207SS6C	7 1/4
AB206SS	AB206SS6C	3 5/8
90° Corner Fittings or Brackets		
AB201SS	AB201SS316	—
AB202SS	AB202SS316	1 5/8 x 2
AB203SS	AB203SS316	—
AB204SS	AB204SS316	2 1/4 x 3 5/8
AB213SS	AB213SS316	—
AB214SS	AB214SS316	—
AB219SS	AB219SS316	—
AW219SS	AW219SS316	9 5/8 x 3 7/8
AB205SS	AB205SS316	—
45° Fittings		
AB225SS	AB225SS316	3 1/2 x 2 1/2
SPAB227SS	AB227SS316	3 x 2 5/16
Pedestal Base		
AP232SS	AP232SS6	4 1/4 x 3 1/2
AP232SQSS	AP232SQSS6	4 1/4 x 3 1/2
AP235SS	AP235SS6	6 x 4
AP235SQSS	AP235SQSS6	6 x 4

Type 304 Stainless Product Code	Type 316 Stainless Product Code	Size (in.)
Spring Nut – Regular		
—	A100 1/4 SS	1/4
—	A100 5/16SS	5/16
—	A100 3/8 SS	3/8
Spring Nut – Short		
—	B100 1/4 SS	1/4
—	B100 3/8 SS	3/8
—	B100 1/2ss	1/2
Springless Nut		
—	AB100 1/4 SS	1/4
—	AB100 5/16SS	5/16
—	AB100 3/8 SS	3/8
Hex Head Cap Screw		
E142 (T) X (L) SS	E142 (T) X (L) SS316	—
Hex Nut		
E145 1/4 SS	—	1/4
E145 5/16SS	—	5/16
E145 3/8 SS	—	3/8
E145 1/2 SS	—	1/2
Fender Washer		
EF147 1/4 SS	—	1/4
EF147 3/8 SS	—	3/8
EF147 1/2ss	—	1/2
Square Washer		
AB241 1/4SS	AB241-1/4SS316	1/4
AB241 5/16SS	—	5/16
AB241 3/8 SS	AB241-3/8 SS316	3/8
AB241 1/2SS	AB241-1/2SS316	1/2
Rod Coupling		
H119 1/4SS	—	1/4
H119 3/8SS	—	3/8
H119 1/2SS	H119-1/2SS6	1/2
U-Bolt Beam Clamps		
U501SS	—	3 3/16H
U502ss	—	3 13/16H

All-thread rod

Continuously threaded rod for use with conduit hangers and strut to suspend overhead conduit runs

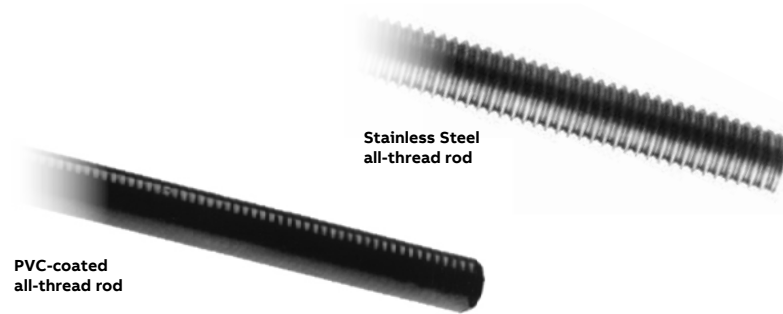

Product features

- All-thread steel rod coated with Nominal .007 - .015" (7 - 15 mil) PVC in blue, white or gray with custom colors available on request
- Available in 1/4", 3/8" or 1/2" standard diameters and in 3-, 6- or 10-ft. standard lengths
- Also available uncoated in Type 304 or Type 316 stainless steel
- Stainless steel all-thread rod comes in 3/8" or 1/2" diameters in 6-ft. standard lengths with other diameters and lengths available on request

Ocal® PVC-coated steel all-thread rod

Product Code	(in.)	Trade Size		Length
		(mm)	(ft.)	(mm)
THR1/4X10- <u> </u>	1/4	6.35	10.00	3.05
THR3/8X3- <u> </u>	3/8	9.53	3.00	0.91
THR3/8X6- <u> </u>	3/8	9.53	6.00	1.83
THR3/8X10- <u> </u>	3/8	9.53	10.00	3.05
THR1/2X3- <u> </u>	1/2	12.70	3.00	0.91
THR1/2X6- <u> </u>	1/2	12.70	6.00	1.83
THR1/2X10- <u> </u>	1/2	12.70	10.00	3.05

Stainless steel all-thread rod

Type 304 Stainless Product Code	Type 316 Stainless Product Code	(in.)	Trade Size (mm)	(ft.)	Length (mm)
H104-3/8X6SS	H104 3/8X6SS316	3/8	9.53	6.00	1.83
H104 3/8X12SS	H104-3/8X12SS6	3/8	9.53	12.00	3.66
H104-1/2X6SSC	H104-1/2X6SS6	1/2	12.70	6.00	1.83
H104 1/2X12SS	H104 1/2X12SS316	1/2	12.70	12.00	3.66

Product Code	Diameter x Length	Colour
--------------	-------------------	--------

THR 3/8 x 3-

 = space for color identifier

G = Gray 

W = White 

B = Blue 

Custom colors also available.

Ocal® PVC-coated hanger rod beam clamps

Corrosion-protected clamps for hanging threaded rod



500-G
Hanger Rod Beam Clamp

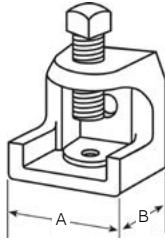

Product features

- Malleable iron construction
- Nominal .007 - .015" (7 - 15 mil) PVC coating in blue, white, gray or custom colors
- 500, 502 and 503 also available uncoated in Type 316 stainless steel; add -SS316 to catalog number to order (for example: 502-SS316)

Ocal® PVC-coated hanger rod beam clamps

Product Code	Base "A"		Base "B"		Jaw Opening		Tapped Hole		Load Rating [‡]	
	(in.)	(mm)	(in.)	(mm)	(in.)	(mm)	(in.)	(mm)	(lbs.)	(kg)
500- <u> </u>	1	25.40	1¼	31.75	15/16	23.81	¼-20	6.35 - 20	450	204.12
501- <u> </u>	1½	38.10	1⅝	41.28	7/8	22.23	15/16-18	7.94 - 18	800	362.87
502- <u> </u>	2	50.80	2	50.80	1	25.40	3/8-16	9.53 - 16	1300	589.67
503- <u> </u>	2⅝	66.68	2½	63.50	1	25.40	1/2-13	12.70 - 13	1300	589.67
508- <u> </u>	2½	63.50	2⅜	60.33	2⅛	53.98	1/2-13	12.70 - 13	1700	771.11

* Metric size designator (ANSI C80.1-1994).

‡ Load ratings based on bottom hole of beam clamp with safety factor of three.
CSA File No. LR-52208

Product Code	Colour
500- <u> </u>	<u> </u>
<u> </u>	= space for color identifier
G = Gray	
W = White	
B = Blue	
Custom colors also available.	

Ocal® PVC-coated mini conduit hangers

Includes stainless steel bolt and nut for fast, easy installation



MINE3/4-G
Mini Conduit Hanger

Product features

- Nominal .007 - .015" (7 - 15 mil) PVC coating in blue, white, gray or custom colors
- Rated for loads of up to 500 lbs. (226.80kg) with a safety factor of three

Ocal® PVC-coated mini conduit hangers

Product Code	Pipe Size (in.)	Metric Size Designator*
MINE1/2- <u> </u>	1/2	16
MINE3/4- <u> </u>	¾	21
MINE1- <u> </u>	1	27
MINE1-1/4- <u> </u>	1¼	35
MINE1-1/2- <u> </u>	1½	41

* Metric size designator (ANSI C80.1-1994).

Product Code	Pipe Size (in.)	Metric Size Designator*
MINE2- <u> </u>	2	53
MINE2-1/2- <u> </u>	2½	63
MINE3- <u> </u>	3	78
MINE3-1/2- <u> </u>	3½	91
MINE4- <u> </u>	4	103

Product Code	Colour
MINE1- <u> </u>	<u> </u>
<u> </u>	= space for color identifier
G = Gray	
W = White	
B = Blue	
Custom colors also available.	

Pipe straps for strut

Designed for easy attachment of conduit to strut



Stainless steel Cobra® clamp



PVC-coated pipe strap

Just twist-insert these pipe straps anywhere you need them along the slot side of a channel. For additional flexibility, you can position the straps as closely as your pipe couplings permit.

Product features

- Combination slot and hex head bolt for flexibility of attachment
- Captivated square nut on shoulder enables easy one-handed tightening
- Use with either 1⁵/₈" or 1¹/₂" strut for greater versatility
- Shipped pre-assembled for easier counting, sorting and handling
- Available with Nominal .007 - .015" (7 - 15 mil) PVC coating in your choice of blue, white or gray standard colors (custom colors also available on request)
- Or choose uncoated Cobra® Clamps in Type 316 stainless steel

Stainless steel Cobra® clamp – Type 316

Type 316 Stainless Product Code	Pipe Size (in.)	Metric Size Designator*
CPC075SS6	1/2	16
CPC100SS6	3/4	21
CPC100SS6	1	27
CPC150SS6	1 1/4	35
CPC150SS6	1 1/2	41
CPC200SS6	2	53
CPC250SS6	2 1/2	63
CPC100SS6	3	78
CPC350SST	3 1/2	91
CPC400SS6	4	103

* Metric size designator (ANSI C80.1-1994).

Note: Stainless steel strut straps are recommended only for use with stainless steel strut. Stainless steel straps may damage the PVC coating on PVCcoated strut.

Ocal® PVC-coated strut pipe straps

Ocal® PVC-Coated Strut Pipe Straps	Pipe Size (in.)	Metric Size Designator*
SS1/2- _	1/2	16
SS3/4- _	3/4	21
SS1- _	1	27
SS1-1/4- _	1 1/4	35
SS1-1/2- _	1 1/2	41
SS2- _	2	53
SS2-1/2- _	2 1/2	63
SS3- _	3	78
SS3-1/2- _	3 1/2	91
SS4- _	4	103
SS5- _	5	129

* Metric size designator (ANSI C80.1-1994).

Product Code Colour

SS-1

_ = space for color identifier

G = Gray

W = White

B = Blue

Custom colors also available.

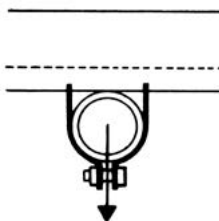
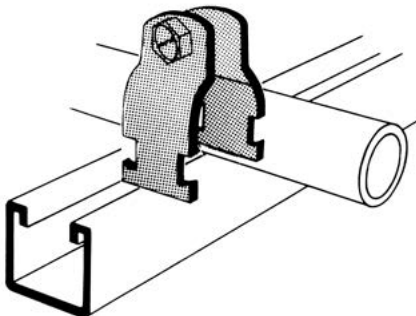

Trapnut® strut fastener

Fewer parts, less installation time and huge labor savings



The unique scissor action of the Trapnut® Strut Fastener closes at any desired position on the threaded rod. Once closed, precision threads trap the rod for a sturdy hold that can be adjusted up or down for fine-tune positioning. While the versatile Trapnut® Fastener has a locking pin that holds it in the desired position, it can also be removed and reused.

01 Hold in the open position

- No need to thread the Trapnut® Fastener from either end of the rod – saves valuable time
- Perfect for retrofit applications where the rod ends are not accessible

02 Insert the bottom plate on the rod and close the top plate.

- Precision threads trap the threaded rod for a sturdy hold that can be adjusted up or down for fine-tune positioning
- Functions as a hex nut, square washer and flat washer combined

03 Press the pin with pliers

- Locking pin holds Trapnut® Fastener in the desired position
- Can be removed and reused

04 Tighten to the desired position with pliers

- Can be adjusted up or down for fine-tune positioning
- Sturdy, load-bearing stainless steel construction
- Sized to provide custom fit for either 1 5/8" or 1 1/2" strut systems

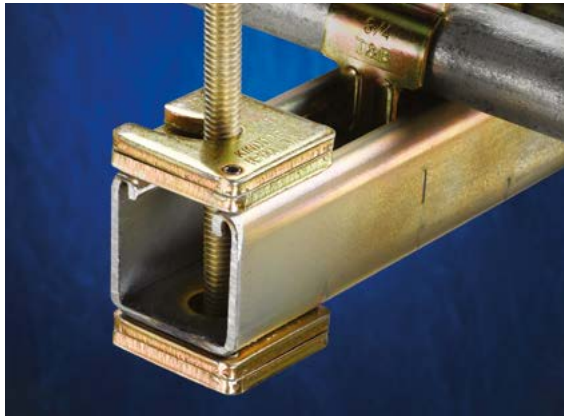

Unlike a hex nut, there's no need to thread the Trapnut® Fastener from either end of the rod, saving valuable time on the job. While the Trapnut® Fastener is a time-saver for new work, it's invaluable for retrofit applications. Rather than disassembling an existing trapeze to run additional conduit above it, simply clamp the Trapnut® Fastener between the trapeze and beam clamp for a speedy retrofit solution. Ideal for applications where the rod ends aren't accessible.

The Trapnut® Fastener offers sturdy, loadbearing steel construction for a solid installation. In addition, the Trapnut® Fastener functions as a hex nut, square washer and flat washer all in one, so there are fewer parts to keep track of on the job.

- Takes 30% less time than the traditional method on new work*
- Takes 43% less time than the traditional method on retrofit applications*

* Based on time study conducted by ABB comparing the time to install 15 feet of 2" conduit with typical trapeze assemblies using washers and nuts versus Trapnut® fasteners.

Type 316 stainless steel Trapnut® fastener

Product Code	Material	Size		Design Load	
		(in.)	(mm)	(lbs.)	(kg)
H122-1/4-SS6	Type 316 Stainless Steel	1/4	6.35	150.00	68.04
H122-3/8-SS6	Type 316 Stainless Steel	3/8	9.53	590.00	267.62
H122-1/2-SS6	Type 316 Stainless Steel	1/2	12.70	1080.00	489.88

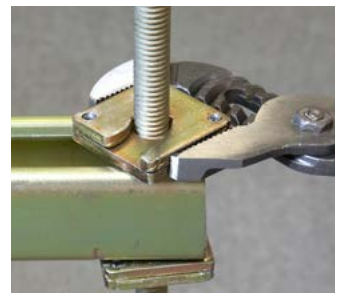
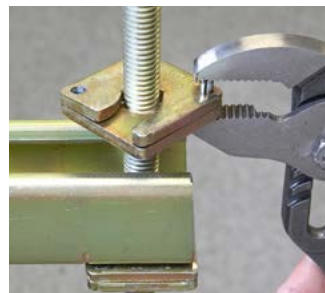
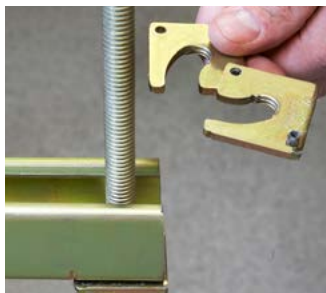

01

02

03

04

Ocal® Installation Products

The right tools for the job

ABB Ocal® PVC-Coated Conduit is designed to help prevent corrosion from striking weak points in conduit systems. But any PVC-coated conduit system is only as good as the installation job. The wrong tools can result in incorrectly installed pipes and fittings or damage to PVC coating, creating those weak points where corrosion starts.

After careful research and evaluation, ABB now offers you the very best installation tools available for PVC-coated conduit. These tools are ready for use on PVC-coated conduit right out of the box. What that means to the installer, is lower costs – in equipment, in installation time and in time normally spent adapting standard tools for use on PVC-coated conduit.

Hassle-Free Installation

Count on ABB to provide a hassle-free means for installers to get the right tools for the job in their hands – just another benefit of using Ocal® products.

For more information on Ocal® Installation Guidelines, see pages 80-86.



GREENLEE® Model 555 electric bender for PVC-coated conduit

Bends 1/2" through 2" PVC-coated conduit



When using this electric bending machine on 1/2" through 2" conduit, the shoes as well as the roller assembly should be of the type designed specifically for use with PVC-coated conduit.

When using conventional shoes, the shoes and each of the rollers in the roller assembly must be machined 60 thousandths. Some manufacturers use slide bars instead of a roller assembly, and these, too, must be machined 60 thousandths.

Be sure to compensate for "spring back," since PVC coating often requires the setting to be off as much as 5°.

GREENLEE® Model 555 electric bender for PVC-coated conduit

Product Code	Description
GBENDER	GREENLEE® Model 555 Bender
Shoes and roller kit for 40-mil PVC-coated conduit	
12586	1/2" – 2" Shoes and Roller Supports

Hand bender for PVC-coated conduit

Make saddles, offsets and conventional bends



Hand bender for PVC-coated conduit

Product Code	Conduit Size (in.)
35220	1/2
35225	3/4
2424A8	1

Ridgid stationary power threading machine

1224 Series

Stationary power threading machines such as the Ridgid model number 1224 have the capacity to thread rigid conduit from 1/2" to 4".



- The standard jaw inserts for these units are intended to secure uncoated rigid conduit. The teeth of the standard jaw inserts will penetrate the PVC coating, but not bite into the steel. As a result, the standard jaw inserts will grind the PVC coating off the conduit. To prevent this, shell style clamps or jaw inserts for coated conduit may be used.

- **Shell Clamps – Range: 1/2" to 3 1/2"**

To properly clamp the conduit, the shell style clamps described earlier can be used on conduit sizes from 1/2" to 1 1/2". However, for 4" conduit, there is not enough room in the chuck to accommodate both the 4 in. conduit and shell clamps.

- **Jaw inserts for coated conduit – Range: 1/2" to 4"**

The jaw inserts for coated conduit have a wider surface area to effectively grip the PVC coating. Ridgid Catalogue No. 26247 is the jaw insert for coated conduit used in the Ridgid 1224 threading machine.

There is no need to pencil cut or score the PVC because these threading machines use a roller cutter to remove 1/4 in. of the PVC coating. Cuttings simply fall onto the screen on the lower portion of the machine.

—
01 Special jaw insert
for PVC coated conduit
Ridgid model number
97365 and 26247

—
02 Standard jaw insert

—
03 In hot weather, use
scored shell clamps
to prevent slipping



—
01



—
02



—
03

Ridgid 700 portable threader and die heads

For PVC coated conduit



Handheld

The Ridgid #12R is typically used for smaller size conduit. The ratchet knob indicates forward and reverse. Die heads snap in from both sides and lock in place. (#12R includes ratchet and handle only)

Handheld powered

The Ridgid 700 Power Drive is a heavy duty handheld tool typically used for conduit up to 2 inches in diameter. The 700 Power Drive is designed for Ridgid 12R dies, available in both 115V and 230V models. Optional case is available for this tool.

Ridgid 700 portable threader

Product Code	Description
Ridgid 700 portable threader and die heads for PVC coated conduit	
51857	High speed 1/2" 12R die head for coated conduit
51862	High speed 3/4" 12R die head for coated conduit
51867	High speed 1" 12R die head for coated conduit
51872	High speed 1 1/4" 12R die head for coated conduit
51877	High speed 1 1/2" 12R die head for coated conduit
51882	High speed 2" 12R die head for coated conduit

Ridgid Tools 460-6

Tri-stand Chain vise



Product features

- Sturdy, stable frame collapses for easy mobility and storage
- Ceiling brace for overhead support enables you to secure frame even during difficult work
- Features recesses for bending tubes 3/8", 1/2" and 3/4" O.D.

Ridgid Tools 460-6

Product Code	Description	Pipe Capacity	
		in.)	Metric Size Designator*
Ridgid Tools 460-6	Tri-Stand with 6" Chain Vise (use with Ocal® Half-Shell Clamps)	1/2 - 6	16 - 155

* Metric size designator (ANSI C80.1-1994).

Ocal® Half-shell clamps

Superior design and construction for faster, safer chain-vise clamping of PVC-coated conduit.



Avoid the expense of purchasing a yoke vise with special jaws – or the trouble of making clamps out of PVC or steel pipe – to cut and thread PVC-coated conduit. These Half-Shell Clamps come in the full range of 1/2" to 6" trade sizes. Buy individual sizes, or choose our convenient set, which contains all the sizes from 1/2" to 2" in a handy carrying/storage case.

A unique internal design ensures secure clamping while protecting the integrity of the conduit's PVC coating. Cast from ductile iron for extreme strength and durability, Ocal® Half-Shell Clamps offer years of consistent, reliable service.

Product features

- Two-piece construction, cast from ductile iron for exceptional strength, durability and performance
- Cross-hatched interior surface grips conduit securely while safeguarding PVC jacket from damage
- Available individually in 1/2" through 4" trade sizes
- Also available in a convenient set – 1/2" to 2" trade sizes
- Each clamp clearly marked with trade size for easy identification
- Openings at each end enable hanging for handy storage

Aluminum pipe wrenches

Product Code	Conduit Size	
	(in.)	Metric
Individual Half-Shell Clamps		
HLF-SHL-CLP1/2	1/2	16
HLF-SHL-CLP3/4	3/4	21
HLF-SHL-CLP1	1	27
HLF-SHL-CLP1-1/4	1 1/4	35
HLF-SHL-CLP1-1/2	1 1/2	41
HLF-SHL-CLP2	2	53
HLF-SHL-CLP2-1/2	2 1/2	63
HLF-SHL-CLP3	3	78
HLF-SHL-CLP3-1/2	3 1/2	91
HLF-SHL-CLP4	4	103
Half-Shell Clamp Set (in carrying/storage case)		
HLF-SHL-CLP-SET1	1/2 - 2	78

* Metric size designator (ANSI C80.1-1994).

Ocal® Jaws for PVC-coated conduit

Designed to hold PVC-coated conduit securely in a yoke-style vise without damaging the conduit

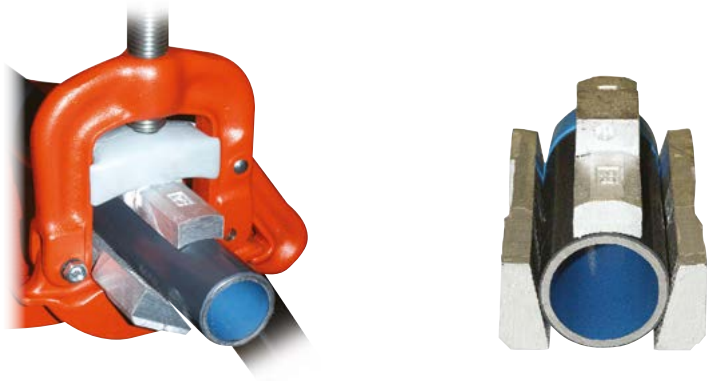

Product features

- Replaces the standard jaw inserts in a yoke vise
- Provides greater clamping force and prevents pipe from spinning during threading
- Machined aluminum construction
- Three-piece set

Ocal® Jaws for PVC-coated conduit

Product Code	Description	Weight	
		(lbs.)	(kg)
JAWS23	Use with RIDGID No. 23 and 40A Yoke Vises	2.80	1.27

Steel pipe cutters

Specially designed for cutting PVC-coated conduit



Product features

- Easy pressure control transmits optimum force onto tube
- Hardened, high-alloy steel cutter wheel provides long service life and burr-free external cutting

Ocal® Jaws for PVC-coated conduit

Product Code	Description	Pipe O.D.
P70045C	Steel Pipe Cutter – Up to 2"	1/8"–2"
P70060C	Steel Pipe Cutter – Up to 4"	1/8"–4"

Ratchet pipe reamer

Rapid and clean deburring



Product features

- Smooth-running ratchet
- Tempered-steel cutting bit
- For steel tubes 1/4" to 2" O.D.

Ratchet pipe reamer

Product Code	Description	Pipe O.D. (in.)
70289	Ratchet Pipe Reamer	1/4-2

Ocal® J-wrenches

Removable aluminum jaws for PVC-coated conduit

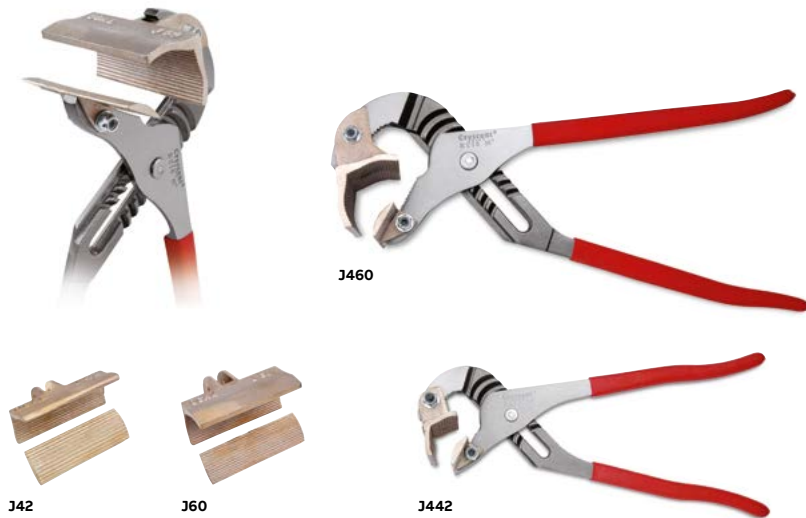

Use with our pliers, or purchase the jaws only and adapt your own!

Ratchet pipe reamer

Product Code	Description	Pipe Capacity (in.)
J442	12" J-Wrench with Jaws	1/2 - 1 1/4
J460	16" J-Wrench with Jaws	1 1/2 - 2 1/2
J42	12" Jaw Set only	1/2 - 1 1/4
J60	16" Jaw Set only	1 1/2 - 2 1/2

Strap wrenches

Specially coated strap won't absorb oil



Strap wrenches

Product Code	Handle Length		Strap Length		Strap Width		Pipe Capacity		Pipe Capacity (O.D.)		Weight	
	(in.)	(mm)	(in.)	(mm)	(in.)	(mm)	(in.)	(mm)	(in.)	(mm)	(lbs.)	(kg)
31355	11.75	298.45	17.00	431.80	1.75	44.45	2.00	50.80	3.50	88.90	1.75	.79
31370	18.00	457.20	29.25	742.95	1.75	44.45	5.00	127.00	5.50	139.70	2.75	1.25

KOPR-SHIELD® Joint compound

Protects, lubricates and enhances the conductivity of all electrical connections



Product features

- Meets NEC® requirements for protection against corrosion: “Where corrosion protection is necessary and the conduit is threaded in the field, all threads shall be coated with an approved electrically conductive, corrosion-resistant compound.”
- Extremely adhesive compound flows smoothly into uneven contours and voids, ensuring easy application and complete, positive protection and lubrication
- Won't settle out, thin, thicken, harden or dry out under the most severe environmental conditions
- Excellent temperature characteristics — can be brushed on at -50° F to 250° F (-45° C to 121° C) and remains intact for short periods even at 1,800° F (982° C)
- Helps ensure low resistance and seals out air and moisture
- Unique, homogenized blend of pure, polished colloidal copper, rust and corrosion inhibitors

NEC and National Electrical Code are registered trademarks of the National Fire Protection Association, Inc.

KOPR-SHIELD® Joint compound



Product Code	Container	Size
201-31879	Brush Cap Can	1½ oz. (.04 liter)
201-31879-1	Brush Cap Can	4 oz. (.12 liter)
CP8-TB	Brush Cap Can	8 oz. (.24 liter)
CP16	Brush Cap Can	1 pint (.47 liter)
CP128	Can	1 gallon (3.79 liter)

Note: Not recommended for food & beverage processing applications.

Ocal® Touch-up compounds

Fast-drying, air-cure patch for Ocal® conduit and fittings



Ocal® Touch-up compounds

Product Code	Container	Size	Color
Exterior PVC Patch			
SPRAY-G	Spray Can	12½ oz. (.37 liter)	Dark Gray
SPRAY-W	Spray Can	12½ oz. (.37 liter)	White
SPRAY-B	Spray Can	12½ oz. (.37 liter)	Light Blue
PATCHP-G	Brush Cap Can	1 pint (.47 liter)	Dark Gray
PATCHP-W	Brush Cap Can	1 pint (.47 liter)	White
PATCHP-B	Brush Cap Can	1 pint (.47 liter)	Light Blue
PATCHG-G	Bottle	1 gallon (3.79 liter)	Dark Gray
PATCHG-W	Bottle	1 gallon (3.79 liter)	White
PATCHG-B	Bottle	1 gallon (3.79 liter)	Light Blue
Interior Urethane Patch			
URETHANEPATCH	Brush Cap Can	1 pint (.47 liter)	Blue

Ocal® Heat-cure patch

A better patching solution for hot weather applications



Even in the best of installations, the PVC jacket on PVC-coated conduit or fittings can be cut, nicked or abraded. To maintain corrosion protection, Ocal® has added a new, thicker PVC patch to its offering of touch-up compounds.

Ideal for use in hot weather, Ocal® Heat-Cure Patch offers a thicker consistency at high ambient temperatures than standard air-cure patches, helping to ensure better coverage and a more effective patch.

Ocal® Heat-cure patch makes patching fast and easy.

1. Make sure the area to be patched is clean and dry.
2. Squeeze the amount of patch material needed onto the area to be repaired.
3. If necessary, spread and level the patch material with a putty knife.
4. Apply heat with a heat gun or torch, such as the ABB Portable Heat-Shrink Torch.
5. Being careful not to overheat (500° F/260°C max.), apply heat for two minutes total, or at least one minute after surface of patch has turned glossy. (The patch material is a glossy liquid that turns flat with initial heat application and then turns glossy again as heating continues.)
6. Allow the patched area to air cool, or use a water quench.

Ocal® Heat-cure patch

Product Code	Color	Size
PATCHT-G	Dark Gray	6 oz. (.18 liter)
PATCHT-W	White	6 oz. (.18 liter)
PATCHT-B	Light Blue	6 oz. (.18 liter)

ABB Portable heat-shrink torch

Separate controls enable precise adjustment of flame and temperature



Product features

- 2,500° F (1,371° C) output capacity satisfies virtually any heating, brazing or soldering requirement
- Dual fuel- and air-flow controls enable separate adjustment of temperature and flame precision
- Brass and steel construction provides durability
- Operates on standard butane lighter fluid (not included)
- Operating Time (per full fuel tank): Up to 220 minutes
- Fuel Tank Capacity: 2.03 fl. oz. / 60.03ml

Ocal® Touch-up compounds

Product Code	Description	Dimensions (without base)						Weight (when filled)	
		Length		Width		Height		(oz)	(g)
		(in.)	(mm)	(in.)	(mm)	(in.)	(mm)		
WT-PTORCH	Portable Heat-Shrink Torch	3.90	99.06	1.40	35.56	5.40	137.16	9.88	280.09

Electric heat gun



Product features

- UL® Listed
- 600° F to 950° F heat range
- Brass and steel construction provides durability
- 120VAC 60Hz

Electric heat gun



Product Code	Description	Pkg qty
WT1400	Dual-temp. heat gun 600° F/950° F, 1300W, 120VAC, 60Hz	1

Order multiple is std. pkg.

Technical information

Ocal® PVC exterior coating chemical resistance

Solutions	Recommended Exposure				
	Conc.	Temp.	Splashing	Liquid	Fumes
Acetic Acid	10%	120	no	no	no
Acid Copper Plating Solution		160	yes	yes	yes
Alkaline Cleaners		160	yes	yes	yes
Aluminum Chloride	Sat'd	160	yes	yes	yes
Aluminum Sulfate	Sat'd	160	yes	yes	yes
Alums	Sat'd	160	yes	yes	yes
Ammonium Chloride	Sat'd	160	yes	yes	yes
Ammonium Hydroxide	28%	120	yes	yes	yes
Ammonium Hydroxide	10%	120	yes	yes	yes
Ammonium Sulfate	Sat'd	160	yes	yes	yes
Ammonium Thiocyanate	Sat'd	160	yes	yes	yes
Amyl Alcohol	Any	90	yes	yes	yes
Arsenic Acids	Any	150	yes	yes	yes
Barium Sulfide	Sat'd	120	yes	yes	yes
Black Liquor	Sat'd	90	yes	yes	yes
Benzoic Acid	Sat'd	160	yes	yes	yes
Brass Plating Solution	Any	160	yes	yes	yes
Bromine Water	Sat'd	120	yes	yes	yes
Butyl Alcohol	Any	90	yes	yes	yes
Cadmium Plating Solution	Any	150	yes	yes	yes
Calcium Bisulfite	Any	150	yes	yes	yes
Calcium Chloride	Sat'd	160	yes	yes	yes
Calcium Hypochlorite	Sat'd	120	yes	yes	yes
Carbonic Acid	Sat'd	160	yes	yes	yes
Casein	Sat'd	90	yes	yes	yes
Castor Oil	Any	90	yes	yes	yes
Caustic Soda	35%	120	yes	yes	yes
Caustic Soda	10%	150	yes	yes	yes
Caustic Potash	35%	120	yes	yes	yes
Caustic Potash	10%	150	yes	yes	yes
Chlorine Water	Sat'd	90	yes	yes	yes
Chromium Plating Solution	Any	150	yes	yes	yes
Citric Acid	Sat'd	160	yes	yes	yes
Copper Chloride (Cupric)	Sat'd	160	yes	yes	yes
Copper Cyanide Plating Sol	Any	160	yes	yes	yes
(High Speed)	Any	180	yes	yes	yes
(with Alkali Cyanides)	Sat'd	160	yes	yes	yes
Copper Sulfate	Sat'd	160	yes	yes	yes
Coconut Oil	Sat'd	90	yes	yes	yes
Cottonseed Oil	Sat'd	90	yes	yes	yes
Disodium Phosphate	Sat'd	160	yes	yes	yes
Ethyl Alcohol	Any	90	yes	yes	yes
Ethylene Glycol	Any	90	yes	no	yes
Ferric Chloride	45%	120	yes	yes	yes
Ferrous Sulfate	Sat'd	150	yes	yes	yes
Fluoboric Acid	Any	150	yes	yes	yes
Formaldehyde	37%	120	yes	yes	yes
Formic Acid	85%	100	no	no	no
Gallic Acid	Sat'd	150	no	no	yes
Glucose	Any	150	yes	yes	yes
Glue	Any	150	yes	yes	yes
Glycerine	Any	90	yes	yes	yes

Solutions	Recommended Exposure				
	Conc.	Temp.	Splashing	Liquid	Fumes
Gold Plating Solution	Any	150	yes	yes	yes
Hydrochloric Acid	10%	120	yes	no	yes
Hydrochloric Acid	21.50%	120	yes	no	yes
Hydrochloric Acid	37.50%	120	yes	no	yes
Hydrochloric Acid	37.50%	90	yes	no	yes
Hydrofluoric Acid	4%	140	yes	no	yes
Hydrofluoric Acid	10%	120	yes	no	yes
Hydrofluoric Acid	48%	120	yes	no	yes
Hydrogen Peroxide	30%	120	yes	yes	yes
Hydrogen Sulfide	Sat'd	120	yes	yes	yes
Hydroquinone	Any	90	yes	yes	yes
Indium Plating Solution	Any	150	yes	yes	yes
Lactic Acid	50%	120	yes	yes	yes
Lactic Acid	Any	90	yes	yes	yes
Lead Plating Solution	Any	150	yes	yes	yes
Malic Acid	Any	90	yes	yes	yes
Methyl Alcohol	Any	90	yes	yes	yes
Mineral Oils	Any	90	yes	yes	yes
Nickel Acetate	Sat'd	160	yes	yes	yes
Nickel Plating Solution		160	yes	yes	yes
Nickel Salts	Sat'd	160	yes	yes	yes
Nitric Acid	35%	120	yes	no	yes
Nitric Acid	40%	90	yes	no	yes
Nitric Acid	60%	120	yes	no	yes
Nitric Acid/ Hydrofluoric Acid	15% 4%	140	yes	yes	yes
Nitric Acid/ Sodium Dichromate	16% 13%	130	yes	yes	yes
Water	71%				
Oleic Acid	Any	90	yes	yes	yes
Oxalic Acid	Sat'd	120	yes	yes	yes
	Any	90	yes	yes	yes
Phenol	Sat'd	120	no	no	no
Phosphoric Acid	75%	150	yes	yes	yes
Phosphoric Acid	85%	120	yes	yes	yes
Phosphoric Acid	85%	160	yes	yes	yes
Potassium Acid Sulfate	Sat'd	150	yes	yes	yes
Potassium Antimonate	Sat'd	150	yes	yes	yes
Potassium Bisulfite	Sat'd	90	yes	yes	yes
Potassium Chloride	Sat'd	160	yes	yes	yes
Potassium Cuprocyanide	Sat'd	150	yes	yes	yes
Potassium Cyanide	Sat'd	160	yes	yes	yes
Potassium Diachromate	Sat'd	160	yes	yes	yes
Potassium Hypochlorite	Sat'd	90	yes	no	yes
Potassium Sulfide	Sat'd	150	yes	yes	yes
Potassium Thiosulfate	Sat'd	150	yes	yes	yes
Propyl Alcohol	Sat'd	150	yes	yes	yes
Rhodium Plating Solution	Sat'd	150	yes	yes	yes
Silver Plating Solution	Sat'd	150	yes	yes	yes
Soaps	Any	90	yes	yes	yes
Sodium Acid Sulfate	Sat'd	160	yes	yes	yes
Sodium Antimonate	Sat'd	150	yes	yes	yes

Technical information

Ocal® PVC exterior coating chemical resistance (continued)

Solutions	Recommended Exposure				
	Conc.	Temp.	Splashing	Liquid	Fumes
Sodium Bicarbonate	Sat'd	160	yes	yes	yes
Sodium Bisulfite	Sat'd	90	yes	yes	yes
Sodium Chloride	Sat'd	160	yes	yes	yes
Sodium Cyanide	Sat'd	160	yes	yes	yes
Sodium Dichromate	Sat'd	160	yes	yes	yes
Sodium Hydroxide	10%	150	yes	no	yes
Sodium Hydroxide	35%	120	yes	no	yes
Sodium Hydroxide	73%	160	no	no	no
Sodium Hypochlorite	Sat'd	90	yes	no	yes
Sodium Hypochlorite	15%	120	yes	no	yes
Sodium Sulfide	Sat'd	150	yes	yes	yes
Sodium Thiosulfate	Sat'd	150	yes	yes	yes
Sulfuric Acid	15%	120	yes	yes	yes
Sulfuric Acid	15%	160	yes	yes	yes
Sulfuric Acid	50%	120	yes	yes	yes

Solutions	Recommended Exposure				
	Conc.	Temp.	Splashing	Liquid	Fumes
Sulfuric Acid	70%	90	yes	no	yes
Sulfuric Acid	98.00%	100	no	no	yes
Sulfurous Acid	2%	120	yes	no	yes
Sulfurous Acid	6%	120	yes	no	yes
Tannic Acid	Sat'd	90	yes	yes	yes
Tartaric Acid	Sat'd	90	yes	yes	yes
Tin Chloride Aqueous	Sat'd	150	yes	yes	yes
Tin Plating Solution	Sat'd	150	yes	yes	yes
Triethaneolamine	Sat'd	150	yes	yes	yes
Trisodium Phosphate	Sat'd	150	yes	yes	yes
Water	Sat'd	160	yes	yes	yes
White Liquor		90	yes	yes	yes
Zinc Plating Solution		160	yes	yes	yes
Zinc Sulfate	Sat'd	160	yes	yes	yes

Ocal® Urethane interior coating chemical resistance

Solutions	Recommended Exposure				
	Conc.	Temp.	Splashing	Liquid	Fumes
Acetic Acid	10%	75	yes	no	yes
Acid Copper Plating Solution	Any	75	yes	no	yes
Alkaline Cleaners	Any	75	yes	no	yes
Aluminum Chloride	Sat'd	75	yes	no	yes
Aluminum Sulfate	Sat'd	75	yes	no	yes
Alums	Sat'd	75	yes	no	yes
Ammonium Chloride	Sat'd	75	yes	no	yes
Ammonium Hydroxide	28%	75	yes	no	yes
Ammonium Hydroxide	10%	75	yes	no	yes
Ammonium Sulfate	Sat'd	75	yes	no	yes
Ammonium Thiocyanate	Sat'd	75	yes	no	yes
Amyl Alcohol	Any	75	yes	yes	yes
Arsenic Acids	Any	75	yes	no	yes
Barium Sulfide	Sat'd	75	yes	no	yes
Black Liquor	Sat'd	75	yes	no	yes
Benzoic Acid	Sat'd	75	yes	no	yes
Brass Plating Solution	Any	75	yes	no	yes
Bromine Water	Sat'd	75	yes	no	yes
Butyl Alcohol	Any	75	yes	no	yes
Cadmium Plating Solution	Any	75	yes	no	yes
Calcium Bisulfite	Any	75	yes	no	yes
Calcium Chloride	Sat'd	75	yes	no	yes
Calcium Hypochlorite	Sat'd	75	yes	no	yes
Carbonic Acid	Sat'd	75	yes	no	yes
Casein	Sat'd	75	yes	no	yes
Castor Oil	Any	75	yes	yes	yes
Caustic Soda	35%	75	yes	no	yes
Caustic Soda	10%	75	yes	no	yes

Solutions	Recommended Exposure				
	Conc.	Temp.	Splashing	Liquid	Fumes
Caustic Potash	35%	75	yes	no	yes
Caustic Potash	10%	75	yes	no	yes
Chlorine Water	Sat'd	75	yes	no	yes
Chromium Plating Solution	Any	75	yes	no	yes
Citric Acid	Sat'd	75	yes	no	yes
Copper Chloride (Cupric)	Sat'd	75	yes	no	yes
Copper Cyanide Plating Sol (High Speed)	Any	75	yes	no	yes
(with Alkali Cyanides)	Sat'd	75	yes	no	yes
Copper Sulfate	Sat'd	75	yes	no	yes
Coconut Oil	Sat'd	75	yes	yes	yes
Cottonseed Oil	Sat'd	75	yes	yes	yes
Disodium Phosphate	Sat'd	75	yes	no	yes
Ethyl Alcohol	Any	75	yes	no	yes
Ethylene Glycol	Any	75	yes	yes	yes
Ferric Chloride	45%	75	yes	no	yes
Ferrous Sulfate	Sat'd	75	yes	no	yes
Fluoboric Acid	Any	75	yes	no	yes
Formaldehyde	37%	75	yes	no	yes
Formic Acid	85%	75	yes	no	yes
Gallic Acid	Sat'd	75	yes	no	yes
Glucose	Any	75	yes	yes	yes
Glue	Any	75	yes	no	yes
Glycerine	Any	75	yes	yes	yes
Gold Plating Solution	Any	75	yes	no	yes
Hydrochloric Acid	10%	75	yes	no	yes
Hydrochloric Acid	21.50%	75	yes	no	yes
Hydrochloric Acid	37.50%	75	yes	no	yes

Technical information

Ocal® Urethane interior coating chemical resistance (continued)

Solutions	Recommended Exposure				
	Conc.	Temp.	Splashing	Liquid	Fumes
Hydrofluoric Acid	4.00%	75	yes	no	yes
Hydrofluoric Acid	10%	75	yes	no	yes
Hydrofluoric Acid	48%	75	yes	no	yes
Hydrogen Peroxide	30%	75	yes	no	yes
Hydrogen Sulfide	Sat'd	75	yes	no	yes
Hydroquinone	Any	75	yes	no	yes
Indium Plating Solution	Any	75	yes	no	yes
Lactic Acid	50%	75	yes	no	yes
Lactic Acid	Any	75	yes	no	yes
Lead Plating Solution	Any	75	yes	no	yes
Malic Acid	Any	75	yes	no	yes
Methyl Alcohol	Any	75	yes	no	yes
Mineral Oils	Any	75	yes	yes	yes
Nickel Acetate	Sat'd	75	yes	no	yes
Nickel Plating Solution		75	yes	no	yes
Nickel Salts	Sat'd	75	yes	no	yes
Nitric Acid	35%	75	yes	no	yes
Nitric Acid	40%	75	yes	no	yes
Nitric Acid	60%	75	yes	no	yes
Nitric Acid/ Hydrofluoric Acid	15% 4%	75	yes	no	yes
Nitric Acid/ Sodium Dichromate	16% 13%	75	yes	no	yes
Water	71%				
Oleic Acid	Any	75	yes	no	yes
Oxalic Acid	Sat'd	75	yes	no	yes
	Any	75	yes	no	yes
Phenol	Sat'd	75	yes	no	yes
Phosphoric Acid	75%	75	yes	no	yes
Phosphoric Acid	85%	75	yes	no	yes
Potassium Antimonate	Sat'd	75	yes	no	yes
Potassium Bisulfite	Sat'd	75	yes	no	yes
Potassium Chloride	Sat'd	75	yes	no	yes
Potassium Cuprocyanide	Sat'd	75	yes	no	yes
Potassium Cyanide	Sat'd	75	yes	no	yes
Potassium Diachromate	Sat'd	75	yes	no	yes
Potassium Hypochlorite	Sat'd	75	yes	no	yes

Solutions	Recommended Exposure				
	Conc.	Temp.	Splashing	Liquid	Fumes
Potassium Sulfide	Sat'd	75	yes	no	yes
Potassium Thiosulfate	Sat'd	75	yes	no	yes
Propyl Alcohol	Sat'd	75	yes	no	yes
Rhodium Plating Solution	Sat'd	75	yes	no	yes
Silver Plating Solution	Sat'd	75	yes	no	yes
Soaps	Any	75	yes	no	yes
Sodium Acid Sulfate	Sat'd	75	yes	no	yes
Sodium Antimonate	Sat'd	75	yes	no	yes
Sodium Bicarbonate	Sat'd	75	yes	no	yes
Sodium Bisulfite	Sat'd	75	yes	no	yes
Sodium Chloride	Sat'd	75	yes	no	yes
Sodium Cyanide	Sat'd	75	yes	no	yes
Sodium Dichromate	Sat'd	75	yes	no	yes
Sodium Hydroxide	10%	75	yes	no	yes
Sodium Hydroxide	35%	75	yes	no	yes
Sodium Hydroxide	73%	75	yes	no	yes
Sodium Hypochlorite	Sat'd	75	yes	no	yes
Sodium Hypochlorite	15%	75	yes	no	yes
Sodium Sulfide	Sat'd	75	yes	no	yes
Sodium Thiosulfate	Sat'd	75	yes	no	yes
Sulfuric Acid	15%	75	yes	no	yes
Sulfuric Acid	50%	75	yes	no	yes
Sulfuric Acid	70%	75	yes	no	yes
Sulfuric Acid	98%	75	yes	no	yes
Sulfurous Acid	2%	75	yes	no	yes
Sulfurous Acid	6%	75	yes	no	yes
Tannic Acid	Sat'd	75	yes	no	yes
Tartaric Acid	Sat'd	75	yes	no	yes
Tin Chloride Aqueous	Sat'd	75	yes	no	yes
Tin Plating Solution	Sat'd	75	yes	no	yes
Triethaneolamine	Sat'd	75	yes	no	yes
Trisodium Phosphate	Sat'd	75	yes	no	yes
Water	Sat'd	75	yes	no	yes
White Liquor		75	yes	no	yes
Zinc Plating Solution		75	yes	no	yes
Zinc Sulfate	Sat'd	75	yes	no	yes

Technical information

Ocal® Guide Specification:

Section 26 05 33 — Underground Ducts and Raceways for Electrical Systems:
Conduit Systems for Use in Corrosive Environments

Part 1 – General

1.1 Summary

- A. Section Includes: Furnishing, installation and assembly of PVC-coated electrical rigid metal conduit (ERMC) systems and stainless steel fittings.
- B. Related Sections
 - 1. Section 26 05 29 – Hangers and Supports for Electrical Systems

1.2 References

- A. National Electrical Manufacturers Association (NEMA)
 - 1. NEMA RN 1: Polyvinyl-Chloride (PVC) Externally Coated Galvanized Rigid Steel Conduit and Intermediate Metal Conduit
- B. National Fire Protection Association (NFPA)
 - 1. NFPA 70: National Electrical Code® (NEC®)
- C. American Society for Testing and Materials (ASTM):
 - 1. ASTM A 239: Standard Practice for Locating the Thinnest Spot in a Zinc (Galvanized) Coating on Iron or Steel Articles
- D. Underwriters Laboratories, Inc. (UL®)
 - 1. UL 6: Safety Standard for Rigid Metal Conduit
 - 2. UL 514B: Safety Standard for Fittings for Conduit and Outlet Boxes
- E. American National Standards Institute (ANSI)
 - 1. ANSI C80.1: American National Standard for Rigid Steel Conduit – Zinc Coated
- G. Steel Tube Institute of North America
 - 1. Guidelines for Installing Steel Conduit/Tubing

1.3 Submittals

- A. General: Submit in accordance with Section 01 33 00.
- B. Product Data
 - 1. Manufacturer's descriptive literature and product specifications for each product.
 - 2. Manufacturer's installation literature and training guide.
 - 3. Manufacturer's product drawings, when applicable.

1.4 Quality Assurance

- A. Manufacturer Qualifications: Products shall be free of defects in material and workmanship.
- B. Installer Qualifications: Installer shall be trained and certified based on the acceptable manufacturer's listed requirements.

Part 2 – Products

2.1 General

- A. Furnish PVC-coated ERMC of size as indicated. If not indicated, the smallest trade size shall be ¾ in. The PVC-coated ERMC system shall include necessary PVC-coated fittings, boxes and covers to form a complete encapsulated system.

2.2 Manufacturers

- A. Acceptable Manufacturers: ABB Corporation; Electrification Products division 860 Ridge Lake Blvd., Memphis, TN 38120. Tel: 901-252-5000. Web: www.tnb.com..
- B. Substitutions: Not permitted.
- C. Requests for substitutions will be considered in accordance with provisions of Section 01 25 00.

1.3 Materials/Components

A. PVC-coated rigid steel conduit

The PVC-coated rigid steel conduit shall be hot-dip galvanized inside and out with hot-dip galvanized threads. The interior galvanizing shall be listed per UL 6. The exterior galvanizing shall be listed per UL 6 as primary corrosion protection. Thread protectors shall be used on the exposed threads of the PVC-coated conduit. PVC-coated ERMC steel conduit shall comply with UL 6, ANSI C80.1 and NEMA RN 1 standards without exception.

The PVC coating, in compliance with NEMA RN 1, shall be nominal 40 mils in thickness continuous over the entire length of the conduit except at the threads and be free of blisters, bubbles or pinholes. PVC shall be UL listed as a primary corrosion protection.

A blue urethane coating shall be uniformly and consistently applied to the interior of conduit. This internal coating shall be a nominal 2 mils thickness. All male threads on elbows and nipples shall be protected by this same application of urethane coating.

Coated couplings shall be used with coated conduit. The thickness of the coating on couplings shall be at least equal to the thickness of the coating on the conduit. Each coated coupling shall have a flexible PVC sleeve which extends from each end of the coupling and which will overlap the PVC coating on the conduit when the coupling has been installed on the conduit.

Technical information

Ocal® Guide Specification (continued):

The length of the sleeve extension(s) shall be at least equivalent to the nominal conduit size for sizes up through 2 in. For sizes 2–6 in., the length of the sleeve extension(s) shall be at least 2 in. The PVC sleeve shall be a nominal thickness of 40 mils in thickness. The inside diameter of the overlapping sleeve shall be less than the outside diameter of the PVC-coated conduit.

The PVC coating, in compliance with NEMA RN 1, shall be nominal 40 mils in thickness continuous over the entire length of the conduit except at the threads and be free of blisters, bubbles or pinholes. PVC shall be UL listed as a primary corrosion protection.

A blue urethane coating shall be uniformly and consistently applied to the interior of conduit. This internal coating shall be a nominal 2 mils thickness. All male threads on elbows and nipples shall be protected by this same application of urethane coating.

Coated couplings shall be used with coated conduit. The thickness of the coating on couplings shall be at least equal to the thickness of the coating on the conduit. Each coated coupling shall have a flexible PVC sleeve which extends from each end of the coupling and which will overlap the PVC coating on the conduit when the coupling has been installed on the conduit.

B. PVC-coated rigid steel conduit

The PVC-coated ERMC aluminum conduit prior to coating shall be UL listed. The exterior of the conduit shall have a PVC coating of a minimum thickness of nominal 40 mils.

A blue urethane coating shall be uniformly and consistently applied to the interior of conduit. This internal coating shall be a nominal 2 mils thickness. All male threads on elbows and nipples shall be protected by this same application of urethane coating.

Coated couplings shall be used with coated conduit. The thickness of the coating on couplings shall be at least equal to the thickness of the coating on the conduit. Each coated coupling shall have a flexible PVC sleeve which extends from each end of the coupling and which will overlap the PVC coating on the conduit when the coupling has been installed on the conduit. The length of the sleeve extension(s) shall be at least equivalent to the nominal conduit size for sizes

up through 2 in. For sizes 2–6 in., the length of the sleeve extension(s) shall be at least 2 in. The PVC sleeve shall be a nominal thickness of 40 mils in thickness. The inside diameter of the overlapping sleeve shall be less than the outside diameter of the PVC-coated conduit.

C. PVC-coated ordinary location fittings

PVC-coated ferrous and aluminum fittings for general service and corrosive locations must be UL listed. The PVC coating shall be minimum 40 mils in thickness and be free of blisters, bubbles or pinholes. Female threads on fittings shall be protected by application of urethane coating.

All female ends of PVC-coated conduit fittings shall have a flexible PVC sleeve which extends from the female ends of the fitting and which will overlap the PVC coating on the conduit when the fitting has been installed on the conduit. The length of the sleeve extension(s) shall be at least equivalent to the nominal conduit size for sizes up through 2 in. For sizes 2–6 in., the length of the sleeve extension(s) shall be at least 2 in. The PVC sleeve shall be a nominal thickness of 40 mils in thickness. The inside diameter of the overlapping sleeve shall be less than the outside diameter of the PVC-coated conduit.

1. The PVC coating on all form 8 covers shall form a gasketlike flange of at least 5/16 in. wide and minimum 40 mils covering the top of the fitting around the opening and the bottom of the cover/mating with the flange of the fitting. A blue urethane coating shall be uniformly and consistently applied to the interior, exterior and threads of all conduit bodies, including but not limited to form 8 and form 7 conduit bodies. This coating shall be a nominal 2 mils thickness. Stainless steel encapsulated screws shall be Supplied with all form 7 and form 8 fittings.
2. Rigid hubs shall have a nominal 40 mils PVC coating thickness with a nominal 2 mils of blue urethane on interior and threads. The male threads and locknut shall remain uncoated.
3. Liquidtight fittings shall have an exterior PVC coating of a minimum thickness of nominal 40 mils.

Technical information

Ocal® Guide Specification (continued):

D. PVC-coated hazardous location fittings

Hazardous location fittings prior to PVC coating must be UL listed. All female ends of PVC-coated conduit fittings shall have a flexible PVC sleeve which extends from the female ends of the fitting and which will overlap the PVC coating on the conduit when the fitting has been installed on the conduit. The length of the sleeve extension(s) shall be at least equivalent to the nominal conduit size for sizes up through 2 in. For sizes 2–6 in., the length of the sleeve extension(s) shall be at least 2 in. The PVC sleeve shall be a nominal thickness of 0 mils in thickness. The inside diameter of the overlapping sleeve shall be less than the outside diameter of the PVC-coated conduit.

E. PVC-coated strut, hangers and clamps

Right-angle beam clamps and U-bolts shall be specially formed and sized to fit snugly the outside diameter of the PVC-coated conduit. Support products such as ferrous strut, beam clamps, pipe straps, clamp back spacers, conduit clamp hangers and all-thread rods shall have a minimum 15-mil PVC coating by the manufacturer of the ERM conduit and system components.

F. Stainless steel fittings

Stainless steel liquid-tight fittings shall be made of 304-grade stainless steel or better.

G. Stainless steel strut, hangers, etc.

Stainless steel strut, beam clamps, pipe straps, clamp back spacers, conduit clamp hangers and all-thread rods shall be made of 304-grade stainless steel or better.

Part 3 – Execution

3.1 Examination

A. The PVC-coated ERM conduit and system components have been selected for use in an atmosphere considered to be corrosive for this project. The corrosive atmosphere is considered to be more damaging than merely the presence of moisture. Accordingly, conduit and the corresponding fittings for it must have PVC protection as described under Part 2 – Products. Conduit and fittings that are merely galvanized for this purpose are insufficient.

3.2 Preparation

A. Preparation shall be done in accordance with manufacturer's printed instructions.

3.3 Installation

A. Install in accordance with manufacturer's printed instructions and manufacturer's installation training.

3.4 Quality control

A. General:
Comply with requirements of Section 01 45 13.

3.5 Manufacturer's field services

A. Free on-site installation training course by company representative. This representative must conduct the on-site training course in order to qualify for the installation certificate. The time required for this training is estimated to be two (2) hours.
B. After the on-site training installation, the representative shall then register the installer in his database and provide certification for installation.

End of section

Notes

- Ocal® PVC-coated conduit and fittings are not recommended for use in areas where they will be exposed to sustained temperatures above 200 degrees Fahrenheit or exposed to fire. Prolonged exposure to heat greater than 200 degrees Fahrenheit or exposure to fire may cause the plastic coatings to release harmful emissions, posing a potential health hazard to persons subjected to such emissions.
- If subjected to sustained flame or sustained heat above 400 degrees Fahrenheit, PVC will burn. PVC is self-extinguishing at room temperature.

Technical information

Recommended installation procedures

PVC-coated conduit is installed in much the same manner as conventional rigid galvanized steel conduit; however, certain precautions must be taken to protect the exterior coating and ensure satisfactory results. By following these guidelines and using the proper tooling, a damage-free installation can be achieved.

When an engineer has specified Ocal® PVC-coated conduit, the intent is for the total run to be PVC coated. There are no exceptions to this rule. This means from the beginning of the run to its completion and all in between, no exposed metal shall be allowed.

Clamping in a Yoke-style vise



Ocal Jaw Vise Adapters
JAWS23
See page 67

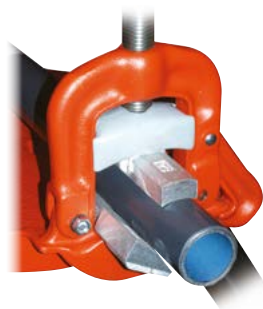

The PVC-coated conduit must be correctly clamped.

Replace both the upper and lower jaw inserts of the yoke-style vise with specially designed Ocal® jaw vise adapters. These adapters provide greater clamping force and prevent the pipe from spinning during the threading process. (See Catalog No. JAWS23 on page 67).

Clamping in a chain-style vise



Chain-style vise
Ridgid Tools 460-6
See page 65

If a chain-style vise is used, the chain – as well as the jaw inserts - can tear the PVC coating when the threading force is applied.

To prevent tearing, installers may make “shells” from PVC pipe or standard rigid steel conduit that fit over the PVC-coated conduit. To save time and obtain more consistency, longer life and better protection, use the Ocal® half-shell clamps featured on page 66.

Available in trade sizes ½" to 6", Ocal® half-shell clamps are made from ductile iron for superior strength and durability. They feature a cross-hatched interior surface designed to safeguard the PVC coating while holding the conduit securely in a chain-style vise.

Half-Shell Clamp Sets
HLF-SHL-CLP-SET1
See page 66



Half-Shell Clamps
for conduit sizes ½" to 6"
HLF-SHL-CLP-
See page 66

Technical information

Cutting with a band saw cutter

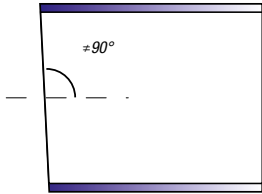

A band saw cutter will cut the PVC coating flush with the end of the conduit. PVC material cut flush to the end of the conduit will not allow the die teeth to bite into the steel to start the threading process.

Before threading, remove approximately 1/4" of the PVC coating from the end of the conduit. Using a knife, whittle in a pencil-sharpening style, cutting the coating from the conduit. A wire brush may also be used to remove PVC coating.

A band saw cutter will not easily cut the conduit at a "perfect" 90° angle (the accuracy of this cut depends heavily on the skill of the operator).



Cutting with a roller-style cutter

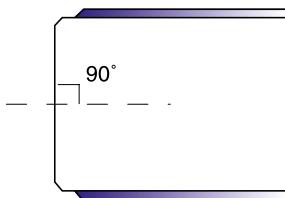

A roller-style cutter is the recommended tool for cutting Ocal® PVC-coated conduit.

A roller-style cutter cuts the edge of the conduit at a bevel and removes 1/4" of the coating at the same time. In addition, a roller-style cutter provides an exact 90° cut in relation to the conduit. No additional removal of PVC coating is necessary.

Steel Pipe Cutters
P70045C, P70060C
See page 67



Technical information

Manual and hand-held threading



51862

Ridgid Tools #700 threader
See page 65

PVC-coated conduit has a larger outer diameter than uncoated conduit. Standard dies will not clear the additional thickness. Hand-held as well as power threading devices require a die head for the correct size conduit. The standard die head is factory set for rigid conduit and will not fit over PVC coating.

Proper sized die heads are available from Ocal®, machined for use with PVC-coated conduit. Standard dies can also be machined to the proper size.

The following procedure is required for machined dies:

1. Remove the cover plate and the four die teeth.
2. Remove 100 thousandths of an inch ($\frac{1}{10}''$) from the throat and collar diameter of the die head.
3. Replace the dies and cover.

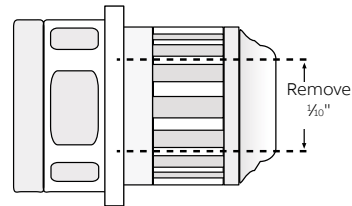

—
01 Throat & Collar Shown

—
02 Cover Plate Shown

—
03 The die teeth are cutting tapered threads and will become clogged with PVC and metal shavings.

—
04 To prevent clogging, use a knife and score the conduit lengthwise from the point where the threads will end to where they begin. This will allow the PVC and metal shavings to fall into the throat of the die head.



01



02



03



04



Technical information

Hand-held powered threading



Rothenberger Reamer
70289
See page 68

Handheld

The Ridgid #12R is typically used for smaller size conduit. The ratchet knob indicates forward and reverse. Die heads snap in from both sides and lock in place. (#12R includes ratchet and handle only)

Handheld powered

The Ridgid 700 Power Drive is a heavy duty handheld tool typically used for conduit up to 2 inches diameter. The 700 Power Drive is designed for Ridgid 12R dies, available in both 115V and 230V models. Optional case is available for this tool.

01 Ream the conduit with approved reamers. Spiral and straight-style reamers are both acceptable.

02 Ocal® Urethane Patching Compound See page 71

03 KOPR-SHIELD® See page 70



01



02



03

Technical information

Geared threading



Ridgid #700 threader
See page 65



Geared Threader ("Hog Head")

Geared threaders will thread 2½" through 6" PVC coated conduit but they are typically only used for 5" and 6" conduit. The cutting dies are adjustable and will not require pencil cutting the conduit.

The geared threader requires a clamp screw to secure the conduit and penetrate the PVC coating. If the clamp screw is not tight; it will slip around the conduit and tear the coating. After the threading process is complete, touch up the penetrated area with Ocal® exterior PVC patching compound (see pages 71–72).

Ream the conduit and dress the threads as previously described.

Stationary power threading



Ridgid Tools 1224
threader
See page 64

Stationary power threading machines such as **Ridgid model number 1224** have the capacity to thread rigid conduit from ½" to 4".

The standard jaw inserts with these units are intended to secure un-coated rigid conduit. The teeth of the standard jaw inserts will penetrate the PVC coating, but not bite into the steel. As a result, the standard jaw inserts will grind the PVC coating off of the conduit. Shell style clamps or jaw inserts for coated conduit may prevent the coating from grinding off.

Jaw inserts for coated conduit – Range: 1/2" to 4"

The jaw inserts for coated conduit have a wider surface area to effectively grip the PVC coating. Ridgid Catalogue No. 26247 is the jaw insert for coated conduit used in the Ridgid 1224 threading machine.

Technical information

Bending and hand bending



Chicago Bender



Hand Bender
See page 63

Bending

Never use any type of lubricant on the shoes of a bending device. Use rubbing alcohol to clean the shoe prior to bending.

Hand bending

A standard hand bender can be used for saddles, offsets and conventional bending. For PVC-coated conduit, the next larger shoe size from the EMT size should be used. The table below shows the catalog numbers of the hand benders on page 63 and the corresponding size of PVC-coated conduit on which they should be used.



Ocal® Heat-Cure Patch
See page 71



Ocal® Air-Cure
Patching Compounds
See page 72



Ocal® Heat-Cure Patch offers a thicker consistency at higher ambient temperatures than standard air-cure compounds, helping ensure better coverage and a more effective patch in warm weather applications.

Product Code	PVC-Coated Conduit Size
35220	1/2"
35225	3/4"
2424A8	1"

Technical information

Electric bending



Greenlee® Model 555 Bender and bending accessories for PVC-coated conduit
See page 63

These machines are designed for bending 1/2" through 2" conduit. The shoes as well as the roller assembly should be of the design for use with PVC-coated conduit. Listed along with the Greenlee® electric bender on page 61 are the bending accessories to equip the machine for PVC-coated conduit.

Conventional shoes on an electric bender and each of the rollers in the roller assembly must be machined to 60 thousandths. Although manufacturers use slide bars instead of a roller assembly, they must also be machined 60 thousandths. Compensate for "spring back," since PVC coating often requires the setting to be off as much as 5°.

Hydraulic bending

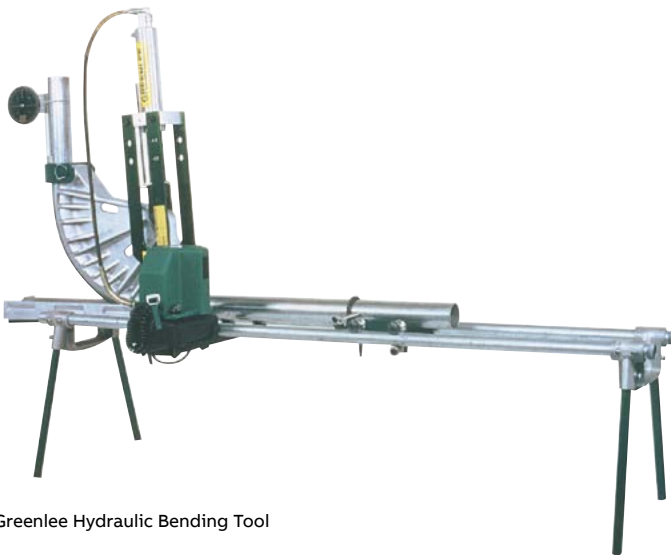

Greenlee Hydraulic Bending Tool

The preferred style of bending for 2 1/2" and larger size conduit. The shoe assembly should be of the design for PVC-coated conduit. The roller wheel and/or slide bar will accommodate PVC-coated conduit without the need for machining.

Note

Sequential bends can be manufactured by Ocal upon request. 5" and 6" conduit must be bent at the factory.



Shoe for Greenlee Hydraulic Bending Tool

Technical information

NEMA Standards Publication No. RN 1–2005

Section 3 – External coatings

3.1 Thickness

The thickness of polyvinyl chloride (PVC) coatings shall be a nominal .040 in. (1.02mm). The tolerance on the coating thickness shall be +.010 in. (.25mm) or -.005 in. (.13mm).

3.2 Coating Material

The PVC coating shall have the properties specified in Table 3.1.

Properties of PVC coatings – Table 3.1

Property	Minimum Requirement	ASTM Test Method
Hardness:		
Shore A	75	D 2240
Shore D	25	D 2240
Tensile Strength	2,000 psi	D 638
Elongation	200%	D 638
Dielectric Strength	325 volts per mil	D 149
Brittleness Temperature	5° F	D 1790

3.3 Application of coating

3.3.1 Cleaning

The exterior surface that is to receive the coating shall be free of grease, oil, dirt and other extraneous matter. The surface shall be cleaned in such a manner that the galvanized surface of the conduit is not harmed or eroded.

3.3.2 Priming

The cleaned exterior surface shall be primed with an adhesive suitable for use with the PVC coating material to be applied.

3.3.3 Coating

The PVC material shall be applied in powder, plastisol or pellet form by a manufacturing method which will produce a finished product conforming to these standards.

3.4 Elbows

Coated elbows shall be used with coated conduit. The thickness of the coating on elbows shall be in accordance with Section 3.1.

3.5 Couplings

Coated couplings shall be used with coated conduit. The thickness of the coating on couplings shall be at least equal to the thickness of the coating on the conduit.

Each coated coupling shall have a flexible PVC sleeve which extends from each end of the coupling and which will overlap the PVC coating on the conduit when the coupling has been installed on the conduit.

The length of the sleeve extension(s) shall be at least equivalent to the nominal conduit size for sizes up through NPS 2 (53). For sizes NPS 2½ (63) through NPS 6 (155), the length of the sleeve extension(s) shall be at least 2 in. (50.8mm).

The PVC sleeve shall be a nominal thickness of .040 in (1.02mm). The inside diameter (I.D.) of the overlapping sleeve shall be less than the outside diameter (O.D.) of the PVC-coated conduit.

3.6 Workmanship and appearance

The PVC coating shall be free of blisters, bubbles and pinholes. The PVC coating shall be continuous over the entire length of the conduit except at the threads and shall be holiday-free at the time of manufacture.

A holiday is herein defined as an electrical discontinuity of less than 80,000 ohms equivalent resistance sensed with a cellulose sponge wet with a suitable electrolyte and measured with an appropriate low voltage directcurrent instrument. A suitable electrolyte is a solution containing tap water, 3.0% salt (sodium chloride) and .5% liquid detergent.

The inside of the PVE-coated conduit, couplings and elbows shall be free of the PVC coating material.

All sleeve extensions shall be square cut.

3.7 Performance requirements

Typical physical requirements for PVC-coated conduit are given in Table 3.2.

Typical physical properties of PVC-coated rigid conduit and IMC – Table 3.2

Property	Requirement*	Test Method
Abrasion Resistance	200 hours, no failure	ASTM G6
Bendability, Radius	9 in. (228.6mm)	ASTM G10
Elongation	(228.6mm)	
Artificial Weathering	Minimum 1,000 hours, no adverse effect	ASTM G153

* The above requirements are based on testing a .040 in. (1.02mm) PVC coating applied over NPS ¾ inch galvanized rigid steel conduit. See Section 1 for information on the ASTM test methods.

3.8 Adhesion

The adhesion of the PVC coating to the conduit shall be greater than the strength of the coating itself. This shall be determined by making two circumferential cuts, above ½ in. (12.7mm) apart, through the plastic to the substrate. A third cut shall be made perpendicular to and crossing the circumferential cuts. The edge of the plastic shall be carefully lifted with a knife to form a plastic tab. This tab shall be pulled perpendicular to the conduit with a pair of pliers. The plastic tab shall tear rather than any additional coating film separating from the substrate.

Additional information

We reserve the right to make technical changes or modify the contents of this document without prior notice. With regard to purchase orders, the agreed particulars shall prevail. ABB AG does not accept any responsibility whatsoever for potential errors or possible lack of information in this document.

We reserve all rights in this document and in the subject matter and illustrations contained therein. Any reproduction, disclosure to third parties or utilization of its contents – in whole or in parts – is forbidden without prior written consent of ABB AG.



US

ABB Installation Products
Electrification Products division
860 Ridge Lake Blvd.
Memphis, TN 38120
+1 901-252-5000

tnb.abb.com

For other ABB locations visit new.abb.com/low-voltage

Canada

ABB Installation Products
Electrification Products division
700 Thomas Avenue
Saint-Jean-sur-Richelieu
Quebec, J2X 2M9
+1 450-347-5318

tnb.ca.abb.com