

CD HORIZON[®] SOLERA[®] 5.5/6.0

SPINAL SYSTEM

Surgical Technique

ENABLING TECHNOLOGIES

SERVICES & SUPPORT



**INTEGRATED
SPINE SOLUTIONS**

CAPSTONE[®] PEEK Spinal System, CLYDESDALE[®] Spinal System, CRESCENT[®] Spinal System—PEEK, CRESCENT[®] Spinal System—Titanium, and SOVEREIGN[®] Spinal System incorporate technology developed by Gary K. Michelson, MD.



Profile. Performance. Efficiency.

From the thoracic spine to the ilium, the CD HORIZON® SOLERA® Spinal System facilitates surgeon choice and flexibility across patient types with a variety of implant options for treating multiple spinal pathologies with one system family. The CD HORIZON® SOLERA® 4.75 Spinal System is detailed in another technique UC201105109EE. The CD HORIZON® SOLERA® 5.5/6.0 Spinal System offers the opportunity to reduce overall metal mass and profile, and provide surgeon choice without compromising implant integrity, as seen in mechanical testing when compared to the CD HORIZON® LEGACY™ System¹. Mechanical testing is not indicative of human clinical outcomes. The technology platform offered with this system is backed by more than 30 years and 600,000 cases of CD HORIZON® clinical experience and Medtronic expertise². The CD HORIZON® SOLERA® Spinal Systems is also compatible various enabling technologies that are complementary the therapy treatment.

Risks associated with these spinal implants include loosening, disassembly, bending and/or breakage of components.

¹ Based on mechanical testing of the CHROMALOY™ and CHROMALOY™ Plus rod construct per ASTM F1798.

² Based on internal sales estimates.

CD HORIZON[®] SOLERA[®] 5.5/6.0

SPINAL SYSTEM

Surgical Technique

Table of Contents

INTEGRATED Spine Solutions	1	Hook Surgical Technique	
Implant Features	4	Hook Implant	46
Instrument Set	6	Surgical Strategy	47
Pedicle Screw Surgical Technique		Hook Site Preparation, Options, and Insertion	48
Thoracic Facetectomy and Starting Points	16	Decortication	50
Screw Starting Points	17	Rod Contouring	50
Pedicle Preparation	18	Rod Insertion	51
Enabling Technologies	20	Deformity Correction	51
VERIFY [™] Implant Tracking System	21	Compression and Distraction	52
Screw Placement	22	Stabilization and Holding Rod Placement	52
Interbody or VBR Options	25	Final Tightening	53
Rod Selection	26	CD HORIZON [®] X10 CROSSLINK [®] Plate Placement and Closure	53
Rod Contouring and Placement	26	Suggestions to Explant the CD HORIZON [®] SOLERA [™] Spinal System	54
Provisional Driver Assembly	27	Product Ordering Information	56
Rod Reduction	28	Important Product Information	63
Apical Derotation	33		
Compression Distraction	36		
Iliac Fixation	38		
Final Tightening	39		
Bone Graft and Anti-Adhesion Options	40		
X10 CROSSLINK [®] Plate Placement	41		
Final Tightening of the Plate	43		
Postoperative Care and Mobilization	44		

Implant Features

BREAK-OFF SET SCREW



- Features a blunt start thread, reducing the chances of the set screw starting off-axis to the tulip
- The thread pattern on the set screw and the geometry of the tulip head forces the set screw to start in "one way."
- The reverse angle threadform maximizes the surface contact of the set screw threads with the tulip head
- The G4 reverse angle threadform patented technology also allows for a good tactile feedback and a reduced risk of head splay, hence reducing the chance of cross-threading
- The break-off patented technology improves security of final tightening by ensuring accurate tightening torque

ROD OPTIONS

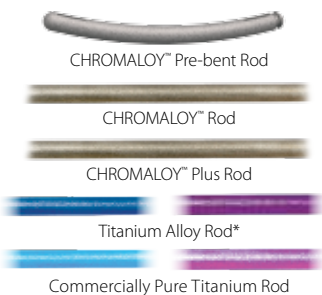

- Multiple material types and rod diameters for construct tailoring and intraoperative flexibility
- Precontoured and Precut CHROMALLOY™ and Commercially Pure Titanium rods
- Straight CHROMALLOY™, CHROMALLOY™ Plus, Commercially Pure Titanium, and Titanium Alloy Rods
- See "Product Ordering Information" on page 58 for the comprehensive list of rod options

CD HORIZON® X10 CROSSLINK PLATE®



- Compatible with CHROMALLOY™, CHROMALLOY™ Plus, and Titanium Rods
- Adjustable or fixed length options
- Adjustable plate attaches to the rod in the coronal, sagittal, or transverse planes in any orientation
- 6.35 X10 Crosslink® plate compatible with 6.0 rods diameter offering

CD HORIZON® LEGACY™ HOOKS*



- Compatible with CHROMALLOY™, CHROMALLOY™ Plus, and Titanium Rods
- Anatomic design to mimic the posterior spinal elements

CD HORIZON® LEGACY™ ILIAC SPINE SYSTEM*



- Closed fixed head iliac screws available in 0°, 10°, and 20° angles
- Closed Multi-Axial Screws (CMAS) provide flexibility to position the screw head
- Lateral connectors compatible with CHROMALLOY™, CHROMALLOY™ Plus, and Titanium Rods
- Lateral connectors allow medial/lateral adjustability which may prevent the need for coronal rod bending

Instrument Sets

PEDICLE PREPARATION AND SCREW SIZE SELECTION



In-Line Handle Round Awl
7480104



Thoracic Probe
8350294

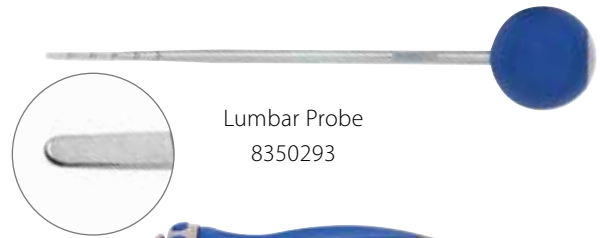

Lumbar Probe
8350293



Quick Connect Ratcheting Handle
G900000



Taps
8350421 (4.0mm)*
8350422 (4.5mm)
8350424 (5.5mm)
8350426 (6.5mm)
8350428 (7.5mm)*
8350430 (8.5mm)*
8350432 (9.5mm)*



Quick Connect Ratcheting T-Handle
G900100



Dual Ended Feeler Probe
7480100



Sounding/Feeler Probe, 2mm
8572102



Straight Holt Probe*
803-292



T-handle Holt Probe*
803-290

SCREW PLACEMENT



Fixed Angle Screw Lock Sleeve Driver
5584334



Lock Sleeve Multi-Axial Screwdriver
5584111



Dual Purpose Instrument
5584339



Multi-Axial Screwdriver*
5584109

*May be ordered as an extra instrument.

Instrument Sets

ROD HANDLING



50cm Rod Template
5484510



20cm Rod Template
5484520



Table Top Rod Cutter*
808-529



French Bender
7480162



Rod Introducer/Holder
5584312



Rod Inserter
7480126



Rod Pusher*
5584235
(Shown with Adjustable Driver Handle)

*May be ordered as an extra instrument

Instrument Sets

FINAL TIGHTENING/SET SCREWS



Dual Ended Set Screw Starter
5484302

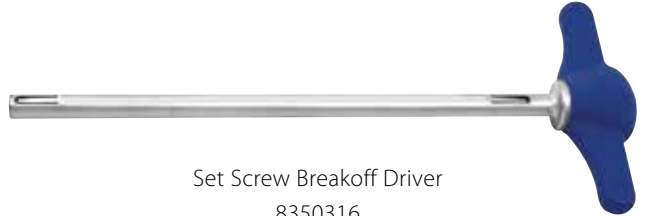

Set Screw Breakoff Driver
8350316



6.35mm Hex Shaft
Provisional Driver
5480131V

(Shown with Adjustable Driver Handle)



Adjustable Driver
Handle
5480140V



Counter Torque
5584150 – 5.5/6.0mm



Torque Indicating Driver*
5585147V



ROD REDUCTION



Beale Rod Reducer, Slots
5584134



Forceps Rocker
7480142



Beale Rod Reducer, Lateral
7480136



Rocker Pusher*
7480141

*May be ordered as an extra instrument

Instrument Sets

ROD REDUCTION CONTINUED

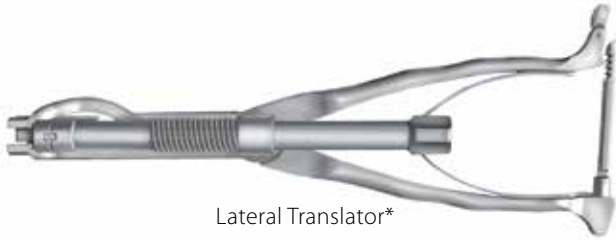

Lateral Translator*
5485904



Translator Driver*
5485905

SMARTLINK™ EXTENDERS AND DEROTATORS (OPTIONAL)



Open Extender
5485900 – 5.5/6.0mm



Closed Extender
5485901 – 5.5/6.0mm



Extender Guide
5485906 – 5.5/6.0mm



Reducer, HS
5485908 – 5.5/6.0mm

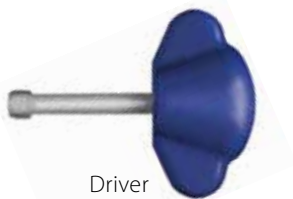

Driver
5485903 – 5.5/6.0mm



SMARTLINK™ Extender
(Shown Assembled)



Interlink*
5485911



Segmental Link*
5485910

*May be ordered as an extra instrument

Instrument Sets

ROD CORRECTION



Coronal Benders
Left 5584265
Right 5584270



In Situ Benders
Left 5584255
Right 5584260



Dual Action Rod Gripper
5584006



Rod Rotation Wrench
7480285

COMPRESSION AND DISTRACTION



Curved Compressor
5584165



Hinged Translator
5584172

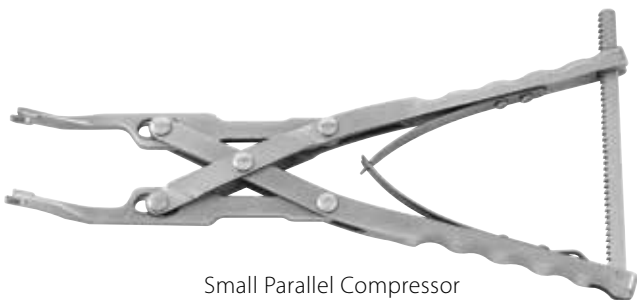

Small Parallel Compressor
7480165



Parallel Distractor
7480170



Distractor Pliers*
5584171

*May be ordered as an extra instrument

Instrument Sets

HOOK PREPARATION



Laminar Elevator
7480220



Pedicle Finder
7480225



Transverse Process Elevator
7480222

HOOK PLACEMENT



Hook Pusher for Implant Holder
7480231 – 5.5mm
7486231 – 6.35mm



Hook Pusher for Dual Purpose
7480230 – 5.5mm
74802301 – 6.35mm



Lateral Implant Holder
7480211 – 5.5mm
7486211 – 6.35mm



Straight Implant Holder
7480216 – 5.5mm
7486216 – 6.35mm

Instrument Sets

REMOVAL

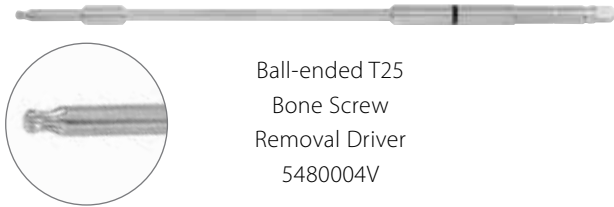

Ball-ended T25
Bone Screw
Removal Driver
5480004V

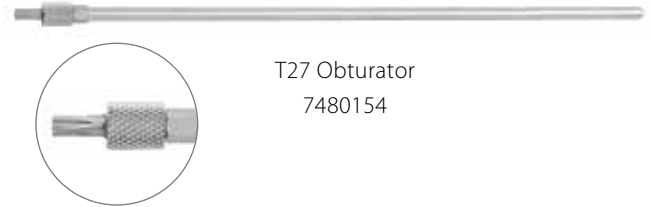

T27 Obturator
7480154



T25 Set Screw
Obturator*
8350322

ADDITIONAL



Torx 20 Shaft*
815-517

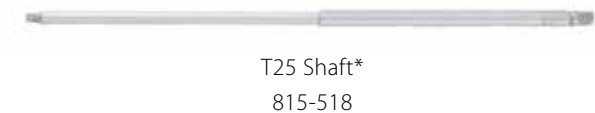

T25 Shaft*
815-518



Self-Retaining 3.5mm
Hex Driver*
7480114



Screw Head
Positioner Shaft
5584003

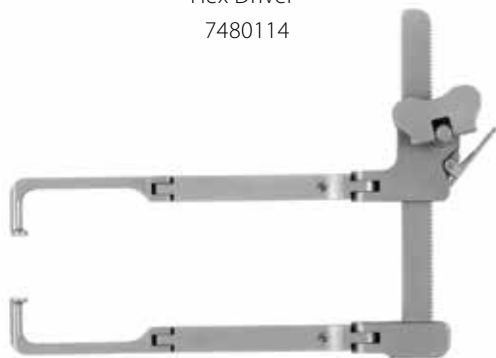

TLIF Distractor*
5584327



Hinged Translator*
Left
5584173

*May be ordered as an extra instrument

Instrument Sets

CD HORIZON® X10 CROSSLINK® PLATE INSTRUMENT SET



Measuring Card
8110501



T-bolt Implant Positioners
808-545

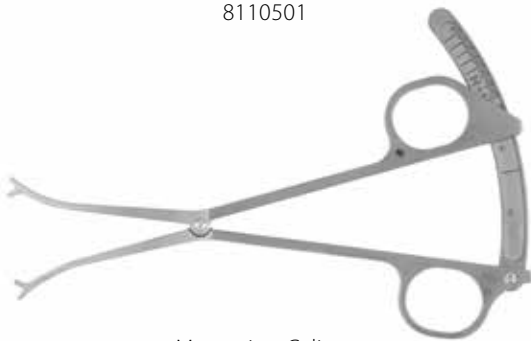

Measuring Caliper
8110502

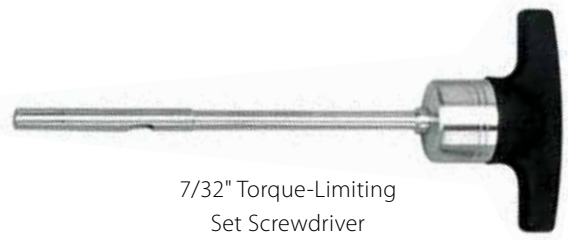

7/32" Torque-Limiting
Set Screwdriver
8110535



In-line Plate Holder
8110511



Counter Torque
8110540



3.0mm Hex Head Shaft, Removal Driver
8110530

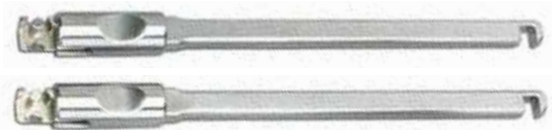

Plate Benders Bending Irons*
8110525

*May be ordered as an extra instrument

Pedicle Screw Surgical Technique

Thoracic Facetomy and Starting Points

Clean the facet joints and perform a partial inferior articular process osteotomy to enhance visualization and fusion. Remove 3mm to 5mm of the inferior facet and denude the articular cartilage on the superior facet, except for the lowest vertebra to be instrumented. This will allow for the intraoperative localization of the thoracic pedicle screw starting points.

Anatomic starting points vary by the posterior elements that can be observed intraoperatively. These include the transverse process, the lateral portion of the pars interarticularis, and the base of the superior articular process.

After a thorough exposure, use as much anatomic information as possible by starting with a neutral, non-rotated vertebra. The lateral and posterior views shown on the following page can be used as a guide for starting points and screw trajectory.

The first and extremely critical step to performing advanced deformity techniques is the safe and secure placement of segmental pedicle screws. Knowledge of the Superior Facet Rule (A) to direct the medial/lateral and the Cephalocaudal Starting Points (B) is a helpful reference to accomplish this.

Important: Do not start medial to the midpoint of the superior facet.

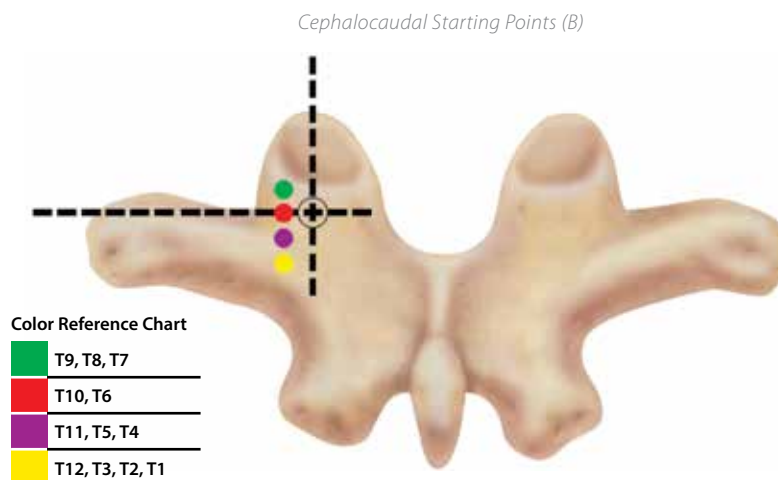
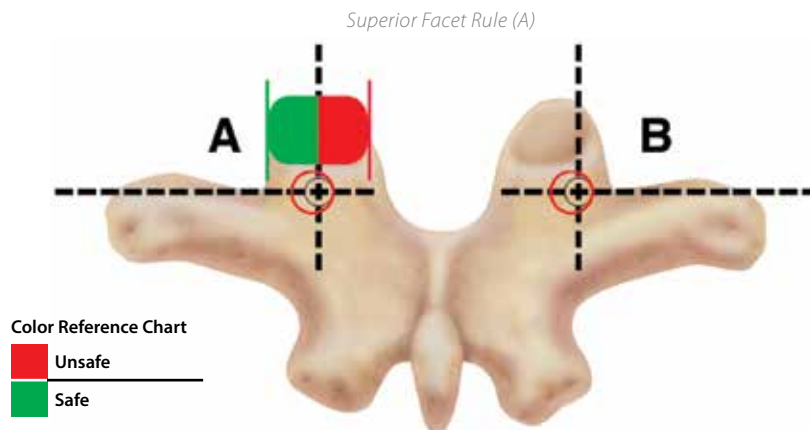

Screw Starting Points

Use Fixed Angle or Multi-Axial Screws for the straightforward approach (Blue Pins).
Use Multi-Axial Screws only for the anatomic approach (Green Pins).

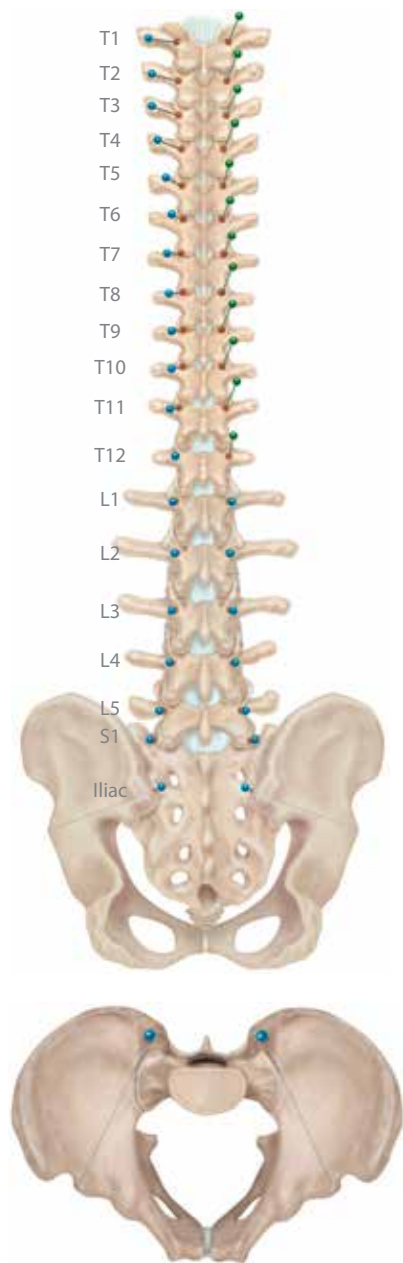

Axial View

Level	Cephalad-Caudad Starting Point	Medial-Lateral Starting Point
T1	Midpoint Transverse Process (TP)	Junction: TP-Lamina
T2	Midpoint TP	Junction: TP-Lamina
T3	Midpoint TP	Junction: TP-Lamina
T4	Junction: Proximal Third-Midpoint TP	Junction: TP-Lamina
T5	Proximal Third TP	Junction: TP-Lamina
T6	Junction: Proximal Edge-Proximal Third TP	Junction: TP-Lamina-Facet
T7	Proximal TP	Midpoint Facet
T8	Proximal TP	Midpoint Facet
T9	Proximal TP	Midpoint Facet
T10	Junction: Proximal Edge-Proximal Third TP	Junction: TP-Lamina-Facet
T11	Proximal Third TP	Just medial to lateral pars
T12	Midpoint TP	At the level of lateral pars
L1	Midpoint TP	Junction: Lateral pars and superior facet
L2	Midpoint TP	Junction: Lateral pars and superior facet
L3	Midpoint TP	Junction: Lateral pars and superior facet
L4	Midpoint TP	Junction: Lateral pars and superior facet
L5	Midpoint TP	Junction: Lateral pars and superior facet
S1	Midpoint Sacral Ala	Junction: Sacral ala and superior facet
Iliac	1cm Cephalad to Distal Posterior Superior Iliac Spine (PSIS)	1cm inferior to the superior PSIS on the medial slope

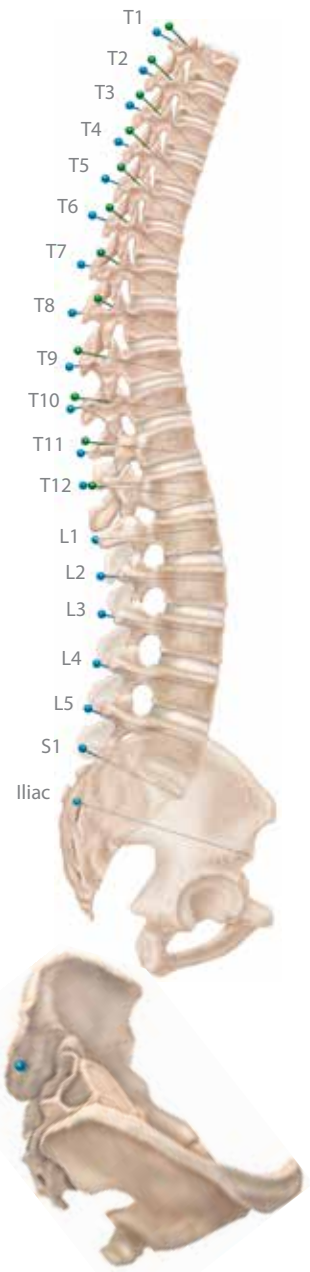

Oblique View

Pedicle Preparation

Create a 3mm-deep posterior cortical breach with a high-speed burr. A pedicle blush may be visualized suggesting entrance into the cancellous bone at the base of the pedicle. Occasionally, when preparing small pedicles located at the apex of the curve, the blush will not be evident due to the limited intrapedicular cancellous bone. In this case, use the Thoracic Probe to search in the burred cortical breach for the soft, funnel-shaped cancellous bone, which indicates the entrance to the pedicle. The tip should be pointed laterally to avoid perforation of the medial cortex (**Figure 1**).

Grip the side of the handle to avoid applying too much ventral pressure. Insert the tip approximately 20mm to 25mm (**Figure 2**), and then remove the probe to reorient it so that the tip points medially. Carefully place the probe into the base of the prior hole and use the instrument markings to advance the probe to the desired depth (**Figure 3**). Rotate the probe 180° to ensure adequate room for the screw.



Figure 1



Figure 2



Figure 3

Pedicle Preparation *continued*

Check to ensure that only blood is coming out of the pedicle and that the bleeding is not excessive. Using a flexible ball-tipped Sounding/Feeler Probe, advance the instrument to the base (floor) of the hole to confirm five distinct bony borders: a floor and four walls (medial, lateral, superior, and inferior) (**Figure 4**). Give special care to the first 10mm to 15mm of the tract. Cortically breached pedicles may be salvageable. When necessary, place bone wax in the pedicle hole to limit bleeding, then reposition the probe with a more appropriate trajectory.

Next, undertap the pedicle by 0.5mm to 1.0mm of the final screw diameter (**Figure 5**). Palpate the tapped pedicle tract with a flexible Sounding/Feeler Probe. Clamp a hemostat to the exposed Sounding/Feeler Probe and measure the length of the hole (**Figure 6**). Select the appropriate screw diameter and length by both preoperative measurement and intraoperative observation.

NOTE: Dual Lead taps can be ordered as an extra instrument. Although the OSTEOGRIP® thread design is different than previous designs, you can still select a tapping strategy based upon personal preference. In most instances we recommend under tapping by 1mm. If a pedicle seems particularly tenuous or brittle, then line-to-line tapping might be considered. In addition, due to the untapped second cortical thread, line to line tapping generates a significantly better sense of rigid fixation with the CD HORIZON® SOLERA™ screw as compared to prior systems. For example, you have the flexibility to follow a 5.5mm tap, which feels tight, with a 5.5mm screw and yet not compromise on fixation.



Figure 4



Figure 5

Figure 6

Enabling Technologies

Triggered intraoperative EMG monitoring, such as the NIM-ECLIPSE® Spinal System, may be used to verify the trajectory within the pedicle. The O-arm® Imaging System coupled with the StealthStation® Image Guidance System can also be used to navigate pedicle preparation and screw placement.

The POWEREASE® System is compatible with 4.75mm and 5.5/6.0mm CD HORIZON® SOLERA® System implants. The POWEREASE® System includes a rod cutter, and set screw break-off instruments that result in reduced physical fatigue for surgeons as compared to manual instruments (based on biomechanical testing and claims validation questionnaire using Likert scale and completed by nine surgeons). Biomechanical testing is not indicative of human clinical outcomes.



NIM-ECLIPSE® Spinal System

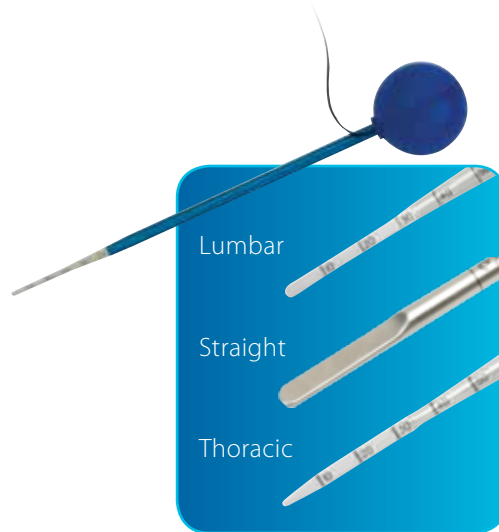

NIM® Pedicle Probes



NavLock™
Navigated Instruments



POWEREASE® System



O-arm® Imaging System



O-arm® and StealthStation® System Images

Verify™ Implant Tracking System

The CD HORIZON® SOLERA® Spinal System implants feature the VERIFY™ Implant Tracking System, a patent-pending traceability tool which enables electronic tracking and documentation of implant part and lot numbers to provide data management benefits for surgeons and hospitals. Each implant has a tag attached that is clearly marked with the part number, lot number, implant size, and a barcode (Figure 7). Contact your local Medtronic sales representative for detailed information on using the VERIFY™ Implant Tracking System.



Figure 7

Important: The implant tags must be removed prior to implantation. Do not implant the tags.

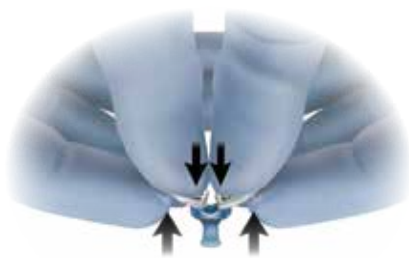

Figure 8

Prior to implantation remove the tags from the implants (Figure 8). Retain all of the implant tags so that they can be scanned at the end of the surgery. A tag sorter is available if the surgeon wants to track the implants by spinal level (Figure 9).



Figure 9

Screw Placement

QUICK CONNECT HANDLE

Attach the Quick Connect Handle to the Multi-Axial Screw Lock Sleeve Driver by snapping into place. A slight rotation of the Quick Connect Handle may be required to fully engage with the driver. To remove the Quick Connect Handle from the driver, press the cap on the handle to disengage the driver (Figure 10a and 10b).



Figure 10a

Figure 10b

SCREW ENGAGEMENT

After the Quick Connect Handle is assembled on the Lock Sleeve Driver, ensure that the blue locking cap is not engaged with the screwdriver shaft and then thread the driver shaft into the screw from the screw caddy (Figure 11). Slide the blue locking cap toward the screw to engage it with the driver shaft (Figure 12). An audible “click” will confirm engagement. Break off the VERIFY™ Implant Tracking Tag as shown (Figure 13) and place the tag in the Tag Sorter.

Important: The Multi-Axial Screw Lock Sleeve Driver locking cap must be disengaged while threading it into the threads of the bone screw tulip head. The locking mechanism of the driver may be damaged if it is advanced into the tulip head with the locking cap engaged.

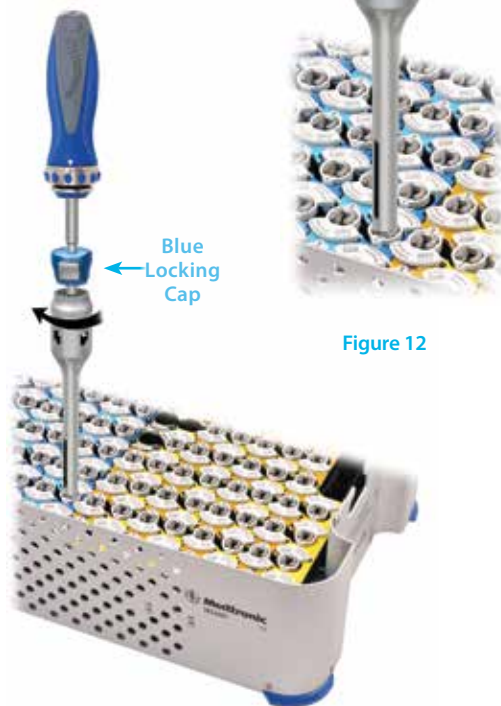

Figure 12



Figure 13

Figure 11

Screw Placement *continued*

The ring on the Quick Connect Handle determines the direction the screw will be driven by the Multi-Axial Screw Lock Sleeve Driver. Turn the ring clockwise to drive the screw into the pedicle (Figure 14). Turn the ring clockwise or counterclockwise to drive the screw into or out of the pedicle (Figure 15).



Figure 14

Important: If the button on the blue cap is locked and the driver is difficult to disengage, hold the screwdriver sleeve and twist the screw driver shaft counterclockwise. This will allow the button on the locking cap to release and disengage the screwdriver shaft from the screw.

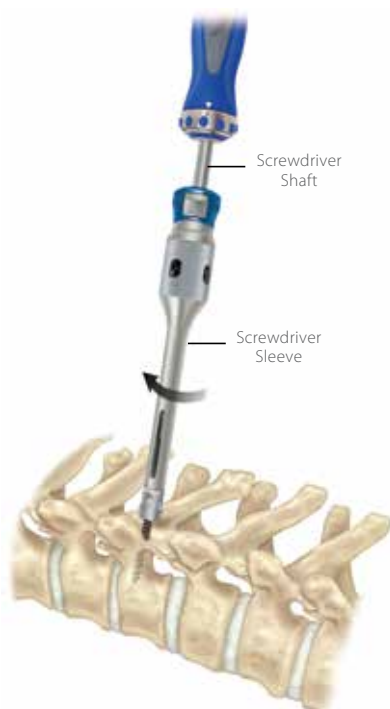

Figure 15

Slowly advance the screw down the pedicle to ensure proper tracking while allowing for viscoelastic expansion (Figure 16). Once the screw is inserted, push the button on the blue locking cap and slide it back toward the handle to disengage the driver (Figure 16). Finally, unthread the Lock Sleeve Multi-Axial Screw Driver from the screw.



Figure 16

Screws should be placed at every segment on the correction side and every third or fourth level on the stabilizing side. Insert at least two screws at the proximal and distal ends of the planned construct on the stabilizing side. For some pathologies, such as kyphosis and scoliosis, more screws are placed for greater construct rigidity. Screws should be checked radiographically at this time to ensure intraosseous screw placement.

Screw Placement *continued*

The Dual Purpose Driver should be used for Fixed Angle Screw placement. To engage the screw pull back on the ring to enlarge the tip of the driver and then release the ring to fully connect the driver to the screw (**Figure 17**). Once the screw is inserted, simply pull back on the ring to release the pressure on the implant head to disconnect the driver from the screw. (**Figure 18**).



Figure 17



Figure 18

ALTERNATIVE POWERED OPTIONS

Alternatively, the POWEREASE® System may be used to prepare and insert a pedicle screw (**Figure 19**). Similar to the quick connect handle, insert the desired drill bit, tap, or screw driver into the POWEREASE® handle. An audible "click" will confirm engagement. Confirm the driver is in the intended direction of use by rotating the collet on the handle and looking at the IPC™ monitor for drive direction

and speed settings. Gradually pressing the trigger will slowly advance the screw down the pedicle (**Figure 20**). EMG triggering may be conducted during pedicle preparation and screw placement to ensure the proper trajectory is followed. Once the screw is inserted, unthread the sleeve driver from the screw.



Figure 19



Figure 20

Interbody or Vertebral Body Replacement Options

Depending on the type of surgical technique and the patient pathology, a variety of interbody or vertebral body replacement options are available. Interbody implants are to be used with autogenous bone graft and supplemental fixation for fusion in patients with degenerative disc disease. Vertebral body replacement devices are to be used with autograft or allograft and supplemental fixation to replace a collapsed, damaged, or unstable vertebral body due to tumor or trauma. For comprehensive instructions for implantation of these implants, refer to their respective surgical techniques.



*Supplemental fixation is only required for this device when the surgeon chooses to use less than three or none of the provided screws.

Rod Selection

SPINAL ROD SELECTION AND REDUCTION OPTIONS

The CD HORIZON® SOLERA® Spinal System offers a full spectrum of rods with different material types to facilitate intraoperative construct tailoring. The available rod options allow for a full range of pathologies to be addressed with a reduction in hospital inventory due to the accommodation of multiple materials and rod sizes as compared to previous implant systems.

PRE-BENT RODS

These rods range in lengths from 30mm to 120mm in 5mm increments (**Figure 21**). The pre-bent rods reduce the steps associated with measuring, cutting, and bending straight rods during lumbar fusion surgeries. The pre-bent rods have short lines on each end for alignment during rod placement.

500MM STRAIGHT RODS

There are many types of 500mm straight rods and each rod type has different strength characteristics. The choice of the rod material depends upon the patient pathology, bone quality, and construct strength requirements as determined by the surgeon.

Rod Options	5.5mm	6.0mm
Pre-bent CHROMALOY™	•	
Pre-bent Commercially Pure Titanium	•	
Straight Titanium Alloy	•	•
Straight Commercially Pure Titanium	•	•
Straight CHROMALOY™	•	•
Straight CHROMALOY™ Plus	•	•

Note: Prior to implantation, break off the VERIFYI™ Implant Tracking Tag and retain it in the Tag Sorter so that it can be scanned at the end of the surgery.



Figure 21

Rod Contouring and Placement

Once correct screw placement has been verified radiographically, measure and contour the selected rods in the sagittal and coronal planes. A rod template may be used to measure the rod length required for the construct (**Figure 22**). A rod cutter (handheld or table top) may be used to cut the appropriate rod length.

The Titanium Alloy rods have an orientation line that serves as a reference point during contouring. Clamping the rod with Dual Action Rod Grippers at both ends helps prevent the rod from rotating during contouring (**Figure 23**).

NOTE: Prior to implantation of the rod, break off the VERIFYI™ Implant Tracking Tag and retain it in the Tag Sorter so that it can be scanned at the end of the surgery.



Figure 22



Figure 23

Provisional Drive Assembly

The Provisional Driver assembly consists of a handle and a separate insert shaft. The instrument set contains a Provisional Driver insert shaft and a Rod Pusher insert shaft. When assembling either insert shaft, align the black laser markings on the shaft with the black line on the handle and insert the shaft (**Figure 24**). When the insert shaft stops push the button on the handle and insert until it stops again (**Figure 25**). Turn the shaft 90° following the black line on the shaft (**Figure 26**). Push the shaft toward the handle until it locks into place. The driver is now locked in the short position (**Figure 27a**).

The Provisional Driver has a short and an extended position. The push button on the handle allows the driver to lock in the two different positions. The short position is used for tightening the set screw while the extended position allows use through the Beale Rod Reducer or a Sequential Reducer.

To use the driver in the extended position, push the button and start pulling the insert shaft out from the short position. Release the button and continue pulling the shaft out until the button engages with an audible "click" (**Figure 27b**).

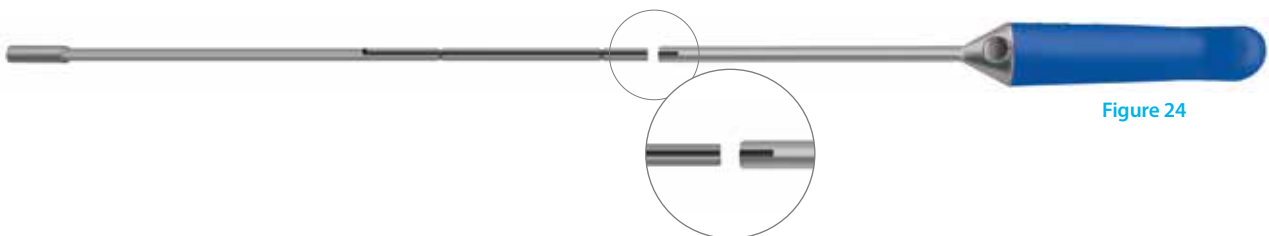

Figure 24

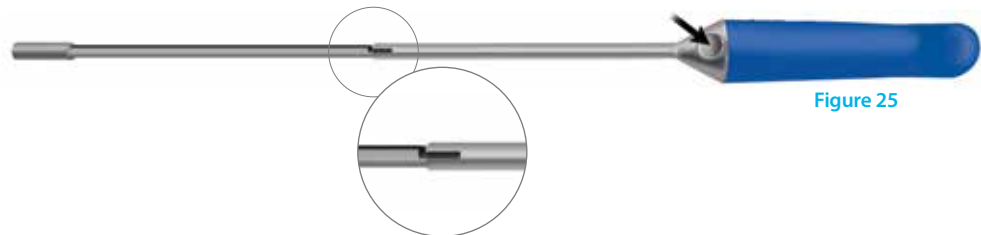

Figure 25

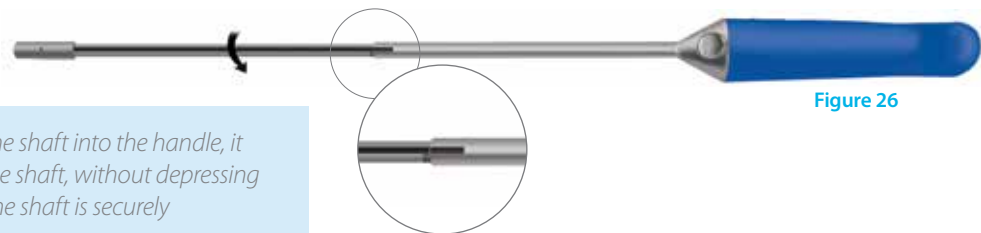

Figure 26

Important: After locking the shaft into the handle, it is advised to pull back on the shaft, without depressing the button, to ensure that the shaft is securely attached to the handle.



Figure 27a



Figure 27b

Note: This instrument requires disassembly for proper sterilization after surgery.

Rod Reduction

For non-hyperkyphotic deformities, place the rod on the concave side first. The contoured rod is introduced into the previously placed screws. There are several methods and instruments that facilitate fully seating the rod into the saddle of the implant.

Important: Care should be taken with any of the following reduction methods. Improper instrument use may loosen implants or damage the residual facets and other bony anatomy.

Important: As the Cobalt Chrome material is stiffer than Titanium material, reduction tools or manual reduction techniques must be used for rod manipulation or to seat the rod into the tulip head. Never use the set screw to reduce a spinal rod because the force applied by a set screw may not be able to fully seat the rod into the saddle of the screw.

FORCEPS ROCKER METHOD

Use of the Forceps Rocker is an effective method for reducing (or seating) the rod into the implant when only a slight height difference exists between the rod and the implant saddle. To use the Forceps Rocker, grasp the sides of the implant with the rocker cam above the rod and then lever backward over the rod (**Figure 28**). The levering action allows the rod to be fully seated into the saddle of the implant. The Dual Ended Set Screw Starter is then used to introduce the set screw (**Figure 29**).

ROCKER* PUSHER METHOD

The Rocker Pusher can also be used to achieve rod reduction. To use this rocker, grasp the sides of the implant with the rocker cam above the rod, squeeze the handle to secure the instrument to the implant, and then lever the instrument backward over the rod (**Figure 30**). The levering action allows the rod to be fully seated into the implant saddle. To remove the instrument, press the blue button on the top of the instrument.

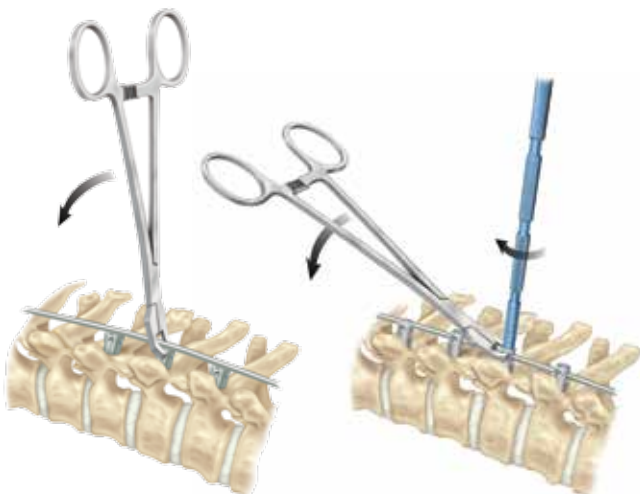

Figure 28

Figure 29



Figure 30

*May be ordered as an extra instrument

Rod Reduction *Continued*

BEALE ROD REDUCER

In situations where the rod rests at the top of the implant, the Beale Rod Reducer may be used to seat the rod. The Beale Rod Reducer attaches to the four implant slots (**Figure 31**).

Once the Beale Rod Reducer is attached to the implant, squeeze the reducer handles slowly, allowing the sleeve to slide down, and seat the rod into the implant saddle.

The set screw is then placed through the reducer tube and into the implant head with the Provisional Driver or a Dual Ended Set Screw Starter. Provisionally tighten the set screw with the Provisional Driver in the extended position (**Figure 32**).

Note: Prior to implantation of the set screw, break off the VERIFY™ Implant Tracking Tag and retain it in the Tag Sorter so that it can be scanned at the end of the surgery.



Figure 31



Figure 32

Rod Reduction *Continued*

5.5/6.0MM LATERAL TRANSLATOR

In situations where the rod rests medial or lateral to the top of the implant, the Lateral Translator may be used to align the implant and rod, and sequentially reduce the rod into the implant. Attach the instrument to the implant head by tilting it from the curved arm and squeeze the handles to engage fully the rack until the last fourth ridge. **(Figure 33)**. Once alignment has been achieved, the spinal rod can be reduced into the implant by attaching the Translator

Driver and rotating clockwise until the rod is seated while maintaining the lateral translator. **(Figure 34)**. Towards the end of the reduction make sure the instrument is perpendicular to the rod. Using the Dual Ended Set Screw Starter or Provisional Driver, a set screw can be introduced through the cannula of the Lateral Translator to provisionally tighten the set screw **(Figure 35)**. To remove the instrument from the implant, release the handle and pull the instrument up.

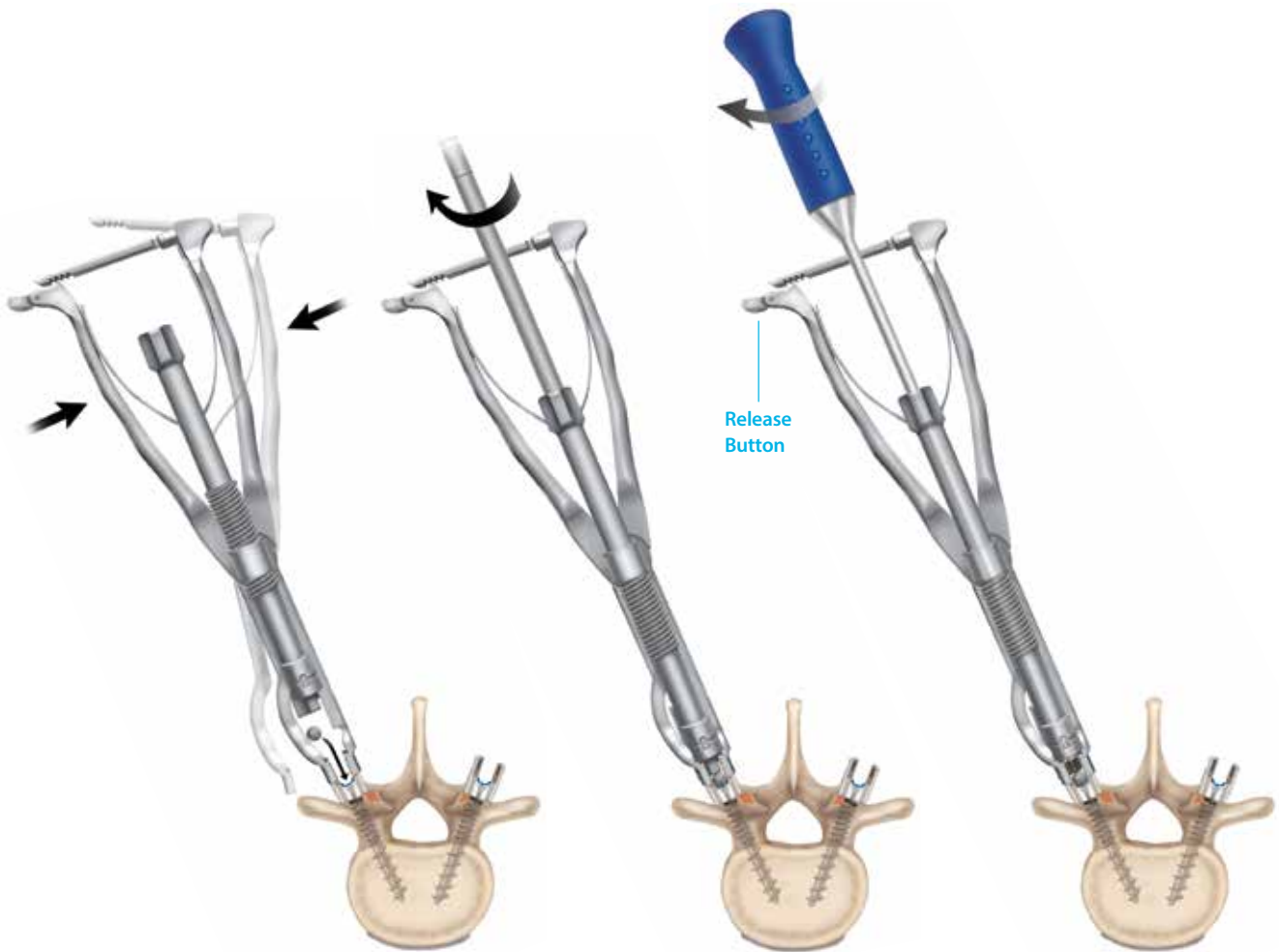

Figure 33

Figure 34

Figure 35

Rod Reduction *Continued*

SMARTLINK™ EXTENDERS

The SMARTLINK™ Extenders may be used to gradually align and seat a 5.5mm or 6.0mm rod into 5.5/6.0mm implants. Two extenders are available, an Open and a Closed Extender. To attach either extender to a bone screw, slide the green sleeve to the unlocked position and dock the extender to the top of the screw head, aligning the implant slots to the instrument (**Figure 36**). Once aligned, lock the Extender to the implant by pushing the green sleeve downward until the top surface of the sleeve is flush with the Extender (**Figure 37**).

To use the Open Extender more easily with Multi-Axial Screws, engage the Extender Guide. Slide the green sleeve on the Open Extender to the unlocked position and insert the Extender Guide. The Extender Guide docks into the Multi-Axial Screw rod slot and aligns the Open Extender (**Figure 38**). Once the Open Extender is aligned, slide the green sleeve downward into the locked position and remove the Extender Guide. Please note that the Extender Guide may not be used if the rod has already been placed.

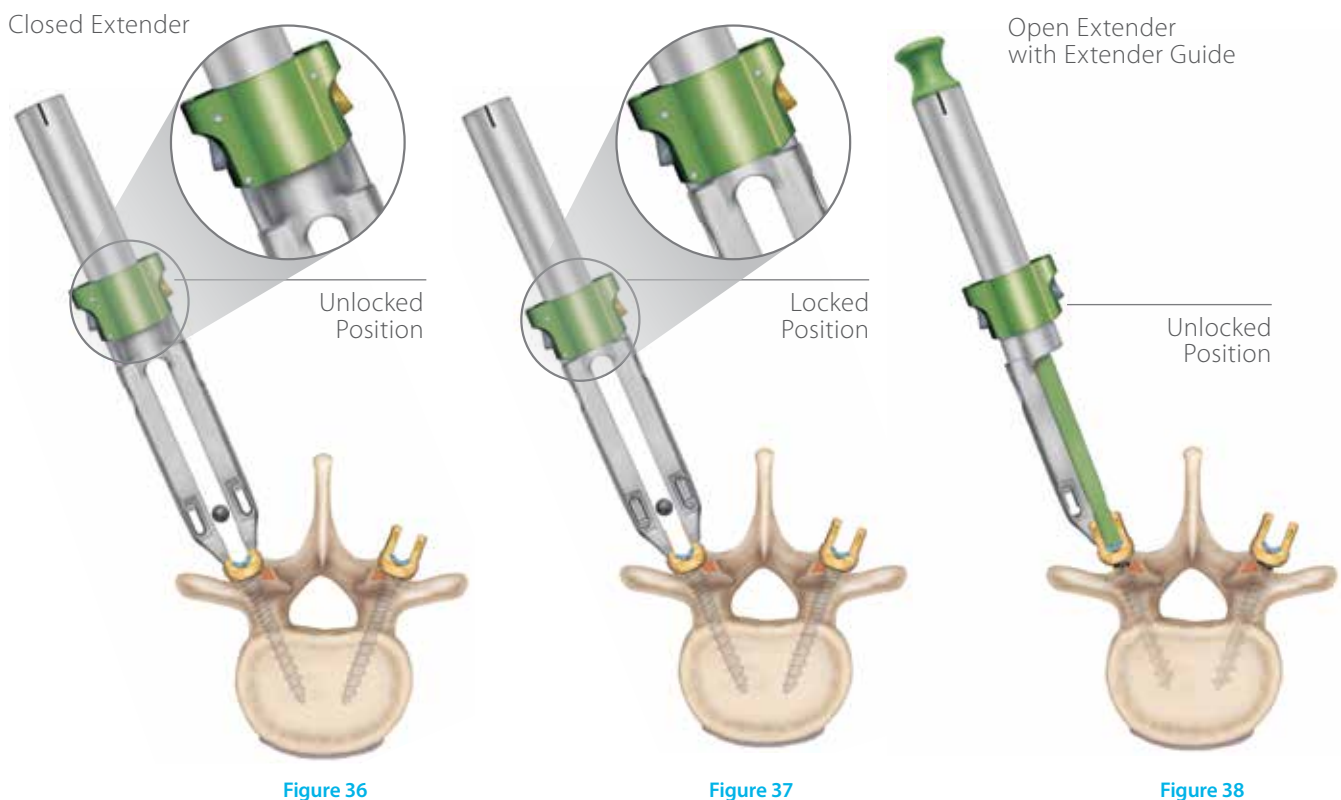

Rod Reduction *Continued*

SMARTLINK™ EXTENDERS CONTINUED

To assemble the Reducer with either extender, align the Reducer with the internal slots of the Extender (**Figure 39**). Turn the Reducer by hand until it is engaged with the rod (**Figure 40**). Holding the top of the instrument, manipulation of the rod and implant can be done until the desired alignment is achieved. To gradually reduce the rod into the implant, the blue Driver Handle is engaged with the Reducer and manually turned clockwise (**Figure 41**).

In this seated position, remove the Driver Handle and insert a set screw to secure the rod to the bone screw. Introduction of the set screw is accomplished using the Dual Ended Set Screw Starter or the Provisional Driver. Attach the set screw to either instrument and insert it through the cannula and provisionally tighten (**Figure 42**). To remove the SMARTLINK™ Extenders from the implant, pull up on the green sleeve to disengage the tips of the instrument from the implant (**Figure 43**). Manually turning the Reducer counterclockwise will allow the Reducer to be disassembled from the Extender.



Apical Derotation

SMARTLINK™ DEROTATORS

The SMARTLINK™ Derotators are designed to triangulate the SMARTLINK™ Extenders and facilitate apical vertebral body manipulation.

To perform segmental derotation, place the Segmental Link (5485910) over bilateral SMARTLINK™ Extenders and turn the blue handle clockwise to tighten. The handle can then be used for vertebral body manipulation (**Figure 44**). If contrarotational corrective forces are desired, additional Segmental Links may be added as needed. If Multi-Axial Screws (MAS) are used on one side of the construct, place the Segmental Link over the Extender that is attached to a MAS ensuring that it passes through the round MAS hole in the Segmental Link (**Figure 45**). The Segmental Link is not compatible with bilateral MAS constructs.

If performing a unilateral derotation, the Interlink (5485911) should be used. Place the Interlink over multiple Extenders with the blue handle on the lateral side of the Extenders. Turn the blue handle clockwise to tighten the Interlink prior to performing derotation maneuvers (**Figure 46**).

Global derotation constructs can be assembled using a combination of Segmental Links and Interlinks. Begin by placing Segmental Links over two or more levels. The Segmental Links should be pushed down the Extender shaft to accommodate the subsequent placement of the Interlink. Screw Extenders attached to MAS must pass through the MAS hole in the Segmental Link. Next, attach Interlinks on both sides of the construct to perform a Global Derotation (**Figure 47**).



Figure 44

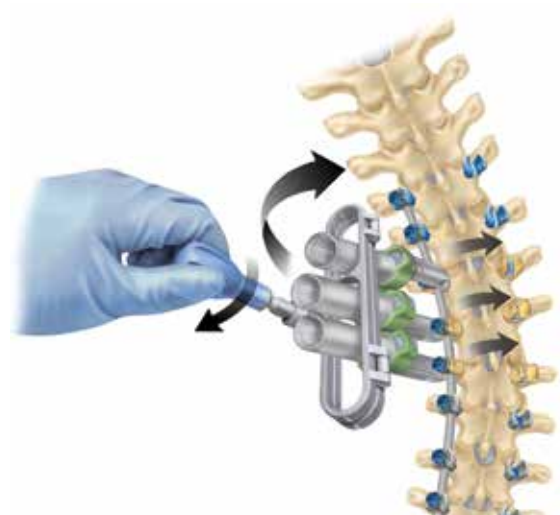

Figure 46



Figure 45

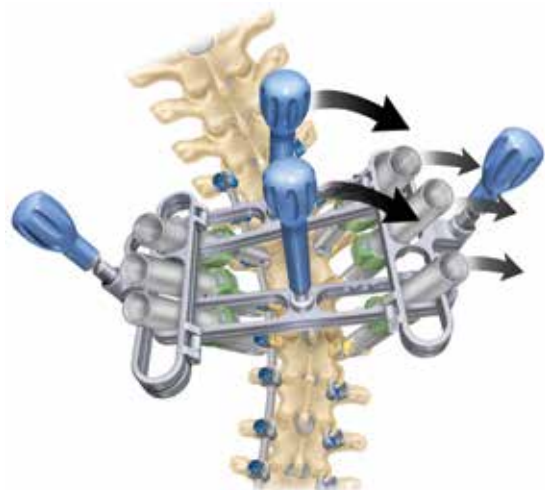

Figure 47

Apical Derotation *Continued*

VERTEBRAL COLUMN MANIPULATION

The VCM assembly can be used on multi-axial screws (MAS), Sagittal Adjusting Screw (SAS) and fixed angle screws (FAS). Once the assembly is triangulated, the axial screws will mimic the control of a fixed angle screw to allow vertebral body manipulation.

Attach the Implant Holder to the slots on the side of the screw head saddle. Lock the Implant Holder to the screw head by squeezing the open lever (**Figure 48**). Choose a Derotator Bridge that spans the distance between the Implant Holders. With the threaded middle portion of

the Derotator Bridge facing upward, slide the Derotator Bridge Nuts onto each end (**Figure 49**). Prior to placing the Derotator Bridge onto the Implant Holders, position the flat side of the threaded portion of the Implant Holder in a rostrocaudal direction (**Figure 50**). Next slide the Derotator Bridge assembly onto the Implant Holders (**Figure 51**) and finger tighten.



Figure 48



Figure 49



Figure 50

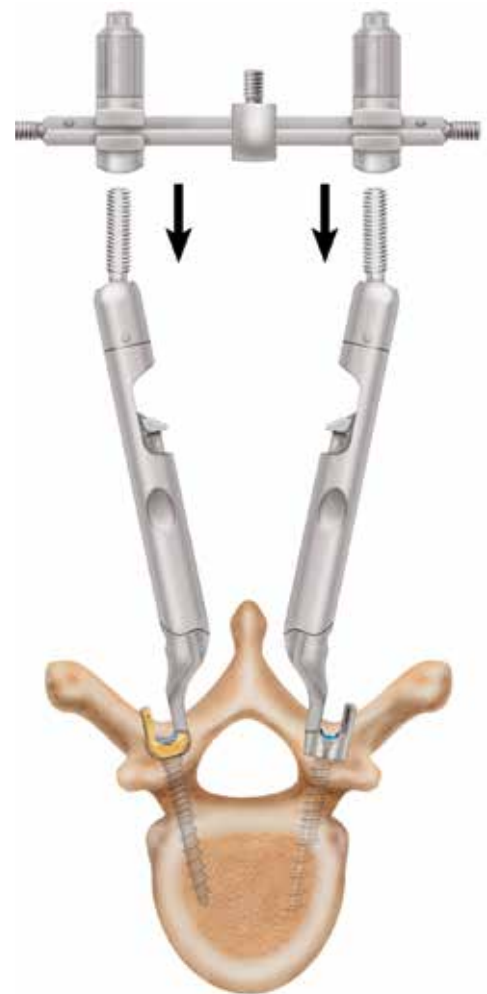

Figure 51

Apical Derotation *Continued*

VERTEBRAL COLUMN MANIPULATION *CONTINUED*

Once the Derotator Bridge Nuts are secured (using Break Off Hex Driver), the Derotator Inline Handles are attached at the end of the Derotator Bridge. The vertebra can then be manipulated. **(Figure 52)**

The Bridge Derotation instruments can link multiple levels using the Derotator Interlinks. **(Figure 53).**

For Detailed information on VCM and BAVD technique please read the CD HORIZON® Legacy™ Spinal System with Vertebral Column Manipulation (VCM) Instrument Set Advanced Deformity Correction.

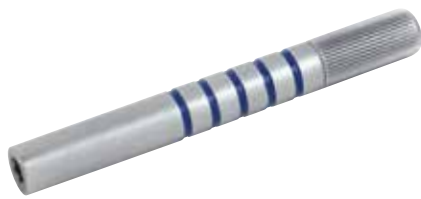

Derotator Bridge Handle
7480396



Derotator Interlink
7480395

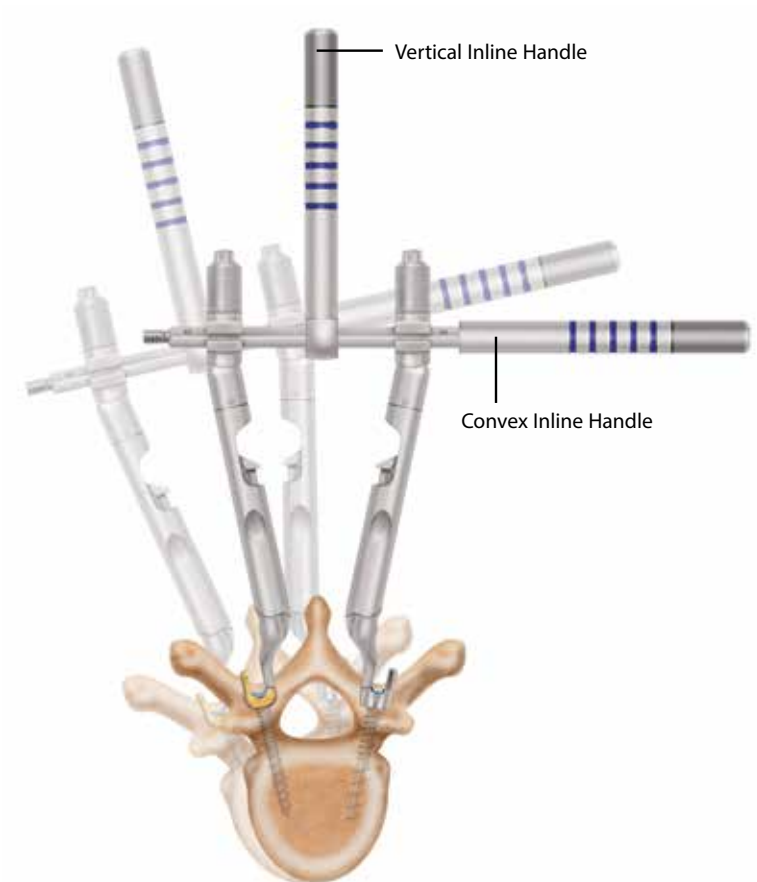

Figure 52



Figure 53

Compression Distraction

HINGED TRANSLATOR

The Hinged Translator can be used in place of either a compressor or a distractor during correction manoeuvres. The straight leg of the instrument will push the implant while the hinged leg engages on the rod to act as rod gripper. Pay careful attention to the bone-to-screw interface during any correction manoeuvre. Prior to placing the Hinged Translator on the rod, disengage the rack so that the hinged leg and straight leg are touching each other (**Figure 54**). The arrow on the rack of the Hinged Translator shows the direction in which the implant will be moved (**Figure 55**).

Example for Compressing the T8-T9 Segment: Provisionally tighten the T9 set screw. Prior to squeezing the handles, place the instrument along the rod with the straight leg below and immediately against the T9 screw (**Figure 56**). Squeeze the handles to begin compression (**Figure 57**).

Example for Distracting the T8-T9 Segment: Provisionally tighten the T8 set screw. Prior to squeezing the handles, place the instrument along the rod with the straight leg below and immediately against the T8 screw (**Figure 58**). Squeeze the handles to begin distraction (**Figure 59**).

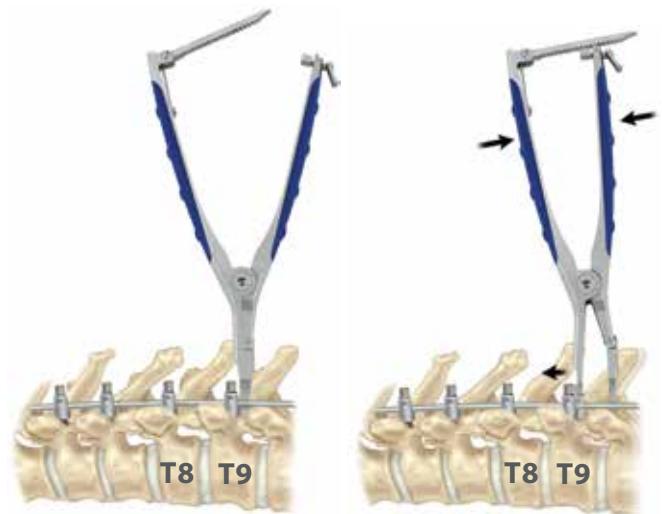

Figure 56

Figure 57

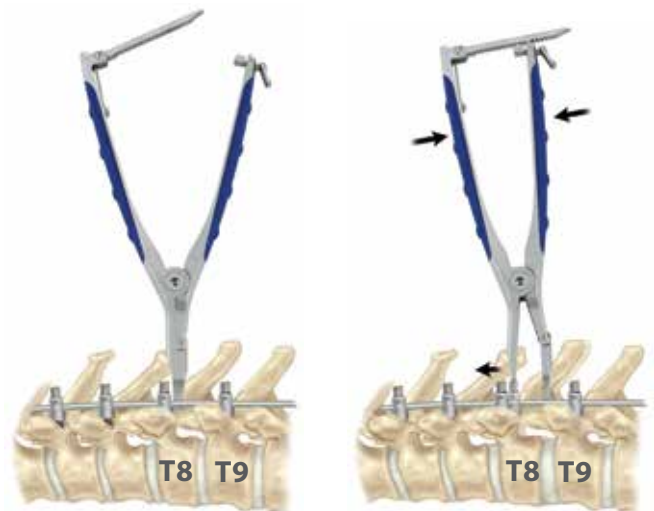

Figure 58

Figure 59



Figure 54



Figure 55

Compression Distraction *Continued*

PLACING THE STABILIZATION ROD

Following placement of the second rod and set screws (**Figure 60**), convex compressive forces are placed on the segments using the Compressor to horizontalize the lowest instrumented vertebra and mildly compress the convexity of the deformity (**Figure 61**). It is preferred that compression be released just prior to the set screw being broken off or with final tightening. This technique will help ensure that the implant head and rod are normalized to one another and thus allow

for the rod to be fully seated in the implant head during the final tightening step. NMEP and/or SSEP monitoring are performed to detect any potential neurologic deficits. Fixation is verified with AP and lateral x-rays to confirm spinal correction and alignment.

Important: The Dual Ended Set Screw Starter or the Provisional Driver may be used for provisionally tightening the set screws.

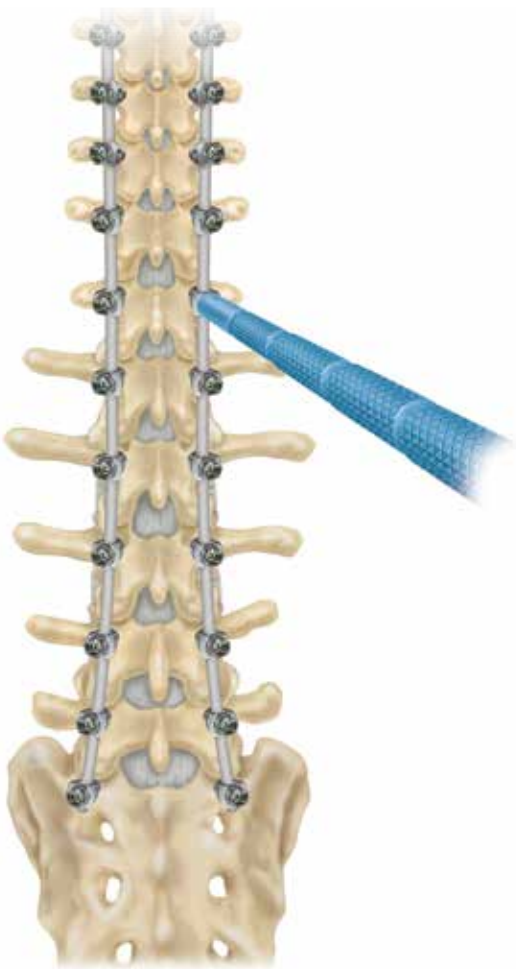

Figure 60



Figure 61

Iliac Fixations

SOLERA LATERAL CONNECTORS

Closed and Side-loading Lateral Connectors are color-coded by rod channel diameter and connect to 4.75, 5.5, 6.0, and 6.35mm diameter rods as shown below (**Figure 66**). The titanium break-off set screw (779170005) should

Rod Size Compatibility				Lateral Connectors	Set Screw	Screw Connection Compatibility			
4.75mm	5.5mm	6.0mm	6.35mm			4.75mm	5.5mm	?	?
●						●	●	●	
●						●	●	●	
	●	●						●	●
	●	●					●	●	●
			●					●	●

Figure 66

When performing iliac fixation, Closed and Side-Loading Lateral Connectors may be used to facilitate construct assembly (**Figure 68**). These connectors are compatible with long CD HORIZON® SOLERA® Multi-Axial Screws, CD HORIZON® Closed Multi-Axial Iliac Screws and CD

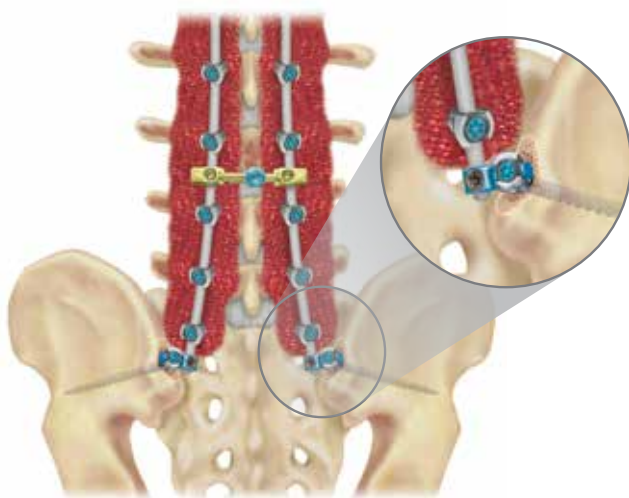

Figure 68

be used with these connectors. The smooth posts of the connectors are offered in 20mm to 70mm lengths and are compatible with 4.75, 5.5, 6.0, and 6.35mm CD HORIZON® System Screws (**Figure 67**).



Figure 67

HORIZON® Fixed Angle Iliac Screws to allow intraoperative flexibility (**Figure 69**). For information on iliac fixation and connector placement, please refer to the CD HORIZON® Iliac Fixation Surgical Technique.

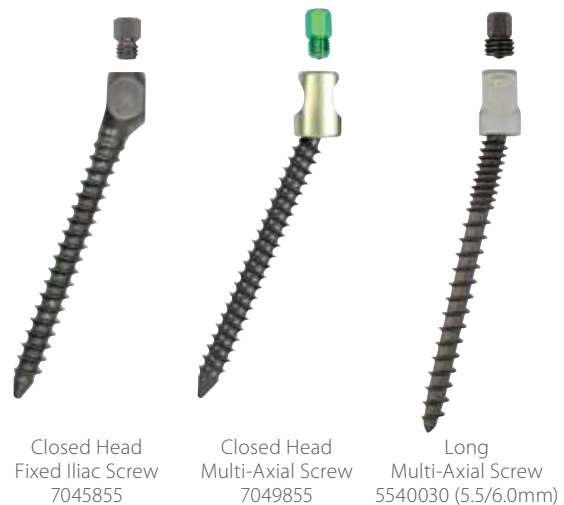

Figure 69

Final Tightening

Using the Counter Torque and the Self-Retaining Breakoff Driver, shear off the set screws which locks the rods into place (**Figure 62**). The break off set screw has the appropriate locking torque built into it and should not require additional tightening. Final tightening torque range is 10.50-12.50Nm or 92-110 in-lbs. Following final tightening, the sheared-off portions of the set screws accumulated in the driver are removed using the T27 Obturator shaft (**Figure 63**).

If additional manipulation of the set screw is desired after the break off is achieved, the Torque Indicating Driver should be used to prevent over tightening of the set screw which could reduce the strength of the connection.

To use the Torque Indicating Driver, attach the Quick Connect T-Handle to the Torque Indicating Driver and pass it through the Counter Torque and into the inner portion of the set screw (**Figure 64**). Turn the handle until the slot reaches the line on the right side of the scale to ensure the Correct Torque limit has been achieved (**Figure 65**). The posterior elements are decorticated with a burr and the bone graft is placed.

Important: Ensure the correct Torque Indicating Driver is used for the system. A Counter Torque should be used when using the Torque Indicating Driver.



Figure 62



Figure 63



Figure 64



Figure 65

Bone Graft Options

The posterior elements are decorticated with a burr prior to bone graft placement. Precise placement of the bone graft (autograft or allograft bone) on the decorticated surface is essential to facilitate fusion. A number of Medtronic bone graft substitutes, such as MASTERGRAFT® Strip and NANOSTIM™ Synthetic Bone Paste, are available as fillers for voids or gaps that are not intrinsic to the stability of the bony structure.

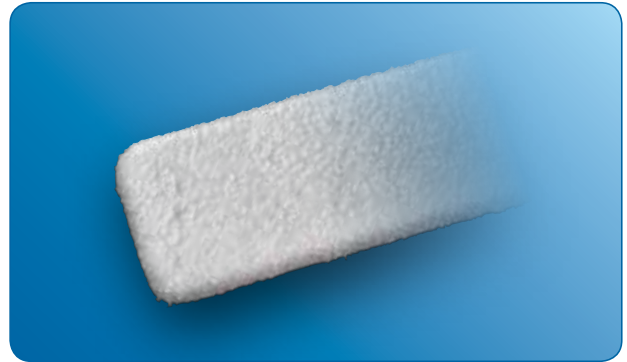

MASTERGRAFT® Strip



*NANOSTIM™ Synthetic Bone Paste Resorbable
Nanocrystalline Hydroxyapatite*

Anti-Adhesion Option

MediShield™ Anti-Adhesion Gel creates a barrier to separate tissues during the initial stages of the healing process. This Medtronic integrated solution provides the surgeon with an advanced and cost-effective prevention methodology to reduce the pain and severity of postoperative adhesions.

- Helps inhibit the formation of peridural adhesions
- Allows for normal wound healing to take place
- Resorbable
- Biocompatible



MediShield™ Anti-Adhesion Gel

CD HORIZON® X10 CROSSLINK® Plate Placement

It has been shown that a CROSSLINK® Plate provides resistance against both axial and torsional loads by converting a two rod construct into an unitized quadrilateral frame (Johnston, Ashman, Allard: Effect of Spinal Construct Stiffness on Early Fusion Mass Incorporation. Spine 15: 908-912, 1990). In long constructs, the CROSSLINK® Plate should be placed on the upper one-third of the construct and another one in the lower one-third of the construct.

To determine the appropriate CROSSLINK® Plate, use the measuring credit card or the measuring caliper (**Figure 70**).

IN-LINE PLATE HOLDER METHOD

NOTE: Prior to implantation of the CROSSLINK® Plate, break off the VERIFY™ Implant Tracking Tag and retain it in the tag sorter so that it can be scanned at the end of the surgery.

The midline nut is provisionally tightened to gain control of the CD HORIZON® X10 CROSSLINK® Multi-Span Plate. The rod set screws are backed out such that they do not obstruct rod introduction. With the use of the In-line plate holder, the plate is gripped and positioned to capture the far rod of the two rods. The far rod set screw is provisionally tightened using the 7/32" Torque-Limiting Set Screw Driver to firmly anchor the device to the rod (**Figure 71**). Next, loosen the midline nut to allow the multi-axial flexibility of the CD HORIZON® CROSSLINK® Plate and assemble the plate to the other rod and provisionally tighten the set screw. Retighten the midline nut to secure the overall device (**Figure 72**).



Figure 70



Figure 71



Figure 72

CD HORIZON® X10 CROSSLINK® Plate Placement *Continued*

T-BOLT IMPLANT POSITIONER METHOD

With the use of the implant positioner instruments, the appropriate CD HORIZON® X10 CROSSLINK® MULTI-SPAN® Plate is selected and gripped (**Figure 73**). Ensure that both positioners fit securely onto both set screws.

The T-bolt Implant Positioners can be used to sequentially articulate the plate around the rod (**Figure 74**). If the plate cannot be precisely seated against the rod, the set screw is still too prominently extended into the claw opening. Keep the plate in the wound and abutting against the rod. By rotating the positioners, the set screw can be manipulated

and slightly backed out, allowing the rod to fully seat in the claw opening. Once precise contact has been achieved between the plate and the rod, the positioners can be used to provisionally tighten the plate to the rod. The same process is carried out for the other side of the plate. Both halves of the plate should precisely articulate with the rod before final tightening and set screw breakoff.

Remove the T-bolt Implant Positioners and provisionally tighten the midline nut using the 7/32" Torque-Limiting Set Screw Driver.



Figure 73



Figure 74

Final Tightening of the Plate

Finally tighten the midline nut to 80in-lbs (9Nm) using the Counter Torque to minimize torque transfer and the 7/32" Torque-Limiting Set Screw Driver (**Figure 75**). The 7/32" Torque-Limiting Set Screw Driver should be fully seated on the midline nut during the final tightening. The midline nut is not a Break-off set screw. An audible "click" from the handle will confirm that the midline nut is adequately tightened to the appropriate torque.

Advance the break off set screws using the Counter Torque and the 7/32" Torque-Limiting Set Screw Driver and tighten the set screws to break off at 55-65 in-lbs (6.2-7.3Nm) (**Figure 76**). The sheared off sections of the set screws can remain housed in the shaft of the driver until removal is convenient. To remove the sheared-off sections of the set screws from the driver, hold the handle horizontally and the broken off sections will easily fall from the oblong window in the shaft (**Figure 77**).



Figure 75



Figure 76



Figure 77

Postoperative Care and Mobilization

Prior to closure, do a final check to ensure that the set screws are symmetrically seated in the screw heads and sheared off, that the bone graft has not become dislodged during manipulation, and that a proper count of all sheared-off set screw heads is correct (**Figure 78**).

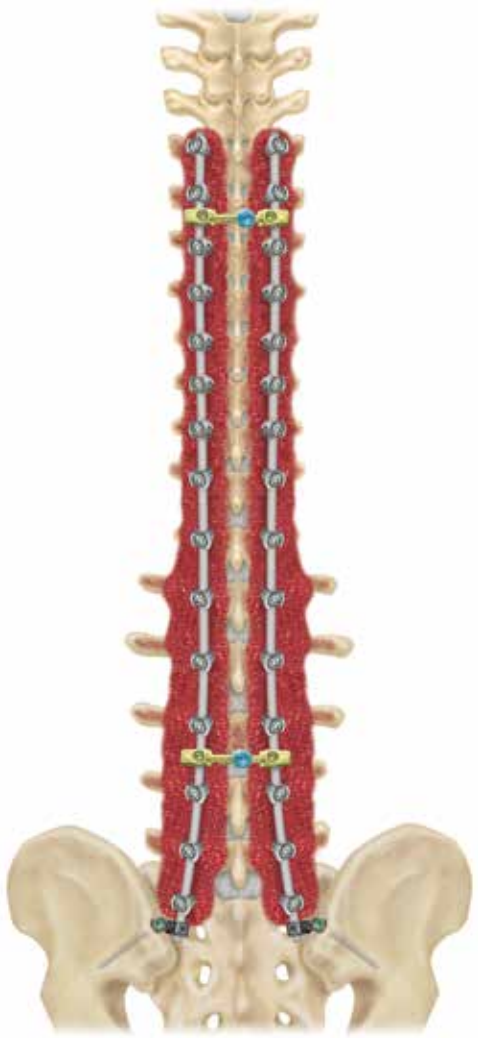

Figure 78



Appropriate postoperative monitoring following evaluation of the extent of the surgical procedure and the patient's overall medical status is essential. Deep vein anti-embolic treatment should be considered for all patients, along with active pulmonary toilet, fluid balance, nutritional status, and monitoring of neurologic function. Prophylactic antibiotics may be continued for a brief duration following surgery until the wound seals. Finally, postoperative bracing may be considered for longer fusions depending upon individual surgeon preference.

A structured, progressive physical therapy program is essential to mobilize the patient in order to diminish postoperative complications and to rehabilitate the patient sufficiently for discharge. During the inpatient rehabilitation period, patients should be carefully instructed in the appropriate methods of getting in and out of bed, stair climbing, and brace application, as well as how long to sit and various other activities of daily living. Patients who lag behind a normal recovery period proportional to the extent of their surgery should be expediently considered for transfer to a rehabilitation inpatient facility.

Finally, postoperative follow-up for a minimum of two years is crucial to assess the progression of fusion and, equally important, the patient's clinical improvement.

Hook Surgical Technique

Hook Implant Strategy

Hook Type	Vertebral Posterior Element Placement	Blade Direction	Region of Spine	Design Features
 Pedicle Hook	Articular Process	↑	T1 – T10	» Bifid blade grasps thoracic pedicle for stability.
 Wide Blade Hook	Lamina	↕	T1 – L5	» Wider blade width distributes forces evenly over a wider aspect of bone.
	Transverse Process	↕	T1 – L5	
 Narrow Blade Hook	Lamina	↕	T1 – L5	» Narrower blade width minimizes metal volume in the spinal canal.
	Transverse Process	↕	T1 – L5	
 Wide Blade Ramped Hook	Lamina	↕	T1 – L5	» Ramp reduces intra-canal intrusion.
	Transverse Process	↕	T1 – L5	
 Narrow Blade Ramped Hook	Lamina	↕	T1 – L5	» Ramp reduces intra-canal intrusion.
	Transverse Process	↕	T1 – L5	
 Extended Body Hook	Lamina	↕	T1 – L5	» Can correct anatomic misalignment between two laminae in the dorso-ventral plane.
	Transverse Process	↕	T1 – L5	
 Offset Hook	Lamina	↕	T1 – L5	» Can be used to medialize or lateralize the rod in supralaminar or infralaminar position.
	Transverse Process	↕	T1 – L5	» Can back up a pedicle screw at the same level.

Color-coding Size Reference

Small	Medium	Large
●	●	●

Improper positioning and placement of implants may cause damage.

Surgical Strategy

Preoperatively, any spinal surgery should be studied and a scheme of the construct defined.

Shown below are examples of some typical hook construct schemes for a T4-L1 and T2-S1 placement. These schemes, which are strictly for illustrative purposes, are examples of how to treat various degrees of scoliosis.

Figure 79 shows a standard right thoracic curve (Lenke

Type 1AN/King Type III) instrumented with hooks from T4 to L1. This case can also be treated using a hybrid construct consisting of hooks and pedicle screws. **Figure 80** shows a construct treating scoliosis from T2 to L5.

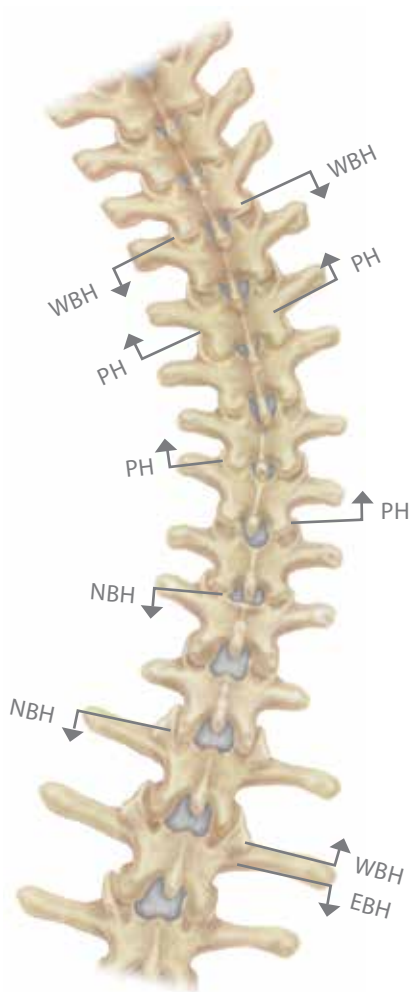

Figure 79

Hook Construct Legend	
NBH	= Narrow Blade Hook
OH	= Offset Hook
PH	= Pedicle Hook
⊗	= Pedicle Screw
WBH	= Wide Blade Hook
↗	= Up-Going Hook
↘	= Down-Going Hook
TAPH	= Total Anatomical Pedicle Hook
TATP	= Total Anatomical Transverse Process Hook
EBH	= Extended Body Hook



Figure 80

Hook Site Preparation, Options and Insertion

The CD HORIZON® SOLERA® Spinal System is compatible with a number of top-loading hooks of different anatomic shapes and sizes (see hook implants chart, page 66). The surgeon must choose the appropriate hook based on the individual patient's anatomy, deformity degree and type, method of correction chosen, and amount of compression/distraction that will be needed to provide proper and stable purchase of the implants.

NOTE: Prior to implantation of the hooks, break off the VERIFY™ Implant Tracking tag and retain it in the Tag Sorter so that it can be scanned at the end of the surgery.

Several different instruments can be used for hook insertion. For instance, the Straight or Lateral Implant Holder combined with the Hook Pusher (**Figure 81**).



Figure 81

PEDICAL HOOK

The Pedicle Hook may be used from T1 to T10. The hook blade is always cephalad (up-going) and is in the infralaminar position. The facet capsule is divided, and a portion of the inferior facet process may be removed to facilitate insertion of the hook (**Figure 82**). Once the pedicle has been clearly identified with the help of the Pedicle finder (**Figure 83**), the hook may be inserted.

If needed, a mallet can be used to impact the Hook Pusher to drive the Pedicle Hook. It is important that the Pedicle Hook is placed into the joint cavity (**Figure 84**) and is not splitting the inferior articular process (**Figure 85**).



Pedicle Hook



Figure 82



Figure 83



CORRECT

Figure 84



INCORRECT

Figure 85

Hook Site Preparation, Options and Insertion *Continued*

TRANSVERSE PROCESS HOOK

This is generally a wide blade hook and is typically used in a pedicle-transverse claw construct as a caudal (down-going) as well as cephalad (up-going) hook (**Figure 86**). The Transverse Process Elevator or the wide blade Laminal Elevator may be used to separate the ligamentous attachment between the undersurface of the transverse process and the posterior arch of the rib medial to the rib-transverse joint. An Implant Holder is used to insert this hook.



Figure 86

LAMINAR HOOK

This hook is always inserted in the cephalad (towards the head) direction and is generally used at T10 or below. With this hook type, the ligamentum flavum is partially removed or separated from the inferior surface of the lamina using the Laminal Elevator, keeping the bone intact, if possible (**Figures 87a and 87b**). An Implant Holder is used to insert the hook.

The Supralaminar Hook direction of this hook is always caudal (down-going). A partial or total division of the spinous process directly above the vertebra to be instrumented (thoracic vertebra) may be performed. A division and/or partial removal of the ligamentum flavum and a small laminotomy are carried out on the superior lamina. The amount of bone removed from the lamina may vary depending on the size of the hook blade and throat angle chosen. The upper edge of the lamina below may be resected to ease the placement of this hook. The Laminal Elevator may be used to check the space between laminar and peridural structures (**Figure 88**). Two sizes of Laminal Elevators are available depending on the size of the lamina and thus the size of the hook blade: Narrow or Wide Blade. An Implant Holder is typically used to insert the hook (Dual Purpose Instrument or Straight/Lateral Implant Holders) when placed on the superior lamina (**Figure 88**).



Figure 87a



Figure 87b



Figure 88

Decortication

Once inserted, laminar hooks are not very stable prior to rod insertion. Therefore, it is recommended to remove them to decorticate.

At this point in the surgery, bilateral partial facetectomies are carried out (**Figure 89**). The intervening cartilage is denuded to allow exposure of the subchondral bone assisting in bone fusion. Decortication of the laminae, spinous processes, and transverse processes, along with bone graft placement, will be done at the end of the surgery to avoid intraoperative bleeding. Laminar hooks are placed back into their position.



Figure 89

Rod Contouring

Once the hooks on the correction side of the deformity (concave in the thoracic area, convex in the lumbar area of the spine) are tested for fit and placement, a rod template may be used to determine the length and the curve. The correction rod is cut to the appropriate length (1cm to 2cm longer than the overall hook-to-hook length). To achieve the correct sagittal plane contour, the rod is bent in small incremental steps using a French Bender (**Figure 90**). It is important to maintain a same plane orientation of the rod to prevent a spiral-type bend down the rod.

In the case of a reducible scoliosis, the rod is bent according to the final postoperative planned correction to obtain a nice postoperative thoracic kyphosis and lumbar lordosis.

In a case of stiff scoliosis, the rod is placed along the spine to check for proper correction, hook fit, and contouring. This type of scoliosis correction will be mainly obtained with in situ bending.



Figure 90

Rod Insertion

The contoured rod is placed into the top-loading implants beginning from either the upper or lower part of the construct, there is no particular rule for rod insertion. One can start with the implants in which the rod seems to best position and facilitate the continuation of the insertion (**Figures 91 and 92**). A Rod Holder may be used to assist in placing the rod. Using the Dual Ended Set Screw Starter or Provisional Driver, set screws are placed into the first implants where the rod seats perfectly. The Rod Pusher may be used to push the rod down in order to place a set screw (**Figure 93**).

There are several methods and instruments that may be used to facilitate rod reduction and to fully seat the rod into the saddle of the implants. Refer to the Rod Reduction steps on pages 31 through 37 of the pedicle screw section of this technique for method options.

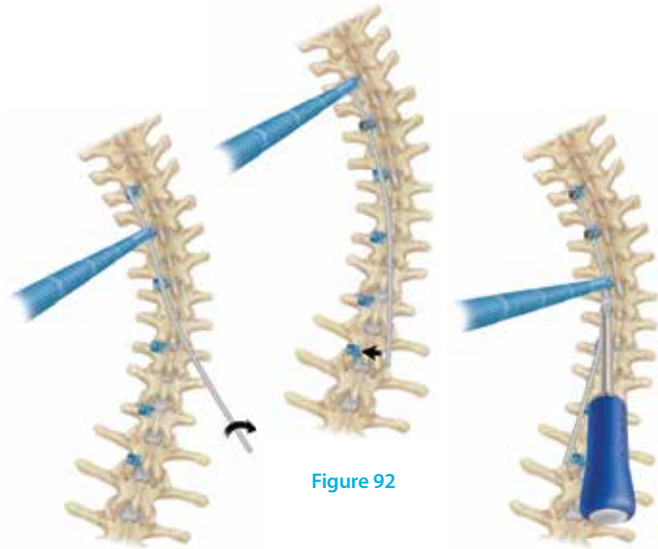

Figure 91

Figure 92

Figure 93

Deformity Correction

At this point of the surgery some of the correction has been achieved, mainly due to translation maneuvers used when inserting the rod. Further correction can be accomplished with rod rotation and/or in situ bending, depending on the type and stiffness of the curve, and completed with compression/distraction maneuvers.

ROD ROTATION

Once the contoured rod and all of the set screws have been placed, the rod is ready to be rotated into its final position. The rotation must be done slowly in order to prevent rapid neurologic changes and/or partial pullout or hook dislodgement. The rotation is done using two Dual Action Rod Grippers (**Figure 94**). It is important to monitor the interval hooks, which can back out during rod rotation. Several methods are proposed: use of the C-Shaped Rod Pusher, the placement of C-rings on the rod prior to rotation, placement of the Rod Gripper on the rod just below the hook to buttress it, or the use of a hook stabilizer instrument, which is available upon special ordering request.



Figure 94

Deformity Correction *Continued*

Once the rotation of the rod is complete and the position of the hooks is verified, the interval hooks' set screws are provisionally tightened to prevent rod derotation. The hooks should be checked following all rotation maneuvers and the necessary adjustments made to ensure that proper placement is maintained. At this point, the rod should be fully seated into the saddle of all of the implants.

IN SITU BENDING

In Situ Benders may be used for correction and final adjustment of the rod in the sagittal plane. The rod is bent in small incremental steps using the two bender tips positioned near each other on the rod (**Figure 95**).

COMPRESSION AND DISTRACTION

Once the rod is secured in the implants, distraction and/or compression are performed to place the hooks in their final position. The Hinged Translator, Multilevel Hook Compressor, Distractor, and Provisional Driver are used to carry out these maneuvers. (**Figure 96**). Compression maneuvers are most often carried out directly on two hooks (**Figure 97**). Another option is to use the Hinged Translator for Compression. Care should be taken to ensure that the foot of either instrument is placed against the implant body and not against the set screw. It is preferred that compression be released just prior to the set screw being broken off or final tightened. This technique will help ensure that the implant head and rod are normalized to one another, and thus, allows for the rod to be fully seated in the implant head during the final tightening step. After these maneuvers are complete, the set screw is tightened with the Provisional Driver.

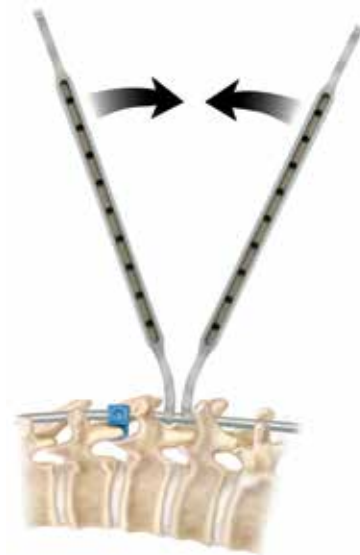

Figure 95



Figure 96

Stabilization and Holding Rod Placement

With the completion of the deformity correction and the seating of the correction rod, the opposite side of the construct is prepared. Measure the length for the stabilizing rod, then cut. Using the French Bender, contour the rod according to the curvature of the spine and the residual position of alignment from the correction rod. Place the contoured rod into the hooks and provisionally secure the rod with set screws (**Figure 97**). Once the rod is secured to the implants, distraction and/or compression are performed to place the hooks in their final position. Refer to the previously described instructions to ensure the appropriate steps are followed.

The spine may be decorticated to carry out the bone fusion and morselized cancellous bone placed along the decorticated spine, extending out over the transverse processes.



Figure 97

Final Tightening

When all implants are securely in place and the rod fully seated, final tightening and/or break-off of the set screws is performed.

The Counter Torque instrument is placed over the implant and the rod (**Figure 98**). The Self-Retaining Breakoff Driver is then placed through the cannulated Counter Torque. The Self-Retaining Break-Off Driver provides adequate leverage for breaking the set screw heads. The handle of the Counter Torque device should be held firmly to prevent torquing of the construct while the set screw is secured and sheared off (**Figure 99**). The broken-off part of the set screw is captured in the cannulated portion of the Self-Retaining Break-Off Driver. Following final tightening, the sheared-off portions of the set screws accumulated in the driver are removed using the T25 or T27 Obturator shaft (**Figure 100**).

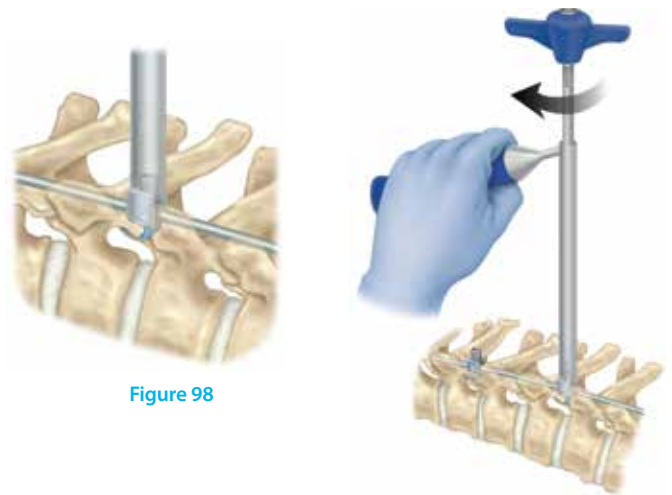

Figure 98

Figure 99

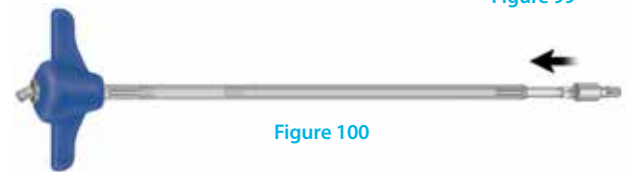

Figure 100

CD HORIZON® X10 CROSSLINK® Plate Placement and Closure

Once final tightening of the set screws is completed, transverse links should be placed if possible to provide rotational stability to the construct. A framed construct resists rotational forces. Refer to the previously described instructions for placing CD HORIZON® X10 CROSSLINK® Plates in the pedicle screw section of this technique. The posterior elements should be decorticated with a burr followed by bone graft placement (**Figure 101**). Wound closure is performed in the customary manner.

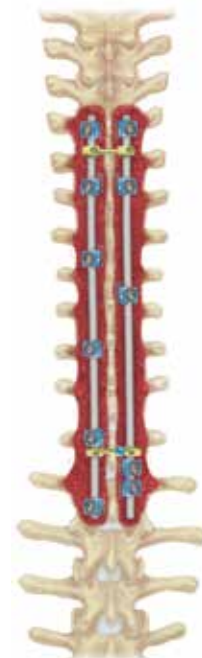

Figure 101

Suggestions to Explant the CD HORIZON® SOLERA® Spinal System

SET SCREWS

The 5.5/6.0mm CD HORIZON® SOLERA® set screws (plugs) may be removed using the T27 Obturator and the Self-retaining Breakoff Driver. The T27 Obturator is inserted into the working end of the Self-retaining Break-off Driver, so that the knurled portion of the T27 Obturator is flush with the driver. Insert the obturator tip through the Counter Torque, which should be seated on the screw and into the plug, turning counterclockwise until the plug has been removed.

When removing the 4.75mm CD HORIZON® SOLERA® set screws (plug), use the T25 Obturator and following the same steps as listed above.

PEDICLE SCREWS

The pedicle screws may be removed using either the Ball-ended T25 Bone Screw Removal Driver or the Self-retaining Screwdriver in conjunction with the Quick Connect Handle. First, attach the Quick Connect Handle to the modular end of the driver. Next, fully engage the T25 end of the driver into the screw head; then, if utilizing the Multi-Axial Screwdriver, thread the instrument sleeve into the screw head. Turn counterclockwise until the pedicle screws have been removed.

HOOKS

The hooks may be removed using the Self-retaining Implant Holder. Attach the Self-retaining Implant Holder to the implant and remove the hook.

CD HORIZON® CROSSLINK® PLATES

If removal of a CD HORIZON® X10 CROSSLINK® MULTI-SPAN® Plate is necessary, place the 7/32" Torque-Limiting Set Screw Driver over the midline nut and turn counterclockwise to loosen. Place the 3.0mm Hex Removal Driver into a standard Medtronic Quick Connect Handle. Place the tip of the 3.0mm internal hex driver into the set screw and confirm that the 3.0mm tip is completely inserted and seated in the set screw so that the tip does not strip the hex. Turn the driver counterclockwise to loosen the set screw from the rod.

Product Ordering Information

5.5/6.0MM COBALT CHROME/TITANIUM MULTI-AXIAL SCREWS



Catalog Number	Description		Catalog Number	Description	
55840004525	4.5mm × 25mm	●	55840007525*	7.5mm × 25mm	●
55840004530	4.5mm × 30mm	●	55840007530*	7.5mm × 25mm	●
55840004535	4.5mm × 35mm	●	55840007535	7.5mm × 35mm	●
55840004540	4.5mm × 40mm	●	55840007540	7.5mm × 40mm	●
55840004545	4.5mm × 45mm	●	55840007545	7.5mm × 45mm	●
55840004550	4.5mm × 50mm	●	55840007550	7.5mm × 50mm	●
55840004555*	4.5mm × 55mm	●	55840007555*	7.5mm × 55mm	●
55840005525*	5.5mm × 25mm	●	55840007560*	7.5mm × 60mm	●
55840005530	5.5mm × 30mm	●	55840008530	8.5mm × 30mm	●
55840005535	5.5mm × 35mm	●	55840008535	8.5mm × 35mm	●
55840005540	5.5mm × 40mm	●	55840008540	8.5mm × 40mm	●
55840005545	5.5mm × 45mm	●	55840008545	8.5mm × 45mm	●
55840005550	5.5mm × 50mm	●	55840008550	8.5mm × 50mm	●
55840005555	5.5mm × 55mm	●	55840008555	8.5mm × 55mm	●
55840005560*	5.5mm × 60mm	●	55840008560	8.5mm × 60mm	●
55840006525*	6.5mm × 25mm	●	55840009530	9.5mm × 30mm	●
55840006530	6.5mm × 30mm	●	55840009535	9.5mm × 35mm	●
55840006535	6.5mm × 35mm	●	55840009540	9.5mm × 40mm	●
55840006540	6.5mm × 40mm	●	55840009545	9.5mm × 45mm	●
55840006545	6.5mm × 45mm	●	55840009550	9.5mm × 50mm	●
55840006550	6.5mm × 50mm	●	55840009555	9.5mm × 55mm	●
55840006555	6.5mm × 55mm	●	55840009560	9.5mm × 60mm	●
55840006560	6.5mm × 60mm	●			
55840006565*	6.5mm × 65mm	●			

SPECIAL CASE WITH LONGER SCREW EXIST IN 6.5, 7.5, 8.5 AND 9.5 DIAMETERS (LEAD TIME EXPECTED)

Catalog Number	Description	
5584000x570	x.5mm × 70mm	● ● ● ●
5584000x580	x.5mm × 80mm	● ● ● ●
5584000x590	x.5mm × 90mm	● ● ● ●
5584000x500	x.5mm × 100mm	● ● ● ●

5.5/6.0MM TITANIUM SET SCREWS



Catalog Number	Description
5540030	Break-off Set Screws
5540230	5.5/6.0 Reduction Set Screws

Product Ordering Information

5.5/6.0MM TITANIUM FIXED ANGLE SCREWS



Catalog Number	Description	
55410004520*	4.5mm x 20mm	●
55410004525	4.5mm x 25mm	●
55410004530	4.5mm x 30mm	●
55410004535	4.5mm x 35mm	●
55410004540	4.5mm x 40mm	●
55410004545	4.5mm x 45mm	●
55410004550*	4.5mm x 50mm	●
55410005525*	5.5mm x 25mm	●
55410005530	5.5mm x 30mm	●
55410005535	5.5mm x 35mm	●
55410005540	5.5mm x 40mm	●
55410005545	5.5mm x 45mm	●
55410005550	5.5mm x 50mm	●
55410005555*	5.5mm x 55mm	●
55410006525*	6.5mm x 25mm	●

Catalog Number	Description	
55410006530	6.5mm x 30mm	●
55410006535	6.5mm x 35mm	●
55410006540	6.5mm x 40mm	●
55410006545	6.5mm x 45mm	●
55410006550	6.5mm x 50mm	●
55410006555	6.5mm x 55mm	●
55410007530*	7.5mm x 30mm	●
55410007535	7.5mm x 35mm	●
55410007540	7.5mm x 40mm	●
55410007545	7.5mm x 45mm	●
55410007550	7.5mm x 50mm	●
55410007555	7.5mm x 55mm	●
55410007560*	7.5mm x 60mm	●

Screw Color-coding Size Reference

4.5mm	5.5mm	6.5mm	7.5mm
●	●	●	●

5.5/6.0MM COBALT-CHROME REDUCTION MULTI-AXIAL SCREW (RMAS)



Catalog Number	Description	
55890004525*	4.5mm x 25mm	●
55890004530	4.5mm x 30mm	●
55890004535	4.5mm x 35mm	●
55890004540*	4.5mm x 40mm	●
55890004545*	4.5mm x 45mm	●
55890005525*	5.5mm x 25mm	●
55890005530	5.5mm x 30mm	●
55890005535	5.5mm x 35mm	●
55890005540	5.5mm x 40mm	●
55890005545	5.5mm x 45mm	●
55890005550	5.5mm x 50mm	●
55890005555*	5.5mm x 55mm	●

Catalog Number	Description	
55890006525*	6.5mm x 25mm	●
55890006530	6.5mm x 30mm	●
55890006535	6.5mm x 35mm	●
55890006540	6.5mm x 40mm	●
55890006545	6.5mm x 45mm	●
55890006550	6.5mm x 50mm	●
55890006555*	6.5mm x 55mm	●
55890006560*	6.5mm x 60mm	●
55890007535*	7.5mm x 35mm	●
55890007540	7.5mm x 40mm	●
55890007545	7.5mm x 45mm	●
55890007550	7.5mm x 50mm	●
55890007555*	7.5mm x 55mm	●
55890007560*	7.5mm x 60mm	●

5.5/6.0MM RODS

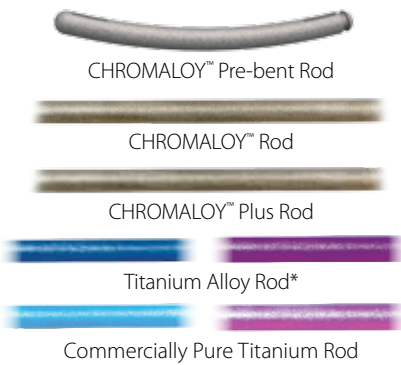

Commercially Pure Titanium	CHROMALLOY™	Description
1553201030	1555501030	30mm Pre-bent 5.5mm rod
1553201035	1555501035	35mm Pre-bent 5.5mm rod
1553201040	1555501040	40mm Pre-bent 5.5mm rod
1553201045	1555501045	45mm Pre-bent 5.5mm rod
1553201050	1555501050	50mm Pre-bent 5.5mm rod
1553201055	1555501055	55mm Pre-bent 5.5mm rod
1553201060	1555501060	60mm Pre-bent 5.5mm rod
1553201070	1555501070	70mm Pre-bent 5.5mm rod
1553201080	1555501080	80mm Pre-bent 5.5mm rod
1553201090	1555501090	90mm Pre-bent 5.5mm rod
1553201100	1555501100	100mm Pre-bent 5.5mm rod
1553201110	1555501110	110mm Pre-bent 5.5mm rod
1553201120	1555501120	120mm Pre-bent 5.5mm rod

CHROMALLOY™ PLUS	Titanium Alloy	Commercially Pure Titanium	CHROMALLOY™	Description
1556Q00500*	1554200500	1553200500	1555Q00500*	500mm Straight 5.5mm rod
1606Q00500*	1604200500	1603200500	1605Q00500*	500mm Straight 5.5mm rod

*A lined rods can be ordered by replacing the 5h digit undelined from 0 to 2 (ex: 1605200500)

5.5/6.0MM SAGITTAL ADJUSTING SCREWS



Catalog Number	Description		Catalog Number	Description	
55811004520*	4.5mm x 20mm	●	55811006530*	6.5mm x 30mm	●
55811004525	4.5mm x 25mm	●	55811006535	6.5mm x 35mm	●
55811004530	4.5mm x 30mm	●	55811006540	6.5mm x 40mm	●
55811004535	4.5mm x 35mm	●	55811006545	6.5mm x 45mm	●
55811004540	4.5mm x 40mm	●	55811006550	6.5mm x 50mm	●
55811004545	4.5mm x 45mm	●	55811006555*	6.5mm x 55mm	●
55811005530	5.5mm x 30mm	●	55811007535	7.5mm x 35mm	●
55811005535	5.5mm x 35mm	●	55811007540	7.5mm x 40mm	●
55811005540	5.5mm x 40mm	●	55811007545	7.5mm x 45mm	●
55811005545	5.5mm x 45mm	●	55811007550	7.5mm x 50mm	●
55811005550	5.5mm x 50mm	●	55811007555*	7.5mm x 55mm	●

May be ordered as an extra instrument.

Product Ordering Information *Continued*

TITANIUM HOOKS



Hook Color-Coding Size Reference

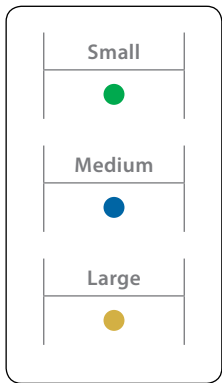

5.5/6.0mm	5.5mm	6.35mm	Description	
5541102	7541102	7641202	Pedicle Hook, Small	●
5541103	7541103	7641203	Pedicle Hook, Medium	●
5541104	7541104	7641204	Pedicle Hook, Large	●
5541112	7541112	7641212	Wide Blade Hook, Small	●
5541113	7541113	7641213	Wide Blade Hook, Medium	●
5541114	7541114	7641214	Wide Blade Hook, Large	●
5541122	7541122	7641222	Narrow Blade Hook, Small	●
5541123	7541123	7641223	Narrow Blade Hook, Medium	●
5541124	7541124	7641224	Narrow Blade Hook, Large	●
5541133	7541133	7641133	Ramped, Wide Blade, Medium	●
5541142	7541142	7641142	Ramped, Narrow Blade, Small	●
5541143	7541143	7641143	Ramped, Narrow Blade, Medium	●
	7541153		Lumbar Supralaminar, Medium	●
	7541162	7641162	Lumbar Angled Blade, Small	●
	7541163	7641163	Lumbar Angled Blade, Medium	●
5541173	7541172		Extended Body Hook, Small	●
5541174	7541173	7641173	Extended Body Hook, Medium	●
5541188	7541174	7641174	Extended Body Hook, Large	●
5541189	7541188	7641188	Thoracic Angled Blade, Right	
5541198	7541189	7641189	Thoracic Angled Blade, Left	
5541199	7541198	7641198	Right Offset Hook, Large	●
7541199	7541199	7641199	Left Offset Hook, Large	●

CD HORIZON® X10 CROSSLINK® PLATES, TITANIUM



5.5mm	6.35mm	Description
8115516	8116416	16mm Fixed
8115519	8116419	19mm Fixed
8115522	8116422	22mm Fixed
8115525	8116425	25mm Fixed
8115528	8116428	28mm-30mm MULTISPAN
8115530	8116430	30mm-34mm MULTISPAN
8115534	8116434	34mm-36 mm MULTISPAN
8115536	8116436	36mm-39mm MULTISPAN
8115539	8116439	39mm-45mm MULTISPAN
8115545	8116445	45mm-58mm MULTISPAN
8115558	8116458	58mm-80mm MULTISPAN
8110855	8110855	Set Screw

SIDE LOADING LATERAL CONNECTORS

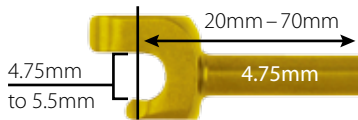

Catalog Number	Description
4.75mm to 4.75mm	
5444220	4.75mm Side Loading Lateral Connector, 4.75mm Post, 20mm Length
5444225	4.75mm Side Loading Lateral Connector, 4.75mm Post, 25mm Length
5444235	4.75mm Side Loading Lateral Connector, 4.75mm Post, 35mm Length
5444270*	4.75mm Side Loading Lateral Connector, 4.75mm Post, 70mm Length

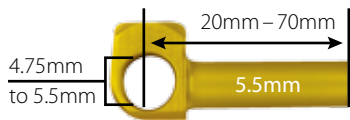

Catalog Number	Description
4.75mm to 5.5mm	
5454120	4.75mm Closed Lateral Connector, 5.5mm Post, 20mm Length
5454125	4.75mm Closed Lateral Connector, 5.5mm Post, 25mm Length
5454135	4.75mm Closed Lateral Connector, 5.5mm Post, 35mm Length
5454170*	4.75mm Closed Lateral Connector, 5.5mm Post, 70mm Length

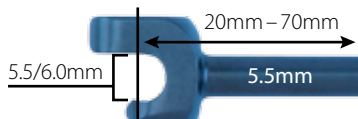

Catalog Number	Description
5.5/6.0mm to 5.5mm	
5554220	5.5/6.0mm Side Loading Lateral Connector, 5.5mm Post, 20mm Length
5554225	5.5/6.0mm Side Loading Lateral Connector, 5.5mm Post, 25mm Length
5554235	5.5/6.0mm Side Loading Lateral Connector, 5.5mm Post, 35mm Length
5554270*	5.5/6.0mm Side Loading Lateral Connector, 5.5mm Post, 70mm Length

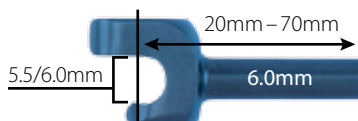

Catalog Number	Description
5.5/6.0mm to 6.0mm	
5564220	5.5/6.0mm Side Loading Lateral Connector, 6.0mm Post, 20mm Length
5564225	5.5/6.0mm Side Loading Lateral Connector, 6.0mm Post, 25mm Length
5564235	5.5/6.0mm Side Loading Lateral Connector, 6.0mm Post, 35mm Length
5564270*	5.5/6.0mm Side Loading Lateral Connector, 6.0mm Post, 70mm Length

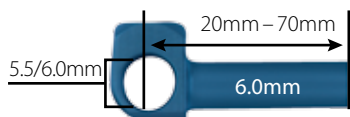

Catalog Number	Description
5.5/6.0mm to 6.0mm	
5564120	5.5/6.0mm Closed Lateral Connector, 6.0mm Post, 20mm Length
5564125	5.5/6.0mm Closed Lateral Connector, 6.0mm Post, 25mm Length
5564135	5.5/6.0mm Closed Lateral Connector, 6.0mm Post, 35mm Length
5564170*	5.5/6.0mm Closed Lateral Connector, 6.0mm Post, 70mm Length

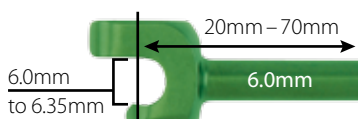

Catalog Number	Description
6.0mm to 6.35mm	
5764220*	6.35mm Side Loading Lateral Connector, 6.0mm Post, 20mm Length
5764225*	6.35mm Side Loading Lateral Connector, 6.0mm Post, 25mm Length
5764235*	6.35mm Side Loading Lateral Connector, 6.0mm Post, 35mm Length
5764270*	6.35mm Side Loading Lateral Connector, 6.0mm Post, 70mm Length

Product Ordering Information *Continued*

TITANIUM CLOSED MULTI-AXIAL ILIAC SCREWS*



Catalog Number	Description	Catalog Number	Description
70465540	5.5mm × 40mm	70467560	7.5mm × 60mm
70465550	5.5mm × 50mm	70467570	7.5mm × 70mm
70465560	5.5mm × 60mm	70467580	7.5mm × 80mm
70466550	6.5mm × 50mm	70468570	8.5mm × 70mm
70466560	6.5mm × 60mm	70468580	8.5mm × 80mm
70466570	6.5mm × 70mm	70468590	8.5mm × 90mm

TITANIUM ILIAC SCREWS*



Catalog Number	Description	Catalog Number	Description
7040650	6.5mm × 50mm, 0°	7041780	7.5mm × 80mm, 10°
7040660	6.5mm × 60mm, 0°	7041870	8.5mm × 70mm, 10°
7040670	6.5mm × 70mm, 0°	7041880	8.5mm × 80mm, 10°
7040760	7.5mm × 60mm, 0°	7041890	8.5mm × 90mm, 10°
7040770	7.5mm × 70mm, 0°	7042650	6.5mm × 50mm, 20°
7040780	7.5mm × 80mm, 0°	7042660	6.5mm × 60mm, 20°
7040870	8.5mm × 70mm, 0°	7042670	6.5mm × 70mm, 20°
7040880	8.5mm × 80mm, 0°	7042760	7.5mm × 60mm, 20°
7040890	8.5mm × 90mm, 0°	7042770	7.5mm × 70mm, 20°
7041650	6.5mm × 50mm, 10°	7042780	7.5mm × 80mm, 20°
7041660	6.5mm × 60mm, 10°	7042870	8.5mm × 70mm, 20°
7041670	6.5mm × 70mm, 10°	7042880	8.5mm × 80mm, 20°
7041760	7.5mm × 60mm, 10°	7042890	8.5mm × 90mm, 20°
7041770	7.5mm × 70mm, 10°		

TITANIUM ILIAC SET SCREWS



Catalog Number	Description
7049855	Hex Break-off Set Screws
7045855	Set Screw for Fixed Titanium Iliac Screw

TITANIUM ILIAC LATERAL CONNECTORS



Catalog Number	Description
5443110	4.75mm/6.35mm Closed, 10mm
5443120	4.75mm/6.35mm Closed, 20mm
5443130	4.75mm/6.35mm Closed, 30mm
5443160	4.75mm/6.35mm Closed, 60mm
7041310	5.5mm/6.35mm Closed, 10mm
7041320	5.5mm/6.35mm Closed, 20mm
7041330	5.5mm/6.35mm Closed, 30mm
7041360	5.5mm/6.35mm Closed, 60mm
7041410	6.35mm/6.35mm Closed, 10mm
7041420	6.35mm/6.35mm Closed, 20mm
7041430	6.35mm/6.35mm Closed, 30mm
7041460	6.35mm/6.35mm Closed, 60mm

*Lateral Connectors must be used with CD HORIZON® System Iliac Screws.

Important
Information

Important Information

PURPOSE

The CD HORIZON® Spinal System is intended to help provide immobilization and stabilization of spinal segments as an adjunct to fusion of the thoracic, lumbar, and/or sacral spine.

DESCRIPTION

The CD HORIZON® Spinal System consists of a variety of shapes and sizes of rods, hooks, screws, CROSSLINK® Plates, staples and connecting components, as well as implant components from other Medtronic spinal systems, which can be rigidly locked into a variety of configurations, with each construct being tailor-made for the individual case.

A subset of CD HORIZON® Spinal System components may be used for posterior pedicle screw fixation in pediatric cases. These constructs may be comprised of a variety of shapes and sizes of rods (ranging in diameter from 3.5mm to 6.35mm), hooks, screws, CROSSLINK® Plates, and connecting components. Similarly to the CD HORIZON® implants used in adult cases, these components can be rigidly locked into a variety of configurations, with each construct being tailor-made for the individual case.

Certain components within the CD HORIZON® Spinal System are specifically excluded for use in pediatric patients. These include PEEK rods, Shape Memory Alloy Staples, SPIRE™ Plates and DYNALOK® bolts. All screws used in pediatric cases are only cleared for use via a posterior approach. All of the components used in pediatric cases are fabricated from medical grade stainless steel, medical grade titanium, titanium alloy, and medical grade cobalt-chromium-molybdenum alloy.

Certain implant components from other Medtronic spinal systems can be used with the CD HORIZON® Spinal System in non-pediatric cases. These components include TSRH® rods, hooks, screws, plates, CROSSLINK® plates, connectors, staples, washers, GDLH® rods, hooks, connectors and CROSSLINK® bar and connectors; LIBERTY® rods and screws; DYNALOK® PLUS and DYNALOK CLASSIC® bolts along with rod/bolt connectors; and Medtronic Multi-Axial rods and screws. Please note that certain components are specifically designed to connect to specific rod diameters, while other components can connect to multiple rod diameters. Care should be taken so that the correct components are used in the spinal construct.

CD HORIZON® hooks are intended for posterior use only. CD HORIZON® staples and CD HORIZON® ECLIPSE® rods and associated screws are intended for anterior use only. However, for patients of smaller stature and pediatric patients, CD HORIZON® 4.5mm rods and associated components may be used posteriorly.

The CD HORIZON® Spinal System implant components are fabricated from medical grade stainless steel, medical grade titanium, titanium alloy, medical grade cobalt-chromium-molybdenum alloy, or medical grade PEEK OPTIMA-LT1. Certain CD HORIZON® Spinal System components may be coated with hydroxyapatite. No warranties expressed or implied are made. Implied warranties of merchantability and fitness for a particular purpose or use are specifically excluded. See the MDT Catalog for further information about warranties and limitations of liability.

Never use stainless steel and titanium implant components in the same construct.

Medical grade titanium, titanium alloy, and/or medical grade cobalt-chromium-molybdenum alloy may be used together. Never use titanium, titanium alloy, and/or medical grade cobalt-chromium-molybdenum alloy with stainless steel in the same construct.

The CD HORIZON® Spinal System also includes anterior staples made of Shape Memory Alloy (Nitinol – NiTi). Shape Memory Alloy is compatible with titanium, titanium alloy, and cobalt-chromium-molybdenum alloy. Do not use with stainless steel. These staples are not to be used in pediatric patients.

PEEK OPTIMA-LT1 implants may be used with stainless steel, titanium, or cobalt-chromium-molybdenum alloy implants. CD HORIZON® PEEK Rods are not to be used with CROSSLINK® Plates or in pediatric patients.

To achieve best results, do not use any of the CD HORIZON® Spinal System implant components with components from any other system or manufacturer unless specifically allowed to do so in this or another Medtronic document. As with all orthopaedic and neurosurgical implants, none of the CD HORIZON® Spinal System components should ever be reused under any circumstances.

INDICATIONS

The CD HORIZON® Spinal System with or without SEXTANT® instrumentation is intended for posterior, non-cervical fixation as an adjunct to fusion for the following indications: degenerative disc disease (defined as back pain of discogenic origin with degeneration of the disc confirmed by history and radiographic studies); spondylolisthesis; trauma (i.e., fracture or dislocation); spinal stenosis; curvatures (i.e., scoliosis, kyphosis and/or lordosis); tumor; pseudarthrosis; and/or failed previous fusion.

Except for hooks, when used as an anterolateral thoracic/lumbar system, the CD HORIZON® Spinal System may also be used for the same indications as an adjunct to fusion.

With the exception of degenerative disc disease, the CD HORIZON® LEGACY™ 3.5mm rods and the CD HORIZON®

Important Information

Spinal System PEEK rods and associated components may be used for the aforementioned indications in skeletally mature patients as an adjunct to fusion. The 3.5mm rods may be used for the specific pediatric indications noted below.

When used for posterior non-cervical pedicle screw fixation in pediatric patients, the CD HORIZON® Spinal System implants are indicated as an adjunct to fusion to treat adolescent idiopathic scoliosis. Additionally, the CD HORIZON® Spinal System is intended to treat pediatric patients diagnosed with the following conditions: spondylolisthesis/spondylolysis, and fracture caused by tumor and/or trauma. These devices are to be used with autograft and/or allograft. Pediatric pedicle screw fixation is limited to a posterior approach.

The CD HORIZON® SPIRE™ Plate is a posterior, single level, non-pedicle supplemental fixation device intended for use in the non-cervical spine (T1-S1) as an adjunct to fusion in skeletally mature patients. It is intended for plate fixation/attachment to spinous processes for the purpose of achieving supplemental fixation in the following conditions: degenerative disc disease (as previously defined); spondylolisthesis; trauma; and/or tumor.

In order to achieve additional levels of fixation, the CD HORIZON® Spinal System rods may be connected to the VERTEX® Reconstruction System with the VERTEX® rod connector. Refer to the VERTEX® Reconstruction System Package Insert for a list of the VERTEX® indications of use.

CONTRAINDICATIONS

Contraindications include, but are not limited to:

- Active infectious process or significant risk of infection (immunocompromise).
- Signs of local inflammation.
- Fever or leukocytosis.
- Morbid obesity.
- Pregnancy.
- Mental illness.
- Grossly distorted anatomy caused by congenital abnormalities.
- Any other medical or surgical condition which would preclude the potential benefit of spinal implant surgery, such as the presence of congenital abnormalities, elevation of sedimentation rate unexplained by other diseases, elevation of white blood count (WBC), or a marked left shift in the WBC differential count.
- Suspected or documented metal allergy or intolerance.
- Any case not needing a bone graft and fusion.
- Any case where the implant components selected for use would be too large or too small to achieve a successful result.

- Any patient having inadequate tissue coverage over the operative site or inadequate bone stock or quality.
- Any patient in which implant utilization would interfere with anatomical structures or expected physiological performance.
- The CD HORIZON® SPIRE™ Plate and the CD HORIZON® PEEK Rods are specifically contraindicated for use in pediatric patients.
- Any patient unwilling to follow postoperative instructions.
- Any case not described in the indications.

NOTA BENE: Although not absolute contraindications, conditions to be considered as potential factors for not using this device include:

- Severe bone resorption.
- Osteomalacia.
- Severe osteoporosis.

POTENTIAL ADVERSE EVENTS

All of the possible adverse events associated with spinal fusion surgery without instrumentation are possible. With instrumentation, a listing of potential adverse events includes, but is not limited to:

- Early or late loosening of any or all of the components.
- Disassembly, bending, and/or breakage of any or all of the components.
- Foreign body (allergic) reaction to implants, debris, corrosion products (from crevice, fretting, and/or general corrosion), including metallosis, staining, tumor formation, and/or autoimmune disease.
- Pressure on the skin from component parts in patients with inadequate tissue coverage over the implant possibly causing skin penetration, irritation, fibrosis, neurosis, and/or pain.
- Bursitis.
- Tissue or nerve damage caused by improper positioning and placement of implants or instruments.
- Post-operative change in spinal curvature, loss of correction, height, and/or reduction.
- Infection.
- Dural tears, pseudomeningocele, fistula, persistent CSF leakage, and/or meningitis.
- Loss of neurological function (e.g., sensory and/or motor) including paralysis (complete or incomplete), dysesthesias, hyperesthesia, anesthesia, paresthesia, appearance of radiculopathy, and/or the development or continuation of pain, numbness, neuroma, spasms, sensory loss, tingling sensation, and/or visual deficits.
- Cauda equina syndrome, neuropathy, neurological deficits (transient or permanent), paraplegia,

Important Information

paraparesis, reflex deficits, irritation, arachnoiditis, and/or muscle loss.

- Urinary retention or loss of bladder control or other types of urological system compromise.
- Scar formation possibly causing neurological compromise or compression around nerves and/or pain.
- Fracture, microfracture, resorption, damage, or penetration of any spinal bone (including the sacrum, pedicles, and/or vertebral body) and/or bone graft or bone graft harvest site at, above, and/or below the level of surgery.
- Retropulsed graft.
- Herniated nucleus pulposus, disc disruption or degeneration at, above, or below the level of surgery.
- Non-union (or pseudarthrosis), delayed union, and mal-union.
- Cessation of any potential growth of the operated portion of the spine.
- Loss of or increase in spinal mobility or function.
- Inability to perform the activities of daily living.
- Bone loss or decrease in bone density, possibly caused by stresses shielding.
- Graft donor site complications including pain, fracture, or wound healing problems.
- Ileus, gastritis, bowel obstruction, loss of bowel control, or other types of gastrointestinal system compromise.
- Hemorrhage, hematoma, occlusion, seroma, edema, hypertension, embolism, stroke, excessive bleeding, phlebitis, wound necrosis, wound dehiscence, damage to blood vessels, or other types of cardiovascular system compromise.
- Reproductive system compromise including sterility, loss of consortium, and sexual dysfunction.
- Development of respiratory problems (e.g., pulmonary embolism, atelectasis, bronchitis, pneumonia, etc).
- Change in mental status.
- Death.

Note: Additional surgery may be necessary to correct some of these potential adverse events.

ADDITIONAL POTENTIAL ADVERSE EVENTS FOR PEDIATRIC PATIENTS

- Inability to use pedicle screw fixation due to anatomic limitations (pedicle dimensions and/or distorted anatomy)
- Pedicle screw malpositioning, with or without neurological or vascular injury
- Proximal or distal junctional kyphosis
- Pancreatitis

WARNINGS

The safety and effectiveness of pedicle screw spinal systems have been established only for spinal conditions with significant mechanical instability or deformity requiring fusion with instrumentation. These conditions are significant mechanical instability or deformity of the thoracic, lumbar, and sacral spine secondary to degenerative spondylolisthesis with objective evidence of neurologic impairment, fracture, dislocation, scoliosis, kyphosis, spinal tumor, and failed previous fusion (pseudarthrosis). The safety and effectiveness of this device for any other conditions are unknown. The implants are not prostheses. In the absence of fusion, the instrumentation and/or one or more of its components can be expected to pull out, bend, or fracture as a result of exposure to every day mechanical stresses.

A device that has been implanted should never be reused, reprocessed or resterilized under any circumstances. Sterile packaged devices should also never be resterilized. Reuse, reprocessing, or resterilization may compromise the structural integrity of these implants and create a risk of contamination of the implants which could result in patient injury, illness, or death.

ADDITIONAL WARNINGS FOR PEDIATRIC PATIENTS

Warning: The safety and effectiveness of this device has not been established for use as part of a growing rod construct. This device is only intended to be used when definitive fusion is being performed at all instrumented levels.

The use of pedicle screw fixation in the pediatric population may present additional risks when patients are of smaller stature and skeletally immature. Pediatric patients may have smaller spinal structures (pedicle diameter or length) that may preclude the use of pedicle screws or increase the risk of pedicle screw malpositioning and neurological or vascular injury. Patients not skeletally mature that undergo spinal fusion procedures may have reduced longitudinal spinal growth, or may be at risk for rotational spinal deformities (the “crankshaft phenomenon”) due to continued differential growth of the anterior spine.

Other adverse events related to pedicle screw fixation, such as screw or rod bending, breakage, or loosening, may also occur in pediatric patients. Pediatric patients may be at increased risk for device-related injury because of their smaller stature.

ADDITIONAL WARNING FOR THE CD HORIZON® SPIRE™ SPINOUS PROCESS PLATE

Please consider the extent of decompression, as well as the amount of intact bone remaining on the spinous processes, when using the CD HORIZON® SPIRE™ Plate as the sole supplemental fixation for an interbody fusion procedure.

Important Information

PRECAUTIONS

The implantation of pedicle screw spinal systems should be performed only by experienced spinal surgeons with specific training in the use of this pedicle screw spinal system because this is a technically demanding procedure presenting a risk of serious injury to the patient.

A successful result is not always achieved in every surgical case. This fact is especially true in spinal surgery where many extenuating circumstances may compromise the results. This device system is not intended to be the sole means of spinal support. Use of this product without a bone graft or in cases that develop into a non-union will not be successful. No spinal implant can withstand body loads without the support of bone. In this event, bending, loosening, disassembly, and/or breakage of the device(s) will eventually occur.

Preoperative and operating procedures, including knowledge of surgical techniques, good reduction, and proper selection and placement of the implants are important considerations in the successful utilization of the system by the surgeon. Further, the proper selection and compliance of the patient will greatly affect the results. Patients who smoke have been shown to have an increased incidence of non-unions. These patients should be advised of this fact and warned of this consequence. Obese, malnourished, and/or alcohol abuse patients are also poor candidates for spine fusion. Patients with poor muscle and bone quality and/or nerve paralysis are also poor candidates for spine fusion.

ADDITIONAL PRECAUTIONS FOR PEDIATRIC PATIENTS

The implantation of pedicle screw spinal systems in pediatric patients should be performed only by experienced spinal surgeons with specific training in the use of this pedicle screw spinal system in pediatric patients because this is a technically demanding procedure presenting a risk of serious injury to the patient.

Preoperative and operating procedures, including knowledge of surgical techniques, good reduction, and proper selection and placement of the implants are important considerations in the successful utilization of the system in pediatric patients.

The selection of the proper size, shape, and design of the implant for each patient is crucial to the safe use of this device in pediatric patients.

PHYSICIAN NOTE: Although the physician is the learned intermediary between the company and the patient, the important medical information given in this document should be conveyed to the patient.

USA For US Audiences Only

CAUTION: FEDERAL LAW (USA) RESTRICTS THESE DEVICES TO SALE BY OR ON THE ORDER OF A PHYSICIAN.



Medtronic B.V.
Earl Bakkenstraat 10
6422 PJ Heerlen
The Netherlands
Tel: + 31 45 566 80 00



Medtronic Sofamor Danek USA, Inc.
1800 Pyramid Place
Memphis, TN 38132
Telephone 800 933 2635 (In U.S.A.)
901 396 3133 (Outside of U.S.A.)
Fax 901 396 0356

©2011 Medtronic Sofamor Danek USA, Inc. All rights reserved.

Please contact your Sales Representative or Customer Service for the most up-to-date version of the package insert.

Summary of Indications

MASTERGRAFT® Ceramic Scaffolds are cleared as bone void fillers for bony voids of the skeletal system (i.e., posterolateral spine, pelvis, ilium, and/or extremities). MASTERGRAFT® Granules, MASTERGRAFT® Putty, and MASTERGRAFT® Strip are also cleared as autogenous bone graft extenders. MASTERGRAFT® Granules, MASTERGRAFT® Mini Granules, and MASTERGRAFT® Putty are also cleared for use in bony voids or gaps to fill and/or augment dental oral/maxillofacial bony tissue.

The CAPSTONE® Spinal System is indicated for interbody fusion with autogenous bone graft in patients with Degenerative Disc Disease (DDD) at one or two levels from L2 to S1. These DDD patients may also have up to Grade 1 Spondylolisthesis or retrolisthesis at the involved levels. DDD is defined as discogenic back pain with degeneration of the disc confirmed by history and radiographic studies. These patients should be skeletally mature and have had six months of non-operative treatment. These implants may be implanted via an open or a minimally invasive posterior approach. Alternatively, these implants may also be implanted via an anterior and/or transforaminal approach. These implants are to be used with autogenous bone graft. These devices are intended to be used with supplemental fixation instrumentation, which has been cleared by the FDA for use in the lumbar spine.

The CLYDESDALE™ Spinal System is designed to be used with autogenous bone graft to facilitate interbody fusion and is intended for use with supplemental fixation systems cleared for use in the lumbar spine. The CLYDESDALE™ Spinal System is used for patients diagnosed with Degenerative Disc Disease (DDD) at one or two contiguous levels from L2 to S1. These DDD patients may also have up to Grade 1 Spondylolisthesis or retrolisthesis at the involved levels. DDD is defined as discogenic back pain with degeneration of the disc confirmed by history and radiographic studies. These patients should be skeletally mature and have had six months of non-operative treatment. These implants may be implanted via a minimally invasive lateral approach.

The SOVEREIGN® Spinal System is indicated for use with autogenous bone graft in patients with degenerative disc disease (DDD) at one or two contiguous levels from L2 to S1. DDD is defined as discogenic back pain with degeneration of the disc confirmed by history and radiographic studies. These patients should be skeletally mature and have had six months of non-operative treatment. These implants may be implanted via a laparoscopic or an open anterior approach. The SOVEREIGN® interbody system may be used as a

stand-alone device or in conjunction with supplemental fixation. When used as a standalone device, the SOVEREIGN® interbody device is intended to be used with the three titanium alloy fixed or variable angle screws. The accompanying cover plate MUST be used anytime the device is used with any number of variable angle screws. If the physician chooses to use less than three or none of the provided screws, then additional supplemental fixation for use in the lumbar spine must be used to augment stability.

The T2 ALTITUDE™ Expandable Corpectomy System is a vertebral body replacement system intended for use in the thoracolumbar spine (T1-L5) to replace a collapsed, damaged, or unstable vertebral body due to tumor or trauma (i.e., fracture). The T2 ALTITUDE™ Expandable Centerpiece may be used with or without optional modular endcaps which accommodate individual anatomic requirements. The device is to be used with supplemental fixation. Specifically, the construct is to be used with the VANTAGE® Anterior Fixation System, the TSRH® Spinal System, the CD HORIZON® Spinal System, or their successors. Additionally, the T2 ALTITUDE™ Expandable Corpectomy System is intended to be used with allograft and/or autograft.

The CRESCENT® Spinal System is indicated for interbody fusion with autogenous bone graft in patients with Degenerative Disc Disease (DDD) at one or two levels from L2 to S1. These DDD patients may also have up to Grade 1 spondylolisthesis or retrolisthesis at the involved levels. DDD is defined as discogenic back pain with degeneration of the disc confirmed by history and radiographic studies. These patients should be skeletally mature and have had six months of non-operative treatment. These implants are to be used autogenous bone graft. These devices are intended to be used with supplemental fixation instrumentation which has been cleared by the FDA for use in the lumbar spine.

NANOSTIM™ Synthetic Bone Paste is a resorbable, nanocrystalline hydroxyapatite bone grafting paste with osteoconductive properties that facilitate new bone formation and bone healing. Delivered in a syringe, NANOSTIM™ Synthetic Bone Paste is ready-to-use in the filling and reconstruction of bone defects in orthopaedics, traumatology and neurosurgery.

MediShield™ Gel is intended to be used as an adjunct to posterior lumbar laminectomy, laminotomy, or discectomy procedures for reducing pain, radiculopathy, lower extremity weakness, and the incidence, extent, and severity of postoperative adhesions.

Summary of Important Product Information for the POWEREASE® System

INDICATIONS FOR USE

The IPC® POWEREASE® System is indicated for drilling, tapping, and driving screws and working end attachments during spinal surgery, including open and minimally invasive procedures. It is also used in the placement of screws or cutting of screws, posts, and rods.

The IPC® POWEREASE® System is indicated for the incision/cutting, removal, drilling, and sawing of soft and hard tissue and bone, and biomaterials in Neurological (Cranial, Craniofacial), Orthopedic Arthroscopic, Spinal, Sternotomy, and General surgical procedures.

Do not cut rods in situ.

Refer to the Reprocessing Instructions for the POWEREASE® System Working Ends package insert (M708348B184) for the cleaning instructions and sterilization parameters and requirements.

THERAPIES

SERVICES & SUPPORT

ENABLING TECHNOLOGIES

www.medtronic.com

www.medtronic.eu



Medtronic SOFAMOR DANEK
1800 Pyramid Place
Memphis, Tennessee 38132
Telephone 800 876 3133 (in U.S.A.)
901 396 3133 (Outside U.S.A.)
Fax 901 396 3133

For more information visit
www.myspinetools.com

Medtronic International Trading Sàrl
Case Postale
Route du Molliau 31
CH-1131 Tolochenaz
Tel: +41 (0)21 802 70 00
Fax: +41 (0)21 802 79 00

The surgical technique shown is for illustrative purposes only. The technique(s) actually employed in each case will always depend upon the medical judgment of the surgeon exercised before and during surgery as to the best mode of treatment for each patient.

Please see the package insert for the complete list of indications, warnings, precautions, and other important medical information.



Medtronic