

Compact cylinders ADN/AEN, to ISO 21287

FESTO



Festo Core Range
Solves the majority of your automation tasks

Worldwide:
Simply good:
Fast:

Quickest delivery – wherever, whenever
Expected high Festo quality
Easy and fast to select

With the Festo Core Range, we have selected the most important products and functions from our broad product catalogue, and added the quickest delivery.

The Core Range offers you the best value for your automation tasks.

Just look
for the
star!

Key features

At a glance

Sensor slots on three sides for flush mounting of proximity sensors

Piston rod with choice of male or female thread

Mounting option:
Female thread and through-hole

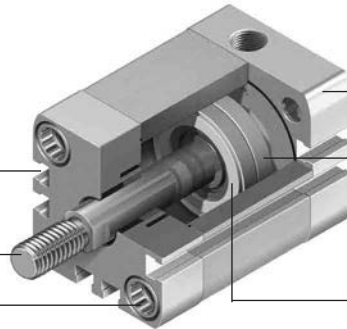

Centring hole in the end cap matches centring pins ZBS

Magnet for contactless position sensing

Integrated cushioning for absorbing residual energy

More than the standard

- The compact cylinder series ADN/AEN comply with the standard ISO 21287
- The ADN/AEN is characterised by its compact design and broad area of application thanks to the large number of variants
- The variants can be configured according to individual needs thanks to the modular product system

Powerful

- Integrated cushioning for absorbing residual energy
- Long service life thanks to exceptional cushioning characteristics and minimal friction factors

Convenient

- Easy to mount with a comprehensive range of mounting accessories for just about every type of installation
- Highly flexible thanks to the wide range of variants
- Contactless position sensing using proximity sensors

Reliable

- Optimised manufacturing methods, patented technology and more than 40 years of experience in the field of cylinders make Festo and ADN/AEN a great team

Cushioning types

Cushioning P

Mode of operation

- The drive has elastic polymer end-position cushioning

Application

- Small loads
- Low speeds
- Small cushioning capacity

Advantages

- No adjustment required
- Saves time

Cushioning PPS

Mode of operation

- The drive has self-adjusting, pneumatic end-position cushioning

Application

- Larger loads
- Higher speeds
- Larger cushioning capacity

Advantages

- No adjustment required
- Up to 4 times bigger cushioning capacity than ADN-...-P
- Saves time
- Reduced noise

Cushioning capacity of ISO 21287 and ISO 15552

In terms of cushioning capacity, the compact cylinder ADN-...-PPS fills the gap between ADN-...-P and standards-based cylinders with ISO 15552.

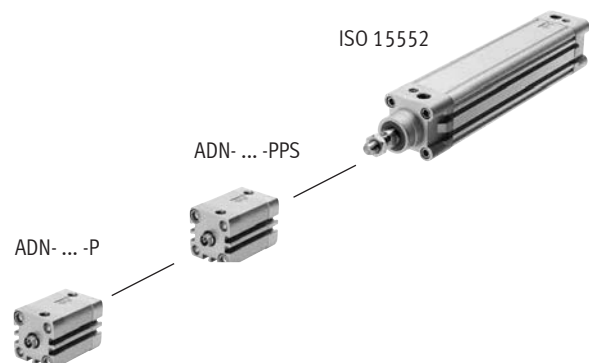

For manufacturing lithium-ion batteries

ADN-...-F1A











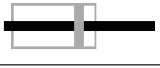

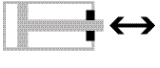
Recommended for production facilities for the manufacture of lithium-ion batteries.

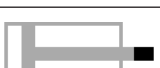
Metals with copper, zinc or nickel as the main constituent are excluded from use. Exceptions are nickel in steels, chemically nickel-plated surfaces, printed circuit boards, cables, electrical plug connectors and coils.

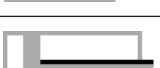

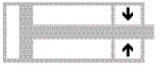





Accessories

Your Festo contact partner can provide information about which accessories are suitable for manufacturing lithium-ion batteries.

Key features

Variants from the modular product system		
Symbol	Key features	Description
	F1A Recommended for production plants for manufacturing lithium-ion batteries	Cylinders free of copper, zinc and nickel ($\leq 1\%$)
	S1 Reinforced piston rod	Increased lateral loads. Absorbs many times more lateral load than a basic cylinder
	S2 Through piston rod	The piston rod can be used for attachments at both ends of the cylinder
	S6 Heat-resistant seals	Temperature resistance up to max. 120°C
	S10 Constant motion (slow speed) at low piston speeds	<ul style="list-style-type: none"> • Break-away pressure: very low • Dynamic response: Suitable for very slow, constant and stick-slip-free movements Application example: Slow, constant feed motion
	S11 Low friction	<ul style="list-style-type: none"> • Break-away pressure: very low • Dynamic response: Especially suitable for slow movements with considerably reduced system friction • Application example: Slow applications where standstill is critical
	S20 Through, hollow piston rod	The piston rod can be used for attachments at both ends of the cylinder. The piston rod is hollow inside. This means it can be used to carry vacuum or compressed air
	K2 Extended male piston rod thread	–
	K5 Special piston rod thread	Metric standard thread to ISO
	K8 Extended piston rod	–
	K10 Smooth anodised aluminium piston rod	Ideal for use in welding environments: <ul style="list-style-type: none"> • Protection against welding spatter • Small working loads • Harder surface compared to steel • Long service life
	KP With clamping unit	Integrated clamping unit on the piston rod
	EL With end-position locking	Positive locking in the end position as a drop guard. If there is a drop in pressure, the cylinder is secured in its end position to prevent it from dropping
	Q Square piston rod	Protection against rotation. For correctly oriented feeding
	R3 High corrosion protection	All external cylinder surfaces comply with corrosion resistance class 3 to Festo standard 940070. The piston rod is made from corrosion- and acid-resistant steel
	R8 Dust protection with wiper seal	The cylinder has a hard-chrome-plated piston rod and a hard wiper seal, which protects against dry, dusty media
	TL Captive rating plate	Laser-etched rating plate. For easy identification of components when it comes to replacement, even after years in a harsh environment
	TT Low temperature	Temperature resistance down to max. -40°C
	F1A Recommended for production plants for manufacturing lithium-ion batteries	Cylinders free of copper, zinc and nickel ($\leq 1\%$)



Product range overview

Function	Design	Type	Piston \varnothing	Stroke	Position sensing	Recommended for production plants for manufacturing lithium-ion batteries	Cushioning		
			[mm]	[mm]			A	F1A	P
Double-acting	Basic version								
		ADN	12	5, 10, 15, 20, 25, 30, 40	1 ... 300	■	■	■	■
			16	5, 10, 15, 20, 25, 30, 40, 50	1 ... 300				
			20, 25	5, 10, 15, 20, 25, 30, 40, 50, 60	1 ... 300				
			32, 40, 50	5, 10, 15, 20, 25, 30, 40, 50, 60, 80	1 ... 400				
			63	10, 15, 20, 25, 30, 40, 50, 60, 80	1 ... 400				
			80, 100	10, 15, 20, 25, 30, 40, 50, 60, 80	1 ... 500				
			125	-	1 ... 500				
		ADN-...-S2 Through piston rod	12, 16, 20, 25	-	1 ... 300	■	■	■	■
			32, 40, 50, 63	-	1 ... 400				
			80, 100, 125	-	1 ... 500				
		ADN-...-S20 Through, hollow piston rod	16, 20, 25	-	1 ... 300	■	-	■	■
			32, 40, 50, 63	-	1 ... 400				
			80, 100, 125	-	1 ... 500				
	Reinforced piston rod								
		ADN-...-S1	25	-	5 ... 300	■	-	■	-
			40, 63	-	10 ... 400				
			100	-	10 ... 500				
	Non-rotating with square piston rod								
		ADN-...-Q	12, 16, 20, 25	-	1 ... 300	■	-	■	-
			32, 40, 50, 63	-	1 ... 400				
			80, 100, 125	-	1 ... 500				
		ADN-...-Q-S2 Through piston rod	12, 16, 20, 25	-	1 ... 300	■	-	■	-
32, 40, 50, 63			-	1 ... 400					
80, 100, 125			-	1 ... 500					
	ADN-...-Q-S20 Through, hollow piston rod	16, 20, 25	-	1 ... 200	■	-	■	-	
		32, 40, 50, 63	-	1 ... 300					
		80, 100, 125	-	1 ... 400					
Standard hole pattern, with clamping unit									
	ADN-...-KP	20, 25	-	10 ... 300	■	-	■	-	
		32, 40, 50, 63	-	10 ... 400					
		80, 100	-	10 ... 500					
Standard hole pattern, with end-position locking									
	ADN-...-EL	20, 25	-	10 ... 300	■	-	■	-	
		32, 40, 50, 63	-	10 ... 400					
		80, 100	-	10 ... 500					

Product range overview

Type	Male piston rod thread	Female piston rod thread	Extended male piston rod thread	Special piston rod thread	Extended piston rod	Smooth anodised piston rod	Heat-resistant seals max. 120°C	Slow speed (constant motion)	Low friction	High corrosion protection	Dust protection	Low temperature	→ Page/Internet
	A	I	K2	K5	K8	K10	S6	S10	S11	R3	R8	TT	
Basic version													
ADN	■	■	■	■	■	■ from Ø 20	■	■	■	■	■ from Ø 20	■ Ø 20 ... 100	13
ADN-...-S2 Through piston rod	■	■	■	■	■	-	■	-	-	-	-	■ Ø 20 ... 100	13
ADN-...-S20 Through, hollow piston rod	■	-	■	■	■	-	■	-	-	-	-	-	13
Reinforced piston rod													
ADN-...-S1	■	■	■	■	■	-	■	-	-	■	-	-	13
Non-rotating with square piston rod													
ADN-...-Q	■	■	■	■	■	-	■	-	-	-	-	-	13
ADN-...-Q-S2 Through piston rod	■	■	■	■	■	-	■	-	-	-	-	-	13
ADN-...-Q-S20 Through, hollow piston rod	■	-	■	■	■	-	■	-	-	-	-	-	13
Standard hole pattern, with clamping unit													
ADN-...-KP	■	■	■	■	■	-	-	-	-	-	-	-	40
Standard hole pattern, with end-position locking													
ADN-...-EL	■	■	■	■	■	-	-	-	-	-	-	-	49

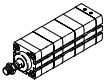
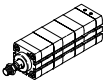

Product range overview

Function	Design	Type	Piston ø	Stroke	Position sensing	Cushioning		
			[mm]	[mm]		Fixed	Self-adjusting	
					A	P	PPS	
Double-acting	Standard hole pattern, non-rotating with yoke							
		ADNGF	12	5, 10, 15, 20, 25, 30, 40	1 ... 200	■	■	■ ø 20 ... 100
			16	5, 10, 15, 20, 25, 30, 40, 50	1 ... 200			
			20, 25	5, 10, 15, 20, 25, 30, 40, 50, 60	3 ... 200			
			32, 40, 50	5, 10, 15, 20, 25, 30, 40, 50, 60, 80	5 ... 300			
			63, 80	10, 15, 20, 25, 30, 40, 50, 60, 80	5 ... 300			
			100	10, 15, 20, 25, 30, 40, 50, 60, 80	5 ... 400			
		ADNGF-...-S2 Through piston rod	12, 16	-	1 ... 200	■	■	■ ø 20 ... 100
			20, 25		3 ... 200			
			32, 40, 50, 63, 80, 100		5 ... 250			
	Standard hole pattern, high-force cylinder							
		ADNH	25	-	1 ... 150	■	■	-
			40					
			63					
100								
Standard hole pattern, multi-position cylinder								
	ADNM	25	-	1 ... 2000	■	■	-	
		40						
		63						
		100						

Product range overview

Type	Male piston rod thread	Female piston rod thread	Extended male piston rod thread	Special piston rod thread	Extended piston rod	Heat-resistant seals max. 120°C	→ Page/Internet
	A	I	K2	K5	K8	S6	
Standard hole pattern, non-rotating with yoke							
ADNGF	-	-	-	-	-	■	adngf
ADNGF-...-S2 Through piston rod	-	-	-	-	-	■	adngf
Standard hole pattern, high-force cylinder							
ADNH	■	■	■	■	■	■	adnh
Standard hole pattern, multi-position cylinder							
ADNM	■	■	■	■	■	■	adnh

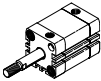
Product range overview

Function	Design	Type	Piston \varnothing	Stroke	Position sensing	Cushioning
			[mm]	[mm]	A	P
Single-acting	Basic version					
		AEN	12	1 ... 10	■	■
			16, 20, 25, 32, 40, 50, 63, 80, 100	1 ... 25		
		AEN-...-Z Pulling	12	1 ... 10	■	■
			16, 20, 25, 32, 40, 50, 63, 80, 100	1 ... 25		
	Non-rotating with square piston rod					
	AEN-...-Q	16	1 ... 25	■	■	
		20, 25, 32, 40, 50, 63, 80, 100	1 ... 25			

Product range overview

Type	Male piston rod thread	Female piston rod thread	Extended male piston rod thread	Special piston rod thread	Extended piston rod	Smooth anodised piston rod	Heat-resistant seals max. 120°C	→ Page/Internet
	A	I	K2	K5	K8	K10	S6	
Basic version								
AEN	■	■	■	■	■	■ from Ø 20	■	59
AEN-...-Z Pulling	■	■	■	■	■	■ from Ø 20	■	59
Non-rotating with square piston rod								
AEN-...-Q	■	■	■	■	■	-	■	59

Peripherals overview

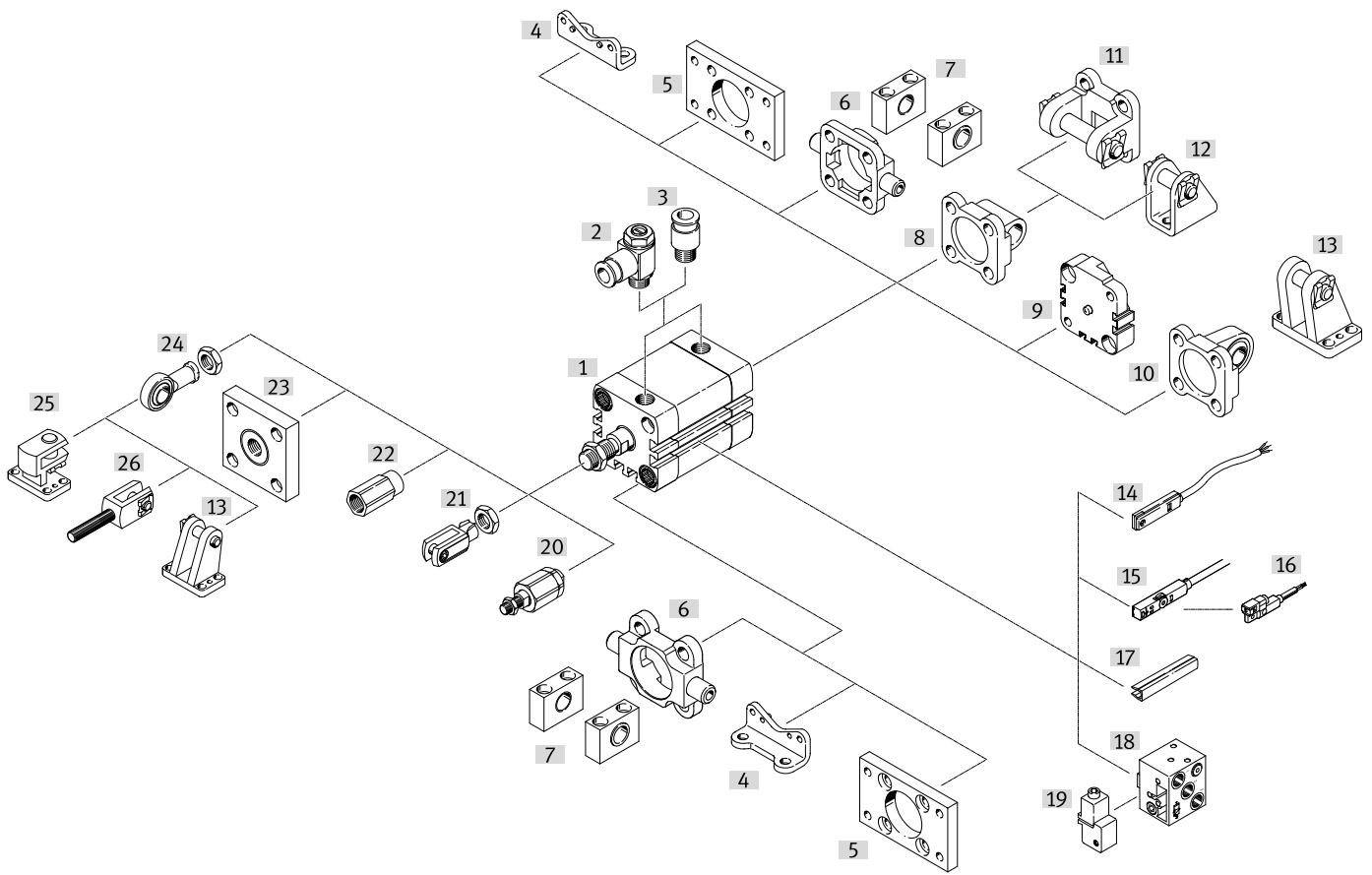

Peripherals overview

Mounting components and accessories		Description	→ Page/Internet
[1]	Compact cylinder ADN	Double-acting cylinder	13
	Compact cylinder AEN	Single-acting cylinder	59
[2]	One-way flow control valve GRLA/GRLZ	For speed regulation	83
[3]	Push-in fitting QS	For connecting compressed air tubing with standard O.D.	qs
[4]	Foot mounting HNA	For bearing or end caps	72
[5]	Flange mounting FNC	For bearing or end caps	73
[6]	Trunnion flange ZNCF/CRZNG	For bearing caps	80
[7]	Trunnion support LNZG	For trunnion flange ZNCF/CRZNG	81
[8]	Swivel flange SNCL/SNCL-...-R3	For end caps	74
[9]	Multi-position kit DPNA	For connecting two cylinders with identical piston diameters to form a multi-position cylinder	77
[10]	Swivel flange SNCS/CRSNCS/SNCS-...-R3	For end caps	75
[11]	Swivel flange SNCB/SNCB-...-R3	For swivel flange SNCL	79
[12]	Clevis foot LBN/CRLBN	For swivel flange SNCL	78
[13]	Clevis foot LBG/LBG-...-R3	For swivel flange SNCS	76
[14]	Proximity sensor SME-8	Can be integrated in the cylinder profile barrel	85
[15]	Proximity sensor SME/SMT-8M	Can be integrated in the cylinder profile barrel	85
[16]	Proximity sensor SMT-8G	Inserted in the slot lengthwise	85
[17]	Slot cover ABP-5-S	For protecting the sensor cables and the sensor slots from contamination	85
[18]	Proximity sensor SMPO-8E	Pneumatic output signal	85
[19]	Mounting kit SMB-8E	For proximity sensor SMPO-8E	85
[20]	Self-aligning rod coupler FK/CRFK	For compensating radial and angular deviations	82
[21]	Rod clevis SG/CRSG	Permits a swivelling movement of the cylinder in one plane	82
[22]	Adapter AD	For mounting a suction cup on a hollow piston rod	82
[23]	Coupling piece KSG/KSZ	To compensate for radial deviations	82
[24]	Rod eye SGS/CRSGS	With spherical bearing	82
[25]	Right-angle clevis foot LQG	For rod eye SGS	83
[26]	Rod clevis SGA	With male thread	82

Type codes

001	Series
ADN	Compact cylinder, double-acting, based on ISO 21287

002	Piston diameter [mm]
12	12
16	16
20	20
25	25
32	32
40	40
50	50
63	63
80	80
100	100
125	125

003	Stroke [mm]
5	5
10	10
15	15
20	20
25	25
30	30
40	40
50	50
60	60
80	80
...	5 ... 80

004	Piston rod thread type
A	Male thread
I	Female thread

005	Cushioning
P	Elastic cushioning rings/plates on both sides
PPS	Pneumatic cushioning, self-adjusting at both ends

006	Position sensing
A	For proximity sensor

007	Special material properties
	None
F1A	Recommended for production facilities for the manufacture of lithium-ion batteries

008	Protection against rotation
	None
Q	Square piston rod

009	Piston rod type
	At one end
S2	Through piston rod
S20	Through, hollow piston rod

010	Custom thread
"M5"K5	M5
"M6"K5	M6
"M8"K5	M8
"M10"K5	M10
"M10x1,25"K5	M10x1.25
"M12"K5	M12
"M16"K5	M16
"M20"K5	M20
"M20x1,5"K5	M20x1.5

011	Temperature range
	Standard
S6	Heat-resistant seals max. 120 °C

012	Constant motion
	Standard
S10	Uniform, slow movement

013	Running characteristics
	Standard
S11	Low friction

014	Improved running performance
	None
K10	Smooth anodised aluminium coated piston rod

015	Corrosion protection
	Standard
R3	High corrosion protection

016	Captive rating plate
	Rating plate, glued
TL	Laser etched rating plate

017	Low temperature
	None
TT	-40 °C ... +80 °C

018	Scrapper variant
	Standard
R8	Dust protection

019	EU certification
	None
EX4	II 2GD

Data sheet

Function
Elastic cushioning (P)

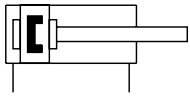

-  - Diameter
12 ... 125 mm

-  - Stroke length
1 ... 500 mm

Self-adjusting cushioning (PPS)

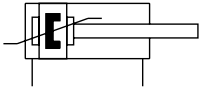

Variants → page 3



www.festo.com



General technical data		12	16	20	25	32	40	50	63	80	100	125
Piston \varnothing												
Design	Piston											
	Piston rod											
	Cylinder barrel											
Mode of operation	Double-acting											
Cushioning												
P	Elastic cushioning rings/plates at both ends											
PPS	-	Pneumatic cushioning, self-adjusting at both ends										-
Cushioning length												
PPS	[mm]	-	3	3.5	4	5	6	7	7.5	10	-	
Position sensing	Via proximity sensor											
Type of mounting	Via through-hole											
	Via female thread											
	Via accessories											
Mounting position	Any											

Technical data – Basic version and variants		12	16	20	25	32	40
Piston \varnothing							
Pneumatic connection							
-	M5	M5	M5	M5	G1/8	G1/8	
S1	-	-	-	M5	-	M5	
Female piston rod thread							
-	M3	M4	M6	M6	M8	M8	
K5	-	-	M5	M5	M6	M6	
S1	-	-	-	M6	-	M10	
S1-K5	-	-	-	M5	-	M8	
Male piston rod thread							
-	M5	M6	M8	M8	M10x1.25	M10x1.25	
K5	M6	M8	M10; M10x1.25	M10; M10x1.25	M10; M12	M10; M12	
S1	-	-	-	M8	-	M12x1.25	
S1-K5	-	-	-	M10; M10x1.25	-	M10x1.25; M12	
Q-K5	M6	M8	M10; M10x1.25	M10; M10x1.25	M10	M10	
Max. torsional backlash of piston rod [°]							
Q	2	1.8	1.6	1.6	1.2	1.2	

Data sheet

Technical data – Basic version and variants											
Piston ø	50		63		80		100		125		
Pneumatic connection											
–	G1/8		G1/8		G1/8		G1/8		G1/4		
S1	–		G1/8		–		G1/8		–		
Female piston rod thread											
–	M10		M10		M12		M12		M16		
K5	M8		M8		M10		M10		–		
S1	–		M12		–		M16		–		
S1-K5	–		M10		–		–		–		
Male piston rod thread											
–	M12x1.25		M12x1.25		M16x1.5		M16x1.5		M20x1.5		
K5	M12; M16		M12; M16		M16; M20; M20x1.5		M16; M20; M20x1.5		M20		
S1	–		M16x1.5		–		M20x1.5		–		
S1-K5	–		M12x1.25; M16		–		M16x1.5; M20		–		
Q-K5	M12		M12		M16		M16		M20		
Max. torsional backlash of piston rod [°]											
Q	1		1		0.8		0.8		0.8		
Operating and environmental conditions											
Piston ø	12	16	20	25	32	40	50	63	80	100	125
Operating medium	Compressed air to ISO 8573-1:2010 [7:4:4]										
Note on operating/ pilot medium	Lubricated operation possible (in which case lubricated operation will always be required)										
Operating pressure [bar]											
[MPa]											
–	0.1 ... 1		0.06 ... 1								
PPS	–		0.15 ... 1		0.1 ... 1						–
Q	0.13 ... 1		0.1 ... 1		0.08 ... 1		0.06 ... 1				
S1	–		0.1 ... 1		–		0.1 ... 1		–		0.1 ... 1
S2, S20	0.15 ... 1		0.13 ... 1		0.12 ... 1		0.1 ... 1		0.08 ... 1		
S6	0.1 ... 1		0.06 ... 1								
S11	0.045 ... 1		0.025 ... 1								
R8, TT	–		0.15 ... 1		0.1 ... 1						–
[bar]											
–	1 ... 10		0.6 ... 10								
PPS	–		1.5 ... 10		1 ... 10						–
Q	1.3 ... 10		1 ... 10		0.8 ... 10		0.6 ... 10				
S1	–		1 ... 10		–		1 ... 10		–		1 ... 10
S2, S20	1.5 ... 10		1.3 ... 10		1.2 ... 10		1 ... 10		0.8 ... 10		
S6	1 ... 10		0.6 ... 10								
S11	0.45 ... 10		0.25 ... 10								
R8, TT	–		1.5 ... 10		1 ... 10						–
Ambient temperature ¹⁾ [°C]											
–	–20 ... +80										
S6	0 ... +120										
R3	–20 ... +80										
TT	–		–40 ... +80								–
Corrosion resistance class CRC ²⁾											
–	2										
R3	3										
F1A	0										
ATEX	Selected types → www.festo.com										

1) Note operating range of proximity sensors

2) Corrosion resistance class CRC 0 to Festo standard FN 940070

No corrosion stress. Applies to small, visually unimportant standards-based parts such as threaded pins, circlips and clamping sleeves which are usually only available on the market in a phosphated or burnished version (and possibly oiled) as well as to ball bearings (for components < CRC 3) and plain bearings.

Corrosion resistance class CRC 2 to Festo standard FN 940070

Moderate corrosion stress. Indoor applications in which condensation can occur. External visible parts with primarily decorative surface requirements which are in direct contact with a normal industrial environment.

Corrosion resistance class CRC 3 to Festo standard FN 940070

High corrosion stress. Outdoor exposure under moderate corrosive conditions. Externally visible parts with primarily functional surface requirements which are in direct contact with a normal industrial environment.

Data sheet

Forces [N] and impact energy [J]											
Piston ø	12	16	20	25	32	40	50	63	80	100	125
Theoretical force at 6 bar, advancing											
-	68	121	188	295	483	754	1178	1870	3016	4712	7363
S1	-	-	-	295	-	754	-	1870	-	4712	-
S2	51	90	141	247	415	686	1057	1750	2827	4524	7069
Theoretical force at 6 bar, retracting											
-	51	90	141	247	415	686	1057	1750	2827	4524	7069
S1	-	-	-	247	-	633	-	1681	-	4417	-
S2	51	90	141	247	415	686	1057	1750	2827	4524	7069
Max. impact energy at the end positions											
-	0.07	0.15	0.2	0.3	0.4	0.7	1	1.3	1.8	2.5	3.3
S1	-	-	-	0.3	-	0.7	-	1.3	-	2.5	-
S6	0.035	0.075	0.1	0.15	0.2	0.35	0.5	0.65	0.9	1.25	1.75
K10	-	-	0.16	0.24	0.32	0.56	0.8	1	1.4	2	2.6
S20	-	0.016	0.024	0.083	0.15	0.39	0.48	0.62	0.8	0.9	0.95

Note
These specifications represent the maximum values that can be achieved. The maximum permissible impact energy must be observed.

Permissible impact speed: $V = \sqrt{\frac{2 \times E}{m_1 + m_2}}$

Maximum permissible mass: $m_2 = \frac{2 \times E}{v^2} - m_1$

V Perm. impact speed
E Max. impact energy
m1 Moving mass (drive)
m2 Moving payload

Note
In combination with the self-adjusting cushioning (PPS), the maximum impact energy is still obtained.

Max. energy conversion capacity [J]								
Piston ø	20	25	32	40	50	63	80	100
For self-adjusting cushioning (PPS)	0.65	0.8	1	1.7	2.8	4.8	8	12

Max. lateral load F_q as a function of projection x

ø 12 ... 63

ø 80 ... 125

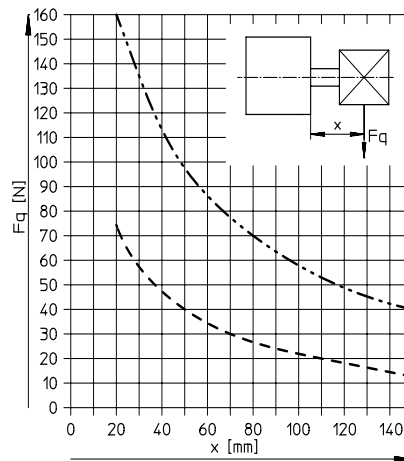
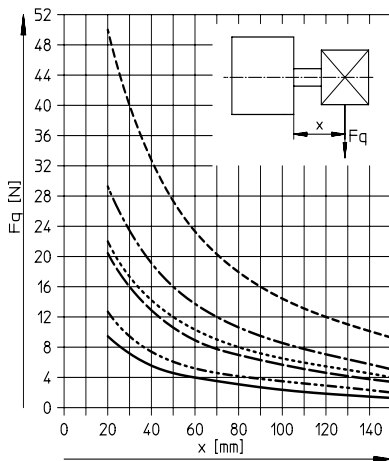

- ø 12
- · - · - · - ø 16
- - - - - ø 20
- · · · · ø 25
- · - · - · - ø 32/40
- - - - - ø 50/63

- - - - - ø 80/100
- · - · - · - ø 125

Data sheet

Max. lateral load F_q as a function of projection x and lever arm a

Q – Square piston rod

$\varnothing 12$

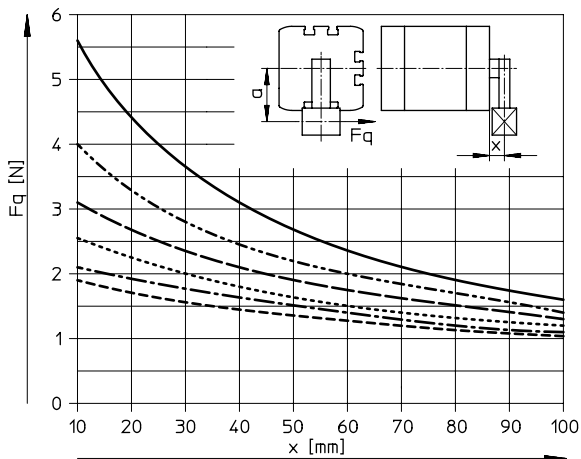

- a = 5 mm
- · - · a = 10 mm
- - - a = 15 mm
- · · · · a = 20 mm
- · - · a = 25 mm
- - - a = 30 mm

$\varnothing 16$

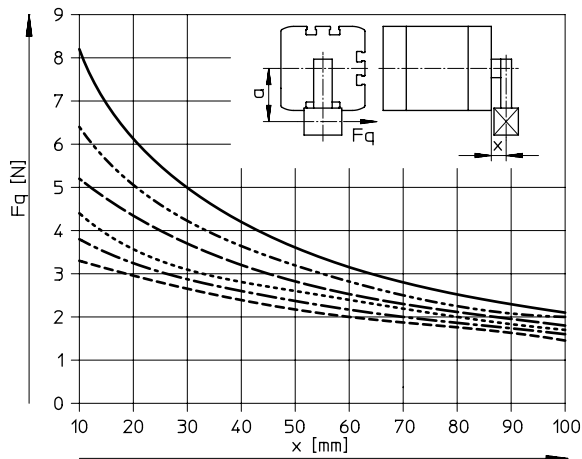

- a = 5 mm
- · - · a = 10 mm
- - - a = 15 mm
- · · · · a = 20 mm
- · - · a = 25 mm
- - - a = 30 mm

$\varnothing 20/25$

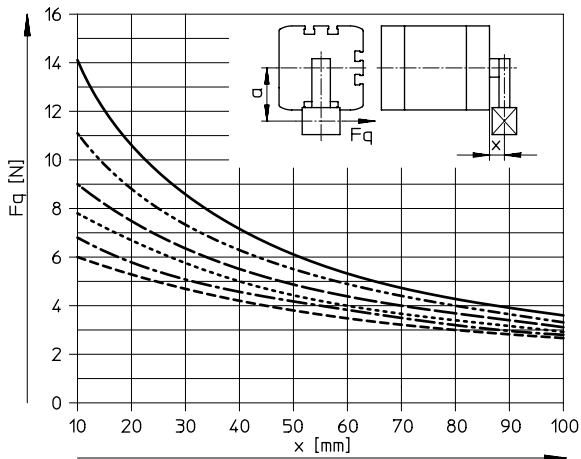

- a = 5 mm
- · - · a = 10 mm
- - - a = 15 mm
- · · · · a = 20 mm
- · - · a = 25 mm
- - - a = 30 mm

$\varnothing 32/40$

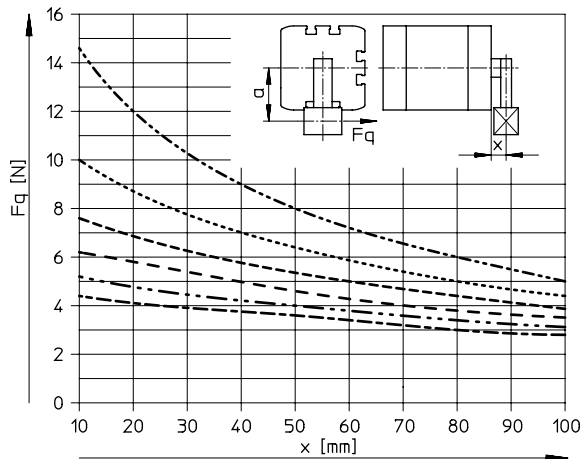

- · - · a = 10 mm
- · · · · a = 20 mm
- - - a = 30 mm
- - - a = 40 mm
- · - · a = 50 mm
- · - · a = 60 mm

Note

- Torques on the piston rod are to be excluded with projections greater than those shown in the graphs.

- If $a = 0$, the corresponding lateral load line of the basic version of the ADN can be used (→ page 15).

Data sheet

Max. lateral load F_q as a function of projection x and lever arm a

Q – Square piston rod

∅ 50/63

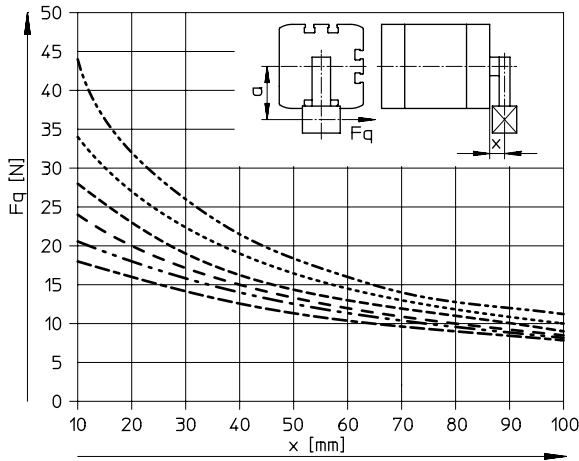

- a = 10 mm
- a = 20 mm
- a = 30 mm
- a = 40 mm
- a = 50 mm
- a = 60 mm

∅ 80/100

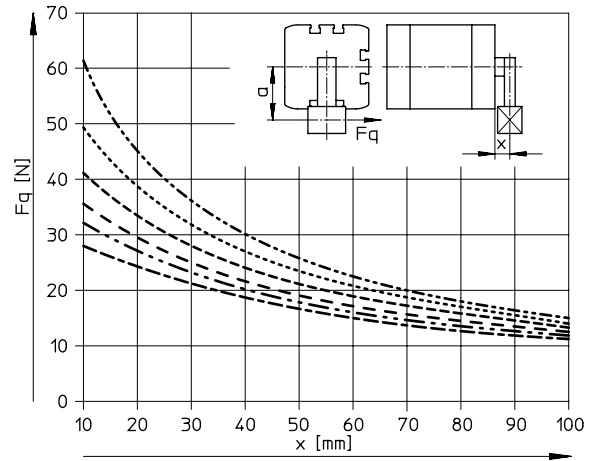

- a = 10 mm
- a = 20 mm
- a = 30 mm
- a = 40 mm
- a = 50 mm
- a = 60 mm

∅ 125

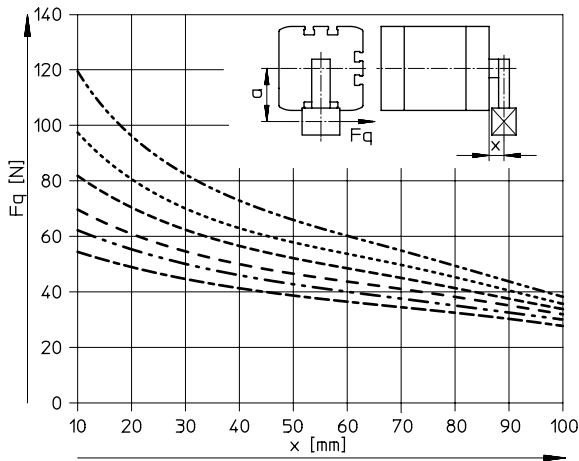

- a = 10 mm
- a = 20 mm
- a = 30 mm
- a = 40 mm
- a = 50 mm
- a = 60 mm

Note

- Torques on the piston rod are to be excluded with projections greater than those shown in the graphs.

- If $a = 0$, the corresponding lateral load line of the basic version of the ADN can be used (→ page 15).

Data sheet

Max. lateral load F_q as a function of projection x

S1 – Reinforced piston rod

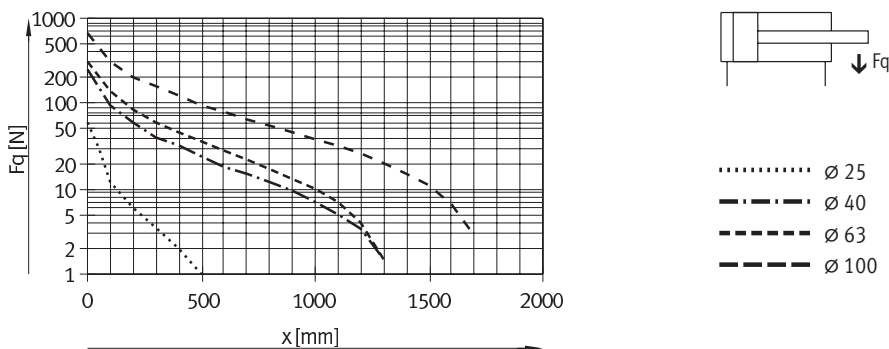

Weight [g]

Piston \varnothing	12	16	20	25	32	40	50	63	80	100	125
Product weight with 0 mm stroke	77	79	131	156	265	346	540	722	1121	2154	2880
Additional weight per 10 mm stroke	12	14	21	23	30	37	51	59	79	98	117
Moving mass with 0 mm stroke	9	15	30	50	60	80	140	180	400	570	1080
Additional mass per 10 mm stroke	2	4	6	6	9	9	16	16	25	25	39

Materials

Sectional view

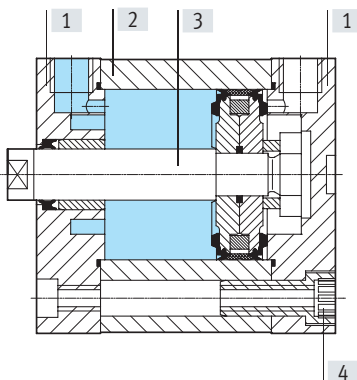

Compact cylinder	Basic version, Q	R8	S6, S10, S11	R3	K10	F1A
[1] Cover						
$\varnothing 12 \dots 63$	Anodised aluminium					
$\varnothing 80 \dots 125$	Coated die-cast aluminium					
[2] Cylinder barrel	Anodised aluminium					
[3] Piston rod	High-alloy steel	Hard-chrome-plated tempered steel	High-alloy steel		Anodised aluminium	High-alloy steel
[4] Flange screws						
$\varnothing 12 \dots 16$	High-alloy steel			High-alloy steel	-	Steel, nickel-plated
$\varnothing 20 \dots 63$	Galvanised steel			Tempered steel	Galvanised steel	
$\varnothing 80 \dots 125$	Standard screws, galvanised steel			Standard screws, high-alloy steel	Standard screws, galvanised steel	
- Seals	Polyurethane		Fluoro rubber	Polyurethane		Polyurethane
Note on materials						
ADN-...	RoHS-compliant					
	PWIS conformity: VDMA24364-B1/B2-L					
ADN-...-S10/11	Contains PWIS (paint-wetting impairment substances)					
	PWIS conformity: VDMA24364 zone III					
ADN-...-F1A	Metals with copper, zinc or nickel as the main constituent are excluded from use. Exceptions are nickel in steels, chemically nickel-plated surfaces, printed circuit boards, cables, electrical plug connectors and coils.					

Data sheet

Dimensions – Basic version

Download CAD data → www.festo.com

∅ 12 ... 63

∅ 80 ... 125

∅ 32 ... 63

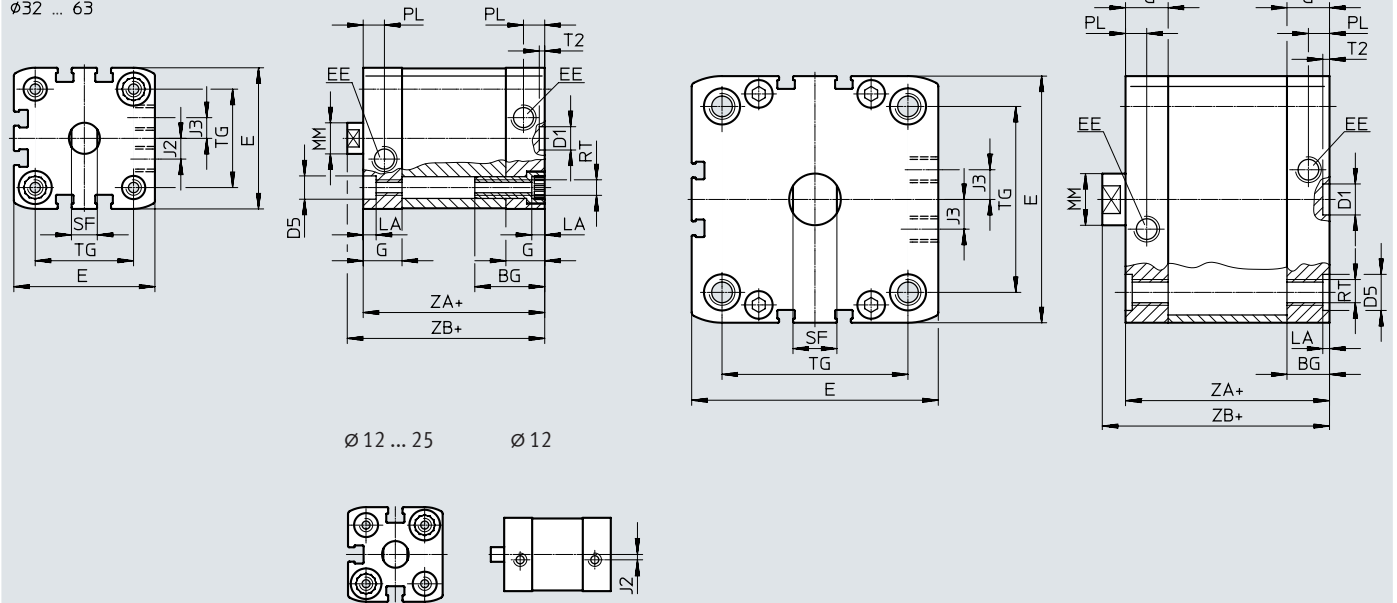

+ = plus stroke length
 [1] = Drilled hole for centring pin/sleeve

∅ [mm]	BG min.	D1 ∅ H9	D5 ∅	E	EE	G	J2	J3	LA +0.2
12	17	9	6 ^{F9}	27.5 ^{+0.3}	M5	10.5	2	-	3.5
16				29 ^{+0.3}		11			
20				35.5 ^{+0.3}		12	2.6		
25	39.5 ^{+0.3}		15	6	5				
32	47 ^{+0.3}					8			
40	54.5 ^{+0.3}		12	11.5					
50	65.5 ^{+0.3}	G1/8			20				
63	75.5 ^{+0.3}					15	11.5		
80	17	12	15	20	2.6				
100	21.5					15	21.5		
125	20							-	21.15

∅ [mm]	MM ∅	PL +0.2	RT	SF h13	T2 +0.1	TG ±0.2	ZA ±0.3	ZB +1.2	PPS +1.3		
12	6	6	M4	5	2.1	16	35	39.2	-		
16	8			7		18		39.7			
20	10			M5		9	22	42.5			
25			26				44.5	45.3			
32			32.5				44	50	50.6		
40	12		8.2	M6		10	2.6	38	45	51.1	51.7
50	16	M8			13			46.5		52.7	53.2
63								56.5	49	56.5	57
80			20	M10		17		72	54	62.9	63.4
100	10.5	M12			21			89	67	76	76.8
125								110	81	92	-

Data sheet

Dimensions – Variants

Download CAD data → www.festo.com

Basic version

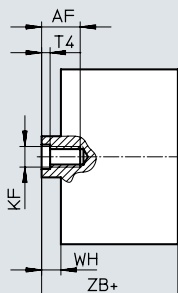
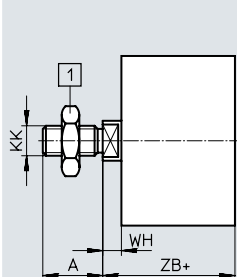

[1] Hex nut DIN 439-B
only with $\varnothing 32 \dots 125$

+ = plus stroke length

S2 – Through piston rod

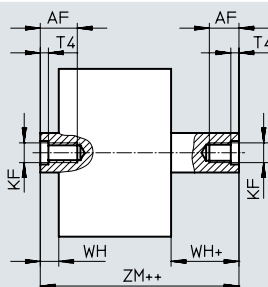
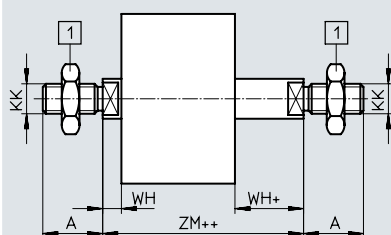

[1] Hex nut DIN 439-B
only with $\varnothing 32 \dots 125$

+ = plus stroke length

++ = plus 2x stroke length

S20 – Through, hollow piston rod

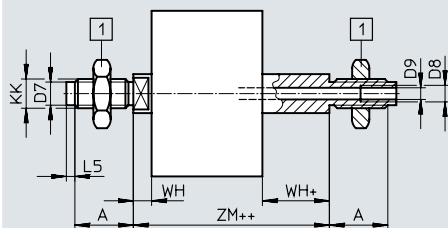

[1] Hex nut DIN 439-B
only with $\varnothing 32 \dots 125$

+ = plus stroke length

++ = plus 2x stroke length

K2 – Extended male piston rod thread

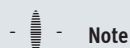
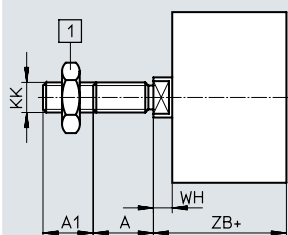

Note

In combination with variants S2/
S20, the piston rod thread is ex-
tended at both ends

[1] Hex nut DIN 439-B
only with $\varnothing 32 \dots 125$

+ = plus stroke length

K5 – Special piston rod thread

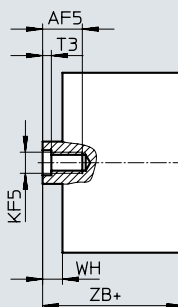
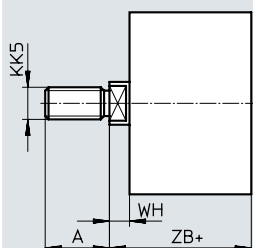

Data sheet

Dimensions – Variants

Download CAD data → www.festo.com

K8 – Extended piston rod

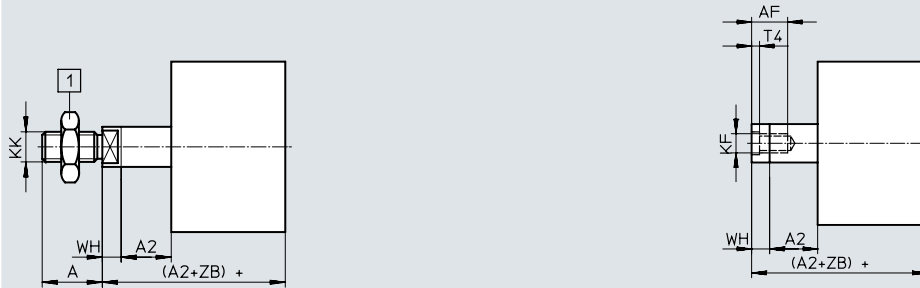

Note
 In combination with variants S2/S20, the piston rod thread is extended at one end
 [1] Hex nut DIN 439-B only with $\varnothing 32 \dots 125$
 + = plus stroke length

R8 – Dust protection / TT – Low temperature

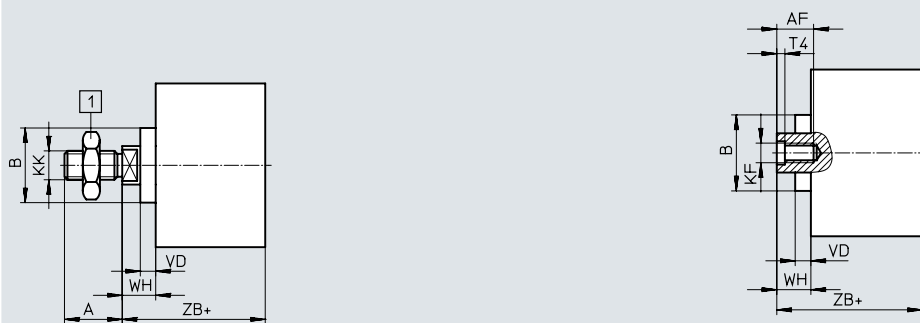

[1] Hex nut DIN 439-B only with $\varnothing 32 \dots 125$
 + = plus stroke length

\varnothing [mm]	A	A1	A2	AF	AF5	B \varnothing	D7 \varnothing	D8	D9 \varnothing	L5	KF	KF5	KK
12	-0.5	1 ... 10	1 ... 300	8	-	-	-	-	-	-	M3	-	M5
16	12	10		-	-	4.5	3.2		3	M4	-	M6	
20	16	1 ... 20	1 ... 400	14	12	18	6	-	3.8	2	M6	M5	M8
32	19			16	14	27	8		4.5	3	M8	M6	M10x1.25
40	22		20	16	31	10	6		3.5	M10	M8	M12x1.25	
50	28		1 ... 30	1 ... 500	20	20	35		-	-	8	-	M12
63	40	1 ... 40	25		-	-	G1/8	8	M16		-	M20x1.5	
80							G1/4	11.7					

\varnothing [mm]	KK5	T3	T4	VD	WH			ZB			ZM	
					+1.3	PPS +1.4	R8/TT +1.3	+1.2	PPS +1.3	R8/TT +1.2		PPS
12	M6	-	1.5	-	4.2	-	-	39.2	-	-	44.5 ^{+0.5}	-
16	M8	-	1.5	-	4.7	-	-	39.7	-	-	45.7 ^{+0.5}	-
20	M10x1.25	2	2.6	5.2	5.5	5.5	10.5	42.5	42.5	47.5	49.5 ^{+0.5}	49.5 ^{+0.5}
25	M10							44.5	45.3	49.5	51.5 ^{+0.5}	51.5 ^{+0.5}
32	M10	2.6	3.3	6.4	6	6.5	12.5	50	50.6	56.5	57.5 ^{+0.5}	58.6 ^{+0.6}
40	M12							51.1	51.7	57.5	58.6 ^{+0.6}	59.7 ^{+0.7}
50	M12							52.7	53.2	59.7	62.0 ^{+0.6}	63.1 ^{+0.7}
63	M16	3.3	4.7	6.4	7.5	8	14.6	56.5	57	63.6	65.4 ^{+0.6}	66.5 ^{+0.7}
80	M16							62.9	63.4	69.4	73.2 ^{+0.6}	74.3 ^{+0.7}
100	M20x1.5	4.7	6.1	6.4	9	9.8	15.5	76	76.8	82.5	86.4 ^{+0.6}	88 ^{+0.7}
125	M20							92	-	-	104.4 ^{+0.6}	-

Data sheet

Dimensions – Variants

Download CAD data → www.festo.com

Q – Square piston rod

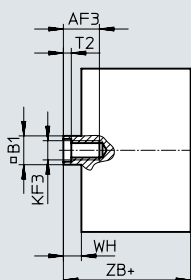
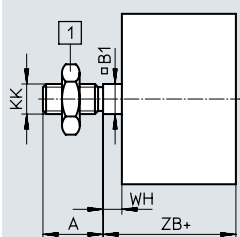

[1] Hex nut DIN 439-B
only with $\varnothing 32 \dots 125$

+ = plus stroke length

Q-S2 – Square, through piston rod

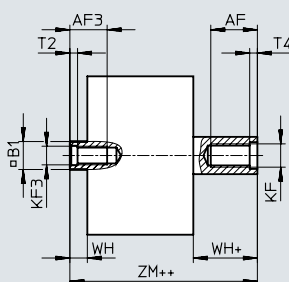
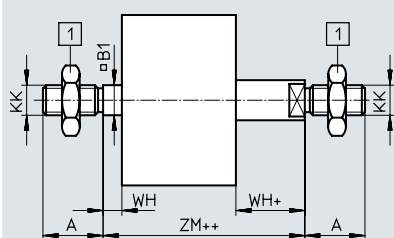

[1] Hex nut DIN 439-B
only with $\varnothing 32 \dots 125$

+ = plus stroke length

++ = plus 2x stroke length

Q-S20 – Square, through, hollow piston rod

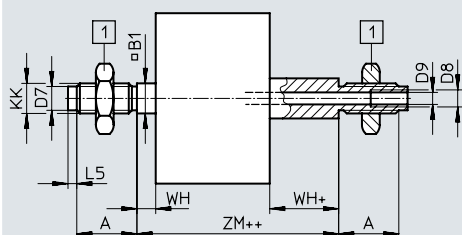

[1] Hex nut DIN 439-B
only with $\varnothing 32 \dots 125$

+ = plus stroke length

++ = plus 2x stroke length

Q-K2 – Square piston rod with extended male thread

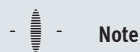
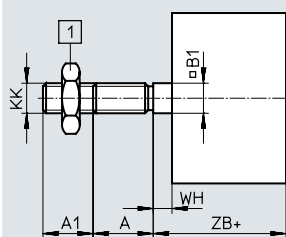

Note

In combination with variants S2/S20, the piston rod thread is extended at both ends.

[1] Hex nut DIN 439-B
only with $\varnothing 32 \dots 125$

+ = plus stroke length

Q-K5 – Square piston rod with special thread

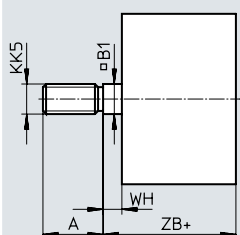

+ = plus stroke length

Data sheet

Dimensions – Variants

Download CAD data → www.festo.com

Q-K8 – Square, extended piston rod

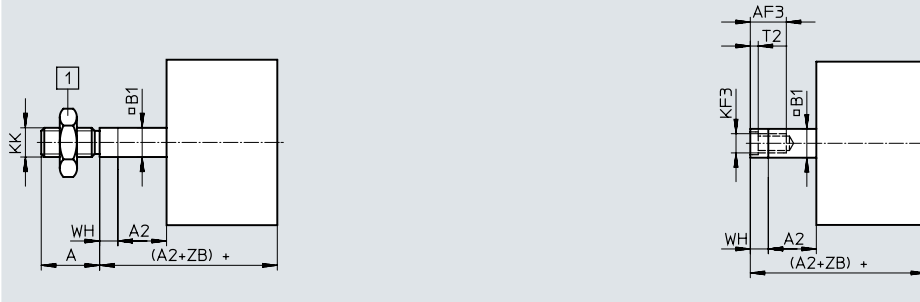

Note
 In combination with variants S2/S20, the piston rod thread is extended at both ends.
 [1] Hex nut DIN 439-B only with $\varnothing 32 \dots 125$
 + = plus stroke length

\varnothing [mm]	A	A1	A2	AF min.	AF3 min.	B1 □	D7 \varnothing	D8	D9 \varnothing
	-0.5								
12	10	1 ... 10	1 ... 300	8	8	5.5	-	-	-
16	12			10	10	7	4.5		3.2
20	16			14	12	9	6		3.8
25		1 ... 20	1 ... 400	16	14	10	8	4.5	
32	20			16	12	10	6		
40	22			20	16	12	10	6	
50	28	1 ... 30	1 ... 500	20	20	16	-	G1/8	8
63				25	24	20			
80	40	1 ... 40							
100									
125									

\varnothing [mm]	L5	KF	KF3	KK	KK5	T2	WH +1.3	ZB +1.2	ZM
12	-	M3	M3	M5	M6	1.5	4.2	39.2	44.5 ^{+0.5}
16	3	M4	M4	M6	M8		4.7	39.7	45.7 ^{+0.5}
20	2	M6	M5	M8	M10x1.25 M10	2	5.5	42.5	49.5 ^{+0.5}
25							44.5	51.5 ^{+0.5}	
32	3	M8	M6	M10x1.25	M10	2.6	6	50	57.5 ^{+0.5}
40							6.1	51.1	58.6 ^{+0.6}
50							8.2	53.2	62.8 ^{+0.6}
63	3.5	M10	M8	M12x1.25	M12	3.3	8.1	57.1	66.6 ^{+0.6}
80							8.9	62.9	73.2 ^{+0.6}
100	-	M12	M10	M16x1.5	M16	4.7	9	76	86.4 ^{+0.6}
125							M16	M12	M20x1.5

Data sheet

Dimensions – Variants

Download CAD data → www.festo.com

S1 – Reinforced piston rod

∅ 25

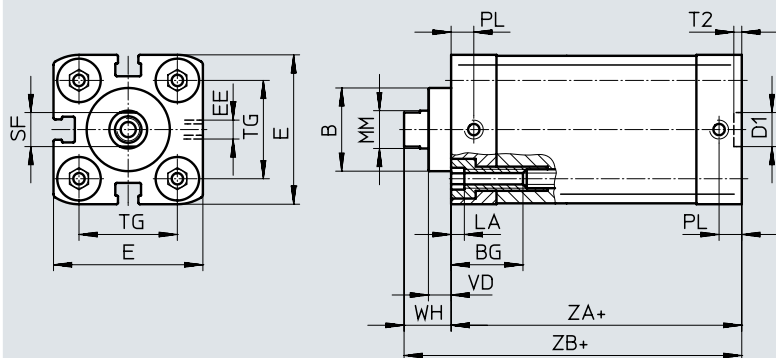

+ = plus stroke length

∅ 40 ... 100

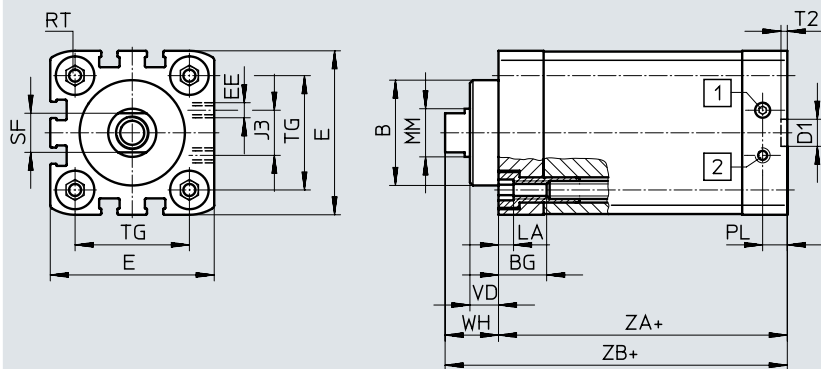

- [1] Cylinder advancing
- [2] Cylinder retracting

+ = plus stroke length

∅ [mm]	B ∅ f8	BG min.	D1 ∅ H9	E	EE	J3	LA	MM ∅	PL
25	22	15	9	39.5 ^{+0.3}	M5	-	5	10	6
40	35	16		54.5 ^{+0.3}		15		8.2	
63	42		75.5 ^{+0.3}	23					
100	55	17	12	113.5 ^{+0.6}	G1/8	40	25	10.5	

∅ [mm]	RT	SF h13	T2	TG	VD	WH	ZA	ZB
			+0.1	±0.2		+1.3	±0.3	+1.2
25	M5	9	2.1	26	6	11.8	39	50.9
40	M6	13		38	9.5	18	45	62.9
63	M8	17	2.6	56.5	12	21	49	70.2
100	M10	21		89	15.5	26.5	67	93.5

Data sheet

Dimensions – Variants

Download CAD data → www.festo.com

S1 – Reinforced piston rod

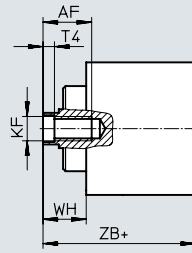
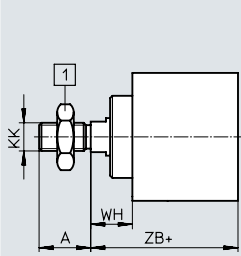

[1] Hex nut DIN 439-B
only with \varnothing 40 ... 100

+ = plus stroke length

S1-K2 – Reinforced piston rod with extended male piston rod thread

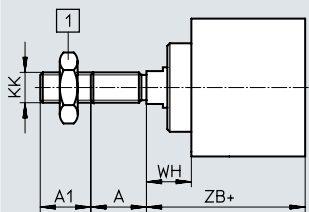

[1] Hex nut DIN 439-B
only with \varnothing 40 ... 100

+ = plus stroke length

S1-K5 – Reinforced piston rod with special piston rod thread

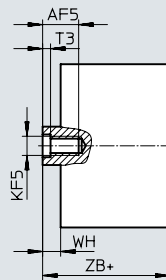
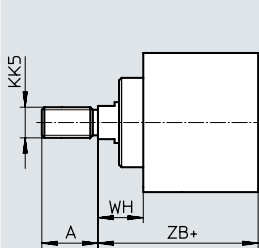

[1] Hex nut DIN 439-B
only with \varnothing 40 ... 100

+ = plus stroke length

S1-K8 – Reinforced piston rod with extended piston rod thread

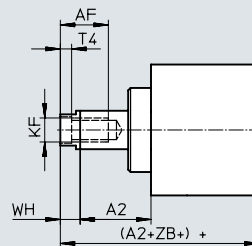
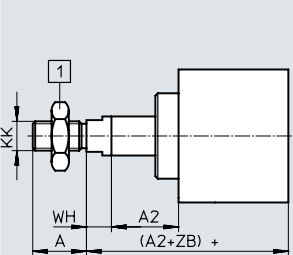

[1] Hex nut DIN 439-B
only with \varnothing 40 ... 100

+ = plus stroke length

\varnothing [mm]	A	A1	A2	AF	AF5	KF	KF5	KK	KK5	T3	T4	WH	ZB
25	16	1 ... 20	1 ... 300	14	12	M6	M5	M8	M10x1.25 M10	2	2.6	11.8	50.9
40	22		1 ... 400	20	16	M10	M8	M12x1.25	M10x1.25 M12	3.3	4.7	18	62.9
63	28		1 ... 500		20	M12	M10	M16x1.5	M12x1.25 M16	4.7	6.1	21	70.2
100	40	1 ... 30	1 ... 500	25	–	M16	–	M20x1.5	M16x1.5 M20	–	7	26.5	93.5

Data sheet

★ Core product range

Ordering data		Stroke [mm]	I – Piston rod with female thread P – Elastic cushioning rings/plates at both ends		A – Piston rod with male thread P – Elastic cushioning rings/plates at both ends	
Type	Piston ø [mm]		Part no.	Type	Part no.	Type
	12	5	★ 536211	ADN-12-5-I-P-A	★ 536204	ADN-12-5-A-P-A
		10	★ 536212	ADN-12-10-I-P-A	★ 536205	ADN-12-10-A-P-A
		15	★ 536213	ADN-12-15-I-P-A	★ 536206	ADN-12-15-A-P-A
		20	★ 536214	ADN-12-20-I-P-A	★ 536207	ADN-12-20-A-P-A
		25	★ 536215	ADN-12-25-I-P-A	★ 536208	ADN-12-25-A-P-A
		30	★ 536216	ADN-12-30-I-P-A	★ 536209	ADN-12-30-A-P-A
		40	★ 536217	ADN-12-40-I-P-A	★ 536210	ADN-12-40-A-P-A
		16	5	★ 536226	ADN-16-5-I-P-A	★ 536219
	10		★ 536227	ADN-16-10-I-P-A	★ 536220	ADN-16-10-A-P-A
	15		★ 536228	ADN-16-15-I-P-A	★ 536221	ADN-16-15-A-P-A
	20		★ 536229	ADN-16-20-I-P-A	★ 536222	ADN-16-20-A-P-A
	25		★ 536230	ADN-16-25-I-P-A	★ 536223	ADN-16-25-A-P-A
	30		★ 536231	ADN-16-30-I-P-A	★ 536224	ADN-16-30-A-P-A
	40		★ 536232	ADN-16-40-I-P-A	★ 536225	ADN-16-40-A-P-A
	50		★ 536341	ADN-16-50-I-P-A	★ 536331	ADN-16-50-A-P-A
	20	5	★ 536242	ADN-20-5-I-P-A	★ 536234	ADN-20-5-A-P-A
		10	★ 536243	ADN-20-10-I-P-A	★ 536235	ADN-20-10-A-P-A
		15	★ 536244	ADN-20-15-I-P-A	★ 536236	ADN-20-15-A-P-A
		20	★ 536245	ADN-20-20-I-P-A	★ 536237	ADN-20-20-A-P-A
		25	★ 536246	ADN-20-25-I-P-A	★ 536238	ADN-20-25-A-P-A
		30	★ 536247	ADN-20-30-I-P-A	★ 536239	ADN-20-30-A-P-A
		40	★ 536248	ADN-20-40-I-P-A	★ 536240	ADN-20-40-A-P-A
		50	★ 536249	ADN-20-50-I-P-A	★ 536241	ADN-20-50-A-P-A
		60	★ 536362	ADN-20-60-I-P-A	★ 536352	ADN-20-60-A-P-A
		25	5	★ 536259	ADN-25-5-I-P-A	★ 536251
	10		★ 536260	ADN-25-10-I-P-A	★ 536252	ADN-25-10-A-P-A
	15		★ 536261	ADN-25-15-I-P-A	★ 536253	ADN-25-15-A-P-A
	20		★ 536262	ADN-25-20-I-P-A	★ 536254	ADN-25-20-A-P-A
25	★ 536263		ADN-25-25-I-P-A	★ 536255	ADN-25-25-A-P-A	
30	★ 536264		ADN-25-30-I-P-A	★ 536256	ADN-25-30-A-P-A	
40	★ 536265		ADN-25-40-I-P-A	★ 536257	ADN-25-40-A-P-A	
60	★ 536266		ADN-25-50-I-P-A	★ 536258	ADN-25-50-A-P-A	
32	5	★ 536278	ADN-32-5-I-P-A	★ 536268	ADN-32-5-A-P-A	
	10	★ 536279	ADN-32-10-I-P-A	★ 536269	ADN-32-10-A-P-A	
	15	★ 536280	ADN-32-15-I-P-A	★ 536270	ADN-32-15-A-P-A	
	20	★ 536281	ADN-32-20-I-P-A	★ 536271	ADN-32-20-A-P-A	
	25	★ 536282	ADN-32-25-I-P-A	★ 536272	ADN-32-25-A-P-A	
	30	★ 536283	ADN-32-30-I-P-A	★ 536273	ADN-32-30-A-P-A	
	40	★ 536284	ADN-32-40-I-P-A	★ 536274	ADN-32-40-A-P-A	
	50	★ 536285	ADN-32-50-I-P-A	★ 536275	ADN-32-50-A-P-A	
	60	★ 536286	ADN-32-60-I-P-A	★ 536276	ADN-32-60-A-P-A	
	80	★ 536287	ADN-32-80-I-P-A	★ 536277	ADN-32-80-A-P-A	

Data sheet

★ Core product range

Ordering data		Stroke [mm]	I – Piston rod with female thread P – Elastic cushioning rings/plates at both ends		A – Piston rod with male thread P – Elastic cushioning rings/plates at both ends	
Type	Piston ø [mm]		Part no.	Type	Part no.	Type
	40	5	★ 536299	ADN-40-5-I-P-A	★ 536289	ADN-40-5-A-P-A
		10	★ 536300	ADN-40-10-I-P-A	★ 536290	ADN-40-10-A-P-A
		15	★ 536301	ADN-40-15-I-P-A	★ 536291	ADN-40-15-A-P-A
		20	★ 536302	ADN-40-20-I-P-A	★ 536292	ADN-40-20-A-P-A
		25	★ 536303	ADN-40-25-I-P-A	★ 536293	ADN-40-25-A-P-A
		30	★ 536304	ADN-40-30-I-P-A	★ 536294	ADN-40-30-A-P-A
		40	★ 536305	ADN-40-40-I-P-A	★ 536295	ADN-40-40-A-P-A
		50	★ 536306	ADN-40-50-I-P-A	★ 536296	ADN-40-50-A-P-A
		60	★ 536307	ADN-40-60-I-P-A	★ 536297	ADN-40-60-A-P-A
		80	★ 536308	ADN-40-80-I-P-A	★ 536298	ADN-40-80-A-P-A
	50	5	★ 536320	ADN-50-5-I-P-A	★ 536310	ADN-50-5-A-P-A
		10	★ 536321	ADN-50-10-I-P-A	★ 536311	ADN-50-10-A-P-A
		15	★ 536322	ADN-50-15-I-P-A	★ 536312	ADN-50-15-A-P-A
		20	★ 536323	ADN-50-20-I-P-A	★ 536313	ADN-50-20-A-P-A
		25	★ 536324	ADN-50-25-I-P-A	★ 536314	ADN-50-25-A-P-A
		30	★ 536325	ADN-50-30-I-P-A	★ 536315	ADN-50-30-A-P-A
		40	★ 536326	ADN-50-40-I-P-A	★ 536316	ADN-50-40-A-P-A
		50	★ 536327	ADN-50-50-I-P-A	★ 536317	ADN-50-50-A-P-A
		60	★ 536328	ADN-50-60-I-P-A	★ 536318	ADN-50-60-A-P-A
		80	★ 536329	ADN-50-80-I-P-A	★ 536319	ADN-50-80-A-P-A
	63	10	★ 536342	ADN-63-10-I-P-A	★ 536332	ADN-63-10-A-P-A
		15	★ 536343	ADN-63-15-I-P-A	★ 536333	ADN-63-15-A-P-A
		20	★ 536344	ADN-63-20-I-P-A	★ 536334	ADN-63-20-A-P-A
		25	★ 536345	ADN-63-25-I-P-A	★ 536335	ADN-63-25-A-P-A
		30	★ 536346	ADN-63-30-I-P-A	★ 536336	ADN-63-30-A-P-A
		40	★ 536347	ADN-63-40-I-P-A	★ 536337	ADN-63-40-A-P-A
		50	★ 536348	ADN-63-50-I-P-A	★ 536338	ADN-63-50-A-P-A
		80	★ 536349	ADN-63-60-I-P-A	★ 536339	ADN-63-60-A-P-A
	80	10	★ 536363	ADN-80-10-I-P-A	★ 536353	ADN-80-10-A-P-A
		15	★ 536364	ADN-80-15-I-P-A	★ 536354	ADN-80-15-A-P-A
		20	★ 536365	ADN-80-20-I-P-A	★ 536355	ADN-80-20-A-P-A
		25	★ 536366	ADN-80-25-I-P-A	★ 536356	ADN-80-25-A-P-A
		30	★ 536367	ADN-80-30-I-P-A	★ 536357	ADN-80-30-A-P-A
40		★ 536368	ADN-80-40-I-P-A	★ 536358	ADN-80-40-A-P-A	
50		★ 536369	ADN-80-50-I-P-A	★ 536359	ADN-80-50-A-P-A	
60		★ 536370	ADN-80-60-I-P-A	★ 536360	ADN-80-60-A-P-A	
80		★ 536371	ADN-80-80-I-P-A	★ 536361	ADN-80-80-A-P-A	

Data sheet

★ Core product range

Ordering data						
Type	Piston ø	Stroke	I – Piston rod with female thread PPS – Pneumatic cushioning, self-adjusting at both ends	A – Piston rod with male thread PPS – Pneumatic cushioning, self-adjusting at both ends		
	[mm]	[mm]	Part no.	Type	Part no.	
	32	10	★ 572646	ADN-32-10-I-PPS-A	★ 572655	ADN-32-10-A-PPS-A
		15	★ 572647	ADN-32-15-I-PPS-A	★ 572656	ADN-32-15-A-PPS-A
		20	★ 572648	ADN-32-20-I-PPS-A	★ 572657	ADN-32-20-A-PPS-A
		25	★ 572649	ADN-32-25-I-PPS-A	★ 572658	ADN-32-25-A-PPS-A
		30	★ 572650	ADN-32-30-I-PPS-A	★ 572659	ADN-32-30-A-PPS-A
		40	★ 572651	ADN-32-40-I-PPS-A	★ 572660	ADN-32-40-A-PPS-A
		50	★ 572652	ADN-32-50-I-PPS-A	★ 572661	ADN-32-50-A-PPS-A
		60	★ 572653	ADN-32-60-I-PPS-A	★ 572662	ADN-32-60-A-PPS-A
	80	★ 572654	ADN-32-80-I-PPS-A	★ 572663	ADN-32-80-A-PPS-A	
	40	10	★ 572664	ADN-40-10-I-PPS-A	★ 572673	ADN-40-10-A-PPS-A
		15	★ 572665	ADN-40-15-I-PPS-A	★ 572674	ADN-40-15-A-PPS-A
		20	★ 572666	ADN-40-20-I-PPS-A	★ 572675	ADN-40-20-A-PPS-A
		25	★ 572667	ADN-40-25-I-PPS-A	★ 572676	ADN-40-25-A-PPS-A
		30	★ 572668	ADN-40-30-I-PPS-A	★ 572677	ADN-40-30-A-PPS-A
		40	★ 572669	ADN-40-40-I-PPS-A	★ 572678	ADN-40-40-A-PPS-A
		50	★ 572670	ADN-40-50-I-PPS-A	★ 572679	ADN-40-50-A-PPS-A
		60	★ 572671	ADN-40-60-I-PPS-A	★ 572680	ADN-40-60-A-PPS-A
	80	★ 572672	ADN-40-80-I-PPS-A	★ 572681	ADN-40-80-A-PPS-A	
	50	10	★ 572682	ADN-50-10-I-PPS-A	★ 572691	ADN-50-10-A-PPS-A
		15	★ 572683	ADN-50-15-I-PPS-A	★ 572692	ADN-50-15-A-PPS-A
		20	★ 572684	ADN-50-20-I-PPS-A	★ 572693	ADN-50-20-A-PPS-A
		25	★ 572685	ADN-50-25-I-PPS-A	★ 572694	ADN-50-25-A-PPS-A
		30	★ 572686	ADN-50-30-I-PPS-A	★ 572695	ADN-50-30-A-PPS-A
		40	★ 572687	ADN-50-40-I-PPS-A	★ 572696	ADN-50-40-A-PPS-A
		50	★ 572688	ADN-50-50-I-PPS-A	★ 572697	ADN-50-50-A-PPS-A
		60	★ 572689	ADN-50-60-I-PPS-A	★ 572698	ADN-50-60-A-PPS-A
	80	★ 572690	ADN-50-80-I-PPS-A	★ 572699	ADN-50-80-A-PPS-A	
	63	10	★ 572700	ADN-63-10-I-PPS-A	★ 572709	ADN-63-10-A-PPS-A
15		★ 572701	ADN-63-15-I-PPS-A	★ 572710	ADN-63-15-A-PPS-A	
20		★ 572702	ADN-63-20-I-PPS-A	★ 572711	ADN-63-20-A-PPS-A	
25		★ 572703	ADN-63-25-I-PPS-A	★ 572712	ADN-63-25-A-PPS-A	
30		★ 572704	ADN-63-30-I-PPS-A	★ 572713	ADN-63-30-A-PPS-A	
40		★ 572705	ADN-63-40-I-PPS-A	★ 572714	ADN-63-40-A-PPS-A	
50		★ 572706	ADN-63-50-I-PPS-A	★ 572715	ADN-63-50-A-PPS-A	
60		★ 572707	ADN-63-60-I-PPS-A	★ 572716	ADN-63-60-A-PPS-A	
80	★ 572708	ADN-63-80-I-PPS-A	★ 572717	ADN-63-80-A-PPS-A		
80	10	★ 572718	ADN-80-10-I-PPS-A	★ 572727	ADN-80-10-A-PPS-A	
	15	★ 572719	ADN-80-15-I-PPS-A	★ 572728	ADN-80-15-A-PPS-A	
	20	★ 572720	ADN-80-20-I-PPS-A	★ 572729	ADN-80-20-A-PPS-A	
	25	★ 572721	ADN-80-25-I-PPS-A	★ 572730	ADN-80-25-A-PPS-A	
	30	★ 572722	ADN-80-30-I-PPS-A	★ 572731	ADN-80-30-A-PPS-A	
	40	★ 572723	ADN-80-40-I-PPS-A	★ 572732	ADN-80-40-A-PPS-A	
	50	★ 572724	ADN-80-50-I-PPS-A	★ 572733	ADN-80-50-A-PPS-A	
	60	★ 572725	ADN-80-60-I-PPS-A	★ 572734	ADN-80-60-A-PPS-A	
80	★ 572726	ADN-80-80-I-PPS-A	★ 572735	ADN-80-80-A-PPS-A		

Data sheet

Ordering data Type	Piston ø [mm]	Stroke [mm]	I – Piston rod with female thread		A – Piston rod with male thread	
			P – Elastic cushioning rings/plates at both ends		P – Elastic cushioning rings/plates at both ends	
			Part no.	Type	Part no.	Type
	100	10	536384	ADN-100-10-I-P-A	536374	ADN-100-10-A-P-A
		15	536385	ADN-100-15-I-P-A	536375	ADN-100-15-A-P-A
		20	536386	ADN-100-20-I-P-A	536376	ADN-100-20-A-P-A
		25	536387	ADN-100-25-I-P-A	536377	ADN-100-25-A-P-A
		30	536388	ADN-100-30-I-P-A	536378	ADN-100-30-A-P-A
		40	536389	ADN-100-40-I-P-A	536379	ADN-100-40-A-P-A
		50	536390	ADN-100-50-I-P-A	536380	ADN-100-50-A-P-A
		60	536391	ADN-100-60-I-P-A	536381	ADN-100-60-A-P-A
		80	536392	ADN-100-80-I-P-A	536382	ADN-100-80-A-P-A

Ordering data Type	Piston ø [mm]	Stroke [mm]	I – Piston rod with female thread		A – Piston rod with male thread	
			PPS – Pneumatic cushioning, self-adjusting at both ends		PPS – Pneumatic cushioning, self-adjusting at both ends	
			Part no.	Type	Part no.	Type
	20	10	577158	ADN-20-10-I-PPS-A	577166	ADN-20-10-A-PPS-A
		15	577159	ADN-20-15-I-PPS-A	577167	ADN-20-15-A-PPS-A
		20	577160	ADN-20-20-I-PPS-A	577168	ADN-20-20-A-PPS-A
		25	577161	ADN-20-25-I-PPS-A	577169	ADN-20-25-A-PPS-A
		30	577162	ADN-20-30-I-PPS-A	577170	ADN-20-30-A-PPS-A
		40	577163	ADN-20-40-I-PPS-A	577171	ADN-20-40-A-PPS-A
		50	577164	ADN-20-50-I-PPS-A	577172	ADN-20-50-A-PPS-A
		60	577165	ADN-20-60-I-PPS-A	577173	ADN-20-60-A-PPS-A
	25	10	577174	ADN-25-10-I-PPS-A	577182	ADN-25-10-A-PPS-A
		15	577175	ADN-25-15-I-PPS-A	577183	ADN-25-15-A-PPS-A
		20	577176	ADN-25-20-I-PPS-A	577184	ADN-25-20-A-PPS-A
		25	577177	ADN-25-25-I-PPS-A	577185	ADN-25-25-A-PPS-A
		30	577178	ADN-25-30-I-PPS-A	577186	ADN-25-30-A-PPS-A
		40	577179	ADN-25-40-I-PPS-A	577187	ADN-25-40-A-PPS-A
		50	577180	ADN-25-50-I-PPS-A	577188	ADN-25-50-A-PPS-A
		60	577181	ADN-25-60-I-PPS-A	577189	ADN-25-60-A-PPS-A
	100	15	577191	ADN-100-15-I-PPS-A	577200	ADN-100-15-A-PPS-A
		20	577192	ADN-100-20-I-PPS-A	577201	ADN-100-20-A-PPS-A
		25	577193	ADN-100-25-I-PPS-A	577202	ADN-100-25-A-PPS-A
		30	577194	ADN-100-30-I-PPS-A	577203	ADN-100-30-A-PPS-A
		40	577195	ADN-100-40-I-PPS-A	577204	ADN-100-40-A-PPS-A
		50	577196	ADN-100-50-I-PPS-A	577205	ADN-100-50-A-PPS-A
		60	577197	ADN-100-60-I-PPS-A	577206	ADN-100-60-A-PPS-A
		80	577198	ADN-100-80-I-PPS-A	577207	ADN-100-80-A-PPS-A

Ordering data – Modular product system, basic sensor and variants

Ordering table										
Size	12	16	20	25	32	40	Conditions	Code	Enter code	
Module no.	536203	536218	536233	536250	536267	536288				
Function	Compact cylinder, double-acting, based on ISO 21287								ADN	ADN
Piston ø [mm]	12	16	20	25	32	40		★ -...		
Stroke [mm]	1 ... 300				1 ... 400			★ -...		
Piston rod thread	Male thread								★ -A	
	Female thread							[1]	★ -I	
Cushioning	Elastic cushioning rings/plates at both ends								★ -P	
	-		Pneumatic cushioning, self-adjusting at both ends					[8]	★ -PPS	
Position sensing	Via proximity sensor								★ -A	-A

[1] **I** Not with piston rod type S20.
Not with extended male thread K2

[8] **PPS** Not with improved running performance K10, temperature resistance S6, low temperature TT, wiper seal R8
Minimum stroke 5 mm

Ordering data – Modular product system, basic sensor and variants

Ordering table		12	16	20	25	32	40	Conditions	Code	Enter code
Piston rod type		Through piston rod						[2]	★ -S2	
		Through, hollow piston rod						[2]	-S20	
	[mm]	1 ... 300			1 ... 400					
Extended male thread		Extended male piston rod thread								
	[mm]	1 ... 10			1 ... 20				-...K2	
Special piston rod thread	Male thread	M6	M8	M10x1.25 M10	M10x1.25 M10	M10 M12	M10 M12		-“...”K5	
	Female thread	-	-	M5	M5	M6	M6			
Extended piston rod	[mm]	1 ... 300			1 ... 400			[3]	★ -...K8	
Improved running performance		-	-	Smooth anodised aluminium piston rod				[4]	-K10	
Temperature resistance		Heat-resistant seals max. 120°C							★ -S6	
Corrosion protection		High corrosion protection						[5]	★ -R3	
Captive rating plate		Laser-etched rating plate							-TL	
Low temperature	[°C]	-	-	-40 ... +80			[6] [7]	-TT		
Wiper seal		-	-	Dust protection			[6]	-R8		
Special material properties		None								
		Recommended for production facilities for the manufacture of lithium-ion batteries						[9]	-F1A	

- [2] **S2, S20** Not with improved running performance K10.
Not with corrosion protection R3.
Not with wiper seal R8
- [3] **K8** The sum of the stroke length and piston rod extension must not exceed the maximum permissible stroke length
- [4] **K10** Not with extended male thread K2.
Not with special piston rod thread K5.
Not with corrosion protection R3
- [5] **R3** Not with captive rating plate TL
Not with wiper seal R8
- [6] **TT, R8** Not with improved running performance K10.
Not with temperature resistance S6
- [7] **TT** Not with wiper seal R8
- [9] **F1A** Not with S6, S20, K10, R3, TL, TT, R8, PPS

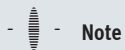
**Note**

NSF-H1 lubricants are used in combination with R3 and in combination with R3 and K2, K5 or K8.

Ordering data – Modular product system, basic sensor and variants

Ordering table									
Size	50	63	80	100	125	Conditions	Code	Enter code	
Module no.	536309	536330	536351	536372	536393				
Function	Compact cylinder, double-acting, based on ISO 21287							ADN	ADN
Piston ø [mm]	50	63	80	–	–		★ -...		
	–	–	–	100	125		-...		
Stroke [mm]	1 ... 400		1 ... 500				★ -...		
Piston rod thread	Male thread							★ -A	
	Female thread						[1]	★ -I	
Cushioning	Elastic cushioning rings/plates at both ends							★ -P	
	Pneumatic cushioning, self-adjusting at both ends				–	[8]	★ -PPS		
Position sensing	Via proximity sensor							★ -A	-A

[1] **I** Not with piston rod type S20.
Not with extended male thread K2

[8] **PPS** Not with improved running performance K10, temperature resistance S6, low temperature TT, wiper seal R8
Minimum stroke 5 mm

Ordering data – Modular product system, basic sensor and variants

Ordering table		50	63	80	100	125	Conditions	Code	Enter code
Piston rod type		Through piston rod					[2]	★ -S2	
	[mm]	Through, hollow piston rod					[2]	-S20	
Extended male thread	[mm]	1 ... 400		1 ... 500				-...K2	
Special piston rod thread	Male thread	M12	M12	M16	M16	M20		-"..."K5	
	Female thread	M16	M16	M20	M20	M20x1.5			
Extended piston rod		Extended piston rod							
	[mm]	1 ... 400		1 ... 500			[3]	★ -...K8	
Improved running performance		Smooth anodised aluminium piston rod					[4]	-K10	
	[mm]	2 ... 400		5 ... 500					
Temperature resistance		Heat-resistant seals max. 120°C						★ -S6	
Corrosion protection		High corrosion protection					[5]	★ -R3	
Captive rating plate		Laser-etched rating plate						-TL	
Low temperature	[°C]	-40 ... +80				-	[6] [7]	-TT	
Wiper seal		Dust protection				-	[6]	-R8	
Special material properties		None							
		Recommended for production facilities for the manufacture of lithium-ion batteries					[9]	-F1A	

[2] **S2, S20** Not with improved running performance K10.
Not with corrosion protection R3.
Not with wiper seal R8

[3] **K8** The sum of the stroke length and piston rod extension must not exceed the maximum permissible stroke length

[4] **K10** Not with extended male thread K2.
Not with special piston rod thread K5.
Not with corrosion protection R3

[5] **R3** Not with captive rating plate TL
Not with wiper seal R8

[6] **TT, R8** Not with improved running performance K10.
Not with temperature resistance S6

[7] **TT** Not with wiper seal R8

[9] **F1A** Not with S6, S20, K10, R3, TL, TT, R8, PPS

**Note**

NSF-H1 lubricants are used in combination with R3 and in combination with R3 and K2, K5 or K8.

Ordering data – Modular product system, S10 – constant motion, S11 – low friction

Ordering table										
Size	12	16	20	25	32	40	Conditions	Code	Enter code	
Module no.	536203	536218	536233	536250	536267	536288				
Function	Compact cylinder, double-acting, based on ISO 21287								ADN	ADN
Piston ø [mm]	12	16	20	25	32	40		-...		
Stroke [mm]	1 ... 300				1 ... 400			-...		
Piston rod thread	Male thread								-A	
	Female thread							[1]	-I	
Cushioning	Elastic cushioning rings/plates at both ends								-P	-P
Position sensing	Via proximity sensor								-A	-A
Extended male thread [mm]	Extended male piston rod thread									
	1 ... 10			1 ... 20					-...K2	
Special piston rod thread	Male thread		M6	M8	M10x1.25 M10	M10x1.25 M10	M10 M12	M10 M12		-“...”K5
	Female thread		-	-	M5	M5	M6	M6		
Extended piston rod [mm]	1 ... 300				1 ... 400		[2]	-...K8		
Improved running performance	-	-	Smooth anodised aluminium piston rod				[3]	-K10		
Constant motion [mm]	Slow speed (constant motion at low piston speeds)							[4]	-S10	
	Restricted stroke 20 ... 300				20 ... 400					
Low friction	Smooth running							[5]	-S11	
Corrosion protection	High corrosion protection							[6]	-R3	
Captive rating plate	Laser-etched rating plate								-TL	

- [1] **I** Not with extended male thread K2
- [2] **K8** The sum of the stroke length and piston rod extension must not exceed the maximum permissible stroke length
- [3] **K10** Not with extended male thread K2
Not with special piston rod thread K5
Not with corrosion protection R3
- [4] **S10** Not with low friction S11
- [5] **S11** Not with constant motion S10
- [6] **R3** Not with captive rating plate TL

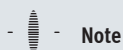
**Note**

NSF-H1 lubricants are used in combination with R3 and in combination with R3 and K2, K5 or K8.

Ordering data – Modular product system, S10 – constant motion, S11 – low friction

Ordering table										
Size	50	63	80	100	125	Conditions	Code	Enter code		
Module no.	536309	536330	536351	536372	536393					
Function	Compact cylinder, double-acting, based on ISO 21287							ADN		ADN
Piston Ø [mm]	50	63	80	100	125		-...			
Stroke [mm]	1 ... 400		1 ... 500				-...			
Piston rod thread	Male thread							-A		
	Female thread						[1]	-I		
Cushioning	Elastic cushioning rings/plates at both ends							-P		-P
Position sensing	Via proximity sensor							-A		-A
Extended male thread [mm]	Extended male piston rod thread									
	1 ... 20		1 ... 30		1 ... 40			-...K2		
Special piston rod thread	Male thread		M12	M12	M16	M16	M20	-“...”K5		
	Female thread		M16	M16	M20	M20	M20x1.5		M20x1.5	
Extended piston rod [mm]	M8		M8	M10	M10	-				
	Extended piston rod									
Improved running performance [mm]	1 ... 400		1 ... 500							
	Restricted stroke						[2]	-...K8		
Constant motion [mm]	2 ... 400		5 ... 400	5 ... 500						
	Smooth anodised aluminium piston rod						[3]	-K10		
Low friction [mm]	20 ... 400		20 ... 500							
	Restricted stroke						[4]	-S10		
Low friction	Smooth running						[5]	-S11		
Corrosion protection	High corrosion protection						[6]	-R3		
Captive rating plate	Laser-etched rating plate							-TL		

- [1] **I** Not with extended male thread K2
 [2] **K8** The sum of the stroke length and piston rod extension must not exceed the maximum permissible stroke length
 [3] **K10** Not with extended male thread K2
 Not with special piston rod thread K5
 Not with corrosion protection R3
 [4] **S10** Not with low friction S11
 [5] **S11** Not with constant motion S10
 [6] **R3** Not with captive rating plate TL

 **Note**

NSF-H1 lubricants are used in combination with R3 and in combination with R3 and K2, K5 or K8.

Ordering data – Modular product system, Q – Square piston rod, non-rotating

Ordering table										
Size	12	16	20	25	32	40	Conditions	Code	Enter code	
Module no.	536203	536218	536233	536250	536267	536288				
Function	Compact cylinder, double-acting, based on ISO 21287								ADN	ADN
Piston Ø [mm]	12	16	20	25	32	40		★ -...		
Stroke [mm]	1 ... 300				1 ... 400			★ -...		
Piston rod thread	Male thread							★ -A		
	Female thread						[1]	★ -I		
Cushioning	Elastic cushioning rings/plates at both ends							★ -P	-P	
Position sensing	Via proximity sensor							★ -A	-A	
Protection against rotation	Square piston rod							★ -Q	-Q	
Piston rod type	Through piston rod							★ -S2		
	-	Through, hollow piston rod						-S20		
			Restricted stroke		1 ... 300					
			1 ... 200							
Extended male thread [mm]	Extended male piston rod thread									
	1 ... 10		1 ... 20					-...K2		
Special piston rod thread Male thread	M6	M8	M10x1.25 M10	M10x1.25 M10	M10	M10		-“...”K5		
Extended piston rod [mm]	Extended piston rod				1 ... 400		[2]	★ -...K8		
Temperature resistance	Heat-resistant seals max. 120°C							★ -S6		
Corrosion protection	High corrosion protection						[3]	★ -R3		
Captive rating plate	Laser-etched rating plate							-TL		

[1] **I** Not with piston rod type S20.
Not with extended male thread K2

[2] **K8** The sum of the stroke length and piston rod extension must not exceed the maximum permissible stroke length

[3] **R3** Not with captive rating plate TL

**Note**

NSF-H1 lubricants are used in combination with R3 and in combination with R3 and K2, K5 or K8.

Ordering data – Modular product system, Q – Square piston rod, non-rotating

Ordering table									
Size	50	63	80	100	125	Conditions	Code	Enter code	
Module no.	536309	536330	536351	536372	536393				
Function	Compact cylinder, double-acting, based on ISO 21287							ADN	ADN
Piston Ø [mm]	50	63	80	100	125		★ -...		
Stroke [mm]	1 ... 400		1 ... 500				★ -...		
Piston rod thread	Male thread							★ -A	
	Female thread						[1]	★ -I	
Cushioning	Elastic cushioning rings/plates at both ends							★ -P	-P
Position sensing	Via proximity sensor							★ -A	-A
Protection against rotation	Square piston rod							★ -Q	-Q
Piston rod type	Through piston rod							★ -S2	
	Through, hollow piston rod							-S20	
	Restricted stroke								
	1 ... 300	1 ... 400							
Extended male thread [mm]	Extended male piston rod thread								
	1 ... 20	1 ... 30			1 ... 40			-...K2	
Special piston rod thread Male thread	M12	M12	M16	M16	M20		-“...”K5		
Extended piston rod [mm]	Extended piston rod								
	1 ... 400		1 ... 500			[2]	★ -...K8		
Temperature resistance	Heat-resistant seals max. 120°C							★ -S6	
Corrosion protection	High corrosion protection						[3]	★ -R3	
Captive rating plate	Laser-etched rating plate							-TL	

- [1] **I** Not with piston rod type S20.
Not with extended male thread K2
- [2] **K8** The sum of the stroke length and piston rod extension must not exceed the maximum permissible stroke length
- [3] **R3** Not with captive rating plate TL

 **Note**

NSF-H1 lubricants are used in combination with R3 and in combination with R3 and K2, K5 or K8.

Ordering data – Modular product system, S1 – Reinforced piston rod

Ordering table							
Size	25	40	63	100	Conditions	Code	Enter code
Module no.	536250	536288	536330	536372			
Function	Compact cylinder, double-acting, based on ISO 21287					ADN	ADN
Piston ø [mm]	25	40	63	100		-...	
Stroke [mm]	5 ... 300	10 ... 400		10 ... 500		-...	
Piston rod thread	Male thread					-A	
	Female thread				[1]	-I	
Cushioning	Elastic cushioning rings/plates at both ends					-P	-P
Position sensing	Via proximity sensor					-A	-A
Extended male thread [mm]	Extended male piston rod thread						
	1 ... 20			1 ... 30		-...K2	
Special piston rod thread	Male thread	M10x1.25	M10x1.25	M12x1.25	M16x1.5	-“...”K5	
		M10	M12	M16	M20		
Extended piston rod [mm]	Extended male piston rod thread						
	1 ... 300	1 ... 400		1 ... 500	[2]	-...K8	
Temperature resistance	Heat-resistant seals max. 120°C					-S6	
Increased lateral load	Reinforced piston rod or extended piston rod bearing					-S1	-S1
Captive rating plate	Laser-etched rating plate					-TL	

[1] **I** Not with extended male thread K2

[2] **K8** The sum of the stroke length and piston rod extension must not exceed the maximum permissible stroke length

Type codes

001	Series
ADN	Compact cylinder, double-acting, based on ISO 21287

002	Piston diameter
20	20
25	25
32	32
40	40
50	50
63	63
80	80
100	100

003	Stroke
...	10 ... 500

004	Clamping unit
KP	Attached

005	Piston rod thread type
A	Male thread
I	Female thread

006	Cushioning
P	Elastic cushioning rings/plates on both sides

007	Position sensing
A	For proximity sensor

008	Piston rod thread extension
	None
...K2	1 ... 30 mm

009	Custom thread
"M6"K5	M6
"M8"K5	M8
"M10"K5	M10
"M10x-1,25"K5	M10x1.25
"M12"K5	M12
"M16"K5	M16
"M20x-1,5"K5	M20x1.5
"M5"K5	M5
"M20"K5	M20

010	Piston rod extension
	None
...K8	1 ... 500 mm

011	Captive rating plate
	Rating plate, glued
TL	Laser etched rating plate

Data sheet

Function

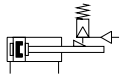

Variants



K2



K5



K8

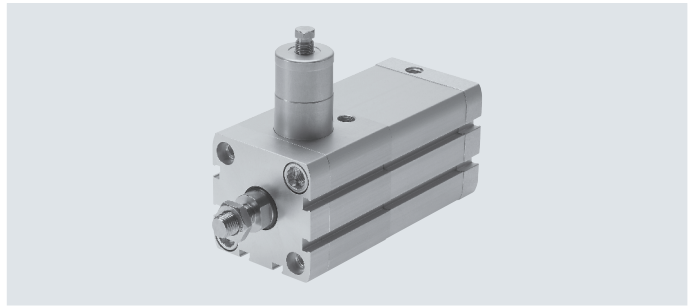

- - Diameter
20 ... 100 mm

- - Stroke length
10 ... 500 mm

Note

Additional measures are required for use in safety-related applications; in Europe, for example, the standards listed under the EC Machinery Directive must be observed.

Without additional measures in accordance with legally specified minimum requirements, the product is not suitable as a safety-related component in control systems.

General technical data								
Piston \varnothing	20	25	32	40	50	63	80	100
Pneumatic connection								
Cylinder	M5	M5	G1/8	G1/8	G1/8	G1/8	G1/8	G1/8
KP	M5	M5	M5	G1/8	G1/8	G1/8	G1/8	G1/8
Female piston rod thread								
-	M6		M8		M10		M12	
K5	M5		M6		M8		M10	
Male piston rod thread								
-	M8		M10x1.25		M12x1.25		M16x1.5	
K5	M10; M10x1.25		M10; M12		M12; M16		M16; M20; M20x1.5	
Axial backlash under load [mm]	0.5				0.8			
Design	Piston							
	Piston rod							
	Cylinder barrel							
Cushioning	Elastic cushioning rings/plates at both ends							
Position sensing	Via proximity sensor							
Type of mounting	Via through-hole							
	Via female thread							
	Via accessories							
Mounting position	Any							
Type of clamping with effective direction	At both ends							

Operating and environmental conditions	
Operating medium	Compressed air to ISO 8573-1:2010 [7:4:4]
Note on operating/pilot medium	Lubricated operation possible (in which case lubricated operation will always be required)
Operating pressure	[MPa] 0.15 ... 1
	[bar] 1.5 ... 10
Min. release pressure	[MPa] 0.3
	[bar] 3
Ambient temperature ¹⁾	[°C] -10 ... +80
Corrosion resistance class CRC ²⁾	2

1) Note operating range of proximity sensors

2) Corrosion resistance class CRC 2 to Festo standard FN 940070

Moderate corrosion stress. Indoor applications in which condensation can occur. External visible parts with primarily decorative surface requirements which are in direct contact with a normal industrial environment.

Data sheet

Impact energy [J]								
Piston \varnothing	20	25	32	40	50	63	80	100
Max. impact energy at the end positions	0.2	0.3	0.4	0.7	1	1.3	1.8	2.5

Note
 These specifications represent the maximum values that can be achieved. The maximum permissible impact energy must be observed.

Permissible impact speed:

$$V = \sqrt{\frac{2 \times E}{m_1 + m_2}}$$

V Perm. impact speed

E Max. impact energy

m1 Moving mass (drive)

m2 Moving payload

Maximum permissible mass:

$$m_2 = \frac{2 \times E}{v^2} - m_1$$

Forces [N]								
Piston \varnothing	20	25	32	40	50	63	80	100
Theoretical force at 6 bar, advancing	188	295	483	754	1178	1870	3016	4712
Theoretical force at 6 bar, retracting	141	247	415	633	990	1682	2721	4418
Static holding force	350	350	600	1000	1400	2000	5000	5000

Note.
 The specified holding force refers to a static load. If this value is exceeded, slippage may occur. Dynamic forces occurring during operation must

not exceed the static holding force. The clamping unit is not backlash-free in the clamped condition if varying loads are applied to the piston rod.

Control

The clamping unit may only be released if the forces at the piston have reached equilibrium. Otherwise, there is a risk of accidents due to sudden movement of the piston rod.

Blocking off the compressed air supply at both ends (e.g. with a 5/3-way valve) does not provide any safety.

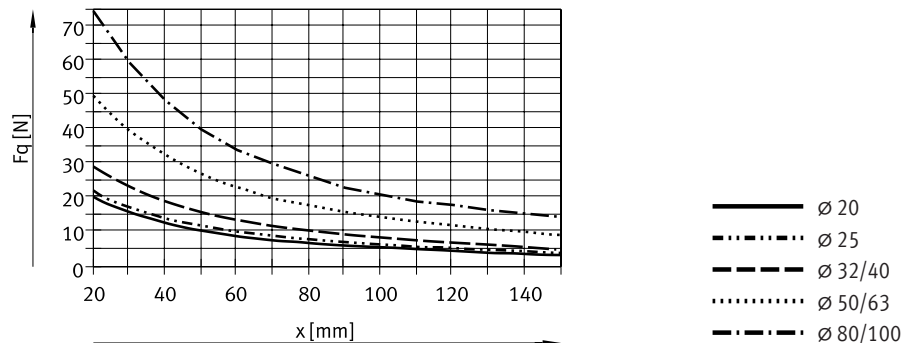
Max. lateral load F_q as a function of projection x

Weight [g]								
Piston \varnothing	20	25	32	40	50	63	80	100
Product weight with 0 mm stroke	282	344	503	789	1268	1894	3973	5497
Additional weight per 10 mm stroke	22	26	29	45	60	68	93	112
Moving mass with 0 mm stroke	53	63	100	173	296	368	755	932
Additional mass per 10 mm stroke	6	6	9	16	25	25	39	39

Data sheet

Materials

Sectional view

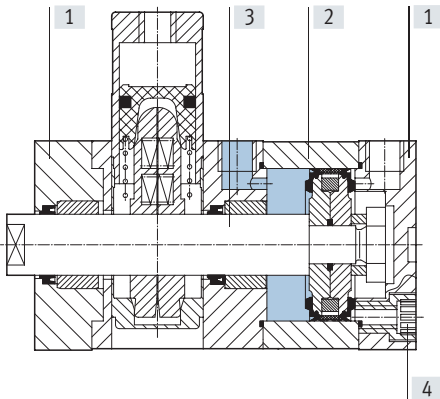

Compact cylinder

[1]	Cover	Anodised aluminium
[2]	Cylinder barrel	Anodised aluminium
[3]	Piston rod	High-alloy steel
[4]	Flange screws	$\varnothing 20 \dots 63$
		$\varnothing 80 \dots 100$
-	Seals	Polyurethane, nitrile rubber
	Note on materials	RoHS-compliant

Data sheet

Dimensions – Basic version

Download CAD data → www.festo.com

∅ 20 ... 63

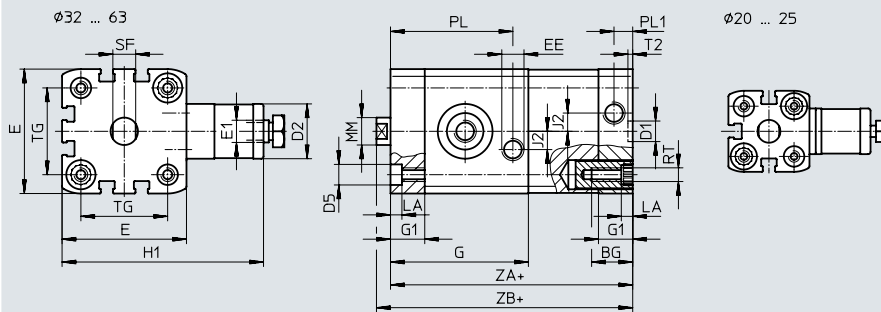

Only direct mounting is possible with this variant.

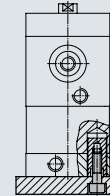

+ = plus stroke length

Dimensions – Basic version

Download CAD data → www.festo.com

∅ 80, 100

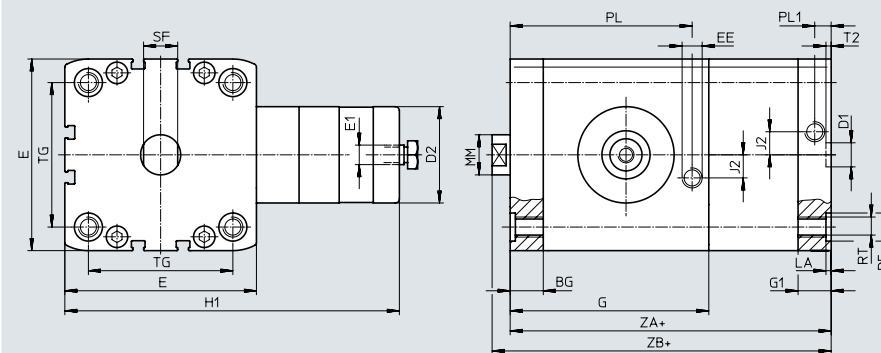

Only direct mounting is possible with this variant.

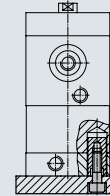

+ = plus stroke length

∅	BG	D1	D2	D5	E	E1	EE	G	G1	H1	J2
[mm]	min.	∅ H9	∅	∅							
20	19.5	9	20	9 ^{F9}	35.5 ^{+0.3}	M5	M5	49.8	12	63	2.6
25					39.5 ^{+0.3}			50.6			
32					47 ^{-0.3}			56.4			
40	26		24		54.5 ^{+0.3}	G1/8	G1/8	60.4	15	89	8
50					65.5 ^{+0.3}			67.4		108	
63	27	12	38	12 ^{F9}	75.5 ^{+0.3}	G1/8	G1/8	76.8	16.5	120	11.5
80					95.5 ^{+0.6}			99		167	
100					113.5 ^{+0.6}			99.6		21.5	

∅	LA	MM	PL	PL1	RT	SF	T2	TG	ZA	ZB
[mm]	+0.2	∅	+0.2	+0.2		h13	+0.2	±0.2	±0.3	+1.2
20	5	10	42.8	6	M5	9	2.1	22	74.8	80.8
25			44.6					26	77.6	83.1
32			49.6					32.5	85.4	91.4
40		16	53.6	38	90.4	96.5				
50		20	60.6	8.2	M8	17	2.6	46.5	97.4	105.6
63			70					56.5	110.8	118.9
80			90.7					72	136.5	145.4
100	2.6	25	88.6	10.5	M10	21	89	145.1	154.1	

Data sheet

Dimensions – Variants

Download CAD data → www.festo.com

Basic version

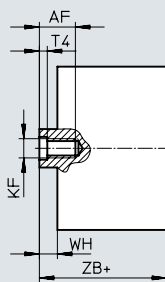
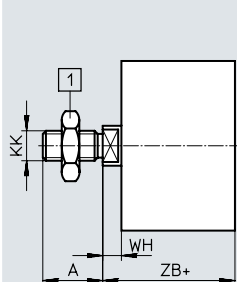

[2] Hex nut DIN 439-B
only with \varnothing 32 ... 100

+ = plus stroke length

K2 – Extended male piston rod thread

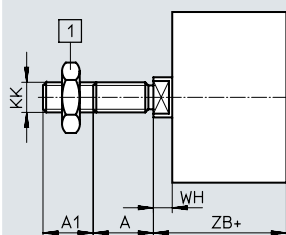

[1] Hex nut DIN 439-B
only with \varnothing 32 ... 100

+ = plus stroke length

K5 – Special piston rod thread

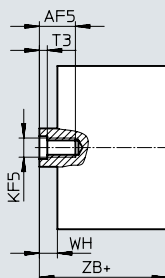
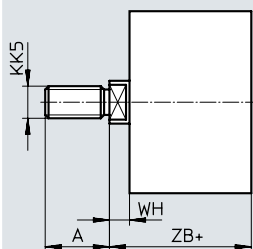

+ = plus stroke length

K8 – Extended piston rod

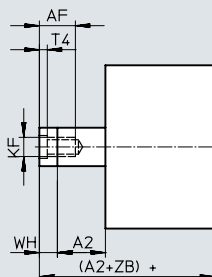
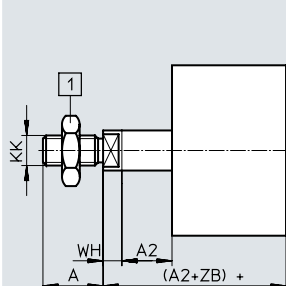

[1] Hex nut DIN 439-B
only with \varnothing 32 ... 100

+ = plus stroke length

Data sheet

∅	A	A1	A2	AF	AF5	KF	KF5
[mm]	-0.5			min.	min.		
20	16	1 ... 20	1 ... 300	14	12	M6	M5
25							
32	19		1 ... 400	16	14	M8	M6
40							
50	22	1 ... 30	1 ... 500	20	16	M10	M8
63							
80	28				20	M12	M10
100							

∅	KK	KK5	T3	T4	WH	ZB
[mm]					+1.3	+1.2
20	M8	M10x1.25	2	2.6	5.5	80.8
25		M10				83.1
32	M10x1.25	M10	2.6	3.3	6	91.4
40		M12				96.5
50	M12x1.25	M12	3.3	4.7	8.2	105.6
63		M16				118.9
80	M16x1.5	M16	4.7	6.1	8.9	145.4
100		M20x1.5 M20				154.1

Compact cylinders ADN-KP, standard hole pattern, with clamping unit

Ordering data – Modular product system

Ordering table							Conditions	Code	Enter code
Size	20	25	32	40					
Module no.	548206	548207	548208	548209					
Function	Compact cylinder, double-acting, standard hole pattern, with clamping unit						ADN	ADN	
Piston ø [mm]	20	25	32	40			-...		
Stroke [mm]	10 ... 300		10 ... 400				-...		
Clamping unit	Attached						-KP	-KP	
Piston rod thread	Male thread						-A		
	Female thread					[1]	-I		
Cushioning	Elastic cushioning rings/plates at both ends						-P	-P	
Position sensing	Via proximity sensor						-A	-A	
Extended male thread [mm]	Extended male piston rod thread 1 ... 20						-...K2		
Special piston rod thread	Male thread	M10x1.25 M10	M10x1.25 M10	M10 M12	M10 M12		-“...”K5		
	Female thread	M5	M5	M6	M6				
Extended piston rod [mm]	Extended piston rod 1 ... 300		1 ... 400		[2]	-...K8			
Captive rating plate	Laser-etched rating plate						-TL		

[1] **I** Not with extended male thread K2

[2] **K8** The sum of the stroke length and piston rod extension must not exceed the maximum permissible stroke length

Ordering data – Modular product system

Ordering table									
Size	50	63	80	100	Conditions	Code		Enter code	
Module no.	548210	548211	548212	548213					
Function	Compact cylinder, double-acting, standard hole pattern, with clamping unit						ADN	ADN	
Piston Ø [mm]	50	63	80	100		-...			
Stroke [mm]	10 ... 400		10 ... 500			-...			
Clamping unit	Attached						-KP	-KP	
Piston rod thread	Male thread						-A		
	Female thread					[1]	-I		
Cushioning	Elastic cushioning rings/plates at both ends						-P	-P	
Position sensing	Via proximity sensor						-A	-A	
Extended male thread [mm]	Extended male piston rod thread								
	1 ... 20		1 ... 30				-...K2		
Special piston rod thread	Male thread	M12 M16	M12 M16	M16 M20 M20x1.5	M16 M20 M20x1.5		-“...”K5		
	Female thread	M8	M8	M10	M10				
Extended piston rod [mm]	Extended piston rod		1 ... 400			1 ... 500	[2]	-...K8	
Captive rating plate	Laser-etched rating plate						-TL		

[1] **I** Not with extended male thread K2

[2] **K8** The sum of the stroke length and piston rod extension must not exceed the maximum permissible stroke length

Type codes

001	Series	
ADN	Compact cylinder, double-acting, based on ISO 21287	

002	Piston diameter	
20	20	
25	25	
32	32	
40	40	
50	50	
63	63	
80	80	
100	100	

003	Stroke	
...	10 ... 500	

004	End-position locking	
ELB	Both sides	
ELH	Rear	
ELV	Front	

005	Piston rod thread type	
A	Male thread	
I	Female thread	

006	Cushioning	
P	Elastic cushioning rings/plates on both sides	

007	Position sensing	
A	For proximity sensor	

008	Piston rod thread extension	
	None	
...K2	1 ... 30 mm	

009	Custom thread	
"M6"K5	M6	
"M8"K5	M8	
"M10"K5	M10	
"M10x1,25"K5	M10x1.25	
"M12"K5	M12	
"M16"K5	M16	
"M20x1,5"K5	M20x1.5	
"M5"K5	M5	
"M20"K5	M20	

010	Piston rod extension	
	None	
...K8	1 ... 500 mm	

011	Captive rating plate	
	Rating plate, glued	
TL	Laser etched rating plate	

Data sheet

Function

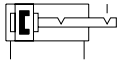

Variants



K2



K5



K8

- - Diameter
20 ... 100 mm

- - Stroke length
10 ... 500 mm

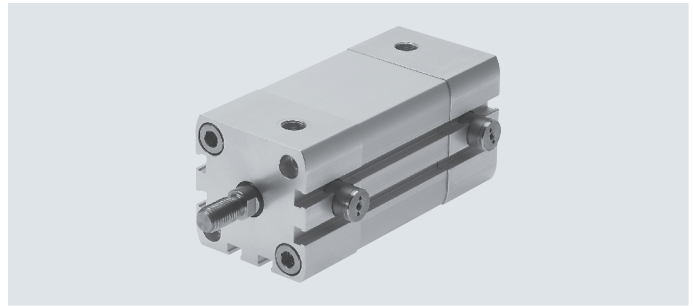

- **Note**

Additional measures are required for use in safety-related applications; in Europe, for example, the standards listed under the EC Machinery Directive must be observed.

Without additional measures in accordance with legally specified minimum requirements, the product is not suitable as a safety-related component in control systems.

General technical data								
Piston \varnothing	20	25	32	40	50	63	80	100
Pneumatic connection	M5	M5	G1/8	G1/8	G1/8	G1/8	G1/8	G1/8
Female piston rod thread								
-	M6	M8	M10	M12				
K5	M5	M6	M8	M10				
Male piston rod thread								
-	M8	M10x1.25	M12x1.25	M16x1.5				
K5	M10; M10x1.25	M10; M12	M12; M16	M16; M20; M20x1.5				
Max. axial backlash with end position locked [mm]	1.3						2.1	
Design								
	Piston							
	Piston rod							
	Cylinder barrel							
End-position locking								
ELB	At both ends							
ELV	At front							
ELH	At rear							
Cushioning	Elastic cushioning rings/plates at both ends							
Position sensing	Via proximity sensor							
Type of mounting								
	Via female thread							
	Via accessories							
Mounting position	Any							

- **Note**

- No screws with a head or similar may be used in place of end-position locking, as there is a risk that the function will be impaired if they are screwed in too deeply.
- The exhaust hole must not be closed.
- The piston rod can be locked in any stroke position once the drive is brought mechanically into its end position.
- End-position locking has been designed to prevent the load from dropping in case of pressure failure.
- Operation of the cylinder in conjunction with a 3-way valve (especially with the function “mid-position closed” and those with “metallic sealing”) should be avoided. The residual pressure that is enclosed on the locking side of the cylinder can release the locking function.
- The cylinder must not be operated with external stops (e.g. shock absorber, buffer, oil brake, etc.):
 - It may not be possible to reliably reach the internal end position.
 - The locking mechanism can wear out prematurely. (In the event of pressure drop in the opposite chamber to less than the locking pressure, the locking piston will prematurely fall to its lower end position.)

Data sheet

Operating and environmental conditions								
Piston \varnothing	20	25	32	40	50	63	80	100
Operating medium	Compressed air to ISO 8573-1:2010 [7:4:4]							
Note on operating/pilot medium	Lubricated operation possible (in which case lubricated operation will always be required)							
Operating pressure	[MPa]	0.25 ... 1			0.15 ... 1			
	[bar]	2.5 ... 10			1.5 ... 10			
Ambient temperature ¹⁾	[°C]	-20 ... +80						
Corrosion resistance class CRC ²⁾	2							

1) Note operating range of proximity sensors

2) Corrosion resistance class CRC 2 to Festo standard FN 940070

Moderate corrosion stress. Indoor applications in which condensation can occur. External visible parts with primarily decorative surface requirements which are in direct contact with a normal industrial environment.

Forces [N]								
Piston \varnothing	20	25	32	40	50	63	80	100
Theoretical force at 6 bar, advancing	188	295	483	754	1178	1870	3016	4712
Theoretical force at 6 bar, retracting	141	247	415	686	1057	1750	2827	4524
Static holding force	250	500			2000		5000	

Sizing example

Note
When sizing pneumatic cylinders it is recommended as a basic principle that only 50% of the indicated theoretical forces (see above) be used

Assuming:
Mounting position = vertical
Workpiece load = 44 kg
 $F = m \times g = 44 \text{ kg} \times 9.81 \text{ m/s}^2 = 431.6 \text{ N}$

To be calculated:
Suitable piston diameter

Example with 32 mm piston diameter:
Theoretical force at 6 bar, advancing = 483 N
50% of the theoretical force = 241.5 N
Static holding force with 32 mm piston diameter = 500 N
The static holding force of end-position locking is within the permissible range (max. 500 N) for a workpiece load of 44 kg (431.6 N); however, the cylinder would be at 89% capacity.
Result:
A cylinder with a piston diameter of 40 mm is therefore recommended for this application.

Impact energy [J]								
Piston \varnothing	20	25	32	40	50	63	80	100
Max. impact energy at the end positions	0.2	0.3	0.4	0.7	1	1.3	1.8	2.5

Note
These specifications represent the maximum values that can be achieved. The maximum permissible impact energy must be observed.

Permissible impact speed: $V = \sqrt{\frac{2 \times E}{m_1 + m_2}}$
Maximum permissible mass: $m_2 = \frac{2 \times E}{v^2} - m_1$

V Perm. impact speed
E Max. impact energy
m1 Moving mass (drive)
m2 Moving payload

Max. lateral load Fq as a function of projection x

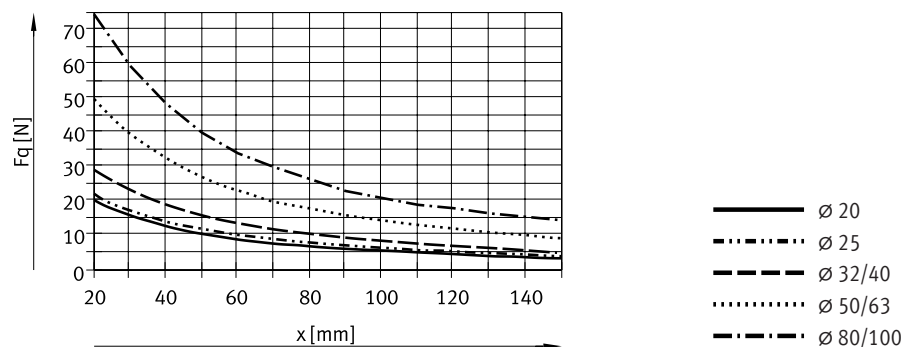

Data sheet

Weight [g]	20	25	32	40	50	63	80	100
Piston \varnothing								
End-position locking at both ends								
Product weight with 0 mm stroke	234	339	518	665	1334	1734	3300	4735
Additional weight per 10 mm stroke	22	26	29	38	51	59	79	98
Moving mass with 0 mm stroke	43	53	85	101	199	248	475	637
Additional mass per 10 mm stroke	6	6	9	9	16	16	25	25
End-position locking at front								
Product weight with 0 mm stroke	177	248	387	498	922	1228	2296	3448
Additional weight per 10 mm stroke	22	26	29	38	51	59	79	98
Moving mass with 0 mm stroke	35	46	75	98	175	225	464	626
Additional mass per 10 mm stroke	6	6	9	9	16	16	25	25
End-position locking at rear								
Product weight with 0 mm stroke	181	252	380	505	920	1217	2233	3409
Additional weight per 10 mm stroke	22	26	29	38	51	59	79	98
Moving mass with 0 mm stroke	37	45	73	89	168	217	413	582
Additional mass per 10 mm stroke	6	6	9	9	16	16	25	25

Materials

Sectional view

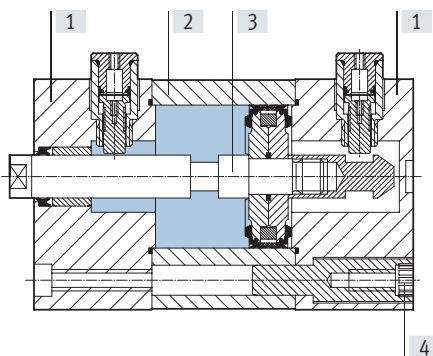

Compact cylinder		
[1]	Cover	Anodised aluminium
[2]	Cylinder barrel	Anodised aluminium
[3]	Piston rod	High-alloy steel
[4]	Flange screws	$\varnothing 20 \dots 63$
		$\varnothing 80 \dots 100$
-	Seals	Polyurethane, nitrile rubber
	Note on materials	RoHS-compliant

Data sheet

Dimensions – Basic version

Download CAD data → www.festo.com

ELB – End-position locking at both ends

∅ 20 ... 63

∅ 32 ... 63

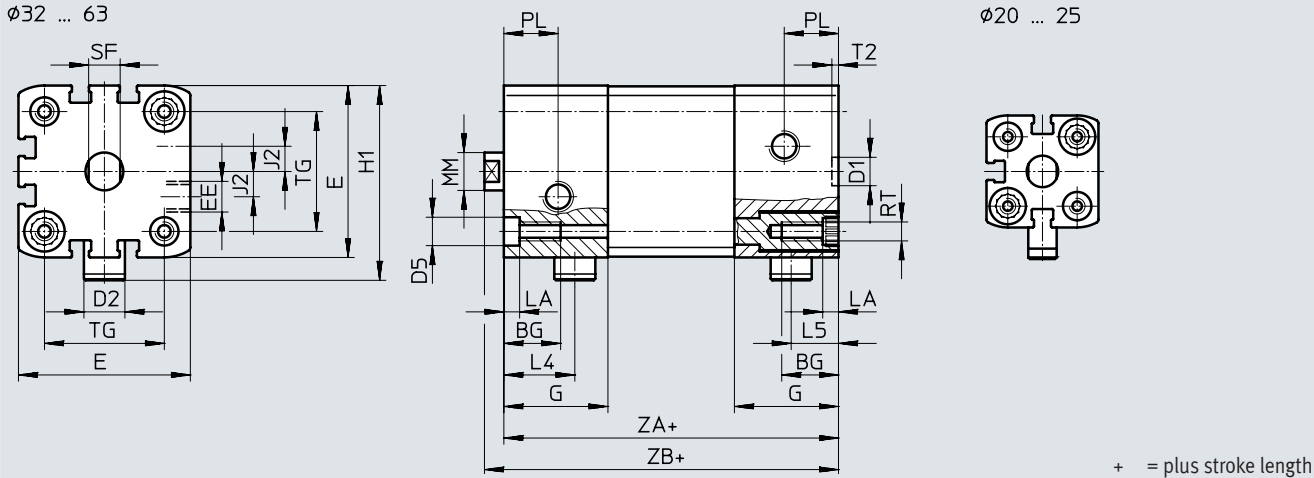

∅ 80 ... 100

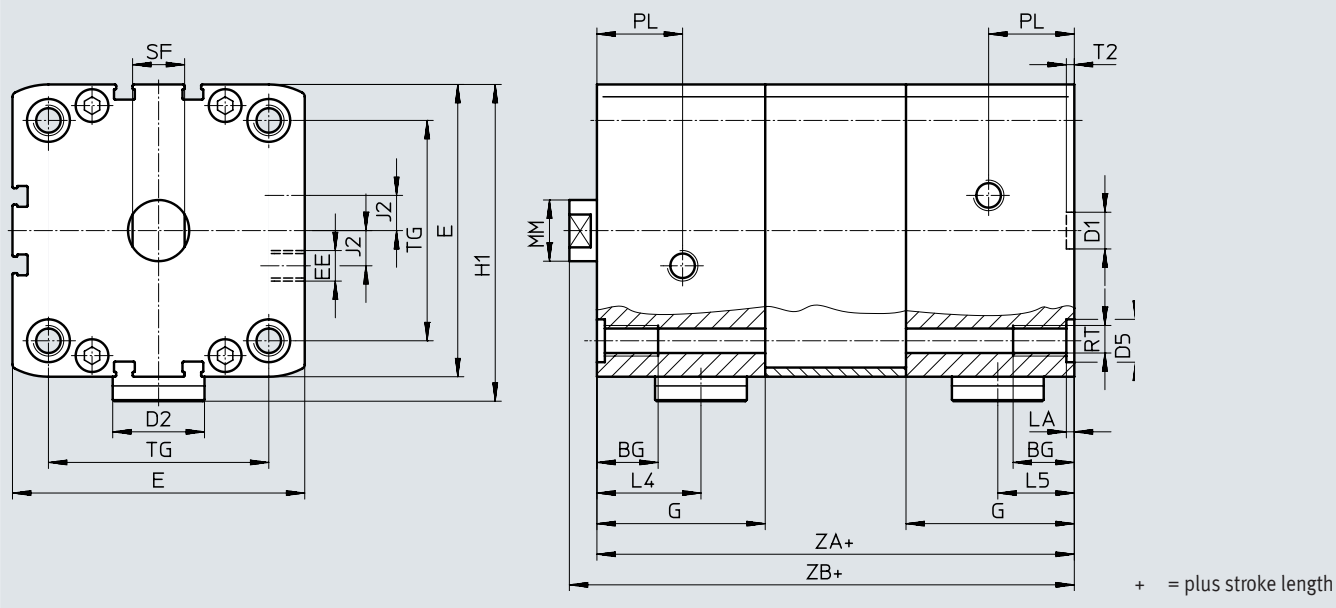

ELV – End-position locking at front

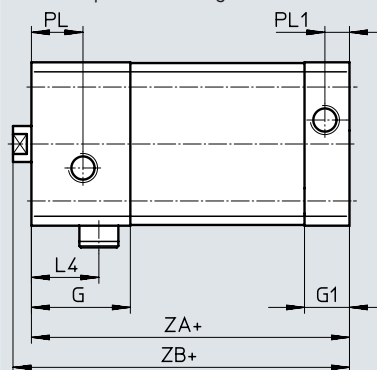

ELH – End-position locking at rear

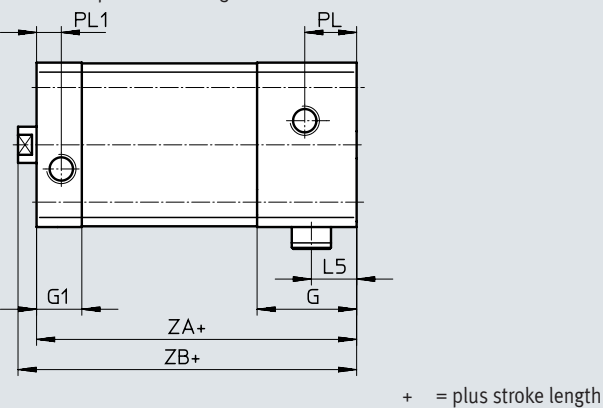

Data sheet

∅ [mm]	BG min.	D1 ∅ H9	D2 ∅	D5 ∅	E	EE	G	G1	H1	J2	L4	L5		
20	18	9	9	9 ^{F9}	35.5 ^{+0.3}	M5	25	12	45.5	2.6	18.5	12.5		
25			13		39.5 ^{+0.3}		29.5		53.3		20.8	14		
32			20		12	20	47 ^{+0.3}	G1/8	33	15	58	8	22.5	15
40							54.5 ^{+0.3}				61.8			
50	65.5 ^{+0.3}	43		77		82	11.5		27.5		20.5			
63	75.5 ^{+0.3}													
80	95.5 ^{+0.6}	55		16.5		103.5	34		25					
100	113.5 ^{+0.6}	57		21.5		113.5	35		27					

∅ [mm]	LA +0.2	MM ∅	PL	PL1	RT	SF h13	T2 +0.1	TG ±0.2	ZA ±0.3		ZB +1.2	
									ELB	ELV, ELH	ELB	ELV, ELH
20	5	10	6	6	M5	9	2.1	22	63	50	68.8	55.5
25								26	74	56.5	79.5	62
32		12	16	8.2	M6	10		32.5	80	62	86	68
40								38	81	63	87.1	69
50	16	21	M8		13	2.6	46.5	101	73	109.2	81.2	
63							56.5	105	77	113.1	85.1	
80	20	28	M10	17	72		131	92.5	139.9	101.4		
100					10.5		89	138	102.5	147	111.5	

Data sheet

Dimensions – Variants

Download CAD data → www.festo.com

Basic version

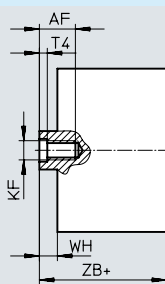
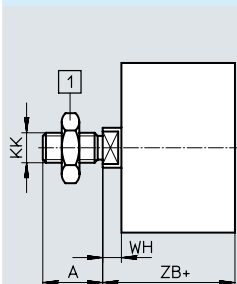

[1] Hex nut DIN 439-B
only with $\varnothing 32 \dots 100$

+ = plus stroke length

K2 – Extended male piston rod thread

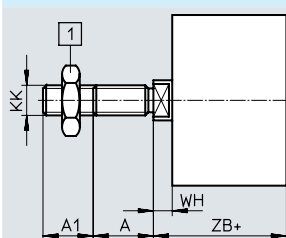

[1] Hex nut DIN 439-B
only with $\varnothing 32 \dots 100$

+ = plus stroke length

K5 – Special piston rod thread

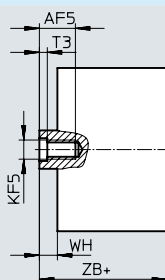
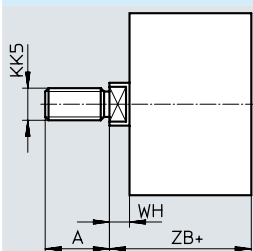

+ = plus stroke length

K8 – Extended piston rod

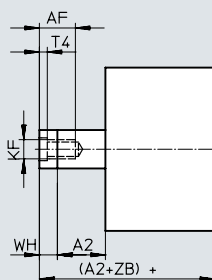
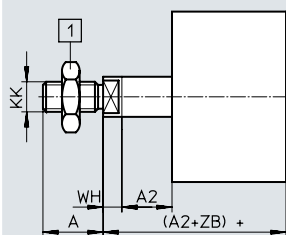

[1] Hex nut DIN 439-B
only with $\varnothing 32 \dots 100$

+ = plus stroke length

Data sheet

∅	A	A1	A2	AF	AF5	KF	KF5				
[mm]	-0.5			min.	min.						
20	16	1 ... 20	1 ... 300	14	12	M6	M5				
25			1 ... 400	16	14	M8	M6				
32	22							20	16	M10	M8
40			1 ... 30	1 ... 500	20	20	M12				
50	28	20						16	M10	M8	
63											20
80	28	20	16	M10	M8						
100						28	20	16	M10	M8	

∅	KK	KK5	T3	T4	WH	ZB +1.2	
[mm]					+1.3	ELB	ELV, ELH
20	M8	M10x1.25	2	2.6	5.5	68.8	55.5
25		M10				79.5	62
32	M10x1.25	M10	2.6	3.3	6	86	68
40		M12				87.1	69
50	M12x1.25	M12	3.3	4.7	8.2	109.2	81.2
63		M16				113.1	85.1
80	M16x1.5	M16	4.7	6.1	8.9	139.9	101.4
100		M20x1.5 M20				147	111.5

Ordering data – Modular product system

Ordering table		20		25		32		40		Conditions	Code	Enter code
Size		20		25		32		40				
Module no.		548214		548215		548216		548217				
Function		Compact cylinder, double-acting, standard hole pattern, with end-position locking									ADN	ADN
Piston ø	[mm]	20	25	32	40						-...	
Stroke	[mm]	10 ... 300		10 ... 400							-...	
End-position locking		At both ends									-ELB	
		At front									-ELV	
		At rear									-ELH	
Piston rod thread		Male thread									-A	
		Female thread								[1]	-I	
Cushioning		Elastic cushioning rings/plates at both ends									-P	-P
Position sensing		Via proximity sensor									-A	-A
Extended male thread		Extended male piston rod thread										
	[mm]	1 ... 20									-...K2	
Special piston rod thread		Male thread		M10x1.25	M10x1.25	M10	M10	M10	M10		-“...”K5	
		Female thread		M5	M5	M6	M6	M6	M6			
Extended piston rod		Extended piston rod										
	[mm]	1 ... 300			1 ... 400					[2]	-...K8	
Captive rating plate		Laser-etched rating plate									-TL	

[1] **I** Not with extended male thread K2

[2] **K8** The sum of the stroke length and piston rod extension must not exceed the maximum permissible stroke length

Ordering data – Modular product system

Ordering table							
Size	50	63	80	100	Conditions	Code	Enter code
Module no.	548218	548219	548220	548221			
Function	Compact cylinder, double-acting, standard hole pattern, with end-position locking					ADN	ADN
Piston Ø [mm]	50	63	80	100		-...	
Stroke [mm]	10 ... 400		10 ... 500			-...	
End-position locking	At both ends					-ELB	
	At front					-ELV	
	At rear					-ELH	
Piston rod thread	Male thread					-A	
	Female thread				[1]	-I	
Cushioning	Elastic cushioning rings/plates at both ends					-P	-P
Position sensing	Via proximity sensor					-A	-A
Extended male thread [mm]	Extended male piston rod thread		1 ... 30			-...K2	
	1 ... 20						
Special piston rod thread	Male thread	M12	M12	M16	M16	-“...”K5	
		M16	M16	M20	M20		
	Female thread	M8	M8	M10	M10		
Extended piston rod [mm]	Extended piston rod				[2]	-...K8	
	1 ... 400		1 ... 500				
Captive rating plate	Laser-etched rating plate					-TL	

[1] **I** Not with extended male thread K2

[2] **K8** The sum of the stroke length and piston rod extension must not exceed the maximum permissible stroke length

Type codes

001	Series	
AEN	Compact cylinder, single-acting, based on ISO 21287	

002	Piston diameter [mm]	
12	12	
16	16	
20	20	
25	25	
32	32	
40	40	
50	50	
63	63	
80	80	
100	100	

003	Stroke [mm]	
...	1 ... 25	

004	Piston rod thread type	
A	Male thread	
I	Female thread	

005	Cushioning	
P	Elastic cushioning rings/plates on both sides	

006	Position sensing	
A	For proximity sensor	

007	Active direction	
Z	Single-acting, pulling	
	Single-acting, pushing	

008	Piston rod thread extension	
	None	
...K2	1 ... 30 mm	

009	Custom thread	
"M5"K5	M5	
"M6"K5	M6	
"M8"K5	M8	
"M10"K5	M10	
"M10x1,25"K5	M10x1.25	
"M12"K5	M12	
"M16"K5	M16	
"M20"K5	M20	
"M20x1,5"K5	M20x1.5	

010	Piston rod extension	
	None	
...K8	1 ... 25 mm	

011	Improved running performance	
	None	
K10	Smooth anodised aluminium coated piston rod	

012	Temperature resistance	
	Standard	
S6	Heat-resistant seals max. 120 °C	

013	Captive rating plate	
	Rating plate, glued	
TL	Laser etched rating plate	

Data sheet

Function

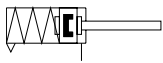

Pulling

-  - Diameter
12 ... 100 mm

-  - Stroke length
1 ... 25 mm

 www.festo.com

Variants



S6



K2



K5



K8



K10



Q

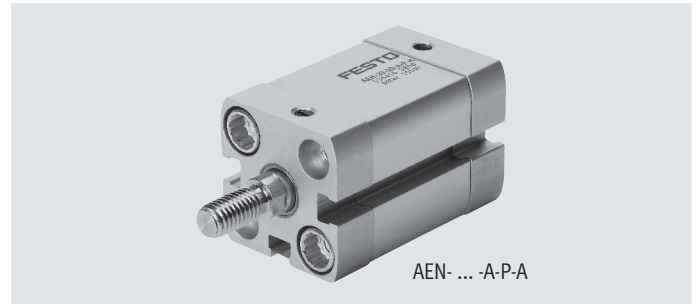

AEN- ... -A-P-A

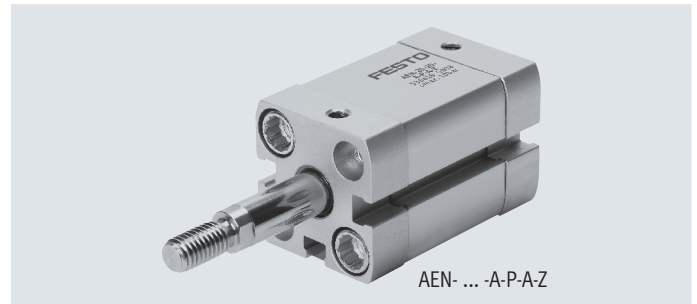

AEN- ... -A-P-A-Z

General technical data

Piston Ø	12	16	20	25	32	40	50	63	80	100
Design	Piston									
	Piston rod									
	Cylinder barrel									
Cushioning	Elastic cushioning rings/plates at both ends									
Position sensing	Via proximity sensor									
Type of mounting	Via through-hole									
	Via female thread									
	Via accessories									
Mounting position	Any									

Technical data – Basic version and variants

Piston Ø	12	16	20	25	32
Pneumatic connection	M5	M5	M5	M5	G1/8
Female piston rod thread					
-	M3	M4	M6	M6	M8
K5	-	-	M5	M5	M6
Male piston rod thread					
-	M5	M6	M8	M8	M10x1.25
K5	M6	M8	M10; M10x1.25	M10; M10x1.25	M10; M12
Q-K5	-	M8	M10; M10x1.25	M10; M10x1.25	M10

Piston Ø	40	50	63	80	100
Pneumatic connection	G1/8	G1/8	G1/8	G1/8	G1/8
Female piston rod thread					
-	M8	M10	M10	M12	M12
K5	M6	M8	M8	M10	M10
Male piston rod thread					
-	M10x1.25	M12x1.25	M12x1.25	M16x1.5	M16x1.5
K5	M10; M12	M12; M16	M12; M16	M16; M20; M20x1.5	M16; M20; M20x1.5
Q-K5	M10	M12	M12	M16	M16

Data sheet

Operating and environmental conditions										
Piston ø	12	16	20	25	32	40	50	63	80	100
Operating medium	Compressed air to ISO 8573-1:2010 [7:4:4]									
Note on operating/pilot medium	Lubricated operation possible (in which case lubricated operation will always be required)									
Operating pressure [bar]										
[MPa]										
-	0.15 ... 1		0.1 ... 1							
Z	0.17 ... 1	0.22 ... 1	0.13 ... 1		0.07 ... 1	0.06 ... 1				
Q	0.15 ... 1		0.1 ... 1							
[bar]										
-	1.5 ... 10		1 ... 10							
Z	1.7 ... 10	2.2 ... 10	1.3 ... 10		0.7 ... 10	0.6 ... 10				
Q	1.5 ... 10		1 ... 10							
Ambient temperature ¹⁾ [°C]										
-	-20 ... +80									
S6	0 ... +120									
Corrosion resistance class CRC ²⁾										
	2									

1) Note operating range of proximity sensors

2) Corrosion resistance class CRC 2 to Festo standard FN 940070

Moderate corrosion stress. Indoor applications in which condensation can occur. External visible parts with primarily decorative surface requirements which are in direct contact with a normal industrial environment.

Forces [N] and impact energy [J]										
Piston ø	12	16	20	25	32	40	50	63	80	100
AEN										
Theoretical force at 6 bar, advancing	56	95	162	259	441	702	1098	1783	2899	4511
AEN-...-Z, pulling										
Theoretical force at 6 bar, retracting	39	65	115	211	373	634	977	1663	2610	4323
Max. impact energy at the end positions	0.04	0.04	0.04	0.08	0.1	0.15	0.18	0.28	0.35	0.7

Note
These specifications represent the maximum values that can be achieved. The maximum permissible impact energy must be observed.

Permissible impact speed:

$$V = \sqrt{\frac{2 \times E}{m_1 + m_2}}$$

Maximum permissible mass:

$$m_2 = \frac{2 \times E}{v^2} - m_1$$

- V Perm. impact speed
- E Max. impact energy
- m1 Moving mass (drive)
- m2 Moving payload

Spring return force F as a function of stroke l

ø 12 ... 20

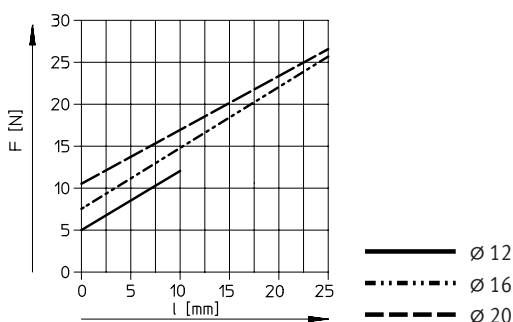

ø 25 ... 100

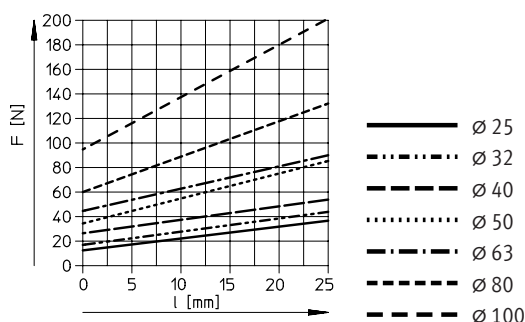

Note
The degree of friction depends on the mounting position and the type of load involved. Single-acting cylinders should as far as possible be operated without lateral loads.

Data sheet

Weight [g]										
Piston \varnothing	12	16	20	25	32	40	50	63	80	100
Product weight with 0 mm stroke	77	79	131	156	265	346	540	722	1300	2154
Additional weight per 10 mm stroke	12	14	21	23	30	37	51	59	79	98
Moving mass with 0 mm stroke	9	15	30	50	60	80	140	180	400	570
Additional mass per 10 mm stroke	2	4	6	6	9	9	16	16	25	25

Materials

Sectional view

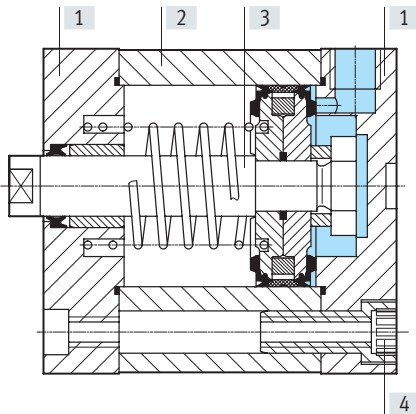

Compact cylinder		Basic version	S6
[1]	Cover	\varnothing 12 ... 80 \varnothing 100	Anodised aluminium Coated die-cast aluminium
[2]	Cylinder barrel		Anodised aluminium
[3]	Piston rod		High-alloy steel
[4]	Flange screws	\varnothing 12 ... 16	High-alloy steel
		\varnothing 20 ... 63	Galvanised steel
		\varnothing 80 ... 100	Standard screws, galvanised steel
-	Seals		Polyurethane Fluoro rubber
	Note on materials		RoHS-compliant

Data sheet

Dimensions – Basic version

Download CAD data → www.festo.com

∅ 12 ... 63

∅ 32 ... 63

∅ 12 ... 25

∅ 12

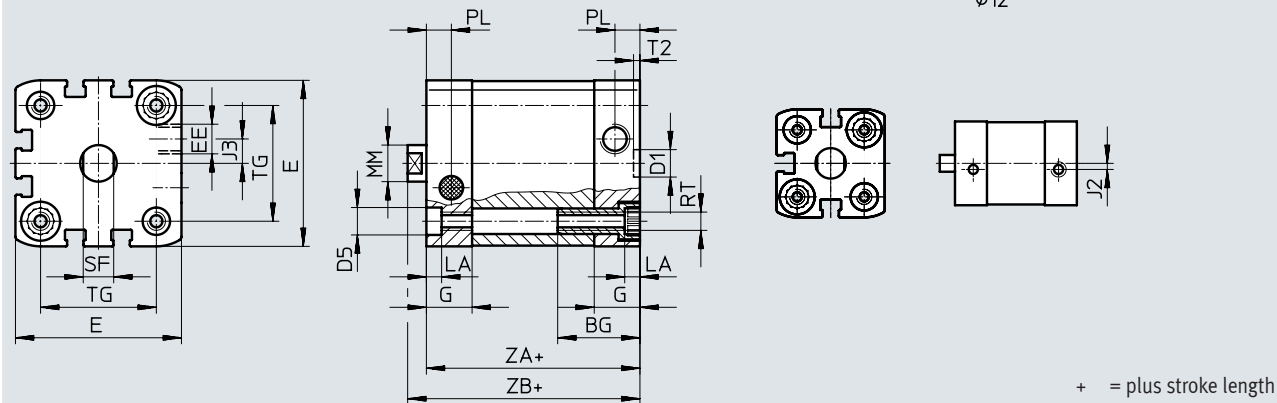

∅ 80 ... 100

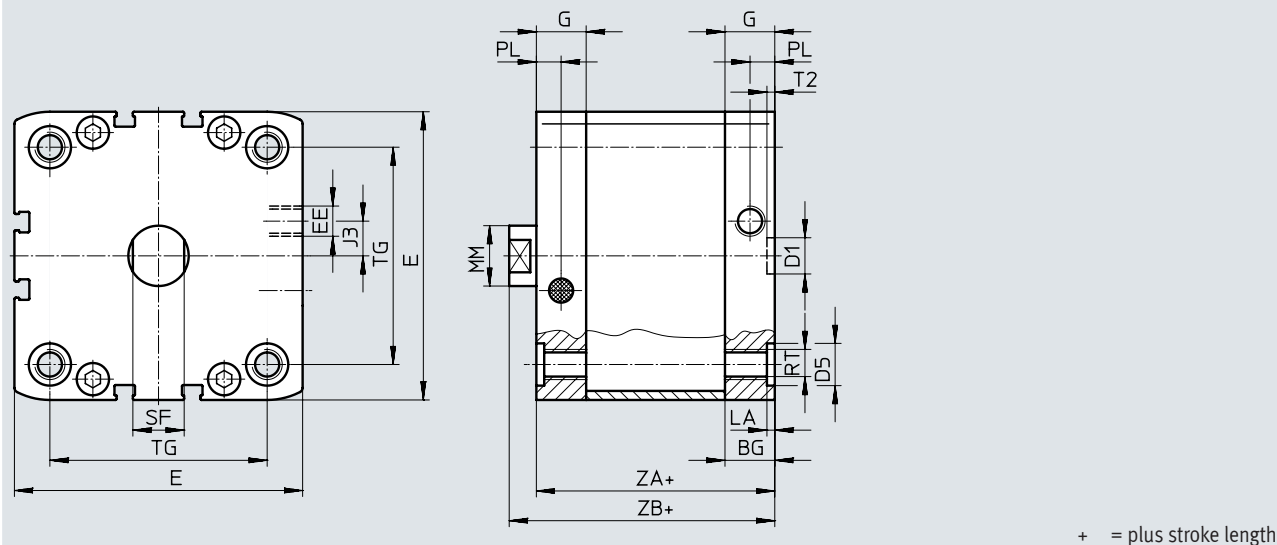

Data sheet

∅ [mm]	BG min.	D1 ∅ H9	D5 ∅	E	EE	G	J2	J3	LA +0.2
12	17	9	6 ^{F9}	27.5 ^{+0.3}	M5	10.5	2	–	3.5
16				29 ^{+0.3}		11	2.6		
20	19.5		9 ^{F9}	35.5 ^{+0.3}		12			
25				39.5 ^{+0.3}	15	6			
32	26		47 ^{+0.3}	8		5			
40		54.5 ^{+0.3}	11.5						
50	27	12 ^{F9}		65.5 ^{+0.3}	G1/8	15	20		
63				75.5 ^{+0.3}					
80	17	15	95.5 ^{+0.6}	16.5					
100	21.5		113.5 ^{+0.6}	21.5	2.6				

∅ [mm]	MM ∅	PL +0.2	RT	SF h13	T2 +0.1	TG ±0.2	ZA ±0.3	ZB +1.2
12	6	6	M4	5	2.1	16	35	39.2
16	8			7		18		39.7
20	10		M5	9		22	42.5	
25		26		39		44.5		
32	12	8.2	M6	10		2.6	32.5	44
40				38	45		51.1	
50	16		M8	13	46.5		49	53.2
63				56.5	57.1			
80	20		10.5	M10	17	72	54	62.9
100		89			67	76		

Data sheet

Dimensions – Variants

Download CAD data → www.festo.com

Basic version

[1] Hex nut DIN 439-B
only with $\varnothing 32 \dots 100$

+ = plus stroke length

Z – Pulling

[1] Hex nut DIN 439-B
only with $\varnothing 32 \dots 100$

+ = plus stroke length
++ = plus 2x stroke length

K2 – Extended male piston rod thread

[1] Hex nut DIN 439-B
only with $\varnothing 32 \dots 100$

+ = plus stroke length

K5 – Special piston rod thread

+ = plus stroke length

K8 – Extended piston rod

[1] Hex nut DIN 439-B
only with $\varnothing 32 \dots 100$

+ = plus stroke length

Data sheet

∅	A	A1	A2	AF	AF5	KF	KF5
[mm]	-0.5			min.	min.		
12	10	1 ... 10	1 ... 300	8	-	M3	-
16	12			10		M4	
20	16	1 ... 20		14	12	M6	M5
25			16	14	M8	M6	
32	19		1 ... 400	16	16	M10	M8
40				20	16	M12	M10
50	22	1 ... 30	1 ... 500	20	20	M10	M8
63					20	M12	M10
80		28					
100							

∅	KK	KK5	T3	T4	WH	ZB
[mm]					+1.3	+1.2
12	M5	M6	-	1.5	4.2	39.2
16	M6	M8			4.7	39.7
20	M8	M10x1.25	2	2.6	5.5	42.5
25		M10				44.5
32	M10x1.25	M10	2.6	3.3	6	50
40		M12			6.1	51.1
50	M12x1.25	M12	3.3	4.7	8.2	53.2
63		M16			8.1	57.1
80	M16x1.5	M16	4.7	6.1	8.9	62.9
100		M20x1.5 M20			9	76

Data sheet

Dimensions – Variants

Download CAD data → www.festo.com

Q – Square piston rod

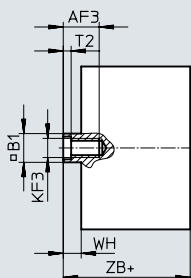
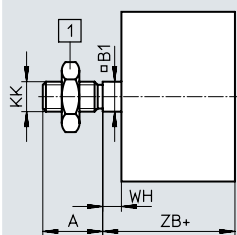

[1] Hex nut DIN 439-B
only with $\varnothing 32 \dots 100$

+ = plus stroke length
++ = plus 2x stroke length

Q – Z – Pulling

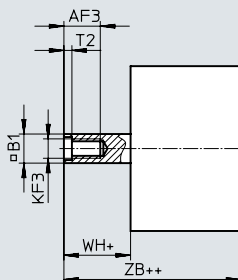
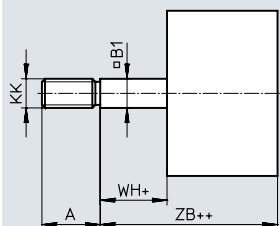

[1] Hex nut DIN 439-B
only with $\varnothing 32 \dots 100$

+ = plus stroke length

Q-K2 – Square piston rod with extended male thread

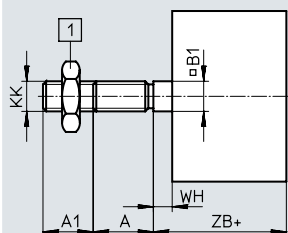

[1] Hex nut DIN 439-B
only with $\varnothing 32 \dots 100$

+ = plus stroke length

Q-K5 – Square piston rod with special thread

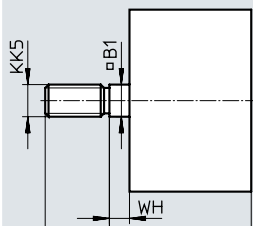

+ = plus stroke length

Q-K8 – Square, extended piston rod

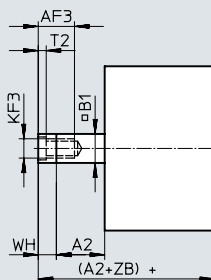
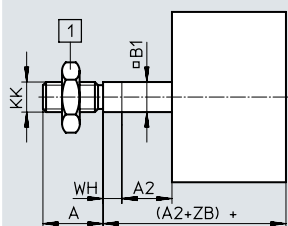

[1] Hex nut DIN 439-B
only with $\varnothing 32 \dots 100$

+ = plus stroke length

Data sheet

∅ [mm]	A -0.5	A1	A2	AF3 min.	B1 □	KF3
16	12	1 ... 10	1 ... 300	10	7	M4
20	16	1 ... 20		12	9	M5
25			1 ... 400	14	10	M6
32	16			12	M8	
40	19		1 ... 30	1 ... 500	20	16
50	22					
63	28					
80						
100						

∅ [mm]	KK	KK5	T2	WH +1.3	ZB +1.2
16	M6	M8	1.5	4.7	39.7
20	M8	M10x1.25	2	5.5	42.5
25		M10			44.5
32	M10x1.25	M10	2.6	6	50
40				6.1	51.1
50	M12x1.25	M12	3.3	8.2	53.2
63				8.1	57.1
80	M16x1.5	M16	4.7	8.9	62.9
100				9	76

Ordering data – Modular product system, basic sensor and variants

Ordering table								Conditions	Code	Enter code
Size	12	16	20	25	32					
Module no.	536414	536415	536416	536417	536418					
Function	Compact cylinder, single-acting, based on ISO 21287							AEN	AEN	
Piston ø [mm]	12	16	20	25	32		-...			
Stroke [mm]	1 ... 10	1 ... 25					-...			
Thread type	Male thread							-A		
	Female thread						[1]	-I		
Cushioning	Elastic cushioning rings/plates at both ends							-P	-P	
Position sensing	Via proximity sensor							-A	-A	
Effective direction	Single-acting, pulling							-Z		
Extended male thread [mm]	Extended male piston rod thread									
	1 ... 10		1 ... 20			[2]	-...K2			
Special piston rod thread	Male thread	M6	M8	M10x1.25 M10	M10x1.25 M10	M10 M12	[2]	-“...”K5		
	Female thread	-	-	M5	M5	M6				
Extended piston rod [mm]	Extended piston rod									
	1 ... 10	1 ... 25					-...K8			
Improved running performance	-	-	Smooth anodised aluminium piston rod				-K10			
Temperature resistance	Heat-resistant seals max. 120°C							-S6		
Captive rating plate	Laser-etched rating plate							-TL		

[1] **I** Not with extended male thread K2

[2] **K2, K5** Not with improved running performance K10

Ordering data – Modular product system, basic sensor and variants

Ordering table									
Size	40	50	63	80	100	Conditions	Code	Enter code	
Module no.	536419	536420	536421	536422	536423				
Function	Compact cylinder, single-acting, based on ISO 21287						AEN		AEN
Piston Ø [mm]	40	50	63	80	100		-...		
Stroke [mm]	1 ... 25						-...		
Thread type	Male thread						-A		
	Female thread					[1]	-I		
Cushioning	Elastic cushioning rings/plates at both ends						-P		-P
Position sensing	Via proximity sensor						-A		-A
Effective direction	Single-acting, pulling						-Z		
Extended male thread [mm]	Extended male piston rod thread			1 ... 20		1 ... 30	[2]	-...K2	
	Special piston rod thread	Male thread	M10 M12	M12 M16	M12 M16	M16 M20 M20x1.5	M16 M20 M20x1.5	[2]	-“...”K5
Female thread		M6	M8	M8	M10	M10			
Extended piston rod [mm]	Extended piston rod						-...K8		
Improved running performance	Smooth anodised aluminium piston rod						-K10		
Temperature resistance	Heat-resistant seals max. 120°C						-S6		
Captive rating plate	Laser-etched rating plate						-TL		

[1] **I** Not with extended male thread K2

[2] **K2, K5** Not with improved running performance K10

Ordering data – Modular product system, Q – Square piston rod, non-rotating

Ordering table							
Size	16	20	25	32	Conditions	Code	Enter code
Module no.	536415	536416	536417	536418			
Function	Compact cylinder, single-acting, based on ISO 21287					AEN	AEN
Piston ø [mm]	16	20	25	32		-...	
Stroke [mm]	1 ... 25					-...	
Thread type	Male thread					-A	
	Female thread				[1]	-I	
Cushioning	Elastic cushioning rings/plates at both ends					-P	-P
Position sensing	Via proximity sensor					-A	-A
Effective direction	Single-acting, pulling					-Z	
Protection against rotation	Square piston rod					-Q	-Q
Extended male thread [mm]	Extended male piston rod thread						
	1 ... 10	1 ... 20				-...K2	
Special piston rod thread Male thread	M8	M10x1.25 M10	M10x1.25 M10	M10		-“...”K5	
Extended piston rod [mm]	Extended piston rod						
	1 ... 25					-...K8	
Temperature resistance	Heat-resistant seals max. 120°C					-S6	
Captive rating plate	Laser-etched rating plate					-TL	

[1] | Not with extended male thread K2

Ordering data – Modular product system, Q – Square piston rod, non-rotating

Ordering table								
Size	40	50	63	80	100	Conditions	Code	Enter code
Module no.	536419	536420	536421	536422	536423			
Function	Compact cylinder, single-acting, based on ISO 21287						AEN	AEN
Piston Ø [mm]	40	50	63	80	100		-...	
Stroke [mm]	1 ... 25						-...	
Thread type	Male thread						-A	
	Female thread					[1]	-I	
Cushioning	Elastic cushioning rings/plates at both ends						-P	-P
Position sensing	Via proximity sensor						-A	-A
Effective direction	Single-acting, pulling						-Z	
Protection against rotation	Square piston rod						-Q	-Q
Extended male thread [mm]	Extended male piston rod thread 1 ... 20			1 ... 30			-...K2	
Special piston rod thread Male thread	M10	M12	M12	M16	M16		-“...”K5	
Extended piston rod [mm]	Extended piston rod 1 ... 25						-...K8	
Temperature resistance	Heat-resistant seals max. 120°C						-S6	
Captive rating plate	Laser-etched rating plate						-TL	

[1] | Not with extended male thread K2

Accessories

Foot mounting HNA/HNA-...-R3

Material:

HNA: galvanised steel
 HNA-...-R3: steel,
 with protective coating
 Free of copper and PTFE
 RoHS-compliant

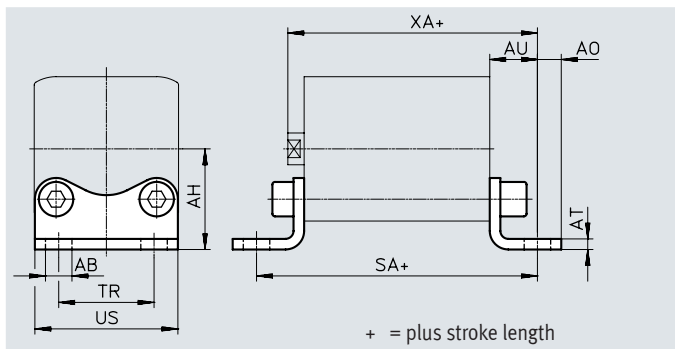

Dimensions and ordering data

For \varnothing [mm]	AB \varnothing H14	AH JS14	AO	AT ± 0.5	AU ± 0.2	SA	TR ± 0.2	US -0.5	XA
12	5.8	21	5	3	13	61	16	26	52.2
16		22	4.75				18	27.5	
20	7	27	6.25	4	16	69	22	34.5	58.7
25		29				38.5	60.7		
32		33.5	7			46	66.2		
40	10	38	9	5	18	81	36	54	69.2
50		45	8		21	87	45	64	74.2
63		50			91	50	75	78.2	
80	12	63	10.5	6	26	106	63	93	89
100	14.5	74	12.5		27	121	75	110	103

For \varnothing [mm]	Basic version				R3 – High corrosion protection			
	CRC ¹⁾	Weight [g]	Part no.	Type	CRC ¹⁾	Weight [g]	Part no.	Type
12	1	39	537237	HNA-12	3	39	537252	HNA-12-R3
16	1	42	537238	HNA-16	3	42	537253	HNA-16-R3
20	1	84	537239	HNA-20	3	84	537254	HNA-20-R3
25	1	90	537240	HNA-25	3	90	537255	HNA-25-R3
32	1	123	537241	HNA-32	3	123	537256	HNA-32-R3
40	1	157	537242	HNA-40	3	157	537257	HNA-40-R3
50	1	278	537243	HNA-50	3	278	537258	HNA-50-R3
63	1	328	537244	HNA-63	3	328	537259	HNA-63-R3
80	1	634	537249	HNA-80	3	634	537260	HNA-80-R3
100	1	814	537250	HNA-100	3	814	537261	HNA-100-R3

1) Corrosion resistance class CRC 1 to Festo standard FN 940070

Low corrosion stress. Dry indoor application or transport and storage protection. Also applies to parts behind coverings, in the non-visible interior area, and parts which are covered in the application (e.g. drive trunnions).
 Corrosion resistance class CRC 3 to Festo standard FN 940070

High corrosion stress. Outdoor exposure under moderate corrosive conditions. Externally visible parts with primarily functional surface requirements which are in direct contact with a normal industrial environment.

Accessories

Flange mounting FNC

Material:
Galvanised steel
Free of copper and PTFE
RoHS-compliant

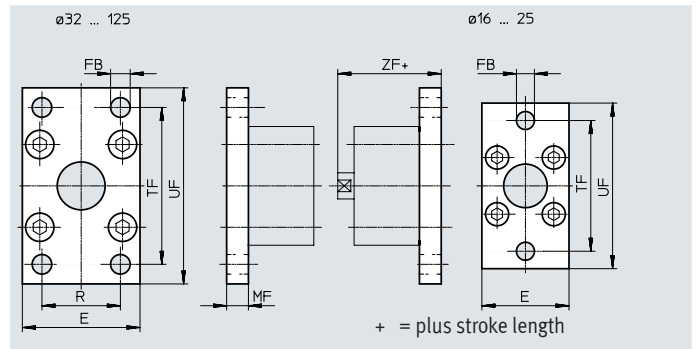

Dimensions and ordering data

For \varnothing [mm]	E	FB \varnothing	MF	R	TF	UF ± 1	ZF	CRC ¹⁾	Weight [g]	Part no.	Type
12	28	5.5	8	-	40	50	47.2	1	79	537245	FNC-12
16	29				43	55	47.9	1	88	537246	FNC-16
20	36	55			70	50.7	1	141	537247	FNC-20	
25	40	60			76	52.7	1	165	537248	FNC-25	
32	45	7	10	32	64	80	60.2	1	221	★ 174376	FNC-32
40	54	36		72	90	61.2	1	291	★ 174377	FNC-40	
50	65	9	12	45	90	110	65.2	1	536	★ 174378	FNC-50
63	75			50	100	120	69.2	1	679	★ 174379	FNC-63
80	93	12	16	63	126	150	79	1	1495	★ 174380	FNC-80
100	110	14		75	150	175	92	1	2041	174381	FNC-100
125	132	16	20	90	180	210	112	1	3775	174382	FNC-125

1) Corrosion resistance class CRC 1 to Festo standard FN 940070

Low corrosion stress. Dry indoor application or transport and storage protection. Also applies to parts behind coverings, in the non-visible interior area, and parts which are covered in the application (e.g. drive trunnions).

Accessories

Swivel flange

SNCL/SNCL-...-R3

Material:

SNCL 12 ... 25:

Wrought aluminium alloy

SNCL 32 ... 125:

Die-cast aluminium

SNCL-...-R3: wrought aluminium alloy

with protective coating

Free of copper and PTFE

RoHS-compliant

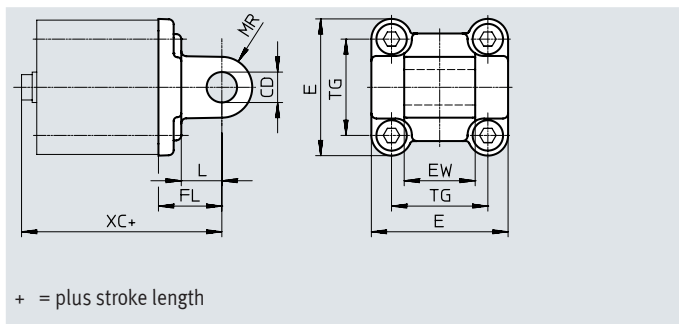

+ = plus stroke length

Dimensions and ordering data

For \varnothing [mm]	CD \varnothing H9	E	EW	FL ± 0.2	L	MR	TG	XC
12	6	25 _{-0.6}	12 _{h12}	16	10	6	16	55.2
16		27.5 _{-0.6}					18	
20	8	34.5 _{-0.6}	16 _{h12}	20	14	8	22	62.7
25		38.5 _{-0.6}					26	
32	10	45 _{+0.2/-0.5}	26 _{-0.2/-0.6}	22	13	10	32.5	72.2
40	12	54 _{-0.5}	28 _{-0.2/-0.6}	25	16	12	38	75.2
50		64 _{-0.6}	32 _{-0.2/-0.6}	27			46.5	
63	16	75 _{-0.6}	40 _{-0.2/-0.6}	32	21	16	56.5	89.2
80		93 _{-0.8}	50 _{-0.2/-0.6}	36			72	
100	20	110 _{+0.3/-0.8}	60 _{-0.2/-0.6}	41	27	20	89	117
125	25	131 _{-0.8}	70 _{-0.2/-0.6}	50	30	25	110	142

For \varnothing [mm]	Basic version				R3 – High corrosion protection			
	CRC ¹⁾	Weight [g]	Part no.	Type	CRC ¹⁾	Weight [g]	Part no.	Type
12	2	20	537790	SNCL-12	3	20	537794	SNCL-12-R3
16	2	21	537791	SNCL-16	3	21	537795	SNCL-16-R3
20	2	38	537792	SNCL-20	3	38	537796	SNCL-20-R3
25	2	41	537793	SNCL-25	3	41	537797	SNCL-25-R3
32	1	71	★ 174404	SNCL-32	–	–	–	–
40	1	95	★ 174405	SNCL-40	–	–	–	–
50	1	158	★ 174406	SNCL-50	–	–	–	–
63	1	225	★ 174407	SNCL-63	–	–	–	–
80	1	436	★ 174408	SNCL-80	–	–	–	–
100	1	606	174409	SNCL-100	–	–	–	–
125	1	1135	174410	SNCL-125	–	–	–	–

1) Corrosion resistance class CRC 1 to Festo standard FN 940070

Low corrosion stress. Dry indoor application or transport and storage protection. Also applies to parts behind coverings, in the non-visible interior area, and parts which are covered in the application (e.g. drive trunnions).

Corrosion resistance class CRC 2 to Festo standard FN 940070

Moderate corrosion stress. Indoor applications in which condensation can occur. External visible parts with primarily decorative surface requirements which are in direct contact with a normal industrial environment.

Corrosion resistance class CRC 3 to Festo standard FN 940070

High corrosion stress. Outdoor exposure under moderate corrosive conditions. Externally visible parts with primarily functional surface requirements which are in direct contact with a normal industrial environment.

Accessories

Swivel flange

SNCS/CRSNCS/SNCS-...-R3

Material:

SNCS 32 ... 50: Die-cast aluminium

SNCS 63 ... 125: Wrought aluminium alloy

CRSNCS 32 ... 80:

High-alloy stainless steel

SNCS-...-R3 100 ... 125:

Wrought aluminium alloy with protective coating

RoHS-compliant

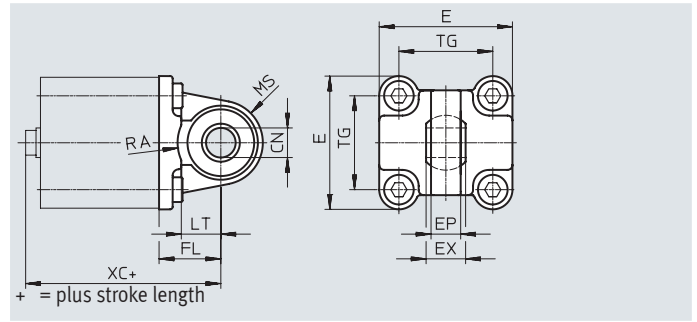
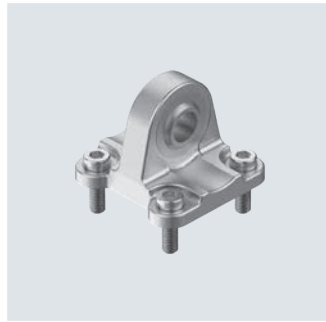

Dimensions and ordering data

For \varnothing [mm]	CN \varnothing		E		EP ± 0.2	EX	FL ± 0.2
	ADN-...	ADN-...-R3	ADN-...	ADN-...-R3			
32	10 ^{+0.013}	10+0.015/-0.04	45+0.2/-0.5	45 _{-0.5}	10.5	14	22
40	12 ^{+0.015}	12+0.018/-0.04	54 _{-0.5}	54 _{-0.5}	12	16	25
50	16 ^{+0.015}	16+0.018/-0.04	64 _{-0.6}	64 _{-0.6}	15	21	27
63	16 ^{+0.015}	16+0.018/-0.04	74.5 ± 0.5	75 _{-0.6}	15	21	32
80	20 ^{+0.018}	20+0.021/-0.04	92.2 ± 0.8	93 _{-0.8}	18	25	36
100	20 ^{+0.018}	20+0.021/-0.04	109+1/-0.7	109+1/-0.7	18	25	41
125	30 ^{+0.018}	30+0.021/-0.04	132+1/-0.7	132+1/-0.7	25	37	50

For \varnothing [mm]	LT	MS		RA		TG	XC
		ADN-...	ADN-...-R3	ADN-... +1	ADN-...-R3 +1		
32	13	15 ^{+0.5}	15 ^{+0.5}	14.5	14.5	32.5	72.2
40	16	17 ^{+0.5}	17 ^{+0.5}	17.5	17.5	38	75.2
50	16	20 ^{+0.5}	20 ^{+0.5}	18.5	19	46.5	80.2
63	21	23 _{-0.5}	22 ^{+0.5}	23	23	56.5	89.2
80	22	28 _{-0.5}	27 ^{+0.5}	25	25	72	99
100	27	30 ± 0.5	30 ± 0.5	95	100	89	117
125	30	39 ± 0.5	39 ± 0.5	100	100	110	142

For \varnothing [mm]	Basic version				High corrosion protection			
	CRC ¹⁾	Weight [g]	Part no.	Type	CRC ¹⁾	Weight [g]	Part no.	Type
32	1	86	★ 174397	SNCS-32	4	161	2895920	CRSNCS-32
40	1	122	★ 174398	SNCS-40	4	239	2895921	CRSNCS-40
50	1	216	★ 174399	SNCS-50	4	403	2895922	CRSNCS-50
63	2	281	★ 174400	SNCS-63	4	576	2895923	CRSNCS-63
80	2	557	★ 174401	SNCS-80	4	1173	2895924	CRSNCS-80
100	2	683	174402	SNCS-100	3	684	2895925	SNCS-100-R3
125	2	1369	174403	SNCS-125	3	1369	2895926	SNCS-125-R3

1) Corrosion resistance class CRC 1 to Festo standard FN 940070

Low corrosion stress. Dry indoor application or transport and storage protection. Also applies to parts behind coverings, in the non-visible interior area, and parts which are covered in the application (e.g. drive trunnions).

Corrosion resistance class CRC 2 to Festo standard FN 940070

Moderate corrosion stress. Indoor applications in which condensation can occur. External visible parts with primarily decorative surface requirements which are in direct contact with a normal industrial environment.

Corrosion resistance class CRC 3 to Festo standard FN 940070

High corrosion stress. Outdoor exposure under moderate corrosive conditions. Externally visible parts with primarily functional surface requirements which are in direct contact with a normal industrial environment.

Corrosion resistance class CRC 4 to Festo standard FN 940070

Particularly high corrosion stress. Outdoor exposure under extreme corrosive conditions. Parts exposed to aggressive media, e.g. in the chemical or food industries. Such applications may need to be safeguarded by means of special testing (→ also FN 940082), using appropriate media.

Accessories

Clevis foot LBG/LBG- ...-R3

The pivot pin is secured against rotation with a spring pin.

Material:

LBG 32 ... 63: Stainless steel casting

LBG 80 ... 125: Spheroidal graphite cast iron

LBG-...-R3: High-alloy stainless steel

Free of copper and PTFE

RoHS-compliant

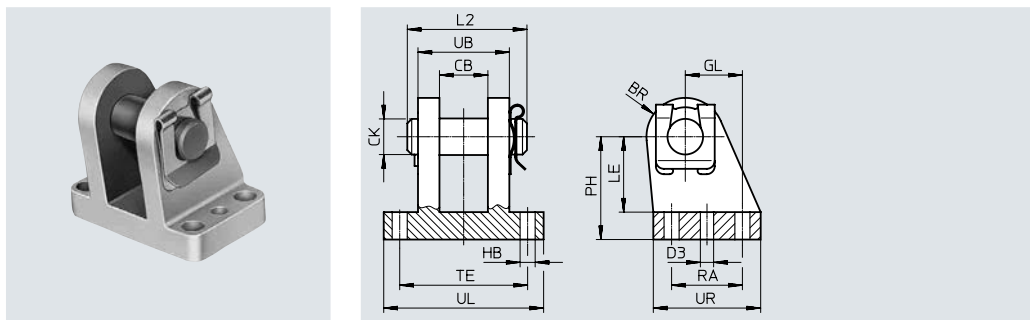

Dimensions and ordering data

For \varnothing [mm]	BR		CB	CK \varnothing	D3 \varnothing	GL	HB \varnothing	L2	LE	PH	RA	TE	UB	UL	UR
		ADN-...-R3													
32	12	12	14.1	10	4.8	16	6.8	35	24	32	20	42	28	56	36
40	14	14	16.1	12	5.8	20	6.8	39	26	36	26	44	30	58	41.5
50	15	15	21.1	16	5.8	25	9.2	50	33	45	31	56	40	70	47
63	17	17	21.1	16	7.8	25	9.2	50	38	50	31	56	40	70	49
80	17	17	25.1	20	7.8	30	11	60	49	63	36	70	50	89	55
100	20	22	25.1	20	9.8	41	11	60	56	71	46	70	50	89	65
125	25	25	37.2	30	11.8	60	14	89	70	90	70	106	80	128	96

For \varnothing [mm]	Basic version				R3 – High corrosion protection			
	CRC ¹⁾	Weight [g]	Part no.	Type	CRC ¹⁾	Weight [g]	Part no.	Type
32	2	220	31761	LBG-32	3	220	2078790	LBG-32-R3
40	2	300	31762	LBG-40	3	300	2078792	LBG-40-R3
50	2	540	31763	LBG-50	3	540	2078794	LBG-50-R3
63	2	580	31764	LBG-63	3	580	2078795	LBG-63-R3
80	2	1050	31765	LBG-80	3	1050	2078797	LBG-80-R3
100	2	1375	31766	LBG-100	3	1375	2078799	LBG-100-R3
125	2	4140	31767	LBG-125	3	4140	2078837	LBG-125-R3

1) Corrosion resistance class CRC 2 to Festo standard FN 940070

Moderate corrosion stress. Indoor applications in which condensation can occur. External visible parts with primarily decorative surface requirements which are in direct contact with a normal industrial environment.

Corrosion resistance class CRC 3 to Festo standard FN 940070

High corrosion stress. Outdoor exposure under moderate corrosive conditions. Externally visible parts with primarily functional surface requirements which are in direct contact with a normal industrial environment.

Accessories

Multi-position kit DPNA

Material:

Flange:

Wrought aluminium alloy

Screws: Galvanised steel

Free of copper and PTFE

RoHS-compliant

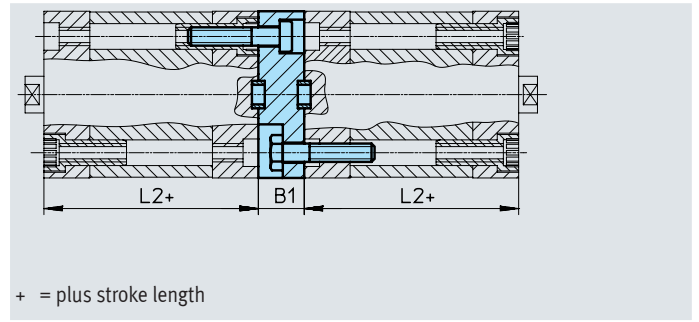

Dimensions and ordering data

For \varnothing [mm]	L2	B1	Max. overall stroke length [mm]	CRC ¹⁾	Weight [g]	Part no.	Type ¹⁾
12	35	13	600	2	28	537263	DPNA-12
16					33	537264	DPNA-16
20					50	537265	DPNA-20
25					60	537266	DPNA-25
32	45	15	800		99	537267	DPNA-32
40					129	537268	DPNA-40
50					16	537269	DPNA-50
63	54	17	1000		249	537270	DPNA-63
80					474	537271	DPNA-80
100					67	19.5	537272

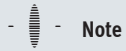

Note

The maximum overall stroke length must not be exceeded when combining cylinders and multi-position kits.

1) Corrosion resistance class CRC 2 to Festo standard FN 940070

Moderate corrosion stress. Indoor applications in which condensation can occur. External visible parts with primarily decorative surface requirements which are in direct contact with a normal industrial environment.

Accessories

Clevis foot LBN

Material:
Galvanised steel
Free of copper and PTFE
RoHS-compliant

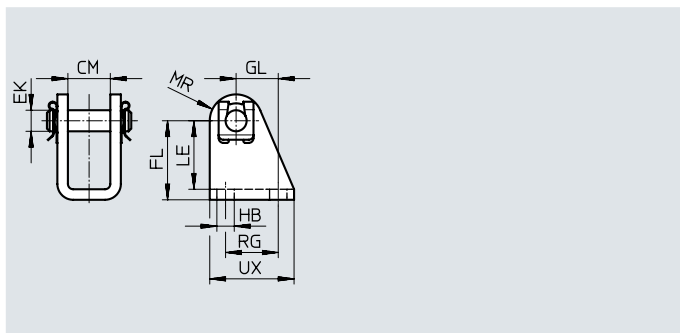

Dimensions and ordering data

For \varnothing	CM	EK \varnothing	FL	GL	HB \varnothing	LE	MR	RG	UX	CRC ¹⁾	Weight [g]	Part no.	Type
12/16	12.1	6	27 +0.3/-0.2	13	5.5	24	7	15	25	1	40	★ 6058	LBN-12/16
20/25	16.1	8	30 +0.4/-0.2	16	6.6	26	10	20	32	1	84	★ 6059	LBN-20/25

1) Corrosion resistance class CRC 1 to Festo standard FN 940070

Low corrosion stress. Dry indoor application or transport and storage protection. Also applies to parts behind coverings, in the non-visible interior area, and parts which are covered in the application (e.g. drive trunnions).

Clevis foot CRLBN, stainless steel

Material:
High-alloy steel
Free of copper and PTFE
RoHS-compliant

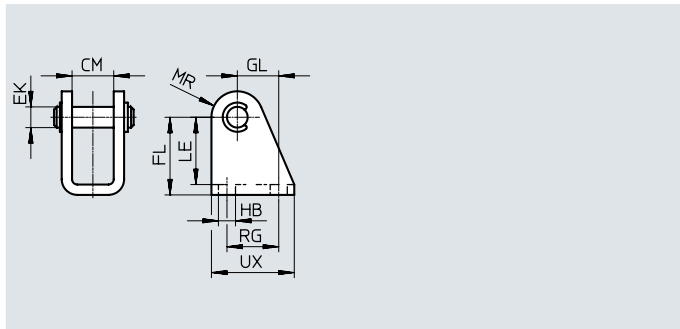
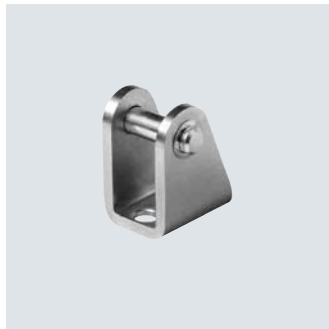

Dimensions and ordering data

For \varnothing	CM	EK \varnothing	FL	GL	HB	LE	MR	RG	UX	CRC ¹⁾	Weight [g]	Part no.	Type
12/16	12.1	6	27 +0.3/-0.2	13	5.5	24	7	15	25	4	39	161862	CRLBN-12/16
20/25	16.1	8	30 +0.4/-0.2	16	6.6	26	10	20	32	4	82	161863	CRLBN-20/25

1) Corrosion resistance class CRC 4 to Festo standard FN 940070

Particularly high corrosion stress. Outdoor exposure under extreme corrosive conditions. Parts exposed to aggressive media, e.g. in the chemical or food industries. Such applications may need to be safeguarded by means of special testing (→ also FN 940082), using appropriate media.

Accessories

Swivel flange SNCB/SNCB-...-R3

Material:
 SNCB: Die-cast aluminium
 SNCB-...-R3: Die-cast aluminium with
 protective coating
 Free of copper and PTFE
 RoHS-compliant

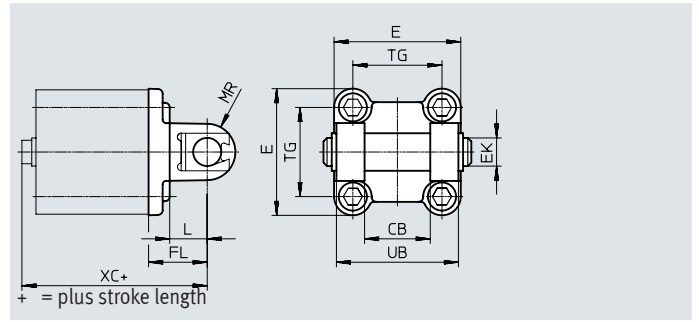
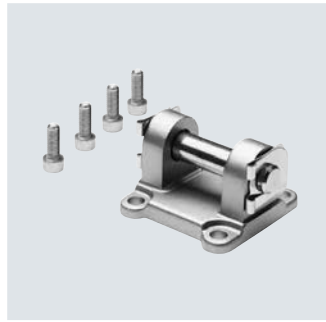

Dimensions and ordering data

For \varnothing	CB	E	EK \varnothing H9/e8	FL	L	MR	TG	UB	XC
[mm]	H14			± 0.2		-0.5		h14	
32	26	$45+0.2/-0.5$	10	22	13	8.5	32.5	45	72
40	28	$54_{-0.5}$	12	25	16	12	38	52	76
50	32	$64_{-0.6}$	12	27	16	12	46.5	60	80
63	40	$75_{-0.6}$	16	32	21	16	56.5	70	89
80	50	$93_{-0.8}$	16	36	22	16	72	90	99
100	60	$110+0.3/-0.8$	20	41	27	20	89	110	117
125	70	$131_{-0.8}$	25	50	30	25	110	130	142

For \varnothing	Basic version				R3 – High corrosion protection			
	CRC ¹⁾	Weight [g]	Part no.	Type	CRC ¹⁾	Weight [g]	Part no.	Type
32	1	103	★ 174390	SNCB-32	3	100	176944	SNCB-32-R3
40	1	155	★ 174391	SNCB-40	3	151	176945	SNCB-40-R3
50	1	233	★ 174392	SNCB-50	3	228	176946	SNCB-50-R3
63	1	375	★ 174393	SNCB-63	3	371	176947	SNCB-63-R3
80	1	636	★ 174394	SNCB-80	3	632	176948	SNCB-80-R3
100	1	1035	★ 174395	SNCB-100	3	986	176949	SNCB-100-R3
125	1	1860	★ 174396	SNCB-125	3	1776	176950	SNCB-125-R3

1) Corrosion resistance class CRC 1 to Festo standard FN 940070

Low corrosion stress. Dry indoor application or transport and storage protection. Also applies to parts behind coverings, in the non-visible interior area, and parts which are covered in the application (e.g. drive trunnions).
 Corrosion resistance class CRC 3 to Festo standard FN 940070

High corrosion stress. Outdoor exposure under moderate corrosive conditions. Externally visible parts with primarily functional surface requirements which are in direct contact with a normal industrial environment.

Accessories

Trunnion flange ZNCF/CRZNG

Material:

ZNCF: Stainless steel casting

CRZNG: Electropolished stainless steel casting

Free of copper and PTFE

RoHS-compliant

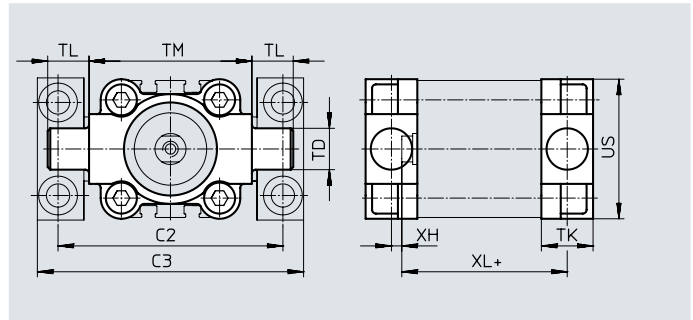

Dimensions and ordering data

For \varnothing [mm]	C2	C3	TD \varnothing e9	TK	TL	TM	US	XH	XL
32	71	86	12	16	12	50	45	2	58
40	87	105	16	20	16	63	54	4	61.1
50	99	117	16	24	16	75	64	4	64.7
63	116	136	20	24	20	90	75	4	68.5
80	136	156	20	28	20	110	93	5	76.9
100	164	189	25	38	25	132	110	10	95
125	192	217	25	50	25	160	131	14	117

For \varnothing [mm]	Basic version				R3 – High corrosion protection			
	CRC ¹⁾	Weight [g]	Part no.	Type	CRC ¹⁾	Weight [g]	Part no.	Type
32	2	150	174411	ZNCF-32	4	150	161852	CRZNG-32
40	2	285	174412	ZNCF-40	4	285	161853	CRZNG-40
50	2	473	174413	ZNCF-50	4	473	161854	CRZNG-50
63	2	687	174414	ZNCF-63	4	687	161855	CRZNG-63
80	2	1296	174415	ZNCF-80	4	1296	161856	CRZNG-80
100	2	2254	174416	ZNCF-100	4	2254	161857	CRZNG-100
125	2	3484	174417	ZNCF-125	4	3484	185362	CRZNG-125

1) Corrosion resistance class CRC 2 to Festo standard FN 940070

Moderate corrosion stress. Indoor applications in which condensation can occur. External visible parts with primarily decorative surface requirements which are in direct contact with a normal industrial environment.

Corrosion resistance class CRC 4 to Festo standard FN 940070

Particularly high corrosion stress. Outdoor exposure under extreme corrosive conditions. Parts exposed to aggressive media, e.g. in the chemical or food industries. Such applications may need to be safeguarded by means of special testing (→ also FN 940082), using appropriate media.

Accessories

Trunnion support LNZG

Material:

Trunnion support: Anodised aluminium

Plain bearing: Plastic

Free of copper and PTFE

RoHS-compliant

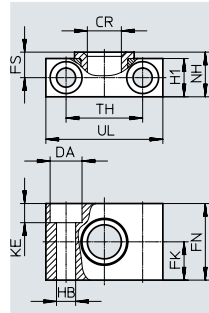
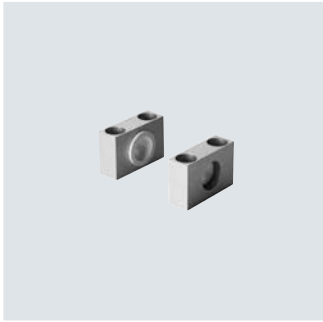

Dimensions and ordering data														Part no.	Type
For \varnothing	CR	DA	FK	FN	FS	H1	HB	KE	NH	TH	UL	CRC ¹⁾	Weight		
[mm]	\varnothing	\varnothing	\varnothing				\varnothing			± 0.2			[g]		
32	12	11	15	30	10.5	15	6.6	6.8	18	32	46	2	83	32959	LNZG-32
40, 50	16	15	18	36	12	18	9	9	21	36	55	2	129	32960	LNZG-40/50
63, 80	20	18	20	40	13	20	11	11	23	42	65	2	178	32961	LNZG-63/80
100, 125	25	20	25	50	16	24.5	14	13	28.5	50	75	2	306	32962	LNZG-100/125

1) Corrosion resistance class CRC 2 to Festo standard FN 940070

Moderate corrosion stress. Indoor applications in which condensation can occur. External visible parts with primarily decorative surface requirements which are in direct contact with a normal industrial environment.

Accessories

Ordering data – Piston rod attachments

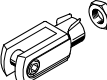
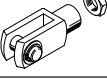
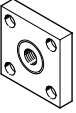
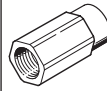
Designation	For ø	Part no.	Type
Rod eye SGS			
	16	★ 9254	SGS-M6
	20, 25	★ 9255	SGS-M8
	32, 40	★ 9261	SGS-M10x1.25
	50, 63	★ 9262	SGS-M12x1.25
	80, 100	★ 9263	SGS-M16x1.5
	125	★ 9264	SGS-M20x1.5
	Rod clevis SG		
	12	–	
	16	★ 3110	SG-M6
	20, 25	★ 3111	SG-M8
	32, 40	★ 6144	SG-M10x1.25
	50, 63	★ 6145	SG-M12x1.25
	80, 100	★ 6146	SG-M16x1.5
	125	★ 6147	SG-M20x1.5
	Coupling piece KSG		
	12, 16, 20, 25	–	
	32, 40	32963	KSG-M10x1.25
	50, 63	32964	KSG-M12x1.25
	80, 100	32965	KSG-M16x1.5
	125	32966	KSG-M20x1.5
Adapter AD			
	12	–	
	16	157328	AD-M6-M5
		157329	AD-M6-1/8
		157330	AD-M6-1/4
	20	157331	AD-M8-1/8
	25	157332	AD-M8-1/4
	32	157333	AD-M10x1.25-1/8
	40	157334	AD-M10x1.25-1/4
	50	160256	AD-M12x1.25-1/4
	63	160257	AD-M12x1.25-3/8

Data sheets → Internet: piston rod attachment

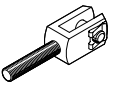
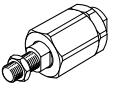
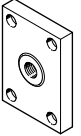
Designation	For ø	Part no.	Type
Rod clevis SGA for rod eye SGS			
	12, 16, 20, 25	–	
	32, 40	32954	SGA-M10x1.25
	50, 63	10767	SGA-M12x1.25
	80, 100	10768	SGA-M16x1.25
	125	10769	SGA-M20x1.25
	Self-aligning rod coupler FK		
	12	30984	FK-M5
	16	★ 2061	FK-M6
	20, 25	★ 2062	FK-M8
	32, 40	★ 6140	FK-M10x1.25
	50, 63	★ 6141	FK-M12x1.25
	80, 100	★ 6142	FK-M16x1.5
	125	★ 6143	FK-M20x1.5
	Coupling piece KSZ		
	12	–	
	16	36123	KSZ-M6
	20, 25	36124	KSZ-M8
	32, 40	36125	KSZ-M10x1.25
	50, 63	36126	KSZ-M12x1.25
	80, 100	36127	KSZ-M16x1.5
	125	36128	KSZ-M20x1.5

Accessories

Ordering data – Piston rod attachments, corrosion-resistant

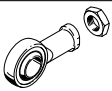
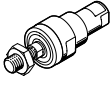
Designation	For \varnothing	Part no.	Type
Rod eye CRSGS			
	12	–	
	16	195580	CRSGS-M6
	20, 25	195581	CRSGS-M8
	32, 40	195582	CRSGS-M10x1.25
	50, 63	195583	CRSGS-M12x1.25
	80, 100	195584	CRSGS-M16x1.5
	125	195585	CRSGS-M20x1.5
Self-aligning rod coupler CRFK			
	32, 40	2305778	CRFK-M10x1.25
	50, 63	2305779	CRFK-M12x1.25
	80, 100	2490673	CRFK-M16x1.5
	125	2545677	CRFK-M20x1.5

Data sheets → Internet: piston rod attachment

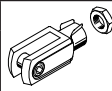
Designation	For \varnothing	Part no.	Type
Rod clevis CRSG			
	12	–	
	16, 20	13567	CRSG-M6
	20, 25	13568	CRSG-M8
	32, 40	13569	CRSG-M10x1.25
	50, 63	13570	CRSG-M12x1.25
	80, 100	13571	CRSG-M16x1.5
	125	13572	CRSG-M20x1.5

Ordering data – Mounting components

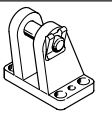
Designation	For \varnothing	Part no.	Type
Right-angle clevis foot LQG for rod eye SGS			
	32, 40	31761	LBG-32
	50, 63	31762	LBG-40
	80, 100	31763	LBG-50
		31764	LBG-63
	125	31765	LBG-80
		31766	LBG-100

Data sheets → Internet: clevis foot

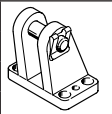
Designation	For \varnothing	Part no.	Type
Right-angle clevis foot LQG for rod eye SGS			
	32, 40	31768	LQG-32
	50, 63	31769	LQG-40
	80, 100	31770	LQG-50
		31771	LQG-63
	125	31772	LQG-80
		31773	LQG-100

Ordering data – Mounting components, high corrosion protection

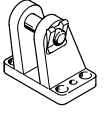
Designation	For \varnothing	Part no.	Type
Clevis foot LBG-R3 for rod eye CRSGS			
	32, 40	2078790	LBG-32-R3
	50, 63	2078792	LBG-40-R3
	80, 100	2078794	LBG-50-R3
		2078795	LBG-63-R3
	125	2078797	LBG-80-R3
	2078799	LBG-100-R3	

Data sheets → Internet: clevis foot

Ordering data – One-way flow control valves

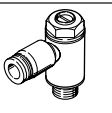
Connection	For \varnothing	For tubing O.D.	Material	Part no. Type	
				Part no.	Type
For exhaust air					
	12, 16, 20, 25	3	Metal design	★ 193137	GRLA-M5-QS-3-D
		4		★ 193138	GRLA-M5-QS-4-D
		6		★ 193139	GRLA-M5-QS-6-D
	32, 40, 50, 63, 80, 100	3		★ 193142	GRLA-1/8-QS-3-D
		4		★ 193143	GRLA-1/8-QS-4-D
		6		★ 193144	GRLA-1/8-QS-6-D
		8		★ 193145	GRLA-1/8-QS-8-D
	125	6		★ 193146	GRLA-1/4-QS-6-D
		8		★ 193147	GRLA-1/4-QS-8-D
		10		★ 193148	GRLA-1/4-QS-10-D

Data sheets → Internet: grla

Accessories



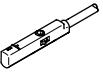
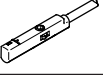

Ordering data – One-way flow control valves					Data sheets → Internet: grlz	
	Connection		Material	Part no.	Type	
	For ø	For tubing O.D.				
For supply air						
	12, 16, 20, 25	3	Metal design	★ 193153	GRLZ-M5-QS-3-D	
		4		★ 193154	GRLZ-M5-QS-4-D	
		6		★ 193155	GRLZ-M5-QS-6-D	
	32, 40, 50, 63, 80, 100	3		★ 193156	GRLZ-1/8-QS-3-D	
		4		★ 193157	GRLZ-1/8-QS-4-D	
		6		★ 193158	GRLZ-1/8-QS-6-D	
		8		★ 193159	GRLZ-1/8-QS-8-D	
	125	–		151195	GRLZ-1/4-B	

Ordering data – One-way flow control valves for cylinders ADN and ADN					Data sheets → Internet: grla	
	Connection		Material	Part no.	Type	
	For ø	For tubing O.D.				
For exhaust air						
	25, 40	3	Metal design	193137	GRLA-M5-QS-3-D	
		4		193138	GRLA-M5-QS-4-D	
	63, 100	4		193143	GRLA-1/8-QS-4-D	
		6		193144	GRLA-1/8-QS-6-D	
		8		193145	GRLA-1/8-QS-8-D	

Ordering data – Proximity sensors for T-slot, magneto-resistive						Data sheets → Internet: smt	
	Type of mounting	Switching output	Electrical connection	Cable length [m]	Part no.	Type	
	Insertable in the slot from above, flush with the cylinder profile, short design	PNP	Cable, 3-wire	2.5	★ 574335	SMT-8M-A-PS-24V-E-2.5-OE	
			Plug M8x1, 3-pin	0.3	★ 574334	SMT-8M-A-PS-24V-E-0.3-M8D	
			Plug M12x1, 3-pin	0.3	★ 574337	SMT-8M-A-PS-24V-E-0.3-M12	
		NPN	Cable, 3-wire	2.5	★ 574338	SMT-8M-A-NS-24V-E-2.5-OE	
			Plug M8x1, 3-pin	0.3	★ 574339	SMT-8M-A-NS-24V-E-0.3-M8D	
N/C contact							
	Insertable in the slot from above, flush with the cylinder profile, short design	PNP	Cable, 3-wire	7.5	★ 574340	SMT-8M-A-PO-24V-E-7.5-OE	

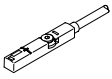
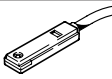
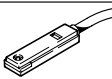
Ordering data – Proximity sensors for T-slot, magneto-resistive						Data sheets → Internet: smt	
	Type of mounting	Electrical connection, outlet direction of connection	Switching output	Cable length [m]	Part no.	Type	
	Inserted in the slot lengthwise	Cable, 3-wire, lateral	PNP	2.5	547859	SMT-8G-PS-24V-E-2,5Q-OE	
				0.3	547860	SMT-8G-PS-24V-E-0,3Q-M8D	
		Plug M8x1, 3-pin, lateral	NPN	2.5	8065028	SMT-8G-NS-24V-E-2,5Q-OE	
				0.3	8065027	SMT-8G-NS-24V-E-0,3Q-M8D	

Accessories

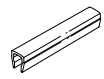
Ordering data – Proximity sensors for T-slot, magnetic reed						Data sheets → Internet: sme	
	Type of mounting	Switching output	Electrical connection	Cable length [m]	Part no.	Type	
N/O contact							
	Inserted in the slot from above, flush with the cylinder profile	Contacting	Cable, 3-wire	2.5	★ 543862	SME-8M-DS-24V-K-2.5-OE	
				5.0	★ 543863	SME-8M-DS-24V-K-5.0-OE	
			Cable, 2-wire	2.5	★ 543872	SME-8M-ZS-24V-K-2.5-OE	
			Plug M8x1, 3-pin	0.3	★ 543861	SME-8M-DS-24V-K-0.3-M8D	
	Inserted in the slot lengthwise, flush with the cylinder profile	Contacting	Cable, 3-wire	2.5	150855	SME-8-K-LED-24	
			Plug M8x1, 3-pin	0.3	150857	SME-8-S-LED-24	
N/C contact							
	Inserted in the slot lengthwise, flush with the cylinder profile	Contacting	Cable, 3-wire	7.5	160251	SME-8-0-K-LED-24	
Ordering data – Connecting cables						Data sheets → Internet: nebu	
	Electrical connection, left	Electrical connection, right	Cable length [m]	Part no.	Type		
	Straight socket, M8x1, 3-pin	Cable, open end, 3-wire	2.5	★ 541333	NEBU-M8G3-K-2.5-LE3		
			5	★ 541334	NEBU-M8G3-K-5-LE3		
	Straight socket, M12x1, 5-pin	Cable, open end, 3-wire	2.5	★ 541363	NEBU-M12G5-K-2.5-LE3		
			5	★ 541364	NEBU-M12G5-K-5-LE3		
	Angled socket, M8x1, 3-pin	Cable, open end, 3-wire	2.5	★ 541338	NEBU-M8W3-K-2.5-LE3		
			5	★ 541341	NEBU-M8W3-K-5-LE3		
	Angled socket, M12x1, 5-pin	Cable, open end, 3-wire	2.5	541367	NEBU-M12W5-K-2.5-LE3		
			5	541370	NEBU-M12W5-K-5-LE3		
Ordering data – Proximity sensor in block design, pneumatic						Data sheets → Internet: smpo	
	Pneumatic connection	Part no.	Type				
3/2-way valve, normally closed							
	Female thread M5	178563	SMPO-8E				
Ordering data – Mounting kit for proximity sensors SMPO-8E						Data sheets → Internet: smb	
	Mounting	Part no.	Type				
	Clamped in T-slot	178230	SMB-8E				
Ordering data – Slot cover for T-slot							
	Mounting	Length	Part no.	Type			
	Insertable	2x 0.5 m	151680	ABP-5-S			

Festo - Your Partner in Automation



1 Festo Inc.
5300 Explorer Drive
Mississauga, ON L4W 5G4
Canada

Festo Customer Interaction Center
Tel: 1 877 463 3786
Fax: 1 877 393 3786
Email: customer.service.ca@festo.com



2 Festo Pneumatic
Av. Ceylán 3,
Col. Tequesquináhuac
54020 Tlalnepantla,
Estado de México

Multinational Contact Center
01 800 337 8669
ventas.mexico@festo.com



3 Festo Corporation
1377 Motor Parkway
Suite 310
Islandia, NY 11749

Festo Customer Interaction Center
1 800 993 3786
1 800 963 3786
customer.service.us@festo.com



4 Regional Service Center
7777 Columbia Road
Mason, OH 45040

Connect with us



www.festo.com/socialmedia



www.festo.com

Subject to change