

Denso Hair Pin Alternators

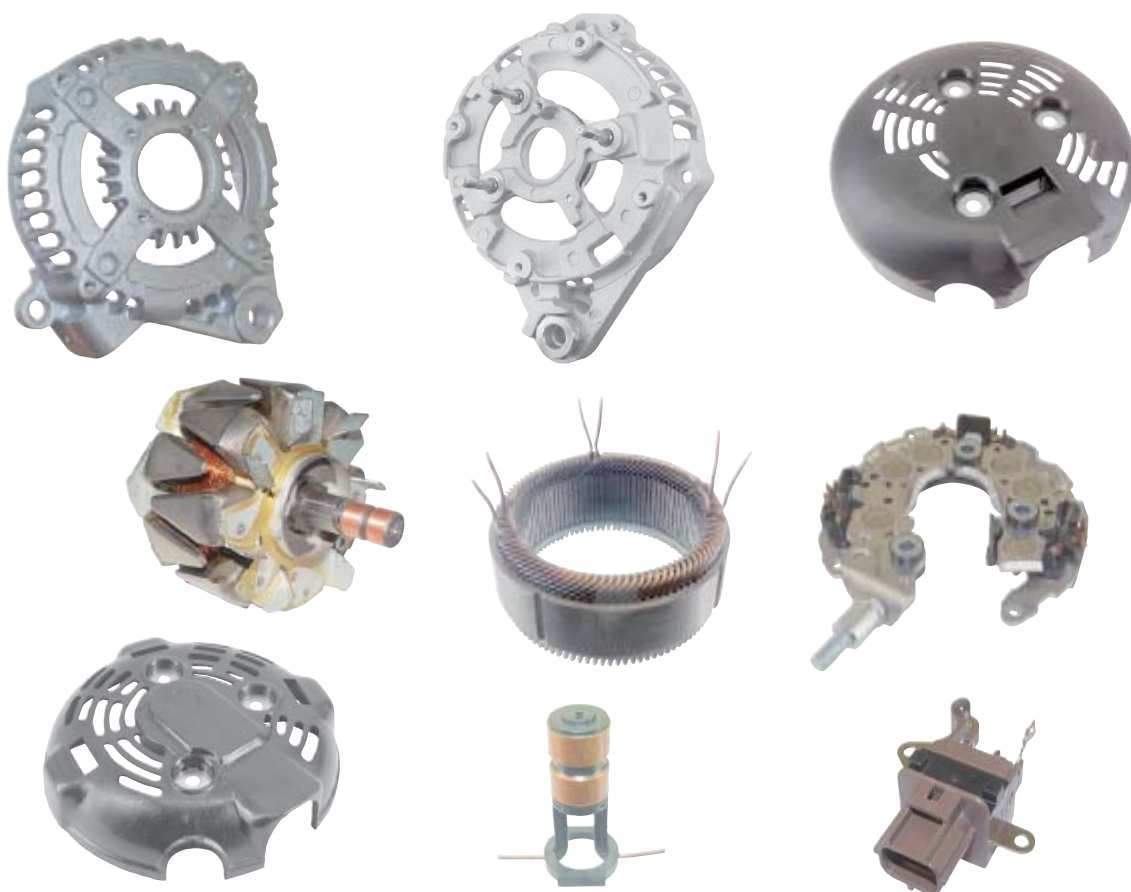

Component Parts Catalog



Metro Auto Industrial Inc.

Toll Free: 1-800-263-8761

INDEX

Denso Hair Pin Exploded View

104210 & 421000 Series

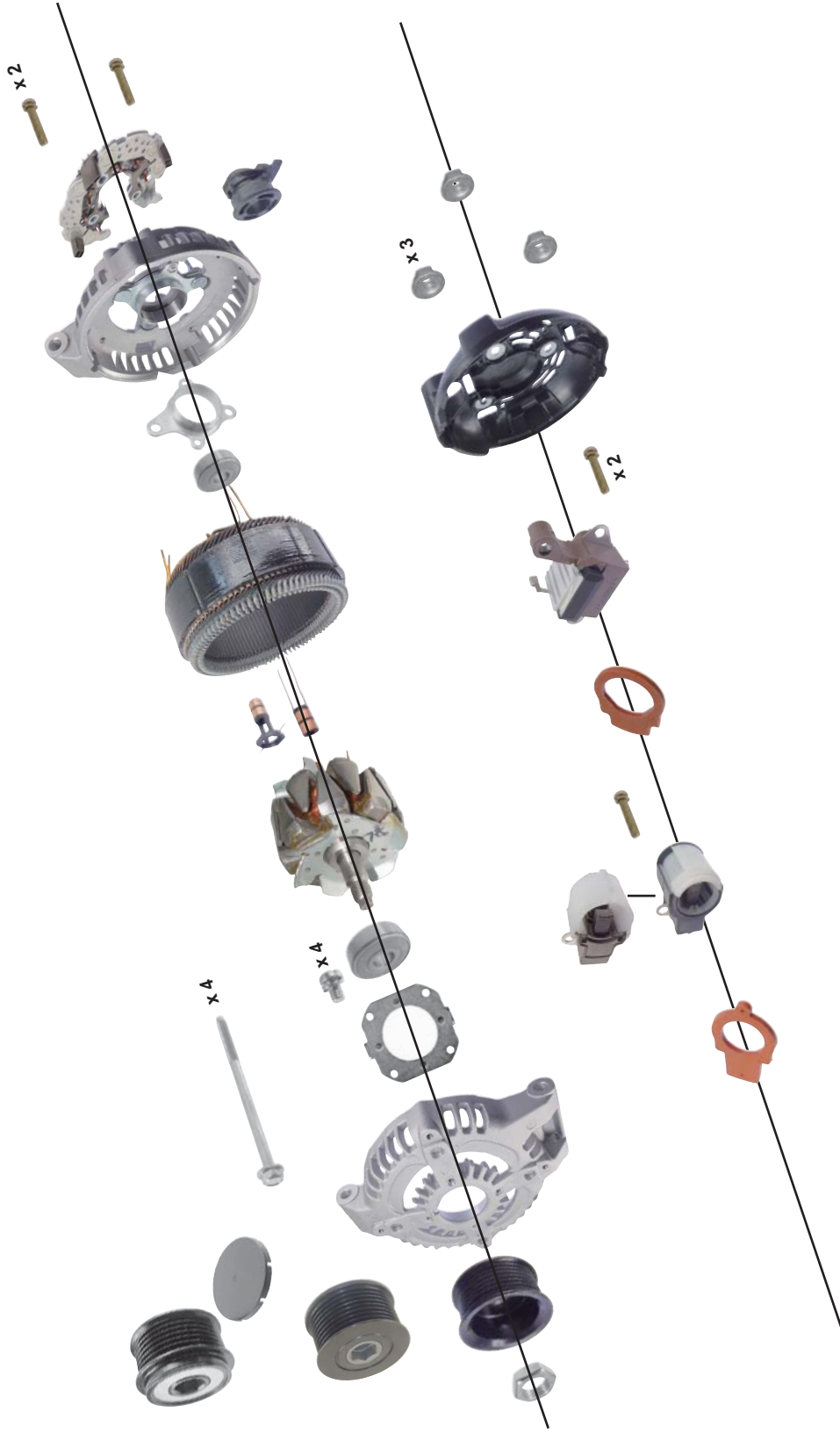

21-Drive End Housing



21-82084 DE Housing

130-160 Amp, 128.5mm Stator OD

For: Denso Hair Pin Alternators

Used on: Chrysler, Dodge

Replaces: 121400-2630,
121401-0080

OE: 104210-424, 421000-001,
421000-002, 421000-012,
421000-013, 421000-022, 421000-
049

Lester: 11114, 13870, 13871

Ref: AZ-0378

Note: Bearing use
Bearing Retainer 46-82003
Retainer Screw 84-82008



21-82086 DE Housing

100-130 Amp, 128.5mm Stator OD

For: Denso Hair Pin Alternators

Used on: Toyota Tacoma, 4Runner

Replaces: 121401-1090

OE: 104210-347, 104210-420,
104210-423, 104210-492+

Lester: 11138, 11139, 11324, 13984

Ref: AT-03280

Note: Bearing use
Bearing Retainer 46-82003
Retainer Screw 84-82008

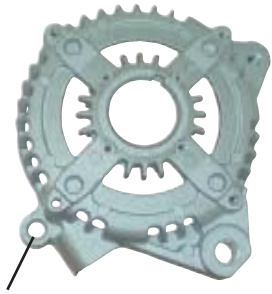

w/Ear Ring

21-82088 DE Housing

100 Amp, 128.5mm Stator OD

For: Denso Hair Pin Alternators

Used on: Toyota RAV4

Replaces: 121401-0520

OE: 104210-378, 104210-388,
104210-389, 104210-403,
104210-481

Lester: 11084, 11088, 11034, 11195,
11201

Ref: AT-03295

Note: Bearing use
Bearing Retainer 46-82003
Retainer Screw 84-82008 DE w/
Ear Ring.
wo/Ear Ring please use 21-82097.



21-82085 DE Housing

130-150 Amp, 128.5mm Stator OD

For: Denso Hair Pin Alternators

Used on: Lexus GX, Toyota 4Runner

Replaces:

OE: 104210-303, 104210-338, 104210-
339, 104210-344,
104210-346, 104210-368, 104210-451,
104210-511, 104210-512

Lester: 11087, 11090, 11153, 11198,
13983, 13992, 13994

Ref: AT-03274

Note: Bearing use
Bearing Retainer 46-82003
Retainer Screw 84-82008



21-82087 DE Housing

105 Amp, 128.5mm Stator OD

For: Denso Hair Pin Alternators

Used on: Acura, Honda

Replaces: 121401-0920

OE: 104210-329, 104210-473

Lester: 13980

Ref: AH-03113

Note: Bearing use
Bearing Retainer 46-82003
Retainer Screw 84-82008



21-82089 DE Housing

100-150 Amp, 128.5mm Stator OD

For: Denso Hair Pin Alternators

Used on:

Replaces:

OE: 104210-304, 104210-312,
104210-345, 104210-362,
104210-379, 104210-418,
104210-419

Lester: 11032, 11033, 13905,
13927, 13981

Ref: AT-03266

Note: Bearing use
Bearing Retainer 46-82003
Retainer Screw 84-82008

21-Drive End Housing

Photo
Coming Soon

21-82090 DE Housing

140 Amp, 128.5mm Stator OD

For: Denso Hair Pin Alternators

Used on: Jaguar S-Style, XJ8, XJR..

Replaces:

OE: 104210-308

Lester: 13979

Ref: AE-0322

Note: Bearing use
Bearing Retainer
Retainer Screw

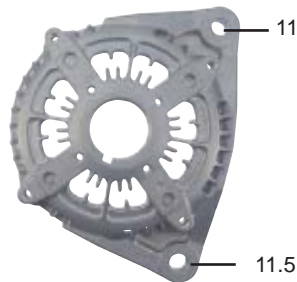

21-82096 DE Housing

180-220 Amp, 138.5mm Stator OD

For: Denso Hair Pin Alternators

Used on: Dodge Truck

Replaces:

OE: 421000-700, 421000-701

Lester: 11379, 11380

Ref:

Note: Bearing use
Bearing Retainer 46-82039
Retainer Screw 84-82008

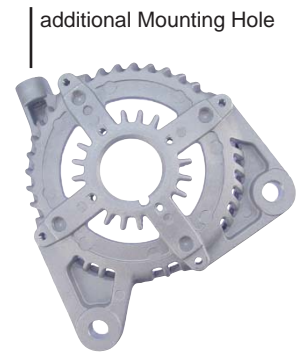

21-82098 DE Housing

136 Amp, 128.5mm Stator OD

For: Denso Hair Pin Alternators

Used on: Chrysler Pacifica

Replaces:

OE: 421000-014, 421000-030

Lester: 11063

Ref: AZ-0395

Note: Bearing use
Bearing Retainer 46-82003
Retainer Screw 84-82008
11296 DE similar to this, but 11296
without the additional Bolt hole.
For 11296 DE, please use 21-82145.



21-82095 DE Housing

130 Amp, 128.5mm Stator OD

For: Denso Hair Pin Alternators

Used on: Acura MDX, Honda Odyssey

Replaces:

OE: 104210-309

Lester: 13918

Ref: AH-03107

Note: Bearing use
Bearing Retainer 46-82003
Retainer Screw 84-82008



21-82097 DE Housing

100-140 Amp, 128.5mm Stator
OD

For: Denso Hair Pin Alternators

Used on: Toyota Camry, Solara

Replaces:

OE: 104210-479, 104210-481,
104210-533

Lester: 11034, 11195, 11201

Ref:
Note: Bearing use
Bearing Retainer 46-82003
Retainer Screw use 84-82008
DE wo/Ear Ring



21-82099 DE Housing

195 Amp, 138.5mm Stator OD

For: Denso Hair Pin Alternators

Used on: Ford E Series Truck

Replaces:

OE: 104210-618

Lester: 11434

Ref:

Note: Bearing use
Bearing Retainer use 46-82003
Retainer Screw use 84-82008

21-Drive End Housing



21-82101
DE Housing
150 Amp, 128.5mm Stator OD
For: Denso Hair Pin Alternators
Used on: John Deere
Replaces: 121401-0780
OE: 104210-392
Lester: 12660
Ref:
Note: Bearing use OE# 949100-2820
 Bearing Retainer 46-82039
 Retainer Screw 84-82008



21-82103
DE Housing
140-160 Amp, 128.5mm Stator OD
For: Denso Hair Pin Alternators
Used on: Chrysler, Dodge
Replaces:
OE: 421000-025, 421000-026,
 421000-034, 421000-062,
 421000-063
Lester: 11112, 11113, 11382, 11383
Ref: AZ-0392
Note: Bearing use OE# 949100-2820
 Bearing Retainer 46-82039
 Retainer Screw 84-82008



21-82102
DE Housing
145-160 Amp, 128.5mm Stator OD
For: Denso Hair Pin Alternators
Used on: Chrysler, Dodge
Replaces:
OE: 421000-021, 421000-041, 421000-
 051, 421000-052, 421000-058, 421000-
 067, 421000-073
Lester: 11297, 11298, 11299, 11378,
 11449, 13988
Ref: AZ-0389
Note: Bearing use OE#
 Bearing Retainer
 Retainer Screw



21-82104
DE Housing
100-150 Amp, 128.5mm Stator OD
For: Denso Hair Pin Alternators
Used on: Lexus, Toyota
Replaces:
OE: 104210-209, 104210-214, 104210-
 447, 104210-457, 104210-474, 104210-
 475, 104210-551
Lester: 11136, 11137, 11322, 11323,
 11325, 11326
Ref: AT-03308
Note: Bearing use OE# 949100-2250
 Bearing Retainer
 Retainer Screw



21-82106
DE Housing
150 Amp, 128.5mm Stator OD
For: Denso Hair Pin Alternators
Used on: Volvo
Replaces:
OE: 104210-356, 104210-464
Lester: 11054
Ref:
Note: Bearing use OE#
 Bearing Retainer
 Retainer Screw

21-Drive End Housing



21-82107

DE Housing

220 Amp, 138.5mm Stator OD

For: Denso Hair Pin Alternators

Used on: GM Cadillac

Replaces:

OE: 104210-600

Lester: 11181

Ref:

Note: Bearing use OE#
Bearing Retainer
Retainer Screw



21-82109

DE Housing

125 Amp, 128.5mm Stator OD

For: Denso Hair Pin Alternators

Used on: Ford Truck

Replaces:

OE: 104210-543

Lester: 11291

Ref: AE-0330

Note: Bearing use OE#
Bearing Retainer
Retainer Screw



21-82111

DE Housing

150 Amp, 128.5mm Stator OD

For: Denso Hair Pin Alternators

Used on: Hyundai, Kia

Replaces:

OE: 104210-287, 104210-581

Lester: 11387, 11524, 11591, 11686

Ref: AN-03148

Note: Bearing use OE#
Bearing Retainer
Retainer Screw



21-82108

DE Housing

150 Amp, 128.5mm Stator OD

For: Denso Hair Pin Alternators

Used on: Landrover

Replaces:

OE: 104210-3690, 104210-3691,
104210-370

Lester: 11205, 11206, 11569

Ref: AN-03109

Note: Bearing use OE#
Bearing Retainer
Retainer Screw



21-82110

DE Housing

150 Amp, 128.5mm Stator OD

For: Denso Hair Pin Alternators

Used on: Lexus

Replaces:

OE: 104210-205, 104210-468

Lester: 11196

Ref: AT-03306

Note: Bearing use OE#
Bearing Retainer
Retainer Screw



21-82112

DE Housing

130 Amp, 128.5mm Stator OD

For: Denso Hair Pin Alternators

Used on: Honda Accord

Replaces:

OE: 104210-589

Lester: 11390

Ref: AH-03132_

Note: Bearing use OE#
Bearing Retainer
Retainer Screw

21-Drive End Housing



21-82113

DE Housing

130 Amp, 128.5mm Stator OD

For: Denso Hair Pin Alternators

Used on: Acura, Honda

Replaces:

OE: 104210-124, 104210-160, 104210-189, 104210-199, 104210-310, 104210-377, 104210-830, 104210-851, 104210-852, 104210-350, 104210-429, 104210-469, 104210-591, 104210-592, 104210-827, 104210-830, 104210-851, 104210-852

Lester: 11030, 11062, 11099, 11150, 11151, 11391, 11392, 11573, 11600, 11670, 11671, 11672, 11773, 11774, 11775

Ref: AH-03123

Note: Bearing use OE#
Bearing Retainer
Retainer Screw



21-82114

DE Housing

100 Amp, 128.5mm Stator OD

For: Denso Hair Pin Alternators

Used on: Pontiac, Scion, Toyota

Replaces:

OE: 104210-548, 104210-549,

Lester: 11385, 11386

Ref: AT-03325

Note: Bearing use OE#
Bearing Retainer
Retainer Screw
11577 can not use this DE, they are different angle.



21-82115

DE Housing

200 Amp, 138.5mm Stator OD

For: Denso Hair Pin Alternators

Used on: Ford Truck

Replaces:

OE: 104210-6100, 104210-6103

Lester: 11290

Ref: AE-0331

Note: Bearing use OE#
Bearing Retainer
Retainer Screw



21-82116

DE Housing

130 Amp, 128.5mm Stator OD

For: Denso Hair Pin Alternators

Used on: Cadillac

Replaces: 121401-0592

OE: 104210-328

Lester: 11003

Ref: AJ-03129

Note: Bearing use OE#
Bearing Retainer
Retainer Screw



21-82117

DE Housing

150 Amp, 128.5mm Stator OD

For: Denso Hair Pin Alternators

Used on: Ford, Lincoln

Replaces:

OE: 104210-470, 104210-563, 104210-582

Lester: 11293, 11430, 11431

Ref: AE-0332

Note: Bearing use OE#
Bearing Retainer
Retainer Screw



21-82118

DE Housing

170 Amp, 138.5mm Stator OD

For: Denso Hair Pin Alternators

Used on: Buick, Chevy, GM, Saturn

Replaces:

OE: 104210-616

Lester: 11252

Ref:

Note: Bearing use OE#
Bearing Retainer
Retainer Screw

21-Drive End Housing



21-82119

DE Housing

180 Amp, 138.5mm Stator OD

For: Denso Hair Pin Alternators

Used on: Lexus, Toyota

Replaces:

OE: 104210-614

Lester: 11405

Ref:

Note: Bearing use OE#
Bearing Retainer
Retainer Screw



21-82121

DE Housing

80 Amp, mm Stator OD

For: Denso Hair Pin Alternators

Used on: Toyota

Replaces:

OE: 104210-811, 104210-823

Lester: 11194, 11354

Ref:

Note: Bearing use OE#
Bearing Retainer
Retainer Screw
This unit is aluminum SRE Cover
but with Hair Pin Stator.



21-82123

DE Housing

150-160 Amp, 128.5mm Stator OD

For: Denso Hair Pin Alternators

Used on: Jeep

Replaces:

OE: 421000-036, 421000-055,
421000-066

Lester: 11155, 11241

Ref: AZ-03105

Note: Bearing use OE#
Bearing Retainer
Retainer Screw



21-82120

DE Housing

160 Amp, 128.5mm Stator OD

For: Denso Hair Pin Alternators

Used on: Chrysler

Replaces:

OE: 421000-075

Lester: 11572

Ref:

Note: Bearing use OE#
Bearing Retainer
Retainer Screw



21-82122

DE Housing

150 Amp, 128.5mm Stator OD

For: Denso Hair Pin Alternators

Used on: Ford Truck

Replaces:

OE: 104210-111, 104210-586,
104210-597

Lester: 11292, 11432

Ref:

Note: Bearing use OE#
Bearing Retainer
Retainer Screw



21-82124

DE Housing

160 Amp, 128.5mm Stator OD

For: Denso Hair Pin Alternators

Used on: Chrysler, Dodge, Jeep

Replaces:

OE: 421000-004, 421000-010, 421000-
044, 421000-047, 421000-050,
421000-053

Lester: 11240, 11277, 13912, 13913

Ref: AZ-0376

Note: Bearing use OE#
Bearing Retainer
Retainer Screw

21-Drive End Housing



21-82125
DE Housing

150 Amp, 128.5mm Stator OD

For: Denso Hair Pin Alternators

Used on: Cadillac

Replaces:

OE: 104210-326

Lester: 11038

Ref:

Note: Bearing use OE#
Bearing Retainer
Retainer Screw



21-82127
DE Housing

100 Amp, 128.5mm Stator OD

For: Denso Hair Pin Alternators

Used on: Toyota

Replaces:

OE: 104210-263, 104210-265

Lester: 11516, 11519

Ref: AT-03338

Note: Bearing use OE#
Bearing Retainer
Retainer Screw



21-82129
DE Housing

150 Amp, 128.5mm Stator OD

For: Denso Hair Pin Alternators

Used on: Chrysler, Dodge

Replaces:

OE: 421000-039, 421000-046,
421000-065

Lester: 11286, 11381, 11401

Ref:

Note: Bearing use OE#
Bearing Retainer
Retainer Screw



21-82126
DE Housing

150 Amp, 128.5mm Stator OD

For: Denso Hair Pin Alternators

Used on: Toyota

Replaces:

OE: 104210-508, 104210-509, 104210-
510

Lester: 11350, 11351, 11352, 11765

Ref: AT-03333

Note: Bearing use OE#
Bearing Retainer
Retainer Screw



21-82128
DE Housing

130-140 Amp, 128.5mm Stator OD

For: Denso Hair Pin Alternators

Used on: Chevy, Potiac, Saturn

Replaces:

OE: 104210-414, 104210-433,
104210-441, 104210-442

Lester: 11109, 11110, 11140

Ref: AJ-03135

Note: Bearing use OE#
Bearing Retainer
Retainer Screw



21-82130
DE Housing

136 Amp, 128.5mm Stator OD

For: Denso Hair Pin Alternators

Used on: Buick, Chevy

Replaces:

OE: 104210-422

Lester: 11179

Ref:

Note: Bearing use OE#
Bearing Retainer
Retainer Screw

21-Drive End Housing

Photo
Coming Soon

21-82131 DE Housing

100 Amp, 128.5mm Stator OD

For: Denso Hair Pin Alternators

Used on: Toyota

Replaces:

OE: 104210-227, 104210-234,
104210-843

Lester: 11402

Ref:

Note: Bearing use OE#
Bearing Retainer
Retainer Screw



21-82133 DE Housing

100 Amp, 128.5mm Stator OD

For: Denso Hair Pin Alternators

Used on: Toyota

Replaces:

OE: 104210-284

Lester: 11517

Ref:

Note: Bearing use OE#
Bearing Retainer
Retainer Screw



21-82135 DE Housing

150 Amp, 128.5mm Stator OD

For: Denso Hair Pin Alternators

Used on: Chevy, Potiac

Replaces:

OE: 104210-330, 104210-331, 104210-
499, 104210-507

Lester: 11035, 11036, 11146, 11156,
11180

Ref: AJ-03120

Note: Bearing use OE#
Bearing Retainer
Retainer Screw



21-82132 DE Housing

160 Amp, 128.5mm Stator OD

For: Denso Hair Pin Alternators

Used on: Chrysler

Replaces:

OE: 421000-077

Lester: 11570

Ref:

Note: Bearing use OE#
Bearing Retainer
Retainer Screw



21-82134 DE Housing

160 Amp, 128.5mm Stator OD

For: Denso Hair Pin Alternators

Used on: Chrysler, Dodge

Replaces:

OE: 421000-005, 421000-011,
421000-015, 421000-020,
421000-037

Lester: 11040, 11244, 13914, 13915

Ref:

Note: Bearing use OE#
Bearing Retainer
Retainer Screw



21-82136 DE Housing

140-150 Amp, 128.5mm Stator OD

For: Denso Hair Pin Alternators

Used on: Buick, Cadillac, Pontiac

Replaces:

OE: 104210-306, 104210-437

Lester: 11178, 13919

Ref: AJ-03100

Note: Bearing use OE#
Bearing Retainer
Retainer Screw

21-Drive End Housing

**Photo
Coming Soon**

**21-82137
DE Housing**

150 Amp, 128.5mm Stator OD

For: Denso Hair Pin Alternators

Used on: Cadillac

Replaces:

OE: 104210-334

Lester: 11037

Ref: AJ-03122

Note: Bearing use OE#
Bearing Retainer
Retainer Screw



**21-82139
DE Housing**

180 Amp, 138.5mm Stator OD

For: Denso Hair Pin Alternators

Used on: Chrysler, Dodge, Jeep

Replaces:

OE: 421000-702, 421000-703

Lester: 11575, 11576

Ref:

Note: Bearing use OE#
Bearing Retainer
Retainer Screw



**21-82141
DE Housing**

220 Amp, 138.5mm Stator OD

For: Denso Hair Pin Alternators

Used on: Ford Truck

Replaces:

OE: 104210-627

Lester: 11532

Ref:

Note: Bearing use OE#
Bearing Retainer
Retainer Screw



**21-82138
DE Housing**

130-160 Amp, 128.5mm Stator OD

For: Denso Hair Pin Alternators

Used on: Chrysler, Dodge

Replaces:

OE: 421000-012, 421000-018, 421000-019

Lester: 11039, 11048, 13923

Ref: AZ-0380

Note: Bearing use OE#
Bearing Retainer
Retainer Screw

**Photo
Coming Soon**

**21-82140
DE Housing**

170 Amp, 138.5mm Stator OD

For: Denso Hair Pin Alternators

Used on: Chevy & GMC Truck

Replaces:

OE: 104210-686, 104210-687

Lester: 14009, 14020

Ref:

Note: Bearing use OE#
Bearing Retainer
Retainer Screw
DE w/Ear Ring



**21-82142
DE Housing**

140 Amp, 128.5mm Stator OD

For: Denso Hair Pin Alternators

Used on: Buick

Replaces:

OE: 104210-225

Lester: 11367

Ref:

Note: Bearing use OE#
Bearing Retainer
Retainer Screw

21-Drive End Housing



21-82143
DE Housing

180-225 Amp, 138.5mm Stator OD

For: Denso Hair Pin Alternators

Used on: Ford Truck

Replaces:

OE: 104210-622, 104210-634, 104210-660, 104210-667

Lester: 11624, 11627, 11629, 11630

Ref:

Note: Bearing use OE#
Bearing Retainer
Retainer Screw



21-82145
DE Housing

160 Amp, 128.5mm Stator OD

For: Denso Hair Pin Alternators

Used on: Chrysler, Dodge

Replaces:

OE: 421000-048

Lester: 11296

Ref: AE-03121

Note: Bearing use OE#
Bearing Retainer
Retainer Screw



21-82147
DE Housing

140-150 Amp, 128.5mm Stator OD

For: Denso Hair Pin Alternators

Used on: Chevy, Cadillac

Replace:

OE: 104210-200, 104210-319, 104210-332, 104210-435, 104210-443, 104210-539, 104210-813

Lester: 11044, 11046, 11369, 11508, 14021

Ref: AJ-03142

Note: Bearing use OE#
Bearing Retainer
Retainer Screw



21-82144
DE Housing

150 Amp, 128.5mm Stator OD

For: Denso Hair Pin Alternators

Used on: GM

Replaces:

OE: 104210-541

Lester: 11250

Ref:

Note: Bearing use OE#
Bearing Retainer
Retainer Screw



21-82146
DE Housing

150 Amp, 128.5mm Stator OD

For: Denso Hair Pin Alternators

Used on: Chrysler, Dodge

Replaces:

OE: 421000-080

Lester: 11574

Ref:

Note: Bearing use OE#
Bearing Retainer
Retainer Screw

**Photo
Coming Soon**

21-82148
DE Housing

150 Amp, 128.5mm Stator OD

For: Denso Hair Pin Alternators

Used on: Chevy Truck, GMC Truck

Replaces:

OE: 104210-834, 104210-911

Lester: 11785, 14007

Ref: AJ-03179

Note: Bearing use OE#
Bearing Retainer
Retainer Screw

21-Drive End Housing



21-82149 DE Housing

180-220 Amp, 138.5mm Stator OD

For: Denso Hair Pin Alternators

Used on: Dodge, Jeep

Replaces:

OE: 421000-704, 421000-705

Lester: 11592, 11598

Ref:

Note: Bearing use OE#
Bearing Retainer
Retainer Screw

**Photo
Coming Soon**

21-82154 DE Housing

150 Amp, 128.5mm Stator OD

For: Denso Hair Pin Alternators

Used on: Volvo S40

Replaces:

OE: 104210-405

Lester: 11093

Ref: AN-0386

Note: Bearing use OE#
Bearing Retainer
Retainer Screw

**Photo
Coming Soon**

21-82156 DE Housing

150 Amp, 128.5mm Stator OD

For: Denso Hair Pin Alternators

Used on: Ford Mustang

Replaces:

OE: 104210-297

Lester: 11623

Ref: AE-0381

Note: Bearing use OE#
Bearing Retainer
Retainer Screw



21-82151 DE Housing

100 Amp, 128.5mm Stator OD

For: Denso Hair Pin Alternators

Used on: Chrysler, Dodge

Replaces:

OE: 421000-

Lester: 11506

Ref:

Note: Bearing use OE#
Bearing Retainer
Retainer Screw



21-82155 DE Housing

160 Amp, 128.5mm Stator OD

For: Denso Hair Pin Alternators

Used on: Jeep

Replaces:

OE: 421000-081

Lester: 11584

Ref:

Note: Bearing use OE#
Bearing Retainer
Retainer Screw
11584 is a CCW unit.

**Photo
Coming Soon**

21-82157 DE Housing

125 Amp, 128.5mm Stator OD

For: Denso Hair Pin Alternators

Used on: Toyota

Replaces:

OE: 104211-3301

Lester: 11776

Ref:

Note: Bearing use OE#
Bearing Retainer
Retainer Screw

21-Drive End Housing

**Photo
Coming Soon**

21-82159

DE Housing

130 Amp, 128.5mm Stator OD

For: Denso Hair Pin Alternators

Used on: Ford

Replaces:

OE: 10421104210-409, 104210-530

Lester: 11238

Ref:

Note: Bearing use OE#

Bearing Retainer

Retainer Screw

22-Slip Ring End Housing



22-82084
SRE Housing
130-160 Amp, 128.5mm Stator OD
For: Denso Hair Pin Alternators
Used on:
Replaces: 021500-7100
OE: 104210-424, 421000-00, 421000-002, 421000-022
Lester: 11114, 13870, 13871
Ref: AZ-0478
Note: Bearing use
 Bearing Retainer 46-82200
 Bushing OE# 021541-1040
 Retainer Screw 84-82023
 SRE Stud 84-82001



22-82086
SRE Housing
100-130 Amp, 128.5mm Stator OD
For: Denso Hair Pin Alternators
Used on:
Replaces:
OE: 104210-347, 104210-420, 104210-423, 104210-492
Lester: 11138, 11139, 11324, 13984
Ref: AT-03280
Note: Bearing use
 Bearing Retainer 46-82200
 Bushing
 Retainer Screw 84-82023
 SRE Stud 84-82001



22-82088
SRE Housing
100 Amp, 128.5mm Stator OD
For: Denso Hair Pin Alternators
Used on:
Replaces:
OE: 104210-378, 104210-388, 104210-389, 104210-403, 104210-479, 104210-481, 104210-488, 104210-533
Lester: 11034, 11084, 11088, 11195, 11201
Ref: AT-04299
Note: Bearing use
 Bearing Retainer 46-82200
 Bushing 4604-8026
 Retainer Screw 84-82023
 SRE Stud 84-82001



22-82085
SRE Housing
130-150 Amp, 128.5mm Stator OD
For: Denso Hair Pin Alternators
Used on:
Replaces:
OE: 104210-338, 104210-339, 104210-344, 104210-451, 104210-512
Lester: 11090, 11153, 11198, 13983, 13992, 13994
Ref: AT-07274
Note: Bearing use
 Bearing Retainer 46-82200
 Bushing 4604-8023
 Retainer Screw 84-82023
 SRE Stud 84-82001



22-82087
SRE Housing
150 Amp, 128.5mm Stator OD
For: Denso Hair Pin Alternators
Used on:
Replaces: 121501-2070
OE: 104210-329, 104210-473
Lester: 13980
Ref: AH-04113
Note: Bearing use
 Bearing Retainer 46-82200
 Bushing
 Retainer Screw 84-82023
 SRE Stud 84-82001



22-82089
SRE Housing
100-150 Amp, 128.5mm Stator OD
For: Denso Hair Pin Alternators
Used on:
Replaces:
OE: 104210-345, 104210-362, 104210-365, 104210-375, 104210-379, 104210-418, 104210-419
Lester: 11032, 11033, 13981
Ref: AT-04275
Note: Bearing use
 Bearing Retainer 46-82200
 Bushing
 Retainer Screw 84-82023
 SRE Stud 84-82001

22-Slip Ring End Housing

Photo
Coming Soon

22-82090
SRE Housing
140 Amp, 128.5mm Stator OD
For: Denso Hair Pin Alternators
Used on:
Replaces:
OE: 104210-308
Lester: 13979
Ref: AN-04100
Note: Bearing use
Bearing Retainer
Bushing
Retainer Screw
SRE Stud 84-82001



22-82093
SRE Housing
130 Amp, 128.5mm Stator OD
For: Denso Hair Pin Alternators
Used on:
Replaces:
OE: 104210-309
Lester: 13918
Ref: AH-04107
Note: Bearing use
Bearing Retainer 46-82200
Bushing 4604-8025
Retainer Screw 84-82023
SRE Stud 84-82001



22-82094
SRE Housing
130 Amp, 128.5mm Stator OD
For: Denso Hair Pin Alternators
Used on:
Replaces:
OE: 104210-304, 104210-312
Lester: 13905, 13927
Ref: AT-04266
Note: Bearing use
Bearing Retainer 46-82200
Bushing 4604-8027
Retainer Screw 84-82023
SRE Stud 84-82001



22-82095
SRE Housing
136 Amp, 128.5mm Stator OD
For: Denso Hair Pin Alternators
Used on:
Replaces:
OE: 421000-014, 421000-030, 421000-048, 412000-056, 421000-070
Lester: 11243, 11294, 11295, 11296, 11063
Ref: AZ-0495, AZ-04106
Note: Bearing use
Bearing Retainer 46-82200
Bushing 4604-8024
Retainer Screw 84-82023
SRE Stud 84-82001

alignment pin



22-82096
SRE Housing
195 Amp, 138.5mm Stator OD
For: Denso Hair Pin Alternators
Used on: Ford Truck
Replaces:
OE: 104210-618
Lester: 11434
Ref:
Note: Bearing use
Bearing Retainer 46-82200
Bushing
Retainer Screw 84-82023
SRE Stud 84-82001
Ford use w/Alignment Pin.
Chevy use wo/Alignment Pin.



22-82098
SRE Housing
150 Amp, 128.5mm Stator OD
For: Denso Hair Pin Alternators
Used on: John Deere
Replaces:
OE: 104210-3920 (Early Type)
Lester: 12660
Ref:
Note: Bearing use 949100-2820
Bearing Retainer 46-82200
Bushing
Retainer Screw 84-82023
SRE Stud 84-82001
Late Type use 22-82104

22-Slip Ring End Housing



22-82099
SRE Housing
145-160 Amp, 128.5mm Stator OD

For: Denso Hair Pin Alternators

Used on: Chrysler, Dodge

Replaces:

OE: 421000-021, 421000-041, 421000-051, 421000-052, 421000-058, 42100-073

Lester: 11297, 11298, 11299, 11378, 13988

Ref: AZ-0489

Note: Bearing use

Bearing Retainer

Bushing 4604-8024

Retainer Screw

SRE Stud



22-82101
SRE Housing
100-150 Amp, 128.5mm Stator OD

For: Denso Hair Pin Alternators

Used on: Lesus, Toyota

Replaces:

OE: 104210-209, 104210-214, 104210-447, 104210-457, 104210-474, 104210-475, 104210-551

Lester: 11136, 11137, 11322, 11323, 11325, 11326

Ref: AT-04308

Note: Bearing use 949100-2820

Bearing Retainer 46-82200

Bushing

Retainer Screw 84-82023

SRE Stud 84-82001



22-82103
SRE Housing
195 Amp, 138.5mm Stator OD

For: Denso Hair Pin Alternators

Used on: Ford E-Series Truck

Replaces:

OE: 104210-618, 104210-686, 104210-687

Lester: 11434, 14009, 14020

Ref:

Note: Similar to 22-82096, but this 22-82103 SRE wo/ Alignment Pin.

Ford use w/Alignment Pin.

Chevy use wo/Alignment Pin.

Reference to 22-82096.



22-82100
SRE Housing
145-160 Amp, 128.5mm Stator OD

For: Denso Hair Pin Alternators

Used on: Chrysler, Dodge

Replaces:

OE: 421000-025, 421000-026, 421000-034, 421000-062, 421000-063, 421000-067

Lester: 11112, 11113, 11382, 11383, 11449

Ref: AZ-0492

Note: Bearing use 949100-2820

Bearing Retainer 46-82200

Bushing

Retainer Screw 84-82023

SRE Stud 84-82001

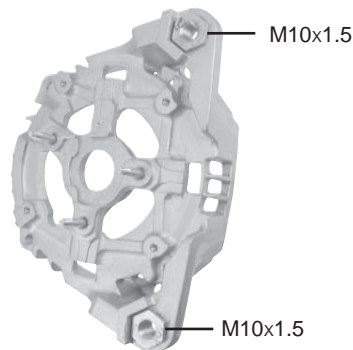

22-82102
SRE Housing
180-220 Amp, 138.5mm Stator OD

For: Denso Hair Pin Alternators

Used on: Chrysler, Dodge Ram Truck

Replaces:

OE: 421000-700, 421000-701, 421000-714

Lester: 11379, 11380, 11775

Ref:

Note: Bearing use 949100-2820

Bearing Retainer

Bushing 4604-8024

Retainer Screw

SRE Stud

22-Slip Ring End Housing



22-82104 SRE Housing

150 Amp, 128.5mm Stator OD

For: Denso Hair Pin Alternators

Used on: John Deere

Replaces:

OE: 104210-3921 (Late Type)

Lester: 12660

Ref:

Note: Bearing use 949100-2820
Bearing Retainer 46-82200
Bushing
Retainer Screw 84-82023
SRE Stud 84-82001
Early Type use 22-82098

**Photo
Coming Soon**

22-82105 SRE Housing

150 Amp, 128.5mm Stator OD

For: Denso Hair Pin Alternators

Used on: Land Rover

Replaces:

OE: 104210-3690, 104210-3691

Lester: 11206, 11569

Ref:

Note: Bearing use 949100-2820
Bearing Retainer 46-82200
Bushing
Retainer Screw 84-82023
SRE Stud 84-82001

Similar to 22-82108, but not the same.



22-82106A SRE Housing

150 Amp, 128.5mm Stator OD

For: Denso Hair Pin Alternators

Used on: Volvo

Replaces:

OE: 104210-356,

Lester: 11054

Ref:

Note: Bearing use
Bearing Retainer
Bushing
Retainer Screw
SRE Stud
104210-464 use 22-82106B.

**Photo
Coming Soon**

22-82106B SRE Housing

150 Amp, 128.5mm Stator OD

For: Denso Hair Pin Alternators

Used on: Volvo

Replaces:

OE: 104210-464

Lester: 11054

Ref:

Note: Bearing use
Bearing Retainer
Bushing
Retainer Screw
SRE Stud
104210-356 use 22-82106A.



22-82107 SRE Housing

220 Amp, 138.5mm Stator OD

For: Denso Hair Pin Alternators

Used on: GM Cadillac

Replaces:

OE: 104210-600

Lester: 11181

Ref:

Note: Bearing use
Bearing Retainer
Bushing
Retainer Screw
SRE Stud

22-Slip Ring End Housing



22-82108
SRE Housing
150 Amp, 128.5mm Stator OD

For: Denso Hair Pin Alternators

Used on: Landrover

Replaces:

OE: 104210-370

Lester: 11205

Ref: AN-04109

Note: Bearing use

Bearing Retainer

Bushing

Retainer Screw

SRE Stud

11205 & 11206 looks similar but,

11205-5:00 Clocking

11206-12:00 Clocking

Similar to 22-82105, but not the same.



22-82109
SRE Housing
125 Amp, 128.5mm Stator OD

For: Denso Hair Pin Alternators

Used on: Ford Truck

Replaces:

OE: 104210-543

Lester: 11291

Ref: AE-0430

Note: Bearing use

Bearing Retainer

Bushing

Retainer Screw

SRE Stud



22-82110
SRE Housing
150 Amp, 128.5mm Stator OD

For: Denso Hair Pin Alternators

Used on: Lexus

Replaces:

OE: 104210-205, 104210-468

Lester: 11196

Ref: AT-04306

Note: Bearing use

Bearing Retainer

Bushing

Retainer Screw

SRE Stud



22-82111
SRE Housing
150 Amp, 128.5mm Stator OD

For: Denso Hair Pin Alternators

Used on: Hyundai, Kia

Replaces:

OE: 104210-180, 104210-287, 104210-362, 104210-564, 104210-581

Lester: 11387, 11524, 11591, 11686

Ref: AN-04148

Note: Bearing use

Bearing Retainer

Bushing

Retainer Screw

SRE Stud



22-82112
SRE Housing
130 Amp, 128.5mm Stator OD

For: Denso Hair Pin Alternators

Used on: Honda Accord

Replaces:

OE: 104210-589

Lester: 11390

Ref: AH-04132

Note: Bearing use

Bearing Retainer

Bushing

Retainer Screw

SRE Stud



22-82113
SRE Housing
130 Amp, 128.5mm Stator OD

For: Denso Hair Pin Alternators

Used on: Honda Accord

Replaces:

OE: 104210-3500, 104210-429, 104210-469, 104210-591, 104210-592

Lester: 11030, 11062, 11099, 11150, 11151, 11391, 11392, 11573, 11600, 11672

Ref: AH-04123

Note: Bearing use

Bearing Retainer

Bushing

Retainer Screw

SRE Stud

22-Slip Ring End Housing



22-82114
SRE Housing
100 Amp, 128.5mm Stator OD
For: Denso Hair Pin Alternators
Used on: Toyota
Replaces:
OE: 104210-146, 104210-548, 104210-549,
Lester: 11385, 11386, 11577
Ref: AT-04325
Note: Bearing use
 Bearing Retainer
 Retainer Screw
 SRE Stud



22-82116
SRE Housing
130 Amp, 128.5mm Stator OD
For: Denso Hair Pin Alternators
Used on: Cadillac CTS
Replaces: 021500-7111
OE: 104210-328
Lester: 11003
Ref: AJ-04129
Note: Bearing use
 Bearing Retainer
 Bushing
 Retainer Screw
 SRE Stud



22-82118
SRE Housing
170 Amp, 138.5mm Stator OD
For: Denso Hair Pin Alternators
Used on: GM, Chevy, Buick
Replaces:
OE: 104210-616
Lester: 11252
Ref: AJ-04160
Note: Bearing use
 Bearing Retainer
 Bushing
 Retainer Screw
 SRE Stud



22-82115
SRE Housing
200 Amp, 138.5mm Stator OD
For: Denso Hair Pin Alternators
Used on: Ford F-Series Truck
Replaces:
OE: 104210-6100, 104210-6103
Lester: 11290
Ref: AE-0431
Note: Bearing use
 Bearing Retainer
 Retainer Screw
 SRE Stud



22-82117
SRE Housing
150 Amp, 128.5mm Stator OD
For: Denso Hair Pin Alternators
Used on: Ford, Lincoln, Mercury
Replaces:
OE: 104210-111, 104210-470, 104210-563, 104210-582, 104210-586
Lester: 11292, 11293, 11430, 11431, 11432
Ref: AE-0432
Note: wo/Mounting Ear
 Bearing use
 Bearing Retainer
 Bushing
 Retainer Screw
 SRE Stud
 Similar to 22-82148, but 22-82148 has Mtg Ear for wire Clip.
 For Big Case 138.5mm, please use 22-82096.



22-82119
SRE Housing
180 Amp, 138.5mm Stator OD
For: Denso Hair Pin Alternators
Used on: Lexus, Toyota
Replaces:
OE: 104210-614
Lester: 11405
Ref:
Note: Bearing use
 Bearing Retainer
 Bushing
 Retainer Screw
 SRE Stud

22-Slip Ring End Housing



22-82120
SRE Housing
160 Amp, 128.5mm Stator OD
For: Denso Hair Pin Alternators
Used on: Chrysler
Replaces:
OE: 421000-075
Lester: 11572
Ref:
Note: Bearing use
 Bearing Retainer
 Retainer Screw
 SRE Stud



22-82124
SRE Housing
160 Amp, 128.5mm Stator OD
For: Denso Hair Pin Alternators
Used on: Chrysler, Dodge, Jeep
Replaces:
OE: 421000-004, 421000-010, 421000-044, 421000-047, 421000-050, 421000-053, 421000-071
Lester: 11240, 11277, 13912, 13913
Ref: AZ-0476
Note: Bearing use
 Bearing Retainer
 Retainer Screw
 SRE Stud



22-82121
SRE Housing
80 Amp, mm Stator OD
For: Denso Hair Pin Alternators
Used on: Toyota, Tacoma
Replaces:
OE: 104210-811, 104210-823
Lester: 11194, 11354
Ref:
Note: Bearing use
 Bearing Retainer
 Retainer Screw
 SRE Stud
 This unit is aluminum SRE Cover but with Hair Pin Stator.



22-82123
SRE Housing
15-160 Amp, 128.5mm Stator OD
For: Denso Hair Pin Alternators
Used on: Jeep
Replaces:
OE: 421000-036, 421000-055, 421000-066
Lester: 11155, 11241
Ref: AZ-04105
Note: Bearing use
 Bearing Retainer
 Retainer Screw
 SRE Stud



22-82125
SRE Housing
150 Amp, 128.5mm Stator OD
For: Denso Hair Pin Alternators
Used on: Cadillac STS, SRX
Replaces:
OE: 104210-326
Lester: 11038
Ref: AJ-04127
Note: wo/Mounting Ear
 Bearing use
 Bearing Retainer
 Retainer Screw
 SRE Stud

22-Slip Ring End Housing



22-82126
SRE Housing
150 Amp, 128.5mm Stator OD
For: Denso Hair Pin Alternators
Used on: Toyota
Replaces:
OE: 104210-598, 104210-509, 104210-510, 104210-864
Lester: 11350, 11351, 11352, 11765
Ref: AT-04333
Note: Bearing use
 Bearing Retainer
 Retainer Screw
 SRE Stud



22-82128
SRE Housing
130-140 Amp, 128.5mm Stator OD
For: Denso Hair Pin Alternators
Used on: Chevy, Pontiac, Saturn
Replaces:
OE: 104210-414, 104210-433, 104210-441, 104210-442
Lester: 11109, 11110, 11140
Ref: AJ-04135
Note: Bearing use
 Bearing Retainer
 Retainer Screw
 SRE Stud



22-82130
SRE Housing
136 Amp, 128.5mm Stator OD
For: Denso Hair Pin Alternators
Used on: Buick, Chevy, Pontiac
Replaces:
OE: 104210-422
Lester: 11179
Ref: AJ-04145
Note: Bearing use
 Bearing Retainer
 Retainer Screw
 SRE Stud



22-82127
SRE Housing
100 Amp, 128.5mm Stator OD
For: Denso Hair Pin Alternators
Used on: Toyota
Replaces:
OE: 104210-263, 104210-265
Lester: 11516, 11519
Ref: AT-04338
Note: Bearing use
 Bearing Retainer
 Retainer Screw
 SRE Stud



22-82129
SRE Housing
150 Amp, 128.5mm Stator OD
For: Denso Hair Pin Alternators
Used on: Chrysler, Dodge
Replaces:
OE: 421000-065
Lester: 11401
Ref:
Note: Bearing use
 Bearing Retainer
 Retainer Screw
 SRE Stud

**Photo
 Coming Soon**

22-82131
SRE Housing
100 Amp, 128.5mm Stator OD
For: Denso Hair Pin Alternators
Used on: Toyota
Replaces:
OE: 104210-227, 104210-234, 104210-843
Lester: 11402
Ref:
Note: Bearing use
 Bearing Retainer
 Retainer Screw
 SRE Stud
Ref:

22-Slip Ring End Housing



22-82132
SRE Housing
160 Amp, 128.5mm Stator OD

For: Denso Hair Pin Alternators

Used on: Crysler, Dodge

Replaces:

OE: 421000-077

Lester: 11570

Ref:

Note: Bearing use
Bearing Retainer
Retainer Screw
SRE Stud



22-82134
SRE Housing
160 Amp, 128.5mm Stator OD

For: Denso Hair Pin Alternators

Used on: Crysler, Dodge

Replaces:

OE: 421000-015, 421000-020,
421000-037,

Lester: 11040, 11244

Ref: AZ-0487

Note: Bearing use
Bearing Retainer
Retainer Screw
SRE Stud



22-82136
SRE Housing
140-150 Amp, 128.5mm Stator OD

For: Denso Hair Pin Alternators

Used on: Buick, Cadillac, Pontiac

Replaces:

OE: 104210-306, 104210-437

Lester: 11178, 13919

Ref: AJ-04100

Note: Bearing use
Bearing Retainer
Retainer Screw
SRE Stud



22-82133
SRE Housing
100 Amp, 128.5mm Stator OD

For: Denso Hair Pin Alternators

Used on: Toyota

Replaces:

OE: 104210-284

Lester: 11517

Ref:

Note: Bearing use
Bearing Retainer
Retainer Screw
SRE Stud



22-82135
SRE Housing
150 Amp, 128.5mm Stator OD

For: Denso Hair Pin Alternators

Used on: Chevy, Potiac

Replaces:

OE: 104210-330, 104210-331, 104210-
436, 104210-454, 104210-499, 104210-
507,

Lester: 11035, 11036, 11146, 11156,
11180

Ref: AJ-04120

Note: Bearing use
Bearing Retainer
Retainer Screw
SRE Stud



22-82137
SRE Housing
150 Amp, 128.5mm Stator OD

For: Denso Hair Pin Alternators

Used on: Cadillac

Replaces:

OE: 104210-334

Lester: 11037

Ref: AJ-04122

Note: Bearing use
Bearing Retainer
Retainer Screw
SRE Stud

22-Slip Ring End Housing



22-82138
SRE Housing
130-160 Amp, 128.5mm Stator OD
For: Denso Hair Pin Alternators
Used on: Crysler, Dodge
Replaces:
OE: 421000-012, 421000-018, 421000-019
Lester: 11039, 11048, 13923
Ref: AZ-0480
Note: Bearing use
 Bearing Retainer
 Retainer Screw
 SRE Stud



22-82142
SRE Housing
140 Amp, 128.5mm Stator OD
For: Denso Hair Pin Alternators
Used on: Buick
Replaces:
OE: 104210-225
Lester: 11367
Ref:
Note: Bearing use
 Bearing Retainer
 Retainer Screw
 SRE Stud



22-82139
SRE Housing
180 Amp, 138.5mm Stator OD
For: Denso Hair Pin Alternators
Used on: Crysler, Dodge, Jeep
Replaces:
OE: 421000-702, 421000-703
Lester: 11575, 11576
Ref:
Note: Bearing use
 Bearing Retainer
 Retainer Screw
 SRE Stud



22-82141
SRE Housing
220 Amp, 138.5mm Stator OD
For: Denso Hair Pin Alternators
Used on: Ford Truck
Replaces:
OE: 104210-627
Lester: 11532
Ref:
Note: Bearing use
 Bearing Retainer
 Retainer Screw
 SRE Stud



22-82143
SRE Housing
180-225 Amp, 138.5mm Stator OD
For: Denso Hair Pin Alternators
Used on: Ford Truck
Replaces:
OE: 104210-622, 104210-634, 104210-660, 104210-667
Lester: 11624, 11627, 11629, 11630
Ref:
Note: Bearing use
 Bearing Retainer
 Retainer Screw
 SRE Stud

22-Slip Ring End Housing



22-82144
SRE Housing
150 Amp, 128.5mm Stator OD
For: Denso Hair Pin Alternators
Used on: GM
Replaces:
OE: 104210-541
Lester: 11250
Ref:
Note: Bearing use OE#
 Bearing Retainer
 Retainer Screw



22-82146
SRE Housing
150 Amp, 128.5mm Stator OD
For: Denso Hair Pin Alternators
Used on: Chrysler, Dodge
Replaces:
OE: 421000-080
Lester: 11574
Ref:
Note: Bearing use OE#
 Bearing Retainer
 Retainer Screw

**Photo
 Coming Soon**

22-82148
SRE Housing
150 Amp, 128.5mm Stator OD
For: Denso Hair Pin Alternators
Used on: Chevy, GMC Truck
Replaces:
OE: 104210-834, 104210-836, 104210-911
Lester: 11785, 11794, 14007
Ref:
Note: w/Mounting Ear
 Bearing use OE#
 Bearing Retainer
 Retainer Screw
 Similar to 22-82117 but 22-82117 wo/
 Mtg Ear for wire Clip.



22-82145
SRE Housing
130 Amp, 128.5mm Stator OD
For: Denso Hair Pin Alternators
Used on: Lexus, Toyota
Replaces:
OE: 104210-346
Lester: 11087
Ref:
Note: Bearing use OE#
 Bearing Retainer
 Retainer Screw



22-82147
SRE Housing
140-150 Amp, 128.5mm Stator OD
For: Denso Hair Pin Alternators
Used on: Chevy, Cadillac
Replaces:
OE: 104210-200, 104210-319, 104210-332, 104210-539, 104210-813
Lester: 11044, 11046, 11369, 11508, 14021
Ref: AJ-04142
Note: Bearing use OE#
 Bearing Retainer
 Retainer Screw



22-82149
SRE Housing
180-220 Amp, 138.5mm Stator OD
For: Denso Hair Pin Alternators
Used on: Dodge, Jeep
Replaces:
OE: 421000-704, 421000-705
Lester: 11592, 11598
Ref:
Note: Bearing use OE#
 Bearing Retainer
 Retainer Screw

22-Slip Ring End Housing

Photo
Coming Soon

22-82151
SRE Housing
100 Amp, 128.5mm Stator OD
For: Denso Hair Pin Alternators
Used on: Chrysler, Dodge
Replaces:
OE: 421000-
Lester: 11506
Ref:
Note: Bearing use OE#
Bearing Retainer
Retainer Screw

Photo
Coming Soon

22-82152
SRE Housing
136-160 Amp, 128.5mm Stator OD
For: Denso Hair Pin Alternators
Used on: Dodge Durango
Replaces:
OE: 421000-005, 421000-011
Lester: 13914, 13915
Ref:
Note: Bearing use OE#
Bearing Retainer
Retainer Screw

Photo
Coming Soon

22-82154
SRE Housing
150 Amp, 128.5mm Stator OD
For: Denso Hair Pin Alternators
Used on: Volvo S40
Replaces:
OE: 104210-405
Lester: 11093
Ref: AN-0486
Note: Bearing use OE#
Bearing Retainer
Retainer Screw



22-82155
SRE Housing
160 Amp, 128.5mm Stator OD
For: Denso Hair Pin Alternators
Used on: Jeep
Replaces:
OE: 421000-081
Lester: 11584
Ref:
Note: Bearing use OE#
Bearing Retainer
Retainer Screw
11584 is a CCW unit.

Photo
Coming Soon

22-82156
SRE Housing
160 Amp, 128.5mm Stator OD
For: Denso Hair Pin Alternators
Used on: Ford Mustang
Replaces:
OE: 104210-297
Lester: 11623
Ref: AE-0481
Note: Bearing use OE#
Bearing Retainer
Retainer Screw

Photo
Coming Soon

22-82157
SRE Housing
125 Amp, 128.5mm Stator OD
For: Denso Hair Pin Alternators
Used on: Toyota
Replaces:
OE: 104211-3301
Lester: 11776
Ref:
Note: Bearing use OE#
Bearing Retainer
Retainer Screw

22-Slip Ring End Housing

**Photo
Coming Soon**

22-82158

SRE Housing

130 Amp, 128.5mm Stator OD

For: Denso Hair Pin Alternators

Used on: Lexus

Replaces:

OE: 104210-4000, 104210-4001

Lester: 11197

Ref:

Note: Bearing use OE#

Bearing Retainer

Retainer Screw

**Photo
Coming Soon**

22-82159

SRE Housing

130 Amp, 128.5mm Stator OD

For: Denso Hair Pin Alternators

Used on: Ford

Replaces:

OE: 104210-409, 104210-530

Lester: 11238

Ref:

Note: Bearing use OE#

Bearing Retainer

Retainer Screw

24-Clutch/Decoupler Pulley



24CP-82001 Clutch Pulley 8-Groove

For: Denso Hair Pin Alternators

Used on:

Replaces:

Size: 17mm Bore
60mm OD x 28mm Belt

OE: 421000-051, 421000-351,
421000-700

Lester: 11378, 11379, 11583

Note: OE Take Out. Ref 24-82116



24CP-82003 Clutch Pulley 6-Groove

For: Denso Hair Pin Alternators

Used on: Chrysler, Dodge

Replaces:

Size: 17mm Bore
58mm OD x 20mm Belt
M14 x 1.5 Threaded

OE: 421000-001, 421000-002,
421000-014, 421000-022,
421000-030, 421000-049,
421000-075

Lester: 11063, 13870, 13871

Note: Ref 24-82273, 28581
Cap use 24CP-CAP001



24CP-82005 Clutch Pulley 7-Groove

For: Denso Hair Pin Alternators

Used on: Lexus, Toyota

Replaces:

Size: 17mm Bore
53mm OD
M14 x 1.50

OE: 104210-207, 104210-447,
104210-483

Lester: 11136, 11137, 11196, 11326

Note: Ref 24-82290, 28738
Cap use 24CP-CAP001

**Photo
Coming Soon**

24CP-82002 Clutch Pulley 6-Groove

For: Denso Hair Pin Alternators

Used on:

Replaces:

Size: 17mm Bore
58.5mm OD x 20mm Belt
M14 x 1.5 Threaded

OE: 104210-376

Lester: 23839

Note: Ref 24-82300



24CP-82004 Clutch Pulley 7-Groove

For: Denso Hair Pin Alternators

Used on:

Replaces:

Size: 17mm Bore
55mm OD
M14 x 1.5 Threaded

OE: 104210-479, 104210-481,
104210-488

Lester: 11195, 11201

Note: Ref 24-82291, 28696
Cap use 24CP-CAP001



24DP-82005 Decoupler Pulley 7-Groove

For: Denso Hair Pin Alternators

Used on: Lexus, Toyota

Replaces:

Size: 17mm Bore
53mm OD
M14 x 1.50

OE: 104210-207, 104210-447,
104210-483

Lester: 11136, 11137, 11196, 11326

Note: Ref 24-82290, 28738
Cap use 24CP-CAP001

24-Clutch/Decoupler Pulley



24CP-82006
Clutch Pulley
6-Groove

For: Denso Hair Pin / Valeo

Used on:

Replaces:

Size: 17mm Bore
58.7mm OD
M14 x 1.50

OE: Hyundai 35300-25301,
37300-25310, 37300-2G150,
37300-2G400

Denso 104210-225, 104210-616,
104210-631,

Lester: 11202, 11252, 11367, 11491,
11492

Note: Ref 24-82302, W055-112N
Cap use 24CP-



24CP-82008
Clutch Pulley
6-Groove

For: Denso Hair Pin

Used on:

Replaces:

Size: 17mm Bore
55mm OD
M14 x 1.50

OE: 104210-225, 104210-616,
104210-631,

Lester: 11402, 11577, 14486, 14487,
20359

Note: Ref AT-09336, 24-82289
Cap use 24CP-



24CP-82010
Clutch Pulley
6-Groove

For: Denso Hair Pin

Used on:

Replaces:

Size: 17mm Bore
70.50mm OD
M14 x 1.50

OE: 104210-124

Lester: 11573

Note: Ref AT-09336, 24-82289
Cap use 24CP-



24CP-82007
Clutch Pulley
6-Groove

For: Denso Hair Pin

Used on:

Replaces: 021040-2090

Size: 17mm Bore
51.9mm OD
M14 x 1.50

OE: 421000-075, 421000-077

Lester: 11570, 11572

Note: Ref 24-82322, W055-127N,
28810
Cap use 24CP-



24CP-82009
Clutch Pulley
4-Groove

For: Denso Hair Pin

Used on: Toyota

Replaces:

Size: 17mm Bore
56.2mm OD
M14 x 1.50

OE: 104210-263, 104210-265

Lester: 11516, 11519

Note: Ref 24-822101-4
Cap use 24CP-

**Photo
Coming Soon**

24DP-82010
Decoupler Pulley
6-Groove

For: Denso Hair Pin

Used on:

Replaces:

Size: 17mm Bore
70.50mm OD
M14 x 1.50

OE: 104210-124

Lester: 11573

Note: Ref AT-09336, 24-82289
Cap use 24CP-

24-Clutch/Decoupler Pulley



24CP-82011 **Clutch Pulley** **5-Groove**

For: Denso Hair Pin

Used on:

Replaces:

Size: 17mm Bore
55mm OD
M14 x 1.50

OE: 104210-124

Lester: 11054, 11093, 20424

Ref: AN-0986, 24-82312

Note: Ref AT-09336, 24-82289
Cap use 24CP-

Photo
Coming Soon

24CP-82012 **Clutch Pulley** **5-Groove**

For: Denso Hair Pin

Used on:

Replaces: 021040-2340, 021040-2680

Size: 17mm Bore
54mm OD
M14 x 1.50

OE: 104210-190, 104210-196,
104211-817, 104211-834, 104211-911

Lester: 11681, 11682, 11780, 11785,
11795, 14007, 14883

Ref: 24-82330 (OAD)

Note: Cap use 24CP-CAP

Photo
Coming Soon

24CP-82013 **Clutch Pulley** **6-Groove**

For: Denso Hair Pin

Used on:

Replaces:

Size: 17mm Bore
55.9mm OD

OE: 421000-702, 421000-703

Lester: 11575, 11576

Ref: AZ-09132 (OAP)

Note: Cap use

24-Pulley

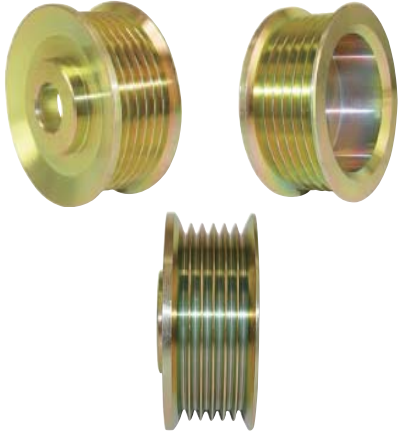

24-125Y Pulley 6-Groove

For: Denso Hair Pin Alternators

Used on:

Replaces: 021040-6240, 021041-5530,
021041-7540, 021041-9200

Size: 17mm Bore
65mm OD
21mm Belt Width
A:8.00mm

OE: 100211-8300, 101211-5480,
101211-5490, 101211-5500,
101211-5620, 101211-7170,
101211-7520, 101211-7670,
101211-7750, 101211-7840,
101211-7850, 101211-7851,
101211-9060, 101211-9100,
101211-9600, 101211-9780,
102211-0680, 102211-0681,
102211-0690, 102211-0691,
102211-1710, 121000-2520,
121000-3400, 121000-3520,
121000-3521, 121000-3523,
121000-3660, 121000-4070,
121000-4120, 121000-4122,
121000-4160, 121000-4161,
121000-4231, 121000-4232,
121000-4233, 121000-4270,
121000-4330, 121000-4331,
121000-4332, 121000-4372,
121000-4373, 121000-4510,
121000-4580, 421000-0060,
421000-0061, 421000-0062,
421000-0120, 421000-0121,
421000-0122, 421000-0230

Lester: 13307, 13311, 13331, 13538,
13539, 13558, 13593, 13594, 13695,
13706, 13722, 13746, 13747, 13755,
13763, 13765, 13769, 13806, 13835,
13836, 13842, 13844, 13868, 13923,
13964

Note: Ref 24-82260
Metro# 24-125 (black)
If used on 11030, 11151, need to
use with 46-82098 Specaer
(1mm Thickness).

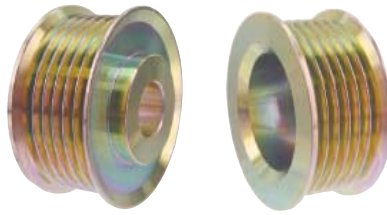

24-171Y Pulley 6-Groove

For: Denso Hair Pin Alternators

Used on:

Replaces: 021041-6780,
021041-6950

Size: 17mm Bore
58mm OD x 21mm Belt

OE: 100211-8830, 100211-8840,
100211-8841, 101211-5450, 101211-
5560, 101211-5610, 101211-7300,
101211-7301, 101211-7440, 101211-
7450, 101211-7760, 101211-7761,
101211-7800, 101211-7860, 101211-
7861, 101211-9150, 101211-9160,
101211-9350, 101211-9410, 101211-
9710, 101211-9711, 101211-9960,
102211-0590, 102211-0610, 102211-
0650, 102211-0730, 102211-0840,
102211-1620, 102211-3102, 104210-
3040, 104210-3041, 104210-3042,
104210-3043, 104210-3070, 104210-
3320, 104210-3380, 104210-3390,
104210-3440, 104210-3441, 104210-
3450, 104210-3620, 104210-3650,
104210-3651, 104210-3652, 104210-
3750, 104210-3751, 104210-3790,
104210-4090, 104210-4091, 104210-
4350, 104210-4510, 104210-5070,
104210-563, 121000-257, 121000-
3440, 121000-3450, 121000-3452,
121000-3480, 121000-3490, 121000-
3510, 121000-3570, 121000-3580,
121000-3600, 121000-3610, 121000-
3620, 121000-3650, 121000-3670,
121000-3671, 121000-3710, 121000-
3730, 121000-3750, 121000-4530,
421000-0030, 421000-0040, 421000-
0042, 421000-0043, 421000-0100,
421000-0103, 421000-0470

Lester: 11003, 11032, 11033, 11044,
11046, 11048, 11087, 11090, 11112,
11116, 11146, 11152, 11153, 11155,
11156, 11191, 11193, 11197, 11198,
11238, 11240, 11241, 11250, 11251,
11286, 11297, 11369, 11431, 11449,
11476, 11479, 11629, 11630, 12778,
13341, 13442, 13443, 13444, 13545,
13546, 13552, 13578, 13669, 13706,
13715, 13747, 13748, 13756, 13791

(continue)

(continue)

13809, 13822, 13834, 13844, 13856,
13859, 13867, 13869, 13880, 13912,
13913, 13919, 13927, 13956, 13978,
13981, 13983, 13994, 13999

Note: Ref 24-82263



24-184Y Pulley 6-Groove

For: Denso Hair Pin Alternators

Used on:

Replaces:

Size: 17mm Bore
55mm OD
21mm Belt Width
A:8mm

OE: 421000-026, 421000-034

Lester: 11116

Note: Ref

24-Pulley

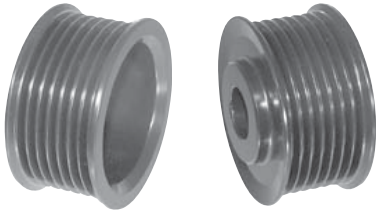

24-222Y
Pulley
7-Groove

For: Denso Hair Pin Alternators
Used on:
Replaces:
Size: 17mm Bore
58mm OD
25mm Belt Width
OE:
Lester: 13354, 13742 13823,
13824, 13988
Note: Ref 24-82269

Photo
Coming Soon

24-305
Pulley
6-Groove

For: Denso Hair Pin Alternators
Used on:
Replaces:
Size: 17mm Bore
60mm OD x 21mm Belt
OE: 100211-630, 101211-702,
104210-306 etc
Lester: 11035, 11036, 11178, 11179,
11180, 11181, 11183, 13331, 13410,
13506, 13547, 13919, 23191
Note: Ref 24-82278



24-319
Pulley
7-Groove

For: Denso Hair Pin Alternators
Used on: Chrysler
Replaces: 021041-9691
Size: 17mm Bore
58mm OD x 24mm Belt
OE: 421000-005, 421000-021m
421000-058
Lester: 11298, 13915, 13988
Note: Ref 24-82306



24-304
Pulley
8-Groove

For: Denso Hair Pin Alternators
Used on: John Deere
Replaces: 021041-7320
Size: 17mm Bore
62.5mm OD x 28mm Belt
A: 9.5mm
OE: 100211-642, 101211-503,
101211-713, 101211-778,
102211-040, 102211-118,
104210-392, 104210-393
Lester: 12193, 12194, 12195, 12474,
12657, 12658, 12660
Note: Ref

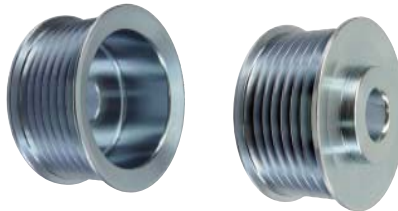

24-315
Pulley
7-Groove

For: Denso Hair Pin Alternators
Used on:
Replaces: 121041-0220
Size: 17mm Bore
59.5mm OD x 26mm Belt
OE: 104210-329, 104210-473
Lester: 11034, 11084, 11088, 11390,
13959, 13980, 23192
Note: Zinc Color.
Ref 24-82268
Black use 24-315B.



24-323
Pulley
8-Groove

For: Denso Hair Pin Alternators
Used on:
Replaces:
Size: 17mm Bore
70mm OD
32mm Belt Width
A:9.25mm
OE: 104210-610
Lester: 11290
Note: Ref

24-Pulley



24-325Y Pulley 7-Groove

For: Denso Hair Pin Alternators

Used on:

Replaces:

Size: 17mm Bore
45mm OD
25mm Belt Width
A:8mm

OE:

Lester: 11034*

Note: Similar to 24-315, except...
*This is small OD special made
to replace to 11034.

Cap & Tools for Clutch/Decoupler Pulley



24CP-CAP001
Cap-Clutch Pulley
Snap On Type

For: Denso Hair Pin Alternators

Used on:

Replaces:

Size: 53mm ID x 55mm OD
5mm Height

OE:

Lester:

Ref: AB-09318C

Note: used on:

24CP-82003, 24CP-82004,
24CP-82005, 24CP-83001,
24CP-83002, 24CP-91002,
24CP-91003, 24CP-94001



24CP-CAP002
Cap-Clutch Pulley

For: Denso Hair Pin Alternators

Used on:

Replaces:

Size:

OE:

Lester:

Ref: AB-09310C

Note: used on:

24CP-81001, 24CP-81001-1,
24CP-82007, 24CP-91001



TL24-007
Tool-Clutch Pulley
Fine Spline

For:

Used on: 24CP-82

Replaces:

OE:

Lester:

Note:



TL24-008
Tool-Clutch Pulley
Hex Head

For:

Used on: 24CP-82

Replaces:

OE:

Lester:

Note:



TL24-021
Tool Box-Clutch & Decoupler
Pulley

For:

Used on:

Replaces:

OE:

Lester:

Note: Shafts & Key Nuts cover all
Europe & North American applica-
tions.

27-Stator

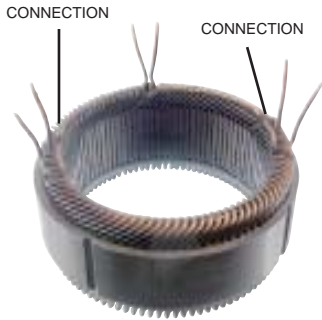

27-82018

Stator

100-130 Amp, 128.5mm OD

For: Denso Hair Pin Alternators

Used on:

Replaces:

Size: 100mm ID
128.5mm OD
32mm Thickness

OE:

Lester: 11034

Note: 6-Lead/2-connections.
Use w/30-82024 Rotor.
Delta Connect



27-82020

Stator

170-200 Amp, 138.5mm OD

For: Denso Hair Pin Alternators

Used on:

Replaces:

Size: 109mm ID
138.5mm OD
34.7mm Thickness

OE: 104210-610

Lester: 11252, 11290, 11434, 11598

Note: 6 Lead/2 connections.
Use w/30-82023 Rotor.
Wye Connect



27-82023

Stator

12V, 80 Amp, 110.8mm OD

For: Denso Hair Pin Alternators

Used on:

Replaces:

Size: 87mm ID
110.8mm OD
27mm Thickness

OE: 104210-802, 104210-9060

Lester: 23317

Note: 3-Lead/1-connections.
Use w/30-82025 Rotor.

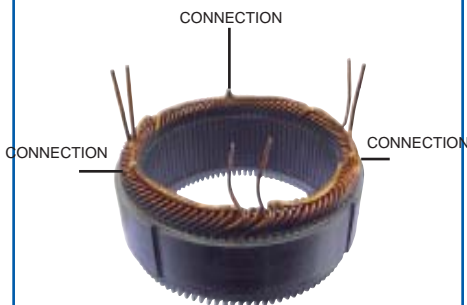

27-82022

Stator

130-160 Amp, 128.5mm OD

For: Denso Hair Pin Alternators

Used on:

Replaces: 021100-4940

Size: 100mm ID
128.5mm OD
32mm Thickness

OE:

Lester: 11030, 11044, 11094, 11099,
11382, 11383, 11572, 11595,
13868,

13870, 13871, 13980

Note: 6-Lead/3 connections.
Use w/30-82017 Rotor.
Wye Connect

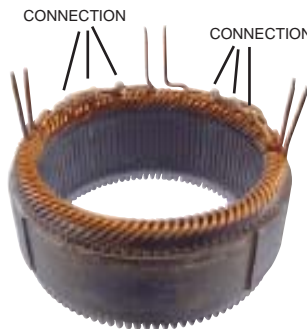

27-82024

Stator

220-225 Amp, 138.5mm OD

For: Denso Hair Pin Alternators

Used on: Dodge, Ford

Replaces: 021100-5480

Size: 109mm ID
138.5mm OD
34.7mm Thickness

OE: 104210-600, 104210-611,
104210-618, 104210-627; 104210-
6601, 421000-700, 421000-701,
421000-703, 421000-705

Lester: 11181, 11379, 11380, 11532,
11534, 11576, 11629, 20402

Note: 6 Lead/6 connections.
Use w/30-82018 Rotor.
Double Delta Connect

**Photo
Coming Soon**

27-82025

Stator

12V, Amp, mm OD

For: Denso Hair Pin Alternators

Used on:

Replaces:

Size: 94mm ID
122mm OD
mm Thickness

OE:

Lester:

Note: 6-Lead/2-connections.
Use w/30-82026 Rotor.

27-Stator

CONNECTION

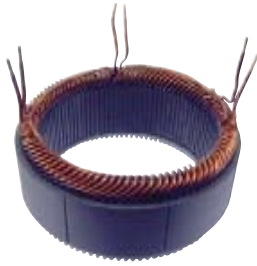

27-82026

Stator

12V, Amp, mm OD

For: Denso Hair Pin Alternators

Used on:

Replaces:

Size: 94mm ID
120mm OD
32mm Thickness

OE:

Lester:

Note: 6 Lead/2 connections.
Use w/Rotor

CONNECTION

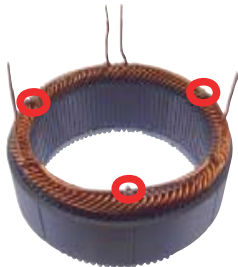

27-82027

Stator

12V, Amp, mm OD

For: Denso Hair Pin Alternators

Used on:

Replaces:

Size: 94mm ID
120mm OD
mm Thickness

OE:

Lester:

Note: 6 Lead/3 connections.
Use w/Rotor

CONNECTION

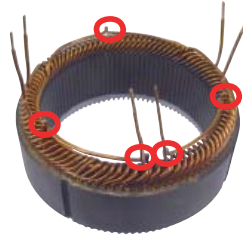

27-82018-1

Stator

12V, 100-130 Amp, 128.5mm OD

For: Denso Hair Pin Alternators

Used on:

Replaces:

Size: 100mm ID
128.5mm OD
32mm Thickness

OE:

Lester:

Note: 6 Lead/5 connections.
Use w/Rotor

CONNECTION

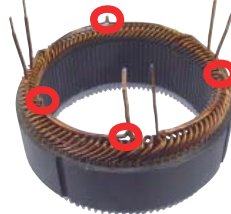

27-82018-2

Stator

12V, 100-130 Amp, 128.5mm OD

For: Denso Hair Pin Alternators

Used on:

Replaces:

Size: 100mm ID
128.5mm OD
32mm Thickness

OE:

Lester:

Note: 6 Lead/4 connections (middle left).
Use w/Rotor

CONNECTION

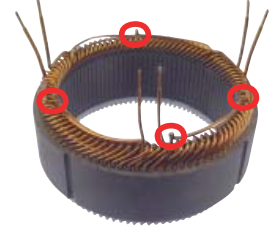

27-82018-3

Stator

12V, 100-130 Amp, 128.5mm OD

For: Denso Hair Pin Alternators

Used on:

Replaces:

Size: 100mm ID
128.5mm OD
32mm Thickness

OE:

Lester:

Note: 6 Lead/4 connections (middle right).
Use w/Rotor

28-Slip Ring

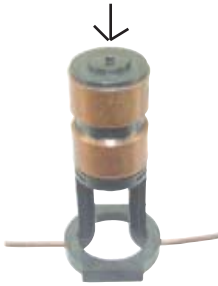

28-82017-1 Slip Ring

For: Denso Hair Pin Alternators

Used on:

Replaces:

Size:

OE:

Lester: 11033, 11034, 11195,
13870, 13871, 13918, 13919,
13980.. etc

Note: Straight Lead.

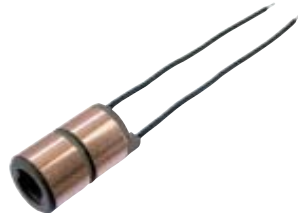

28-82012-4 Slip Ring

For: Denso Hair Pin Alternators

Used on:

Replaces:

Size: 7.2mm ID, 15mm OD
75mm/75mm Lead Length

OE:

Lester:

Note: Square Lead.



28-82017-2 Slip Ring Straight Lead

For: Denso Hair Pin Alternators

Used on:

Replaces:

Size:

OE:

Lester: 13867, 13870, 13871

Note: Straight Lead.

Ref: 28-82854

30-Rotor



30-82024 Rotor-CW 12V, 100-130 Amp

For: Denso Hair Pin Alternators

Used on:

Replaces:

Size: 99.5mm OD x 147mm OAL

OE:

Lester: 11003, 11032, 11034, 11035, 11036, 11039, 11040, 11062, 11087, 11088, 11099, 11136, 11137, 11138, 11139, 11201, 11244, 11324; 11402, 13867, 13868, 13871, 13905, 13912, 13914, 13918, 13919, 13923, 13927, 13963, 13984, 13992

Note: 2.5 ohm. (or 2.6 ohm)
Use w/27-82018 Stator.



30-82017 Rotor-CW 12V, 130-160 Amp

For: Denso Hair Pin Alternators

Used on:

Replaces: 021200-8580

Size: 99.5mm OD x 147mm OAL

OE: 104210-320, -337, -345, -356, -387, -392, -464, -538; 421000-014, -026, -049, -051, -066, -075

Lester: 11054, 11063, 11113, 11150, 11237,

11241, 11378, 11382, 11383, 11572, 12660, 13870, 13978, 13981

Note: 1.8 ohm.
Use w/27-82022 Stator.



30-82023 Rotor-CW 12V, 180-200 Amp

For: Denso Hair Pin Alternators

Used on:

Replaces:

Size: 109mm OD

OE: 104210-610, 104210-613

Lester: 11290, 11328

Note: 2.2 ohm.
Use w/27-82020 Stator.



30-82024-1 Rotor-CW 12V, 100-130 Amp

For: Denso Hair Pin Alternators

Used on:

Replaces:

Size: 99.5mm OD x 147mm OAL

OE:

Lester: 11003, 11032, 11034, 11035, 11036, 11039, 11040, 11062, 11087, 11088, 11099, 11136, 11137, 11138, 11139, 11201, 11244, 11324; 11402, 13867, 13868, 13871, 13905, 13912, 13914, 13918, 13919, 13923, 13927, 13963, 13984, 13992

Ref: AT-01275

Note: 2.5 ohm. (or 2.6 ohm)
Use w/27-82018 Stator.

* Same as 30-82024, except.....



30-82018 Rotor-CW 12V, 220 Amp

For: Denso Hair Pin Alternators

Used on:

Replaces: 121200-1960

Size: 109mm OD

OE: 104210-610

Lester: 11290, 11379

Note: 1.8 ohm.
Use w/27-82024 Stator.



30-82025 Rotor-CW 12V, 80 Amp

For: Denso Hair Pin Alternators

Used on:

Replaces:

Size: 86mm OD
142.8mm OAL

OE: 104210-802, 104210-9060

Lester: 23317

Note: Use w/27-82023 Stator.

30-Rotor

**Photo
Coming Soon**

30-82026

**Rotor-CW
12V, Amp**

For: Denso Hair Pin Alternators

Used on:

Replaces:

Size: 93.40mm OD
145mm OAL

OE:

Lester:

Note: Use w/27-82025 Stator.



30-82027

**Rotor-CCW
12V, 160 Amp**

For: Denso Hair Pin Alternators

Used on:

Replaces:

Size: 99.50mm OD
147mm OAL

OE: 421000-081

Lester: 11584

Note: This is a CCW Rotor.

31-Rectifier Repair Parts



31-82208
Rack-Rectifier

For: Denso Hair Pin Alternators

DIM:

Replace:

OE:

Lester:

Used on: 31-82038, 31-82042

Note: Ref INR420, INR421, INR424, INR425, INR426, INR427, INR434, INR437

for Repair Kit 31-82501



31-82210
Rack-Rectifier

For: Denso Hair Pin Alternators

DIM:

Replace:

OE:

Lester:

Used on:

Note: Ref Toyota Camry for Repair Kit 31-82503

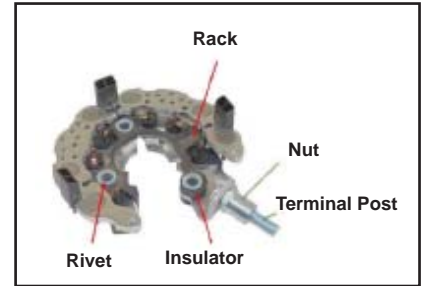

31-82209
Rack-Rectifier

For: Denso Hair Pin Alternators

DIM:

Replace:

OE:

Lester:

Used on: 31-82041, 31-82043, 31-82045

Note: Ref INR423, INR429, INR430, INR431, INR438 for Repair Kit 31-82502



31-82207
Insulator-Rectifier

For: Denso Hair Pin Alternators

DIM:

Replace:

OE:

Lester:

Used on:

Note: Ref



31-82303
Rivet-Rectifier (Brass)

For: Denso Hair Pin Alternators

DIM: 6.9mm ID, 18mm L

Replace:

OE:

Lester:

Used on:

Note: Ref

31-Rectifier Repair Kit



31-82501

Repair Kit-Rectifier

For: Denso Hair Pin Alternators

DIM:

Replace:

OE:

Lester:

Used on: 31-82038, 31-82042

Note: Ref INR420, INR421, INR424, INR425, INR426, INR427, INR434, INR437

Rack Frame from 31-82208



31-82503

Repair Kit-Rectifier

For: Denso Hair Pin Alternators

DIM:

Replace:

OE:

Lester:

Used on:

Note: Ref Toyota Camry.
Rack Frame from 31-82210

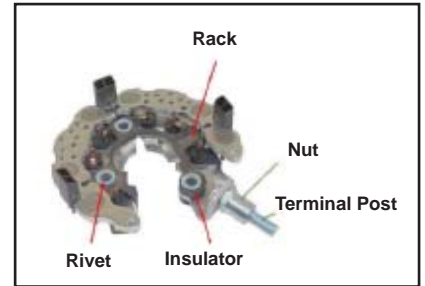

31-82502

Repair Kit-Rectifier

For: Denso Hair Pin Alternators

DIM:

Replace:

OE:

Lester:

Used on: 31-82041, 31-82043, 31-82045

Note: Ref INR423, INR429, INR430, INR431, INR438

Rack Frame from 31-82209

31-Rectifier & Parts



31-82038
Rectifier
 117mm OD, 8mm Side Post
 120-160 Amp, 12 Diodes
 12-40A

For: Denso Hair Pin Alternators
DIM: M8 x 1.25 x 34mm Battery Terminal
Replaces: 021580-5891
OE: 421000-081
Lester: 11030, 11062, 11063, 11093, 11099, 11109, 11114, 11205, 11206, 11291, 11292, 11432, 13868, 13870, 13871, 13912, 13913, 13992
Note: Ref to INR421
 Use 85-82026 (Nut M8x17.75mmL)
 Use 84-82054 (Post, M8x44.2mmOAL)



31-82041
Rectifier
 117mm OD, 8mm Side Post
 100-120 Amp, 7 Diodes

For: Denso Hair Pin Alternators
DIM: M8 x 1.25
Replaces: 021580-5891, 021580-5901, 021580-6381
OE: 421000-022, 42100-023
Lester: 11030, 11062, 11063, 11099, 11110, 11240, 13868, 13870, 13871, 13912, 13913, 13988
Note: Refer to INR423
 Use 17.3mm OAL Nut



31-82043
Rectifier
 117mm OD, 6mm Top Post
 105 Amp, 6 Diodes

For: Denso Hair Pin Alternators
DIM: M6 x 1.0
Replaces: 021580-6490
OE: 104210-329
Lester: 13980
Note: Refer to INR429
 Use 19mm OAL Nut, 85-82028
 Use Bolt 32mmL, 84-82050



31-82040
Rectifier
 134mm OD, 8mm Side Post
 200 Amp, 12 Diodes

For: Denso Hair Pin Alternators
DIM: M8 x 1.25 Battery Terminal
Replaces:
OE: 104210-607, 104210-613
Lester: 11328, 11405, 11496
Note: Ref to INR440
 Use Nut 85-82033
 Use Bolt mmL



31-82042
Rectifier
 117mm OD, 6mm Top Post
 130-140 Amp, 12 Diodes

For: Denso Hair Pin Alternators
DIM: M6 x 1.0
Replaces: 021580-5920
OE:
Lester: 11003, 11035, 11036, 11037, 11044, 11046, 11146, 11180, 11428, 13919, 13978
Note: Ref to INR425
 Use 21mm OAL Nut, 85-82029
 Use Bolt 32mmL, 84-82052



31-82044
Rectifier
 117mm OD, 8mm Side Post
 150 Amp, 12 Diodes

For: Denso Hair Pin Alternators
DIM: M8 x 1.25
Replaces: 021580-6450
OE: 104210-392 (Early Type)
Lester: 12660 (Early Type)
Note: Refer to INR439
 Use mm OAL Nut
 Use Bolt mmL

31-Rectifier & Parts



31-82045

Rectifier
117mm OD, 6mm Side Post
100 Amp, 6 Diodes

For: Denso Hair Pin Alternators

DIM: M6 x 1.0

Replaces: 021580-6610

OE: 104210-362, -378, -388, -389,
-423, -447, -479, -488, -492,
-510, -511, 549, -906

Lester: 11033, 11034, 11088, 11136,
11138, 11153, 11195, 11201*, 11322,
11324, 11350, 11385, 11386, 11400,
11516, 11519

Note: Refer to INR430, W065-220

Nut use 85-82027

Bolt use 84-82051



31-82047

Rectifier
117mm OD, 6mm Side Post
130 Amp, 12 Diodes

For: Denso Hair Pin Alternators

DIM: M6 x 1.0

Replaces:

OE: 104210-338

Lester: 13994

Note: Refer to INR442

Post use 84-82051

Nut use 85-82027

12-50A Diodes.



31-82049

Rectifier
117mm OD, 8mm Top Post
130-136 Amp, 12 Diodes

For: Denso Hair Pin Alternators

DIM: M8 x 1.25 x 42mm Batt. Term.

Replaces: 021580-5911, 021580-5931

OE: 421000-003, 421000-005,

421000-011, 421000-012,

421000-0122, 421000-018,

421000-019, 421000-075

Lester: 11039, 11048, 13867, 13914,

13915, 13923

Note: Refer to INR420, W065-200

Post use 84-

Nut use 85-



31-82046

Rectifier
134mm OD, 8mm Top Post
220 Amp, 12 Diodes

For: Denso Hair Pin Alternators

DIM: M8 x 1.25

Replaces:

OE:

Lester: 11251, 11252, 11290, 11576,
11598

Note: Refer INR435

Nut use

Bolt use

24V-50A Non-Avalanche



31-82048

Rectifier
117mm OD, 8mm Top Post
130-160 Amp, 12 Diodes
12-50A

For: Denso Hair Pin Alternators

DIM: M8x1.25

Replaces:

OE: 104210-373; 421000-008, 421000-
066, 421000-075,
421000-077

Lester: 11040, 11112, 11113, 11155,
11286, 11323, 11381, 11382, 11383,
11401, 11570, 11572, 23830, 23941

Note: Refer to INR432

Post use 84-82056

Nut use 85-82034

Ref: W065-202

use 31-82042+84-82056+85-82034=31-
82048

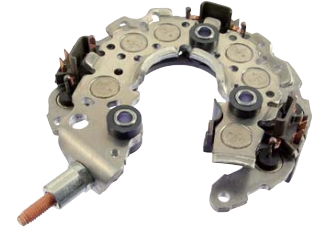

31-82050

Rectifier
117mm OD, 6mm Side Post
130 Amp, 12 Diodes

For: Denso Hair Pin Alternators

DIM: M6 x 1.0 x 28mm Batt Term

Replaces: 021580-6520

OE: 104210-365, 104210-366, 104210-
375, 104210-459, 104210-477, 104211-
8092

Lester: 11032, 14072, 20226

Note: Refer to INR422

Post use 84-

Nut use 85-

12-50A Diodes.

31-Rectifier & Parts



31-82051
Rectifier
117mm OD, 8mm Top Post
130 Amp, 12 Diodes

For: Denso Hair Pin Alternators
DIM: M8 x 1.25 x 42mm Batt. Term.
Replaces:
OE: 104210-309, 104210-309,
104210-543, 104210-595
Lester: 11291, 11368, 13918
Note: Refer to INR424
Post use 84-
Nut use 85-



31-82053
Rectifier
117mm OD, 6mm Side Post
130 Amp, 12 Diodes

For: Denso Hair Pin Alternators
DIM: M6 x 1.0
Replaces:
OE:
Lester: 11032, 11033, 11084, 11139,
11198, 11351, 13927, 13984, 23947
Note: Refer to INR427
Post use 84-
Nut use 85-82027

Photo
Coming Soon

31-82055
Rectifier
117mm OD, 8mm Side Post
120 Amp, 7 Diodes

For: Denso Hair Pin Alternators
DIM: M8 x 1.25
Replaces:
OE:
Lester: 23820, 23839
Note: Refer to INR431
Post use 84-
Nut use 85-
European car use

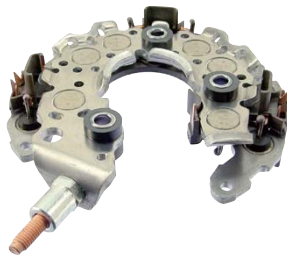

31-82052
Rectifier
117mm OD, 6mm Side Post
120-150 Amp, 12 Diodes

For: Denso Hair Pin Alternators
DIM: M6 x 1.0
Replaces: 021580-6370
OE: 104210-2050, 104210-209,
104210-321, 104210-339, 104210-345,
104210-409, 104210-416, 104210-468,
104210-470, 104210-475, 104210-509,
104210-530, 104210-551, 104210-563
Lester: 11000, 11090, 11196, 11238,
11323, 11326, 11352, 11430, 11431,
13981
Note: Refer to INR426
Post use 84-
Nut use 85-



31-82054
Rectifier
117mm OD, 6mm Top Post
100 Amp, 12 Diodes

For: Denso Hair Pin Alternators
DIM: M6 x 1.0
Replaces:
OE: 104210-153, 104210-329, 104210-
516
Lester: 11154, 11604, 13980
Note: Refer to INR428
Post use 84-
Nut use 85-



31-82056
Rectifier
117mm OD, 8mm Side Post
130 Amp, 12 Diodes

For: Denso Hair Pin Alternators
DIM: M8 x 1.25
Replaces:
OE:
Lester: 11030, 11062, 11140, 11150,
11151, 11197, 11391, 11392, 24028
Note: Refer to INR433
Post use 84-
Nut use 85-
European car use

31-Rectifier & Parts

**Photo
Coming Soon**

31-82057

**Rectifier
117mm OD, 8mm Side Post
140 Amp, 12 Diodes**

For: Denso Hair Pin Alternators

DIM: M8x1.25

Replaces: 021580-7451

OE: 104210-233, 104210-424,
104210-424, 104210-596,
421000-038, 421000-041,
421000-047, 421000-051,
421000-052, 421000-053,
421000-054, 421000-054,
421000-056, 421000-059,
421000-070

Lester: 11114, 11204, 11240, 11243,
11276, 11285, 11294, 11295, 11297,
11298, 11378, 11636

Note: Refer to INR434

Post use 84-820

Nut use 85-82

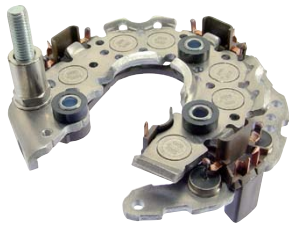

31-82058

**Rectifier
117mm OD, 8mm Top Post
135-155 Amp, 12 Diodes**

For: Denso Hair Pin Alternators

DIM: M8 x 1.25

Replaces:

OE:

Lester: 11156, 11178, 11179, 11250,
11369

Note: Refer to INR436

Post use 84-

Nut use 85-

**Photo
Coming Soon**

31-82059

**Rectifier
117mm OD, 8mm Top Post
150 Amp, 12 Diodes**

For: Denso Hair Pin Alternators

DIM: M8 x 1.25

Replaces:

OE:

Lester: 23821, 24047

Note: Refer to INR437

Post use 84-

Nut use 85-

European car use

**Photo
Coming Soon**

31-82060

**Rectifier
105mm OD, 6mm Side Post
80 Amp, 6 Diodes**

For: Denso Hair Pin Alternators

DIM: M6 x 1.0

Replaces:

OE:

Lester: 23371

Note: Refer to INR438

Post use 84-

Nut use 85-

32-Diodes



32-82003N
Diodes-Negative
24-32V/80A
13mm Press Fit

For: Denso Hair Pin Alternators
Used on:
Replaces:
OE:
Lester:
Note: Green, for higher amp use.
Avalanche Diodes.

**Photo
Coming Soon**

32-91700A-N
Diodes-Negative
20-24V/70A
13mm Press Fit

For: Denso Hair Pin Alternators
Used on:
Replaces:
OE:
Lester:
Note: Avalanche Diodes.



32-82003P
Diodes-Positive
24-32V/80A
13mm Press Fit

For: Denso Hair Pin Alternators
Used on:
Replaces:
OE:
Lester:
Note: Red, for higher amp use.
Avalanche Diodes.

**Photo
Coming Soon**

32-91700A-P
Diodes-Positive
20-24V/70A
13mm Press Fit

For: Denso Hair Pin Alternators
Used on:
Replaces:
OE:
Lester:
Note: Avalanche Diodes.

35-Regulator



35-82084
Regulator
Oval, 3-Pins
BVS-RC-LI

For: Denso Hair Pin Alternators
Used on:
Replaces: 126600-3430, 126600-3460
OE:
Lester: 11290, 11291, 11431, 23820, 23821, 23839
Ref: IN6343
Note:



35-82087
Regulator
Oval, 3-Pins
150 Amp, S-IG-L

For: Denso Hair Pin Alternators
Used on:
Replaces: 126600-0011
OE: 104210-303, 104210-392; 421000-008*
Lester: 12660, 13992, 23830
Ref: IN6001
Note: * this is Chrysler Minivans.

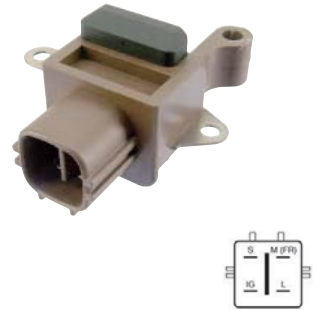

35-82089
Regulator
Square, 4-Pins
Amp, S-IG-L-M (FR)

For: Denso Hair Pin Alternators
Used on:
Replaces: 126600-3000
OE: 104210-205, 104210-347, 104210-420, 104210-423, 104210-487, 104210-492, 104210-514
Lester: 11138, 11139, 11196, 11324, 13984, 24110
Ref: IN6300, AT-10276, W085-291
Note: Without LRC.

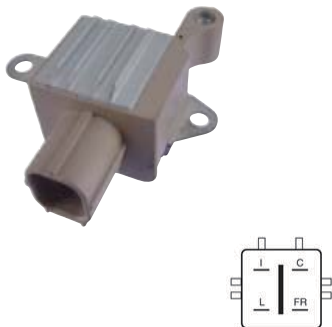

35-82086
Regulator
Square, 4-Pins
IG-C-L-FR

For: Denso Hair Pin Alternators
Used on:
Replaces: 126600-3660
OE: 104210-589
Lester: 11390
Ref: IN6343
Note:

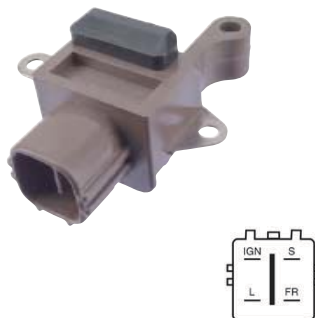

35-82088
Regulator
Square, 4-Pins
150 Amp, IG-S-L-M (FR)

For: Denso Hair Pin Alternators
Used on:
Replaces: 126600-3010
OE: 104210-345, -362, -365, -375, -379, -388, -389, -403, -418, -419
Lester: 11032, 11033, 11034, 11084, 11088, 11195, 11326, 11350, 11351, 11352, 11385, 11386, 11402, 11404, 13981
Ref: IN6301
Note: L-Terminal no Output



35-82090
Regulator
Square, 4-Pins
Amp, S-IG-L-M (FR)

For: Denso Hair Pin Alternators
Used on:
Replaces: 126600-3150
OE: 104210-350, 104210-430, 104210-469
Lester: 11030, 11150, 11151
Ref: IN6315
Note:

35-Regulator

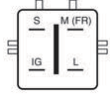

35-82092
Regulator
Square, 4-Pins
12V, Amp, S-IG-L-M (FR)

For: Denso Hair Pin Alternators
Used on:
Replaces: 126600-3230
OE: 104210-447, 104210-457
Lester: 11136, 11137
Ref: IN6323, W085-292, AT-10308
Note: wo/LRC



35-82095
Regulator
, -Pins
12V, Amp,

For: Denso Hair Pin Alternators
Used on:
Replaces: 126600-4200
OE:
Lester:
Ref:
Note:



35-82100
Regulator
Square, 4-Pins
12V, Amp,

For: Denso Hair Pin Alternators
Used on:
Replaces: 126600-3531
OE:
Lester:
Ref:
Note:

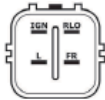

35-82093
Regulator
Square, 4-Pins
12V, Amp, IG-RLO-L-M

For: Denso Hair Pin Alternators
Used on:
Replaces: 126600-3220
OE: 104210-209, 104210-474,
104210-475
Lester: 11322, 11323
Ref: IN6322
Note:



35-82097
Regulator
, -Pins
12V, Amp,

For: Denso Hair Pin Alternators
Used on:
Replaces: 126600-4210
OE:
Lester:
Ref:
Note:

Photo
Coming Soon

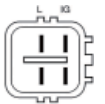

35-82101
Regulator
Square, 4-Pins
12V, Amp, IG-S-L-M(FR)

For: Denso Hair Pin Alternators
Used on: Lexus, Toyota
Replaces: 126600-0150
OE: 104210-338, 104210-339,
104210-344, 104210-346,
104210-393, 104210-400,
104210-451, 104210-511,
104210-802
Lester: 11087, 11090, 11153, 11197,
11198, 13983, 13994, 23317
Ref: IN6015
Note:

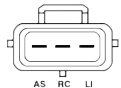

35-82094
Regulator
Oval, 3-Pins
12V, Amp, BVS-RC-LI

For: Denso Hair Pin Alternators
Used on: Ford, Lincoln, Land Rover
Replaces: 126600-3950, 126600-7140
OE: 104210-370, 104210-409,
104210-470, 104210-530
Lester: 11205, 11238, 11430
Ref: IN6601
Note:



35-82099
Regulator
Square, 4-Pins
12V, Amp, C-FR-IG-L

For: Denso Hair Pin Alternators
Used on: Honda Accord, Element
Replaces: 126600-0140,
126600-3200, 126600-3350
OE: 104210-329, 104210-473
Lester: 13980
Ref: IN6335
Note:

Photo
Coming Soon

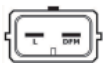

35-82102
Regulator
Square, 2-Pins
12V, Amp, L-DFM

For: Denso Hair Pin Alternators
Used on: Jeep
Replaces: 126600-3531
OE: 104210-317, 104210-324,
104210-424
Lester: 11114, 23229
Ref: IN317
Note: I

35-Regulator



35-82103
Regulator
Square, 4-Pins
12V, Amp, NC-NC-L-FR

For: Denso Hair Pin Alternators
Used on: Saturn
Replaces: 126600-3080
OE: 104210-377, 104210-431
Lester: 11062
Ref: IN6308
Note: L-No Output.

Photo
Coming Soon

35-82106
Regulator
Square, 4-Pins, (to Top)
12V, Amp, IG-C-L-FR

For: Denso Hair Pin Alternators
Used on: Acura, Honda
Replaces: 126600-0040, 126600-0042
OE: 104210-309
Lester: 13918
Ref: IN6004
Note:

Photo
Coming Soon

35-82109
Regulator
Square, 4-Pins, (to Top)
12V, Amp, IG-RLO-L-M

For: Denso Hair Pin Alternators
Used on: Lexus, Toyota
Replaces: 126600-3020, 126600-3320
OE: 104210-474
Lester: 11021, 11322, 11323, 11328, 23947
Ref: IN6302
Note:

Photo
Coming Soon

35-82104
Regulator
Oval, 3-Pins, (to Side)
12V, Amp, S-IG-L

For: Denso Hair Pin Alternators
Used on: Lexus, Toyota
Replaces: 126600-0022, 126600-0023
OE: 104210-304, 104210-312
Lester: 13905, 13927
Ref: IN6002
Note:



Photo
Coming Soon

35-82107
Regulator
Oval, 2-Pins
12V, Amp, F-L

For: Denso Hair Pin Alternators
Used on: Buick, Cadillac, Chevy, Pontiac
Replaces: 126600-0090
OE:
Lester: 11003, 11036, 11146
Ref: IN6009
Note:



35-82110
Regulator
Oval, 2-Pins, (to Top)
12V, Amp, F-L

For: Denso Hair Pin Alternators
Used on: Buick, Cadillac, Chevy, GMC, Pontiac, Saturn
Replaces: 126600-3240, 126600-3440
OE:
Lester: 11044, 11046, 11110, 11140, 1117, 11179, 11180, 11181, 11248, 11251, 11252, 11369
Ref: IN6324
Note:



35-82105
Regulator
Oval, 3-Pins
12V, Amp, S-F-L

For: Denso Hair Pin Alternators
Used on: Buick, Cadillac, Pontiac
Replaces: 126600-0030, 126600-0031
OE: 104210-330, 104210-454
Lester: 11035, 13919
Ref: IN6003
Note:

Photo
Coming Soon

35-82108
Regulator
Oval, 3-Pins
12V, Amp, S(AS)-L(IG)-AM(LI)

For: Denso Hair Pin Alternators
Used on: Ford, Lincoln
Replaces: 126600-0110
OE: 104210-321, 104210-416
Lester: 11000, 13978
Ref: IN6011
Note:



35-Regulator



**Photo
Coming Soon**

**35-82111
Regulator
Oval, 2-Pins, (to Top)
12V, Amp, F-L**

For: Denso Hair Pin Alternators
Used on: Chevy, Pontiac, Saturn
Replaces: 126600-3290
OE: 104210-216, 104210-289, 104210-456, 104210-507, 104210-525, 104210-538, 104210-541
Lester: 11156, 11183, 11237, 11250
Ref: IN6329
Note: for GM RVS system

**Photo
Coming Soon**



**35-82112
Regulator
Oval, 3-Pins
12V, Amp, LI-RC-BVS**

For: Denso Hair Pin Alternators
Used on: Land Rover
Replaces: 126600-3490
OE: 104210-369, 104210-371
Lester: 11206, 24028
Ref: IN6349
Note:



**35-82113
Regulator
Square, 4-Pins, (to Top)
12V, Amp, IG-C-L-FR**

For: Denso Hair Pin Alternators
Used on: Honda
Replaces: 126600-3650
OE: 104210-591
Lester: 11392
Ref: IN6365
Note:



**Photo
Coming Soon**

**35-82117
Regulator
Oval-3 Pins
12V, Amp, AS-RC-LI**

For: Denso Hair Pin Alternators
Used on: Ford, Mercury
Replaces:
OE:
Lester: 11368, 11427, 11428, 11433, 11526, 11532, 11625, 11627, 11628, 11629, 11664, 11665, 14019-1, 14020
Ref: AE-1047, VRH2005-177
Note: PCM



**35-82116
Regulator
Single-Pins
12V, Amp,**

For: Denso Hair Pin Alternators
Used on: Acura, Honda
Replaces: 126600-3970
OE: 104210-149, 104210-153
Lester: 11604, 11768
Ref: AH-10138, VRH2005-190
Note: Single Pin LIN Control

46-Terminal Block



46-82172
Terminal Block

For: Denso Hair Pin Alternators
Used on:
Replaces:
OE: 421000-081
Lester: 11241, 11243, 11285, 11294, 11295, 11296, 11297, 11298, 11378, 11379, 11449
Note: Ref to 46-82208



46-82214
Terminal Block

For: Denso Hair Pin Alternators
Used on:
Replaces: 126220-0230
OE: 421000-014, 421000-030
Lester: 11063
Note: Ref to 46-82205

**Photo
Coming Soon**

46-82233
Terminal Block

For: Denso Aluminum Type Alternators
Used on: Dodge
Replaces:
OE:
Lester: 11094
Note: Ref to 46-82206



46-82198
Terminal Block

For: Denso Hair Pin Alternators
Used on:
Replaces: 126220-0180
OE: 421000-001- 421000-002, 421000-003
Lester: 13867, 13870, 13871
Note: Ref to 46-82203, INP421



46-82215
Terminal Block

For: Denso Hair Pin Alternators
Used on:
Replaces: 126220-0190, 126220-0191
OE: 421000-010
Lester: 11039, 11040, 11048, 11112, 11113, 13912, 13913, 13914, 13915, 13923
Note: Ref to INP420

**Photo
Coming Soon**

46-82234
Terminal Block
F(FLD), B+ Terminal

For: Denso Aluminum Type Alternators
Used on: Jeep
Replaces:
OE:
Lester: 11242
Note: Ref to 46-82209



46-82201
Terminal Block

For: Denso Hair Pin Alternators
Used on: Chrysler, Dodge
Replaces:
OE: 421000-047, 421000-053, 42000-062, 421000-063, 421000-075, 421000-702, 421000-704
Lester: 11240, 11276, 11382, 11383, 11572, 11575, 11598
Note: Ref to 46-82207



46-82217
Terminal Block

For: Denso Hair Pin Alternators
Used on:
Replaces:
OE: 104210-405, 421000-006, 421000-021, 421000-036
Lester: 11093, 11155, 13868, 13988
Note: Ref to 46-82204

46-Terminal Block

--	--	--

Manufacturers and Supplier names and their part numbers are for reference use only.

38-, 39-, 41- Brush Holder & Seals



38-82001

Brush-Brush Holder

For: Denso Hair Pin Alternators
DIM: 5mm T x 7mm W x 15mm L x 48mm LL

Replaces:

OE:

Lester:

Note: Used on most Denso Brush Holder
 Ref to 38-8201, AT-05325A



39-82007

Brush Holder Assy Early Type

For: Denso Hair Pin Alternators

Used on:

Replaces: 021620-3001

OE:

Lester:

Note: Used w/41-82007 Gasket (Seals)
 Ref to 39-8207



39-82008

Brush Holder Assy Late Type

For: Denso Hair Pin Alternators

Used on:

Replaces: 021620-3020

OE:

Lester: 11032, 11034, 11044, 11046, 11062, 11088, 11109, 11136, 11137, 11138, 11140, 11146, 11156, 11179, 11180, 11201, 11240, 11244, 11382, 11383, 11430, 11431, 11508, 11513, 11776, 12660 (Late), 13868, 13870, 13871, 13980

Note: Ref to 39-8206



39-82008-1

Brush Holder Assy Late Type

For: Denso Hair Pin Alternators

Used on:

Replaces:

OE: 104210-304, 104210-314, 104210-409; 421000-001, 421000-006

Lester: 11238, 11382, 11383, 13927, 13963,,13868, 13871

Note: Ref to

Photo Coming Soon

39-82008-2

Brush Holder Assy Late Type

For: Denso Hair Pin Alternators

Used on:

Replaces:

OE:

Lester: 11572

Note: Ref to

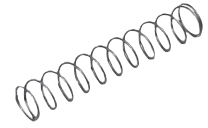

39-82005

Spring-Brush Holder

For: Denso Hair Pin Alternators

DIM: 0.35 x 38mm L

Replaces:

OE:

Lester: 11063, 11116; 12066, 179, 180, 182, 183, 184, 187, 189, 190, 192, 195, 196, 198, 199, 204, 205, 209, 210, 270, 346; 13184, 185, 214, 220, 229, 234, 239, 240, 241, 245, 252, 255, 256, 276, 277, 278, 280, 294, 301, 302, 304, 305, 306, 307, 308, 309, 310, 311, 312, 313, 316, 319, 321, 322, 323, 325, 331, 338, 339, 341, 353, 354, 383, 384, 385, 386, 387, 388, 389, 390, 391, 393, 394, 395, 396, 397, 398, 407, 408, 409, 410, 413, 414, 419, 423, 424, 440, 442, 443, 444, 453, 454, 455, 456, 457, 481, 482, 485, 486, 487, 489, 492, 495, 496, 497, 498, 499, 501, 502, 503, 506, 507, 509, 512, 519, 521, 522, 524, 525, 529, 537, 538, 539, 540, 545, 546, 547, 548, 551, 552, 553, 556, 557, 558, 562, 569, 578, 592, 593, 594, 659, 668, 669, 670, 671, 673, 674, 675, 677, 679, 680, 684, 685, 687, 688, 690, 705, 706, 711, 714, 715, 722, 732, 737, 738, 740, 741, 742, 743, 746, 747, 748, 754, 755, 756, 763, 765, 766, 767, 769, 776, 790, 791, 794, 806, 809, 822, 823, 824, 834, 842, 844, 856, 858, 867, 868, 869, 870, 871, 873, 874, 878, 879, 880, 885, 896, 906, 910, 912, 913, 914, 919, 923, 964; 14449, 453, 454, 455, 457, 458, 460, 472, 611, 643, 668, 671, 674, 678, 679, 680, 682, 683, 684, 732, 733, 739, 755, 756, 757, 759, 843, 847, 849, 851, 852, 855, 857, 869, 870, 872, 926, 930, 931, 935, 937, 939, 940, 941, 974, 989

Note: Used w/39-82001, 39-82002, 39-82003, 39-82007, 39-82008, 39-82009
 Ref to 39-82700

38-, 39-, 41- Brush Holder & Seals



39-82010

Cover-Brush Holder Early Type use

For: Denso Hair Pin Alternators

Used on:

Replaces:

OE:

Lester:

Ref:

Note: Used on 39-82007 Early Type
Brush Holder
Ref to



39-82011

Cover-Brush Holder Late Type use

For: Denso Hair Pin Alternators

Used on:

Replaces:

OE:

Lester:

Ref: AT-06274C

Note: Used on 39-82008, 39-82008-1
Late Type Brush Holder
Ref to 46-82483

38-, 39-, 41- Brush Holder & Seals



41-82003

Seal-Brush Holder 80-120 Amp Alternators

For: Denso Hair Pin Alternators
DIM: 19mm ID, 26mm W, 35mm OL
Replaces: 021626-0080,
 021626-0190

OE:

Lester: 12066, 12194, 12195, 13252,
 13276, 13278, 13321, 13323,
 13325, 13506, 13507, 13857,
 13878... etc

Note: Orange Color.

For thinner use 41-82008.



41-82008

Gasket-Brush Holder 80-160 Amp Alternators

For: Denso Hair Pin Alternators
DIM: 19mm ID, 26mm W, 35mm OL
 1mm Thickness
Replaces: 021626-0080,
 021626-0190

OE:

Lester: 12066, 12194, 12195, 13252,
 13276, 13278, 13321, 13323,
 13325, 13506, 13507, 13857,
 13878... etc

Note: Orange Color.

For thicker use 41-82003.



41-82007

Gasket-Brush Holder 120-160 Amp

For: Denso Hair Pin Alternators
Used on:

Replaces: 021626-0510
OE: 104210-303, 104210-306,
 104210-307, 104210-309,
 104210-328, 104210-344,
 104210-347, 104210-387,
 104210-392, 104210-393;
 121000-429; 421000-001,
 421000-002, 421000-003,
 421000-004, 42100-005,
 421000-006, 421000-008,
 421000-010,, 421000-011,
 421000-018

Lester: 13867, 13870, 13871,
 13912, 13913, 13914,
 13919, 13923

Note: Used w/39-82007 Early TYPe
 Brush Holder.

Ref to 41-82103, W115-156



41-82009

Seal-Brush Holder 80-160 Amp Alternators

For: Denso Hair Pin Alternators
DIM: 19mm ID, 26mm W, 35mm OL
Replaces:

OE:

Lester:

Note: Orange Color.

42-Insulators



42-82048

Insulator-B+ Terminal-for side M8 Post

For: Denso Hair Pin Alternators
DIM: 14mm ID, 25.7mm OD,
16.8mm OAL

Replaces:

OE: 104210-424, 104210-433,
104210-442; 121000-252;
421000-001, 421000-004,
421000-010, 421000-022,
421000-043, 421000-047

Lester: 11110, 11114, 11140, 11240,
11276, 13868, 13870, 13871,
13912, 13913

Note Ref to 42-82325, W115-153
2 slot



42-82050

Insulator-B+ Terminal-for side M8 Post

For: Denso Hair Pin Alternators
DIM: 14mm ID, 28mm OD,
17mm Height

Replaces: 021605-3050,
021605-3110

OE: 421000-065, 421000-081 etc

Lester: 11059, 11063, 11109, 11297,
11298, 11367, 11378, 11401, 11449,
13867, 13868, 13870, 13871, 13912,
13913

Note: Ref to 42-82323
AZ-1895C
4 slot



42-82053

Insulator-B+ Terminal-for side

For: Denso Hair Pin Alternators

DIM: 17.5mm ID

Replaces:

OE: 421000-700

Lester: 11379

Note: Ref W115-210



42-82049

Insulator-B+ Terminal-for top M8 Post

D-Shape Interlock

For: Denso Hair Pin Alternators
DIM: 14mm ID, 28mm OD, 15mm
Height

Replaces: 021605-3080,
021605-3120

OE: 421000-003, 421000-011,
421000-012, 421000-075

Lester: 11039, 11040, 11112, 11113,
11155, 11241, 11244, 11401, 11570,
11572, 13867,
13914, 13915, 13923

Note: Ref to 42-82327, W115-224
4 slot



42-82051

Insulator-B+ Terminal-for top D-Shape

For: Denso Hair Pin Alternators
DIM: 14mm ID, 17.4mm Height

Replaces:

OE: 104210-329, 104210-473,
104210-516

Lester: 11154, 13980

Note: used w/46-82169 SRE Cover.
Ref to W115-163



42-82051-1-for top

Insulator-B+ Terminal

For: Denso Hair Pin Alternators

DIM: 14mm ID, 17.4mm Height

Replaces:

OE: 104210-329

Lester: 13980

Note: used w/46-82169 SRE Cover.
Ref to W115-163

42-Insulators



42-82056

Insulator-B+ Terminal D-Shape Interlock

For: Denso Hair Pin Alternators
Dim: 14.5mm ID, 18mm Height
Replaces:
OE:
Lester:
Note:



42-82057

Insulator-B+ Terminal-for Top D-Shape Interlock

For: Denso Hair Pin Alternators
DIM: 14mm ID, 24mm Height
Replaces:
OE: 104210-589
Lester: 11390
Note:



42-82058

Insulator-B+ Terminal-for Top D-Shape Interlock

For: Denso Hair Pin Alternators
DIM: 14.8mm ID, 37.3mm Height
 27mm OD
Replaces:
OE:
Lester:
Note: Similar to 42-82066, but the top
 open on different direction.



42-82059

Insulator-B+ Terminal-for side M6Post

For: Denso Hair Pin Alternators
DIM: 12.5mm ID, 25.5mm OD
 16.8mm Height
Replaces:
OE:
Lester: 11032, 11033, 11136, 11138,
 11195, 11201, 11326, 11386, 11404,
 11516, 11776, 13905, 13927, 13983,
 13994, 23317
Note: Ref 42-82335, W115-173,
 AT-18266C, 4 slot

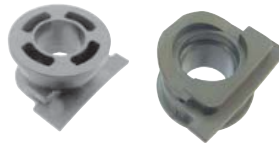

42-82059-1

Insulator-B+ Terminal-for side M6 Post

For: Denso Hair Pin Alternators
DIM: 12.5mm ID, 25.5mm OD
 16.8mm Height
Replaces:
OE:
Lester: 11032, 11033, 11136, 11138,
 11195, 11201, 11386, 11404, 11516,
 13905, 13927, 23317
Note: Ref 42-82335, W115-173
 4 slot



42-82060

Insulator-B+ Terminal D-Shape Interlock

For: Denso Hair Pin Alternators
DIM: 14.6mm ID, 26mm Height
Replaces:
OE:
Lester:
Note:



42-82061

Insulator-B+ Terminal-for side

For: Denso Hair Pin Alternators
DIM: 16.2mm ID, 28.8mm Height
Replaces:
OE: 104210-351, 104210-356,
 104210-405, 104210-464
Lester: 11054, 11093, 23820
Note: Ref W115-214



42-82063

Insulator-B+ Terminal-for Top D-Shapr Interlock

For: Denso Hair Pin Alternators
DIM: 14.5mm ID, 24.6mm,
 19.6mm H
Replaces:
OE:
Lester: 11178, 11183, 11387, 11524,
 11591, 11686
Note: AN-18148C, 4 slot



42-82064

Insulator-B+ Terminal-for side D-Shape Interlock

For: Denso Hair Pin Alternators
DIM: 14.5mm ID, 17.2mm Deep,
 35mm OAL
Replaces:
OE: 104210-310, 104210-350,
 104210-377, 104210-429,
 104210-430, 104210-469,
 104210-592
Lester: 11030, 11062, 11099, 11150,
 11151
Note: Ref to W115-189

42-Insulators



42-82066

Insulator-B+ Terminal-for Top D-Shape Interlock

For: Denso Hair Pin Alternators
DIM: 14.7mm ID, 37.25mm Height, 20.7mm Deep
Replaces: 021605-3190
OE:
Lester: 13918
Note: Ref W115-154
 Similar to 42-82058, but top open on different direction.

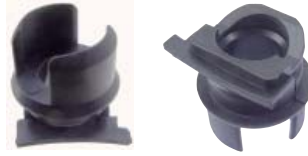

42-82070

Insulator-B+ Terminal-for Side

For: Denso Hair Pin Alternators
DIM: 14.6mm ID, 32.5mm Height 33mm OAL
Replaces:
OE: 104210-582
Lester: 11292, 11293
 Ref: W115-223, AE-1864C
Note: Similar to 42-82085, 42-82086, but different ID and open.



42-82073

Insulator-B+ Terminal-for Side

For: Denso Hair Pin Alternators
DIM: 12mm ID, 22.2mm Height 20mm OD
Replaces:
OE: 104210-296, 104210-321, 104210-416
Lester: 11000, 11621
Note: Ref W115-220



42-82068

Insulator-B+ Terminal-for Top D-Shape Interlock

For: Denso Hair Pin Alternators
Dim: 8.6mm ID, 27.1mm Height
Replaces:
OE:
Lester:
Note: Ref



42-82071

Insulator-B+ Terminal D-Shape Interlock

For: Denso Hair Pin Alternators
Dim: 14.6mm ID, 26.25mm Height
Replaces:
OE:
Lester:
Note: Ref



42-82075

Insulator-B+ Terminal-for Side D-Shape Interlock

For: Denso Hair Pin Alternators
DIM: 14.5mm ID, 30mm OAL
Replaces:
OE:
Lester:
Note: Ref



42-82069

Insulator-B+ Terminal-for Top D-Shape Interlock

For: Denso Hair Pin Alternators
DIM: 17.75mm ID, 28.75mm Height
Replaces:
OE: 104210-6100, 104210-6103, 104210-634
Lester: 11290, 11630
Note: Ref W115-221



42-82072

Insulator-B+ Terminal-for Side D-Shape Interlock

For: Denso Hair Pin Alternators
DIM: 14.75mm ID, 27.1mm Height 35.3mm OAL
Replaces:
OE: 104210-591, 104210-592
Lester: 11391, 11392
Note: Ref W115-222
 w/key slot



42-82076

Insulator-B+ Terminal-for Side

For: Denso Hair Pin Alternators
DIM: 12.5mm ID, 28mm Height
Replaces:
OE:
Lester:
Note: Ref

42-Insulators



42-82080
Insulator-B+ Terminal-for Side D-Shape for M6 Post

For: Denso Hair Pin Alternators
DIM: 14.39mm ID, 26.78mm OD
 29.91mm Height, 26.78mm Hole
Replaces:
OE: 104210-543
Lester: 11291
Note: Ref

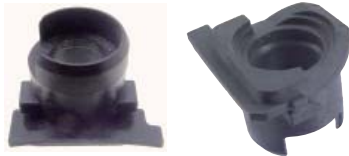

42-82081
Insulator-B+ Terminal-for Side for M6 Post

For: Denso Hair Pin Alternators
DIM: 12mm ID, 22mm Height
Replaces:
OE: 104210-563
Lester: 11431
Note: Ref



42-82082
Insulator-B+ Terminal-for Top D-Shape for M8 Post

For: Denso Hair Pin Alternators
DIM: 17.5mm ID, 15mm Height
Replaces:
OE: 421000-704, 421000-705
Lester: 11592, 11598
Note: Ref



42-82084
Insulator-B+ Terminal-for Side for M8 Post

For: Denso Hair Pin Alternators
DIM: 17.6mm ID, 24.7mm Height
Replaces:
OE: 104210-640
Lester: 14204
Note: Ref



42-82085
Insulator-B+ Terminal-for Side for M6 Post

For: Denso Hair Pin Alternators
DIM: 17mm ID, mm Height
 31.5mm OAL
Replaces:
OE:
Lester:
Ref:
Note: Similar to 42-82070, 42-82086, but different ID and open.



42-82086
Insulator-B+ Terminal-for Side for M6 Post

For: Denso Hair Pin Alternators
DIM: 17mm ID, mm Height
 31.5mm OAL
Replaces:
OE: 104210-622
Lester: 11434, 11575, 11627, 11645, 11665, 11667, 12884, 14009, 14019-1, 14020
Ref:
Note: Similar to 42-82070, 42-82085, but different ID and open.



42-82088
Insulator-B+ Terminal-for Side D-Shape for M8 Post

For: Denso Hair Pin Alternators
DIM: 14.5mm ID, 30.5mm OD
 15.1mm L
Replaces:
OE:
Lester:
Note: Ref

46-SRE Cover



46-82165
SRE Cover

For: Chrysler
DIM: : 127mm OD
Replaces: 021551-3471, 021551-3680
OE: 421000-005, 421000-011, 421000-018, 421000-019, 421000-020
Lester: 11039, 11040*, 11048, 11244, 11383, 13914, 13915
Note: Early Type
 *11040 Late Type use 46-82207
 Ref 46-82486, W015-49
 - Similar to 46-82187, ut inside Brush Holder area different.



46-82164
SRE Cover

For: Chrysler
DIM: 127mm OD
Replaces:
OE: 421000-006
Lester: 13868
Note: Early Type. For Late Type use 46-82176.
 Ref 46-82487



46-82168
SRE Cover

For: Chrysler
DIM: 128mm OD
Replaces: 021551-3500
OE: 421000-003, 421000-008, 421000-012
Lester: 13867, 13923, 23830
Note: Early Type
 Ref to W015-56, AZ-1384

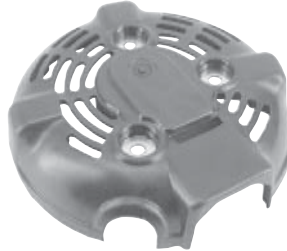

46-82166
SRE Cover

For: Toyota
DIM: 127mm OD
Replaces:
OE: 104210-304, 104210-312
Lester: 13905, 13927
Note: Early Type
 Ref to W015-55



46-82165-1
SRE Cover

For: Chrysler
DIM: : 127mm OD
Replaces: 021551-3471, 021551-3680
OE: 421000-005, 421000-011, 421000-018, 421000-019, 421000-020
Lester: 11039, 11040*, 11048, 11244, 11383, 13914, 13915
Note: Early "q" Type
 *11040 Late Type use 46-82207
 Ref 46-82486



46-82167
SRE Cover

For: Chrysler
DIM: 127mm OD
Replaces: 021551-3450, 021551-3451
OE: 421000-001, 421000-002
Lester: 13870, 13871
Note: Early Type.
 Ref 46-82475, W015-47, AZ-1378



46-82169
SRE Cover

For: Honda
DIM: 127mm OD
Replaces: 021551-4120
OE: 104210-329, 104210-473, 104210-516
Lester: 11154, 13980
Note: Late Type
 Ref to W015-53, 46-82495
 Similar to 46-82191, but different Regulator hole opening.

46-SRE Cover



46-82170
SRE Cover

For: GM
DIM: 127mm OD
Replaces: 021551-3491
OE: 104210-306, 104210-307
Lester: 13919
Note: Early Type.
 Ref to 46-82477, W015-50
 AJ-13100



46-82174
SRE Cover

For: Toyota
DIM: 128mm OD
Replaces:
OE: 104210-339, 104210-368,
 104210-451, 104210-511, 104210-512,
 104210-619
Lester: 11090, 11153, 11198, 13994*
Note: Late Type.
 Ref to W015-77, AT-13274
 *Early type use 46-82189.
 Similar to 46-82245, but 46-82245 is
 43mm Height.



46-82176
SRE Cover

For: Chrysler
DIM: 128mm OD
Replaces: 021551-4030
OE: 421000-014, 421000-021, 421000-
 023, 421000-028, 421000-030,
 421000-038, 421000-041,
 421000-081
Lester: 11063, 11243, 11285, 11294.
 11295, 11296, 11297, 11298, 11378,
 11449, 11584, 13868*, 13988
Note: *Late Type.
 13868 for Early Type use 46- 82164.
 Ref to 46-82473, W015-54, AZ-1388.



46-82173
SRE Cover

For: Chrysler
DIM: 128mm OD
Replaces: 021551-4381
OE: 421000-022, 421000-047,
 421000-049, 421000-050,
 421000-053, 421000-059
Lester: 11240, 11276, 13870, 13871
Note: Late Type.
 Ref to 46-82474, W015-83



46-82175
SRE Cover

For: Toyota
DIM: 128mm OD
Replaces: 021551-4180, 021551-4650
OE: 104210-227, 104210-234, 104210-
 345, 104210-362, 104210-365, 104210-
 375, 104210-378, 104210-379, 104210-
 388, 104210-389, 104210-492
Lester: 11032, 11033, 11034, 11084,
 11088, 11136, 11137, 11138, 11139,
 11195, 11196, 11201, 11322, 11323,
 11324, 11326, 11350, 11351, 11352,
 11352, 11384, 11385, 11386, 11400,
 11402, 11403, 11404, 11407, 11408,
 11519, 11577, 13905, 13981, 13984
Note: Late Type
 Ref to W015-65



46-82177
SRE Cover

For: Chrysler
DIM: 127mm OD
Replaces: 021551-3460
OE: 421000-004, 421000-010
Lester: 13912, 13913
Note: Early Type.
 Ref 46-82476, W015-45

46-SRE Cover



46-82179
SRE Cover

For: Opel
DIM:
Replaces:
OE:
Lester: 23806, 23808
Note: Europe



46-82181
SRE Cover

For: Ford, Lincoln, Mustang
DIM: 128mm
Replaces:
OE: 104210-111, 104210-297,
104210-330, 104210-563, 104210-
586, 104210-596
Lester: 11204, 11292, 11431,
11432, 11623, 11776
Note: Late Type



46-82183
SRE Cover

For: Ford
DIM: 128mm
Replaces:
OE: 104210-351, 104210-363,
104210-376
Lester: 23820, 23839, 23912
Note: Late Type. Europe



46-82180
SRE Cover, 180 Amp

For: Toyota
DIM: 137.5mm
Replaces:
OE: 104210-614
Lester: 11405
Note: Late Type.
Ref to W015-92



46-82182
SRE Cover

For: Denso Hair Pin Alternators
DIM: 114.5mm
Replaces:
OE: 104210-9060
Lester:
Note: Late Type



46-82185
SRE Cover

For: Denso Hair Pin Alternators
DIM: 128mm
Replaces:
OE:
Lester:
Note: Early Type

46-SRE Cover



46-82186
SRE Cover

For: Denso Hair Pin Alternators
DIM : 128mm
Replaces:
OE:
Lester:
Note: Early Type



46-82189
SRE Cover

For: Toyota
DIM: 128mm OD
Replaces:
OE: 104210-344, 104210-346,
104210-400
Lester: 11087, 11197, 13983, 13994
Note: Early Type
Ref to W015-59.
Late type use 46-82174.



46-82191
SRE Cover

For: Honda
DIM: 128mm
Replaces:
OE:
Lester: 11390
Note: Late Type
Similar to 46-82169, but different
Regulator hole opening.



46-82188
SRE Cover

For: Ford
DIM: 128mm
Replaces: 021551-4330
OE: 104210-356, 104210-370,
104210-464, 104210-271, 104210-
352, 104210-405
Lester: 11054, 11093, 11205, 23821
Note: Late Type.
Ref to W015-95



46-82190
SRE Cover

For: Denso Hair Pin Alternators
DIM: 128mm
Replaces:
OE: 104210-369, 104210-370,
Lester: 11206
Note: Late Type
Ref to W015-93



46-82192
SRE Cover

For: John Deere, Toyota
DIM: 128mm OD
Replaces: 021551-3600
OE: 104210-303, 104210-3920 (Early)
Lester: 12660 (Early), 13992
Note: Early Type
Ref to W015-79, AT-13284.
Late use 46-82206.

46-SRE Cover



46-82187
SRE Cover

For:
DIM: 128mm OD
Replaces:
OE:
Lester: 13914, 13915
Note: Early Type
- Similr to 46-82165, but Brush Holder area different.



46-82195
SRE Cover

For: GM
DIM: 128mm OD
Replaces: 021551-4450
OE: 104210-328, 104210-330,
104210-334, 104210-435,
104210-454, 104210-499
Lester: 11003, 11035, 11036, 11037,
11046, 11146
Note: Late Type
Ref to W015-67, 46-824101.



46-82197
SRE Cover

For: GM, Suzuki
DIM: 128mm
Replaces:
OE:
Lester: 11156, 11183, 11237, 11250
Note: Late Type.
Ref to W015-91, AJ-13151.



46-82194
SRE Cover

For: Denso Hair Pin Alternators
DIM: 128mm
Replaces:
OE: 104210-308, 104210-504
Lester: 13979
Note: Late Type
Ref to W015-58



46-82196
SRE Cover

For: GM
DIM: 128mm OD
Replaces:
OE: 104210-433, 104210-442
Lester: 11110, 11140
Note: Late Type.
Ref to W015-74



17.8mm ID

46-82202
SRE Cover, 170-220 Amp

For: GM
DIM: 137.5mm OD
Replaces: 137.5mm
OE: 104210-600, 104210-601,
104210-616
Lester: 11181, 11251, 11252
Note: Late Type.
Ref to W015-98

46-SRE Cover



46-82203 SRE Cover

For: Denso Hair Pin Alternators
DIM: 128mm
Replaces:
OE:
Lester:
Note: Late Type



46-82205 SRE Cover

For: GM
DIM: 128mm
Replaces:
OE: 104210-319, 104210-326,
 104210-332, 104210-435,
 104210-443
Lester: 11038, 11044, 11046
Note: Late Type.
 Ref to W015-78



46-82207 SRE Cover

For: Chrysler
DIM: 128mm
Replaces:
OE: 421000-080, 421000-015,
 421000-025, 421000-026, 421000-033,
 421000-034, 421000-037,
 421000-062, 421000-063, 421000-065,
 421000-075
Lester: 11040*, 11112, 11113,
 11244*, 11382, 11383*,
 11401, 11572, 11574
Note: Late Type
 *11040, 11244, 11383 Early Type
 use 46-82165.
 Ref W015-75



46-82204 SRE Cover

For: Toyota
DIM: 114.5mm
Replaces:
OE: 104210-802
Lester: 23317
Note: Late Type. Europe
 85Amp Type use



46-82206 SRE Cover

For: Land Rover
DIM: 128mm
Replaces:
OE: 104210-371, 104210-3921 (Late)
Lester: 12660 (Late), 24028
Note: Late Type. Europe
 Early type use 46-82192.



46-82210 SRE Cover-220 Amp

For: Chrysler, Dodge Ram
DIM: 137.5mm
Replaces:
OE: 421000-700, 421000-714
Lester: 11379, 11380, 11775
Note: Late Type.
 Ref to W015-99.

46-SRE Cover



46-82213
SRE Cover-220 Amp

For: Chrysler, Dodge
DIM: 137.5mm
Replaces:
OE: 104210-610
Lester: 11290
Note: Late Type



46-82218
SRE Cover- Amp

For: Chrysler, Dodge
DIM: 129mm
Replaces:
OE: 104210-124, 104210-591, 104210-592
Lester: 11391, 11392, 11573
Note: Late Type, Ref W015-97



46-82211
SRE Cover- Amp

For:
DIM: 128mm
Replaces:
OE: 421000-018
Lester: 11048
Note: Early Type



46-82216
SRE Cover- Amp

For: Chrysler, Dodge
DIM: mm
Replaces:
OE:
Lester:
Note: Late Type



46-82219
SRE Cover- Amp

For: Ford Lincoln
DIM: 128mm
Replaces:
OE: 104210-321, 104210-416
Lester: 11000
Note: Late Type

46-SRE Cover



46-82220
SRE Cover- Amp
For: Ford Lincoln, John Deere
DIM: 127mm OD
Replaces: 021551-3560
OE: 104210-309, 104210--393
Lester: 13918
Note: Early Type
 Ref W015-57, AH-13107.



46-82223
SRE Cover- Amp
For:
DIM: 128mm OD
Replaces:
OE: 104210-350*
Lester: 11030*, 11099, 11150
Note: *11030 has two type SRE Cover.
 Type
 Ref



46-82225
SRE Cover- Amp
For: Ford
DIM: 128mm OD
Replaces:
OE: 104210-543
Lester: 11291
Note: Late Type
 Ref



46-82222
SRE Cover- 220Amp
For: Ford
DIM: 138mm OD
Replaces:
OE: 104210-627, 104210-634,
 104210-666, 104210-677
Lester: 11532, 11627, 11645, 11679
Note: Late Type
 Ref AE-1370



46-82224
SRE Cover- Amp
For:
DIM: 128mm OD
Replaces:
OE: *104210-4480, *104210-4481,
 104210-469
Lester: 11030*, 11151
Note: *11030 has two type SRE Cover.
 Type
 Ref



46-82226
SRE Cover- Amp
For:
DIM: mm OD
Replaces:
OE:
Lester:
Note: Late Type
 Ref

46-SRE Cover



46-82227
SRE Cover- Amp

For:
DIM: 127mmOD
Replaces:
OE:
Lester:
Note: Late Type



46-82229
SRE Cover- Amp

For: European Hyundai, Kia
DIM: 127mm OD
Replaces:
OE: 104210-391, 104210-486, 104210-581, 104210-620
Hyundai 37200-3C552
Lester: 11387, 11766, 11523, 23971
Note: Late Type
Ref: AN-13122



14mm ID

46-82231
SRE Cover- Amp

For: Buick
DIM: 128mm
Replaces:
OE: 104210-200, 104210-436, 104210-437, 104210-540, 104210-599
Lester: 11178, 11179, 11180, 11369, 11508, 11513
Note: Late Type
Ref: W015-80
B+ Insulator Height 15mm



46-82228
SRE Cover- Amp

For:
DIM: 127mm OD
Replaces:
OE:
Lester:
Note: Late Type



46-82230
SRE Cover- Amp

For:
DIM: 114.5mm OD
Replaces:
OE:
Lester:
Note: Late Type



46-82235
SRE Cover- Amp

For: Jeep
DIM: 128mm OD
Replaces: 421000-036, 421000-055
OE:
Lester: 11155, 11241
Note: Late Type
Ref: AZ-13105, W015-82

46-SRE Cover



46-82236
SRE Cover- 195 Amp
For: Ford Truck
DIM: 138mmOD
Replaces:
OE: 104210-6181, 104210-634,
104210-667
Lester: 11434, 11624, 11630
Note: Late Type



46-82238
SRE Cover- 180-220 Amp
For: Chrysler, Dodge
DIM: 138mmOD
Replaces:
OE: 421000-702, 421000-703,
421000-704, 421000-705
Lester: 11575, 11576, 11592, 11598
Note: Late Type



46-82240
SRE Cover- Amp
For: BMW-European
DIM: mmOD
Replaces:
OE: 104210-633
Lester: 24111
Note: Late Type

**Photo
Coming Soon**



46-82237
SRE Cover- 150 Amp
For: Jeep
DIM: 128mmOD
Replaces:
OE: 104210-424
Lester: 11114
Note: Late Type
Ref: AZ-1398, W015-89



46-82239
SRE Cover- Amp
For:
DIM: mmOD
Replaces:
OE:
Lester:
Note: Late Type

46-82241
SRE Cover- 150 Amp
For: Hyundai
DIM: 128mmOD
Replaces:
OE: 104210-180
Lester: 11591, 11686
Note: Late Type
Ref: AN-13148

46-SRE Cover



46-82242
SRE Cover- Amp

For:
DIM: 138mm OD
Replaces:
OE:
Lester:
Note: Type

**Photo
Coming Soon**

46-82244
SRE Cover- 170 Amp

For: Chevy & GMC Truck
DIM: 138mm OD
Replaces:
OE: 104210-687
Lester: 14009
Note: Late Type



46-82243
SRE Cover- 225 Amp

For: Ford Truck
DIM: 138mm OD
Replaces:
OE: 104210-607, 104210-667
Lester: 11496, 11624, 11629, 11630, 11667, 12884
Note: Type



46-82245
SRE Cover- Amp

For: Acura, Honda, Saturn
DIM: 128mm OD
Replaces:
OE: 104210-310, 104210-350, 104210-377, 104210-429, 104210-430, 104210-431, 104210-448, **104210-469**
Lester: 11030, 11062, 11099, 11150, 11151
Note: Late Type
Ref W015-68, AH-13123
Similar to 46-82174, but 46-82174 is 31mm Height.

10-Bearing & 46-Bearing Retainer Parts



10-304240

Bearing-DE Housing

For: Denso Hair Pin Alternators
DIM: 17mm ID x 52mm OD x 16mm W
Replaces: #333
OE:
Lester:
Note:



10-202140K (Koyo Brand)

Bearing-SRE Housing

For: Denso Hair Pin Alternators
DIM: 15mm ID x 35mm OD x 13mm W
Replaces: #279
OE:
Lester:
Note: Ref to 10-2021-4
 10-202140S NSK Brand
 10-202140T NTN Brand



6-30340K

Bearing-DE Housing

For: Denso Hair Pin Alternators
DIM: 17mm ID x 47mm OD x 14mm W
Replaces: #6303
OE:
Lester: 11005, 11033
Note:

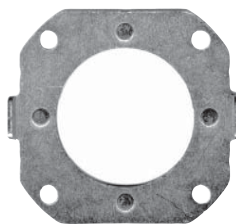

46-82003

Bearing Retainer-DE Housing

For: Denso Hair Pin Alternators
DIM: 34mm ID, 53mm OD
 M4 Mounting Hole
Replaces: 021411-0450
OE:
Lester: 13229, 13508, 13673, 13680,
 13678, 13870, 13871, 14449,
 14452, 14611, 14668, 14755,
 14757, 14989 ... etc
Note: Ref to 46-82502, AT-1755
 Used on DE 21-82084, 21-82085,
 21-82086, 21-82087, 21-82088,
 21-82089, 21-82095, 21-82097,
 21-82098
 Screw use 84-82008



46-82039

Bearing Retainer-DE Housing

For: Denso Hair Pin Alternators
DIM: 37mm ID, 61.5mm OD
Replaces: 021411-0450
OE:
Lester:
Note: Ref to 46-82500
 Used on DE 21-82096
 Screw use 84-82008



46-82023

Gasket-SRE Bearing Retainer

For: Denso Hair Pin Alternators
DIM: 40mm ID x 46mm OD
 1.5mm Thickness
Replaces:
OE:
Lester:
Note: Ref to 46-82100
 Used w/46-82200 Bearing
 Retainer

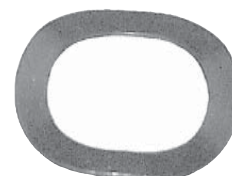

46-82099

Wave Washer-SRE Bearing

For: Denso Hair Pin Alternators
DIM: 24.5mm ID, 35.2mm OD x 1mm T
Replaces: 021542-0120, 021542-0160
OE:
Lester:
Note: Ref to 46-82802
 This is close type design, but the
 function is the same as open
 type.

46-Bearing Retainer & Heat Shield

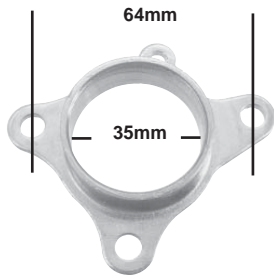

46-82200

Bearing Retainer-SRE Housing

For: Denso Hair Pin Alternators

DIM: 35mm ID, 14.5mm Height

64mm Mounting Length

Replaces:

OE:

Lester:

Note: Use Bearing

For 22-82096, 22-82102, 22-82118,
22-82123, 22-82124

Photo
Coming Soon

46-82XXX

Bearing Retainer-SRE Housing

For: Denso Hair Pin Alternators

DIM: 35mm ID, 14.5mm Height

Replaces:

OE:

Lester:

Note: Similar to 46-82002 but with
Thicker Bearing.

Use Bearing

For 22-82092, 22-82097

Photo
Coming Soon

46-82XXX

Repair Connector

For: Denso Hair Pin Alternators

Used on: Chrysler, Dodge, Honda,
Toyota, Jeep...

DIM:

Replaces:

OE:

Lester: 11000, 11003, 11030, 11032,
11033, 11040... etc

Ref: AZ-0772C

Note:

Photo
Coming Soon

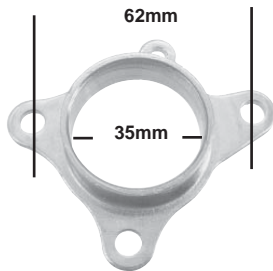

46-82208

Bearing Retainer-SRE Housing

For: Denso Hair Pin Alternators

DIM: 35mm ID, 14.5mm Height

62mm Mounting Length

Replaces:

OE:

Lester: 11063, 12660 (Early), 13871,
13918, 13984, 13988

Note: Use 6202 Bearing.

For 22-82084, 22-82085, 22-82086,
22-82087, 22-82088, 22-82089, 22-
82093, 22-82094, 22-82095, 22-82098,
22-82099, 22-82101, 22-82102, 22-
82106A, 22-82108, 22-82109, 22-
82112, 22-82113, 22-82114, 22-82117,
22-82118, 22-82119, 22-82120

Photo
Coming Soon

46-82246

Heat Shield

For: Denso Hair Pin Alternators

Used on: Lexus, Toyota

DIM: 128.5mm type use

Replaces:

OE: 104210-344, 104210-346

Lester: 11087, 13983

Ref:

Note:

46-82247

Sleeve-SRE Bearing

For: Denso Hair Pin Alternators

Used on:

DIM:

Replaces:

OE: 104210-353, 104210-354

Lester: 14486, 14487

Ref: AT-13366A

Note: Tolerance Ring

46-Misc. Parts



46-82005

Cover-SRE Bearing (External)
For: Denso Hair Pin Alternators
DIM: 15mm ID x 22mm OD x 2.2mm T
Replaces:
OE:
Lester:
Note: Ref to 46-82700



46-82006

Cover-SRE Bearing (Internal)
For: Denso Hair Pin Alternators
DIM: 15.4mm ID x 26mm OD x 0.25mm T
Replaces:
OE:
Lester:
Note:



4604-8023

Bushing-SRE Housing w/Split Open

For: Denso Hair Pin Alternators
DIM: 11.5mm ID, 18.3mm OD
 17.7mm OAL
Replaces:
OE:
Lester: 11584, 13983
Note: used on 22-82085, 22-82155

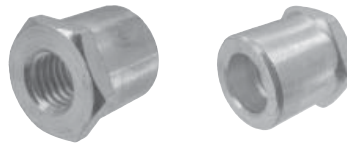

4604-8024

Bushing-SRE Housing

For: Denso Hair Pin Alternators
DIM: M10x1.5 ID, 18mm OD
 19mm OAL
 18.9mm Hex Head
Replaces:
OE: 421000-014, 421000-030,
 421000-700
Lester: 11063, 11379
Note: used on 22-82095, 22-82102



4604-8025

Bushing-SRE Housing w/Split Open

For: Denso Hair Pin Alternators
DIM: 10mm ID, 18.35mm OD
 17.7mm OAL
 26mm Round Head
Replaces:
OE:
Lester: 13918
Note: used on 22-82093



4604-8026

Bushing-SRE Housing Hex Head

For: Denso Hair Pin Alternators
DIM: M10x1.5, 18.3mm OD
 22.85mm OAL
 19mm Hex Head
Replaces:
OE:
Lester: 11034, 11088
Note: used on 22-82088

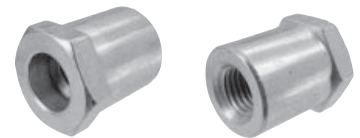

4604-8027

Bushing-SRE Housing

For: Denso Hair Pin Alternators
DIM: M10x1.5, 18mm OD
 23mm OAL
 19mm Hex Head
Replaces:
OE:
Lester: 13927
Note: used on 22-82094, 22-82101,
 22-82110, 22-82112

84-Hardware



84-82001

Stud-SRE Housing

For: Denso Hair Pin Alternators
DIM: M5 x 0.8 x 36mm L
 6.7mm Knurl OD

Replaces:

OE:

Lester:

Note: Ref to 46-82150, AZ-2707
 Used to attached w/SRE Cover



84-82002

Stud-SRE Housing

For: Denso Hair Pin Alternators
DIM: M5 x 0.8 x 35mm L
 6.7mm Knurl OD

Replaces:

OE:

Lester:

Note: Used to attached w/SRE Cover



84-82026

Stud-SRE Housing

For: Denso Hair Pin Alternators
DIM: M5 x 0.8 x 40mm L
 6.7mm Knurl OD

Replaces:

OE:

Lester:

Note: Used to attached w/SRE Cover



84-82003

Screw-Brush Holder, Stator Lead, Rectifier Phillips Head w/Pan Head Split Lock Washer

For: Denso Hair Pin Alternators
DIM: M4 x 0.7 x 6mm L

Replaces:

OE:

Lester:

Note: Ref to 85-1205



84--82005

Screw-Brush Holder, Stator Lead, Rectifier Phillips Fillister Head

For: Denso Hair Pin Alternators
DIM: M4 x 0.7 x 6mm L

Replaces:

OE:

Lester:

Note: Ref to
 Also used on Regulator & Stator



84-82023

Screw-SRE Bearing Retainer Phillips Pan Head Attached Split Lock Washer

For: Denso Hair Pin Alternators
DIM: M4 x 0.7 x 8mm L

Replaces:

OE:

Lester:

Note: Ref to 85-1209



84-82049

Thru Bolt- DE to SRE Housing

For: Denso Hair Pin Alternators,
 104210- & 421000 Series

DIM: M5 x 0.8 x 78mm L
 83.5mm OAL

Replaces:

OE:

Lester:

Note: For 128mm Case OD use.
 with Phillips Head please use
 84-82057.



84-82057

Thru Bolt- DE to SRE Housing w/Phillips Head

For: Denso Hair Pin Alternators,
 104210- & 421000 Series

DIM: M5 x 0.8 x 78mm L
 83.5mm OAL

Replaces: 949042-3950

OE:

Lester:

Note: For 128mm Case OD use.
 Similar to 84-82049 but 84-82049 wo/
 Phillips Head



84-82008

Screw-DE Bearing Retainer Phillips Pan Head Attached Split Lock Washer

For: Denso Hair Pin Alternators
DIM: M4 x 0.7 x 18mm L

Replaces:

OE:

Lester:

Note: Ref to 85-1208

84-Hardware



84-82058

Stud-SRE Housing

For: Denso Hair Pin Alternators

DIM: M5 x 0.8 x 33mm L

6.7mm Knurl OD

Replaces:

OE:

Lester:

Note: Used to attached w/SRE Cover.
When used with SRE Cover to avoid
the Stud exposed too long.



84-82068

Screw-SRE Cover Hex Head

For: Denso Hair Pin Alternators

DIM: M5 x 0.8 x 28mm L

32.5mm OAL

Replaces:

OE: 104210-330

Lester: 11776

Note:



84-82071

Thru Bolt- DE to SRE Housing

For: Denso Hair Pin 220-225 Amp Type
Alternators

DIM: M6 x 1.0 x mm L

90mm OAL

Replaces:

OE:

Lester: 11434

Note: This is for 138mm Case OD use.



84-82117

Screw-Brush Holder

For: Denso, Hair Pin Alternators

DIM: M4 x 0.7 x 10mm L

Replaces:

OE:

Lester:

Note: Also available 84-82117-D w/Dog
Point.



84-82070

Screw-Rectifier Philips Round Head, w/Split Lockwasher, w/Flat Lockwasher

For: Denso, Hair Pin Alternators

DIM: M4 x 0.7 x 12mm L (under Flat

Lockwasher), 18mm OAL

Replaces:

OE:

Lester:

Note: Also available 84-82117-D w/Dog
Point.

Ref MS-4014W



84-82117-5

Screw-Brush Holder w/Dog Point

For: Denso, Hair Pin Alternators

DIM: M4 x 0.7 x 10mm L

Replaces:

OE:

Lester:

Note:

84-M6 B+ Terminal Post



84-82050
Terminal Post-Rectifier
Round Head-Top Post
M6 B+ Terminal

For: Denso Hair Pin Alternators
DIM: M6 x 1.0 x 33.2mm L
35mm OAL

Replace:

OE:

Lester: 13980, 23317

Note: W115-177

Nut use 85-82028
for Rectifier 31-82043
Ref INR429



84-82052
Terminal Post-Rectifier
Round Head-Top Post
M6 B+ Terminal

For: Denso Hair Pin Alternators
DIM: M6 x 1.0 x 39.7mm L
42.9mm OAL

Replace:

OE:

Lester: 11003, 11035, 11036, 11037,
11046, 11180, 13919, 13980

Note: W115-178

Nut use 85-82029
for Rectifier 31-82042
Ref INR422, INR425



Terminal side Post
(Side Post Type)



84-82051
Terminal Post-Rectifier
Square Head-Side Post
M6 B+ Terminal

For: Denso Hair Pin Alternators
DIM: M6 x 1.0 x 33.7mm L
36.3mm OAL

Replace:

OE:

Lester: 11032, 11033, 11034, 11084,
11087, 11088, 11136, 11137, 11138,
11139, 11153, 11195, 11385, 11431,
11776, 13984, 13994

Note: W115-175

Nut use 85-82027
for Rectifier 31-82045
Ref INR426, INR430

Photo
Coming Soon

84-82069
Terminal Post-Rectifier
Square Head-Side Post
M6 B+ Terminal

For: Denso Hair Pin Alternators
DIM: M6 x 1.0 x 28.25mm L
37.75mm OAL

Replace:

OE:

Lester:

Note:



Terminal top Post
(Top Post Type)

84-M8 B+ Terminal Post



84-82053
Terminal Post-Rectifier
Square Head-Side Post
M8 B+ Terminal

For: Denso Hair Pin Alternators
DIM: M8 x 1.25 x 35mm L
38mm OAL

Replace:
OE:
Lester:
Note: for



84-82055
Terminal Post-Rectifier
Round Head-Top Post
M8 B+ Terminal

For: Denso Hair Pin Alternators
DIM: M8 x 1.25 x 43.9mm L
47mm OAL

Replace:
OE:
Lester:
Note: for



Terminal Post
(Side Post Type)



84-82054
Terminal Post-Rectifier
Square Head-Side Post
M8 B+ Terminal

For: Denso Hair Pin Alternators
DIM: M8 x 1.25 x 41mm L
44.2mm OAL

Replace:
OE: 421000-081
Lester: 11063, 11110, 11114, 11240,
11243, 11276, 11285, 11294, 11295,
11296, 11297, 11298
Note: for Side Post
Nut use 85-82026
Ref INR421, W115-176



84-82056
Terminal Post-Rectifier
Round Head-Top Post
M8 B+ Terminal

For: Denso Hair Pin Alternators
DIM: M8 x 1.25 x 45.9mm L
49mm OAL

Replace:
OE: 421000-075, 421000-077
Lester: 11039, 11040, 11048, 11112,
11113, 11156, 11179, 11244, 11369,
11383, 11508, 11513, 11572, 13867,
13914, 13915, 13918
Note: for Top Post
Nut use 85-82034
Ref INR420, INR424, INR432,
W115-179



Terminal Post
(Top Post Type)

85-Rectifier Nut (M6)



85-82025
Nut-Rectifier
M6 B+ Terminal

For: Denso Hair Pin Alternators
DIM: M6 x 1.0 x 17.75mm L
13.7mm OD

Replace:

OE:

Lester:

Note: Ref



85-82028
Nut-Rectifier
M6 B+ Terminal

For: Denso Hair Pin Alternators
DIM: M6 x 1.0 x 18.65mm L
11.6mm OD

Replace:

OE:

Lester: 11238, 11776, 13980, 23317

Note: for Rectifier 31-82043

Ref to W115-181

Post use 84-82050

Ref INR429



Nut



85-82025-1
Nut-Rectifier
M6 B+ Terminal

For: Denso Hair Pin Alternators
DIM: M6 x 1.0 x 15mm L
13.7mm OD

Replace:

OE:

Lester:

Note: Can be use as SRE Stud
Extension



85-82029
Nut-Rectifier
M6 B+ Terminal

For: Denso Hair Pin Alternators
DIM: M6 x 1.0 x 21.50mm L
12.9mm OD

Replace:

OE:

Lester: 11003, 11035, 11036, 11037,
11046, 11180, 13919

Note: for Rectifier 31-82042

Ref to W115-182

Post use 84-82052

Ref INR422, INR425



Nut



85-82027
Nut-Rectifier
M6 B+ Terminal

For: Denso Hair Pin Alternators
DIM: M6 x 1.0 x 17.65mm L
11.8mm OD

Replace:

OE:

Lester: 11032, 11033, 11034, 11084,
11087, 11088, 11136, 11137, 11138,
11139, 11153, 11195, 11385, 11386,
11431, 13994.

Note: for Rectifier 31-82045

Ref to W115-180

Post use 84-82051

Ref INR430

85-Rectifier Nut (M8)



85-82026
Nut-Rectifier
M8 B+ Terminal

For: Denso Hair Pin Alternators

DIM: M8 x 1.25x 17.6mm L
13.7mm OD

Replace:

OE: 421000-081

Lester: 11063, 11110, 11240, 11243,
11276, 11294, 11295, 11296, 11297,
11298, 11378, 13868

Note: for 31-82038

Ref to W115-183

Post use 84-82054

Ref INR421



85-82030
Nut-Rectifier
M8 B+ Terminal

For: Denso Hair Pin Alternators

DIM: M8 x 1.25 x 25.05mm L
13.65mm OD

Replace:

OE:

Lester: 11156, 11179, 11508, 11513,
13918

Note: Ref to W115-185

Ref INR436

Photo
Coming Soon

85-82033
Nut-Rectifier
M8 B+ Terminal

For: Denso Hair Pin Alternators

DIM: M8 x 1.25 x 16.50mm L
16.5mm OD

Replace:

OE: 104210-607, 104210-613

Lester: 11328, 11496

Note: used w/31-82040

Ref INR440



Nut

Photo
Coming Soon

85-82034
Nut-Rectifier
M8 B+ Terminal

For: Denso Hair Pin Alternators

DIM: M8 x 1.25 x 21mm L
13.65mm OD
14mm Hex

Replace:

OE: 421000-003, 421000-005,
421000-008, 421000-011,
421000-012, 421000-015,
421000-018, 421000-019,
421000-075

Lester: 11039, 11040, 11048, 11112,
11113, 11244, 11383, 11572, 13867,
13914, 13915, 13923

Note: Ref to W115-184

Ref INR420, INR424, INR432



Nut

85-Hardware



85-82002
Hex Nut
w/Serrated Flange

For: Denso Hair Pin Alternators
DIM: M6 x 1.0 x 5.8mm Thick
Replaces:
OE:
Lester:
Note: Used on SRE Cover. We also has wo/Serrated 85-82002F available.



85-82003
Hex Nut
w/Serrated Flange

For: Denso Hair Pin Alternators
DIM: M5 x 0.8 x 4.9mm Thick
Replaces:
OE:
Lester:
Note: Used on SRE Cover. We also has wo/Serrated 85-82003F available.



85-82012
Hex Nut
w/Serrated Flange

For: Denso Hair Pin Alternators
DIM: M8 x 1.25 x 7.8mm Thick
Replaces:
OE:
Lester:
Note: Used on Rectifier Post. We also has wo/Serrated 85-82012F available.



85-82002-1
Hex Nut
w/Serrated Flange

For: Denso Hair Pin Alternators
DIM: M6 x 1.0 x 5.8mm Thick
Replaces:
OE:
Lester:
Note: Used on SRE Cover. Zinc plated.



85-82003-1
Hex Nut
w/Serrated Flange

For: Denso Hair Pin Alternators
DIM: M5 x 0.8 x 4.9mm Thick
Replaces:
OE:
Lester:
Note: Used on SRE Cover. Zinc plated.



85-82012-1
Hex Nut
w/Serrated Flange

For: Denso Hair Pin Alternators
DIM: M8 x 1.25 x 7.8mm Thick
Replaces:
OE:
Lester:
Note: Used on Rectifier Post. Zinc plated.



85-82002F
Hex Nut
Unserrated

For: Denso Hair Pin Alternators
DIM: M6 x 1.0 x 5.8mm Thick
Replaces:
OE:
Lester:
Note: Used on SRE Cover. Yellow Zinc plated



85-82003F
Hex Nut
Unserrated

For: Denso Hair Pin Alternators
DIM: M5 x 0.8 x 4.9mm Thick
Replaces:
OE:
Lester:
Note: Used on SRE Cover. Yellow Zinc plated.



85-82012F
Hex Nut
Unserrated

For: Denso Hair Pin Alternators
DIM: M8 x 1.25 x 7.8mm Thick
Replaces:
OE:
Lester:
Note: Used on Rectifier Post. Yellow Zinc plated.

85-Hardware



85-82032
Flange Nut
Unserrated

For: Denso Hair Pin Alternators
DIM: M16 x 1.50 x 10mm Thick
Replaces:
OE:
Lester:
Note: Pulley Nut
Unserrated, Zinc plated.



85-82001-1
Flange Nut
Serrated

For: Denso Hair Pin Alternators
DIM: M14 x 1.50 x 10.8mm Thick
Replaces:
OE:
Lester:
Note: Pulley Nut
Serrated, Zinc plated.

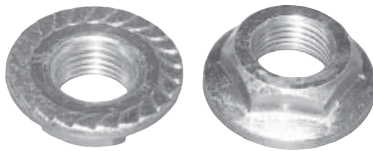

85-82013
Flange Nut
Serrated

For: Denso Hair Pin Alternators
DIM: M16 x 1.50 x 10.8mm Thick
Replaces:
OE:
Lester:
Note: Pulley Nut
Serrated, Zinc plated.

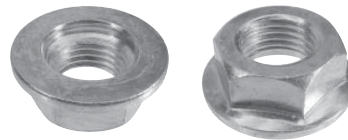

85-82001F
Flange Nut
Unserrated

For: Denso Hair Pin Alternators
DIM: M14 x 1.50 x 10.2mm Thick
Replaces:
OE:
Lester:
Note: Pulley Nut
Unserrated, Zinc plated.

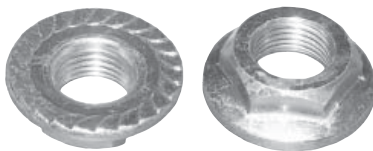

85-82001F-CCW
Flange Nut-CCW
Serrated

For: Denso Hair Pin Alternators
DIM: M16 x 1.50 x 10.8mm Thick
Replaces:
OE: 421000-081
Lester: 11584
Note: CCW Pulley Nut
Serrated, Zinc plated.

**This is
Blank Page**



Metro Auto Industrial Inc

2128 Pomona Boulevard . Pomona . CA 91768-3332

Phone:(909)629-2700 . Fax:(909)629-2721

Toll Free:1-800-263-8761

Toll Free Fax:1-800-799-0838

www.metroautoinc.com

info@metroautoinc.com

Care is taken to ensure the accuracy of photo, descriptions and applications of each items,
but Metro Auto Industrial Inc. assumes no responsibility for possible errors.

All the OE number and Lester number are for referece use only.