

Glued laminated timber structures



Figure 1

Glulam in a commercial building

Introduction

Timber and engineered wood products can be used as the primary material for many forms of structures. While taking advantage of sustainability credentials as a carbon neutral and renewable resource, the engineered wood products are also often selected to be exposed for aesthetic reasons.

One of the most versatile engineered wood product materials is glued laminated timber or 'glulam' (Figure 1). Other engineered wood products (EWPs) such as laminated veneer lumber and standard sawn timber products can also be used in place of glulam, taking account of the particular characteristics of that material type. For more information on the range of EWPs available reference should be made to Timber Engineering Bulletin No. 2¹.

This Engineering Bulletin (No.8) introduces the engineering principles of some common frame types and describes, in more detail, the glulam material and specification.

The technology to remove original wood strength reducing characteristics (e.g. knots) and bond small thicknesses of timber together to form a structural member of significant depth and width, has been used commercially since the 1950s. Glulam manufacturing plants are sophisticated production lines producing quality assured products to enable reliable performance to be achieved for engineered timber structures.

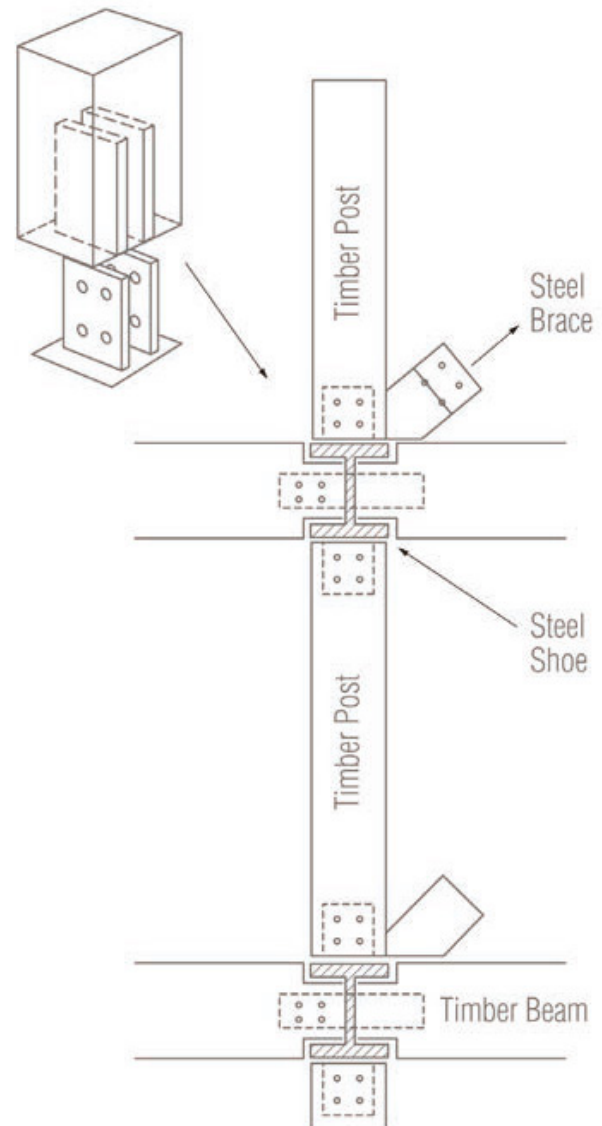

Figure 2

Hybrid braced post and beam structure concepts for multiple storey

This Engineering Bulletin provides a review of glulam in two of the most common structural forms: 'post and beam' and two dimensional rigid frames.

Post and beam forms of construction tend to use columns and beams joined together with nominally pinned connections using steel plates and metal fasteners. It is possible to build structures of a number of storeys by providing braced bays for stability and steel connection shoes at each floor level, to provide ease of connectivity and to ensure durability of the timber components (Figure 2). Horizontal actions are resisted by the diagonal bracing members resulting in relatively stiff frames.

Two dimensional rigid frames are typically used for single storey structures – where stability bracing is not appropriate and ‘rigid’ moment-resisting connections are used between members – to create frames which are resistant to horizontal actions but which will exhibit some sway deflection depending on the stiffness of the frame. It is also possible to extend rigid frames to two or three storey structures. In these situations, however, the overall sway of the frame needs to be carefully considered. Figure 3 indicates a number of commonly used rigid frames.

The fire resistance of glulam and other timber materials in service has been published in a previous Engineering Bulletin No 7.

Other Bulletins investigate the construction and connection details appropriate to low rise glulam frame construction in more detail.

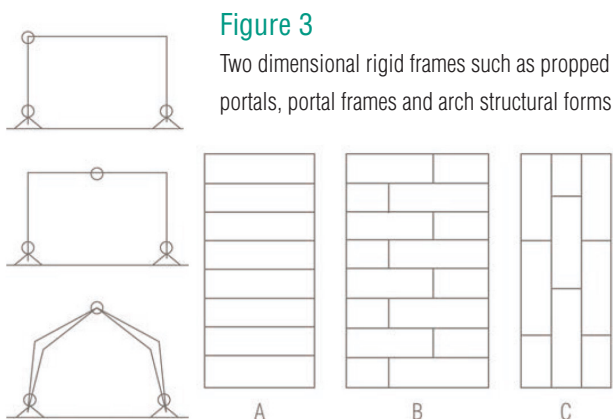

Figure 3
Two dimensional rigid frames such as propped portals, portal frames and arch structural forms

Figure 4
(a) horizontal glulam (b) wide beams made from horizontal glulam (c) glulam with laminates arranged vertically

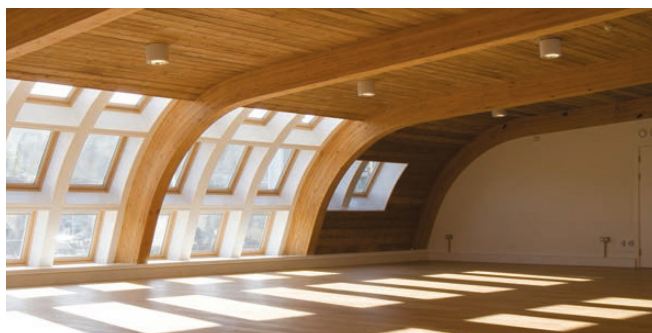

Figure 5
Horizontally laminated, curved glulam

Glued laminated timber (Glulam)

Glulam is an engineered wood product, manufactured from layers of parallel timber laminations (normally spruce or pine but occasionally more durable timber species such as larch, Douglas fir or even hardwoods such as oak or sweet chestnut).

Pieces of sawn timber are graded for strength, before being glued together under pressure with the grain in the laminates running parallel to the longitudinal axis of the section. Strength-reducing defects such as knots, splits and sloping grain are randomly distributed throughout the component allowing glulam to be designed to higher stresses than solid timber of the same grade.

Individual laminates can be end-jointed by the process of fingerjointing to produce long lengths in accordance with the requirements of BS EN 385:20013. One of the greatest advantages of glulam is that it can be manufactured in a wide variety of shapes, sizes and configurations. In most cases horizontal glulam (Figure 4a) is used. Beams wider than the normally available laminate widths can be manufactured by laying boards of different widths side by side and reversing each layer so that there is an overlap and no straight through vertical joint (Figure 4b). Where a tighter radius curve on plan is required, glulam with the laminates arranged vertically is used to enable curving of the section (Figure 4c).

In addition to straight prismatic sections, beams can also be single tapered, double tapered and bevelled. Curved profiles range from a simple curved beam to a pitched and tapered curved beam, to a complex arch configuration. Curved glulam (Figures 5 and 6) is manufactured by bending laminates on formers before being bonded together with adhesive, clamped and cured. In this way, even three dimensional curves can be produced. However these are expensive and often result in significant locked-in stresses in the members which must be taken into account in the design.

The requirements for the manufacture of glulam are contained in product standard BS EN 14080:20054 and glulam complying with this standard must be specified and delivered as CE marked. (Note that BS EN 14080: 2005 is soon to be replaced with BS EN 14080: 2013 which will supersede BS EN 385, 386, 387, 390, 391, 392, 1194 and 14080:2005).



Figure 6
Vertically laminated, curved on plan glulam

Table 1: Size limitations on glulam

Factor	Effect
Tolerances: BS EN 390 ⁵ Glued laminated timber: Sizes. Permissible deviations	Provides manufacturing tolerances on nominal sizes for beams of 50mm to 300mm in width and 100mm to 2500mm in depth, including a method of correcting actual sizes for moisture content
Strength class: BS EN 1194 ⁶ Timber structures. Glued laminated timber. Strength classes and determination of characteristic values	Requires a minimum of 4 laminations in a beam for it to be allocated to a glulam strength class
Production: BS EN 386 ⁷ Glued laminated timber: Performance requirements and minimum production requirements	Prescribes a maximum lamination thickness of 45mm for softwoods and 40mm for hardwoods in service class 1 and 2. For service class 3 these values are both reduced to 35mm

Glulam sizes and availability

Glulam manufacturers tend to offer a range of standard sizes based on multiples of a lamination thickness for the depth and a fairly small range of widths. Depths in the range 180-630mm and widths in the range 66-200mm are common. The most frequently used sizes will be available from stock or on a short order time, whereas bespoke sizes and shapes will require a longer lead time.

Laminations are typically 33mm or 45mm thick but smaller laminations may be required where tightly curved or vertically laminated sections are necessary. Very tight radii under about 4.0 metres may involve laminations of 20mm thickness or less. Lamination thicknesses are not mixed in a single component. Finished Scandinavian sizes are typically based on 45mm thick laminates in width increments of 25mm, starting at around 90mm. Central European finished sizes are based on 40mm laminate thickness and width increments of 20mm, starting from 80mm.

Glulam can be manufactured in long lengths (up to 50m is possible). However, the length of a glulam member will usually be governed by transport and handling limitations.

Some size limitations are imposed by the various glulam standards as indicated in Table 1.

Timber species

The species of the constituent timber laminates of the glulam section will be primarily determined by the appearance and durability requirements of the glulam in service.

Other factors which are also likely to play a part in the selection process will be availability, chain of custody and supply and the ability of the timber species to receive finishes. This guidance is primarily aimed at engineers working in the UK and Europe and timber supply and exposure conditions in other parts of the world may vary.

Glulam for internal use (SC1)

Within the internal environment of a normal conditioned structure there is negligible risk of decay or insect attack and service class 1 (SC1)

conditions are applicable (for definitions of service classes refer to Engineering Bulletin No. 1). The most common timber species used for SC1 conditions is European whitewood (typically Norway spruce and fir) as defined in BS EN 13556:2003⁹ which bonds and machines well, provides a clean bright surface and has an excellent strength to weight and stiffness to weight ratio. Whitewood glulam complying with the forest certification schemes of FSC and PEFC is readily available.

Glulam for unheated internal environments or occasional exposure (SC2)

Where there is a risk of occasional exposure to moisture (service class SC2 conditions), for example beneath an open-roofed area, European redwood (Scots pine if British grown) as defined in BS EN 13556:2003 is preferred due its slightly improved natural durability over European whitewood. The sapwood of the species is also easily pressure preservative treated if required, to further increase its durability.

Softwood glulam manufactured from Larch can be specified to provide a greater degree of natural durability without the need for pressure preservative treatment. Its durability class according to BS EN 350-2:1994¹⁰ is 'moderately to slightly durable' (for definitions of durability classifications refer to Engineering Bulletin No. 1). Larch has the additional advantage of having better impact resistance than spruce, so finds favour in semi exposed conditions such as free standing columns at entrances. Other softwood species that are commonly used for glulam include Douglas fir, which may be imported or British grown, which has a durability class according to BS EN 350-2:1994 of 'moderately to slightly durable' depending on the source.

For all softwood glulam, design details should ensure adequate water-shedding and ventilation, to provide as much physical protection against elevated levels of moisture as possible.

Glulam for external exposure (SC3)

Glulam can be used in exposed conditions where the risk of wetting occurs and SC3 moisture conditions are applicable. This can be achieved, either by using softwood glulam with pressure preservative treatment, combined with

the use of suitably designed covers to protect the timber elements and thereby maintaining them in SC2 conditions, or by the use of naturally 'durable or very durable' timber species without pressure preservative treatment.

The two alternatives for preservative treatment are:

- manufacture the glulam and then treat (limited by size of pressure tank)
- laminate preservation before glulam manufacture (however, compatibility between the preservative and adhesive types must be checked)

Even when a durable species is specified, the use of well-maintained water-repellent finishes together with rain screening and other protection measures, should be considered essential. Accompanying metallic elements require protection by galvanising or the use of stainless steel.

Temperate hardwood species such as European oak and sweet chestnut have a durability class according to BS EN 350-2:1994 of durable'. There are also suitable tropical hardwood timber species such as Iroko and Kapur, both 'durable', which can be obtained from sources registered with forest certification schemes. Gluing hardwoods is difficult and as a result there are few manufacturers and the cost of hardwood glulam is proportionately high. These will therefore be bespoke materials requiring a longer delivery time and prior agreement with potential suppliers of the species and grade of material available.

Strength classes of glulam

BS EN 1995-1-1¹¹⁻¹² requires that timber used to manufacture glulam is strength graded either visually or mechanically to either BS EN 14081¹³, BS 4978¹⁴ (softwoods) or BS 5756¹⁵ (hardwoods).

The strength class to which a glulam member is assigned, depends not only on the grade of the laminations but on the build-up of the glulam section. BS EN 1194:1999 gives the characteristic values for glulam properties for design to Eurocode 5. This standard lists four glulam strength classes GL24, GL28, GL32 and GL36 where the numbers refer to the characteristic bending strength of each class. For example GL28 has a characteristic bending strength of 28N/mm².

Glulam can be either 'homogenous', where all of the laminations are the same strength class of timber, or 'combined', where the outer laminations are a higher strength class than the inner ones (Figure 7). Combined beam lay-ups are an efficient use of timber, since they allow higher strength laminations to be placed where bending stresses are higher in the extreme fibres of the beam. However, care needs to be taken when using combined glulam for column sections where biaxial bending may occur. When using combined glulam with heavily loaded connections fastened over the full depth of the section, then the strength of individual fasteners will vary according to the characteristic density and hence embedment strength.

Reference should be made to Engineering Bulletin No. 2 for some characteristic values of glulam strength properties compared to other EWPs.

Figure 7

Homogenous and combined glulam members

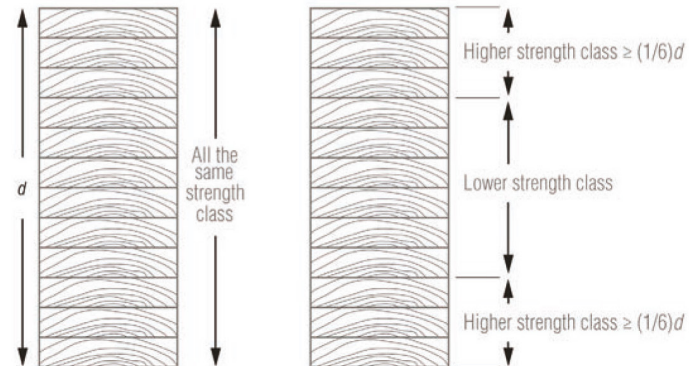

Structural Form	Description and Materials	Pitch (°)	Span Range (m)	Appropriate Proportions
	Straight beam, simply supported Solid timber, glulam, LVL	< 3°	Solid < 5 LVL < 20 Glulam < 30	$h \approx \frac{l}{17}$
	Tapered beam (single or double taper), simply supported Glulam, LVL	3-10°	10 - 30	$h \approx \frac{l}{17}$ $H \approx \frac{l}{16}$
	Pitched cambered beam simply supported Glulam	3-15°	10 - 20	$h \approx \frac{l}{17}$ $H \approx \frac{l}{16}$

Table 2 Structural forms for timber beams and rafters - preliminary sizing charts members

Table 3 Structural forms for timber portals and arches - preliminary sizing charts

Structural Form	Description and Materials	Pitch (°)	Span Range (m)	Appropriate Proportions
	Arch - optionally tied with steel, glulam or LVL - glulam top chords	Rise/span = 0.14	20 - 80	$h \approx \frac{l}{40}$
	Portal Curved laminated glulam haunch	> 14°	15 - 40	$h \approx \frac{S_1 + S_2}{15}$
	Portal with large finger jointed haunch in glulam or LVL	10° - 50°	8 - 30 at 3 - 6 frame centres	$h \approx \frac{S_1 + S_2}{13}$
	Portal - struted and braced haunch Glulam, LVL Struts same, or solid frame	> 14°	10 - 35	$h \approx \frac{S_1 + S_2}{15}$

Table 8

Glulam post and beam structure

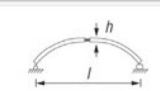
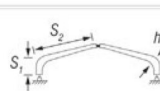
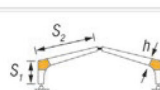
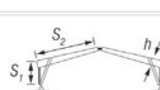

Structural forms for post and beam and rigid frames construction

Typical structural forms include straight and shaped beams supported by glulam posts (post and beam) and single storey roof systems using rigid (portal or arch) frames with moment-resisting connections at the haunches (Tables 2 and 3).

Post and beam construction

In large open spaces, glulam beams can typically span up to 30m (Figure 8). Beams of this length may require splices for transportation and the design of these splices may govern the structural member depth required. Simply supported beams are usually governed by deflection criteria in design and therefore beams which are continuous over multiple supports are more structurally efficient, although care needs to be taken to account for the changed load distribution to supports.

Some stiffness can be developed through the joints, while knee braces can be added to accommodate greater forces. Laminated beams can also act in combination with other materials and moment connections to steel and concrete are viable.

Stock sizes of glulam are generally used for straight elements, since shaping and profiling can be costly and wasteful.

Shaped glulam and built up components e.g. thin-webbed box beams, stressed skin panels and trusses, can be more easily formed to predetermined roof profiles and shapes.



Figure 9
Glulam portal frames

Portals and arches

Large open areas can be created using glulam portal frames (Figure 9) and arches and spans are only limited by the length and weight of the glulam components due to fabrication and transport restrictions, with site conditions occasionally being a further constraint. In some instances, warehouses and distribution centres with roof areas exceeding 100,000m² have been constructed using glulam framing.

The spacing of the principal structural frames may be limited by the economic span of the secondary members such as floor joists and roof purlins. Table 3 indicates the typical span ranges of a number of glulam arch and portal frame arrangements and the typical span to depth ratios of the principal members.

Open frame constructions, members and connections should be designed in accordance with BS EN 1995-1-1 Eurocode 5 together with the UK National Annex to Eurocode 5 and PD 6693-1:2012¹⁶.

With open frame construction, particular attention should also be paid to robustness and disproportionate collapse, as the uses of the buildings often come within critical consequence classes requiring Class 2B or even Class 3 for large public spaces. For more information on robustness and disproportionate collapse design, reference should be made to Engineering Bulletin No. 5¹⁷.

Engineering principles of open frame construction

Design of glulam and LVL

The procedure given in BS EN 1995-1-1 Eurocode 5 for the design of glulam or LVL members such as beams and columns is generally no different from that for solid timber, with only some minor variation in some modification factors. However, since the characteristic strength and stiffness values are higher for glulam and LVL than for solid wood, the design capacities of these engineered wood products will also be higher.

This Bulletin does not cover the design of the individual frame members and readers should consult the 'References and further reading' section for further guidance on the structural design of these components.

Construction principles

Open frames can be constructed as:

- Pin-jointed structures relying on horizontal bracing systems or diaphragms to transfer lateral and instability forces to vertical bracing systems or vertical shear walls and thence to the foundation
- Stiff-jointed structures capable of resisting lateral and instability forces e.g. portal frames
- A combination of pinned and stiff-jointed frames together with appropriate bracing systems

Figure 10

Examples of assumed deviations in geometry of a portal frame and arch

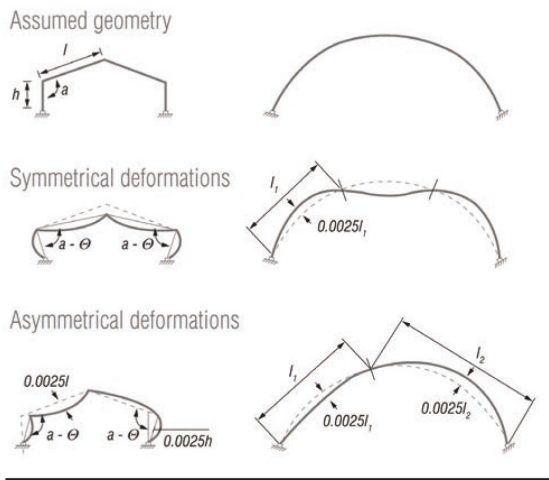
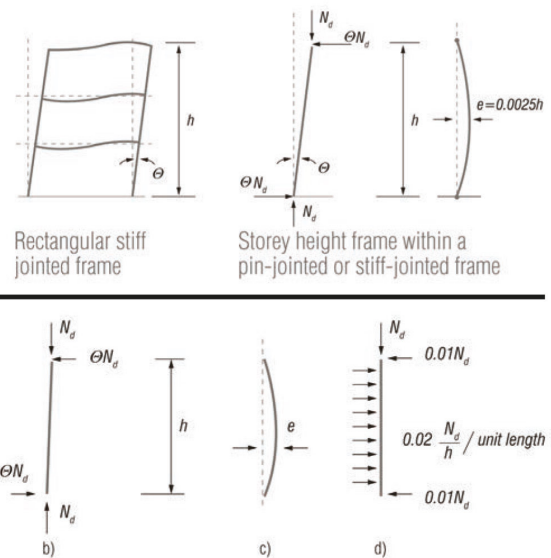

Figure 12

Equivalent horizontal forces for rectangular frames a) initial sway imperfection b) equivalent horizontal forces due to sway imperfection c) local bow imperfection d) equivalent horizontal forces due to local bow imperfection

Figure 11

Examples of assumed deviations in geometry of a rectangular frame



Frame imperfections

To account for frame imperfections, plane frames and arches should be separately checked for dimensional imperfections arising from deviations from the assumed geometry of members and fabrication and erection tolerances, as described BS EN 1995-1-1 (Figure 5.3).

Design member stiffness properties:

$$E_d = \frac{E_{mean}}{\gamma_M} \quad (\text{EC5: 2.15})$$

and

$$G_d = \frac{G_{mean}}{\gamma_M} \quad (\text{EC5: 2.16})$$

For checking stresses in the members, the value of k_{mod} for the relative duration of load should be used.

Figure 10 shows some examples of assumed initial deviations in the geometry of a portal frame and arch and Figure 11 shows some examples for a rectangular frame.

For rectangular frames, the sway imperfections and local bow imperfection may be replaced by equivalent horizontal forces (Figure 12) where N_d is the design axial load for the relevant load duration. If the magnitude of applied horizontal forces is greater than the equivalent horizontal force (e.g. due to wind) then the equivalent horizontal force may be neglected.

Stability and bracing of open frame construction

For open frame construction and plane frameworks such as rafters, structural stability is normally provided by a system of triangulated diagonal bracing members although timber portal frames are also common. For floors, ceilings

and timber frame wall panels, stability is normally provided by the diaphragm action of wood-based sheet materials acting as horizontal diaphragms. The design of horizontal diaphragms was covered in Engineering Bulletin No. 4¹⁸.

Braced bays take on standard engineering principles and the forces resolved taking due account of the connectivity and joint design in the timber to timber connections. Engineering Bulletin No. 9 addresses connection types and present examples.

DEFINITIONS

Portal frames – two-dimensional rigid frames, usually with pitched rafters, that have a rigid joint between column and beam members which allows the frame to act as one continuous structural frame for resistance to vertical and horizontal actions.

Engineered wood product (EWP) – reconstituted wood-based products which may be formed from the same wood-based material e.g. glulam or different products to form a composite material e.g. I-joists.

REFERENCES AND FURTHER READING

- 1) The Institution of Structural Engineers (2013) 'Timber Engineering Notebook No.2: Engineered wood products and an introduction to timber structural systems' The Structural Engineer, 91 (4), pp. 42-48
- 2) The Institution of Structural Engineers (2013) 'Timber Engineering Notebook No.7: Fire safety in timber buildings' The Structural Engineer, 91 (9), pp. 41-47
- 3) British Standards Institution (2001) BS EN 385:2001 Finger jointed structural timber. Performance requirements and minimum production requirements London: BSI
- 4) British Standards Institution (2005) BS EN 14080:2005 Glued laminated timber – Requirements London: BSI



- 5) British Standards Institution (1995) BS EN 390:1995 Glued laminated timber: Sizes. Permissible deviations London: BSI
- 6) British Standards Institution (1999) BS EN 1194:1999 Timber structures. Glued laminated timber. Strength classes and determination of characteristic values London: BSI
- 7) British Standards Institution (2001) BS EN 386:2001 Glued laminated timber: Performance requirements and minimum production requirements London: BSI
- 8) The Institution of Structural Engineers (2013) 'Timber Engineering Notebook No.1: Timber as a structural material – an introduction' *The Structural Engineer*, 91 (3), pp. 33-38
- 9) British Standards Institution (2003) BS EN 13556:2003 Round and sawn timber – Nomenclature for timbers used in Europe London: BSI
- 10) British Standards Institution (1994) BS EN 350-1&2:1994 Durability of wood and wood-based products – Natural durability of solid wood London: BSI
- 11) British Standards Institution (1995) BS EN 1995-1-1 Eurocode 5: Design of Timber Structures – Part 1-1: General – Common rules and rules for buildings London: BSI
- 12) British Standards Institution (1995) BS EN 1995-1-1 UK National Annex to Eurocode 5: Design of Timber Structures – Part 1-1: General – Common rules and rules for buildings London: BSI
- 13) British Standards Institution (2005) BS EN 14081-1:2005 – Strength graded structural timber with rectangular cross section London: BSI
- 14) British Standards Institution (1996) BS 4978:1996 Visual strength grading of softwood London: BSI
- 15) British Standards Institution (2007) BS 5756:2007 Visual grading of hardwood – Specification London: BSI
- 16) British Standards Institution (2012) PD 6693-1:2012 UK Non- Contradictory Complementary Information (NCCI) to Eurocode 5: Design of timber structures London: BSI
- 17) The Institution of Structural Engineers (2013) 'Timber Engineering Notebook No.5: Timber frame structures – platform frame construction (part 3)' *The Structural Engineer*, 91 (7), pp. 43-50
- 18) The Institution of Structural Engineers (2013) 'Timber Engineering Notebook No.4: Timber frame structures – platform frame construction (part 2)' *The Structural Engineer*, 91 (6), pp. 30-36

Further reading

Porteus J. and Kermani A. (2008) *Structural Timber Design to Eurocode 5* Chichester: John Wiley & Sons

The Institution of Structural Engineers/TRADA (2007) *Manual for the design of timber building structures to Eurocode 5* London: The Institution of Structural Engineers/TRADA

TRADA (2011) *Wood Information Sheets: 1-6 Glued laminated timber – an introduction* High Wycombe: TRADA Glued Laminated Timber Association (2010) *Structural glued laminated timber - Design essentials* [Online] Available at: www.constructionaltimber.com/wp-content/uploads/2011/09/structuralglued-laminated-timber.pdf (Accessed: September 2013)