



# Harmony Smart Control™

## User Guide



# Harmony Smart Control User Guide

## Table of Contents

About this Manual .....	6
Terms used in this manual: .....	6
At a Glance.....	6
Features.....	6
Supported devices.....	6
Know your Harmony Smart Control.....	7
Features of the remote control.....	7
Changing the battery.....	8
Harmony Hub and IR mini blaster.....	8
How your Harmony Smart Control works.....	8
Devices .....	8
Activities.....	9
Favorites.....	10
Harmony App .....	10
MyHarmony .....	10
Powering your system off .....	11
Interference with Harmony Smart Control .....	11
Harmony Smart Control First Time Setup .....	11
Hardware setup.....	11
Download the Harmony App.....	12
Set up the Harmony App.....	12
Connecting to Wi-Fi.....	13
Copying setup information from another Harmony remote .....	14
Creating a MyHarmony account .....	15
Setting up devices to control .....	15
Adding a Watch TV Activity.....	16
Setting up Favorites .....	17

- Adding more devices..... 18
- Personalizing your remote ..... 18
- Using your Harmony Smart Control ..... 19
  - Activities..... 19
    - Switching between Activities ..... 20
    - Gesture control ..... 20
      - Viewing current gesture commands ..... 21
      - Customizing Activity gestures ..... 21
    - Activity commands..... 21
  - Favorites..... 21
  - Devices ..... 21
  - How to get the most out of your Harmony Smart Control ..... 22
    - Important: use your Harmony Smart Control every time! ..... 22
    - Adjust the power on delay ..... 22
    - Position the hub and set up hub assignments correctly for your setup ..... 22
    - Use the Help function to put the remote back in sync with devices ..... 22
- Changing your Setup..... 23
  - Changing your setup with the Harmony App..... 23
  - Changing your setup with MyHarmony ..... 23
    - Syncing your changes ..... 24
  - Adding devices ..... 24
    - Adding a device with the Harmony App ..... 24
    - Adding a device with MyHarmony ..... 24
    - Special devices ..... 25
    - Adding an unknown device with MyHarmony..... 25
  - Deleting devices ..... 26
    - Deleting devices with the Harmony App..... 26
    - Deleting devices with MyHarmony ..... 27
  - Modifying device settings ..... 27
    - Modifying device settings with the Harmony App..... 27
    - Modifying device settings with MyHarmony ..... 27
  - Adding Activities..... 27

- Adding Activities with the Harmony App ..... 27
- Adding Activities with MyHarmony ..... 28
- Viewing Activity settings ..... 28
  - Viewing Activity settings with the Harmony App..... 28
  - Viewing Activity settings with MyHarmony ..... 29
- Changing Activity settings ..... 29
  - Changing Activity settings with the Harmony App ..... 29
  - Changing Activity settings with MyHarmony ..... 29
- Deleting Activities ..... 30
  - Deleting Activities with the Harmony App..... 30
  - Deleting Activities with MyHarmony ..... 30
- Changing your location or channel provider..... 31
  - Changing your location or channel provider with the Harmony App ..... 31
  - Changing your location or channel provider with MyHarmony..... 31
- Managing your Favorites..... 31
  - Managing your Favorites with the Harmony App..... 31
  - Managing your Favorites with MyHarmony ..... 32
- Advanced customization ..... 33
  - Customizing Activities with MyHarmony ..... 33
  - Customizing buttons to perform a sequence of commands with MyHarmony ..... 34
  - Customizing Activity buttons with the Harmony App..... 35
  - Customizing buttons and on-screen commands with MyHarmony ..... 35
    - Activities mode..... 35
    - Device mode..... 36
- Changing hub assignments with MyHarmony ..... 36
- Upgrading your Harmony Smart Control firmware ..... 36
- Personalizing your Remote..... 36
  - Customizing Favorite Channel icons with MyHarmony ..... 36
- Remote Control Menus ..... 37
  - Help ..... 37
  - Connect to your Harmony..... 37
  - Edit ..... 38

Devices menu ..... 38

Settings menu ..... 38

    Sync your Harmony ..... 38

    Set up new remote..... 38

    Edit devices and activities ..... 38

        Devices ..... 38

        Activities..... 39

        Favorites..... 39

        Remote..... 39

        Account Info ..... 39

    Reset button layout..... 39

    Reset gesture mapping ..... 39

    Reset Favorites..... 40

    Auto lock ..... 40

    Haptic feedback..... 40

    Customer support ..... 40

    Privacy Policy..... 40

    About..... 40

Troubleshooting..... 40

    Setup problems ..... 40

    Wi-Fi problems ..... 42

    Add missing commands to your Harmony Smart Control ..... 42

    Hub is not syncing to the Harmony app..... 42

    Devices do not respond to Harmony Smart Control..... 43

Support ..... 43

    Find answers to questions online ..... 43

        Logitech Harmony remote knowledge base ..... 43

        Logitech Harmony remote user forum ..... 43

    Contact customer support: ..... 43

Copyright ..... 43

# About this Manual

This manual contains both internal links to other parts of the manual and external links to other sources of information. [Internal links appear like this](#) and [external links appear like this](#).

Illustrations in this manual were accurate at the time of publication.

Note: If you are upgrading from Harmony Touch, [click here for setup instructions](#) of using this user manual

## Terms used in this manual:

- **Harmony App:** the remote control app that runs on your smartphone or mobile device.
- **Harmony Smart Control remote:** the physical remote control that comes with Harmony Smart Control.
- **MyHarmony:** the account that saves all your setup information in the cloud. You can access your MyHarmony account either through the Harmony App, or on your computer through [MyHarmony](#).
- **Harmony Smart Control system:** includes the Harmony Hub, the Harmony App, the Harmony Smart Control remote, and MyHarmony.

# At a Glance

## Features

The Harmony Smart Control system provides maximum flexibility for controlling your home entertainment system.

Use the Harmony app on your smartphone to control your entertainment devices (TV, cable or satellite box, DVR, game console, etc.) and home automation devices (IR controllable light bulbs, vacuum cleaners, motorized blinds, etc.). A Harmony Smart Control remote is provided as backup in case your smartphone is not available.

Switch between watching cable TV, watching your Roku, or playing a game with one touch. You can program your Activities to be as simple and general as you want or as complicated and precise as you want. Whatever you like to do, one touch can take you from one Activity to the next, powering off and on the right devices and adapting the remote control to send the right commands to the devices you're currently using.

The Harmony App will guide you through the setup process on your smartphone. Once your setup is saved in the MyHarmony cloud, you have the ability to turn any supported smartphone into a remote that functions as a Harmony Smart Control remote.

For suggestions on how to optimize your Harmony and for unique setup solutions, please visit our [Harmony user community forums](#) for ideas (English only).

## Supported devices

New user setup for the Harmony App is only supported for the iPhone 4s or newer, the new iPad, the iPad Mini, and Android phones. To run the Harmony App on an older iPhone, refer to Set up new remote for more information. Please visit our [complete list of supported platforms](#).

[Find out if your mobile device is supported.](#)

## Know your Harmony Smart Control

Open your Harmony Smart Control box and familiarize yourself with the components.

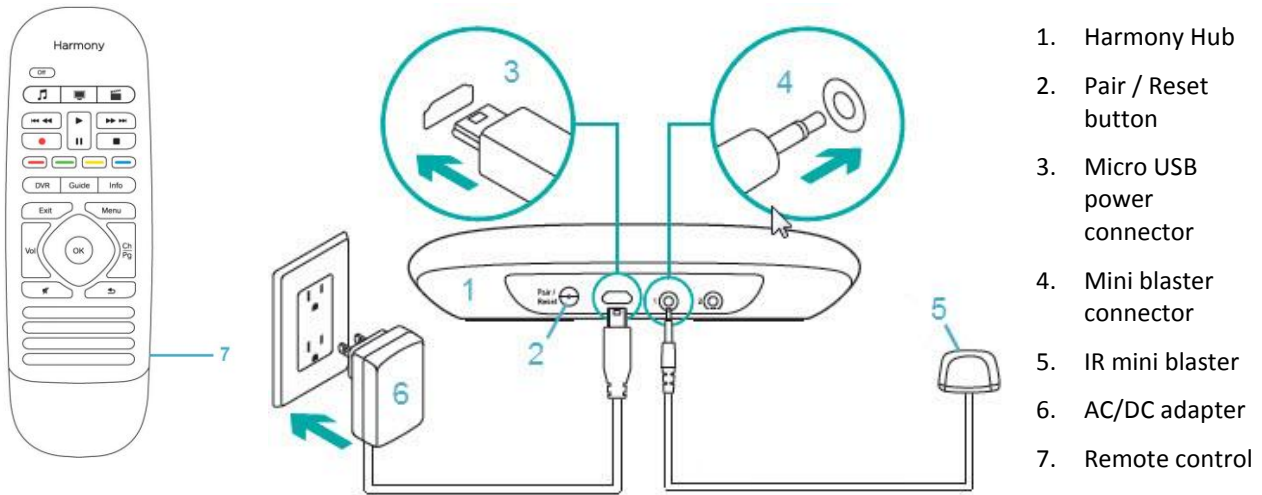

## Features of the remote control

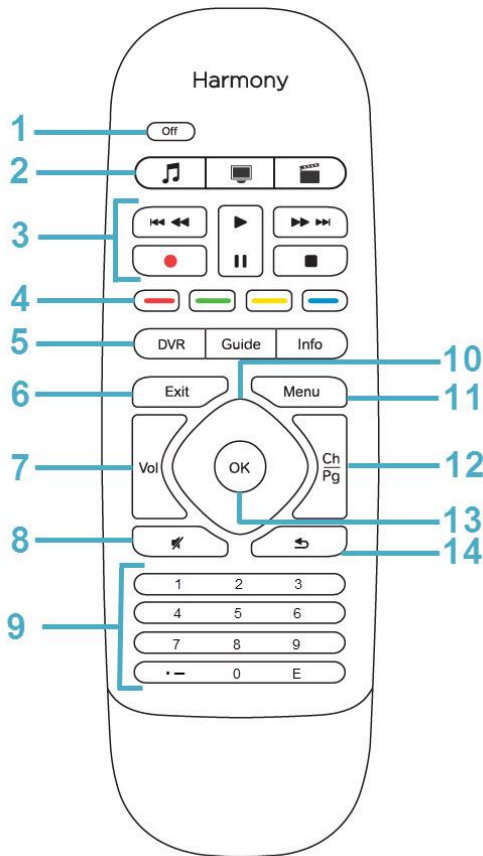

1. Off button: Power off your current Activity.
2. Activity buttons: Select an Activity.
3. Audio/video controls: Perform standard AV functions.
4. Color coded navigation buttons: Perform cable, satellite or Blu-ray functions
5. Satellite/cable controls:
  - DVR: Opens the record/ play menu.
  - Guide: Opens satellite or cable program listings.
  - Info: Provides program information.
6. Exit: Leave a listing or menu on your TV screen.
7. Volume control
8. Mute
9. Numeric keypad
10. Directional controls: Navigate up, down, left and right in menus on your TV, DVR, game console or other media source.
11. Menu: Display the menu on your TV, DVR, game console or other media source.
12. Channel control; page up/down
13. OK: Press to select an option on your TV screen.
14. Previous: Tune to the previous channel.

## Changing the battery

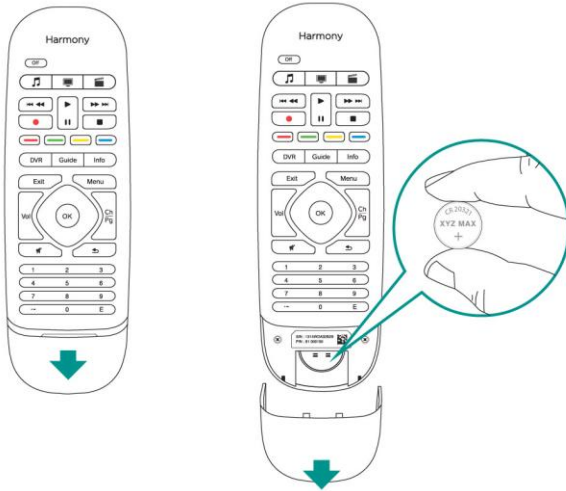

To change the battery, slide open the battery compartment as shown and replace the battery with a new 3 volt CR20321 lithium battery.

## Harmony Hub and IR mini blaster

Whether you use the Harmony App or your Harmony Smart Control remote, the hub stores your setup information and communicates between your Harmony Smart Control system and your entertainment center devices. The hub communicates with other devices by Wi-Fi, IR (infrared), and Bluetooth signals, depending on the device.

An IR mini blaster extends the range of the Harmony Hub allowing you to control devices that are on other shelves or outside of your cabinet, such as a television.

## How your Harmony Smart Control works

### Devices

Devices are the components of your entertainment system. Examples of devices are:

- TV set
- Cable or satellite set top box
- Audio Visual (AV) receiver
- DVD player
- Game console

Gather the manufacturer and model number information for each of your devices and record it on the next page of this user guide. Also write down how devices are connected to one another and the input they must be on. For example, to watch a movie you might have your television set to input (or source) "HDMI 1" and your AV Receiver set to input "DVD". Having this information collected ahead of time will make setup much easier.



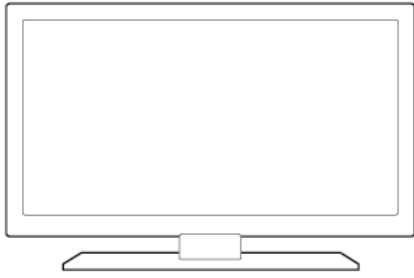

TV Manufacturer

Model # \_\_\_\_\_

What's connected?

Device \_\_\_\_\_ Input \_\_\_\_\_  
Device \_\_\_\_\_ Input \_\_\_\_\_  
Device \_\_\_\_\_ Input \_\_\_\_\_  
Device \_\_\_\_\_ Input \_\_\_\_\_  
Device \_\_\_\_\_ Input \_\_\_\_\_



Cable/Satellite Box Manufacturer

Model # \_\_\_\_\_

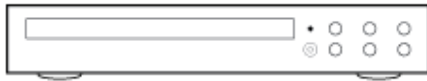

DVD/Blu-ray Player Manufacturer

Model # \_\_\_\_\_



AV Receiver Manufacturer

Model # \_\_\_\_\_

What's connected?

Device \_\_\_\_\_ Input \_\_\_\_\_  
Device \_\_\_\_\_ Input \_\_\_\_\_  
Device \_\_\_\_\_ Input \_\_\_\_\_  
Device \_\_\_\_\_ Input \_\_\_\_\_  
Device \_\_\_\_\_ Input \_\_\_\_\_

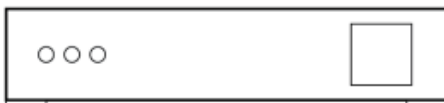

Other Device Manufacturer

Model # \_\_\_\_\_

Activities

Activities define the way you use your remote controlled devices. Examples of Activities are:

- Watch TV
- Listen to Music
- Watch a DVD
- Play a Game

To create an Activity, you need to know some basic information about how your devices interact with each other in that Activity. For example, to create a basic Watch TV Activity, you need to know:

- Which devices you will use. In most cases, you need at least the following devices:
  - A TV set
  - A video source, such as a cable or satellite set top box
- Which device is used to control the volume
- Which device is used to change channels
- Which input is used on the TV set to view the video source

Inputs determine how your devices are connected. For example, if your DVD player is connected to the Video 2 input on your TV, then the TV must be set to Video 2 to display the DVD's picture. More information is provided about inputs in the instructions for Adding a Watch TV Activity.

## Favorites

The Favorites screen allows you to view your predefined Favorite Channels and station icons (where available). You can select up to 50 television channels to display on the Harmony App. Selecting a Favorite Channel will start your "Watch TV" Activity, if it's not already started, and tune directly to that channel. Using the mobile device screen, you can add, remove and reorder your Favorite Channels. The Harmony App on your smartphone allows you to customize Favorite Channels unique to each smartphone.

## Harmony App

The Harmony App communicates with the Harmony hub and mini blasters to send commands to your devices. The app also sets up and communicates with your MyHarmony account, which saves your configuration information in the cloud so that once the Harmony App is set up, you can use the Harmony App on all the smartphones in your household to control the Harmony Smart Control system. In addition, the Harmony App can be customized on each smartphone so that each person can set up and save their own individual preferences.

## MyHarmony

<http://myharmony.com> is a website where you can access your Harmony Smart Control configuration information and make changes to your setup if necessary. When setting up your Harmony Smart Control system for the first time with the Harmony App, it sets up a MyHarmony account for you on MyHarmony. You can return to MyHarmony any time to change your configuration, although you can make most changes with the Harmony App. There are minimum system requirements for using MyHarmony on your computer. The following operating system/browser combinations are supported:

Desktop Browser	Mac	PC*
Internet Explorer 8+		x
Chrome 16+		x
Firefox 11+	x	x
Safari 5.1+	x	

- \* Windows Vista and XP support 32 bit browsers
- \* Windows 7 and 8 support both 32 and 64 bit browsers

## Powering your system off

You can power off your all of the devices for an Activity from the Harmony App by tapping the  icon at the top of the screen and then tapping Power Off. For example, in a Watch TV Activity that uses a TV, Cable Box, and AV Receiver; pressing the Off button will power off all three devices at the same time. Note that this menu option is only available while an Activity is on.

The Harmony Smart Control system knows the current state of the devices it controls by remembering the last Activity you selected. For example, if you switch from watching cable TV to watching a DVD, the Harmony Smart Control knows that it doesn't need to power the TV off and back on, it just leaves the TV turned on; and it knows that it does need to power off the cable box and power on the DVD player.

You will primarily want to use the Harmony App to control your devices, but alternatively you can use the Harmony Smart Control remote Off button to power off all of the devices for an Activity with one touch.

## Interference with Harmony Smart Control

You can confuse the Harmony Smart Control by using other remotes or manually controlling your devices. For example, if you select the Watch TV Activity and then use your TV remote to turn off the TV, the next time you want to select an Activity, the Harmony Smart Control will think that your TV is already powered on and will not turn it on. Other things that can confuse the Harmony Smart Control include inter-device communication that turns devices on or off, such as HDMI-CEC or SCART (in Europe). For more information about HDMI-CEC, see the [FAQ](#).

If the Harmony Smart Control becomes confused, you can use the Help function in the Harmony App to bring the TV back in sync. For more information about the Help function, see the sections Help and Troubleshooting.

# Harmony Smart Control First Time Setup

The first time you set up your Harmony Smart Control system, the Harmony App walks you through the setup process and stores your settings in your personal account. Your settings can be transmitted to your Harmony Hub, your Harmony Smart Control remote, or any other supported mobile device. If anything ever happens to your smartphone, Harmony Hub, or remote control, you can use these saved settings to set up a replacement system with ease.

## Hardware setup

There are a few steps to setting up your Harmony Smart Control hardware:

1. Connect your Harmony Hub to a power outlet.



2. Place the hub inside your entertainment system.

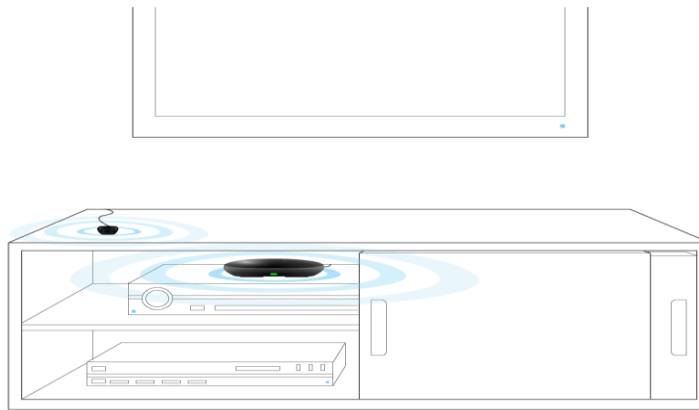

Connect the IR mini blaster to the port on the rear of the Harmony Hub.

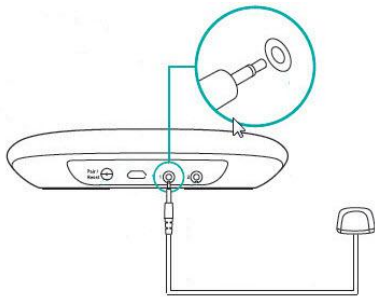

3. Place the mini blaster outside your cabinet or inside your cabinet on a different shelf from your hub. The Smart Control remote cannot send IR signals, so if you have the hub inside a closed cabinet, place the mini blaster outside the cabinet so that it can send IR signals to the television.

Now you're ready to program your system.

## Download the Harmony App

Go to the app store for your device and search the phone apps for "Harmony Control". Although the Harmony App also can run on newer tablets.

## Set up the Harmony App

Although the entire setup process is described in this section, only selected screens from the Harmony App setup process are shown. Please read all the instructions displayed on your Harmony App screen so that you understand what is happening during setup.

1. Start with the Harmony Hub positioned as described in the Hardware setup section,
2. Your mobile device will need to be connected to your Wi-Fi network for the setup process. If it is not already connected, do that now.
3. Open the Harmony App.



4. Tap **Continue** on the welcome screen. The option to buy a Harmony Smart Control is also offered from the welcome screen.
5. When prompted, tap **Set Up Remote**.
6. Read the overview of the setup steps and tap **Continue**.
7. Wait 30 seconds, then press the **Pair / Reset button** on the back of the Harmony Hub to begin pairing the Harmony Hub with the Harmony App on your mobile device.
8. Continue with the steps in the next section, Connecting to Wi-Fi.

## Connecting to Wi-Fi

Connecting your Harmony Hub to your Wi-Fi network has multiple advantages, such as enabling use of the Harmony app, providing Philips hue lighting control, and wirelessly syncing settings between your remote and MyHarmony account.

Steps in this section are part of the process of setting up the Harmony App, and the step numbers continue from the previous section.

NOTE: Harmony Smart Control supports 2.4GHz 802.11 b/g/n wireless networks with WPA, WPA2-AES, and 64/128 bit WEP encryption.

9. Wait while the Harmony App searches for the hub, and then displays the Wi-Fi Setup screen.

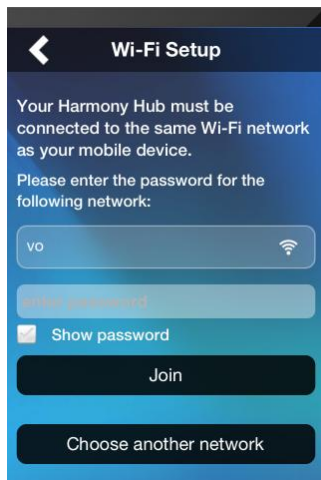

10. Make sure that the Wi-Fi network shown is the same one that your mobile device is connected to.
  - a. If it is not the same network, tap **Choose another network** and follow the instructions.
  - b. When the same network is shown, enter your password tap **Join**, and wait for the Hub to join the Wi-Fi network.

If you have problems connecting to the Wi-Fi, please refer to [Wi-Fi problems](#).

11. When prompted, enter a name for your Harmony Hub, tap **Continue**, and wait for the Harmony App to

connect to MyHarmony.

12. The step that you take next depends on whether you are a new user setting up your first Harmony remote control, or if you already have an older Harmony remote control that you configured previously:

- If you are a new user, skip to the section, Creating a MyHarmony account.
- If you have already set up a Harmony remote control, continue with the steps in the next section, Copying setup information from another Harmony remote.

### Copying setup information from another Harmony remote

This section is only for users who have already set up another Harmony remote control and want to import the settings from that system to the Harmony Smart Control. If you do not have a previous Harmony remote, skip to the Creating a MyHarmony account section below.

To emphasize that these steps are a departure from the normal flow for a new user, step numbers in this section do not follow the sequence of the preceding and following sections.

a. Tap **Sign In**.



b. Tap the **Import** button. You will be asked to enter the ID and password for your previous account. When you do, the settings will be copied and applied to your Harmony Smart Control account.

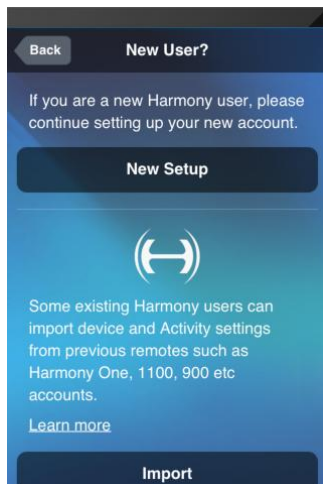

Once your settings are copied, you will be able to add more devices or Activities and modify your settings.

- c. Refer to the sections below if you need assistance with adding devices, Activities, or Favorites.

## Creating a MyHarmony account

Steps in this section are part of the process of setting up the Harmony App, and the step numbers continue from the Connecting to Wi-Fi section above.



13. Tap **Create an account**.
14. Enter your account information and tap **Create Account**.
15. Read and accept the terms of the Software License Agreement.
16. Tap **New Setup**.
17. Read Important Tips #1 and #2, and then verify your hub connections as described in the Harmony App.
18. Continue with the steps in the next section, Setting up devices to control.

## Setting up devices to control

Steps in this section are part of the process of setting up the Harmony App, and the step numbers continue from the previous section.

Carefully enter the manufacturer or brand of your first device followed by the model number. Harmony will automatically correct for common errors such as zeros or ones being confused for the letters '0' or '1' and will provide suggestions if the entered device cannot be found.

Serial numbers found on your devices should not be entered as they are unique and cannot be used to identify the device you have. It is important to enter manufacturer and model information correctly because not doing so may cause devices to change to the wrong input, miss commands, or not function at all during Activities.

19. Make sure you have your device information collected (as described in the [Devices](#) section above).
20. When prompted by the Harmony App, click **Add my TV**.
21. Enter the manufacturer's name and model number for your TV and tap **Add**.
22. Tap **Power on** to confirm that the Smart Control knows the right signal to send your TV.
23. If the TV powered on, tap **Yes**; if it did not, tap **No**.

If you answer No, the Harmony App steps you through a series of diagnostic screens to help fix the

problem. If the Harmony App is not able to fix the problem, please refer to the Setup problems\_section in Troubleshooting. You can proceed to the next step even if you are not able to fix the problem at this time. You can fix it later on MyHarmony, as described in Modifying device settings with MyHarmony.

24. When prompted, either tap **Add** to set up an AV Receiver / Home Theater or tap **Skip, I don't have this device** if you do not wish to set up that type of device. If you choose to add the device, provide the requested information as the Harmony App steps you through a process similar to the one you just completed for the TV.
25. When prompted, either tap **Add** to set up a Cable / Satellite Receiver or tap **Skip, I don't have this device** if you do not wish to set up that type of device.

### Adding a Watch TV Activity

Steps in this section are part of the process of setting up the Harmony App or Harmony Smart Control system, and the step numbers continue from the previous section.

26. When prompted, select the devices you use to watch TV.
27. Select the inputs to use to connect your TV to other devices.



28. Confirm whether you are able to see and hear content on your TV by tapping Yes or No. If you answer Yes, you are finished with setting up your first Activity. If you tap No, you are stepped through a series of tests similar to those described in step [23](#) above.



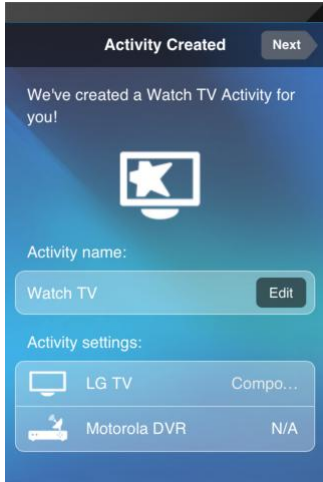

29. Follow the prompts to test your Watch TV activity.

### Setting up Favorites

Favorites allow you to quickly access your Favorite Channels. You can select up to 50 Favorite Channels for your Smart Control system.

Steps in this section are part of the process of setting up the Harmony App, and the step numbers continue from the previous section.

30. When prompted, provide your location and zip / postal code and tap **Search**. The United States location is selected by default. To change the location, tap the down arrow and select another location from the list. To enter a zip code, tap the example zip code to bring up the keyboard that allows you to enter your zip code.



31. Select a television service provider from the list associated with your zip / postal code and tap **Next**.

The next screen displays a lot of information that will help you select your Favorite TV stations:



1. **Favorites counter:** indicates how many Favorites you currently have selected.
2. **Search box:** searches for TV channels by name.
3. **Unselect all button:** unselects all Favorites.
4. **Star icons:** indicate whether a channel is a Favorite. A gold star is a Favorite and a dark star is not.
5. **List switch:** allows you to choose whether to display all channels associated with the selected provider; HD channels only; or your currently selected Favorite Channels only.

32. Tap on the star next to channels that you want to select or unselect from your Favorites list. A gold star next to a channel means that it's one of your Favorites; a dark star next to a channel means that it is not a Favorite.
33. When you are satisfied with your Favorites list, tap **Next**.

## Adding more devices

Next you are prompted to add any additional devices that you would like Harmony Smart Control to operate. You can add a total of eight devices. After you add each device, you are prompted to add an Activity that corresponds to that device. The procedures for adding more devices and Activities are very similar to the setup steps covered in the previous sections. The Harmony App will step you through the process, requesting the information it needs. If you have any problems while adding devices or Activities, refer to the Troubleshooting and [Support](#) sections of this manual for more information.

## Personalizing your remote

Next you are offered the opportunity to specify how your Smart Control remote operates. Note that the settings described in this section are configured with the Harmony App, but do not affect the behavior of the Harmony App. Because this sequence of steps is part of the initial setup of the Harmony App, and the step numbers continue from the previous section.

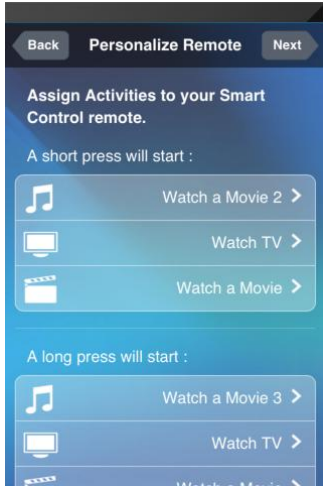

34. Review the button assignments displayed on the Personalize Remote screen.
35. If you would like to change any of the button assignments, tap the button whose assignment you would like to change, and select a new Activity.
36. When you are satisfied with your button assignments, tap **Next**.

At this time the automated setup process is complete. If everything works correctly you can begin using your remote now. If you had any problems during setup, see [Setup problems](#) under [Troubleshooting](#) for more information.

## Using your Harmony Smart Control

After completing the first time setup to add your devices, create Activities, and choose your Favorite Channels, you are ready to use your remote. The following sections describe how to access the features you will use most often.

To begin using the Harmony app, open the app on your smartphone. The first screen that the Harmony app displays is the Activities screen that is described in the next section.

### Activities

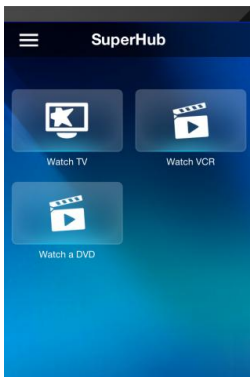

Tap an Activity to start it.

Your Harmony Smart Control will send all the commands to the necessary devices in your entertainment system. For example, to Watch TV, Harmony Smart Control will turn on your TV, turn on your cable set top box, turn on your AV receiver, set the input on your TV to HDMI 2, set the input on your AV receiver to HDMI 1.

## Switching between Activities

While an Activity is active, selecting another Activity will leave on or turn on necessary devices, turn off unnecessary devices, and select the correct inputs for each of the devices. For example, when switching from watching TV to watching a Blu-ray, Harmony Smart Control will leave your TV and AV receiver turned on, but will turn off your cable set top box and turn on your Blu-ray player. Depending on how your TV and AV receivers are set up, Harmony Smart Control may also change the inputs for those devices to the Blu-ray player.

TIP: You don't need to turn your system off in between switching Activities. Harmony Smart Control remembers what is on and off and switches between Activities automatically.

NOTE: if you would like to keep a particular device on when switching to an Activity that does not use it, this may be customized by signing into MyHarmony. For example: you may want to keep your Xbox powered on while you switch to Watch TV so you may return back to Play a Game without losing your game status. See the support article, [Set Devices to Stay On](#).

To switch between Activities:

1. Tap the Home icon: 
2. Tap the Activity you want to switch to.

## Gesture control

Each Activity allows you to control your devices using simple swipes and taps on the Harmony Smart Control screen. Twenty-two different gestures are supported. Each of the following eleven gestures can have two actions associated with it; one for a one-finger gesture and another for a two-finger gesture:

- Swipe up
- Swipe up and hold
- Swipe down
- Swipe up and hold
- Swipe left
- Swipe left and hold
- Swipe right
- Swipe right and hold
- Tap
- Double tap
- Long press



Each gesture performs a default command that depends on the current Activity. When you use a gesture, the action associated with that gesture appears on the screen and activates.

### Viewing current gesture commands

To see a list of commands associated with each gesture, tap the **i** in the upper right corner.

NOTE: Gestures are only available when an Activity is active.

### Customizing Activity gestures

To change which commands are associated with each gesture:

1. Tap the **i** in the upper right corner of the screen.
2. Tap the  icon in the upper right corner of the screen:
3. Tap the gesture you want to change.
4. Tap the action you want to take:
  - **Map a command:** to select a single command to associate with that gesture
  - **Map a sequence:** to select a sequence of commands to associate with that gesture
  - **Clear Gesture:** disable the gesture
5. Tap the device that you want the gesture to control.
6. Tap the **<** as many times as necessary to return to the Edit Gesture screen.
7. Tap **Done**.

NOTE: If you would like to assign a sequence of commands to a gesture, you can do that in MyHarmony.

## Activity commands

When your Activity starts, all the buttons on Harmony Smart Control are configured to control that Activity. For example, the volume button will control your AV receiver while the Play and Pause buttons and the directional navigation will control your cable or satellite set top box. In addition, the screen on the remote is able to display all the available commands for each device that is participating in the current Activity.

## Favorites

Tap the  icon at the bottom of the Harmony Smart Control screen while the Watch TV Activity is active to see your Favorite Channels. Favorites are only active while watching TV.

Swipe up and down on the screen to scroll your Favorites. Tap any Favorite to tune to that channel.

For information about adding, rearranging, and deleting Favorites, refer to Managing your Favorites with the Harmony App.

## Devices

Your Harmony Smart Control is designed to control your devices as part of the Activities that you set up on MyHarmony. Occasionally, you may need to access the full list of commands available for a particular device.

Tap the  icon, then tap **Devices** to enter device mode and see a list of all your devices. You can choose a device to see the complete list of commands for that device. At this time, the physical buttons on the Harmony Smart Control

remote will also control the selected device.

**CAUTION:** Do not power off any devices while in device mode. The remote does not track state changes in device mode. You can adjust settings in device mode; just don't turn devices off or on. If you accidentally turn devices off or on in device mode, you can use the Help menu item in the Harmony app to bring your devices and your Harmony Smart Control system back in sync.

## How to get the most out of your Harmony Smart Control

You can prevent some common problems if you follow the tips in this section.

### Important: use your Harmony Smart Control every time!

Always exclusively use your Harmony Smart Control or the Harmony App on your smartphone to control your devices. Do not use other remotes to control your devices, or manually turn them on or off or change inputs. Harmony is unable to track changes that it does not make and will continue to assume your devices are in the state that it has left them in.

### Adjust the power on delay

If your TV does not go to the right input when starting an Activity from an everything-off state, try increasing the power on delay for your television. This feature is accessible in your remote's Settings menu and in your MyHarmony account. See the section Modifying device settings for more information.

### Position the hub and set up hub assignments correctly for your setup

Traditional 'line of sight' required when operating most infrared remote controls is not required with Harmony Ultimate. The Harmony Hub and IR mini blaster send a strong infrared signal that can reflect off walls and other surfaces before reaching your devices.

Both the hub and IR mini blaster send strong IR signals and may control multiple devices within their range. Larger obstacles such as walls, bookshelves or doors may prevent the IR signals from reaching your devices. If this is the case, try repositioning your hub or IR mini blaster.

When used inside a cabinet, the hub or IR mini blaster can control all the devices within that cabinet. If your cabinet contains devices on multiple shelves that are isolated from one another, a hub or IR mini blaster may need to be positioned on each shelf. You can change which parts of the Smart Control system control each of your devices. For more information about hub assignments, see Changing hub assignments with MyHarmony.

### Use the Help function to put the remote back in sync with devices

Sometimes Harmony becomes out of sync with your devices and confuses when they are on or off, or which input they are on. This occurs when there is an obstacle between the device and the IR transmitters in the hub, IR mini blaster, or remote; or if the devices are operated manually or by using their original remote control. Harmony Smart Control can run through a series of questions to help identify the issue and correct it.

1. Tap the  icon.
2. Select **Help**.
3. Tap the **Power** or **Input** button for the device that is out of sync.

**NOTE:** If you use the Help feature frequently when powering on your devices or switching between Activities, then there may be changes that can be applied to correct this. The Help feature should not be necessary with a properly configured setup.

TIP: Before you use Help, make sure you take steps to address the problem: remove any obstacles from the line of sight between your remote and your system, and only use the Harmony Smart Control system when it is within range of your entertainment system.

## Changing your Setup

Once you have completed the initial setup process on the Harmony App, you can make additional changes either directly from the Harmony App or on your computer with MyHarmony. Changes that you can make include:

- adding or removing devices
- creating, updating, or deleting Activities
- managing Favorite Channels
- reordering screen commands
- changing the behavior of buttons

MyHarmony also allows advanced configuration changes such as:

- adjusting a device's power settings
- adjusting a device's input settings
- adjusting device delays
- fine tuning how Activities control your devices when they start and stop

Each of the following sections includes instructions for both the Harmony App and MyHarmony.

### Changing your setup with the Harmony App

To manage your remote setup with the Harmony App, access the Harmony App Menu by tapping this icon: 

Changes made in the Harmony App automatically sync with MyHarmony and your Harmony Hub.

### Changing your setup with MyHarmony

Using your web browser, go to <http://www.myharmony.com> and click the **Sign In** button in the upper right corner.

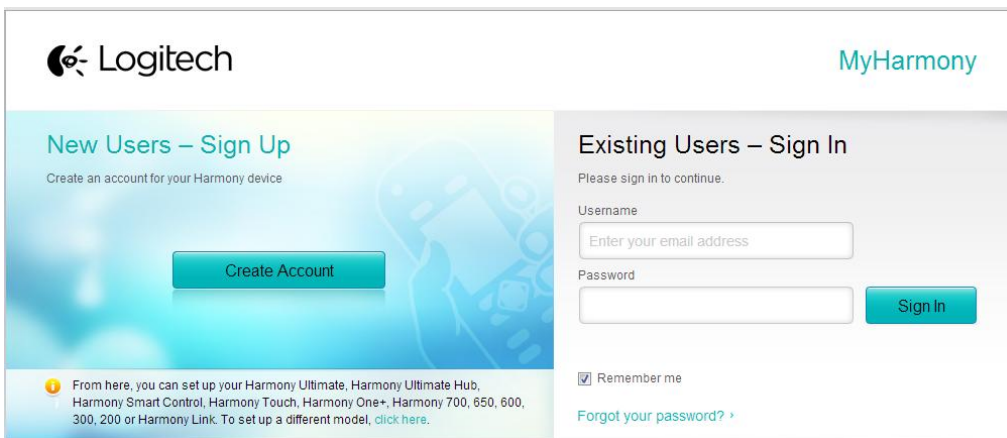

To manage your remote setup on MyHarmony:

1. Click the Harmony Smart Control image.
2. Make the desired changes, then sync your remote as described in the next section.

## Syncing your changes

Any changes made with the Harmony App will automatically sync with MyHarmony. Any changes made on MyHarmony must be manually synced with your remote:

1. Tap the ☰ icon.
2. Tap **Settings**.
3. Tap **Sync Your Harmony**.
4. Tap **Sync Now**.

## Adding devices

NOTE: Harmony will automatically correct for common errors such as zeros or ones being confused for the letters '0' or '1' and will provide suggestions if the entered device cannot be found.

NOTE: Serial numbers found on your devices should not be entered as they are unique and cannot be used to identify the device you have. It is important to enter manufacturer and model information correctly because not doing so may cause devices to change to the wrong input, send commands that do not work, or not function at all during Activities.

NOTE: After adding a new device to your account, be sure to associate it with an Activity.

## Adding a device with the Harmony App

1. Tap the ☰ icon.
2. Tap **Settings**.
3. Tap **Edit Activities and Devices**.
4. Tap **Devices**.
5. Tap **Add a Device**.
6. Enter the manufacturer name and model number.
7. Tap **Add**.
8. Follow any device-specific instructions that appear on the Harmony App screen.

## Adding a device with MyHarmony

1. Select the **Devices** tab on the left hand side of the screen.

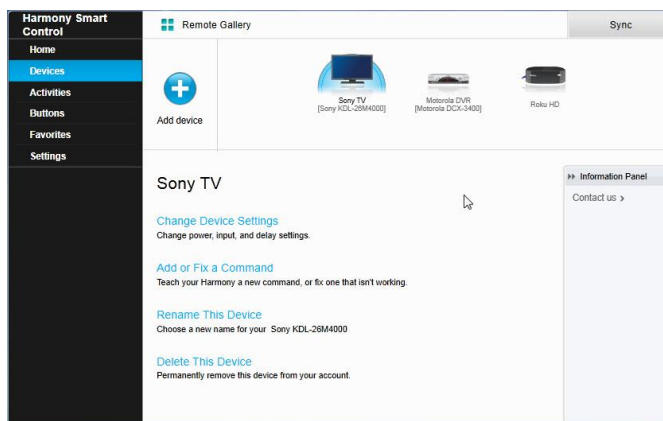



2. Click **Add Device**. The Add Device page displays.
3. Carefully enter the manufacturer or brand of your device.
4. Carefully enter the model number.
5. Click **Add**.

## Special devices

Some types of devices require that you change or manipulate some aspect of them in order for them to be controlled by Harmony Smart Control. If you have an RF-only device, a device that understands multiple IR languages, or a device that does not accept IR input at all, you will be notified of this during setup. Examples of these devices are:

- RF devices: some devices, such as DirecTV or Dish Network cable boxes, are controlled using RF (Radio Frequency) signals. If your device's original remote can operate from a different room, then it is likely using a RF signal. Some of these devices allow them to switch into an IR (infrared) mode that allows Harmony to control them.
- Multi-Code devices: some devices may be controlled using multiple different IR (infrared) signal versions. MyHarmony will use the most common version. If it does not work, it will then try other versions until the correct one is identified.
- Bluetooth devices: Harmony Smart Control works with the PS3, Wii, and Wii U game consoles over Bluetooth. The Harmony remote will guide you through this process the first time you use this device. Other Bluetooth capable devices such as television keyboards are not supported. For more information, see these articles::
  - [Control Sony PlayStation 3 with Harmony](#)
  - [Control Nintendo Wii with Harmony](#)

## Adding an unknown device with MyHarmony

**CAUTION:** This process should only be used if you cannot find a match for your device.

**NOTE:** There is no equivalent section in this guide for the Harmony App. Use MyHarmony to add unknown devices.

The database of devices on MyHarmony contains most available devices. In some rare cases you may need to add a device that is not listed in the database. Follow these steps to add an unknown device:

1. If MyHarmony is unable to find your device you will be prompted to double check the information entered. In some rare cases you may need to add a device that is not contained in the database. If your device is not found, select **Yes, I'm sure that's it** and click **OK** to proceed to teach MyHarmony about this new device.

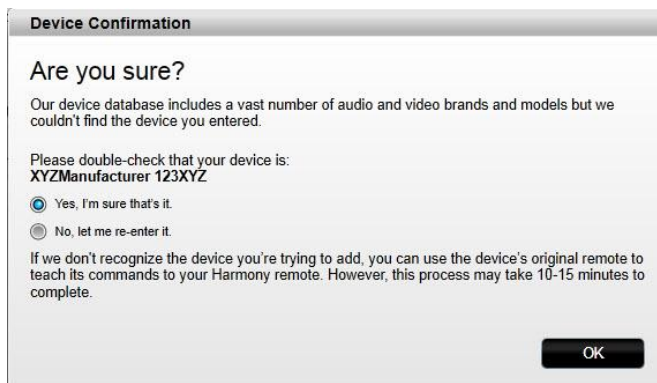

2. Click **Select your device type** to display a list of device types.

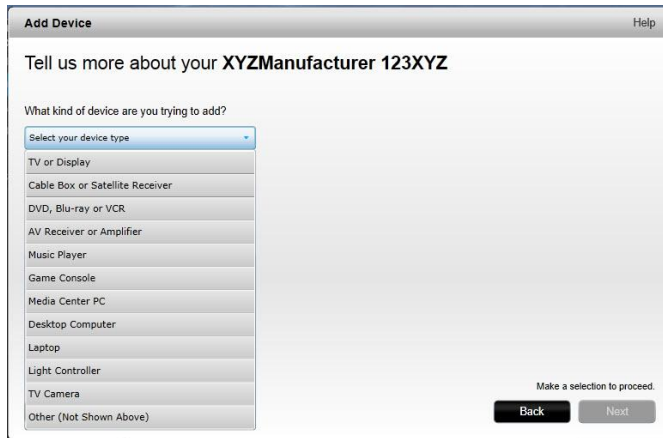

3. Select the device type that best describes your device and click **Next**. Based on your selection, another page displays to get more information about your device.

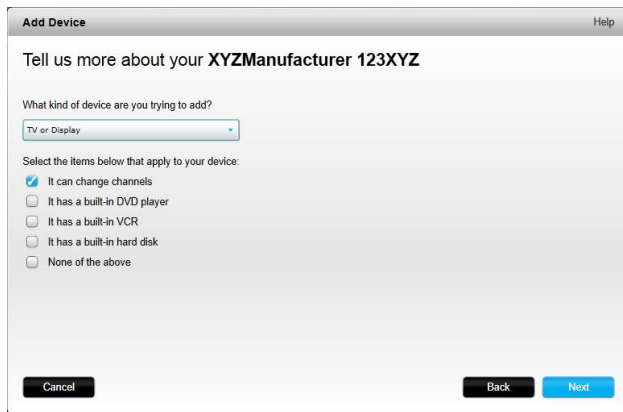

4. Check the box for each item that applies to your device. This will help setup determine which commands are appropriate for your device. Click **Next**.
5. Follow the instructions to set up your device.

## Deleting devices

**CAUTION:** Deleting a device will affect any Activity that uses that device and will have to be reviewed on MyHarmony before it can be used from your remote.

### Deleting devices with the Harmony App

1. Tap the  icon.
2. Tap **Settings**.
3. Tap **Edit Activities and Devices**.
4. Tap **Devices**.
5. Tap the device that you want to delete.
6. Tap **Delete**.
7. Confirm the deletion by tapping **Delete** on the confirmation screen.

## Deleting devices with MyHarmony

1. Click the **Devices** tab on the left hand side of the screen.
2. Select the device to delete.
3. Click **Delete This Device**. The Delete Device confirmation displays.
4. Click **Delete** to remove the device from your list.

## Modifying device settings

You can also modify the way your Harmony Smart Control will control each of your devices by changing:

- **Power settings:** if your device doesn't turn on or off correctly
- **Input settings:** if your device doesn't show the right picture or play the right sound when you start an Activity
- **Device delay settings:** If your remote sends commands too quickly or too slowly to your device
- **Device command repeats:** if your remote sends too many or too few channel up or volume up commands when you press the button once

## Modifying device settings with the Harmony App

1. Tap the  icon.
2. Tap **Settings**.
3. Tap **Edit Activities and Devices**.
4. Tap **Devices**.
5. Tap **Delay Settings**.
6. Use the sliders to change the delay settings as needed, or tap **Restore** if you previously changed the settings and want to restore them to the default settings.
7. Tap **Done**.

## Modifying device settings with MyHarmony

1. Select the **Devices** tab on the left hand side of the screen.
2. Click a device at the top of the page to select it.
3. Click **Change Device Settings**.
4. Select the type of settings you want to change and click **Next**.
5. Follow the prompts to change your settings and click **Finish** when you are done.

## Adding Activities

### Adding Activities with the Harmony App

1. Tap the  icon.
2. Tap **Settings**.
3. Tap **Edit Activities and Devices**.
4. Tap **Activities**.
5. Tap **Add Activity**.
6. Select the type of Activity to add. The choices available depend on the devices you have added. You can add more than one of each Activity type.
7. Select or deselect devices used by the Activity. When the correct devices have check marks next to them, tap **Next**.
8. Tap **Power On** to test the configuration of the Activity, or tap **Not Now** to skip the test.
9. Choose the input for your Activity and tap **Next**.
10. To optionally change the Activity name, tap **Edit** and enter a new name.
11. Tap **Next**.
12. Optionally customize which Activities are assigned to the buttons of your Smart Control remote.

13. Tap **Done**.

## Adding Activities with MyHarmony

1. Select the **Activities** tab on the left hand side of the screen.

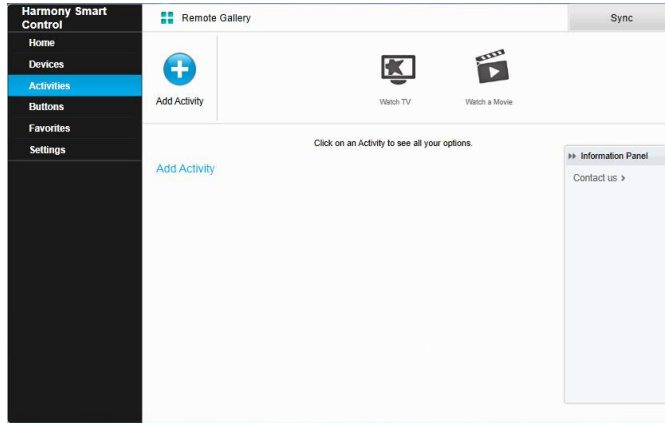

2. Click **Add Activity**.
3. Select the type of Activity to add. The choices available depend on the devices you have added. You can add more than one of each Activity type.

NOTE: Most Activities fit into one of the specific Activity types offered. The Custom Activity type is recommended only for home appliances. The Custom Activity does not provide Favorite Channels or require roles for the device being added. Button assignments may not correctly reflect what is expected for this Activity, but can be changed as described in [How to map buttons to your remote](#).

4. Click **Next**.
5. Enter a name for the Activity.
6. Click **Upload Icon** to choose an icon from your system or accept the displayed icon. This icon will also be used to represent your Activity on your Harmony Smart Control.
7. Click **Next**. The list of devices available for this Activity is displayed, with suggested devices checked.
8. Review the device list and clear any check boxes for unneeded devices.
9. Click the check the box for devices to add to this Activity.
10. Click **Next**.
11. Answer any questions about your Activity that MyHarmony asks.
12. Choose the input(s) for your Activity.
13. Review the settings for your Activity. The devices used are listed, along with the inputs and controls used.
14. The devices that are not used are also shown at the bottom of the screen.
15. Click **Done**.

## Viewing Activity settings

### Viewing Activity settings with the Harmony App

1. Tap the icon.
2. Tap **Settings**.
3. Tap **Edit Activities and Devices**.

4. Tap **Activities**.
5. Tap the Activity to view.

In addition to viewing the Activity settings, from this screen you can change the Activity name or tap **Fix Activity** to step through Activity setup to fix any problems you are having.

6. When you are finished, tap **Back** as many times as needed to return to the menu.

## Viewing Activity settings with MyHarmony

1. Click **Activities**. Your list of Activities displays.

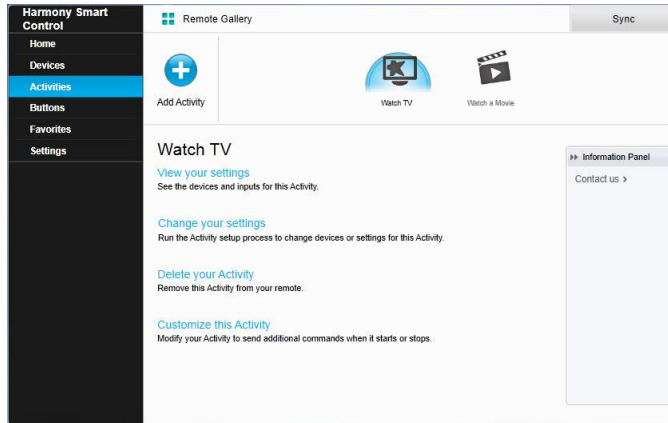

2. Select the Activity to view.
3. Click **View your settings**. The Activity settings page displays.
4. Click **Change** to go to the Change Activity Settings page or click **Close**.

## Changing Activity settings

### Changing Activity settings with the Harmony App

1. Tap the  icon.
2. Tap **Settings**.
3. Tap **Edit Activities and Devices**.
4. Tap **Activities**.
5. Tap the Activity to change.
6. Tap **Fix Activity** to step through Activity setup to fix any problems you are having. For more information about these settings, see Adding a Watch TV Activity.
7. When you are finished, tap **Back** as many times as needed to return to the menu.

### Changing Activity settings with MyHarmony

1. Click **Activities**. Your list of Activities displays.

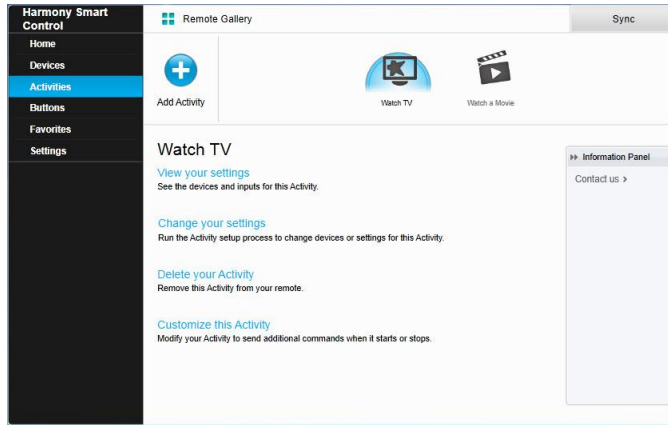

2. Select the **Activity** to change settings.
3. Click **Change your settings**. The Rename Activity page displays. This is the first page in the process for changing the Activity settings.
4. Follow the instructions to change the remaining settings for the selected Activity.

## Deleting Activities

### Deleting Activities with the Harmony App

1. Tap the ☰ icon.
2. Tap **Settings**.
3. Tap **Edit Activities and Devices**.
4. Tap **Activities**.
5. Tap the Activity to delete.
6. Scroll down and tap **Delete**.
7. Confirm the deletion by tapping **Delete** on the confirmation screen.

### Deleting Activities with MyHarmony

1. Click **Activities**. Your list of Activities displays.

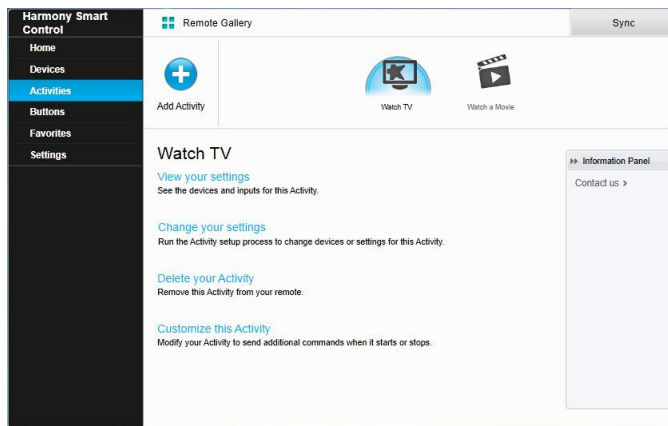

2. Select the Activity to delete.
3. Click **Delete your Activity**. The Delete Activity confirmation displays.
4. Click **Delete** to remove the Activity from your list. Any changes made will be lost, such as Activity customizations and button assignments.

## Changing your location or channel provider

If you move or change your TV channel provider, you will need to change those settings in your MyHarmony account. Harmony allows you to configure one service provider and associate that to one primary Watch TV Activity.

**CAUTION:** Selecting a new provider will reset all previously configured Favorite Channels and only Favorite Channels will be reset!

### Changing your location or channel provider with the Harmony App

1. Tap the  icon.
2. Tap **Settings**.
3. Tap **Edit Activities and Devices**.
4. Tap **Favorites**.
5. Tap **Edit**.
6. Tap **Next**.
7. Enter your location and zip / postal code, then tap **Search**.
8. Select you provider from the list. If you do not see your service provider, you may need to choose a neighboring zip / postal code.

### Changing your location or channel provider with MyHarmony

1. Select the **Favorites** tab from the left hand side of the screen.
2. Click **Edit Your Service Provider**:

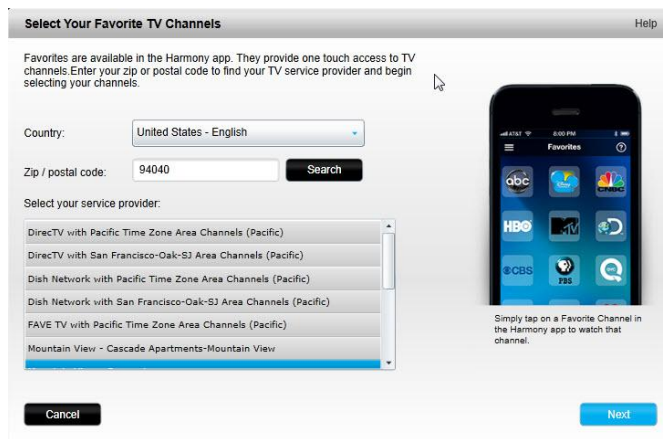

3. Follow the same steps performed during your first time setup to choose your location, TV provider and new Favorites.

## Managing your Favorites

### Managing your Favorites with the Harmony App

1. Tap the  icon.
2. Tap **Settings**.
3. Tap **Edit Activities and Devices**.
4. Tap **Favorites**.
5. Tap **Edit**.
6. Tap **Next**.

7. Confirm that your correct location, zip / postal code, and service provider are selected.
8. Tap **Next**.
9. To remove a Favorite, tap the gold star next to that channel.
10. To add a Favorite, tap **All** (to see all channels) or **HD** (to see HD channels only) and tap the gray star next to that channel.
11. When you are finished, tap **Done**.

## Managing your Favorites with MyHarmony

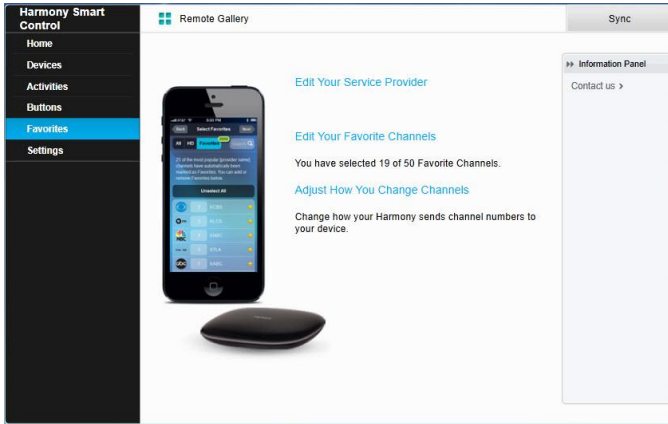

To add, modify or reorder your Favorites:

1. Select the **Favorites** tab from the left hand side of the screen.
2. Click **Edit Your Favorite Channels**. The Set up Favorites page displays. Current Favorites are shown with a gold star in the first column.

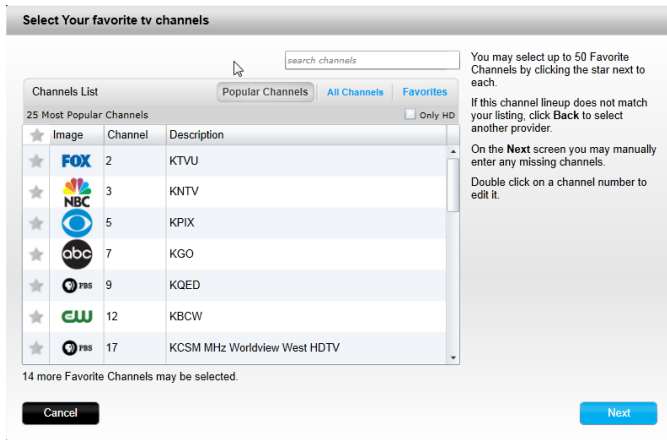

3. To add or remove a channel from your Favorites, click the gold star beside that channel so it is highlighted or grayed out. If the channel you want to add is not in the list, or is missing the icon or channel number, you can add it on the next screen by clicking **Next**.



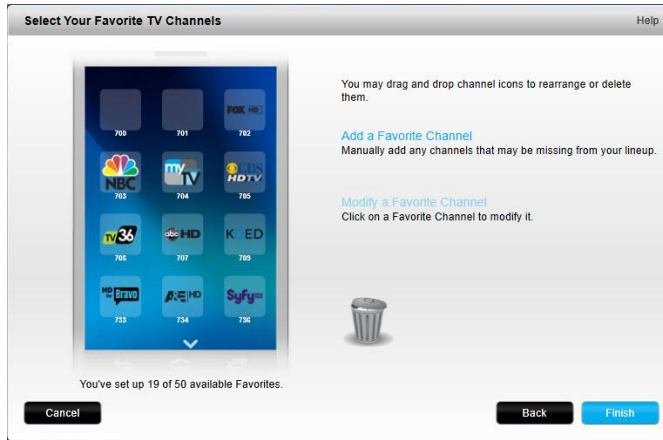

4. On the Select Your Favorite TV Channels screen, you can drag and drop your current Favorites into the exact order you want them to appear on your Harmony Smart Control. Here you can also drag a Favorite to the trash can icon to remove it from your remote.
5. To add a Favorite Channel that does not appear in the list on the previous screen, select **Add a Favorite Channel** to manually enter the name and number for that channel. Optionally, you can upload an icon for that channel from your computer's file system:

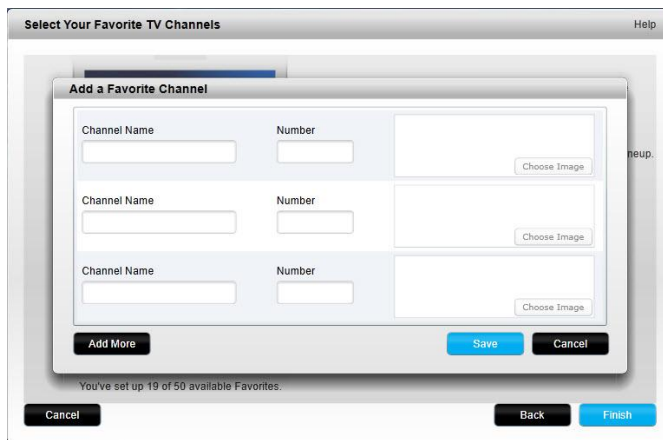

6. To modify the name, number or icon for a Favorite Channel, select it and click the **Modify a Favorite Channel** link. Enter the channel name and channel number. You can also choose a channel icon from your computer file system. Click Browse to select an image file.

TIP: you can also add, remove or reorder your Favorites directly in the Harmony app.

## Advanced customization

### Customizing Activities with MyHarmony

You can add extra steps to an Activity if you want to customize it further. For example, your Watch a Movie Activity can be set up to automatically send the Play command to start your movie.

NOTE: There is no equivalent section in this guide for the Harmony App. Use MyHarmony to add extra steps to an Activity.

To add steps to an Activity in your MyHarmony account:

1. Click **Activities** and select an Activity to customize.

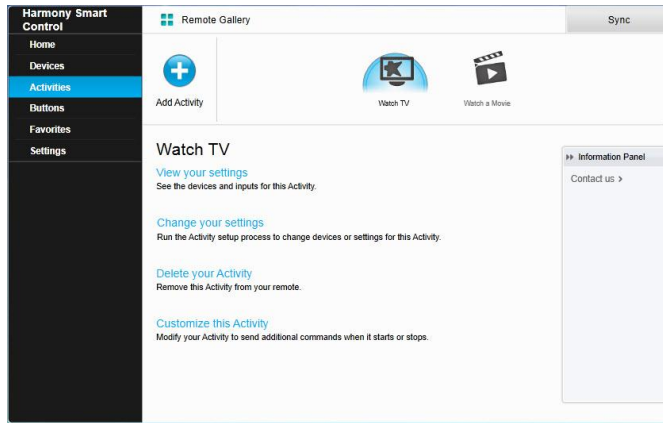

2. Click **Customize this Activity**. The Customize: Activity Sequence page displays. In this example, the Watch TV Activity is shown.

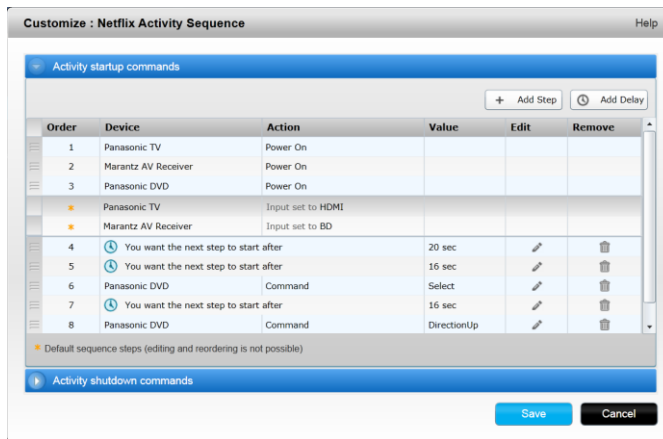

3. Add steps or delays to your Activity as desired.

## Customizing buttons to perform a sequence of commands with MyHarmony

A button sequence is a set of commands that can be grouped together and assigned to one button on your remote, helping to automate certain tasks. Button sequences are sometimes referred to as macros.

NOTE: There is no equivalent section in this guide for the Harmony App. Use MyHarmony to set up a button sequence.

To create a button sequence in your MyHarmony account:

1. Click the **Buttons** tab on the left hand side of the screen.
2. Select an Activity or device from the pull-down menu for the area of the remote you would like to create a sequence for—screen or buttons, and click **Go**.
3. Click the **Sequences** tab on the right side of the screen
4. Click on **Add Sequence**. The Add Sequence page opens.
5. Enter a name for your sequence. Try using a name for your sequence that will represent what you are

- programming it to do.
6. Add steps or delays to your sequence as desired.
  7. Click **Save** when finished. Your Sequence will appear in the list.
  8. Assign your button sequence to a single button as described in the next section, Customizing Activity buttons.

## Customizing Activity buttons with the Harmony App

**NOTE:** You can customize only the three Activity buttons at the top of the Smart Control remote using the Harmony App. Each button can support two different activities: one with a short tap and one with a long press of the button. With MyHarmony, you can customize any button on the Smart Control remote. For more information about customizing your Smart Control remote buttons, refer to Customizing buttons and on-screen commands with MyHarmony.

1. Tap the  icon.
2. Tap **Settings**.
3. Tap **Edit Activities and Devices**.
4. Tap **Remote**.
5. Tap **Customize**.

There are two groups of settings on this screen. The first group controls the actions of the Activity buttons when using a short press of the button; the second group controls the actions of the Activity buttons when pressing and holding the button for a couple of seconds.

6. Tap the button to customize.
7. Select an Activity to associate with the button.
8. Tap **Done**.

## Customizing buttons and on-screen commands with MyHarmony

Harmony allows you to customize the commands that each button sends, or what commands appear in your Activity list. These button mappings may be unique for each of your Activities. This allows each button or screen to have different functions based on context. For example, in your Watch a DVD Activity, the yellow button may perform the eject command, while in your Listen to Music Activity this same yellow button may be used to pull up your Favorite preset.

When customizing your Harmony remote you may find that commands have slightly different names than those of your original remote. For example, Select, OK, and Enter often perform the same action, but may be named differently based on the original manufacturer.

### Activities mode

When you select an Activity to map buttons for, the buttons only perform the assigned functions while the activity is in progress for which they were mapped. If you want to assign a button function for all Activities, you will need to do it for each individual Activity.

#### ***How to map buttons to your remote with MyHarmony***

1. Select the **Buttons** tab on the left hand side of the screen.
2. Select an Activity for the area of the remote you would like to create a sequence for and click **Go**.
3. Select a button on the illustration of the remote. You can scroll the illustration to see buttons at the bottom of the remote.
4. Hover over a command to assign to that button and click on **Long Press**, **Short Press**, or **Both** to make the selection.

5. Click **OK**.

NOTE: Each button on your remote can be assigned more than one command. For example, the Fast Forward button on the top of your remote can be set up so that quickly pressing it (short press) activates the Fast Forward function and holding it (long press) activates the Skip Forward function. You can also assign a sequence of commands instead of a single command, but you must use MyHarmony to assign command sequences to buttons.

### Device mode

It is recommended that you map buttons while in Activities mode so that you do not need to go into device mode to send commands to your device. Buttons mapped in device mode will not carry over into any of your Activities.

## Changing hub assignments with MyHarmony

By default, IR signals are sent at the same time from the Harmony Hub and the IR mini blaster in order to control your equipment. This default works for the vast majority of configurations. If you have an advanced set up such as multiple televisions or multiple set top boxes that are of the same manufacturer, then you may need to isolate signals to the IR mini blaster. To change this behavior:

1. Select the **Settings** tab on the left hand side of the screen.
2. Click **Hub Assignments**.
3. Select the correct assignment for each device from the drop-down list for that device. Choose between:
  - Hub & mini blasters
  - Hub only
  - Mini blaster port 1
  - Mini blaster port 2
4. Click **Finish**.

## Upgrading your Harmony Smart Control firmware

When new firmware is available for Harmony Smart Control, the Harmony App displays a message notifying you to sync your Harmony App with MyHarmony. In addition, when you manually sync your Harmony App with MyHarmony, it always checks for a firmware update and begins the update if needed.

# Personalizing your Remote

## Customizing Favorite Channel icons with MyHarmony

When you choose a Favorite Channel from the list of channels offered by your provider, a default icon for that channel is provided. To choose a different icon for a channel, follow these steps:

1. Select the **Favorites** tab on the left had side of the screen.
2. Click **Edit Your Favorite Channels**.
3. Click **Next**.

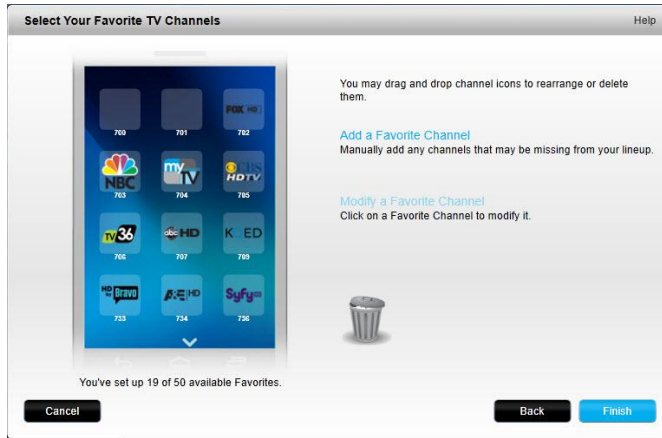

4. Click a channel icon. Use the scroll arrow to see more Favorites if the one you are looking for is not visible.
5. Click **Modify a Favorite Channel**.

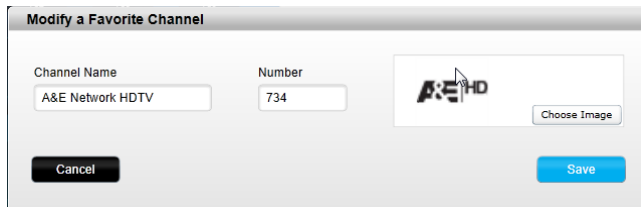

6. Click **Choose Image**.
7. Select an image and click **Save**. The icon for that channel is replaced with your image.
8. Click **Finish**.

## Remote Control Menus

The  icon on the Harmony App screen opens the menu for the remote. The following sections describe the actions you can take using the menus on the remote. Almost anything you can set up using MyHarmony on your computer can also be set up on your smartphone. This section describes how to use the Harmony App to make changes. For a list of changes you must make in MyHarmony, visit the [Changes that can't be made FAQ](#).

### Help

If your remote becomes out of sync with your devices, tapping Help from the remote control menu causes the remote to attempt to fix this. If the remote control is not able to solve your problem, refer to the [Troubleshooting](#) section of this manual for additional assistance.

**NOTE:** If you are using the Help feature frequently when powering on your devices or switching between Activities, then there may be changes that can be applied to correct this. The Help feature should not be necessary with a properly configured setup.

### Connect to your Harmony

If you lose the Wi-Fi connection for the Hub or your smartphone, you can use this menu item to scan for your hub and connect to it. If you have other Harmony hubs in your network or household, you can also switch between them by using this menu item.

## Edit

Edit lets you re-order the display of Activities on the Harmony App by dragging and dropping them in a new location.

## Devices menu

The Devices menu allows you to control individual devices with on-screen commands. All of your devices are listed, regardless of whether or not they are included in an Activity. Tap a device on the list to see what options are available for that device. You can tap any of those options, or tap < to exit that menu.

**CAUTION:** The remote does not track state changes in device mode. Do not power off any devices or change inputs while in device mode. Also, changes made in device mode do not affect the behavior of devices during your Activities. It is recommended that you change device settings in Activities mode.

## Settings menu

After completing the first time setup process, many settings can be changed on the remote that let you personalize your Harmony Smart Control or affect how it controls your entertainment system.

To access the Settings menu, tap the  menu icon, then tap Settings.

The following sections describe how you can adjust settings related to your remote, your Activities and your devices.

## Sync your Harmony

Initiates a sync of the Harmony App with your MyHarmony account.

Settings made directly on your Harmony App automatically sync with your MyHarmony account if your Harmony is configured to use your home's Wi-Fi network.

Changes made from MyHarmony must be manually synced with the Harmony App and your Harmony Smart Control remote.

## Set up new remote

Initiates the first-time setup process described in [Set up the Harmony App](#). The Harmony App is only supported for the iPhone 4s or newer, the new iPad, the iPad Mini, and Android phones. If you want to run the Harmony App on an older iPhone, you have to first set it up on a supported device or on MyHarmony. Once setup is complete in MyHarmony, an older iPhone can use the Harmony App to control your devices.

## Edit devices and activities

When you tap Edit devices and activities, the Harmony App connects to MyHarmony to make the changes both in the Harmony App and in your MyHarmony account. When you finish making changes, a sync with MyHarmony happens automatically.

### Devices

- Add devices
- Delete devices
- Add missing commands from the original remote. You will need the original remote to teach the Harmony App

these commands.

- Fix delay settings:
  - **Power on:** The time your device needs to power on, warm up, and be ready to receive additional commands.
  - **Inter-key:** The time your device needs before being ready to accept another command.
  - **Inter-device:** The time your remote waits between sending commands to different devices within the same Activity.
  - **Input:** The time your device needs to be ready to accept another command after switching inputs.

### Activities

- Add Activities
- Delete Activities
- Customize Activity by adding steps to the start up and shut down of the activity
- Change Activity names and settings
- “Fix” activity by doing one or more of the following:
  - changing devices involved
  - running a power on test
  - changing input connections

### Favorites

- Edit channels in list
- Change service provider
- Change channel tuning settings. If channel selection on your original remote is done differently when selecting channels by number, this will resolve the issue. Options are:
  - numbers only
  - numbers and “enter/select”
  - always 2-digit numbers
  - always 3-digit numbers

### Remote

- Customize Activity buttons on the physical remote
- Pair the remote to the Harmony Hub.

### Account Info

- Look up email ID
- Change name or location
- Change password

### Reset button layout

If you have made any changes to the button layout for the Harmony remote, you can reset it to factory settings [here](#).

### Reset gesture mapping

If you have made any changes to gesture mapping for the Harmony App, you can reset it to factory settings [here](#).

## Reset Favorites

If you have made any changes to the Favorites list, you can reset it to the 25 most popular channels for your location here.

## Auto lock

By default, your smartphone will stay awake while the Harmony App is running so that you have instant access to your remote control functions. You can disable this here if you prefer your smartphone to go to sleep on its usual schedule.

## Haptic feedback

In devices that support vibration, the Harmony app gives tactile feedback when certain commands and gestures are used. You can turn this feature on or off here.

## Customer support

Provides a link to view self-help articles, FAQs, and support contact information. Can also send logs from Harmony Hub to Logitech for troubleshooting.

## Privacy Policy

Displays the Logitech Harmony Privacy Policy.

## About

- Email ID (for MyHarmony)
- Hub Name
- Hub FW (firmware number)
- Hub IP Address
- App Version
- Build Number
- Last Sync

# Troubleshooting

## Setup problems

Once you complete the setup process through MyHarmony, your Harmony Smart Control system should work properly to control your devices. Here are common troubleshooting tips. If you do not find the solution to your problem here, the Harmony Smart Control online support articles and user community can also help troubleshoot unique issues. Refer to Support for more information.

Symptom	Possible Cause	Solution	See Also
I tap an Activity and one or more devices does not turn on	The Smart Control system is out of sync with your devices	Use <a href="#">Help</a> or Edit devices and to restore synchronization.	<a href="#">Harmony Smart Control On-Remote Help</a>
	By default all devices are assigned to the hub and blaster. If one or more of your devices needs to be	Remove any physical obstructions or reposition the mini blasters and try again. If that doesn't solve the problem, use <a href="#">Help</a> or Edit devices and to restore synchronization.	<a href="#">Harmony Smart Control On-Remote Help</a>



	controlled by the remote you will need to assign it to remote		
	The inter-device delay time is too short	Set the inter-device delay time to a longer interval. Refer to Modifying device settings with the Harmony App.	<a href="#">Harmony Smart Control doesn't switch between activities without using the Help feature</a>
My devices turn on but the wrong input is selected	The power on delay time for your device is too short	Change the delay time using the Harmony App or with MyHarmony	Modifying device settings  <a href="#">Harmony Smart Control activities do not work when first powering on devices</a>
	The wrong device information is being applied	Make sure you entered the correct brand and model numbers for your devices.	
	The wrong input was selected for that Activity during configuration	Correct the input settings using the Harmony App by following the steps in the Changing Activity settings with the Harmony App section, or in MyHarmony by following the steps in Changing Activity settings with MyHarmony.	<a href="#">Changing the inputs of an activity on the Harmony Smart Control</a>
Device is not changing channels properly	The inter-key delay time is too short	Change the delay time using your remote or with MyHarmony as described in <a href="#">Harmony Smart Control sends commands slowly in activities</a>	Modifying device settings
	Depending on the device, a different sequence of buttons may be required to change channels	Fix the channel tuning settings in the Harmony app:  <ol style="list-style-type: none"> <li>1. Tap the  icon.</li> <li>2. Tap <b>Settings</b>.</li> <li>3. Tap <b>Edit Activities and Devices</b>.</li> <li>4. Tap <b>Favorites</b>.</li> <li>5. Tap <b>Channel Tuning</b>.</li> <li>6. Select the method for changing channels that is used by your original remote.</li> </ol>	
An Activity works when I select it as the first Activity when I power on my system, but not when I select it while I'm using another Activity	The inter-device delay time is too short or too long	Change the delay time using your remote or with MyHarmony as described in <a href="#">Harmony Smart Control doesn't switch between activities without using the Help feature</a>	Modifying device settings

I want to add a new Activity or change how an Activity is defined		Go to MyHarmony and follow the steps for Adding Activities or Changing Activity settings	
The right devices turn on but the play/stop/other buttons don't operate the device.	Accurate device operation information was not available for your device	Follow the steps for Customizing Activity buttons	
One or more devices does not respond to the Harmony system	There is a physical obstruction between your remote and your hub	Remove any physical obstructions or change how your hub assignments control your devices.	<a href="#">Changing hub assignments</a>
	There is electrical interference from Wi-Fi, Bluetooth, a microwave oven, a cordless telephone, or some other device.	Turn off power to possible sources of interference and try again.	
	The incorrect manufacturer or model number was entered for the device	Verify the manufacturer and model number to make sure it is correct in your Harmony setup.	

## Wi-Fi problems

If you are having trouble getting your Harmony Smart Control to communicate with your Wi-Fi network, please read the [Harmony Smart Control Not Able to Connect to Wi-Fi](#) FAQ.

## Add missing commands to your Harmony Smart Control

If your remote control buttons are not working properly, you can teach functions to the buttons individually using MyHarmony. For more information, see Customizing buttons and on-screen commands with MyHarmony.

## Hub is not syncing to the Harmony app

If you cannot sync with the Hub, you may need to sync the Hub using MyHarmony.

1. Ensure that you are not connecting the Harmony Hub to your computer through a USB hub. If you are, connect the cable directly to a computer USB port.
2. Unplug the USB cable from your computer, and plug it in again. Unplug the USB cable from your Harmony device, and plug it in again.
3. Completely close your browser, start your browser again, and return to MyHarmony.
4. Plug the USB cable into a different USB port of your computer.
5. Disable any anti-virus, firewall, or pop-up blocker programs.
6. Restart your computer.

7. Try using a different computer to connect the Harmony device.

## Devices do not respond to Harmony Smart Control

There are a number of reasons why Harmony Smart Control may not be able to control your devices after setup. The latest information about solving this problem is available online in the support article [Harmony Smart Control Activity not working](#).

# Support

## Find answers to questions online

Answers to many of your questions can be found either in Logitech's online knowledge base or in discussions in Logitech's user forums.

### Logitech Harmony remote knowledge base

The knowledge base is a collection of articles written by our technical support group.

Visit our knowledgebase at <http://www.logitech.com/support/universal-remotes>.

### Logitech Harmony remote user forum

If your question isn't answered in the knowledge base, Logitech's user forums are a valuable source of information. There our customers and our technical support staff discuss questions posed by users like you.

Visit the Harmony Remote User Forums at [http://forums.logitech.com/t5/Harmony-Universal-Remotes/ct-p/harmony\\_remote\\_controls](http://forums.logitech.com/t5/Harmony-Universal-Remotes/ct-p/harmony_remote_controls) and search for "harmony team". You will see articles posted by Harmony support team members in chronological order.

## Contact customer support:

Click the [Support](#) link in MyHarmony for a list of links to all available support options for your Harmony Smart Control remote control.

# Copyright

© 2013 Logitech. All rights reserved. Logitech, the Logitech logo, and other Logitech marks are owned by Logitech and may be registered. All other trademarks are the property of their respective owners. Logitech assumes no responsibility for any errors that may appear in this manual. Information contained herein is subject to change without notice.