



HEAVY-DUTY REPLACEMENT PRODUCTS:

Air Springs, Tensioners, Belts and Hose

AIR SPRINGS

Super-Cushion®	2
Air Suspension Feature and Benefits	3
Components of Super-Cushion® Air Springs	3
Product Identification System	4
How to Identify an Air Spring	4

BELTS AND TENSIONERS

Gatorback® Poly-V® Belts	6
Gatorback® V-Belts	7
Hi-Miler® Truck Belts	8
MatchMaker® V-Belts	9
Insta-Power® Green Seal Belts	10
Lawn and Garden Drive Belts	11
FHP V-Belts	11
Gatorback® Belt Tensioners.....	12

HYDRAULIC HOSE

Hydraulic Hose Assembly Systems	14
Hydraulic Hose Applications.....	15
Hydraulic Fittings	16

RADIATOR AND HEATER HOSE

Molded Radiator Hose	18
Molded By-Pass and Heater Hose	18
Inventory-Reducing Universal Heater Hose	18
Super Hi-Miler® Kits	19
Flexible Radiator Hose.....	20
Radiator Hose Reducers.....	20
Hi-Miler® Straight Radiator Hose.....	21
Heavy-Duty Straight Radiator Hose	22
Standard Straight Radiator Hose.....	23
Wire-Reinforced Radiator Hose	24
Hi-Miler® Blue Heater Hose	25
Hy-T® Red Heater Hose	26
Hy-T® Black Heater Hose	27
EZ Coil™	28

FUEL HOSE

Fuel/PCV/Emission Control Hose SAE 30R7.....	29
Fuel Injection Hose SAE 30R9.....	30
Fuel Fill Hose SAE 30R6.....	31
Fuel Fill Hose/Marine Exhaust Hose	32

AIR BRAKE HOSE

Air Brake Hose	33
----------------------	----

SILICONE HOSE

Silicone Charge Air Cooler Hose	34
Silicone Charge Air Straight Sleeve Hose.....	35

BRAKE, STEERING, TRANSMISSION HOSE

Transmission Oil Cooler Hose	36
Power Steering Return-Side Hose	36
Power Brake Vacuum Hose (Heavy Wall Construction)	37
Power Brake Vacuum Hose (Light Wall Construction)	37

TUBING

Windshield Wiper/Radiator Overflow Tubing	38
--	----

GARAGE EXHAUST AND AIR HOSE

Flexsteel® Service Station Air Hose	39
Service Station Air Hose	40
Pliovic® PVC Air Hose	40
Signal Call Bell Hose.....	41
Sureline® Washdown Hose	41
Garage Exhaust Hose and Accessories.....	42
Multi-Purpose Air Duct	45

CLAMPS AND CONNECTORS

Hose Clamps and Connectors	46
----------------------------------	----

MERCHANDISE TOOLS

Merchandise Tools.....	48
------------------------	----

Super-Cushion®

AIR SPRINGS FOR TRUCKS, TRAILERS AND BUSES

Give your trucks, trailers and buses a new high in productivity and longer life with Super-Cushion® air springs. They offer a quiet, cushioned ride and greater comfort, which allows the driver to stay more alert and less fatigued. Truck, trailer and bus bodies last longer because there is less vibration than experienced with steel springs. Plus, cargo has better protection from shock and vibration.

When used with leveling valves, Super-Cushion® air springs maintain consistent trim regardless of the load. That means clearance heights remain constant, and trailer floors are flush with loading dock floors. Whenever you want to add an axle, Super-Cushion® air springs fit right in.

Choose Goodyear Engineered Products Super-Cushion® air springs for driver comfort, load cushioning, and longer life for your trucks, trailers, buses, and cab and seat springs.



Air Suspension Features and Benefits

A greater level of isolation:

- Reduces cab and body damage
- Reduces downtime, driver fatigue, and extends trailer life

For the owner-operator, air suspension:

- Improves isolation in both loaded and unloaded conditions
- Broadens types of load available for transport
- Provides greater driver comfort
- Increases resale value

Reasons for increased air suspension usage:

- Suspension manufacturers have built in a greater degree of durability and longer warranty periods
- Increased need for greater axle excursion

Components of Goodyear Engineered Products Super-Cushion® Air Springs

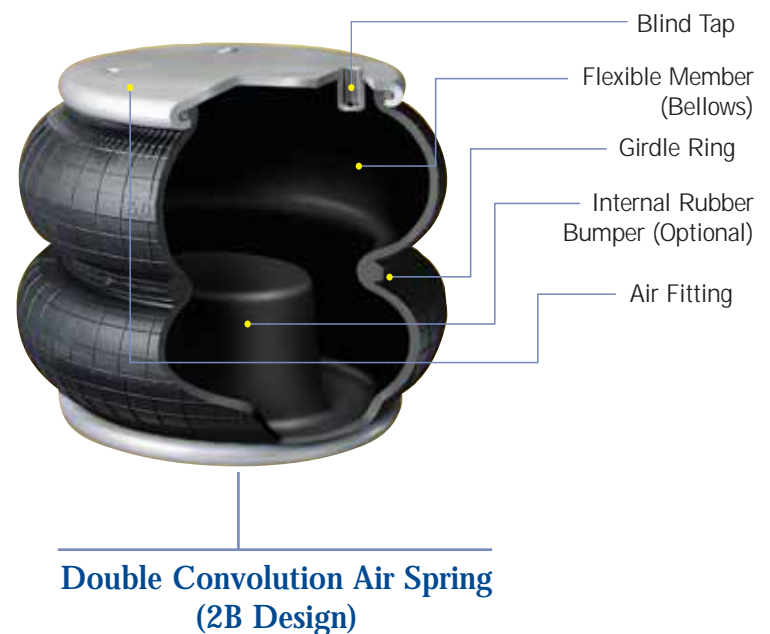

Product Identification System

Elements of the part identification system are shown in the following example for ordering an assembly with the part number 2B12-300.

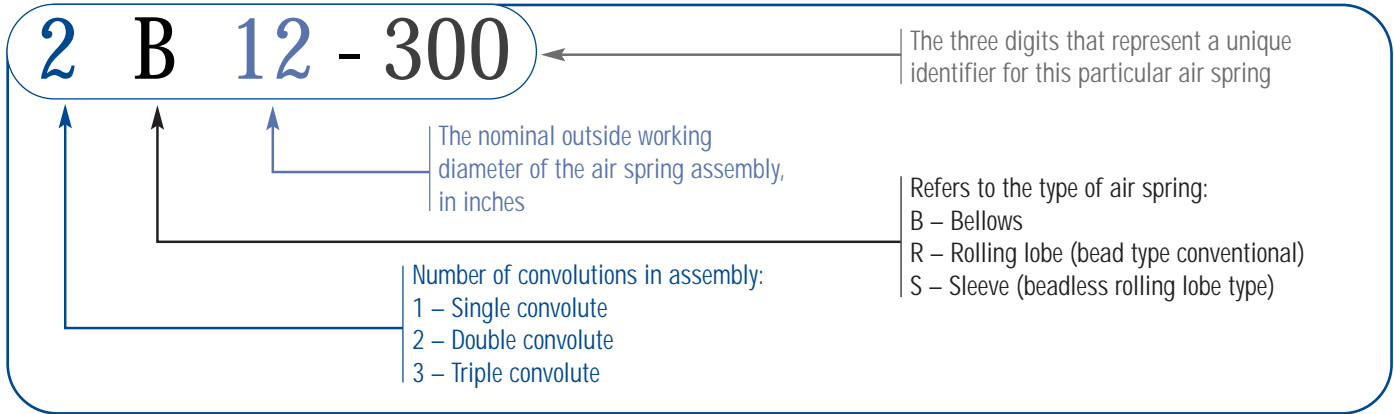

How to Identify an Air Spring

Step 1

The original equipment or aftermarket number is affixed to the top plate of the air spring assembly. Then just double-check the product photo in the main body of the Goodyear Engineered Products catalog. **If this number is unknown due to wear on the sticker or other reasons, refer to steps 2 through 6.**



Step 2

Begin your search with the flexible members number, which is molded into the rubber part of the air spring. Now you can narrow down the choices in the Flexible Members Index section of catalog #719-99.

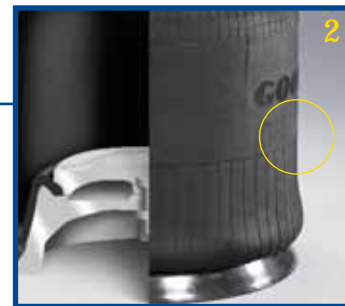

Step 3

Measure the width of the top plate, making a note of the bolt pattern or taps.



Step 4

Measure the width of the piston or bottom bead plate, making a note of the bolt pattern or taps. Be sure to note how the bolt pattern is oriented compared to the bolt on the top plate (incline or rotated). This is how the catalog illustrations are drawn.



Step 5

Compress the bag as far as possible with no air pressure and measure from the bead plate to the bottom of the piston. This is known as the compressed or minimum height. This will help determine if there is an internal bumper.



Step 6

Measure the distance from center to center of each bolt on the top and bottom of the air spring.



You now have the information you need. Compare your data with the narrowed down list of air springs you found via the flexible member or bellows number. Then proceed to the photo section of catalog #719-99.

If you have an O.E. number or a Firestone number, look in the cross-reference section in the back of catalog #719-99.

Gatorback® Poly-V® Belts | Designed for Quiet Performance, Constructed for High Efficiency

QUIET CHANNEL TECHNOLOGY™

Goodyear Engineered Products' unique staggered-cog profile and advanced rubber compounds virtually eliminate the chirps, squeaks and squeals associated with typical pulley misalignment.

GREATER WEAR RESISTANCE

High-strength tension members are specially treated to maintain tension, resulting in controlled elongation.

EXCEPTIONAL BELT LIFE

The same advanced technology that allows the Gatorback® to run so quietly also makes it more flexible and allows it to run cooler - resulting in a belt that lasts considerably longer than comparable belts.

FUNCTIONAL PART NUMBER GIVES YOU THE BELT SIZE

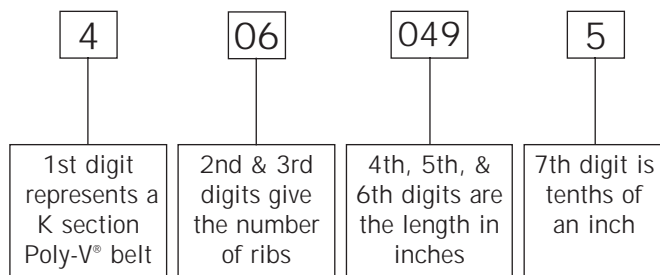

Part number 4060495 would be a K section Poly-V®, six ribs wide, with a length of 49 and 5/10 inches.



Gatorback® V-Belts



HIGH-STRENGTH TENSION MEMBERS

High-strength tension members resist shockload failure. Their low elongation properties assure uniform performances over the life of the belt.

TOUGH, SYNTHETIC COGS

Fiber-reinforced, rubber helical cogs offer greater flexibility that reduces cracking and fatigue in the cushion section.

FULL V DESIGN

Rubber edges maintain positive, no-slip contact with pulley grooves for reliable energy transfer.

FUNCTIONAL PART NUMBER GIVES YOU THE BELT SIZE

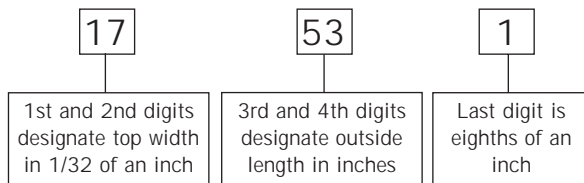

Part number 17531 is a V-belt with a top width of 17/32 inch and a length of 53 1/8 inches.

NASCAR® and NASCAR Performance® are registered trademarks of the National Association for Stock Car Auto Racing, Inc.

Hi-Miler® Truck Belts

FEATURING:

[Heat-Resistant Square Woven Fabric](#) - Reduces surface fatigue and resists cracking and heat.

[High-Strength Cable Cords](#) - Tension members provide great strength and low elongation. Balanced design distributes the load equally.

[Reinforced Insulation](#) - Fiber-reinforced, high-quality synthetic rubber insulation around cords provides greater strength and support to each tensile cord member.

[Reinforced Cushion Section](#) - Heat-resistant, high-grade synthetic rubber compression section is fiber-loaded to provide balanced support for the load-carrying tensile cords.

[Two Plies of Fabric](#) - High-quality plies of fabric provide increased transverse rigidity to resist dishing or sagging under higher tensions and provide better performance.

[Molded Cog Construction](#) - Precision-molded cogs deliver improved flexibility over small, high-speed pulleys and allow for cooler running belts.

[MatchMaker®](#) - Goodyear Engineered Products MatchMaker® belts are manufactured with precise tolerances and exacting quality.



TRUCK REFRIGERATION BELTS

These main drive belts for truck refrigeration units are especially designed for long life on mule drives and backside idler drives. Our premium, rubber-impregnated fabric resists heat and wear. High-strength Vytacord® tension members improve flex life, eliminate excess elongation, and increase resistance to shock loads. Cushion section is made of Goodyear EP's premium rubber to resist heat. Accessory drives also found in the refrigeration units are driven by hex belts, Torque Flex® belts and Insta-Power® belts.



TORQUE TEAM® TRUCK BELTS

Designed For Specific Original Equipment Applications

These banded or joined drive belts supplement the Hi-Miler® Truck Belt line to provide full coverage for specific applications. Goodyear EP's high-quality standards provide maximum performance and belt life.

MatchMaker® V-Belts

REDUCE INVENTORY INVESTMENT!

Our innovation and leadership in belt design and manufacturing permit Goodyear Engineered Products to build belts to more precise tolerances. Goodyear EP belts meet the requirements of many multiple belt applications.

REDUCE LOST ORDERS!

When MatchMaker® belts are available right from stock, you reduce the likelihood of losing an order simply because you can't obtain the right set of matched belts as needed.

IMPROVE SERVICE!

Your customers will appreciate the quick, dependable service that you will be able to provide when MatchMaker® belts are available from local stock. Improved customer service means more business!

INCREASE RETURN ON INVESTMENT!

Reduced inventories, increased sales and simpler procedures mean that you can expect to receive a better return on your belt investment.

HY-T® MATCHMAKER® V-BELTS - A, B, C SECTIONS

HY-T® V-belts are built with strong, continuous, specially treated tension members. Belts are dimensionally stable so they stay matched in a variety of applications. HY-T® belts are flexible, cool-running and heat-resistant and are static-conducting for long, reliable service.



HY-T® WEDGE MATCHMAKER® BELTS - 3VX CROSS SECTION

The 3VX HY-T® Wedge MatchMaker® belt is designed for use on drives with moderate horsepower, small diameter sheaves and short centers. Molded cog notches vulcanized into the belt provide maximum flexibility and heat dissipation. Premium fiber-reinforced rubber provides excellent tensile cord support for longer life and better performance.

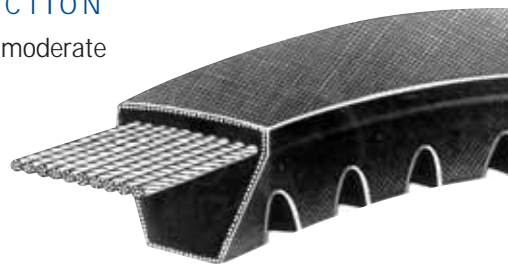

HEX BELTS - AA, BB SECTIONS

Hex Belts, or Double V-belts, are designed for use on drives with one or more reverse bends and usually transmit power from both sides of the belt. Belts are static-conducting and built with Compass® cord construction.

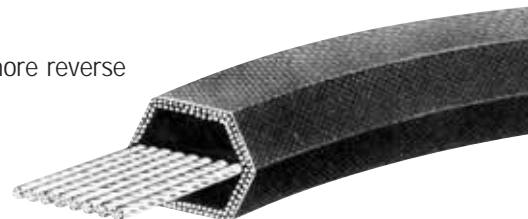

Insta-Power® Green Seal Belts

For Lawn and Garden Equipment and Other Demanding Power Drive Applications

BUILT FOR STRENGTH AND ENDURANCE

Every element of the Insta-Power® V-belt is designed to deliver premium, long-life performance in demanding outdoor power equipment service. They are engineered to withstand the abuse of repeated sudden shock loads, tolerate high ambient temperatures, and resist the damaging effects of dust.

- High horsepower (Up to 20 Hp)
- Reverse bend idlers
- Misaligned or quarter-turn and mule drives
- Sudden shock loads
- High ambient temperatures
- Exposure to dust

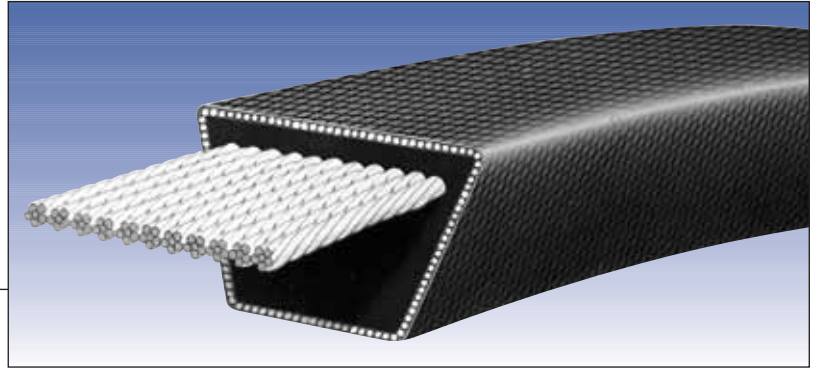

1. WEAR-RESISTANT EXTERNAL FABRIC

The fabric cover on Insta-Power® V-belts is impregnated with Goodyear Engineered Products premium synthetic rubber compound for high wear and abrasion resistance. It also resists drying and cracking, even at high temperatures.

2. CUSHION SECTION COMPOUNDED TO HANDLE HIGH STRESS

The cushion portion of the Insta-Power® V-belt is specially compounded to provide the excellent flexibility and cord support required for a wide variety of high-stress drive applications.

3. HIGH-STRENGTH TENSION MEMBERS

The load carrying tension members are high-strength Flexten® cords with proven reliability in lawn and garden equipment applications.

4. STATIC CONDUCTING FOR ADDED SAFETY

The rubber compounds used in Insta-Power® V-belts are static conducting. That means added safety for the operator and long life for the belt.

5. BRANDED WITH INSTA-POWER®, CLASSICAL AND FHP PART NUMBERS FOR MULTIPLE APPLICATIONS AND SALES OPPORTUNITIES

TYPICAL APPLICATIONS:

- Power Mowers
- Rigging Mowers and Garden Tractors
- Tillers
- Snow Throwers

Get the long-lasting power your lawn and garden equipment needs. Insist on Insta-Power® Green Seal V-belts.

Lawn and Garden Drive Belts

Goodyear Engineered Products 89 Series Drive Belts Are Designed For Original Equipment Lawn and Garden Applications.

These special drive belts supplement the Insta-Power® belt line to provide full coverage on popular lawn and garden applications. Goodyear EP's exacting quality standards provide maximum performance and belt life.



FHP V-BELTS

For Light Industrial Use, Appliances, And Shop Equipment. Up to 1 Hp.

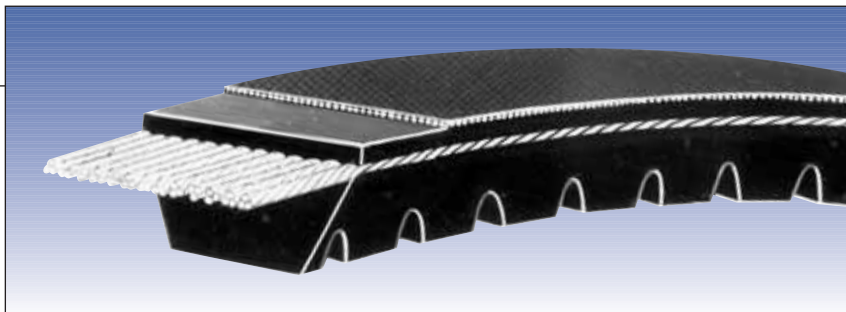

FEATURES THAT MEAN LONGER SERVICE... LOWER COSTS

FLEXIBLE - Molded-cog design for improved flexibility. This feature is especially important on small pulley drives.

ENERGY EFFICIENT - The cut-edge molded cog construction means improved drive efficiency and lower energy costs.

QUIET RUNNING - Lab tests indicate the new Goodyear EP construction is quieter running than the older envelope construction.

LONGER LIFE - The molded-cog construction also dissipates heat for improved life and performance.

COMPLETE RANGE OF SIZES - The Goodyear EP line includes a complete selection of fractional horsepower V-belts for light machinery, home appliances, shop equipment, fans and blowers.

Gatorback® Belt Tensioners

Goodyear Engineered Products heavy-duty belt tensioners meet or exceed O.E. specifications for all major fleet manufacturers.



What They Do

Automatic tensioners are typically engineered for each application so that the belt remains at nearly constant tension throughout the entire operating range. This ensures maximum accessory drive component life, while still preventing belt slip. Tensioners also help to dampen normal vibrations caused by the intermittent piston firing sequence within an engine. Our patented “noose-ring” frictional damping system helps absorb these vibrations resulting in less tensioner arm movement and belt stress. Automatic belt tensioners generally do not require service and will self-adjust for normal belt elongation. Each Gatorback® tensioner is application specific and engineered so that the belt tension, damping and amount of belt take-up are ideal for the recommended application.

Why Goodyear EP Gatorback® Tensioners?

- Designed to meet or exceed OEM fit and performance.
- Application specific.
- Increased belt life because belt maintains ideal tension as it wears.
- Constant tension is maintained throughout the entire operating range.
- Round, torsion-spring technology instead of a flat-spring due to inherent corrosion protection.

Belt Tensioner Parts and Function

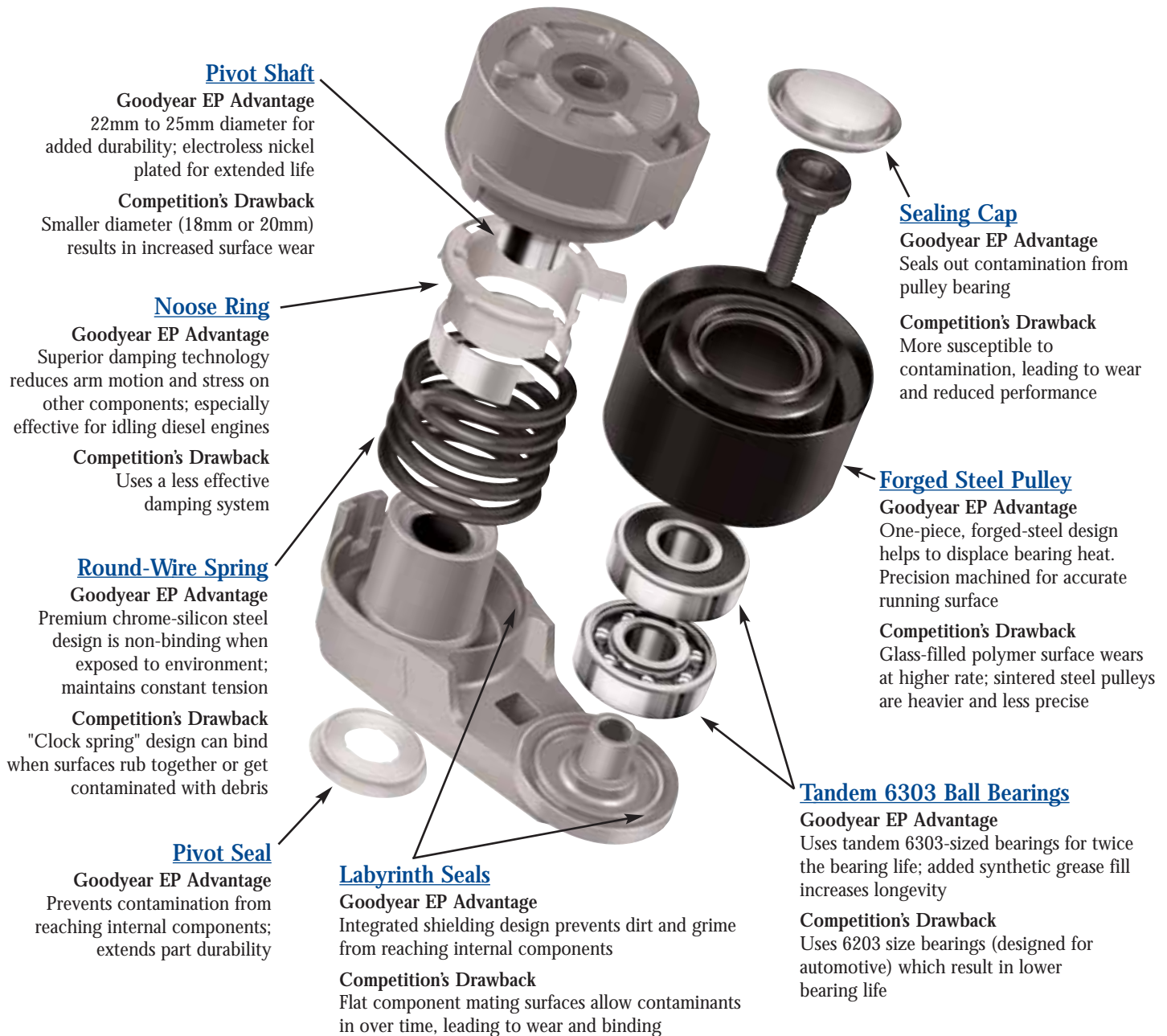

Warning

Under no circumstances should a tensioner assembly be opened to attempt repair of internal parts as the spring is powerful and preloaded and may cause serious injury. Always replace a worn tensioner assembly with a new assembly, as there are no serviceable internal parts. The only part that may be replaced is the pulley.

Hydraulic Hose Assembly Systems

THAT PERFORM

GOODYEAR EP HYDRAULIC HOSE AND FITTINGS

One **SOURCE** provides the hose and fittings that meet global performance standards including SAE, DIN, JIS, USCG and ABS.



GOODYEAR EP HYDRAULIC EQUIPMENT

One **SYSTEM** includes a broad selection of hydraulic assembly equipment.



PERMA-CRIMP™ SYSTEM

One **SOLUTION** that produces a high-quality, reliable hydraulic hose assembly.

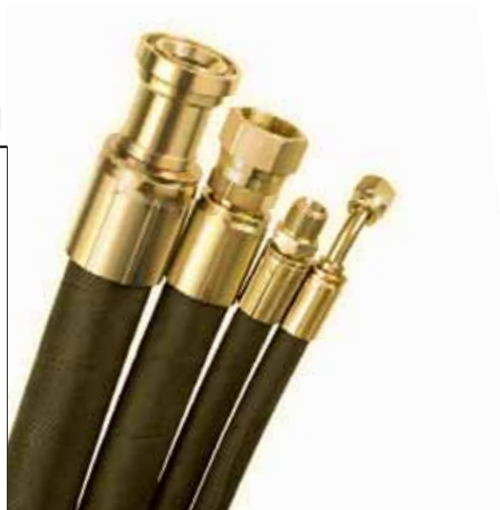

KEY FEATURES

Fleet Applications

- GR5 (SAE 100R5).
- HR5 (high temperature service).
- GUT (SAE J1402 Type A1).
- Air Conditioning Hose.



Teflon Hose

- 500° F high temperature intermittent service.
- Chemical resistance.
- Stainless steel braided cover.
- GR14A (SAE 100R14).



Braided Hose

- Higher EN / DIN pressures.
- Arctic™, Desert™, Armorcoat constructions.
- GR1SN (SAE 100R1AT/1SN), Desert HR1SN (SAE 100R1AT/1SN), GR2SN (SAE 100R2AT/2SN), Desert HR2SN (SAE 100R2AT/2SN), Arctic LR2SN (SAE 100R2AT/2SN), Armorcoat CR2SN (SAE 100R2AT/2SN), GR16 (SAE 100R16), GR16SC (SAE 100R16/857 2SC), Armorcoat AR16SC (SAE 100R16/857 2SC), GR17 (SAE100 R17), Armorcoat AR17 (SAE 100R17).
- GFS (Fire Suppression SAE 100R1AT).
- GCP3 (Constant Pressure 3000, SAE 100R17).



Goodyear Engineered Products Hydraulic Fittings

ONE SOURCE. Many Selections.

Goodyear Engineered Products is your one source for a wide selection of high-performance hydraulic hose fittings, covering a wide range of designs, configurations, sizes and pressure ratings. Low, medium and high pressure fittings are available for braided, spiral and thermoplastic hose. Fittings include Ultra-Crimp™ (1-piece), Uni-Crimp™ (2-piece), Dual-Grip™ (2-piece), Field-Grip™ (reattachable), push-on and air conditioning. Our brand line of thread ends include SAE, NPTF, JIC, British Standard, DIN and JIS. End styles include straights, swivels, elbows and flanges. Find the fittings and threads you need from one source, from Goodyear Engineered Products.

KEY FEATURES

Bite-to-Wire

These one-piece crimp fittings provide maximum coupling retention on 1 and 2-braid hose as well as four and six spiral hose. Serrations penetrate the cover with a powerful bite into the wire reinforcement, resulting in even hose compression.



No Skive

Assemblies made faster, with fewer steps and less mess.

Full Length Crimp

Maximum coupling retention for a safe and longer lasting assembly; easier to crimp with a lower profile.

Zinc Plating

- Offers corrosion resistance for extended hose assembly and fitting life, easily surpassing the corrosion resistance of SAE J516, ASTM B117.
- Silver Chromium 6 Free plating on Ultra-Crimp, Uni-Crimp and Dual-Grip fittings.



Full Line of High Pressure Spiral Hose Couplings

- Code 61 and Code 62 fittings for SAE 100R12 and 100R13.
- Solid one-piece flanged fitting; no braze or weld joints.



Field-Grip™ Fittings

- Non-skive, non-mandrel for easy installation.



Push-On Fittings

- Fittings compatible with push-on hose, including Insta-Grip 300™, Ultra-Grip 300™ and Insta-Grip TC™.



AC Fittings

- Cool Clip™ and Crimp fittings.



Adapters

- Change existing end styles.



MOLDED RADIATOR HOSE

Designed to transfer glycol-based coolants to and from the radiator as well as through other components in the vehicle's coolant system.

- Original configurations available to assure proper fit. See the automotive and heavy-duty truck applications guides for application and part number assistance. Or visit goodyear.com.
- EPDM tube and cover with synthetic knit reinforcement.
- Meets or exceeds SAE 20R4EC Class D1 specifications as well as many original equipment specifications.
- Resistant to Electrochemical Degradation (ECR).
- Compatible with most coolants including ethylene glycol and propylene glycol-based coolants, as well as organic acid modified, Long Life coolants.
- ID Range of 1" to 3" and includes intersect hose configurations.
- Temperature range of -40°F to +275°F (-40°C to +135°C).
- Not for use in fuel or oil transfer applications.

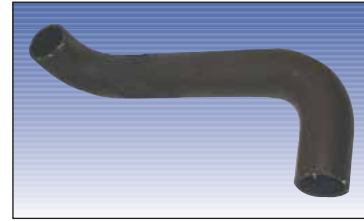

MOLDED BY-PASS AND HEATER HOSE

Designed to transfer glycol-based coolants to and from the heater core, by-pass to the radiator, as well as through other components in the vehicle's coolant system.

- Original configurations available to assure proper fit. See the automotive and heavy-duty truck applications guides for application and part number assistance. Or visit goodyear.com.
- EPDM tube and cover with synthetic knit reinforcement.
- Meets or exceeds SAE 20R3EC Class D1 and Class D2 specifications as well as many original equipment specifications.
- Resistant to Electrochemical Degradation (ECR).
- Compatible with most coolants including ethylene glycol and propylene glycol-based coolants, as well as organic acid modified, Long Life coolants.
- ID Range of 1/4" to 1 3/8" and includes intersect hose configurations.
- Temperature range of -40°F to +275°F (-40°C to +135°C).
- Not for use in fuel or oil transfer applications.



INVENTORY-REDUCING UNIVERSAL HEATER HOSE

It's almost impossible to stock all the sizes and shapes of molded heater hose that are installed in today's trucks. The number is staggering, and so are the inventory headaches. Goodyear Engineered Products makes it easy (and profitable) for you to minimize the headaches with its new line of universal heater hose. You simply select two shapes that match the original hose, join them together, and you've got a hose that's as good as the original... or better!

HOSE CONNECTORS

64092-5/8" 64093-3/4" 64094-3/4"x 5/8"

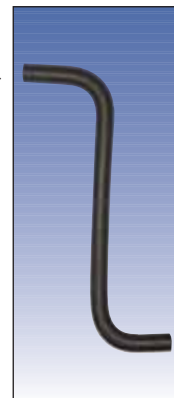

OE Configuration

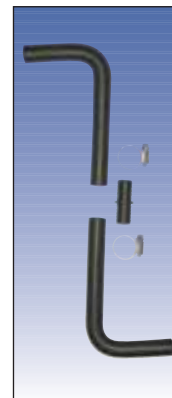

Kit Parts



Assembled Kit

Super Hi-Miler® Blue Hose Kits

High-Performance Blue Hose

Application: High-performance Super Hi-Miler® kits can be installed on the applications shown below. Kits include a variety of upper and lower radiator hoses, by-pass hoses and heater hoses. Blue Super Hi-Miler® is a high-heat resistant hose designed to provide superior performance over standard coolant hoses. Blue hose gives a custom look under the hood while providing miles of worry-free service.

Construction

Tube: Black EPDM (Versigard)
Reinforcement: Nomex Reinforcement
Cover: Blue EPDM (Versigard)

300°F Hi Temp Rating	Nomex Reinforcement	Uses Standard Clamps
-----------------------------------	-------------------------------	-----------------------------------



Temperature Range F & C: -40°F to +300°F (-40°C to +150°C)

SAE Specifications: SAE 20R3 Class D3, SAE 20R4 Class D3

Installation: See selection of Goodyear Engineered Products clamps and connectors

Warning: Do not use for fuel or oil transfer applications.

Kit# 5001

Part Number	Description
61037HT	Upper Radiator Hose
61296HT	Lower Radiator Hose
63726HT	By-Pass Hose
63087HT	Formed Heater Hose
63137HT	Formed Heater Hose
63138HT	Formed Heater Hose

Application: Ford Mustang, 5.0L 1986-1993

Kit# 5002

Part Number	Description
61331HT	Upper Radiator Hose w/TPI
61564HT	Upper Radiator Hose w/o TPI
61196HT	Lower Radiator Hose
63075HT	Formed Heater Hose
63083HT	Formed Heater Hose
63085HT (2Pcs)	Formed Heater Hose
5/8"x6'	Straight Heater Hose
3/4"x4'	Straight Heater Hose

Application: Chevrolet Camaro & Pontiac Firebird, 5.0L / 5.7L 1987-92

Kit# 5003

Part Number	Description
61460HT	Upper Radiator Hose
61105HT	Lower Radiator Hose
63726HT	By-Pass Hose
63100HT	Formed Heater Hose
63101HT	Formed Heater Hose
63137HT	Formed Heater Hose
63812HT	Formed Heater Hose
5/8"x3' (2Pcs)	Straight Heater Hose
5/8"x4'	Straight Heater Hose
3/8"x3'	Straight Heater Hose

Application: Ford F-Series & Bronco, 5.0L, 5.8L 1988-94

Kit# 5004

Part Number	Description
61564HT	Upper Radiator Hose
61274HT	Lower Radiator Hose
5/8" x 4'	Straight Heater Hose
3/4"x6'	Straight Heater Hose
3/4"x3'	Straight Heater Hose

Application: Chevrolet & GMC C & K series truck 5.0L, 5.7L 1984-1987

Kit# 5005

Part Number	Description
61548HT	Upper Radiator Hose
62021HT	Lower Radiator Hose
63726HT	By-Pass Hose
63122HT	Formed Heater Hose
63818HT	Formed Heater Hose
63100HT	Formed Heater Hose
63086HT	Formed Heater Hose
5/8"x4'	Straight Heater Hose

Application: Chevrolet & GMC C & K-series truck, 5.0L, 5.7L 1988-1995

Kit# 5006

Part Number	Description
61351HT	Upper Radiator Hose
62077HT	Lower Radiator Hose
63492HT	Formed Heater Hose
63301HT	Formed Heater Hose
63101HT	Formed Heater Hose
63496HT	Formed Heater Hose
63906HT	Formed Heater Hose
63806HT	Formed Heater Hose
63490HT	Formed Heater Hose
63491HT	Formed Heater Hose
5/8"x1'	Straight Heater Hose

Application: Chevrolet Camaro & Pontiac Firebird, 5.7L 1995-1997

Kit# 5007

Part Number	Description
62223HT	Upper Radiator Hose
62052HT	Lower Radiator Hose
63494HT	Formed Heater Hose
63495HT	Formed Heater Hose
63496HT	Formed Heater Hose
63819HT (2Pcs)	Formed Heater Hose
3/8"x5'	Straight Heater Hose

Application: Chevrolet Impala SS, 5.7L 1994-1996

Kit# 5008

Part Number	Description
61491HT	Upper Radiator Hose
61349HT	Lower Radiator Hose
61572HT	Lower w/Performance Pkg
63251HT	Formed Heater Hose
63100HT	Formed Heater Hose
5/8"x2'	Straight Heater Hose
3/4"x2-1/2'	Straight Heater Hose

Application: Chevrolet Corvette, 5.7L 1985-1989 (will not fit ZR-1)

Kit# 5009

Part Number	Description
61613HT	Upper Radiator Hose
61417HT	Lower Radiator Hose
63174HT	Formed Heater Hose
63175HT	Formed Heater Hose
5/8"x1'	Straight Heater Hose

Application: Ford Ranger, 4.0L 1990-1994

Kit# 5010

Part Number	Description
61503HT	Upper Radiator Hose (VIN W Eng)
62041HT	Upper Radiator Hose (VIN Z Eng)
61502HT	Lower Radiator Hose
63105HT	Formed Heater Hose
63223HT	Formed Heater Hose
5/8"x3'	Straight Heater Hose
3/4"x6'	Straight Heater Hose

Application: Chevrolet & GMC S-10 & S-15 4.3L 1988-1995

Kit# 5011

Part Number	Description
61564HT	Upper Radiator Hose
61196HT	Lower Radiator Hose
63100HT	By-Pass Hose
65032 (5/8"x3')	Straight Heater Hose
65034 (3/4"x3-1/2')	Straight Heater Hose

Application: Chevrolet Monte Carlo SS 5.0L 1982-88 & Pontiac Grand Prix 5.0L 1983-1987

Kit# 5012

Part Number	Description
62149HT	Upper Radiator Hose
62150HT	Lower Radiator Hose
63726HT	By-Pass Hose
63497HT	Formed Heater Hose
63498HT	Formed Heater Hose
63912HT	Formed Heater Hose

Application: Ford Mustang 5.0L 1994-1995 (Except COBRA)

Kit# 5013

Part Number	Description
60686HT	Upper Radiator Hose
60620HT	Lower Radiator Hose
63641HT	By-Pass Hose (Early 302)
63726HT	By-Pass Hose (Late 302 & All 351)

65032 (5/8"x4')(2Pcs) Straight Heater Hose(2Pcs)
Application: Ford Mustang 289, 302 & 351 V-8 Engine 1964-1969

Kit# 5014

Part Number	Description
61037HT	Upper Radiator Hose
61296HT	Lower Radiator Hose
63726HT	By-Pass Hose
63087HT	Formed Heater Hose
65032 (5/8"x4')	Straight Heater Hose

Application: Ford Mustang 5.0L 1979-1985

Kit# 5016

Part Number	Description
62110HT	Upper Radiator Hose
62187HT	Lower Radiator Hose
63350HT	Formed Heater Hose
63351HT	Formed Heater Hose

Application: Ford Mustang 4.6L 1996-2001

Kit# 5017

Part Number	Description
62312HT	Upper Radiator Hose
62313HT	Lower Radiator Hose
63352HT	Formed Heater Hose
63353HT	Formed Heater Hose

Application: Chrysler PT Cruiser 2.4L 2001-2005

Kit# 5018

Part Number	Description
62379HT	Upper Radiator Hose
62313HT	Lower Radiator Hose
63352HT	Formed Heater Hose
63353HT	Formed Heater Hose

Application: Chrysler PT Cruiser 2.4L Turbo 2004-2005

Kit# 5019

Part Number	Description
62380HT	Upper Radiator Hose
62381HT	Lower Radiator Hose
63965HT	Formed Heater Hose
63966HT	Formed Heater Hose

Application: Dodge SRT-4 2.4L 2003-2005

Flexible Radiator Hose

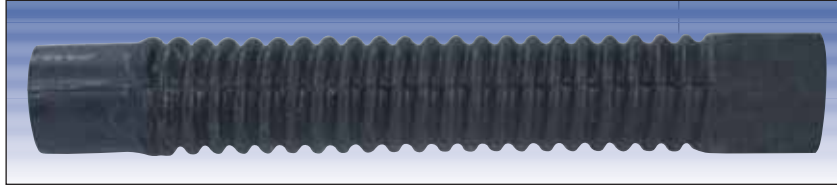

Application: Designed for radiator hose applications where a molded radiator hose is not available. Flexible radiator hose has a corrugated cover that easily bends to replicate the original equipment coolant hose. Flexible radiator hose maintains full flow and resists collapse with a wire insert. Hose is designed to be used with automotive coolants.

Construction

Tube: Black Versigard (EPDM)

Reinforcement: Synthetic Knit Reinforcement

Cover: Black Versigard (EPDM)

Temperature Range F & C: -40°F to +257°F (-40°C to +125°C)

SAE Specifications: SAE J20R5 D1

Working Pressure: 40 PSI (1 1/4" to 1 3/4" ID) to 30 PSI (2" to 2 1/2" ID)

Installation: See selection of Goodyear Engineered Products clamps and connectors

Warning: Do not use for fuel or oil transfer applications.

Part Number	Flex Hose Size	Part Number	Flex Hose Size	Part Number	Flex Hose Size
52007	1 1/4" x 7 3/8"	52418	1 1/2" x 16 5/16" x 1 3/4"	52823	1 3/4" x 23 1/2"
52010	1 1/4" x 9 5/8"	52419	1 1/2" x 19 13/16"	53209	2" x 9 1/2"
52011	1 1/4" x 11"	52420	1 1/2" x 19 1/2" x 1 3/4"	53212	2" x 12 1/4"
52015	1 1/4" x 14 3/4"	52422	1 1/2" x 22"	53214	2" x 14 1/4"
52016	1 1/4" x 15 1/2" x 1 1/2"	52423	1 1/2" x 22 1/2" x 1 3/4"	53216	2" x 16 13/16"
52017	1 1/4" x 17"	52425	1 1/2" x 25"	53220	2" x 20"
52020	1 1/4" x 19 9/16" x 1 1/2"	52430	1 1/2" x 30"	53224	2" x 24"
52021	1 1/4" x 20"	52808	1 3/4" x 8 5/8"	53609	2 1/4" x 9"
52023	1 1/4" x 23"	52810	1 3/4" x 10"	53611	2 1/4" x 11"
52407	1 1/2" x 7 9/16"	52811	1 3/4" x 11 3/16"	53614	2 1/4" x 14"
52409	1 1/2" x 9"	52812	1 3/4" x 12 1/4" x 2"	53617	2 1/4" x 17"
52410	1 1/2" x 10 11/16"	52813	1 3/4" x 13 1/4"	53619	2 1/4" x 19"
52412	1 1/2" x 12 3/16"	52814	1 3/4" x 14 1/4" x 2"	54016	2 1/2" x 16"
52413	1 1/2" x 13 3/4"	52816	1 3/4" x 16 5/16"	54024	2 1/2" x 24"
52414	1 1/2" x 13 1/4" x 1 3/4"	52817	1 3/4" x 16 11/16" x 2"	55090	90 Degree 3x16 7/8" x 1 1/2" ID
52415	1 1/2" x 15 3/4"	52818	1 3/4" x 18 13/16"	55091	90 Degree 3x22 7/8" x 1 1/2" ID
52416	1 1/2" x 17 1/16"	52819	1 3/4" x 19" x 2"	55092	90 Degree 3x20 1/2" x 1 1/2" ID
52417	1 1/2" x 15 5/8" x 1 3/4"				

RADIATOR HOSE REDUCERS



Rubber reducers that are inserted into the inside of a radiator hose to reduce the ID of the hose for a proper fit to the connection. Flange of reducer will prevent slippage into hose. Use standard worm gear clamps for a leak free connection. Makes any stock hose into a "Dual ID" hose. Packaged in a box of 6 pieces.

REDUCERS FOR STRAIGHT/FLEXIBLE RADIATOR HOSE

Part No.	Fits into Hose ID(in.)	ID Reduction(in.)
58981	1 1/2"	1 1/4"
58982	1 3/4"	1 1/2"
58983	2"	1 3/4"
58984	2 1/4"	2"
58985	2 1/2"	2 1/4"
58986	3"	2 1/2"

Hi-Miler® Straight Radiator Hose



Application: Designed for heavy-duty and fleet service on trucks, buses and off-road equipment. Designed for common coolants and straight radiator connections where higher heat resistance and longer life is desired.

Construction

Tube: Black Versigard (EPDM)
Reinforcement: 2-ply Flexten (Kevlar)
Cover: Blue Versigard (EPDM) wrapped finish

300°F
Hi Temp
Rating

Flexten
Reinforcement

Uses
Standard
Clamps

Temperature Range F & C: -40°F to +300°F (-40°C to +149°C)

SAE Specifications: SAE 20R1 D1 Standard Wall

Goodyear Engineered Products Specifications: 542954,541954

Length: 3 feet

Brand Layline: Goodyear HI-MILER® Std Rad Hose, ID, P/N, Flexten, SAE 20R1 D1.

Installation: See selection of Goodyear EP clamps and connectors

Warning: Do not use for fuel or oil transfer applications.

Part Number	ID(in.)	OD(in.)	Length(ft.)	Working Pressure(PSI)	Weight (lbs./ft.)
57214	7/8	1 15/16	3	150	0.32
57216	1	1 23/64	3	150	0.36
57218	1 1/8	1 1/2	3	150	0.40
57220	1 1/4	1 5/8	3	150	0.44
57222	1 3/8	1 47/64	3	150	0.47
57224	1 1/2	1 55/64	3	150	0.51
57226	1 5/8	2	3	150	0.55
57228	1 3/4	2 9/64	3	150	0.59
57230	1 7/8	2 1/4	3	150	0.63
57232	2	2 3/8	3	150	0.66
57234	2 1/8	2 1/2	3	125	0.70
57236	2 1/4	2 5/8	3	125	0.74
57238	2 3/8	2 3/4	3	125	0.78
57240	2 1/2	2 7/8	3	125	0.81
57242	2 5/8	3	3	125	0.85
57244	2 3/4	3 1/8	3	125	0.89
57246	2 7/8	3 1/4	3	125	0.93
57248	3	3 23/64	3	125	0.96
57252	3 1/4	3 41/64	3	125	1.04
57256	3 1/2	3 29/32	3	125	1.12
57260	3 3/4	4 9/64	3	125	1.19
57264	4	4 3/8	3	100	1.27
57272	4 1/2	4 7/8	3	75	1.42
57280	5	5 3/8	3	75	1.57



For hose reducers see page 20.



For clamps and connectors see pages 46 - 47.

Heavy-Duty Straight Radiator Hose



Application: Designed with an extra heavy carcass to be used for automotive coolants and straight connections under severe conditions most likely seen with construction and off-road vehicle applications.

Construction

Tube: Black Versigard (EPDM)

Reinforcement: 4-ply synthetic

Cover: Black Versigard (EPDM) wrapped finish

Temperature Range F & C: -40°F to +260°F (-40°C to +125°C)

SAE Specifications: SAE 20R1 D1

Goodyear Engineered Products Specifications: 542957

Length: 3 feet

Brand Layline: Goodyear HD Rad Hose, ID, P/N, SAE 20R1 D1.

Installation: See selection of Goodyear EP clamps and connectors

Warning: Do not use for fuel or oil transfer applications.

Part Number	ID(in.)	OD(in.)	Length(ft.)	Working Pressure(PSI)	Weight(lbs./ft.)
57016	1	1 33/64	3	150	0.53
57018	1 1/8	1 21/32	3	150	0.59
57020	1 1/4	1 25/64	3	150	0.64
57024	1 1/2	2 1/64	3	150	0.74
57028	1 3/4	2 19/64	3	150	0.86
57032	2	2 17/32	3	150	0.96
57036	2 1/4	2 25/32	3	100	1.06
57040	2 1/2	3 1/32	3	100	1.16
57044	2 3/4	3 9/32	3	100	1.27
57048	3	3 33/64	3	100	1.37
57056	3 1/2	4 1/16	3	100	1.60



For hose reducers see page 20.



For clamps and connectors see pages 46 - 47.

Standard Straight Radiator Hose



Application: Designed for common coolants and straight, coolant connections in automotive and industrial applications.

Construction

Tube: Black Versigard (EPDM)

Reinforcement: 2-ply synthetic

Cover: Black Versigard (EPDM) wrapped finish

Temperature Range F & C: -40°F to +260°F (-40°C to +125°C)

SAE Specifications: SAE 20R1 D1 Standard Wall

Goodyear Engineered Products Specifications: 542956

Length: 3 feet

Brand Layline: Goodyear Std Rad Hose, ID, P/N, SAE 20R1 D1.

Installation: See selection of Goodyear EP clamps and connectors

Warning: Do not use for fuel or oil transfer applications.

Part Number	ID(in.)	OD(in.)	Length(ft.)	Working Pressure(PSI)	Weight(lbs./ft.)
56008	1/2	57/64	3	150	0.22
56012	3/4	1 1/8	3	150	0.29
56014	7/8	1 1/4	3	150	0.33
56016	1	1 3/8	3	150	0.37
56018	1 1/8	1 33/64	3	150	0.41
56020	1 1/4	1 41/64	3	150	0.45
56021	1 5/16	1 45/64	3	150	0.47
56022	1 3/8	1 3/4	3	150	0.48
56024	1 1/2	1 7/8	3	150	0.52
56026	1 5/8	2 1/64	3	150	0.56
56028	1 3/4	2 5/32	3	150	0.61
56030	1 7/8	2 17/64	3	150	0.64
56032	2	2 25/64	3	150	0.68
56034	2 1/8	2 17/32	3	100	0.72
56036	2 1/4	2 41/64	3	100	0.76
56038	2 3/8	2 49/64	3	100	0.80
56040	2 1/2	2 57/64	3	75	0.83
56042	2 5/8	3 1/32	3	75	0.88
56044	2 3/4	3 9/64	3	75	0.91
56046	2 7/8	3 17/64	3	75	0.95
56048	3	3-3/8	3	50	0.99
56052	3 1/4	3 21/32	3	50	1.07
56056	3 1/2	3 59/64	3	50	1.15
56060	3 3/4	4 5/32	3	50	1.22
56064	4	4 13/32	3	50	1.30



For hose reducers
see page 20.



For clamps and connectors
see pages 46 - 47.

Wire-Reinforced Radiator Hose



Application: Designed with enhanced flexibility in “straight” coolant connection applications. A helical steel wire prevents hose collapse under vacuum situations.

Construction

Tube: Black Versigard (EPDM)

Reinforcement: 2-ply synthetic with helix wire

Cover: Black Versigard (EPDM) wrapped finish

Temperature Range F & C: -40°F to +260°F (-40°C to +125°C)

SAE Specifications: SAE J20 R2 D1

Goodyear Engineered Products Specifications: 542988 542989

Length: See table below.

Brand Layline: Goodyear HI-MILER® Wire Inserted, SAE 20R2 D1, P/N, ID.

Installation: See selection of Goodyear EP clamps and connectors

Warning: Do not use for fuel or oil transfer applications.

Part Number	ID(in.)	OD(in.)	Length(ft.)	Working Pressure(PSI)	Min Bend Radius(in.)	Vacuum HG(in.)	Weight (lbs./ft.)
58108	1/2	61/64	10	100	1.5	25	0.31
58110	5/8	1 1/16	10	100	1.8	25	0.34
58112	3/4	1 3/16	10	100	2.3	25	0.39
58016	1	1 7/16	4	100	3.0	25	0.51
58018	1 1/8	1 37/64	4	100	3.4	25	0.57
58020	1 1/4	1 45/64	4	100	3.8	25	0.62
58024	1 1/2	1 15/16	4	100	4.5	25	0.73
58028	1 3/4	2 7/32	4	100	5.3	25	0.87
58032	2	2 29/64	4	100	6.0	25	0.97
58036	2 1/4	2 45/64	4	75	6.8	25	1.08
58040	2 1/2	2 61/64	4	75	7.5	25	1.22
58044	2 3/4	3 13/64	4	75	8.0	25	1.34
58048	3	3 7/16	4	50	9.0	25	1.44



For hose reducers see page 20.



For clamps and connectors see pages 46 - 47.

Hi-Miler® Blue Heater Hose



Application: Designed for heater hose applications that endure higher underhood temperatures and require a higher heat resistance.

Construction

Tube: Black Versigard (EPDM)
Reinforcement: 2-Spiral Flexten (Aramid)
Cover: Blue Versigard (EPDM)

300°F
Hi Temp Rating

Flexten
Reinforcement

Uses Standard Clamps

Temperature Range F & C: -40°F to +300°F (-40°C to +149°C)

SAE Specifications: SAE 20R3 Class D3 HT EC

Goodyear Engineered Products Specifications: 580015

Length: See table below. 6' (bag), 50' (carton), 250' (reel)

Brand Layline: HI-MILER® Heater Hose 5/8" (15.9MM) SAE J20R3-HT-D3-EC Made in USA Goodyear.

Installation: See selection of Goodyear EP clamps and connectors, and Goodyear EP's E-Z Coil™

WARNING: Do not use for fuel or oil transfer applications.

Part Number	ID(in.)	OD(in.)	Length(ft.)	Burst Pressure (PSI)	Weight (lbs./ft.)
65027	5/16	0.59	50	250	0.11
65028	3/8	0.69	50	250	0.15
65029	1/2	0.81	50	250	0.17
65030	1/2	0.81	250	250	0.17
65073	1/2	0.81	6	250	0.17
65031	5/8	0.94	50	250	0.21
65032	5/8	0.94	250	250	0.21
65074	5/8	0.94	6	250	0.21
65033	3/4	1.07	50	200	0.24
65034	3/4	1.07	250	200	0.24
65075	3/4	1.07	6	200	0.24
65035	1	1.34	50	175	0.36
65036	1	1.34	250	175	0.36
65037	1 1/4	1.65	50	175	0.50
65038	1 1/4	1.65	100	175	0.50



For clamps and connectors see pages 46 - 47.



See Goodyear EP's E-Z Coil™ on page 28.

Hy-T[®] Red Heater Hose



Application: Designed for heater hose applications with resistance to high underhood temperatures.

Construction

Tube: Black Versigard (EPDM)

Reinforcement: 2-Spiral Synthetic

Cover: Red Versigard (EPDM)

Temperature Range F & C: -40°F to +257°F (-40°C to +125°C)

SAE Specifications: Similar to SAE J20R3

Goodyear Engineered Products Specifications: 580002

Length: See table below. 6' (bag), 50' (carton), 250' (reel)

Brand Layline: Hy-T[®] Heater Hose 5/8" (15.9mm) SAE J20R3

Made in USA by Goodyear Engineered Products.

Installation: See selection of Goodyear EP clamps and connectors, and Goodyear EP's E-Z Coil™

WARNING: Do not use for fuel or oil transfer applications.

Part Number	ID(in.)	OD(in.)	Length(ft.)	Burst Pressure(PSI)	Weight (lbs./ft.)
65015	5/16	0.63	50	250	0.15
65017	3/8	0.69	50	250	0.16
65070	1/2	0.81	6	250	0.19
65020	1/2	0.81	50	250	0.19
65019	1/2	0.81	250	250	0.19
65071	5/8	0.94	6	250	0.24
65023	5/8	0.94	50	250	0.24
65025	5/8	0.94	250	250	0.24
65072	3/4	1.07	6	200	0.27
65026	3/4	1.07	50	200	0.27
65021	3/4	1.07	250	200	0.27



For clamps and connectors see pages 46 - 47.



See Goodyear EP's E-Z Coil™ on page 28.

Hy-T® Black Heater Hose



Application: Designed for heater hose applications where resistance to antifreeze coolants and underhood temperatures are required.

Construction

Tube: Black Versigard (EPDM)

Reinforcement: 2-Spiral Synthetic

Cover: Black Versigard (EPDM)

Temperature Range F & C: -40°F to +257°F(-40°C to +125°C)

SAE Specifications: Similar to SAEJ20R3

Goodyear Engineered Products Specifications: 580001

Length: See table below. 6' (bag), 50' (carton), 250' (reel)

Brand Layline: HY-T® Heater Hose 5/8"(15.9MM) Made in USA Goodyear.

Installation: See selection of Goodyear EP clamps and connectors, and Goodyear EP's E-Z Coil™

Warning: Do not use for fuel or oil transfer applications.

Part Number	ID(in.)	OD(in.)	Length(ft.)	Burst Pressure(PSI)	Weight (lbs./ft.)
64995	5/16	0.63	50	250	0.14
64997	3/8	0.69	50	250	0.16
65070	1/2	0.77	6	250	0.17
65000	1/2	0.77	50	250	0.17
65018	1/2	0.77	250	250	0.17
65071	5/8	0.91	6	250	0.20
65004	5/8	0.91	50	250	0.20
65005	5/8	0.91	250	250	0.20
65072	3/4	1.05	6	200	0.24
65009	3/4	1.05	50	200	0.24
65010	3/4	1.05	250	200	0.24
65012	1	1.34	50	175	0.37



For clamps and connectors see pages 46 - 47.



See Goodyear EP's E-Z Coil™ on page 28.

E-Z Coil™

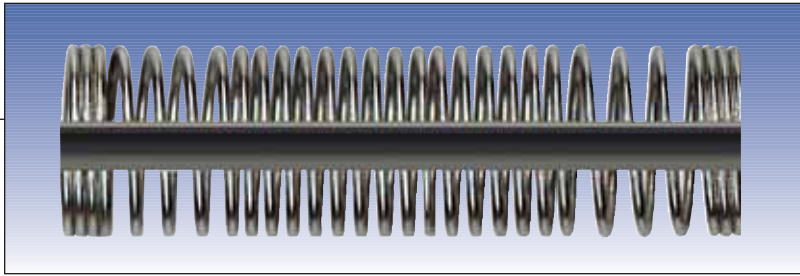

- Replaces Molded Heater Hose
- Replaces 200+ Heater Hose SKU's, with more than 26,000 applications
- For 1/2", 5/8" and 3/4" Heater Hose
- No Waiting for Parts Delivery
- Minimizes Lost Sales
- Easy Assembly and Installation
- Maintains a Consistent ID through a 90° bend



Sold at retail as individually packaged coils.

- GY12UBP 1/2" E-Z Coil
- GY58UBP 5/8" E-Z Coil
- GY34UBP 3/4" E-Z Coil



E-Z Shape

- GY120236 1/2" E-Z Coil with 36" Black Heater Hose
- GY580236 5/8" E-Z Coil with 36" Black Heater Hose
- GY340236 3/4" E-Z Coil with 36" Black Heater Hose



Display Packaging (Quantity of 12)

- GY12BX 1/2" E-Z Coil
- GY58BX 5/8" E-Z Coil
- GY34BX 3/4" E-Z Coil



Fuel Line / PCV / Emission Control Hose SAE 30R7



Application: A multipurpose fuel hose that can be used as a fuel line, PCV connection, emission control line or fuel return line.

Specific Fuel: Leaded and unleaded gasoline, diesel fuel, gasoline blends of ethanol (E-10), E85 and sour gas.

Construction

Tube: Black Chemigum (NBR)

Reinforcement: 2-Spiral Synthetic

Cover: Black Hypalon* (CSM)

Temperature Range F & C: -40°F to +257°F (-40°C to +125°C)

SAE Specifications: SAE J30R7

Goodyear Engineered Products Specifications: 580019

Length: See table below. 1.6' (clamshell), 2' (clamshell), 25' (spool), 50' (carton), 250' (reel)

Brand Layline: 5/16" (7.9mm) 50 psi Fuel/Emission SAE J30R7 Made in USA Goodyear.

Installation: See selection of Goodyear EP clamps and connectors

WARNING: Do not use for pressure lines on fuel-injected engines.

Part Number	ID(in.)	OD(in.)	Length(ft.)	Working Pressure(PSI)	Burst Pressure(PSI)	Weight (lbs./ft.)
65125	3/16	0.41	25	50	250	0.06
65122	1/4	0.50	2	50	250	0.09
65126	1/4	0.50	25	50	250	0.09
65154	1/4	0.50	250	50	250	0.09
65123	5/16	0.56	2	50	250	0.11
65127	5/16	0.56	25	50	250	0.11
65155	5/16	0.56	250	50	250	0.11
65119	11/32	0.59	1.6	50	250	0.11
65185	11/32	0.59	50	50	250	0.11
65124	3/8	0.63	2	50	250	0.12
65128	3/8	0.63	25	50	250	0.12
65156	3/8	0.63	250	50	250	0.12
65129	7/16	0.71	25	35	175	0.16
65157	7/16	0.71	250	35	175	0.16
65120	15/32	0.75	1.6	35	175	0.17
65186	15/32	0.75	50	35	175	0.17
65116	1/2	0.78	50	35	175	0.18
65121	19/32	0.91	1.6	35	175	0.24
65187	19/32	0.91	50	35	175	0.24
65117	5/8	0.94	50	35	175	0.24
65118	3/4	1.13	50	35	175	0.42



For clamps and connectors
see pages 46 - 47.

*Hypalon is registered by DuPont Dow Elastomers, LLC.

Fuel Injection Hose SAE 30R9



Application: Designed specifically for auto and truck fuel injection systems. Goodyear Engineered Products SAE 30R9 is CARB approved (C-U-06-011) with a maximum fuel permeation of 15 g/m²/day at 40°C.

Specific Fuel: Gasoline, ethanol extended gasoline, oxidized sour gas, diesel fuel, biodiesel, lubrication oil

Construction

Tube: Blue Fluoroelastomer/Nitrile

Reinforcement: Aramid Spiral

Cover: Black Hypalon* (CSM)



Temperature Range F & C: -29° to +275°F (-34° to +135°C) Intermittent use at +302°F (+150°C)

SAE Specifications: SAE J30R9

USCG Specifications: NA

Goodyear Engineered Products Specification: 599965

Length: See table below. 1.5' (clamshell), 25' (spool)

Brand Layline: Goodyear (size in inches) Fuel Injection Hose SAE J30R9 (date code) (country code) (time of manufacture)

Installation: See selection of Goodyear EP clamps

Warning: Do not submerge in gasoline

Part Number	ID(in.)	OD(in.)	Length(ft.)	Working Pressure(PSI)	Burst Pressure(PSI)	Min Bend Radius(in.)	Vacuum HG(in.)	Weight (lbs./ft.)
65148	1/4	.50	1.5	max 100	900	0.75	24	0.10
65151	1/4	.50	25	max 100	900	0.75	24	0.10
65149	5/16	.56	1.5	max 100	900	0.84	24	0.12
65152	5/16	.56	25	max 100	900	0.84	24	0.12
65150	3/8	.63	1.5	max 100	900	0.94	24	0.14
65153	3/8	.63	25	max 100	900	0.94	24	0.14
65164	1/2	.80	25	max 100	900	2.00	24	0.16



For clamps see page 47.

*Hypalon is registered by DuPont Dow Elastomers, LLC.

Fuel Fill Hose SAE 30R6



Application: Designed for auxillary gas tanks or as a connection between filler neck and tank where a slight hose bend is required.

Construction

Tube: Black Chemigum (Nitrile)

Reinforcement: Textile

Cover: Black Hypalon* (CSM)

Temperature Range F & C: -40°F to +212°F (-40°C to +100°C)

SAE Specifications: SAE J30R6

Product Specification: 538959

Installation: See selection of Goodyear EP clamps

Part Number	ID(in.)	OD(in.)	Leg Lengths(in.)	Angle	Working Pressure(PSI)
59200	1 1/2	1 7/8	8 X 8	45	20
59201	1 3/4	2 1/8	8 X 8	45	20
59202	2	2 3/8	8 X 8	45	20
59203	2 1/4	2 5/8	8 X 8	45	20
59204	2 1/2	2 7/8	8 X 8	45	20
59205	1 1/2	1 7/8	8 X 8	90	20
59206	1 3/4	2 1/8	8 X 8	90	20
59207	2	2 3/8	8 X 8	90	20
59208	2 1/4	2 5/8	8 X 8	90	20
59209	2 1/2	2 7/8	8 X 8	90	20
59210	1 1/2	1 7/8	36	Straight	20
59211	1 3/4	2 1/8	36	Straight	20
59212	2	2 3/8	36	Straight	20
59213	2 1/4	2 5/8	36	Straight	20
59214	2 1/2	2 7/8	36	Straight	20



For clamps see page 47.

*Hypalon is registered by DuPont Dow Elastomers, LLC.

Fuel Fill Hose / Marine Exhaust Hose



Application: Designed for use with gasoline, methanol, ethanol, and diesel fuel in marine applications such as fuel filler neck, fuel tank vent and exhaust hose.

Construction

Tube: Black Chemigum (Nitrile)

Reinforcement: 2-ply synthetic with helix wire

Cover: Black Chemivic (Nitrile/PVC) wrapped finish

Temperature Range F & C: -25°F to +212°F (-30°C to +100°C)

SAE Specifications: J1527 USCG Type A, Class 2, Style R2

USCG Specifications: CFR33 183 Subpart J, Fire resistance Type A

Goodyear Engineered Products Specifications: 543990 543991 543992

Length: See table below.

Brand Layline: Goodyear HI-MILER® Wire Inserted USCG Type A2 SAE J1527, P/N ID.

Installation: See selection of Goodyear EP clamps

Warning: Do not use hose reducers with this hose unless they meet the same fuel resistant specifications.

Part Number	ID(in.)	OD(in.)	Length(ft.)	Working Pressure(PSI)	Min Bend Radius(in.)	Vacuum HG(in.)	Weight (lbs./ft.)
59310	5/8	63/64	30	35	1.8	20	0.32
59312	3/4	1 7/64	30	35	2.3	20	0.37
59314	7/8	1 15/64	30	35	2.8	20	0.42
59316	1	1 11/64	30	35	3.0	20	0.47
59318	1 1/8	1 1/2	30	18	2.3	20	0.53
59320	1 1/4	1 39/64	30	18	2.8	20	0.58
58524	1 1/2	1 53/64	4	18	4.5	20	0.66
59324	1 1/2	1 27/64	30	18	4.5	20	0.69
59328	1 3/4	2 1/8	30	18	5.0	20	0.80
58530	1 7/8	2 1/4	4	18	5.5	20	0.85
59330	1 7/8	2 1/4	30	18	5.5	20	0.85
58532	2	2 3/8	4	18	6.0	20	0.90
59332	2	2 3/8	30	18	6.0	20	0.90
59034	2 1/8	2 1/2	10	18	6.3	20	0.95
58536	2 1/4	2 39/64	4	18	6.8	20	1.00
59036	2 1/4	2 39/64	10	18	6.8	20	1.00
59038	2 3/8	2 3/4	10	18	7.0	20	1.05
58540	2 1/2	2 57/64	4	18	7.5	20	1.22
59040	2 1/2	2 57/64	10	18	7.5	20	1.22
59048	3	3 7/16	10	18	9.0	20	1.61
59056	3 1/2	3 63/64	10	18	10.5	20	1.94
59072	4 1/2	5 1/32	10	18	13.5	20	2.88



For clamps see page 47.

Air Brake Hose



Application: Designed for compressed air brake systems more commonly found on heavy-duty trucks.

Construction

Tube: Black Versigard (EPDM)

Reinforcement: 2-Spiral Synthetic

Cover: Black Versigard (EPDM)

Temperature Range F & C: -40°F to +200°F (-40°C to +93°C)

SAE Specifications: SAE J1402A

Goodyear Engineered Products Specifications: 580032

DOT: FMVSS-106

Length: See table below. 50' (carton), 250' (reel)

Brand Layline: DOT GY Air Brake 10mm(3/8") SAE J1402A

Warning: Federal law requires registration with the Department of Transportation for anyone producing air brake hose assemblies with swaged or crimped fittings.

Part Number	ID(in.)	OD(in.)	Length(ft.)	Working Pressure(PSI)	Weight (lbs./ft.)
9003006	3/8	0.75	50	145	0.17
9003206	3/8	0.75	250	145	0.17
9003008	1/2	0.88	50	145	0.21
9003208	1/2	0.88	250	145	0.21

Silicone Charge Air Cooler Hose

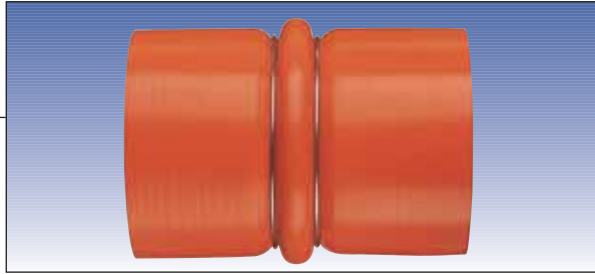

Application: Designed for connection between engine mounted charge air system components on Class 8 and heavy-duty diesel engines. Convolute, this silicone connector will handle slight misalignment between components and help to isolate vibration within the air cooler system.

Construction

4-ply Nomex reinforcement with orange silicone cover and stainless steel rings.

Temperature Range F & C: -60°F to +500°F (-51°C to +260°C)

Clamp Recommendation: T-bolt style with torque of 70-75 in-lbs.

Part Number	Inside Diameter(in.)	Outside Diameter(in.)	Length(in.)	Number of Rings	Max Operating Pressure(PSI)
57504	3.00	3.28	6.0	3	60
57512	3.50	3.73	6.0	3	55
57513	4.00	4.23	6.0	3	50
57514	4.00	4.23	8.0	3	50
57515	4.50	4.73	6.0	3	45

Clamps

51350	3" Clamp
51356	4" Clamp

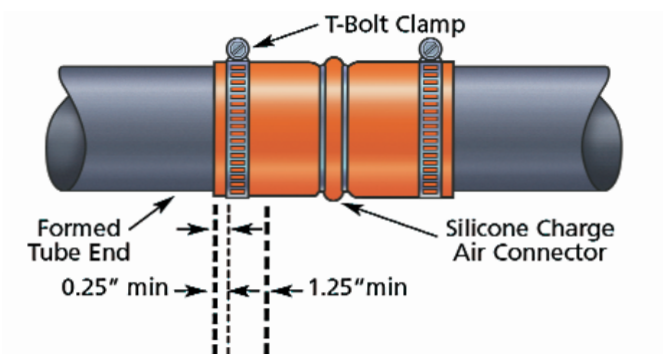

Silicone Charge Air Straight Sleeve Hose



Application: Designed for use as a short, flexible connector between the air intake and the turbocharger.

Construction

Liner: Silicone

Reinforcement: 3-Ply Woven Fiberglass Fabric

Cover: Orange Silicone

Temperature Range F & C: -60°F to +500°F (-51°C to +260°C)

Part Number	Inside Diameter(in.)	Outside Diameter(in.)	Length(in.)	Max Operating Pressure(PSI)
57402	1	1.19	36	45
57403	1 1/2	1.69	36	40
57404	2	2.19	36	35
57405	2 1/2	2.69	36	30
57448	3	3.19	36	25
57401	3 3/8	3.57	3 1/2	20
57456	3 1/2	3.69	36	20
57464	4	4.19	36	15
57406	6	6.19	36	10

Transmission Oil Cooler Hose

Application: For use in connecting add-on and external transmission oil coolers for auto and light truck.



Construction

Tube: Black Chemigum (Nitrile)
Reinforcement: 2-Spiral Synthetic
Cover: Black Hypalon* (CSM)

Temperature Range F & C: -40°F to +252°F (-40°C to +121°C)

Goodyear Engineered Products Specifications: 580018

Length: 25' (spool)

Brand Layline: Goodyear Transmission Oil Cooler Hose 3/8" (9.5mm).

Installation: See selection of Goodyear EP clamps

Part Number	ID(in.)	OD(in.)	Length(ft.)	Working Pressure(PSI)	Burst Pressure(PSI)	Weight (lbs./ft.)
65211	5/16	.62	25	250	1000	0.14
65213	3/8	.69	25	250	1000	0.16
65214	1/2	.87	25	250	1000	0.25

Power Steering Return-Side Hose

Application: Designed for use as on the return side of automotive and truck power steering systems where resistance to power steering fluid is critical.



Construction

Tube: Black Wingprene (CR)
Reinforcement: 2-Spiral Synthetic
Cover: Black Wingprene (CR)

Temperature Range F & C: -40°F to +250°F (-40°C to +121°C)

SAE Specifications: SAE J189

Goodyear Engineered Products Specifications: 580007

Length: 25' (carton)

Brand Layline: 3/8" (9.5mm) SAE J189 Goodyear.

Installation: See selection of Goodyear EP clamps

Part Number	ID(in.)	OD(in.)	Length(ft.)	Working Pressure(PSI)	Burst Pressure(PSI)	Weight (lbs./ft.)
65221	3/8	0.66	25	250	1000	0.13



For clamps see page 47.

*Hypalon is registered by DuPont Dow Elastomers, LLC.

Power Brake Vacuum Hose - Heavy Wall

Application: A heavy wall construction power brake vacuum hose designed to fit most brake systems on trucks, trailers and construction equipment with resistance to collapsing or deforming.

Construction

Tube: Black Versigard (EPDM)
Reinforcement: 2-Spiral Synthetic
Cover: Black Versigard (EPDM)

Temperature Range F & C: -40°F to +257°F (-40°C to +125°C)

SAE Specifications: SAE J1403 Type HWA

Goodyear Engineered Products Specifications: 580011

DOT: FMVSS 106VH

Length: 50' (carton)

Brand Layline: SAE J1403 DOT GY 1/2" VH

Installation: See selection of Goodyear EP clamps



Part Number	ID(in.)	OD(in.)	Length(ft.)	Burst Pressure(PSI)	Vacuum HG(in.)	Weight (lbs./ft.)
65102	3/8	0.81	50	350	26	0.33
65103	1/2	0.94	50	350	26	0.40
65105	3/4	1.19	50	350	26	0.53

Power Brake Vacuum Hose - Light Wall

Application: A light duty hose specifically designed for power brake vacuum applications on cars and light-duty trucks.

Construction

Tube: Black Versigard (EPDM)
Reinforcement: 2-Spiral Synthetic
Cover: Black Versigard (EPDM)

Temperature Range F & C: -40°F to +257°F (-40°C to +125°C)

SAE Specifications: SAE J1403 Type LWA

Goodyear Engineered Products Specifications: 580010

DOT: FMVSS 106VL

Length: 50' (carton)

Brand Layline: SAE J1403 DOT GY 11/32 VL

Installation: See selection of Goodyear EP clamps



Part Number	ID(in.)	OD(in.)	Length(ft.)	Burst Pressure(PSI)	Vacuum HG(in.)	Weight (lbs./ft.)
65107	11/32	0.69	50	350	26	0.15
65108	15/32	0.81	50	350	26	0.28



For clamps see page 47.

Windshield Wiper / Radiator Overflow Tubing



Application: Tubing for use on windshield wiper systems, windshield washer fluid tanks, wet arm wiper tubing, radiator overflow tanks, and as vacuum tubing.

Construction

Tube: EPDM

Reinforcement: No reinforcement

Cover: No cover

Temperature Range F & C: -40°F to 257°F (-40°C to +125°C)

SAE Specifications: J1037 & J942B

Goodyear Engineered Products Specifications: 580560

Length: See table below. 2.5' (clamshell), 6' (clamshell), 50' (spool)

Brand Layline: No brand

Installation: See selection of Goodyear EP clamps and connectors

Part Number	ID(in.)	Nipple Size(in.)	Length(ft.)	Working Pressure(PSI)	Weight (lbs./ft.)
65109	3/32	1/16	50	50	0.01
65192	7/64	1/8	6	50	0.02
65113	7/64	1/8	50	50	0.02
65115	5/32	3/16	6	50	0.04
65111	5/32	3/16	50	50	0.04
65193	7/32	1/4	6	50	0.04
65112	7/32	1/4	50	50	0.04
65130	1/4	9/32	50	50	0.05
65114	9/32	5/16	50	50	0.05
65099	5/16	3/8	2.5	50	0.04
65106	5/16	3/8	50	50	0.04
65100	3/8	7/16	2.5	50	0.06
65101	3/8	7/16	50	50	0.06



For clamps and connectors
see pages 46 - 47.

Flexsteel® Service Station Air Hose



Application: For tire inflation service from towers, reels or curb connections.

Construction

Tube: Black Nitrile (RMA Class B Oil Resistance)

Reinforcement: 1-Braid Steel

Cover: Red Nitrile (RMA Class B Oil Resistance)

Temperature Range F & C: -20°F to +190°F (-29°C to +88°C)

Goodyear Engineered Products Specifications: 539078

Length: See table below. 25' (carton), 50' (carton)

Brand Layline: Goodyear 1/4" Flexsteel® Service Station Air Made in USA Goodyear.

Warning: Do not use for oil, grease or fuel transfer.

Part Number	ID(in.)	OD(in.)	Coupling	Length(ft.)	Working Pressure(PSI)	Weight (lbs./ft.)
65143	1/4	0.61	1/4-18NPT	25	250	0.17
65145	1/4	0.61	1/4-18NPT	50	250	0.17
65144	3/8	0.72	1/4-18NPT	25	250	0.23
65146	3/8	0.72	1/4-18NPT	50	250	0.23

Service Station Air Hose

Application: A general purpose air hose available as a coupled assembly or uncoupled for use on towers, reels or curb service.



Construction

Tube: Black Versigard

(EPDM - RMA Class C Oil Resistance)

Reinforcement: 4-Spiral Synthetic

Cover: Blue Versigard (EPDM - RMA Class C Oil Resistance)

Temperature Range F & C: -40°F to +190°F (-40°C to +88°C)

Goodyear Engineered Products Specifications: 569046

Length: See table below. 25' (coil), 50' (coil), 300' (reel)

Brand Layline: 1/2" (12.7mm) Service Station Air Made in USA Goodyear

Part Number	ID(in.)	OD(in.)	Coupling	Length(ft.)	Working Pressure(PSI)	Weight (lbs./ft.)
65131	1/4	0.59	1/4-18NPT	25	250	0.16
65135	1/4	0.59	1/4-18NPT	50	250	0.16
65139	1/4	0.59	uncoupled	300	250	0.16
65133	3/8	0.71	1/4-18NPT	25	250	0.21
65137	3/8	0.71	1/4-18NPT	50	250	0.21
65141	3/8	0.71	uncoupled	300	250	0.21
65134	1/2	0.87	1/2-14NPT	25	250	0.26
65138	1/2	0.87	1/2-14NPT	50	250	0.26

Pliovic® PVC Air Hose

Application: A lightweight, economical, PVC hose for air, water and many spray solutions. Nonconductive with minimum electrical resistance greater than one megaohm per inch of hose length at 1000 volts DC.



Construction

Tube: Black PVC (RMA Class B Oil Resistance)

Reinforcement: Spiral Synthetic

Cover: Blue PVC (RMA Class B Oil Resistance)

Temperature Range F & C: -10°F to +158°F (-23°C to +70°C)

Goodyear Engineered Products Specifications: 540031

Length: 25' (coil), 50' (coil)

Brand Layline: PVC Air Hose 3/8" (9.5mm) 250 PSI WP (1.7 MPa) Made in USA Goodyear

Warning: Do not use for oil, grease or fuel transfer.

Part Number	ID(in.)	OD(in.)	Coupling	Length(ft.)	Working Pressure(PSI)	Weight (lbs./ft.)
65172	1/4	0.50	1/4-18NPT	25	250	0.06
65174	1/4	0.50	1/4-18NPT	50	250	0.06
65173	3/8	0.66	1/4-18NPT	25	250	0.11
65175	3/8	0.66	1/4-18NPT	50	250	0.11

Signal Call Bell Hose

Application: Designed for driveway signal devices in service stations and garages.

Construction

Tube: EPDM
Reinforcement: No reinforcement
Cover: No cover

Temperature Range F & C: -40°F to +160°F (-40°C to +71°C)

Goodyear Engineered Products Specifications: 580564

Length: See table below. 50' (carton), 100' (carton)

Brand Layline: No brand

Installation: See selection of Goodyear EP clamps and connectors



Part Number	ID(in.)	OD(in.)	Length(ft.)	Weight (lbs./ft.)
65180	3/8	0.63	50	0.11
65181	3/8	0.63	100	0.11



For clamps and connectors see pages 46 - 47.

Sureline® Washdown Hose

Application: A general purpose washdown hose with crushproof garden hose fittings for car and truck service bays.

Construction

Tube: Black Versigard (EPDM - RMA Class C Oil Resistance)
Reinforcement: 4-Spiral Synthetic
Cover: Black Versigard (EPDM - RMA Class C Oil Resistance)

Temperature Range F & C: -40°F to +190°F (-40°C to +88°C)

Goodyear Engineered Products Specifications: 569049

Length: 50' (coil)

Brand Layline: Sureline® 5/8" (15.9mm) 150 PSI WP Made in USA Goodyear.

Warning: Do not use for oil, grease or fuel transfer.



Part Number	ID(in.)	OD(in.)	Coupling	Length(ft.)	Working Pressure(PSI)	Weight (lbs./ft.)
65170	5/8"	0.93	MXF	50	150	0.26

Garage Exhaust Systems: Hose and Accessories

Application: Garage exhaust hose and accessories are designed for both floor and overhead use in both small car and heavy-duty truck garages. Garage exhaust hose is designed to connect to the tailpipe and provide easy escape of the vehicle exhaust gas.

Construction

Temperature Range F & C: Up to +600°F (+316°C)

Seven easy steps to developing a complete garage exhaust system:

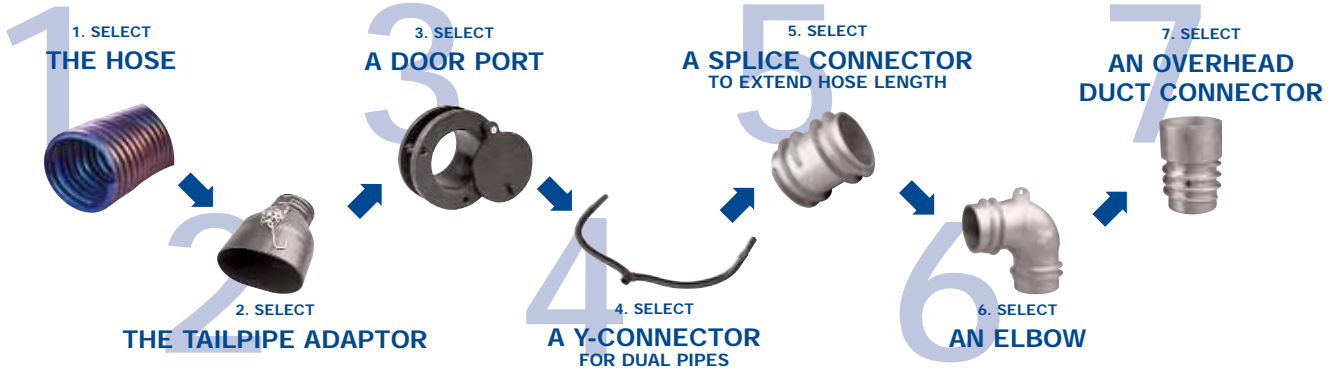

ORDER GUIDE

Develop Garage Exhaust Systems using compatible parts

Rubber Hose	ID(in.) x Length(ft.)	Tailpipe Adapter	Door Port	Y-Connector	Splice Connector	Elbows	Overhead Duct Connector
FLT 200	2 x 11	F250 Straight(11) RA300 Bell	DF25 Rubber	RY20 Rubber	SP20	EB20	NA
FLT 250	2 1/2 x 11	F250 Straight F300 Straight RA250 Bell	DF25 Rubber	RY25 Rubber	SP25 Rubber(3)	EB25 Rubber AEL25 Aluminum	NA
FLT 300	3 x 11	F250 Straight F300 Straight F350 Straight F475 3x6 Oval F575 3 1/2x8 1/2 Oval RA300 Bell	ADF30 Aluminum	RY30 Rubber	SP30 Rubber(9) AC30 Aluminum(9)	EP30 Rubber AEL30 Aluminum	OC30 Aluminum
FLT 350	3 1/2 x 11	F300 Straight F350 Straight F400 Straight	NA	NA	NA	NA	NA
FLT400	4 x 11	F350 Straight F400 Straight DSR600 Straight(20) F475 3x6 Oval F575 3 1/2x8 1/2 Oval F800 Straight	ADF40 Aluminum	AY40 Aluminum	SP40 Rubber(7) AC40 Aluminum(8)	AEL40 Aluminum	OC40 Aluminum
ACT400	4 x 11	F350 Straight F400 Straight DSR600 Straight F475 3x6 Oval F575 3 1/2x8 1/2 Oval F800 Straight	ADF40 Aluminum	AY40 Aluminum	SP40 Rubber AC40 Aluminum	AEL40 Aluminum	OC40 Aluminum
ACT500(17)	5 x 11	DSR600 Straight DSR8600 Straight	NA	NA	AC50 Aluminum(14)	AEL50 Aluminum	OC50 Aluminum OC50D AU w/damper
ACT600(6)	6 x 11	DSR600-6 Straight(7) DSR8600 Straight	NA	NA	AC60-OC Aluminum	AEL60 Aluminum	AC60-OC Aluminum

HEAVY-DUTY REPLACEMENT PRODUCTS GARAGE EXHAUST AND AIR HOSE

Rubber Hose:

(*) Indicates one flared end per length, allowing connections of two or more length of the same ID. ACT Hose is designed for use with larger gas vehicles and diesel trucks. Also available with wire insert. Always use the appropriate tailpipe adapter.

Part Number	Inside (in.)	Diameter Length(ft.)	Intended Application
FLT200*	2	11	Compact Car
54040/FLT250*	2 1/2	11	Compact Car
54048/FLT300*	3	11	Passenger Car
54064/FLT400*	4	11	Gas Truck
ACT400	4	11	Diesel Truck
ACT400 Dyno	4	11	Dyno
ACT500	5	11	Diesel Truck
ACT600	6	11	Diesel Truck



Y-Assemblies:

Designed for dual exhaust vehicles. Includes Hose, Y-Connector and Tailpipe adapter.

Assembly Part Number	Hose ID(in.) x Length(ft.)	Y-Connector	Tailpipe Adapter
YA250	2 ea 2 1/2 x 4	RY25	2 ea F250
YA300	2 ea 3 x 4	RY30	2 ea F300
YA575	2 ea 3 x4	RY30	2 ea F575
YA400	2 ea 4x4	AY40	2 ea F350



Tailpipe Adapters:

Connects hose to various types of tailpipes. Hook and Chain holds adapter in place. Adapters are designed with a 1/2" diameter clearance around the tailpipe.

Part Number	Adapter Description	Hose ID(in) Options	Tailpipe Style	Tail Pipe Size(in.)
54032/F250	Straight with hook and chain	2, 2 1/2, 3	Single	Up to 2"
F300	Straight with hook and chain	2 1/2, 3, 3 1/2	Single	Up to 2 1/2"
F350	Straight with hook and chain	3 1/2, 4	Single	Up to 3"
F350 Dyno	Straight with hook and chain	3 1/2	Single	Up to 3"
F400	Straight with hook and chain	3 1/2, 4	Single	Up to 3 1/2"
F475	Oval (3" x 6)	3, 4	Twin up to 2"	Oval 2 1/2" x 5 1/2"
F475 Dyno	Oval (3" x 6)	3, 4	Twin up to 2"	Oval 2 1/2" x 5 1/2"
F575	Oval (3 1/2" x 8 1/2)	3, 4	Twin up to 3"	Oval 3" x 8"
DSR600	Stack Adapter	4, 5	Diesel Stack	Up to 5 1/2"
DSR600-6	Stack Adapter	6	Diesel Stack	Up to 5 1/2"
F800	Stack Adapter	4	Diesel Stack	Up to 7 1/2"
DSR8600	Stack Adapter	5, 6	Diesel Stack	Up to 7 1/2"
RA250	Bell	2 1/2, 3 1/2	All	All
RA300	Bell	2, 3	All	All



HEAVY-DUTY REPLACEMENT PRODUCTS GARAGE EXHAUST AND AIR HOSE

Door Ports:

Allows hose to be vented through 1" door

Part Number	Hose ID(in.)	Material
DF25	2 1/2	Rubber
ADF30	3	Aluminum
ADF40	4	Aluminum



DF25



ADF30
ADF40

Y Fittings:

Allows for 3 hoses to be joined together

Part Number	Hose ID(in.)	Material
RY20	2	Rubber
RY25	2 1/2	Rubber
RY30	3	Rubber
AY40	4	Aluminum



RY20
RY25
RY30



AY40

Splice Connectors:

Joins two hoses together. Internal threads on rubber connector and external threads on metal connector.

Part Number	Hose ID(in.)	Material
SP20	2	Rubber
SP25	2 1/2	Rubber
SP30	3	Rubber
SP40	4	Rubber
AC30	3	Aluminum
AC40	4	Aluminum
AC50	5	Aluminum
AC60-OC	6	Aluminum



SP20
SP25
SP30
SP40



AC30
AC40
AC50
AC60-OC

Elbows:

Rubber elbows connect to underfloor exhaust systems. Aluminum elbows connect two hoses in an overhead pulley system.

Part Number	Hose ID(in.)	Material
EB20	2	Rubber
EB25	2 1/2	Rubber
EB30	3	Rubber
AEL25	2 1/2	Aluminum
AEL30	3	Aluminum
AEL40	4	Aluminum
AEL50	5	Aluminum
AEL60	6	Aluminum



EB20
EB25
EB30



AEL25
AEL30
AEL40
AEL50
AEL60

Overhead Duct Connectors:

Adapter to Overhead "T"'s

Part Number	Duct size	Material
OC30	3	Aluminum
OC40	4	Aluminum
OC50	5	Aluminum
OC50D	5 with Damper	Aluminum
AC60-OC	6	Aluminum



OC30
OC40
OC50

Multi-Purpose Air Duct



Application: Designed for connection between engine exhaust manifold and the air cleaner as a carburetor preheat duct. In addition, this durable, flexible, multi-purpose hose can be used in vehicle cabin ventilation as an air or defroster hose or an emission control hose.

Construction

Tube: Kraft Paper

Reinforcement: Aluminum

Cover: Kraft Paper

Temperature Range F & C: Max Surface Temperature +250° F (+121° C)

Length: 3' (individually packed)

Brand Layline: No Brand

Installation: Can be installed with or without worm gear clamps. Cut to size with long-bladed knife.

Part Number	Diameter (in.)	Length (in.)	Bend Radius (in.)
65912	3/4	36	1 1/8
65924	1 1/2	36	2 1/4
65928	1 3/4	36	2 5/8
65932	2	36	3

Connectors

Application: A general purpose automotive fitting for use as a fuel line connector, vacuum hose connector and for use in emission control systems.

Construction

Black 6/6 Nylon

Temperature Range F & C:

-50°F to +275°F (-45°C to 248°C)

Packaging: Sold in Bags of 5 pcs, Kit includes 2 each of parts designated in a plastic case. Kit includes plan-o-gram card with size and location of each connector.

Part Number	Description	Included in Kit 65670
65601	3/32" Y	X
65602	1/8" Y	X
65603	3/16" Y	X
65604	3/32" Straight	X
65605	1/8" Straight	X
65606	5/32" Straight	X
65607	3/16" Straight	X
65608	3/32" Elbow	X
65609	1/8" Elbow	X
65610	5/32" Elbow	X
65611	3/16" Elbow	X
65612	3/32" Tee	X
65613	1/8" Tee	X
65614	5/32" Tee	X
65615	3/16" Tee	X
65616	3/32" - 1/8" Reducer	X
65617	1/8" - 5/32" Reducer	X
65618	3/16" - 1/4" Reducer	X
65619	5/16" - 3/8" Reducer	



Part Number	Description	Included in Kit 65660
65620	1/4" Straight	X
65621	5/16" Straight	
65622	3/8" Straight	X
65623	1/2" Straight	X
65624	5/8" Straight	X
65625	3/4" Straight	X
65626	1" Straight	
65627	1/2" - 3/8" Reducer	X
65628	5/8" - 1/2" Reducer	X
65629	3/4" - 5/8" Reducer	X
65630	1" - 3/4" Reducer	
65631	1/4" Elbow	X
65632	5/16" Elbow	
65633	3/8" Elbow	X
65634	1/2" Elbow	X
65635	5/8" Elbow	X
65636	3/4" Elbow	X
65637	1" Elbow	
65638	1/4" Tee	X
65639	5/16" Tee	
65640	3/8" Tee	X
65641	1/2" Tee	X
65642	5/8" Tee	X
65643	3/4" Tee	X
65644	5/8" - 3/8" Tee	
65645	3/4" - 3/8" Tee	
65646	1" Tee	



Construction

Glass-Filled Black Nylon

Temperature Range F & C:

-50°F to +275°F (-45°C to +248°C)

Packaging: Sold in Bags of 5 pcs, Kit includes 2 each of parts designated in a plastic case. Kit includes plan-o-gram card with size and location of each connector.



Heater Hose Connector Kit.....65660
 Fuel Line/Vacuum Hose Connector Kit.... 65670

High-Performance Stainless Steel Worm Gear Clamps

Application: All Stainless for maximum corrosion resistance. Suitable for marine applications.

Construction

All 201/301 Stainless including band, housing and hex head screw

Hex Head: 5/16"

Band: 1/2"

* Miniature clamp with 1/4" hex and 5/16" band

Packaging: 10/box



Part Number	Clamp Diameter		SAE #	Hose ID	
	Min(in.)	Max(in.)		Min(in.)	Max(in.)
51302*	1/4	5/8	004	1/8	5/16
51303*	5/16	7/8	006	1/4	7/16
51306	3/8	7/8	006	5/16	3/8
51308	7/16	1	008	5/16	1/2
51310	1/2	1 1/16	010	3/8	5/8
51312	1/2	1 1/4	012	3/8	3/4
51316	11/16	1 1/2	016	3/4	7/8
51320	3/4	1 3/4	020	3/4	1 1/8
51324	1	2	024	7/8	1 3/8
51328	1 1/4	2 1/4	028	1 1/4	1 5/8
51332	1 1/2	2 1/2	032	1 1/2	1 7/8
51336	1 3/4	2 3/4	036	1 3/4	2
51340	2	3	040	2	2 1/4
51344	2 1/4	3 1/4	044	2 1/4	2 1/2
51348	2 1/2	3 1/2	048	2 1/2	2 3/4

Stainless Band Worm Gear Clamp

Construction

201/301 Stainless Band with zinc-plated carbon steel housing and hex head screw.

Hex Head: 5/16"

Band: 1/2"

* Miniature clamp with 1/4" hex and 5/16" band

Packaging: 10/box



Part Number	Clamp Diameter		SAE #	Hose ID	
	Min(in.)	Max(in.)		Min(in.)	Max(in.)
51002*	1/4	5/8	004	1/8	5/16
51003*	5/16	7/8	006	1/4	7/16
51006	3/8	7/8	006	5/16	3/8
51008	7/16	1	008	5/16	1/2
51010	1/2	1 1/16	010	3/8	5/8
51012	1/2	1 1/4	012	3/8	3/4
51016	11/16	1 1/2	016	3/4	7/8
51020	3/4	1 3/4	020	3/4	1 1/8
51024	1	2	024	7/8	1 3/8
51028	1 1/4	2 1/4	028	1 1/4	1 5/8
51032	1 1/2	2 1/2	032	1 1/2	1 7/8
51036	1 3/4	2 3/4	036	1 3/4	2
51040	2	3	040	2	2 1/4
51044	2 1/4	3 1/4	044	2 1/4	2 1/2
51048	2 1/2	3 1/2	048	2 1/2	2 3/4
51052	2 3/4	3 3/4	052	2 3/4	3
51056	3	4	056	3	3 1/2
51064	2 1/2	4 1/2	064	2 1/2	4
51072	3	5	072	3	4 1/2
51104	5	7	104	5	6 1/2

Belt Merchandiser Tools

INSTA-FIND® MEASURING GAUGE

Fast, Easy Belt Selection With The Insta-Find® Measuring Gauge

The Insta-Find® belt measuring gauge makes it easy to quickly determine the size of any belt made by Goodyear Engineered Products or any other manufacturer.

The Insta-Find® gauge measures automotive, truck, and lawn and garden belts. It's designed for top widths to one inch, and will measure circumferences up to and exceeding 100 inches.

POLY-V® BELT MEASURING CAPABILITY

A special Poly-V® groove also enables easy measurement for the growing number of Poly-V® belts used in serpentine applications.

Equally important, it's made of sturdy materials so it will stand up to the heavy usage it's sure to get.

HOW THE INSTA-FIND® GAUGE WORKS

1. Apply old belt.
2. Read belt width at bottom.
3. Read belt length on scale respective to the top width.
4. Select new belt.

Simply slip the old belt onto the gauge and pull the slide tight. The belt width is read at the bottom of the slide. The belt length is read on the bar scale. No guessing. No trial-and-error matching. Part No. 08000



Hose Merchandiser Tools

The top cabinet can be placed on a counter, fastened to a wall or attached to the lower heater hose rack. Part No. 65080: Fuel Hose and Wiper Tubing Cabinet

The top cabinet comes stenciled with part numbers for the nine most popular fuel and wiper tubing hoses. Labels are included to change these part numbers if desired.

The lower heater hose rack holds three sizes of the most popular heater hose and provides a base for Part No. 65080. Part No. 65081: Heater Hose Rack



HOSE MERCHANDISER

The Hose Merchandiser from Goodyear Engineered Products has a small footprint but delivers big benefits. It is designed to better organize and dispense fuel line hose, windshield washer tubing, fuel injection hose and heater hose. To complete the package, we also offer cutters and blade replacements.

VERSATILITY

The merchandiser consists of two parts. Depending on the layout of your shop, you can combine them to form a single, convenient freestanding merchandiser or use them separately.

The merchandiser is also sold as a package that includes the top cabinet and the lower heater hose rack, completely stocked with hose.

Part No. 65082 includes cabinet top 65080 and bottom rack 65081 with the following hose part numbers:

Black Heater Hose.....	65000	1/2" x 50'
Black Heater Hose.....	65004	5/8" x 50'
Black Heater Hose.....	65009	3/4" x 50'
Fuel Hose.....	65126	1/4" x 25' 30R7
Fuel Hose.....	65127	5/16" x 25'
Fuel Hose.....	65128	3/8" x 25'
Tubing.....	65113	7/64" x 50'
Tubing.....	65111	5/32" x 50'
Tubing.....	65112	7/32" x 50'



HOSE CUTTING TOOLS

Provide straight cuts for couplings used for synthetic spinal or braided hose.

- Superior I-Beam design
- Spring-action return with safety latch
- Stainless steel blade

Part No. 65090

2" Hose and Tubing Cutter, Cuts up to 2" hose

Part No. 65091

Replacement Blade for 65090

Part No. 65092

1-1/4" Hose and Tubing Cutter, Cuts up to 1-1/4" hose

Part No. 65093

Replacement Blade for 65092

U . S . A .

1 - 8 0 0 - 8 6 9 - 0 4 3 5
F A X 1 - 8 0 0 - 2 2 8 - 3 1 4 8

C A N A D A

1 - 8 8 8 - 2 7 5 - 4 3 9 7
F A X 1 - 8 8 8 - 4 6 4 - 4 3 9 7WWW.GODYEAREP.COM/AFTERMARKETTRUCK

The GOODYEAR (and Winged Foot Design) trademark is used by Veyance Technologies, Inc. under license from The Goodyear Tire & Rubber Company. Goodyear Engineered Products are manufactured and sourced exclusively by Veyance Technologies, Inc. or its affiliates. The following trade names are licensed to Veyance Technologies, Inc. by The Goodyear Tire & Rubber Company, including Flexsteel, Flexten, Gatorback, Hi-Miler and Super Hi-Miler. All Rights Reserved. ©2008 Veyance Technologies, Inc. All Rights Reserved.

NASCAR® and NASCAR Performance® are registered trademarks of the National Association for Stock Car Auto Racing, Inc.

700-821-950-714

08GRPR020 - 06/08

goodyearep.com

Aftermarket Parts - Automotive and Commercial Truck, Conveyor Belt -
Heavyweight and Lightweight, Home and Garden, Hydraulics, Industrial Hose,
Power Transmission Products, Powersports, Rubber Track

The logo for Veyance Technologies, featuring a stylized winged foot icon to the left of the company name "VEYANCE TECHNOLOGIES" in a bold, sans-serif font.