

Hi-lume 1% 2-Wire LED Driver Forward-Phase Control Overview

The Hi-lume 1% 2-Wire LED Driver is a high-performance LED driver that provides smooth, continuous, flicker-free, 1% dimming for virtually any LED fixture, whether it requires constant-current or constant-voltage. Formerly part of the A-series family, it is the most versatile LED driver offered today due to its compatibility with a wide variety of LED arrays, multiple form factors, and numerous control options.

Features

- UL® Listed Class P
- Continuous, flicker-free dimming from 100% to 1%.¹
- Guaranteed compatibility with selected Maestro Wireless, RadioRA 2, HomeWorks QS, GRAFIK Eye QS, GRAFIK Systems, Quantum, and C•L dimmers. Please see **Compatible Controls** chart or contact Lutron for details regarding compatible controls.
- QwikFig compatible. For more information please refer to Lutron P/N 041473 (K and M case only).
- 100% performance tested at factory.
- A rated lifetime of 50,000 hours @ $t_c = 149^\circ\text{F}$ (65°C).
- Remote-mount options for United States and Canada.
- NOM certified option for Mexico.
- Type TL Rated.²
- FCC Part 15 compliant for commercial and residential (UL® Listed, remote-mountable only) applications at 120 V ~.
- Pulse width modulation (PWM) or constant-current reduction (CCR) dimming methods available. See Application Note #360 for details.
- RoHS Compliant.
- ENERGY STAR Luminaires V2.0 and California Title 24 JA8 compliant models available.
- For more information please go to: www.lutron.com/hilume1led



Case type K

3.00 in (76 mm) W x 1.00 in (25 mm) H x
4.90 in (124 mm) L



Case type M

1.18 in (30 mm) W x 1.00 in (25 mm) H x
14.25 in (362 mm) L



Case type KL

K-case mounted on a 4.00 in (102 mm) W x
1.50 in (38 mm) H x 4.00 in (102 mm) L junction
box to provide wiring compartment

¹ Light output at 1% depends on the efficacy of the light engine used with the driver.

² Visit "Online Certificates Directory" at www.ul.com, enter file number "E322469" to determine the Type TL numbers specific to LTE model Lutron LED Driver.

LUTRON SPECIFICATION SUBMITTAL

Page

Job Name:

Model Numbers:

Job Number:

Specifications

Regulatory Approvals

- Meets ANSI C62.41 category A surge protection standards up to and including 4 kV.
- FCC Part 15 compliant for commercial and residential (UL® Listed, remote-mountable only) applications.
- Manufacturing facilities employ ESD reduction practices that comply with the requirements of ANSI/ESD S20.20.
- Lutron Quality Systems registered to ISO 9001.2015.
- UL® 8750 Class P Listed (K- and M- cases).
- UL® 8750 Listed, remote-mountable form factor (KL Case).
- Class 2 output available.
- LTEA4U1UKL-AV120 and LTEA4U1UKL-CV240 models are NOM certified and available for Mexico.
- LED drivers need to meet certain performance criteria in order for the completed luminaires to comply with the ENERGY STAR Luminaires V2.0 Specification. All models meet these performance criteria throughout their entire load compatibility regions. Refer to the load compatibility graph on each output range page. Consult Application Note #599, **ENERGY STAR Luminaires V2.0 and Lutron Drivers** at www.lutron.com for availability dates of compliant products.
- LED drivers need to meet certain performance criteria in order for the completed luminaires to comply with Title 24 requirements as detailed in CEC-400-2015-037-CMF. All models meet these performance criteria above a minimum output power in their compatibility regions. Refer to the load compatibility graph on each output range page for specific details. Consult **CEC-400-2015-032-CMF Section 6.2.7** for important information on meeting start-up time requirements with fade-in lighting.

UL® 8750 Listed, Remote-Mountable Option

- cULus for United States and Canada available for certain operating regions.
- Pre-wired and installation ready.
- See **KL Case: Case Dimensions** page for more specific details regarding UL listed option.
- Integral junction box to save time.
- For maximum driver-to-LED light engine wire length, see **Driver Leads** section near the end of this document.

Environmental

- Sound Rating: Inaudible in 27 dB ambient.
- Relative Humidity: Maximum 90% non-condensing.
- Minimum operating ambient temperature $t_a = 32\text{ }^\circ\text{F}$ ($0\text{ }^\circ\text{C}$).¹

¹ Where t_a is the temperature of the air directly surrounding the driver.

Job Name: Job Number:	Model Numbers:
--	-----------------------

Specifications *(continued)*

Performance

- Dimming Range: 100% to 1%.
- Operating Voltage: 120 V~ at 50/60 Hz
- Requires Forward Phase Control; please see **Compatible Controls** chart.
- A rated lifetime of 50,000 hours @ $t_c = 149^\circ\text{F}$ (65°C).
 - For rated warranty, t_c not to exceed the maximum rated temperatures.¹
- Patented thermal foldback protection.
- At turn-on, lighting will fade smoothly to the desired light level without decreasing or flashing to full brightness.
- Non-volatile memory restores all driver settings after power failure.
- Inrush Current: < 2 A.
- Inrush Current Limiting Circuitry: eliminates circuit breaker tripping, switch arcing and relay failure.
- Open circuit protected.
- Short circuit protected.
- Turn-on time: ≤ 0.5 seconds to first light.
- PWM Dimming Frequency: 550 Hz.²

Driver Wiring & Mounting

- Driver is grounded by a mounting screw to the grounded fixture (or by terminal connection on the K case).
- Terminal blocks on the driver accept one solid wire per terminal from 18 AWG to 16 AWG (0.75 mm^2 to 1.5 mm^2).
- Fixture must be grounded in accordance with local and national electrical codes.
- For maximum driver-to-LED light engine wire length, see charts in **Driver Leads** section at the end of the document.

¹ Installer is responsible for ensuring that the driver case temperature does not exceed the maximum rated temperature.

² Does not apply to CCR dimming method drivers.

Job Name:	Model Numbers:
Job Number:	

How to Select the Correct LED Driver for Your Load

Note: Try our LED Driver Selection Tool online at www.lutron.com/leddrivertool

1. Review the specifications of the LED load.
 - a. Identify if the LED load requires a “constant current” or a “constant voltage” driver. Contact the LED load manufacturer for information on the type of load.
 - b. Identify the minimum and maximum operating voltage of the LED load at the desired operating current. This “current” will be the rated output current of the LED driver. Consult the LED load manufacturer for any questions.

The examples below are for a Class 2 constant current application:

Example 1: A Class 2 LED load that is rated at 1 A and 38 V_{nom} nominally, and has an output voltage range of 36–40 V_{op} (at 1 A) due to unit-to-unit variation, temperature, etc.

Example 2: A Class 2 LED load that is rated at 1 A and 40 V_{nom} nominally, and has an output voltage range of 38–42 V_{op} (at 1 A) due to unit-to-unit variation, temperature, etc.

2. Determine the proper operating range of the LED driver.

- a. Identify the output current range(s) of the driver family that includes the desired current.

Examples 1 & 2: Only “F”, “I”, “J”, and “Z” models meet the current range of the selected load (1 A).

LED Load Output Range (see the following pages for more detail):

Class 2 Constant-Voltage

A = 10.0 V–12.0 V*

B = 12.5 V–20.0 V**†

C = 20.5 V–24.0 V†

D = 24.5 V–38.0 V†

Isolated Non-Class 2 Constant-Voltage

X = 38.5 V–60.0 V†

Class 2 Constant-Current

E = 0.20 A–0.50 A 30 V–54 V

F = 0.51 A–1.00 A 30 V–54 V†

G = 0.20 A–0.70 A 8 V–20 V

H = 0.20 A–0.70 A 15 V–38 V

I = 0.71 A–1.05 A 8 V–20 V

J = 0.71 A–1.05 A 15 V–38 V

K = 1.06 A–1.50 A 8 V–20 V

L = 1.06 A–1.50 A 15 V–38 V†

M = 1.51 A–2.10 A 8 V–19.9 V†

Isolated Non-Class 2 Constant-Current

Y = 0.20 A–0.50 A 30 V–60 V

Z = 0.51 A–1.00 A 30 V–60 V†

* Available in K-case only.

† Output parameter is power-limited for these output ranges. Consult detailed specifications on the following pages for each range.

- b. Identify output voltage range(s) of the driver that includes the desired voltage range.

Examples 1 & 2: Out of the 3 models indicated in step 2a., only “F” and “Z” models meet the voltage requirement for the selected loads.

LED Load Output Range (see the following pages for more detail):

Class 2 Constant-Voltage

A = 10.0 V–12.0 V*

B = 12.5 V–20.0 V**†

C = 20.5 V–24.0 V†

D = 24.5 V–38.0 V†

Isolated Non-Class 2 Constant-Voltage

X = 38.5 V–60.0 V†

Class 2 Constant-Current

E = 0.20 A–0.50 A 30 V–54 V

F = 0.51 A–1.00 A 30 V–54 V†

G = 0.20 A–0.70 A 8 V–20 V

H = 0.20 A–0.70 A 15 V–38 V

I = 0.71 A–1.05 A 8 V–20 V

J = 0.71 A–1.05 A 15 V–38 V

K = 1.06 A–1.50 A 8 V–20 V

L = 1.06 A–1.50 A 15 V–38 V†

M = 1.51 A–2.10 A 8 V–19.9 V†

Isolated Non-Class 2 Constant-Current

Y = 0.20 A–0.50 A 30 V–60 V

Z = 0.51 A–1.00 A 30 V–60 V†

* Available in K-case only.

† Output parameter is power-limited for these output ranges. Consult detailed specifications on the following pages for each range.

Continued on next page

Job Name:	Model Numbers:
Job Number:	

How to Select the Correct LED Driver for Your Load *(continued)*

3. Identify if the driver needs to be Class 2. Examples 1 & 2: Out of the “F” and “Z” models, only the “F” model is Class 2

a. Examine the Load Compatibility graphs below for each output range to ensure that the voltage range of the LED load is within the safe operating area.

Example 1: The LED voltage range of 36 V_{DC} to 40 V_{DC} falls entirely within the operating area of output range F, so this is a compatible output range

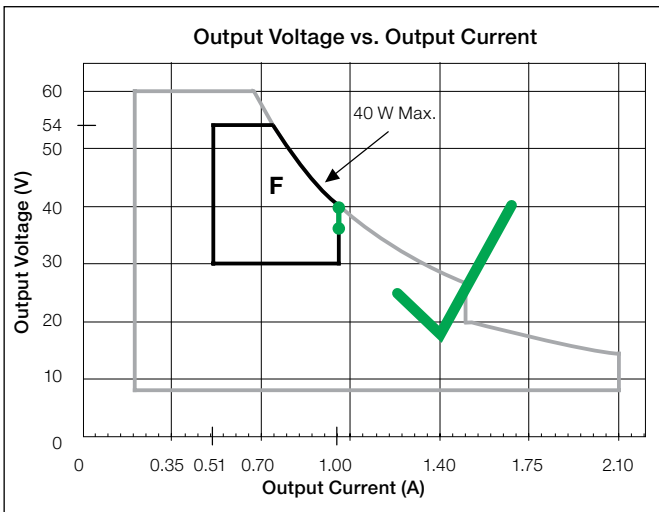

The model numbers for this example are:

- LTEA4U1UMN-FA100 M-Case, constant-current reduction dimming
- LTEA4U1UKL-FA100 UL® Listed, remote-mountable, constant-current reduction dimming
- LTEA4U1UKN-FA100 K-Case, non-studded, constant-current reduction dimming
- LTEA4U1UKS-FA100 K-Case, studded, constant-current reduction dimming

Example 2: The LED voltage range of 38 V_{DC} to 42 V_{DC} does not fall entirely within the operating area of output range F, so this is not a compatible output range.

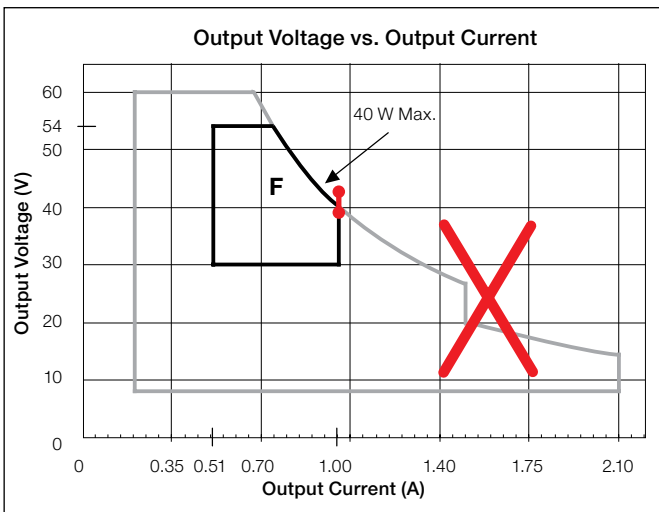

Job Name:	Model Numbers:
Job Number:	

How to Build a Model Number: Hi-lume 1% 2-Wire LED Driver

LTEA4U1U -

Example: LTEA4U1UKS-HC070

For further assistance selecting your model number, contact our LED Center of Excellence at 1.877.DIM.LED8 or LEDs@lutron.com

Case Size:

K = Compact
M = Stick

Current Level (for Constant-Current):

020 = 0.20 A; 021 = 0.21 A...070 = 0.70 A...210 = 2.10 A

Voltage Level (for Constant-Voltage):

100 = 10.0 V; 105 = 10.5 V...600 = 60.0 V

Case Style:

S = Studded (K case only)
N = Non-Studded
L = Remote-mountable, (K case only)

Driver Output:

C = Constant-current driver with pulse width modulation (PWM) dimming
A = Constant-current driver with constant-current reduction (CCR) dimming
V = Constant-voltage driver with pulse width modulation (PWM) dimming

LED Load Output Range (see the following pages for more detail):

Class 2 Constant-Voltage

A = 10.0 V–12.0 V*
B = 12.5 V–20.0 V*†
C = 20.5 V–24.0 V†
D = 24.5 V–38.0 V†

Isolated Non-Class 2 Constant-Voltage

X = 38.5 V–60.0 V†

Class 2 Constant-Current

E = 0.20 A–0.50 A 30 V–54 V
F = 0.51 A–1.00 A 30 V–54 V†
G = 0.20 A–0.70 A 8 V–20 V
H = 0.20 A–0.70 A 15 V–38 V
I = 0.71 A–1.05 A 8 V–20 V
J = 0.71 A–1.05 A 15 V–38 V
K = 1.06 A–1.50 A 8 V–20 V
L = 1.06 A–1.50 A 15 V–38 V†
M = 1.51 A–2.10 A 8 V – 19.9 V†

Isolated Non-Class 2 Constant-Current

Y = 0.20 A–0.50 A 30 V–60 V
Z = 0.51 A–1.00 A 30 V–60 V†

* Available in K-case only.

† Output parameter is power-limited for these output ranges. Consult detailed specifications on the following pages for each range.

Job Name:	Model Numbers:
Job Number:	

How to Build a Bulk Model Number (For use with Lutron QwikFig technology): Hi-lume 1% 2-Wire LED Driver

LTEA4U1U - BLK

Case Size:

K = Compact
M = Stick

Case Style:¹

S = Studded
(K-case only)
N = Non-Studded
(All M-case models)

Bulk Models:

Coverage based on “LED Load Output Range” from standard non-configurable models shown in the **How to Build a Model Number** section. Example Standard Model Number: LTEA4U1UKS-HC070 has LED load output range = H

K-Case and M-Case

1A = Covers “LED Load Output Range” Y and Z
2A = Covers “LED Load Output Range” M
3A = Covers “LED Load Output Range” E and F (CCR dimming only)

K-Case only

2G = Covers “LED Load Output Range” G
2H = Covers “LED Load Output Range” H
2R = Covers “LED Load Output Range” I and K
2S = Covers “LED Load Output Range” J and L

M-Case only



2B = Covers “LED Load Output Range” H, J, and L
2C = Covers “LED Load Output Range” G, I, and K

Note: Only the model numbers falling into the structure listed above can be configured with QwikFig. Standard model numbers configured at Lutron will not be capable of being reconfigured at another facility.

¹ QwikFig bulk drivers are not available as KL type.

Job Name:	Model Numbers:
Job Number:	

“A” Output Range, Voltage Driver Models

Driver Type	Output Dimming Method	Output Voltage	Output Current	Output Power	Standards Recognition	UL® Listed, Remote-Mountable Available	Standards Recognition for UL® Listed, Remote-Mountable
Constant-Voltage Driver (Class 2)	Pulse Width Modulation (PWM)	10.0–12.0 V PWM	0.42–3.3 A	5–40 W		Yes	

Typical Performance Specifications:

Parameter	Value	Test Conditions
Input Current	430 mA	$t_a = 25\text{ }^\circ\text{C}$, 12.0 V 40 W load, Maximum Light Output, K case 120 V~ without a dimmer
Power Factor	0.98	
THD	17%	
Driver Efficiency	77%	

Available in K-case only

Load Compatibility

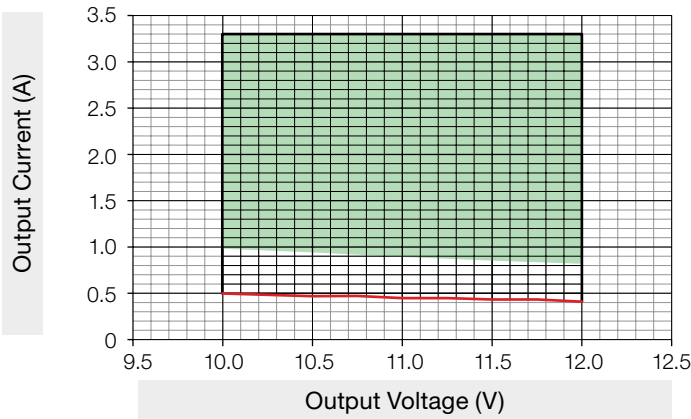

Key: ■ Green area shows California Title 24
— 5 W limited

Typical Efficiency vs. Output Voltage

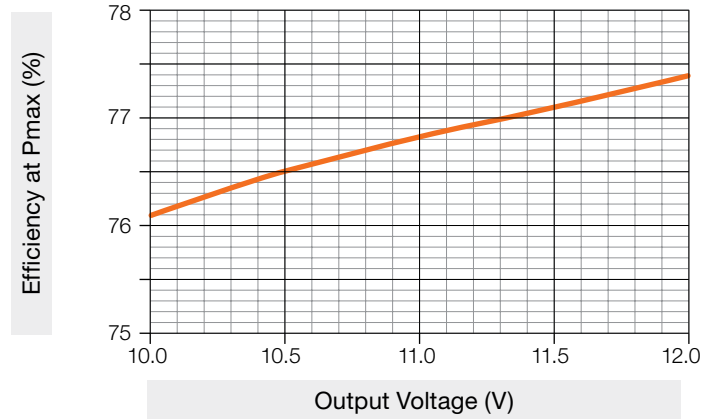

Typical THD vs. Output Power

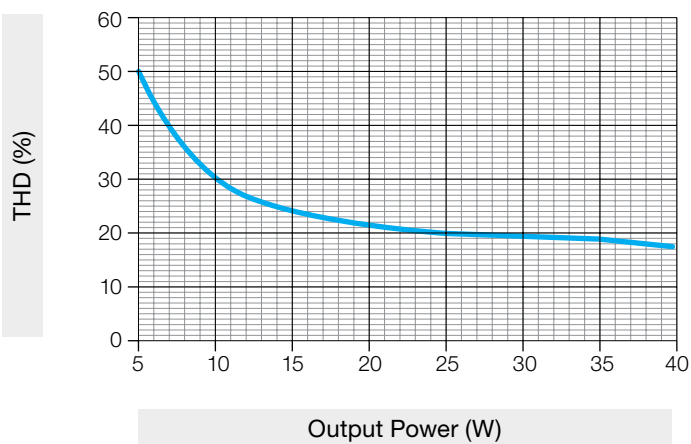

Typical Power Factor vs. Output Power

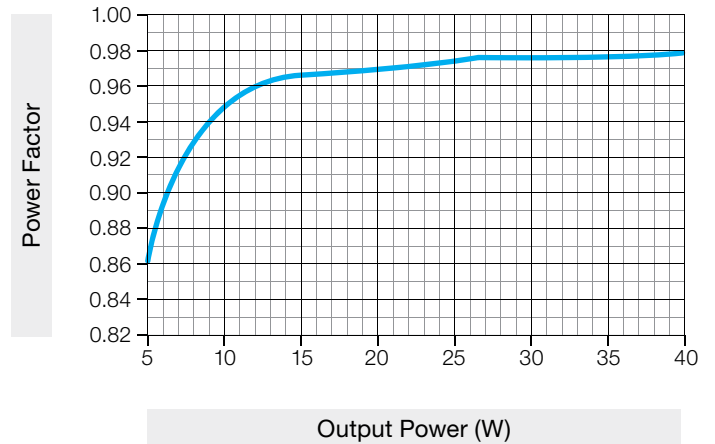

¹ LTEA4U1UKL-AV120 and LTEA4U1UKL-CV240 models are NOM certified and available for Mexico.

Job Name:	Model Numbers:
Job Number:	

“B” Output Range, Voltage Driver Models

Driver Type	Output Dimming Method	Output Voltage	Output Current	Output Power	Standards Recognition	UL® Listed, Remote-Mountable Available	Standards Recognition for UL® Listed, Remote-Mountable
Constant-Voltage Driver (Class 2)	Pulse Width Modulation (PWM)	12.5–20.0 V PWM	0.25–3.2 A	5–40 W		Yes	

Typical Performance Specifications:

Parameter	Value	Test Conditions
Input Current	410 mA	$t_a = 25\text{ }^\circ\text{C}$, 20.0 V 40 W load, Max. Light Output, K case 120 V~ without a dimmer
Power Factor	0.98	
THD	12%	
Driver Efficiency	80%	

Available in K-case only

Load Compatibility

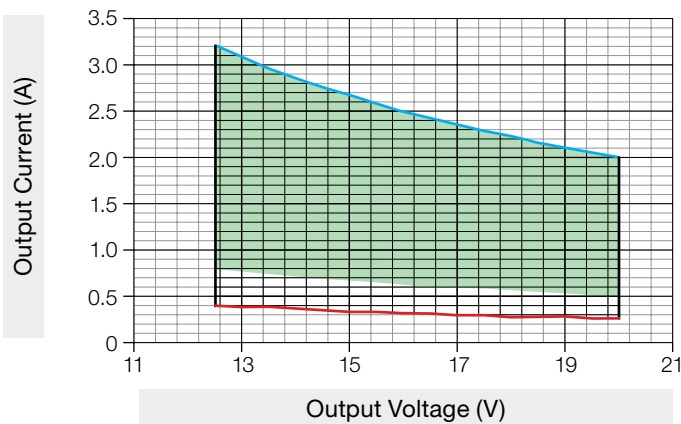

Key: ■ Green area shows California Title 24
— 5 W limited — 40 W limited

Typical Efficiency vs. Output Voltage

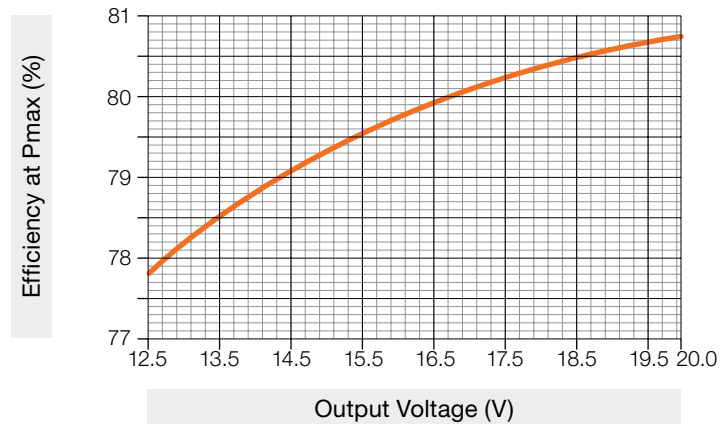

Typical THD vs. Output Power

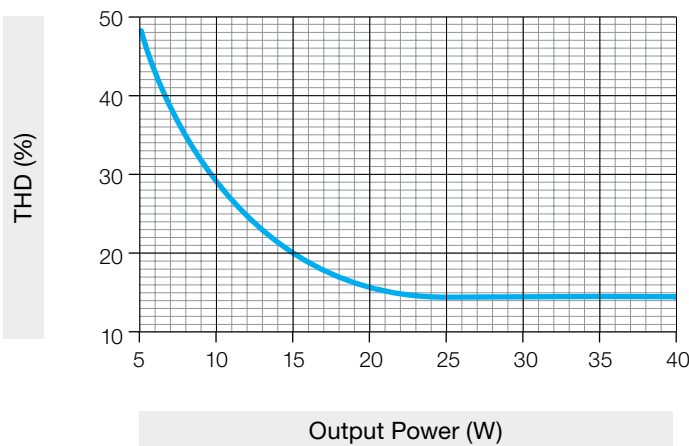

Typical Power Factor vs. Output Power

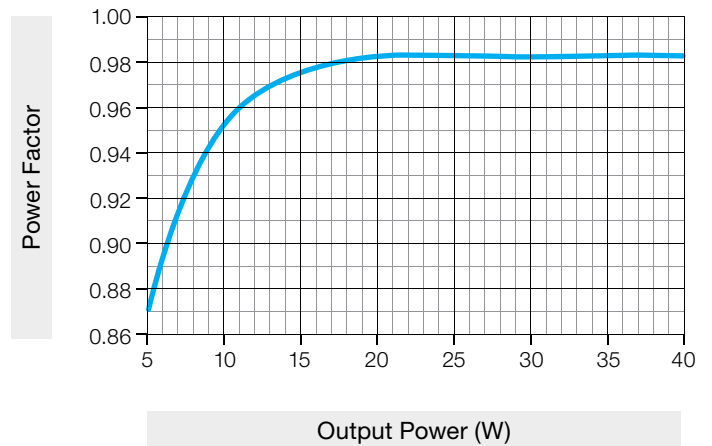

Job Name:	Model Numbers:
Job Number:	

“C” Output Range, Voltage Driver Models

Driver Type	Output Dimming Method	Output Voltage	Output Current	Output Power	Standards Recognition	UL® Listed, Remote-Mountable Available	Standards Recognition for UL® Listed, Remote-Mountable
Constant-Voltage Driver (Class 2)	Pulse Width Modulation (PWM)	20.5–24.0 V PWM	0.21–1.95 A	5–40 W		Yes	

Typical Performance Specifications:

Parameter	Value	Test Conditions
Input Current	420 mA	$t_a = 25\text{ }^\circ\text{C}$, 24.0 V 40 W load, Maximum Light Output, K case 120 V~ without a dimmer
Power Factor	0.98	
THD	14%	
Driver Efficiency	80%	

Load Compatibility

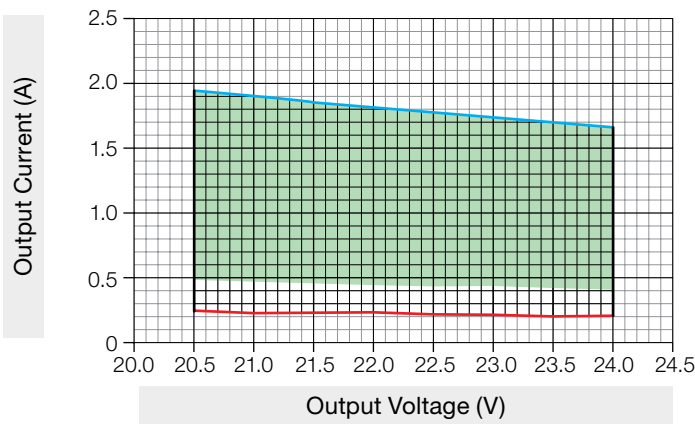

Key:
■ Green area shows California Title 24
— 5 W limited — 40 W limited

Typical Efficiency vs. Output Voltage

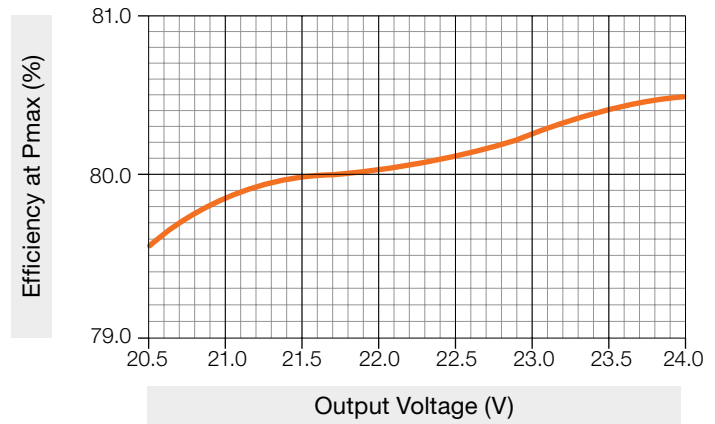

Typical THD vs. Output Power

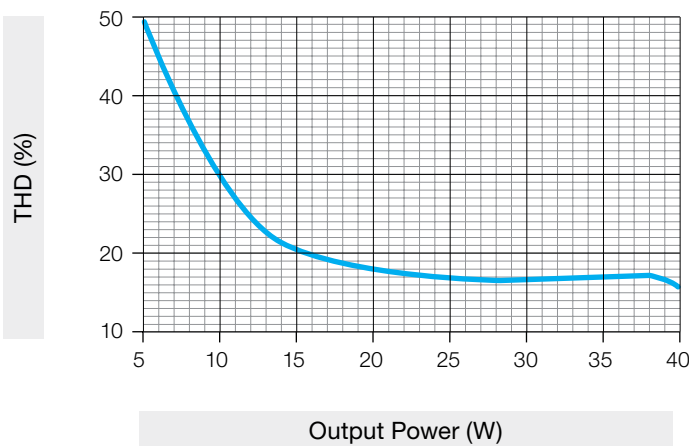

Typical Power Factor vs. Output Power

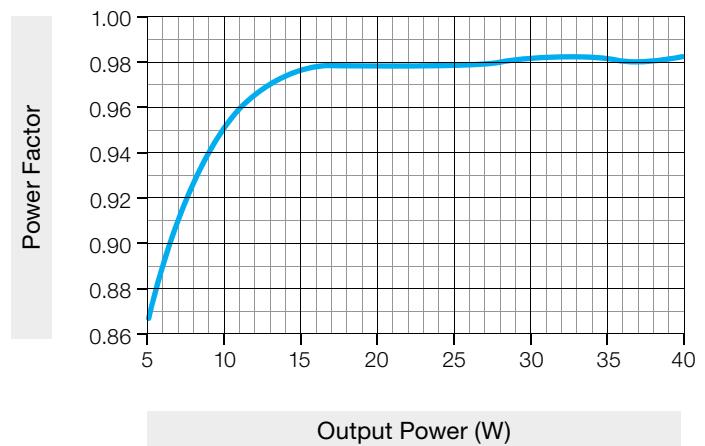

¹ LTEA4U1UKL-AV120 and LTEA4U1UKL-CV240 models are NOM certified and available for Mexico.

Job Name:	Model Numbers:
Job Number:	

“D” Output Range, Voltage Driver Models

Driver Type	Output Dimming Method	Output Voltage	Output Current	Output Power	Standards Recognition	UL® Listed, Remote-Mountable Available	Standards Recognition for UL® Listed, Remote-Mountable
Constant-Voltage Driver (Class 2)	Pulse Width Modulation (PWM)	24.5–38.0 V PWM	0.13–1.63 A	5–40 W		Yes	

Typical Performance Specifications:

Parameter	Value	Test Conditions
Input Current	400 mA	$t_a = 25\text{ }^\circ\text{C}$, 38.0 V 40 W load, Maximum Light Output, K case 120 V~ without a dimmer
Power Factor	0.99	
THD	8%	
Driver Efficiency	82%	

Load Compatibility

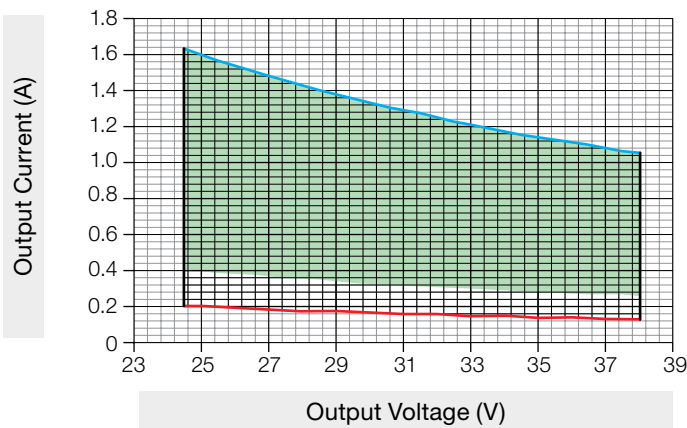

Key:

- Green area shows California Title 24
- 5 W limited
- 40 W limited

Typical Efficiency vs. Output Voltage

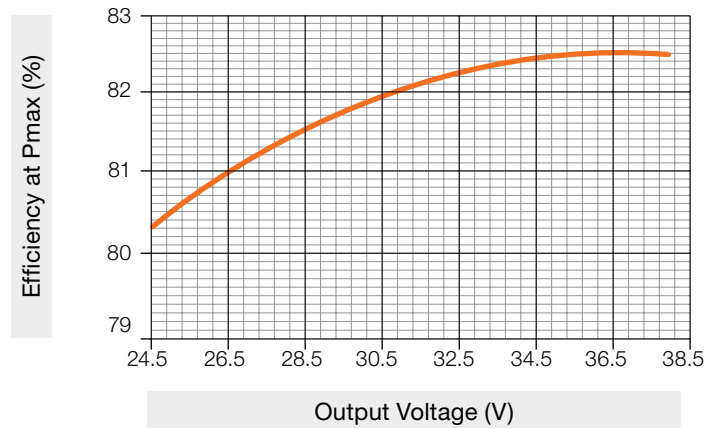

Typical THD vs. Output Power

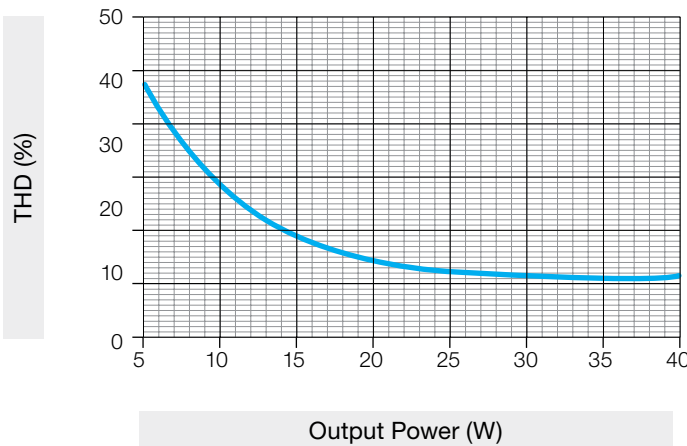

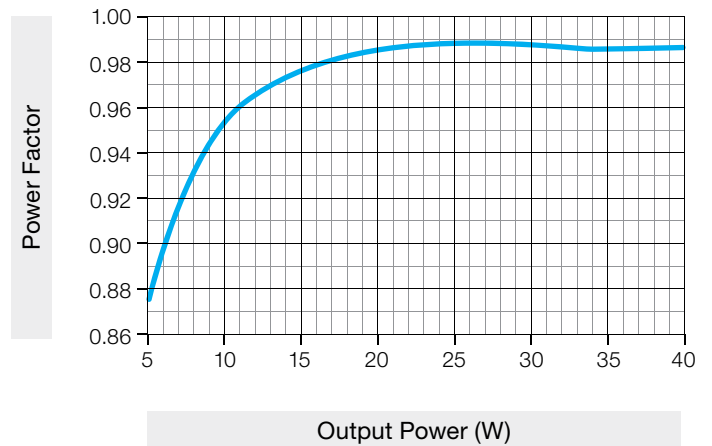

Typical Power Factor vs. Output Power



Job Name:	Model Numbers:
Job Number:	

“E” Output Range, Current Driver Models

Driver Type	Output Dimming Method	Output Voltage	Output Current	Output Power	Standards Recognition	UL® Listed, Remote-Mountable Available	Standards Recognition for UL® Listed, Remote-Mountable
Constant-Current Driver (Class 2)	Constant-Current Reduction (CCR)	30–54 V ⁼⁼⁼	0.20–0.50 A	6–27 W		Yes	

When using QwikFig technology, these models can be built from the following bulk units in 10 mA increments:

K-case - LTEA4U1UKx-3ABLK*; M-case - LTEA4U1UMN-3ABLK

* x = studded (S) or non-studded (N)

Typical Performance Specifications:

Parameter	Value	Test Conditions
Input Current	280 mA	t _a = 25 °C, 0.50 A 27 W load, Maximum Light Output, K case 120 V [~] without a dimmer
Power Factor	0.99	
THD	11%	
Driver Efficiency	80%	

Load Compatibility

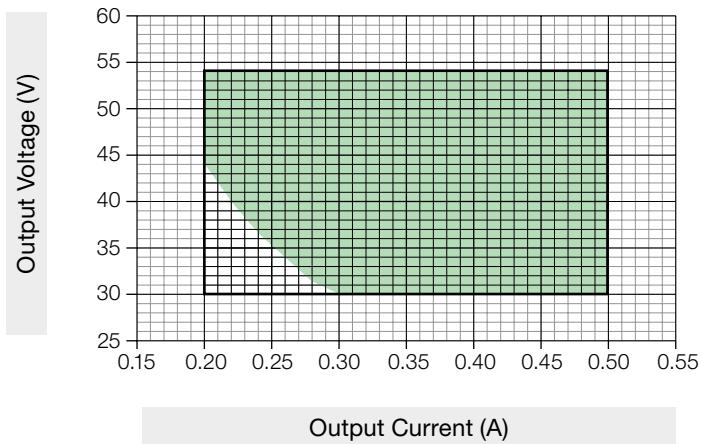

Typical Efficiency vs. Output Current

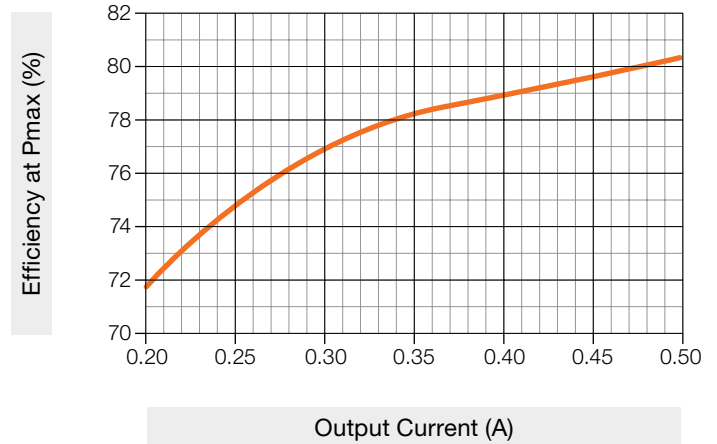

Key: ■ Green area shows California Title 24

Typical THD vs. Output Power

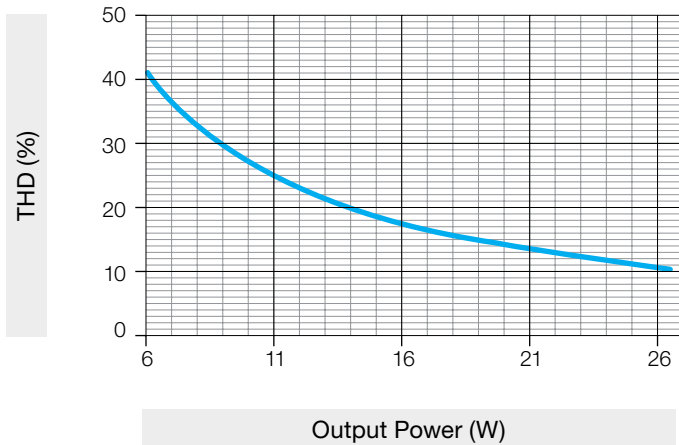

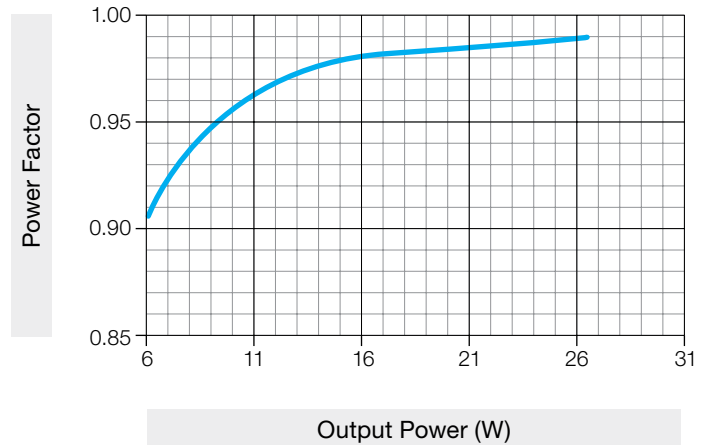

Typical Power Factor vs. Output Power



Job Name:	Model Numbers:
Job Number:	

“F” Output Range, Current Driver Models

Driver Type	Output Dimming Method	Output Voltage	Output Current	Output Power	Standards Recognition	UL® Listed, Remote-Mountable Available	Standards Recognition for UL® Listed, Remote-Mountable
Constant-Current Driver (Class 2)	Constant-Current Reduction (CCR)	30–54 V $\overline{=}$	0.51–1.00 A	15–40 W		Yes	

When using QwikFig technology, these models can be built from the following bulk units in 10 mA increments:

K-case - LTEA4U1UKx-3ABLK*; M-case - LTEA4U1UMN-3ABLK

* x = studded (S) or non-studded (N)

Typical Performance Specifications:

Parameter	Value	Test Conditions
Input Current	430 mA	$t_a = 25^\circ\text{C}$, 1.00 A 40 W load, Maximum Light Output, K case 120 V \sim without a dimmer
Power Factor	0.98	
THD	11%	
Driver Efficiency	80%	

Load Compatibility

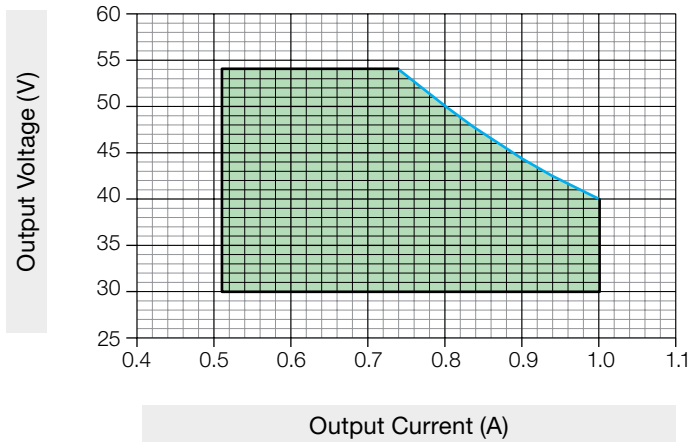

Key:
■ Green area shows California Title 24 and Energy Star 2.0 Compliance
— 40 W limited

Typical Efficiency vs. Output Current

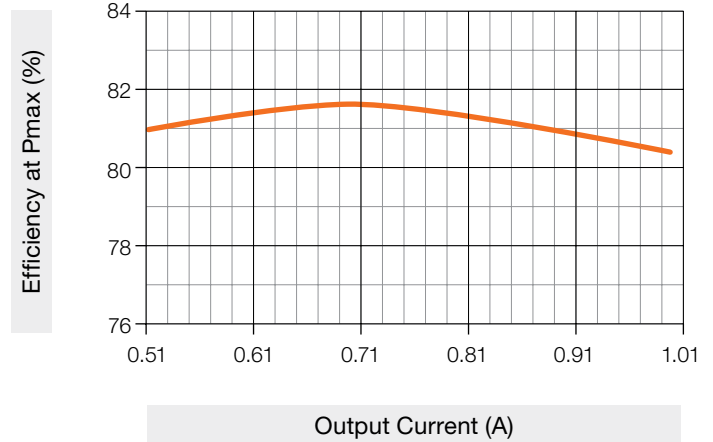

Typical THD vs. Output Power

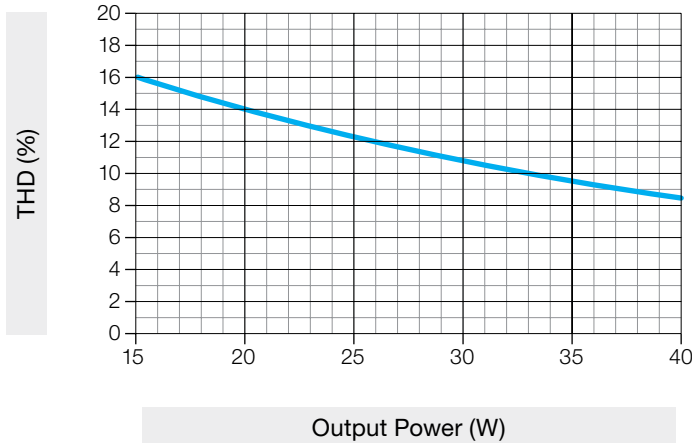

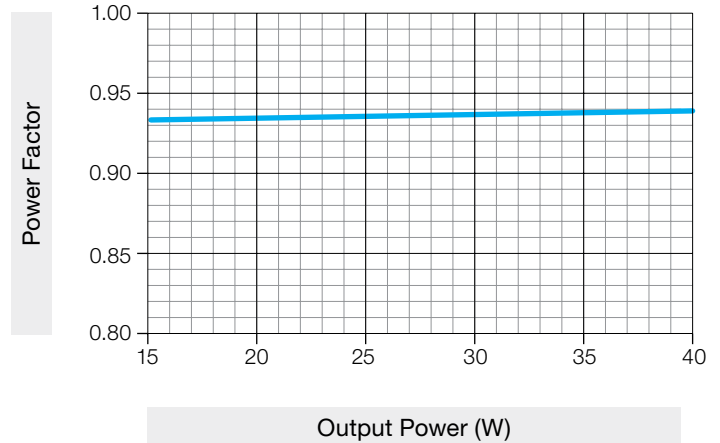

Typical Power Factor vs. Output Power



Job Name:	Model Numbers:
Job Number:	

“G” Output Range, Current Driver Models

Driver Type	Output Dimming Method	Output Voltage	Output Current	Output Power	Standards Recognition	UL® Listed, Remote-Mountable Available	Standards Recognition for UL® Listed, Remote-Mountable
Constant-Current Driver (Class 2)	Pulse Width Modulation (PWM)	8–20 V PWM	0.20–0.70 A	2–14 W		Yes	
	Constant-Current Reduction (CCR)	8–20 V \equiv					

When using QwikFig technology, these models can be built from the following bulk units in 10 mA increments:

K-case - LTEA4U1UKx-2GBLK*; M-case - LTEA4U1UMN-2CBLK

* x = studded (S) or non-studded (N)

Typical Performance Specifications:

Parameter	Value	Test Conditions
Input Current	170 mA	$t_a = 25^\circ\text{C}$, 0.70 A 14 W load, Maximum Light Output, K case 120 V \sim without a dimmer
Power Factor	0.97	
THD	23%	
Driver Efficiency	72%	

Load Compatibility

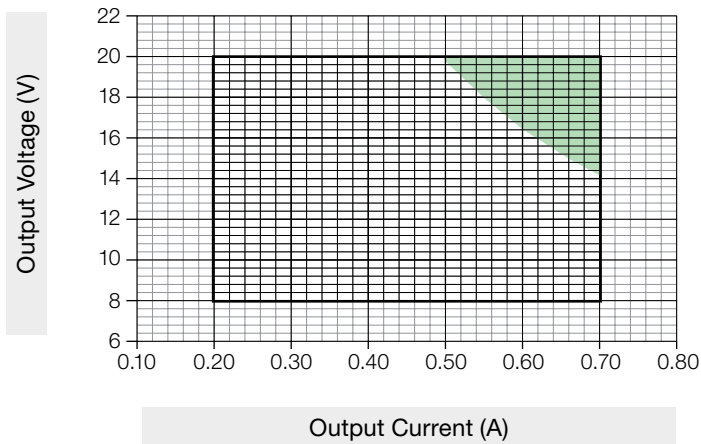

Key: Green area shows California Title 24

Typical Efficiency vs. Output Current

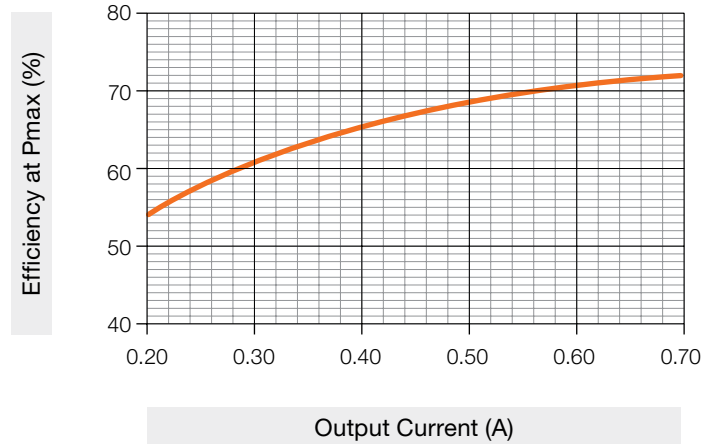

Typical THD vs. Output Power

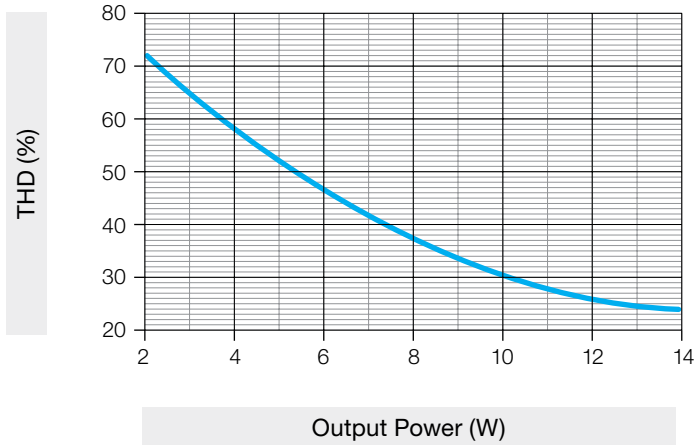

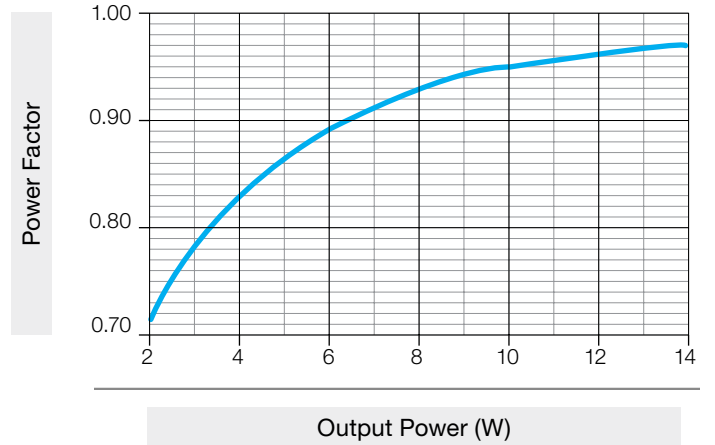

Typical Power Factor vs. Output Power



Job Name:	Model Numbers:
Job Number:	

“H” Output Range, Current Driver Models

Driver Type	Output Dimming Method	Output Voltage	Output Current	Output Power	Standards Recognition	UL® Listed, Remote-Mountable Available	Standards Recognition for UL® Listed, Remote-Mountable
Constant-Current Driver (Class 2)	Pulse Width Modulation (PWM)	15–38 V PWM	0.20–0.70 A	3–26.6 W		Yes	
	Constant-Current Reduction (CCR)	15–38 V==					

When using QwikFig technology, these models can be built from the following bulk units in 10 mA increments:

K-case - LTEA4U1UKx-2HBLK*; M-case - LTEA4U1UMN-2BBLK

* x = studded (S) or non-studded (N)

Typical Performance Specifications:

Parameter	Value	Test Conditions
Input Current	280 mA	t _a = 25 °C, 0.70 A 26 W load, Maximum Light Output, K case 120 V~ without a dimmer
Power Factor	0.99	
THD	10%	
Driver Efficiency	79%	

Load Compatibility

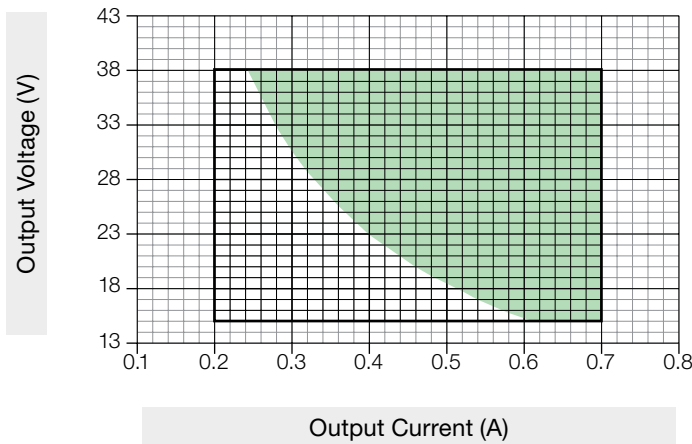

Typical Efficiency vs. Output Current

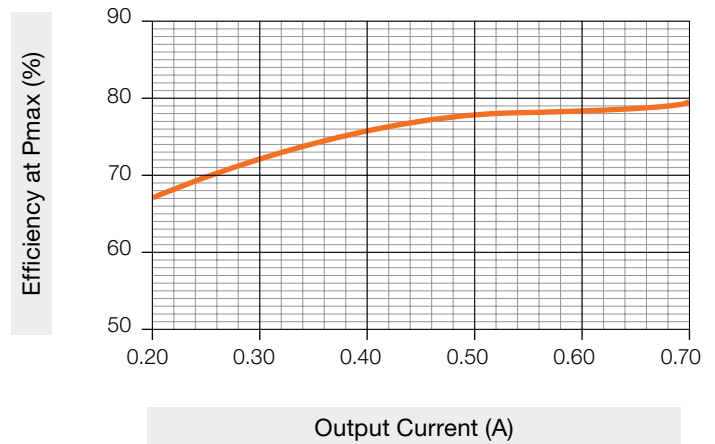

Key: Green area shows California Title 24

Typical THD vs. Output Power

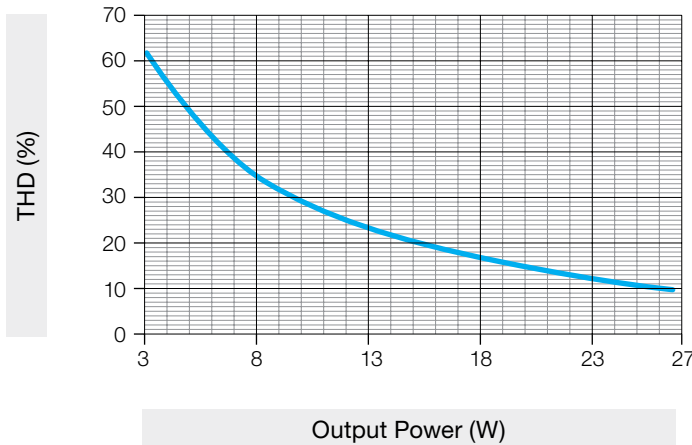

Typical Power Factor vs. Output Power

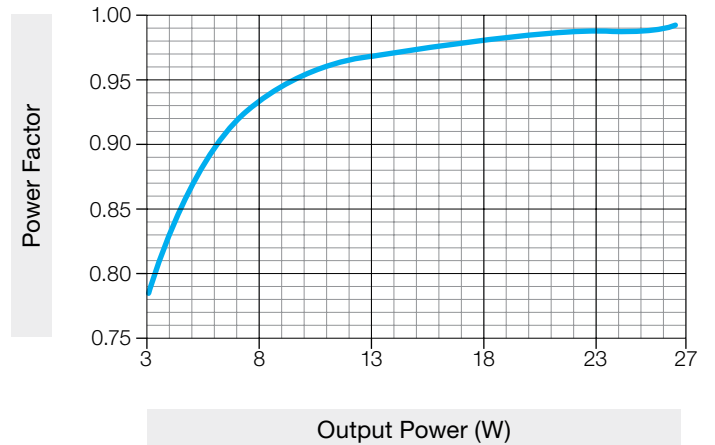

Job Name:	Model Numbers:
Job Number:	

“I” Output Range, Current Driver Models

Driver Type	Output Dimming Method	Output Voltage	Output Current	Output Power	Standards Recognition	UL® Listed, Remote-Mountable Available	Standards Recognition for UL® Listed, Remote-Mountable
Constant-Current Driver (Class 2)	Pulse Width Modulation (PWM)	8–20 V PWM	0.71–1.05 A	6–21 W		Yes	
	Constant-Current Reduction (CCR)	8–20 V---					

When using QwikFig technology, these models can be built from the following bulk units in 10 mA increments:

K-case - LTEA4U1UKx-2RBLK*; M-case - LTEA4U1UMN-2CBLK

* x = studded (S) or non-studded (N)

Typical Performance Specifications:

Parameter	Value	Test Conditions
Input Current	240 mA	t _a = 25 °C, 1.05 A 21 W load, Maximum Light Output, K case 120 V~ without a dimmer
Power Factor	0.97	
THD	20%	
Driver Efficiency	76%	

Load Compatibility

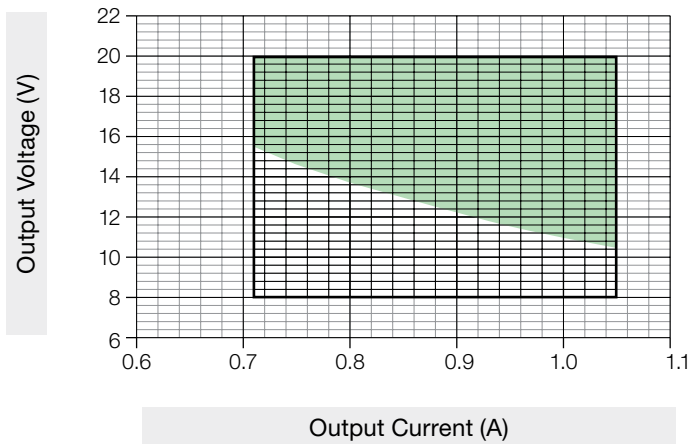

Key: ■ Green area shows California Title 24

Typical Efficiency vs. Output Current

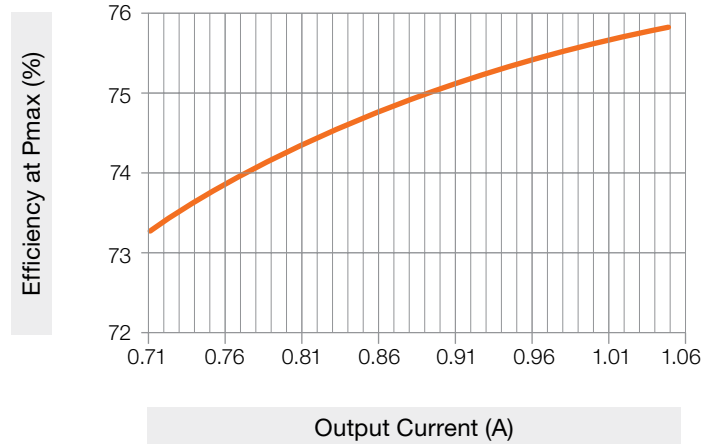

Typical THD vs. Output Power

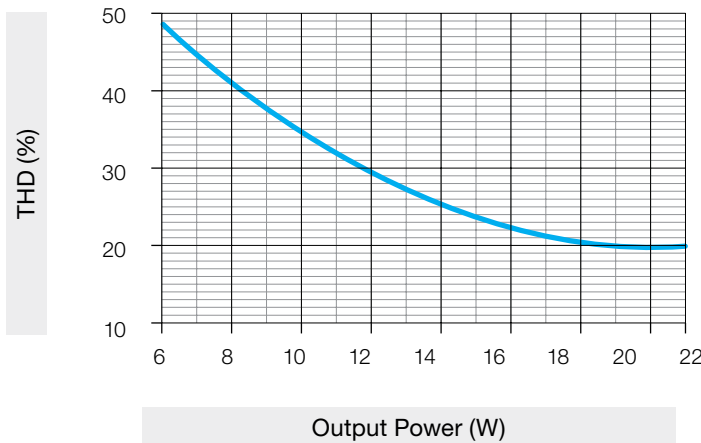

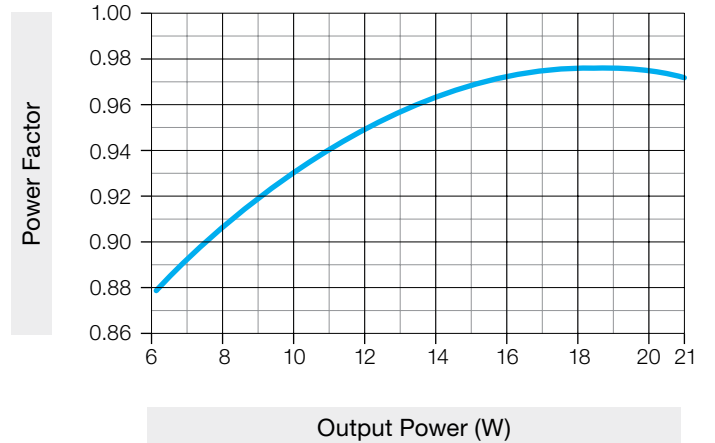

Typical Power Factor vs. Output Power



Job Name:	Model Numbers:
Job Number:	

“J” Output Range, Current Driver Models

Driver Type	Output Dimming Method	Output Voltage	Output Current	Output Power	Standards Recognition	UL® Listed, Remote-Mountable Available	Standards Recognition for UL® Listed, Remote-Mountable
Constant-Current Driver (Class 2)	Pulse Width Modulation (PWM)	15–38 V PWM	0.71–1.05 A	11–40 W		Yes	
	Constant-Current Reduction (CCR)	15–38 V==					

When using QwikFig technology, these models can be built from the following bulk units in 10 mA increments:

K-case - LTEA4U1UKx-2SBLK*; M-case - LTEA4U1UMN-2BBLK

* x = studded (S) or non-studded (N)

Typical Performance Specifications:

Parameter	Value	Test Conditions
Input Current	410 mA	t _a = 25 °C, 1.05 A 40 W load, Maximum Light Output, K case 120 V~ without a dimmer
Power Factor	0.99	
THD	7%	
Driver Efficiency	81%	

Load Compatibility

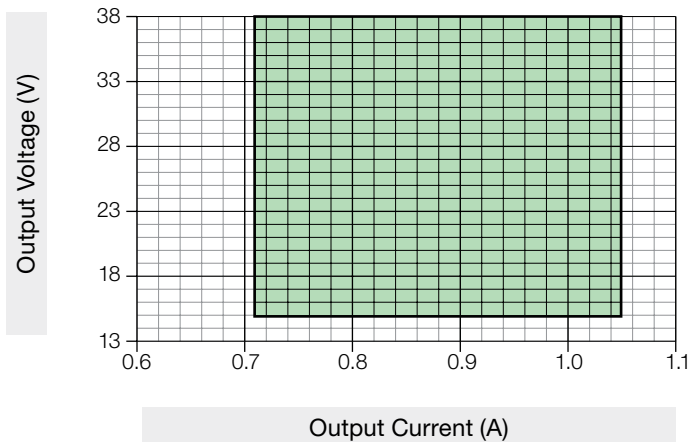

Key: ■ Green area shows California Title 24 and Energy Star 2.0 Compliance

Typical Efficiency vs. Output Current

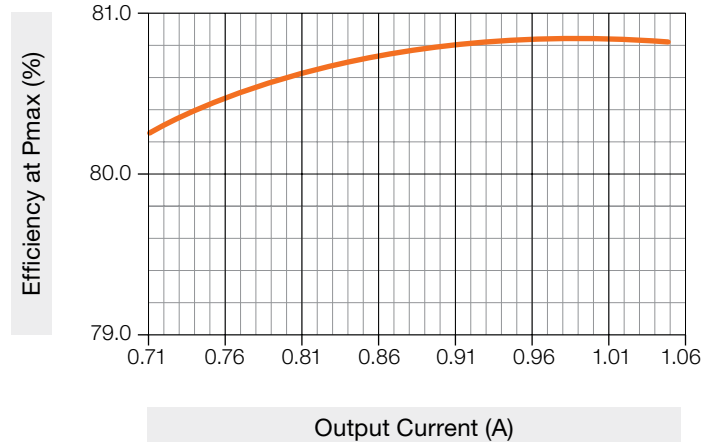

Typical THD vs. Output Power

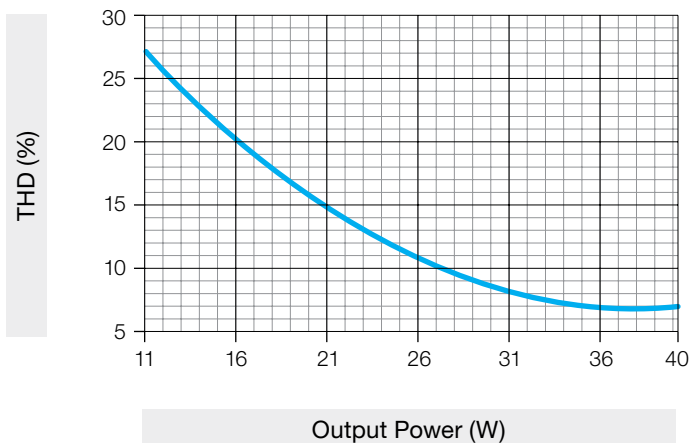

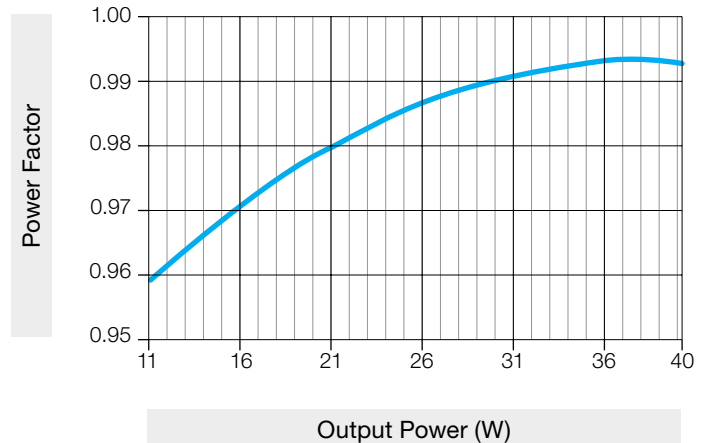

Typical Power Factor vs. Output Power



Job Name:	Model Numbers:
Job Number:	

“K” Output Range, Current Driver Models

Driver Type	Output Dimming Method	Output Voltage	Output Current	Output Power	Standards Recognition	UL® Listed, Remote-Mountable Available	Standards Recognition for UL® Listed, Remote-Mountable
Constant-Current Driver (Class 2)	Pulse Width Modulation (PWM)	8–20 V PWM	1.06–1.50 A	9–30 W		Yes	
	Constant-Current Reduction (CCR)	8–20 V=					

When using QwikFig technology, these models can be built from the following bulk units in 10 mA increments:

K-case - LTEA4U1UKx-2RBLK*; M-case - LTEA4U1UMN-2CBLK

* x = studded (S) or non-studded (N)

Typical Performance Specifications:

Parameter	Value	Test Conditions
Input Current	340 mA	t _a = 25 °C, 1.50 A 30 W load, Maximum Light Output, K case 120 V~ without a dimmer
Power Factor	0.98	
THD	18%	
Driver Efficiency	76%	

Load Compatibility

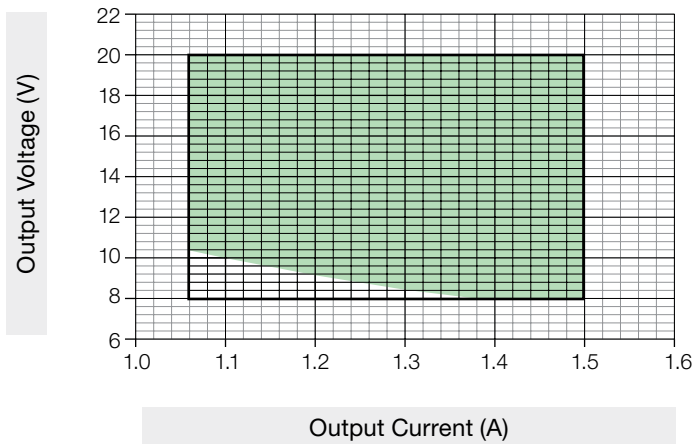

Key: ■ Green area shows California Title 24

Typical Efficiency vs. Output Current

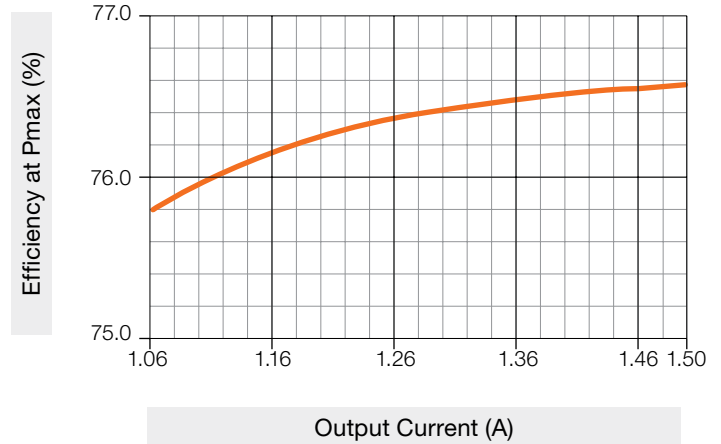

Typical THD vs. Output Power

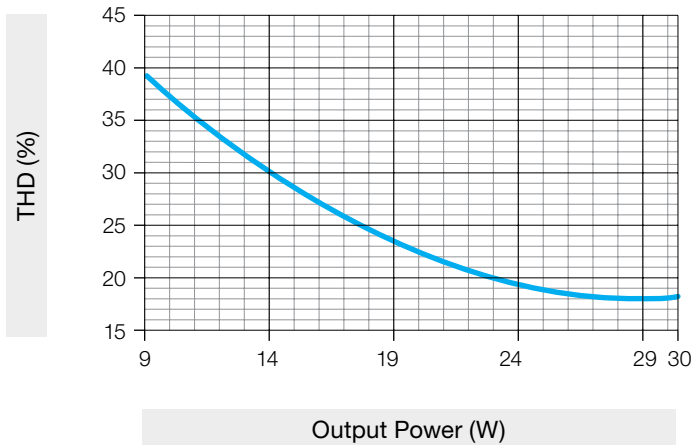

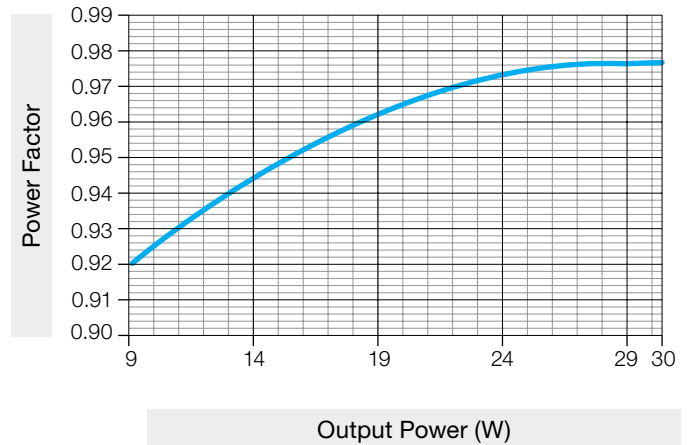

Typical Power Factor vs. Output Power



Job Name:	Model Numbers:
Job Number:	

“L” Output Range, Current Driver Models

Driver Type	Output Dimming Method	Output Voltage	Output Current	Output Power	Standards Recognition	UL® Listed, Remote-Mountable Available	Standards Recognition for UL® Listed, Remote-Mountable
Constant-Current Driver (Class 2)	Pulse Width Modulation (PWM)	15–38 V PWM	1.06–1.50 A	16–40 W		Yes	
	Constant-Current Reduction (CCR)	15–38 V \equiv					

When using QwikFig technology, these models can be built from the following bulk units in 10 mA increments:

K-case - LTEA4U1UKx-2SBLK*; M-case - LTEA4U1UMN-2BBLK

* x = studded (S) or non-studded (N)

Typical Performance Specifications:

Parameter	Value	Test Conditions
Input Current	480 mA	$t_a = 25^\circ\text{C}$, 1.50 A 40 W load, Maximum Light Output, K case 120 V \sim without a dimmer
Power Factor	0.98	
THD	12%	
Driver Efficiency	78%	

Load Compatibility

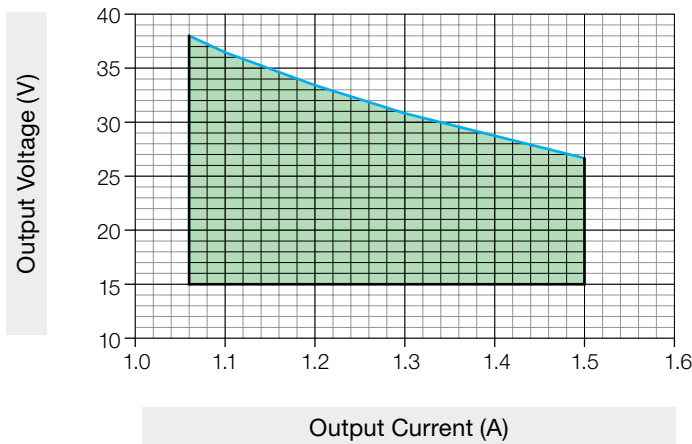

Key:
■ Green area shows California Title 24 and Energy Star 2.0 Compliance
— 40 W limited

Typical Efficiency vs. Output Current

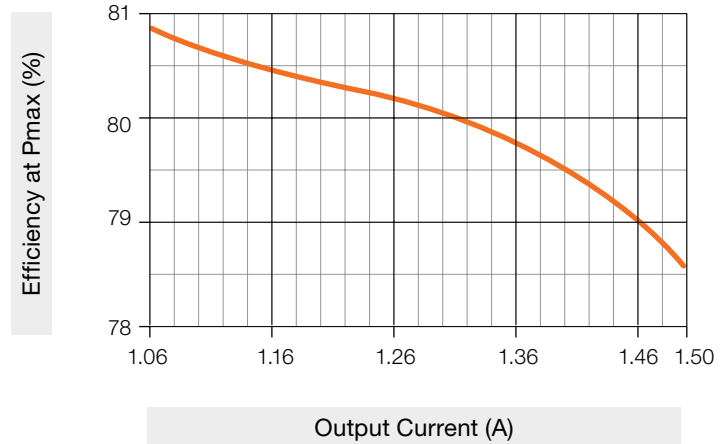

Typical THD vs. Output Power

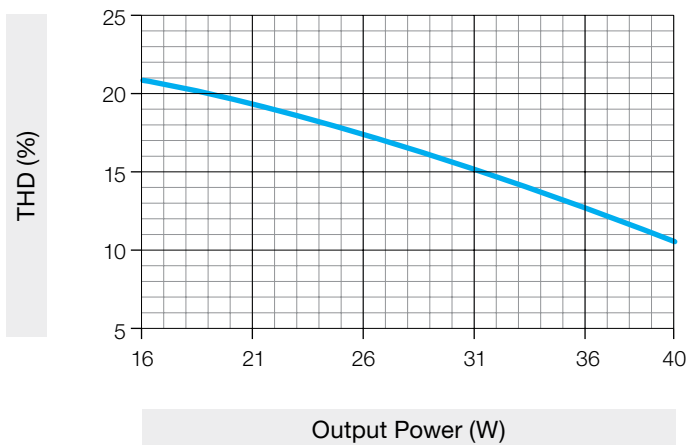

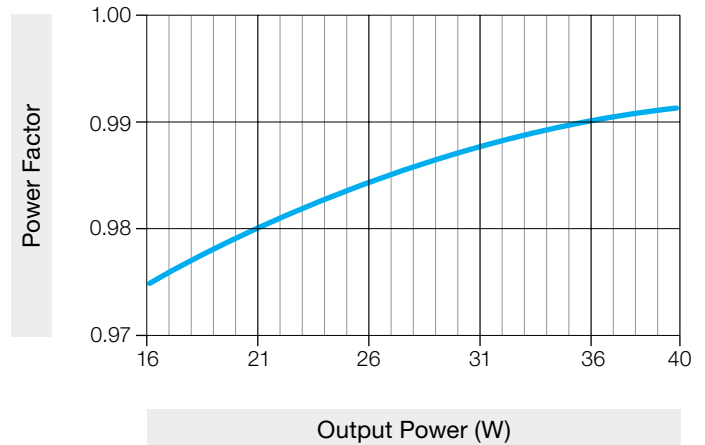

Typical Power Factor vs. Output Power



Job Name:	Model Numbers:
Job Number:	

“M” Output Range, Current Driver Models

Driver Type	Output Dimming Method	Output Voltage	Output Current	Output Power	Standards Recognition	UL® Listed, Remote-Mountable Available	Standards Recognition for UL® Listed, Remote-Mountable
Constant-Current Driver (Class 2)	Pulse Width Modulation (PWM)	8–19.9 V PWM	1.51–2.10 A	12–30 W		Yes	
	Constant-Current Reduction (CCR)	8–19.9 V==					

When using QwikFig technology, these models can be built from the following bulk units in 10 mA increments:

K-case - LTEA4U1UKx-2ABLK*; M-case - LTEA4U1UMN-2ABLK

* x = studded (S) or non-studded (N)

Typical Performance Specifications:

Parameter	Value	Test Conditions
Input Current	330 mA	t _a = 25 °C, 2.10 A 30 W load, Maximum Light Output, K case 120 V~ without a dimmer
Power Factor	0.98	
THD	15%	
Driver Efficiency	75%	

Load Compatibility

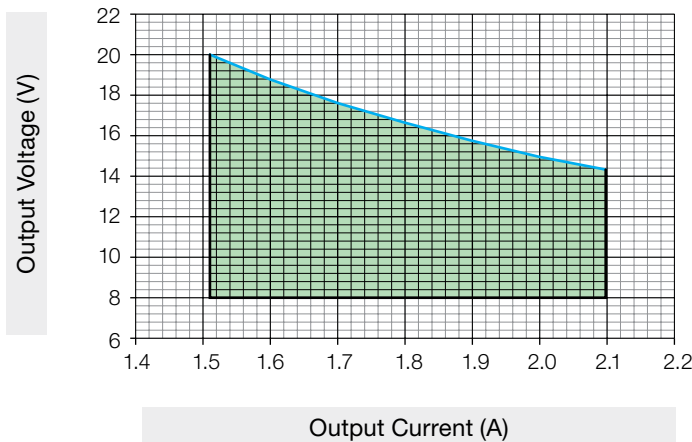

Key:
■ Green area shows California Title 24 and Energy Star 2.0 Compliance
— 30 W limited

Typical Efficiency vs. Output Current

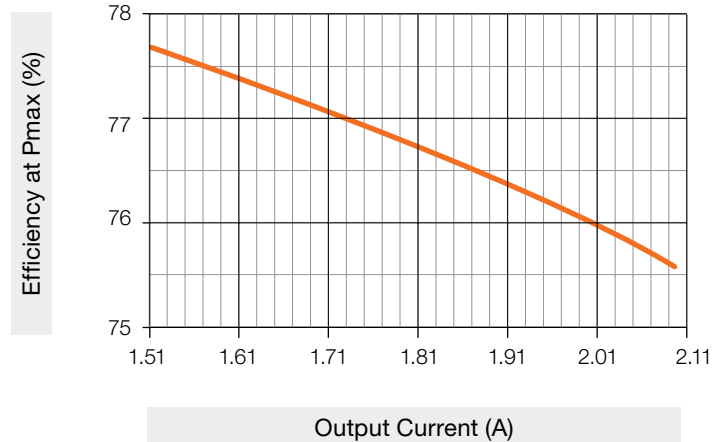

Typical THD vs. Output Power

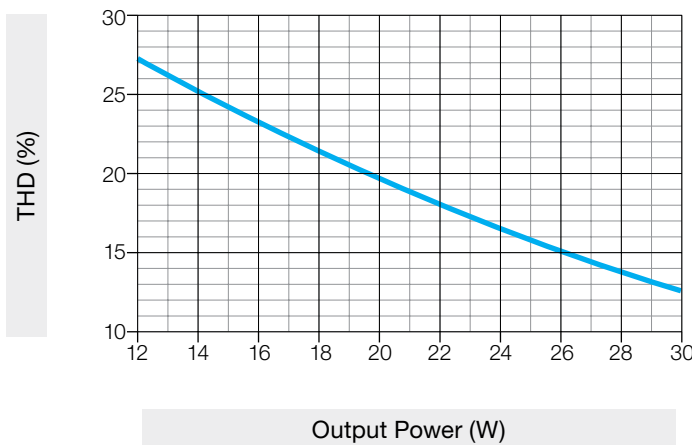

Typical Power Factor vs. Output Power

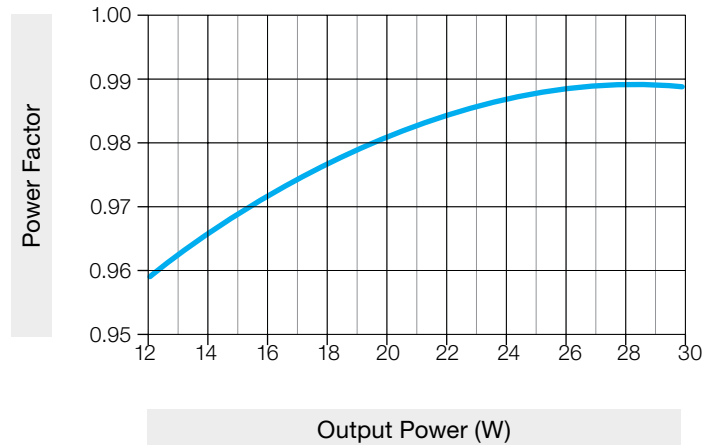

Job Name:	Model Numbers:
Job Number:	

“X” Output Range, Voltage Driver Models

Driver Type	Output Dimming Method	Output Voltage	Output Current	Output Power	Standards Recognition	UL [®] Listed, Remote-Mountable Available
Constant-Voltage Driver (Isolated, Non-Class 2)	Pulse Width Modulation (PWM)	38.5–60.0 V PWM	0.08–1.04 A	5–40 W		No

Typical Performance Specifications:

Parameter	Value	Test Conditions
Input Current	400 mA	$t_a = 25\text{ }^\circ\text{C}$, 60.0 V 40 W load, Maximum Light Output, K case 120 V~ without a dimmer
Power Factor	0.99	
THD	6%	
Driver Efficiency	83%	

Load Compatibility

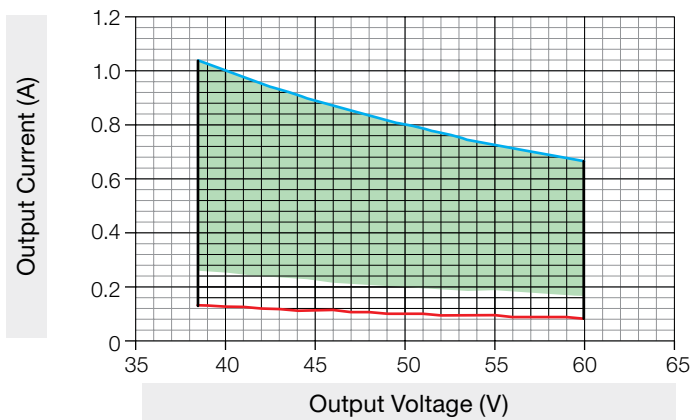

Green area shows California Title 24

Key: — 40 W limited

— 5 W limited

Typical Efficiency vs. Output Voltage

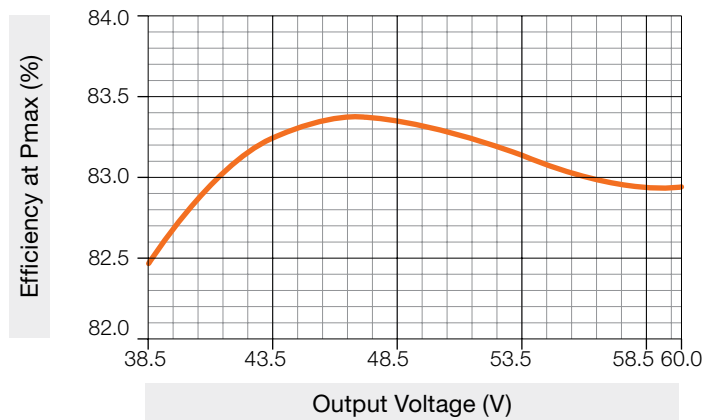

Typical THD vs. Output Power

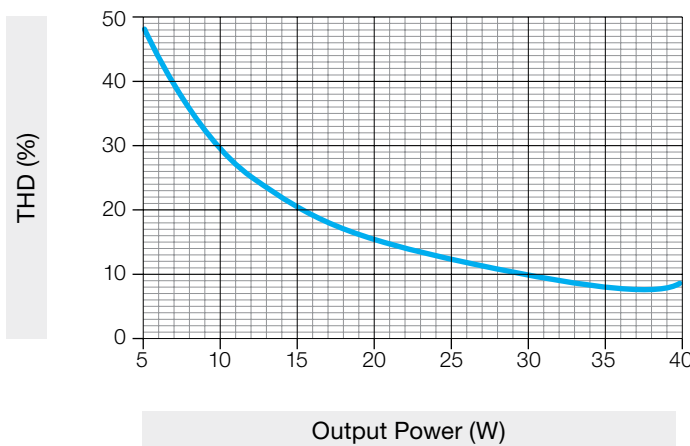

Typical Power Factor vs. Output Power

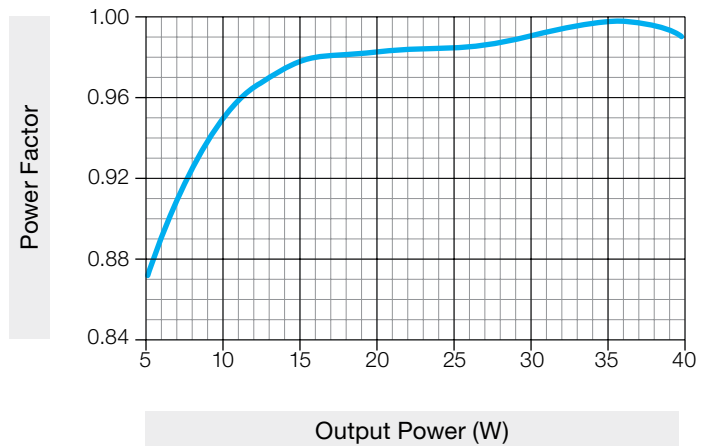

Job Name:	Model Numbers:
Job Number:	

“Y” Output Range, Current Driver Models

Driver Type	Output Dimming Method	Output Voltage	Output Current	Output Power	Standards Recognition	UL® Listed, Remote-Mountable Available
Constant-Current Driver (Isolated, Non-Class 2)	Pulse Width Modulation (PWM)	30–60 V PWM	0.20–0.50 A	6–30 W		No
	Constant-Current Reduction (CCR)	30–60 V==				

When using QwikFig technology, these models can be built from the following bulk units in 10 mA increments:

K-case - LTEA4U1UKx-1ABLK*; **M-case** - LTEA4U1UMN-1ABLK

* x = studded (S) or non-studded (N)

Typical Performance Specifications:

Parameter	Value	Test Conditions
Input Current	310 mA	$t_a = 25\text{ }^\circ\text{C}$, 0.50 A 30 W load, Maximum Light Output, K case 120 V~ without a dimmer
Power Factor	0.99	
THD	10%	
Driver Efficiency	80%	

Load Compatibility

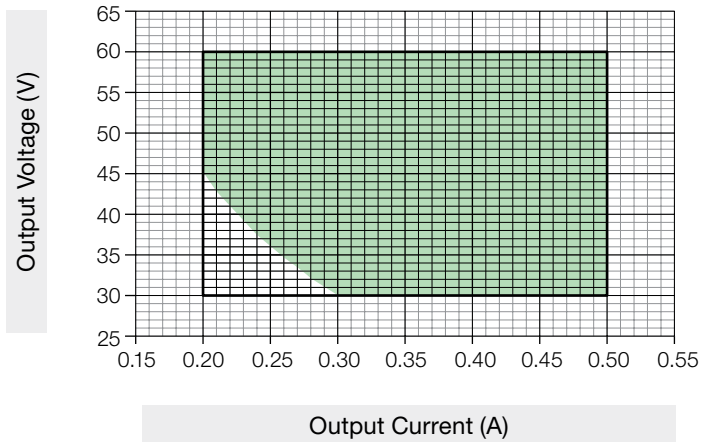

Key: ■ Green area shows California Title 24

Typical Efficiency vs. Output Current

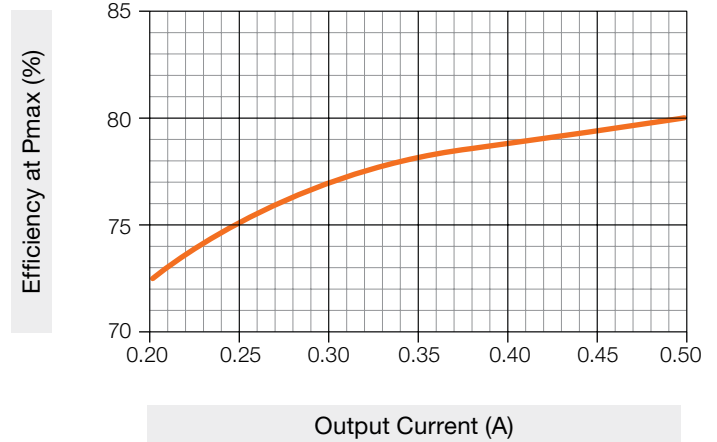

Typical THD vs. Output Power

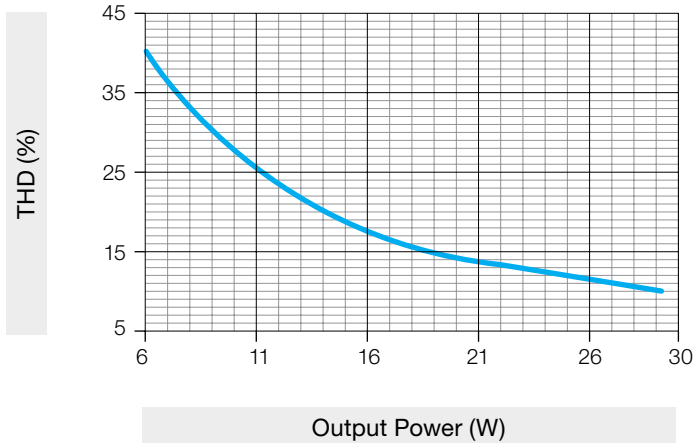

Typical Power Factor vs. Output Power

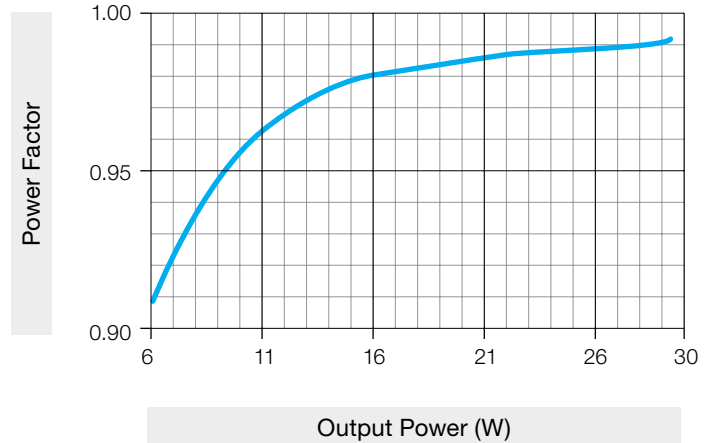

Job Name:	Model Numbers:
Job Number:	

“Z” Output Range, Current Driver Models

Driver Type	Output Dimming Method	Output Voltage	Output Current	Output Power	Standards Recognition	UL® Listed, Remote-Mountable Available
Constant-Current Driver (Isolated, Non-Class 2)	Pulse Width Modulation (PWM)	30–60 V PWM	0.51–1.00 A	16–40 W		No
	Constant-Current Reduction (CCR)	30–60 V==				

When using QwikFig technology, these models can be built from the following bulk units in 10 mA increments:

K-case - LTEA4U1UKx-1ABLK*; M-case - LTEA4U1UMN-1ABLK

* x = studded (S) or non-studded (N)

Typical Performance Specifications:

Parameter	Value	Test Conditions
Input Current	430 mA	$t_a = 25\text{ }^\circ\text{C}$, 1.00 A 40 W load, Maximum Light Output, K case 120 V~ without a dimmer
Power Factor	0.99	
THD	10%	
Driver Efficiency	80%	

Load Compatibility

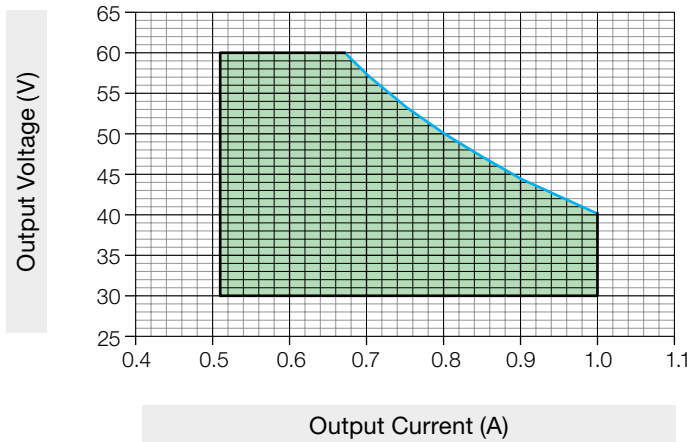

Key:
■ Green area shows California Title 24 and Energy Star 2.0 Compliance
— 40 W limited

Typical Efficiency vs. Output Current

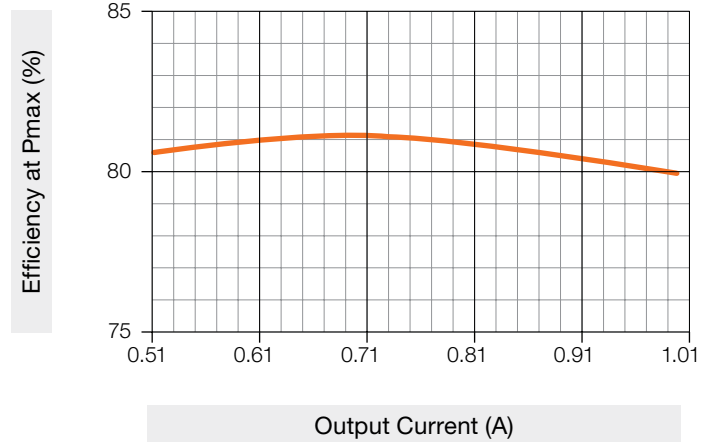

Typical THD vs. Output Power

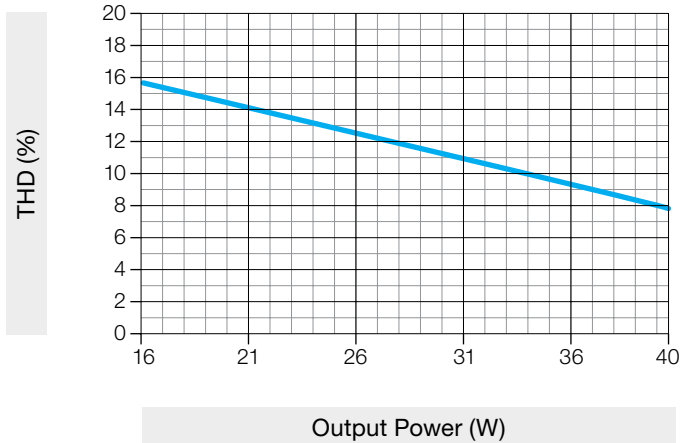

Typical Power Factor vs. Output Power

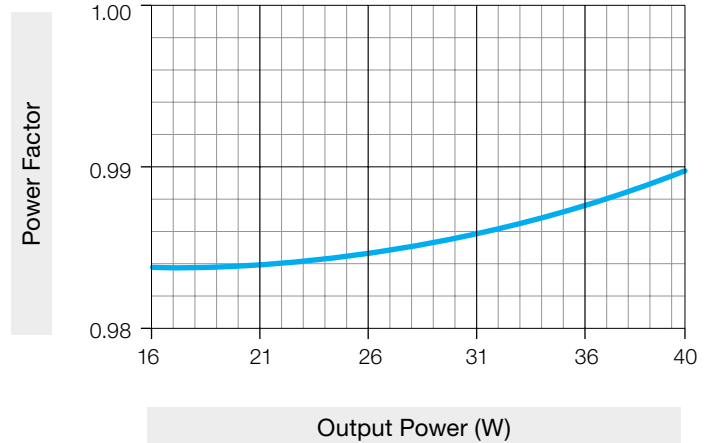

Job Name:	Model Numbers:
Job Number:	

Bulk Model Coverage - K-Case Model Numbers

For use with Lutron QwikFig technology

3ABLK Operation Range:

Bulk Model	Driver Type	Output Dimming Method	Output Voltage	Output Current	Output Power	Standards Recognition
3ABLK	Constant-Current Driver (Class 2)	Constant-Current Reduction (CCR)	30-54 V $\overline{=}$	0.20-1.00 A	6-40 W	

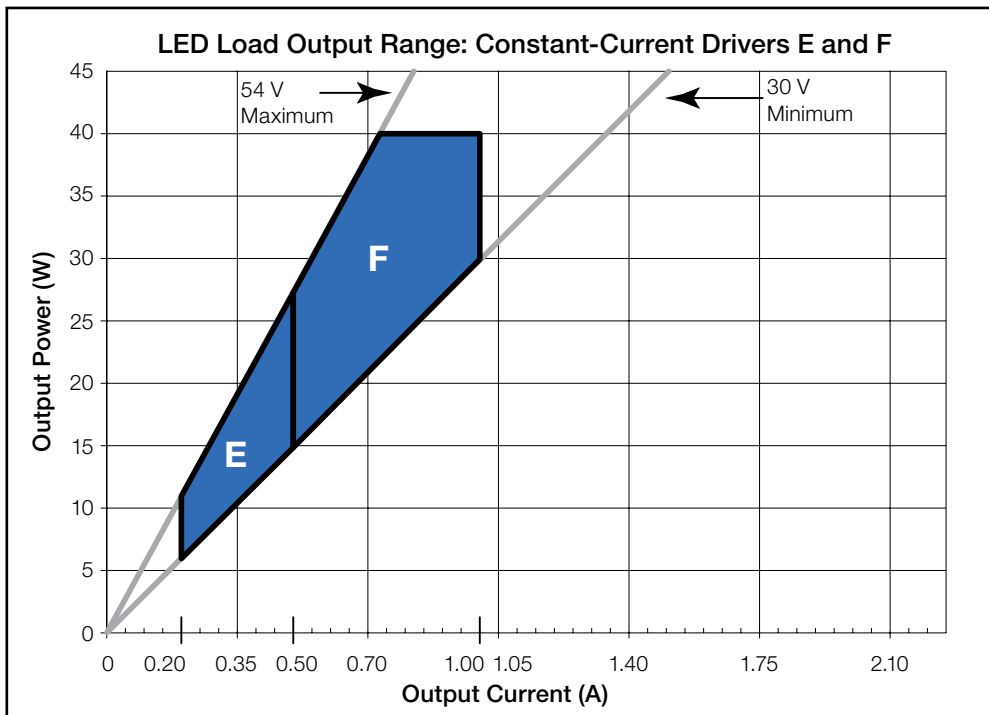



3A = Covers “LED Load Output Range” E and F (CCR dimming only)

Job Name:	Model Numbers:
Job Number:	

Bulk Model Coverage - K-Case Model Numbers (continued)
 For use with Lutron QwikFig technology

2HBLK and 2SBLK Operation Range:

Bulk Model	Driver Type	Output Dimming Method	Output Voltage	Output Current	Output Power	Standards Recognition
2HBLK	Constant-Current Driver (Class 2)	Pulse Width Modulation (PWM)	15–38 V PWM	0.20–0.70 A	3–26.6 W	
		Constant-Current Reduction (CCR)	15–38 V \equiv			
2SBLK	Constant-Current Driver (Class 2)	Pulse Width Modulation (PWM)	15–38 V PWM	0.71–1.50 A	11–40 W	
		Constant-Current Reduction (CCR)	15–38 V \equiv			

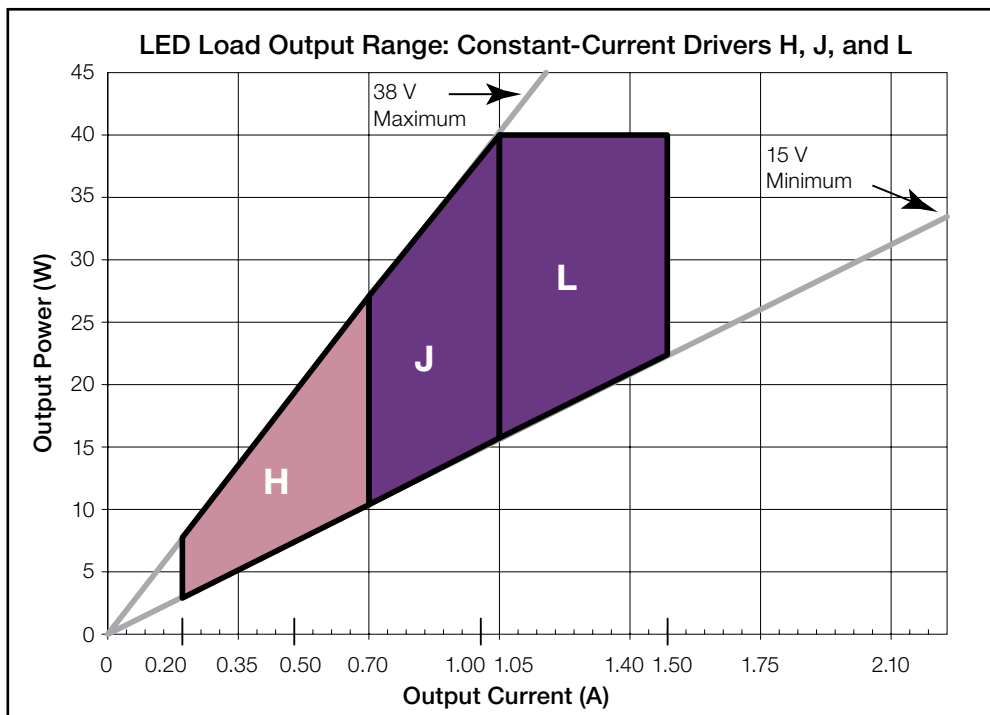



2H = Covers “LED Load Output Range” H
 2S = Covers “LED Load Output Range” J and L

Job Name:	Model Numbers:
Job Number:	

Bulk Model Coverage - K-Case Model Numbers (continued)
 For use with Lutron QwikFig technology

2GBLK, 2RBLK, and 2ABLK Operation Range:

Bulk Model	Driver Type	Output Dimming Method	Output Voltage	Output Current	Output Power	Standards Recognition
2GBLK	Constant-Current Driver (Class 2)	Pulse Width Modulation (PWM)	8–20 V PWM	0.20–0.70 A	2–14 W	
		Constant-Current Reduction (CCR)	8–20 V=			
2RBLK	Constant-Current Driver (Class 2)	Pulse Width Modulation (PWM)	8–20 V PWM	0.71–1.50 A	6–30 W	
		Constant-Current Reduction (CCR)	8–20 V=			
2ABLK	Constant-Current Driver (Class 2)	Pulse Width Modulation (PWM)	8–19.9 V PWM	1.51–2.10 A	12–30 W	
		Constant-Current Reduction (CCR)	8–19.9 V=			

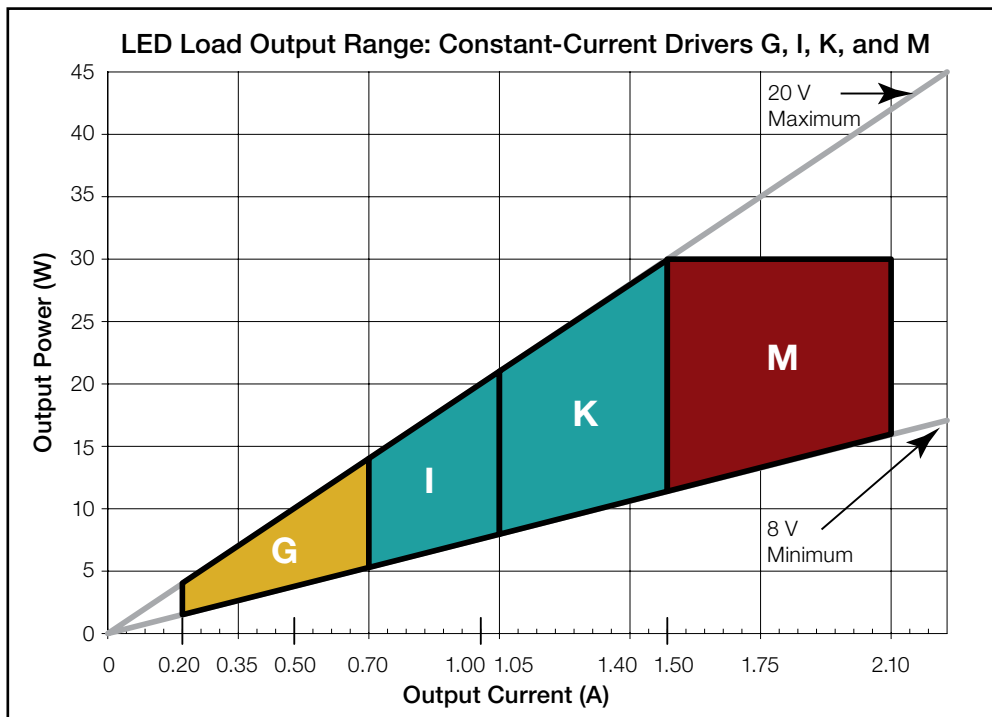

- 2G = Covers “LED Load Output Range” G
- 2R = Covers “LED Load Output Range” I and K
- 2A = Covers “LED Load Output Range” M

Job Name:	Model Numbers:
Job Number:	

Bulk Model Coverage - K-Case Model Numbers (continued)
 For use with Lutron QwikFig technology

1ABLK Operation Range:

Bulk Model	Driver Type	Output Dimming Method	Output Voltage	Output Current	Output Power	Standards Recognition
1ABLK	Constant-Current Driver (Isolated, Non-Class 2)	Pulse Width Modulation (PWM)	30–60 V PWM	0.20–1.00 A	6–40 W	
		Constant-Current Reduction (CCR)	30–60 V _{DC}			

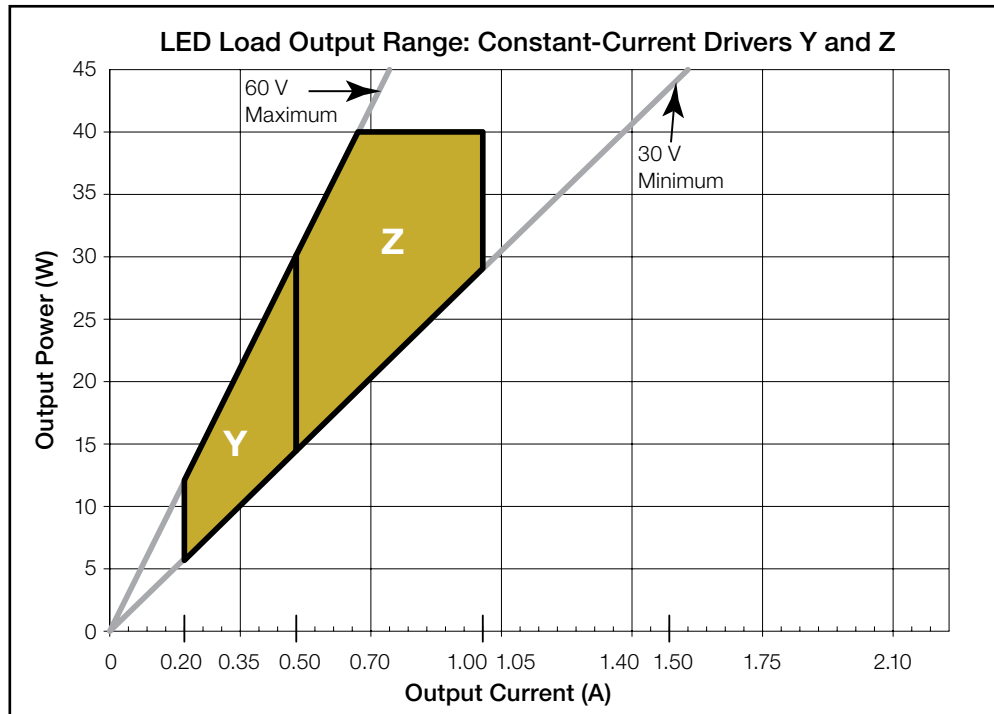

1A = Covers “LED Load Output Range” Y and Z

Job Name:	Model Numbers:
Job Number:	

Bulk Model Coverage - M-Case Model Numbers

For use with Lutron QwikFig technology

3ABLK Operation Range:

Bulk Model	Driver Type	Output Dimming Method	Output Voltage	Output Current	Output Power	Standards Recognition
3ABLK	Constant-Current Driver (Class 2)	Constant-Current Reduction (CCR)	30–54 V _{DC}	0.20–1.00 A	6–40 W	

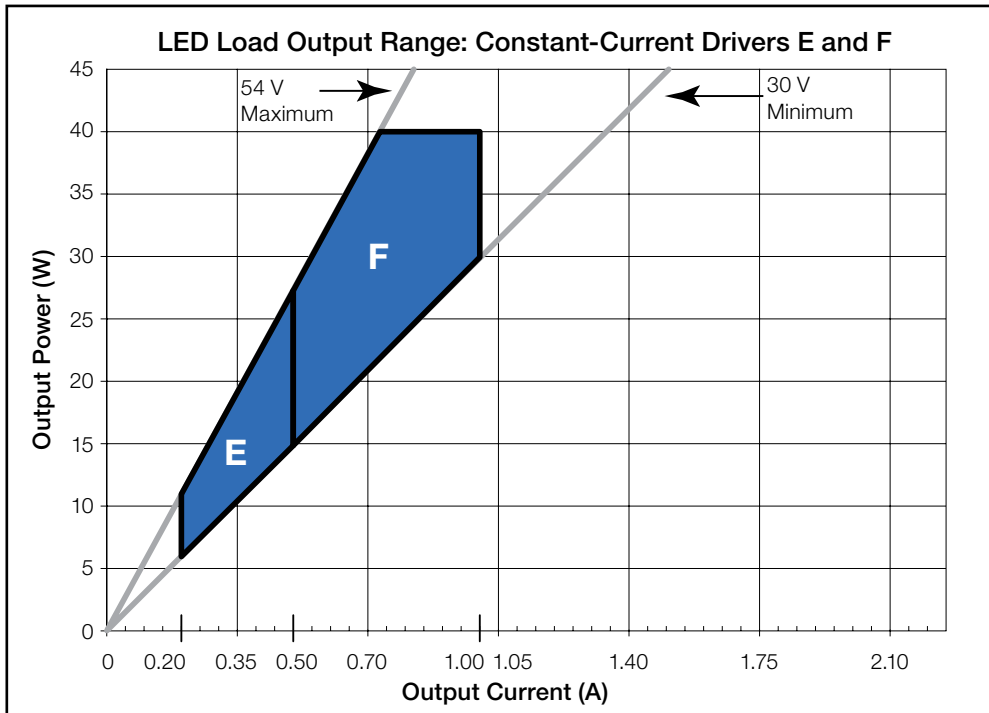

3A = Covers “LED Load Output Range” E and F (CCR dimming only)

Job Name:	Model Numbers:
Job Number:	

Bulk Model Coverage - M-Case Model Numbers (continued)
 For use with Lutron QwikFig technology

2BBLK Operation Range:

Bulk Model	Driver Type	Output Dimming Method	Output Voltage	Output Current	Output Power	Standards Recognition
2BBLK	Constant-Current Driver (Class 2)	Pulse Width Modulation (PWM)	15–38 V PWM	0.20–1.50 A	3–40 W	
		Constant-Current Reduction (CCR)	15–38 V \equiv			

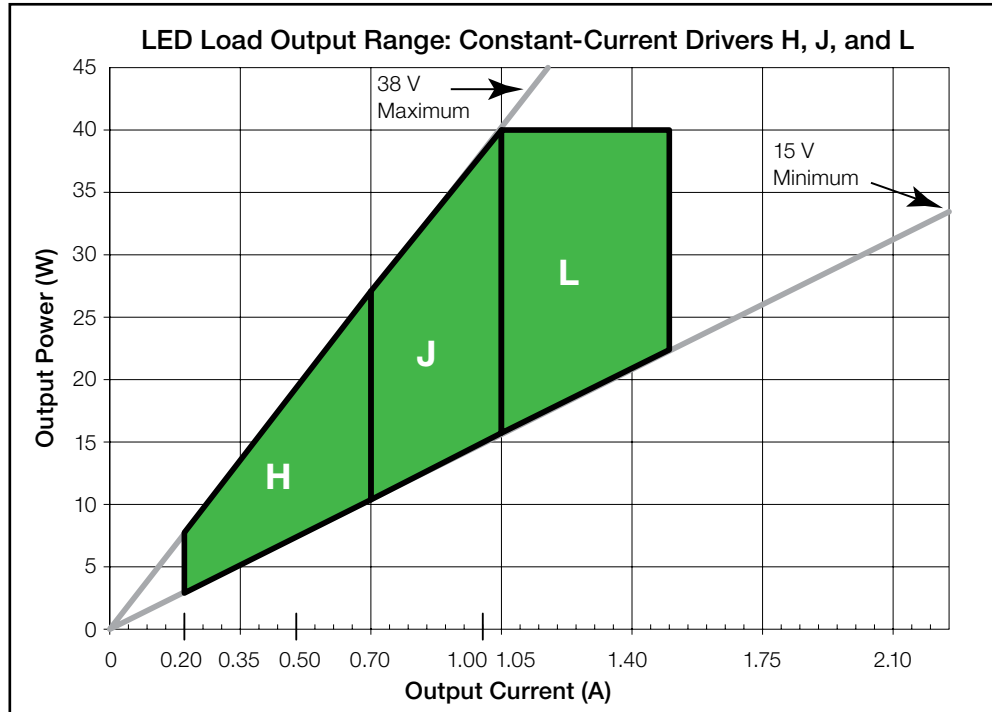



2B = Covers “LED Load Output Range” H, J, and L

Job Name:	Model Numbers:
Job Number:	

Bulk Model Coverage - M-Case Model Numbers (continued)
 For use with Lutron QwikFig technology

2CBLK and 2ABLK Operation Range:

Bulk Model	Driver Type	Output Dimming Method	Output Voltage	Output Current	Output Power	Standards Recognition
2CBLK	Constant-Current Driver (Class 2)	Pulse Width Modulation (PWM)	8–20 V PWM	0.20–1.50 A	2–30 W	
		Constant-Current Reduction (CCR)	8–20 V ⁻⁻⁻			
2ABLK	Constant-Current Driver (Class 2)	Pulse Width Modulation (PWM)	8–19.9 V PWM	1.51–2.10 A	12–30 W	
		Constant-Current Reduction (CCR)	8–19.9 V ⁻⁻⁻			

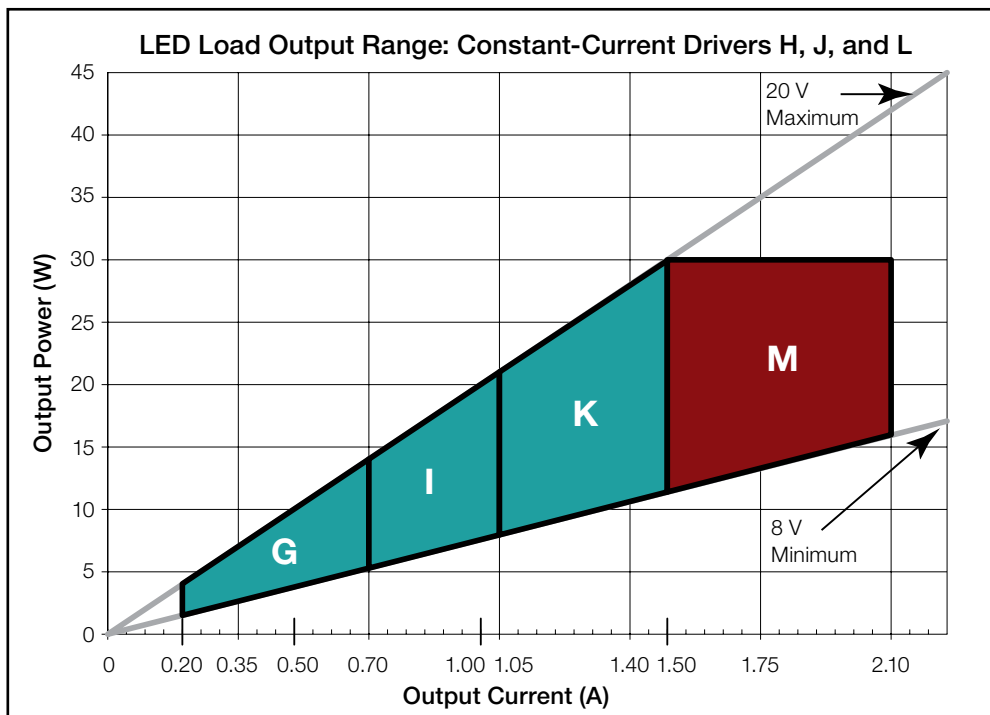

2C = Covers “LED Load Output Range” G, I, and K

2A = Covers “LED Load Output Range” M

Job Name:	Model Numbers:
Job Number:	

Bulk Model Coverage - M-Case Model Numbers (continued)
 For use with Lutron QwikFig technology

1ABLK Operation Range:

Bulk Model	Driver Type	Output Dimming Method	Output Voltage	Output Current	Output Power	Standards Recognition
1ABLK	Constant-Current Driver (Isolated, Non-Class 2)	Pulse Width Modulation (PWM)	30–60 V PWM	0.20–1.00 A	6–40 W	
		Constant-Current Reduction (CCR)	30–60 V=			

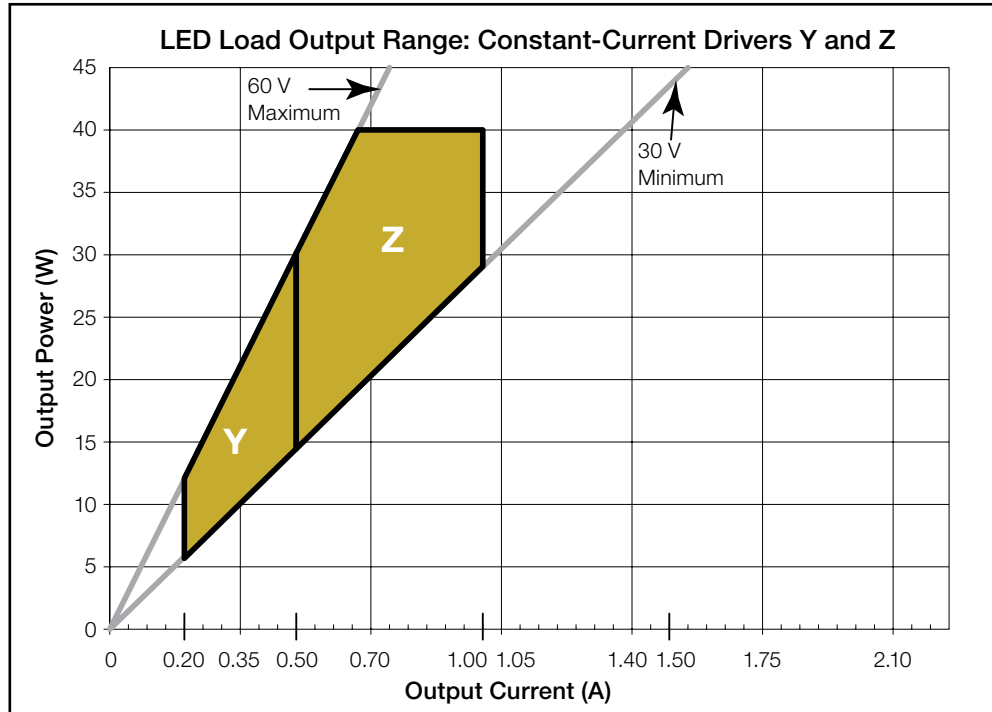

1A = Covers “LED Load Output Range” Y and Z

Job Name:	Model Numbers:
Job Number:	

K Case: Case Dimensions

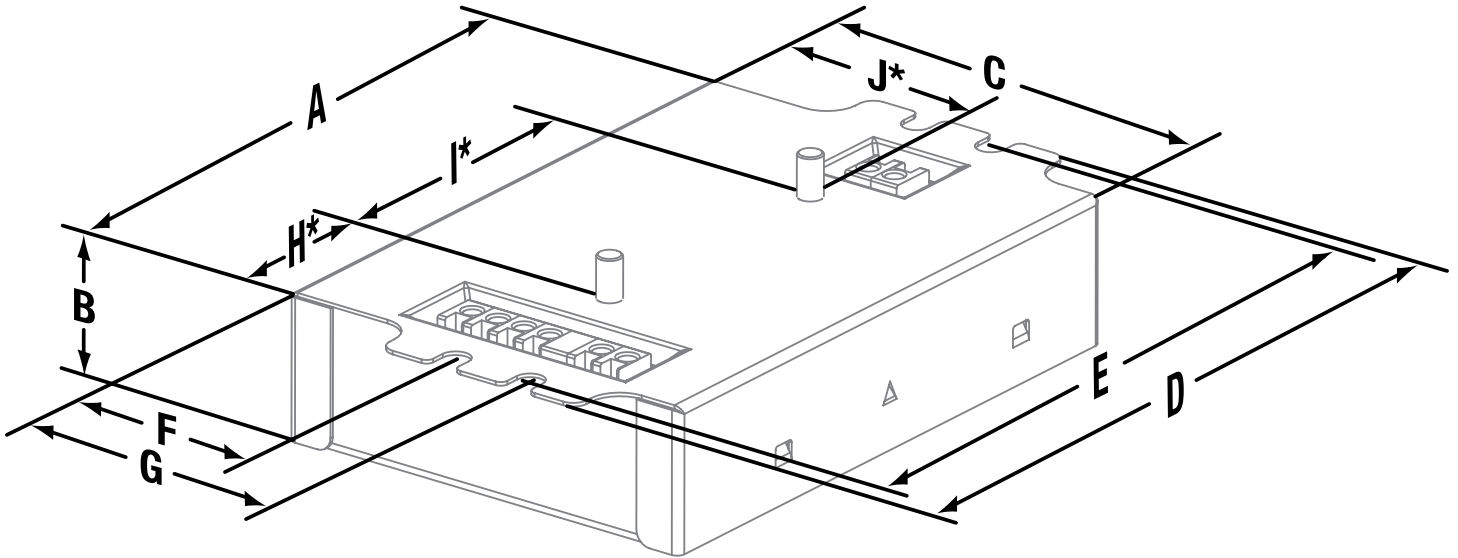

K Case: Connector Location Dimensions

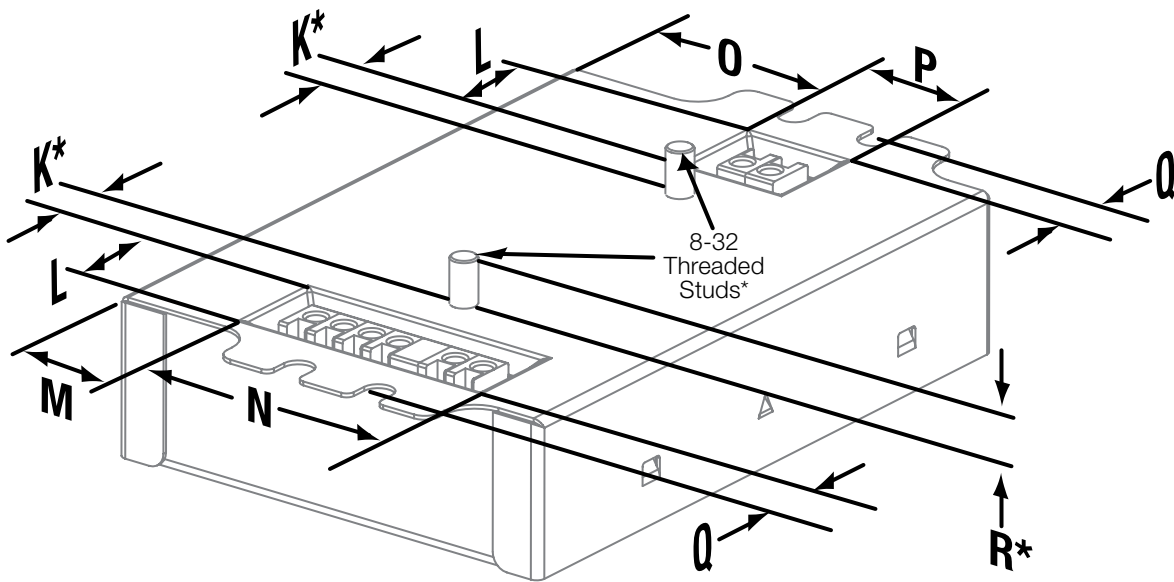

A	4.20 in (107 mm)	F	1.42 in (36 mm)	K*	0.33 in (8.3 mm)	P	0.74 in (19 mm)
B	1.00 in (25 mm)	G	1.99 in (51 mm)	L	0.65 in (16.5 mm)	Q	0.32 in (8 mm)
C	3.00 in (76 mm)	H*	1.11 in (28 mm)	M	0.75 in (19 mm)	R*	0.29 in (7 mm)
D	4.90 in (124 mm)	I*	2.00 in (51 mm)	N	1.73 in (44 mm)		
E	4.60 in (117 mm) (mounting center)	J*	1.60 in (41 mm)	O	1.33 in (34 mm)		

* Applies to studded K case only.

Job Name:	Model Numbers:
Job Number:	

K Case: Side Entry Connector Location Dimensions (Non-Studded)

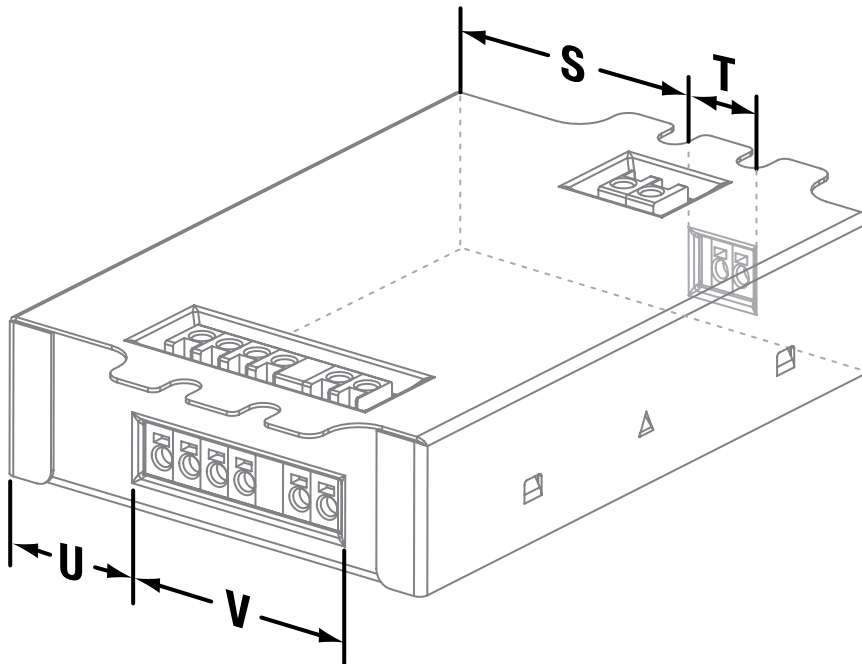

- S 1.38 in (35 mm)
- T 0.64 in (16 mm)
- U 0.88 in (22 mm)
- V 1.53 in (39 mm)

M Case: Case Dimensions

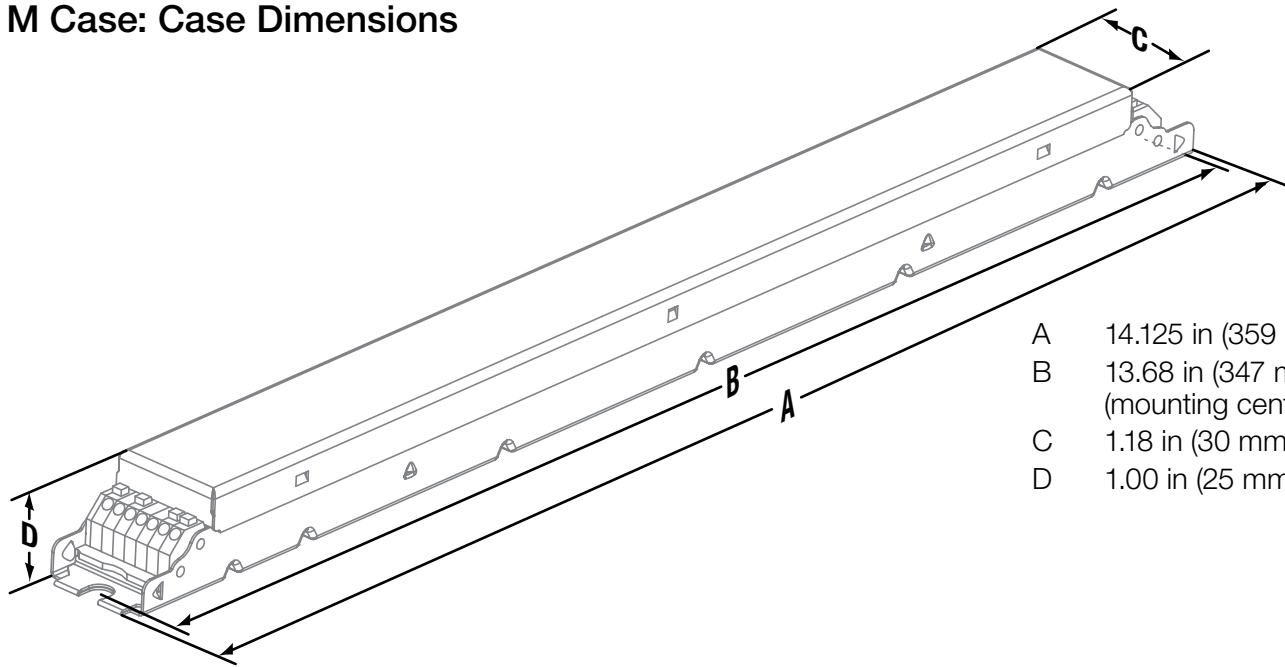

- A 14.125 in (359 mm)
- B 13.68 in (347 mm)
(mounting center)
- C 1.18 in (30 mm)
- D 1.00 in (25 mm)

Job Name:	Model Numbers:
Job Number:	

UL® Listed, Remote-Mountable: Case Dimensions

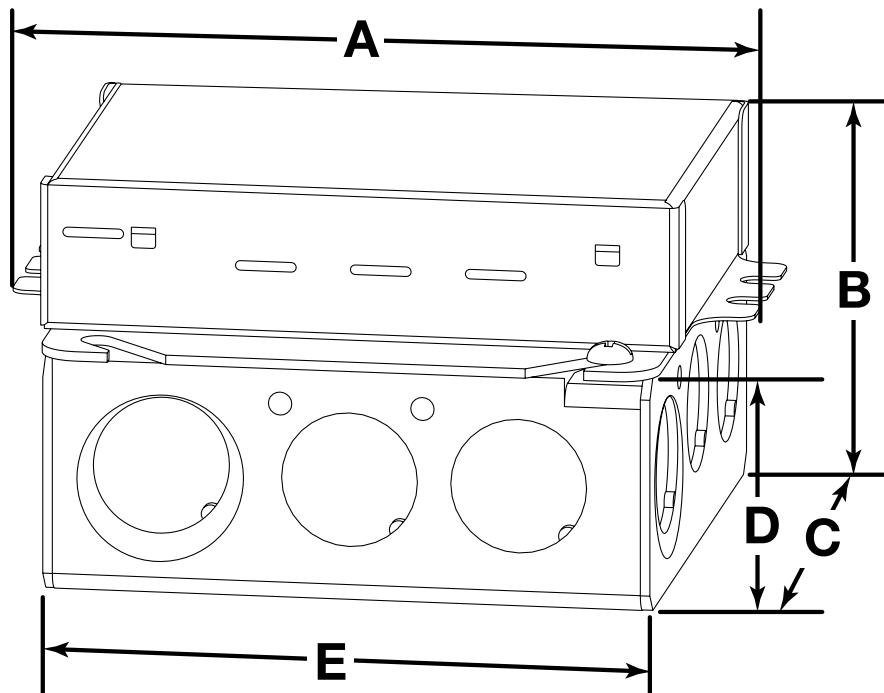

A	4.89 in (124 mm)
B	2.62 in (66 mm)
C	4.00 in (102 mm)
D	1.62 in (41 mm)
E	4.00 in (102 mm)

KL case includes a 4 in (102 mm) square junction box which complies with NEMA OS 1-2008 Figure 112.

Knockouts

- Sides
 - 8 locations: 0.5 in (13 mm)
 - 4 locations: 0.5/0.75 in (13/19 mm)
- Bottom
 - 2 locations: 0.5 in (13 mm)
 - 2 locations: 0.5/0.75 in (13/19 mm)

Driver Wiring and Mounting

- Driver is grounded by the green ground wire connection on the enclosure or by the ground lug terminal in the junction box
- Driver and junction box must be grounded in accordance with local and national electrical codes
- All wire connections must be made in the junction box to maintain UL® listing
- 4 in (102 mm) square junction box is 1.5 in (38 mm) deep with 22.0 in³ (360.5 cm³) capacity and complies with NEMA OS 1-2008 Figure 112
- Driver is pre-wired with 6 in (152 mm), 18 AWG (0.75 mm²) solid copper leads in all terminal blocks

Job Name:	Model Numbers:
Job Number:	

UL® Marking and Compatibility

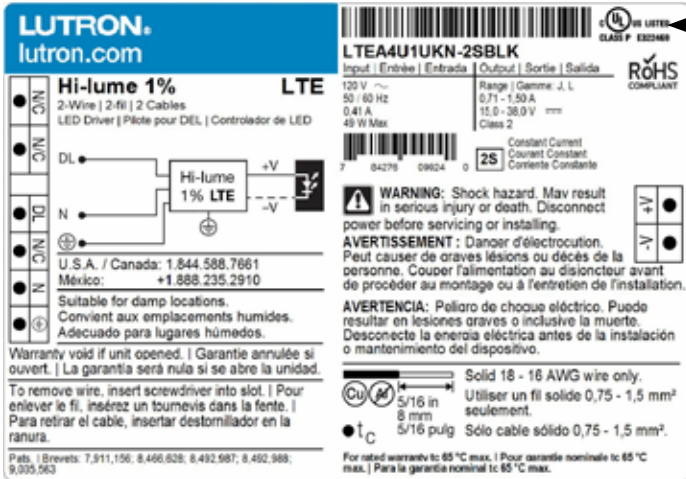

Location of the standards mark on the driver.



Drivers marked as UL® recognized are ONLY compatible with those controls marked with an asterisk (*) on the following pages.



Drivers marked as UL® Listed Class P are compatible with all controls referenced on the following pages.



Drivers marked as UL® 8750 Listed and manufactured before November 20, 2017, are ONLY compatible with those controls marked with an asterisk (*) on the following pages. Date code on the driver is in international date format, DD/MM/YYYY.

Note: If the fixture or driver is not accessible and the standards marking is unknown, use controls marked with an asterisk (*).

Wiring

Controls Requiring Neutral

Note: Colors shown correspond to terminals on driver.

Wiring Diagram

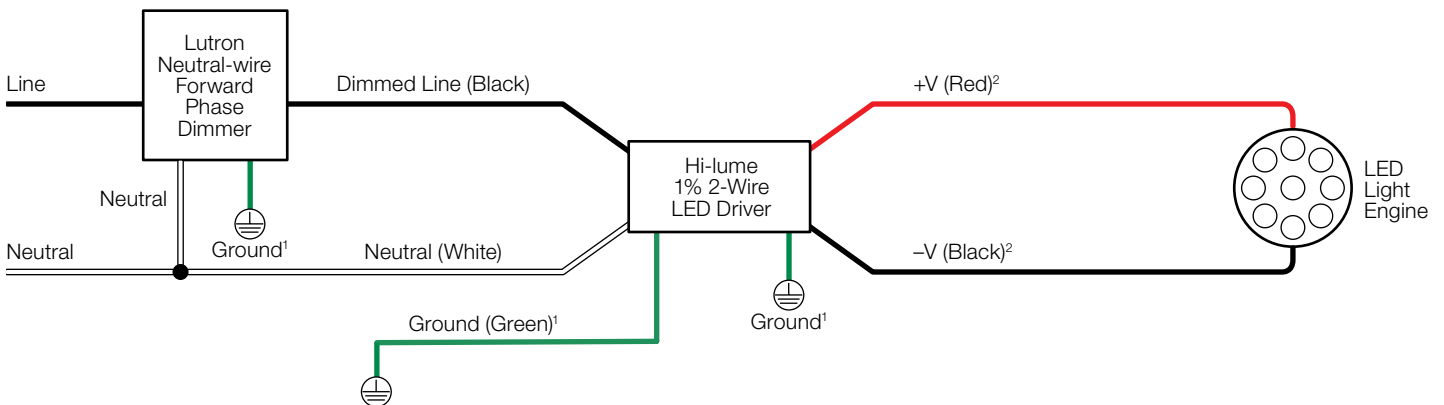

¹Ground wire connection available on K case models only. Fixture and driver case must be grounded in accordance with local and national electrical codes.

²For maximum driver-to-LED light engine wire length, see charts in **Driver Leads** section at the end of the document.

Job Name:	Model Numbers:
Job Number:	

Wiring (continued)

Controls Requiring Neutral (continued)

Compatible Controls: Lutron Neutral-wire Dimmers

Guaranteed performance specifications with the controls listed in the chart below.

For assistance selecting controls, contact our LED Center of Excellence at 1.877.DIM.LED8 or LEDs@lutron.com

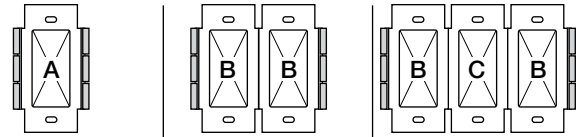

Product	Part Number	Low-End Setting/ Load-Type Setting ¹	Drivers per Control		
			A: Not Ganged	B: End of Gang	C: Middle of Gang
RadioRA 2 adaptive dimmer*	RRD-6NA-	Hi-lume 1% 2-Wire LTE LED ²	1–10, 400 W max	1–10, 400 W max	1–10, 400 W max
RA2 Select/RadioRA 2 600 W dimmer	RRD-6ND	Hi-lume 1% 2-Wire LTE LED ²	1–8, 350 W max	1–8, 350 W max	1–8, 350 W max
RadioRA 2 1000 W dimmer*	RRD-10ND-	Set Device type to “INC/MLV Neutral Dimmer”; Set High-End Trim to 99%; Set Low-End Trim to 35%	1–13	1–13	1–13
RadioRA 2 Architectural RF GRAFIK T phase selectable dimmer	RRT-G5NEW-	Trim low-end per APM App Note (Lutron P/N 048534)	1–10, 400 W max	1–10, 400 W max	1–10, 400 W max
RadioRA 2 Architectural RF GRAFIK T dimmer	RRT-G25LW-	Trim low-end per APM App Note (Lutron P/N 048534)	1–10, 400 W max	1–10, 400 W max	1–10, 400 W max
RadioRA 2 C•L hybrid seeTouch keypad	RRD-HN	Hi-lume 1% 2-Wire LTE LED	1–10, 200 W max	1–10, 200 W max	1–10, 200 W max
RadioRA 2 GRAFIK T C•L hybrid keypad	RRT-GH	Hi-lume 1% 2-Wire LTE LED	1–10, 400 W max	1–10, 400 W max	1–10, 400 W max
HomeWorks QS adaptive dimmer*	HQRD-6NA-	Hi-lume 1% 2-Wire LTE LED ²	1–10, 400 W max	1–10, 400 W max	1–10, 400 W max
HomeWorks QS 600 W dimmer*	HQRD-6ND-	Hi-lume 1% 2-Wire LTE LED ²	1–8, 350 W max	1–8, 350 W max	1–8, 350 W max
HomeWorks QS 1000 W dimmer*	HQRD-10ND-	Hi-lume 1% 2-Wire LTE LED ²	1–13	1–13	1–13
Maestro Wireless 600 W dimmer*	MRF2-6ND-120-	Trim low-end per APM App Note (Lutron P/N 048370)	1–8, 350 W max	1–8, 350 W max	1–8, 350 W max
Vive Maestro Wireless 600 W dimmer*	MRF2S-6ND-120-	Trim low-end per APM App Note (Lutron P/N 048370)	1–8, 350 W max	1–8, 350 W max	1–8, 350 W max
HomeWorks QS GRAFIK T hybrid keypad	HQRT-GH	Hi-lume 1% 2-Wire LTE LED	1–10, 400 W max	1–10, 400 W max	1–10, 400 W max
HomeWorks QS Architectural GRAFIK T dimmer	HQRT-G25LW-	Hi-lume 1% 2-Wire LTE LED	1–10, 400 W max	1–10, 400 W max	1–10, 400 W max
HomeWorks QS Architectural GRAFIK T phase selectable dimmer	HQRT-G5NEW-	Hi-lume 1% 2-Wire LTE LED	1–10, 400 W max	1–10, 400 W max	1–10, 400 W max
HomeWorks QS designer C•L hybrid seeTouch keypad	HQRD-HN	Hi-lume 1% 2-Wire LTE LED	1–10, 200 W max	1–10, 200 W max	1–10, 200 W max
GRAFIK T C•L 250 W dimmer*	GT-250M-, GTJ-250M-	Set low-end trim per dimmer installation instructions	1–10, 400 W max	1–10, 400 W max	1–10, 400 W max
Caséta Wireless Pro 1000 W dimmer*	PD-10NXD-	Trim low-end per instructions at www.casetawireless.com/lowend	1–13	1–13	1–13
Caséta Wireless phase selectable dimmer	PD-5NE-	Trim low-end per instructions at www.casetawireless.com/lowend	1–20, 400 W max	1–20, 400 W max	1–20, 400 W max

Note: All wattages are in terms of input wattage to the LED driver.

* See note on page 35 for control compatibility.

¹ Setting the low-end trim and load type is necessary to ensure optimal performance and 1% dimming capability.

Note: For information about Legacy Product use in existing control application, contact LEDs@lutron.com

² Also listed as “LED Lutron A-Series 2-Wire” or “Hi-lume A-Series LTE LED Driver 2-Wire” in previous software releases.

Job Name:	Model Numbers:
Job Number:	

Wiring (continued)**Controls Requiring Neutral** (continued)

Note: Colors shown correspond to terminals on driver.

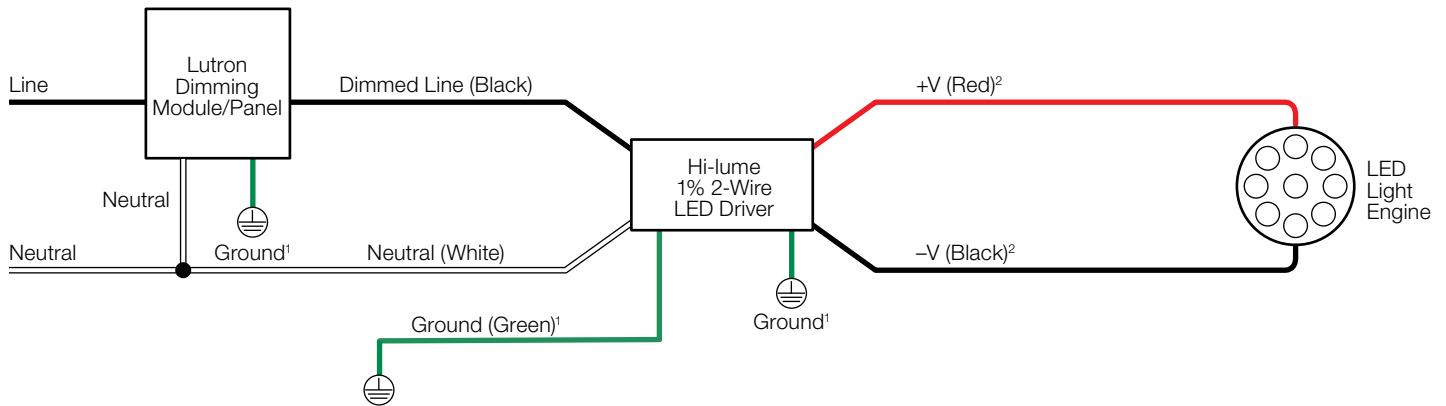
Wiring Diagram

¹ Ground wire connection available on K case models only. Fixture and driver case must be grounded in accordance with local and national electrical codes.

² For maximum driver-to-LED light engine wire length, see charts in **Driver Leads** section at the end of the document.

Compatible Controls: Lutron Dimming Modules/Panels

Guaranteed performance specifications with the controls listed in the chart below.

For assistance selecting controls, contact our LED Center of Excellence at 1.877.DIM.LED8 or LEDs@lutron.com

Product	Part Number	Drivers per Control	Low-End Setting/Load-Type Setting ¹
myRoom DIN power module*	MQSE-4A1-D	1–6 (per output); 1 A maximum driver input current	Hi-lume 1% 2-Wire LTE LED ²
HomeWorks QS DIN power module*	LQSE-4A1-D	1–6 (per output); 1 A maximum driver input current	Hi-lume 1% 2-Wire LTE LED ²
HomeWorks QS Phase Adaptive DIN power module	LQSE-4A-120-D	1–6 (per output); 2 A maximum driver input current	Hi-lume 1% 2-Wire LTE LED ²
HomeWorks QS wallbox power module*	HQRJ-WPM-6D-120	2–10 (per output); 26 total per module	Hi-lume 1% 2-Wire LTE LED ²
HomeWorks wallbox power module*	HWI-WPM-6D-120	2–10 (per output); 26 total per module	Set load type to “GRX-FDBI” or “GRX-TVI”
GRAFIK Eye QS control unit*	QSGR-, QSGRJ-	2–10 (per output); 26 total per unit	Set load type to “Fluorescent Module”
GRAFIK Eye 3000 control unit*	GRX-3100-, GRX-3500-	2–10 (per output); 26 total per module	Set load type to “GRX-FDBI” or “GRX-TVI”
RPM-4U module (LCP, HomeWorks QS, GRAFIK Systems, Quantum)*	HW-RPM-4U-120, LP-RPM-4U-120	2–26 (per output); 26 total per module	Hi-lume 1% 2-Wire LTE LED ² Set load type to “2-1”
RPM-4A module (LCP, HomeWorks QS, GRAFIK Systems, Quantum)*	HW-RPM-4A-120, LP-RPM-4A-120	1–13 (per output); 26 total per module	Hi-lume 1% 2-Wire LTE LED ² Set load type to “2-1”
GP dimming panels*	Various	1–26	Set load type to “2-1”

* See note on page 35 for control compatibility.

¹ Setting the low-end trim and load type is necessary to ensure optimal performance and 1% dimming capability.

² Also listed as “LED Lutron A-Series 2-Wire” or “Hi-lume A-Series LTE LED Driver 2-Wire” in previous software releases.

Job Name:	Model Numbers:
Job Number:	

Wiring (continued)

Controls Not Requiring Neutral

Note: Colors shown correspond to terminals on driver.

Wiring Diagram

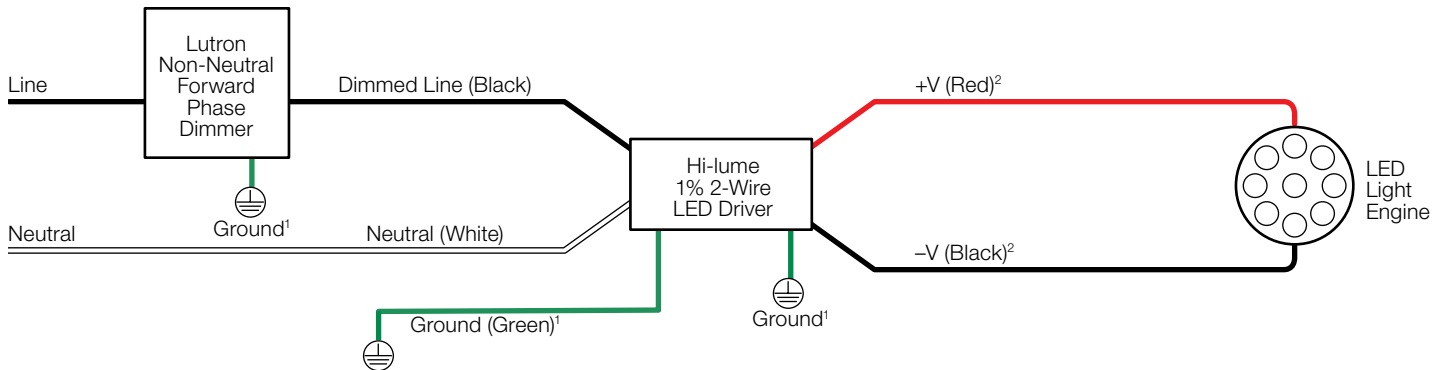

¹ Ground wire connection available on K case models only. Fixture and driver case must be grounded in accordance with local and national electrical codes.

² For maximum driver-to-LED light engine wire length, see charts in **Driver Leads** section at the end of the document.

Compatible Controls: Lutron Non-Neutral Dimmers

Guaranteed performance specifications with the controls listed in the chart below.

For assistance selecting controls, contact our LED Center of Excellence at 1.877.DIM.LED8 or LEDs@lutron.com

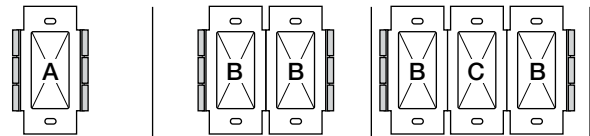

Product	Part Number	Low-End Setting/Load-Type Setting ¹	Drivers per Control		
			A: Not Ganged	B: End of Gang	C: Middle of Gang
Ariadni C•L 250 W dimmer*	AYCL-253P-	Set low-end trim dial to 1 o'clock. Adjust slightly if needed. See dimmer installation instructions on how to adjust low-end trim.	1-8, 350 W max	1-8, 350 W max	1-8, 350 W max
Ariadni C•L 150 W dimmer	TGCL-153P, AYCL-153P-	Set low-end trim dial to 1 o'clock. Adjust slightly if needed. See dimmer installation instructions on how to adjust low-end trim.	1-6, 250 W max	1-6, 250 W max	1-6, 250 W max
Diva C•L 250 W dimmer*	DVCL-253P- DVSCCL-253P-	Set low-end trim dial to 10 o'clock. Adjust slightly if needed. See dimmer installation instructions on how to adjust low-end trim.	1-8, 350 W max	1-8, 350 W max	1-8, 350 W max
Diva C•L 150 W dimmer	DVCL-153P-, DVSCCL-153P-	Set low-end trim dial to 10 o'clock. Adjust slightly if needed. See dimmer installation instructions on how to adjust low-end trim.	1-6, 250 W max	1-6, 250 W max	1-6, 250 W max
Nova T★ C•L 250 W dimmer*	NTCL-250-	Set low-end trim dial to 10 o'clock. Adjust slightly if needed. See dimmer installation instructions on how to adjust low-end trim.	1-10, 400 W max	1-10, 400 W max	1-10, 400 W max
Lumea C•L 150 W dimmer	LECL-153P-	Set low-end trim dial to 10 o'clock. Adjust slightly if needed. See dimmer installation instructions on how to adjust low-end trim.	1-6, 250 W max	1-6, 250 W max	1-6, 250 W max
Skylark C•L 150 W dimmer	SCL-153P-	Set low-end trim dial to 10 o'clock. Adjust slightly if needed. See dimmer installation instructions on how to adjust low-end trim.	1-6, 250 W max	1-6, 250 W max	1-6, 250 W max
Contour C•L 150 W dimmer	CTCL-153P-	Set low-end trim dial to 10 o'clock. Adjust slightly if needed. See dimmer installation instructions on how to adjust low-end trim.	1-6, 250 W max	1-6, 250 W max	1-6, 250 W max

Note: All wattages are in terms of input wattage to the LED driver.

* See note on page 35 for control compatibility.

¹ Setting the low-end trim and load type is necessary to ensure optimal performance and 1% dimming capability.

Note: For information about Legacy Product use in existing control application, contact LEDs@lutron.com

LUTRON SPECIFICATION SUBMITTAL

Page

Job Name:	Model Numbers:
Job Number:	

Wiring (continued)

Controls Not Requiring Neutral (continued)

Compatible Controls: Lutron Non-Neutral Dimmers

Guaranteed performance specifications with the controls listed in the chart below.

For assistance selecting controls, contact our LED Center of Excellence at 1.877.DIM.LED8 or LEDs@lutron.com

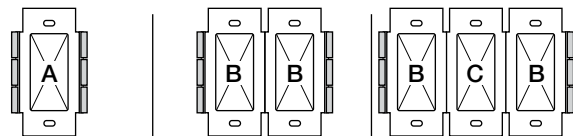

Product	Part Number	Low-End Setting/Load-Type Setting ¹	Drivers per Control		
			A: Not Ganged	B: End of Gang	C: Middle of Gang
Maestro C•L 150 W dimmer	MACL-153M-	Trim low-end per APM App Note (Lutron P/N 048370)	1–6, 250 W max	1–6, 250 W max	1–6, 250 W max
Maestro C•L 150 W sensor	MSCL-OP153M-, MSCL-VP153M-	Trim low-end per APM App Note (Lutron P/N 048370)	1–6, 250 W max	1–6, 250 W max	1–6, 250 W max
Vive Maestro C•L 150 W dimmer	MRF2S-6CL-	Trim low-end per APM App Note (Lutron P/N 048370)	1–6, 250 W max	1–6, 250 W max	1–6, 250 W max
GRAFIK T C•L 150 W dimmer	GTJ-150-	Set low-end trim per dimmer installation instructions	1–6, 250 W max	1–6, 250 W max	1–6, 250 W max
Maestro Wireless C•L 150 W dimmer	MRF2-6CL-	Trim low-end per APM App Note (Lutron P/N 048370)	1–6, 250 W max	1–6, 250 W max	1–6, 250 W max
RadioRA 2 C•L 150 W dimmer	RRD-6CL-	Set low-end trim per dimmer installation instructions	1–6, 250 W max	1–6, 250 W max	1–6, 250 W max
HomeWorks QS Designer C•L 150 W dimmer	HQRD-6CL-	Hi-lume 1% 2-Wire LTE LED	1–6, 250 W max	1–6, 250 W max	1–6, 250 W max
Caséta Wireless C•L Dimmer	PD-6WCL-	Trim low-end per instructions at www.casetawireless.com/lowend	1–6, 250 W max	1–6, 250 W max	1–6, 250 W max
RadioRA 2 Architectural RF GRAFIK T dimmer ²	RRT-G25LW-	Trim low-end per APM App Note (Lutron P/N 048534)	1–10, 400 W max	1–10, 400 W max	1–10, 400 W max
HomeWorks QS Architectural GRAFIK T dimmer ²	HQRT-G25LW-	Hi-lume 1% 2-Wire LTE LED	1–10, 400 W max	1–10, 400 W max	1–10, 400 W max
GRAFIK T C•L 250 W dimmer ^{* 2}	GT-250M-, GTJ-250M-	Set low-end trim per dimmer installation instructions	1–10, 400 W max	1–10, 400 W max	1–10, 400 W max

Note: All wattages are in terms of input wattage to the LED driver.

* See note on page 35 for control compatibility.

¹ Setting the low-end trim and load type is necessary to ensure optimal performance and 1% dimming capability.

Note: For information about Legacy Product use in existing control application, contact LEDs@lutron.com

² Minimum number of drivers for GRAFIK T will vary based on the number of companion dimmers (model number GT-AD) connected. Refer to the GRAFIK T Spec Submittal, Lutron P/N 369826, at www.lutron.com This only applies when neutral is not connected.

Job Name:	Model Numbers:
Job Number:	

Terminal Wiring Gauges

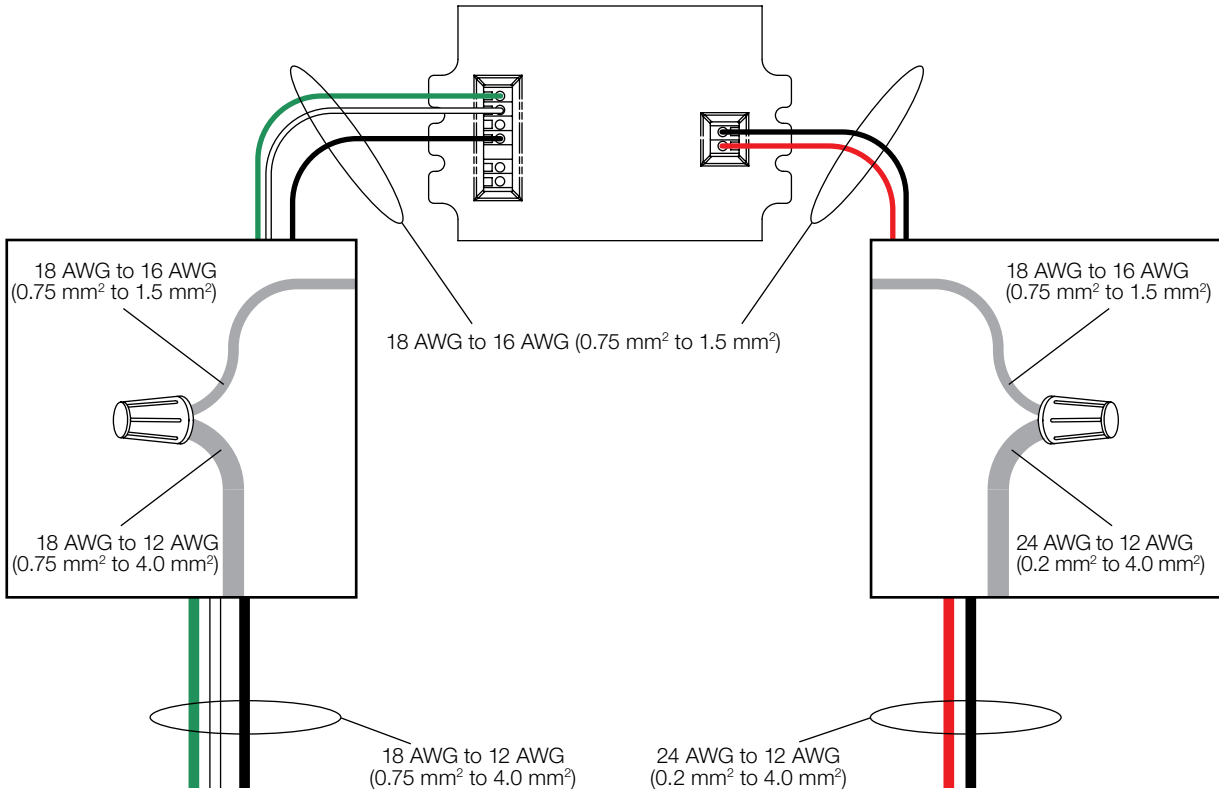

Note: Colors shown correspond to terminal blocks on driver.

LUTRON SPECIFICATION SUBMITTAL

Page

Job Name:	Model Numbers:
Job Number:	

Electricians and Contractors

Driver Leads

Maximum driver-to-LED light engine wire length for
Constant-Current Drivers:

Wire Gauge*	Maximum Lead Length		
	200 mA to 700 mA	710 mA to 1.50 A	1.51 A to 2.10 A
24 AWG (0.2 mm ²)	8 ft (2.5 m)	4 ft (1.2 m)	2.75 ft (0.8 m)
22 AWG (0.34 mm ²)	13 ft (4 m)	6 ft (1.8 m)	4.5 ft (1.5 m)
20 AWG (0.5 mm ²)	20 ft (6 m)	10 ft (3 m)	7 ft (2 m)
18 AWG (0.75 mm ²)	30 ft (9 m)	15 ft (4.5 m)	10 ft (3 m)
16 AWG (1.5 mm ²)	35 ft (10.5 m)	25 ft (7.5 m)	15 ft (4.5 m)
14 AWG (2.5 mm ²)	50 ft (15 m)	40 ft (12 m)	25 ft (7.5 m)
12 AWG (4.0 mm ²)	100 ft (30 m)	60 ft (18 m)	40 ft (12 m)

Maximum driver-to-LED light engine wire length for
Constant-Voltage Drivers:

Wire Gauge*	Maximum Lead Length		
	10 V to 20 V	20.5 V to 40 V	40.5 V to 60 V
24 AWG (0.2 mm ²)	2.5 ft (0.8 m)	4 ft (1.2 m)	8 ft (2.5 m)
22 AWG (0.34 mm ²)	4 ft (1.2 m)	6 ft (1.8 m)	12 ft (3.7 m)
20 AWG (0.5 mm ²)	6 ft (1.8 m)	10 ft (3 m)	20 ft (6 m)
18 AWG (0.75 mm ²)	10 ft (3 m)	15 ft (4.5 m)	30 ft (9 m)
16 AWG (1.5 mm ²)	15 ft (4.5 m)	25 ft (7.5 m)	50 ft (15 m)
14 AWG (2.5 mm ²)	25 ft (7.5 m)	40 ft (12 m)	75 ft (22.5 m)
12 AWG (4.0 mm ²)	40 ft (12 m)	60 ft (18 m)	100 ft (30 m)

* Terminal blocks on the drivers accept only solid 18 AWG or 16 AWG (0.75 mm² or 1.5 mm²) wire. To use wire gauges larger or smaller than this terminal blocks' rated gauge of 18 AWG or 16 AWG (0.75 mm² or 1.5 mm²) refer to the **Terminal Wiring Gauges** diagram on the previous page. Connect up to 3 ft (0.9 m) of 18 AWG or 16 AWG (0.75 mm² or 1.5 mm²) wire to the LED driver terminal blocks, then connect 14 AWG to 12 AWG (2.5 to 4.0 mm²) or 24 AWG to 20 AWG (0.20 mm² to 0.50 mm²) up to the length allowed in the above table.

Wiring and Grounding

Driver and lighting fixture must be grounded. Drivers must be installed per national and local electrical codes.

LED Load Replacement

For Class 2 rated drivers, the LED load can be changed while the driver is installed and powered.

Maximum Driver Operating Temperature

Driver case temperature (t_c) must not exceed UL conditions of acceptability in end product.

For 50,000 hour lifetime, driver case temperature (t_c) must not exceed 65 °C.

Job Name:	Model Numbers:
Job Number:	

Facilities Managers

SERVICE

Warranty

For warranty information, please visit www.lutron.com/driverwarranty

Replacement Parts

When ordering Lutron replacement parts please provide the full model number. Consult Lutron Customer Assistance at 1.844.LUTRON1 if you have any questions.

Further Information

For further information, please visit us at www.lutron.com/hilume1led or contact our LED Control Center of Excellence at 1.877.DIM.LED8 or LEDs@lutron.com

EMC Information

This device complies with part 15 of the FCC Rules. Operation is subject to the following two conditions: (1) This device may not cause interference, and (2) this device must accept any interference, including interference that may cause undesired operation.

FOR UL LISTED CLASS P MODELS ONLY:

NOTE: This equipment has been tested and found to comply with the limits for a Class A digital device, pursuant to part 15 of the FCC rules. These limits are designed to provide reasonable protection against harmful interference when the equipment is operated in a commercial environment. This equipment generates, uses and can radiate radio frequency energy and, if not installed and used in accordance with the instruction manual, may cause harmful interference to radio communications. Operation of this equipment in a residential area is likely to cause harmful interference in which case the user will be required to correct the interference at his own expense.

Lutron,  Lutron, Hi-lume, C•L, Caséta, GRAFIK Eye, PowPak, Quantum, Lumea, Nova T⁺, Nova, Skylark, seeTouch, Diva, Ariadni, Maestro, Maestro Wireless, RadioRA, and HomeWorks are trademarks of Lutron Electronics Co., Inc., registered in the U.S. and other countries. Energi Savr Node, QwikFig, GRAFIK, GRAFIK Systems, GRAFIK T, myRoom, Vive, and RadioRA 2 are trademarks of Lutron Electronics Co., Inc.

UL and the UL logo are trademarks of UL LLC.

LUTRON SPECIFICATION SUBMITTAL

Page

Job Name:	Model Numbers:
Job Number:	

FOR UL LISTED, REMOTE-MOUNTABLE MODELS ONLY:

NOTE: This equipment has been tested and found to comply with the limits for a Class B digital device, pursuant to part 15 of the FCC Rules. These limits are designed to provide reasonable protection against harmful interference in a residential installation. This equipment generates, uses and can radiate radio frequency energy and, if not installed and used in accordance with the instructions, may cause harmful interference to radio communications. However, there is no guarantee that interference will not occur in a particular installation. If this equipment does cause harmful interference to radio or television reception, which can be determined by turning the equipment off and on, the user is encouraged to try to correct the interference by one or more of the following measures:

- Reorient or relocate the receiving antenna.
- Increase the separation between the equipment and receiver.
- Connect the equipment into an outlet on a circuit different from that to which the receiver is connected.
- Consult the dealer or an experienced radio/TV technician for help.