

HPRV Proportional Relief Valve

Catalog 4190-HPRV

aerospace
climate control
electromechanical
filtration
fluid & gas handling
hydraulics
pneumatics
process control
sealing & shielding



ENGINEERING YOUR SUCCESS.

Contents

Page 3 **Introduction**

Page 4 **Seal & Spring Options**

Page 5 **Dimensions**

Page 6 **Materials of Construction**

Page 7 **How to Order**

Introduction

The Parker HPRV relief valve provides an automatic protection mechanism for process instrumentation systems. When upstream pressure exceeds the closing force exerted by the valve's spring, the lower stem opens and permits flow through the valve's outlet port - which can be ducted to a safe place or released to atmosphere. Flow rate increases proportionately to the increase in upstream pressure.

CE marked and certified to the highest Category-IV level of the Pressure Equipment Directive (PED), the HPRV valve's design provides users with accurate and consistent cracking and resealing operation. The valve's innovative seat design additionally operates over an extremely wide pressure range (150 to 6000 psi, 10.3 to 414 bar), providing a universal solution for the vast majority of instrumentation applications.

Pressure settings are externally adjustable. Eight different spring ranges provide greater system sensitivity and enhanced performance.

Features

- **Captured moulded seat design is blow-out and chip resistant**
- **Colour coded springs and labels indicate spring cracking range**
- **Unique Tru-Loc facility prevents accidental adjustment**
- **Lock wire feature secures a given pressure setting**
- **Low friction stem seal design prevents friction which increases accuracy of cracking pressure and reseal pressure**
- **Balanced poppet design ensures consistent cracking pressure regardless of system back pressure**
- **Orifice sizes: 3.6mm (0.142")**
- **Multiple end connections available**

Maximum Relieving Flow

Water 1.686 l/min @ 150 psi with zero back pressure. Air 313 l/min @ 150 psi with zero back pressure.

Note: For a 'safe' system the relieving flow capacity should exceed the maximum input flow. The maximum discharge capacity is not a given design specification for this valve, therefore the maximum discharge capacity quoted within the instructions is for informative purposes only. Should this guideline value not be sufficient to protect equipment or systems from exceeding maximum pressure, another type of relief or safety valve should be used.

Specifications

Working Pressure

Maximum Cold Working Pressure: 6000 psi (414 bar).

Up to 8000 psi (552 bar) during relief with no internal seal damage.
Maximum back pressure: 2000 psi (137.9 bar).

Cracking Pressure

Eight springs, from 150 psi to 6000 psi in the following ranges:
150-375 psi, 325-775 psi, 725-1525 psi, 1475-2275 psi, 2225-3025 psi,
2975-4025 psi, 3975-5025 psi, 4975-6000 psi.

(See table on page 4 for bar equivalents).

Cracking pressure within 3% of set pressure.
Reseat pressure within 15% of cracking pressure.

Note: Valves which are not actuated for a period of time may initially crack at higher than set pressures.

Available End Connections

Z - Single ferrule CPI™
compression port

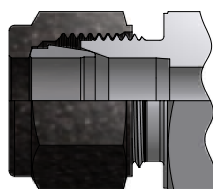

A - Two ferrule A-LOK®
compression port

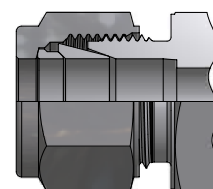

M - ANSI/ASME B1.20.1
External pipe threads

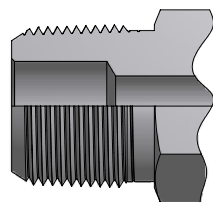

F - ANSI/ASME B1.20.1
Internal pipe threads

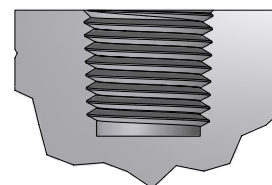

Seal & Spring Options

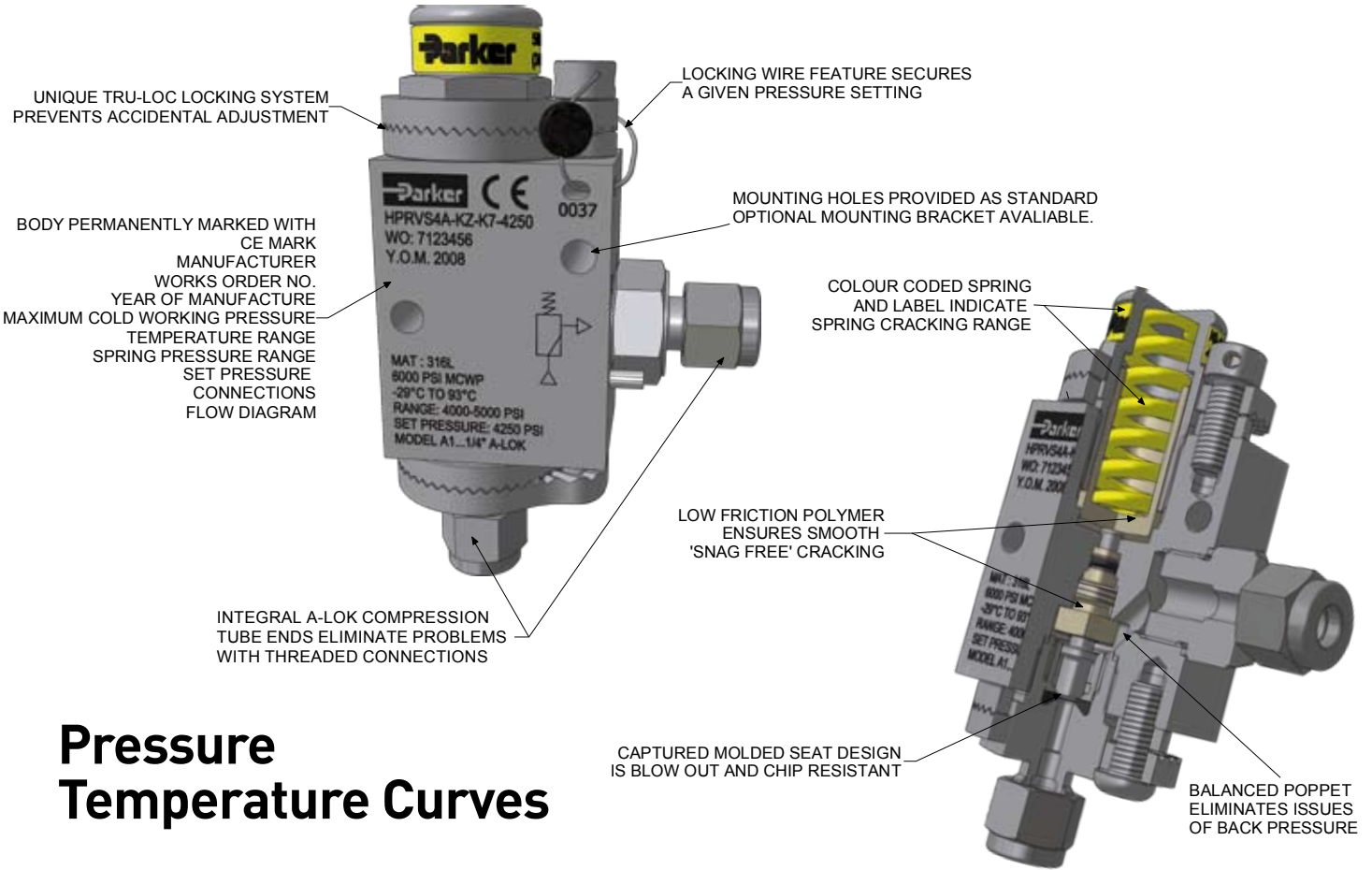

Pressure Temperature Curves

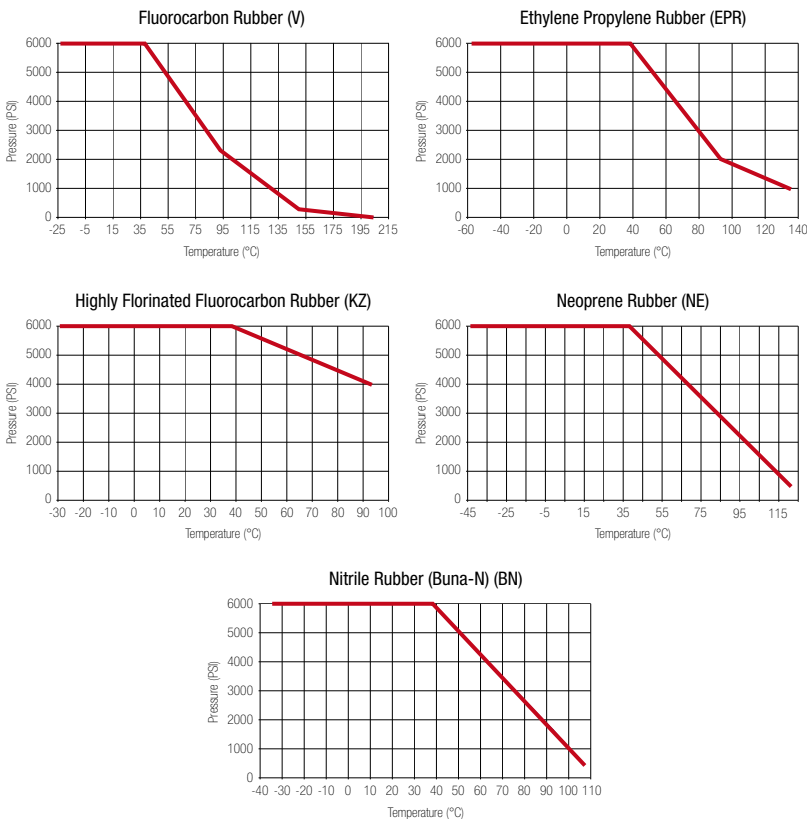

SEAL MATERIAL OPTIONS

Designator	Material	Shore Hardness	Temperature Range
V	Fluorocarbon Rubber	90	-23°C to +204°C (-10°F to +400°F)
EPR	Ethylene Propylene Rubber	90	-57°C to +135°C (-70°F to +135°F)
BN	Nitrile Rubber (Buna-N)	90	-34°C to +107°C (-30°F to +225°F)
KZ	Highly Fluorinated Fluorocarbon Rubber	90	-29°C to +93°C (-20°F to +200°F)
NE	Neoprene Rubber	70	-43°C to +121°C (-45°F to +250°F)

SPRING RANGE OPTIONS

Designator	Pressure Range		Colour Code
	psi	bar	
K1	150 - 375	10.3 - 25.9	Gray
K2	325 - 775	22.4 - 53.4	Red
K3	725 - 1525	50.0 - 105.1	Orange
K4	1475 - 2275	101.7 - 156.9	Yellow
K5	2225 - 3025	153.4 - 208.6	Light Green
K6	2975 - 4025	205.1 - 277.5	Light Blue
K7	3975 - 5025	274.1 - 346.5	Violet
K8	4975 - 6000	343.0 - 414.0	Lemon Yellow

Dimensions

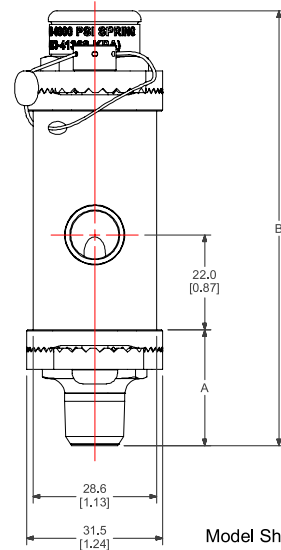
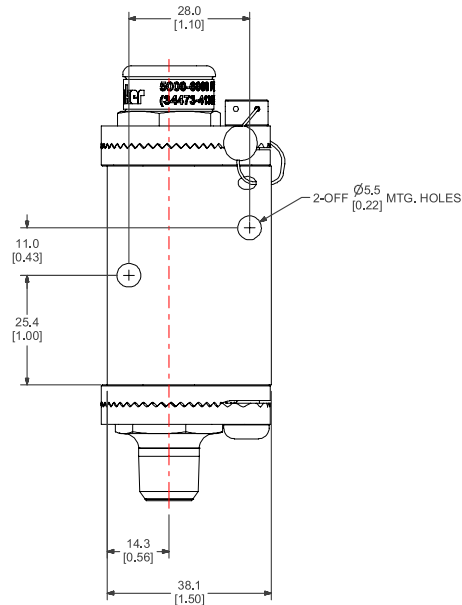

Model Shown: HPRVS4M4F-V-K8-5500

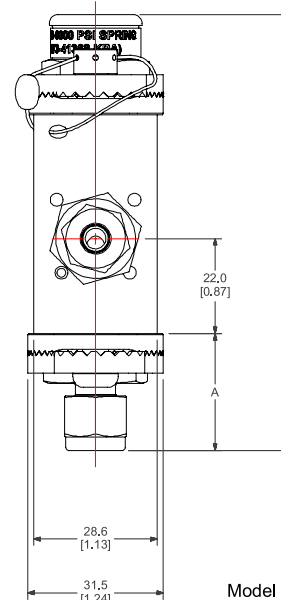
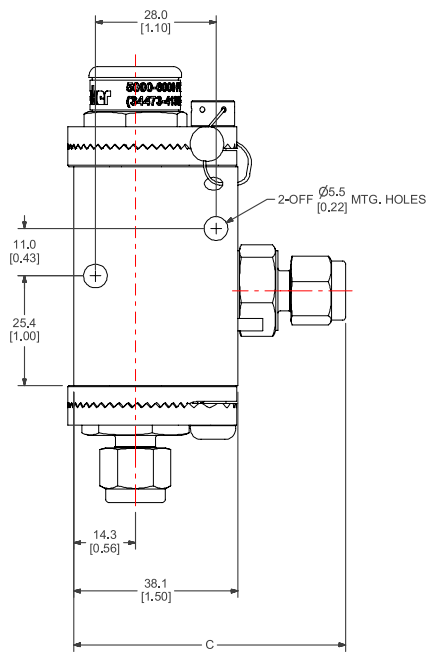

Model Shown: HPRVS4A-V-K8-5500

Basic Part Number	End Connections		Flow Data				Dimensions					
	Inlet	Outlet	Orifice		CV	X _T	A		B		C	
			mm	inch			mm	inch	mm	inch		
HPRV_4A	1/4" O.D. A-LOK	1/4" O.D. A-LOK	3.6	0.14	0.41	0.67	27.2	1.07	105.8	4.17	63.5	2.50
HPRV_4Z	1/4" O.D. CPI	1/4" O.D. CPI					27.2	1.07	105.8	4.17	63.5	2.50
HPRV_M6A	6mm O.D. A-LOK	6mm O.D. A-LOK					27.2	1.07	105.8	4.17	63.5	2.50
HPRV_M6Z	6mm O.D. CPI	6mm O.D. CPI					27.2	1.07	105.8	4.17	63.5	2.50
HPRV_4M4F	1/4-18 NPT (Mate)	1/4-18 NPT (Female)					26.9	1.06	105	4.13	N/A	

For A-LOK and CPI, dimensions are measured with nuts in the finger tight position.
 Gas flow will be choked when $P_1 - P_2 / P_1 = X_T$

[x] denotes dimensions in inches.

Materials of Construction

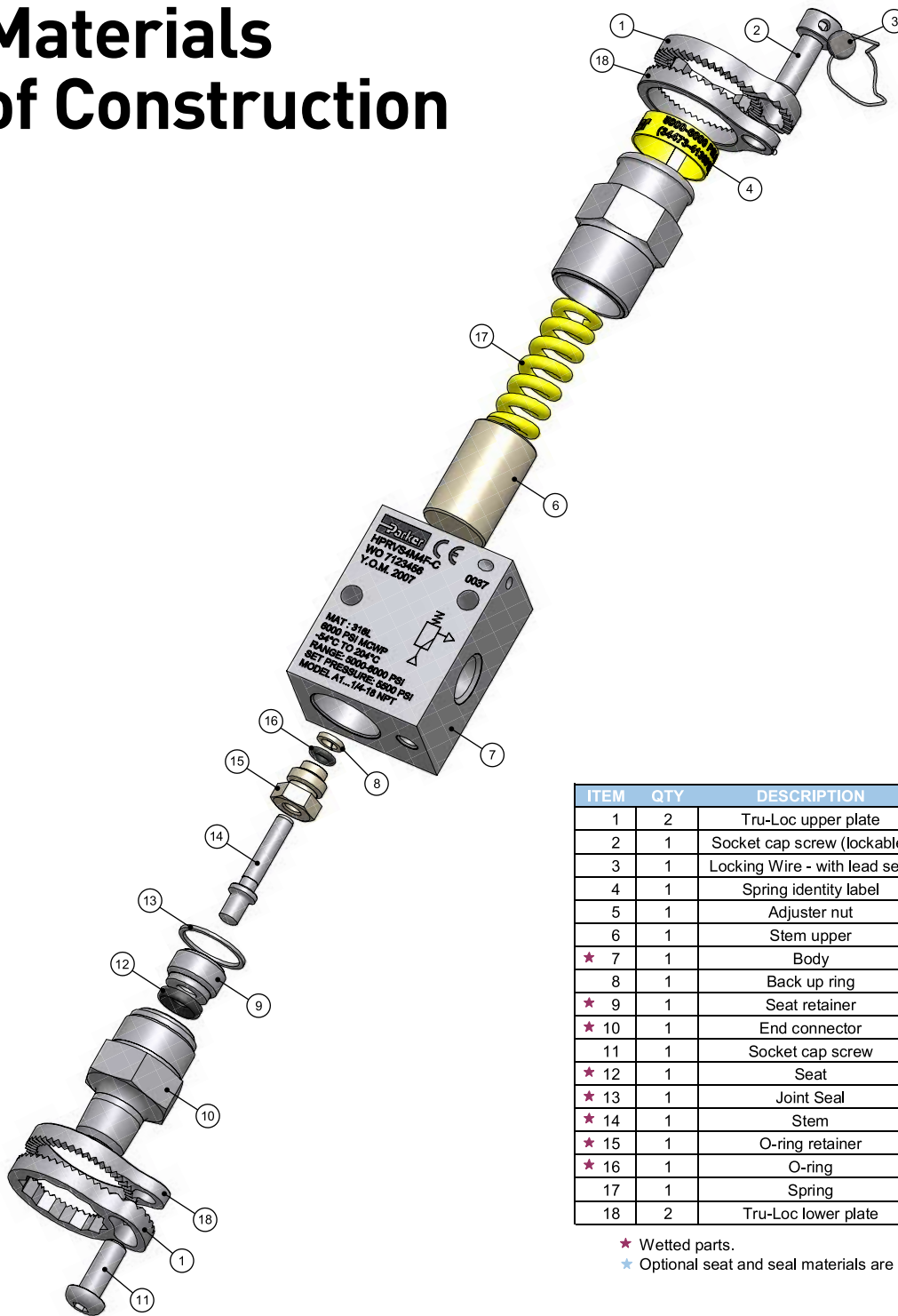

ITEM	QTY	DESCRIPTION	MATERIAL
1	2	Tru-Loc upper plate	316 Stainless Steel
2	1	Socket cap screw (lockable)	316 Stainless Steel
3	1	Locking Wire - with lead seal	316 Stainless Steel
4	1	Spring identity label	Vinyl
5	1	Adjuster nut	ASTM A 479 Type 316
6	1	Stem upper	PEEK
★ 7	1	Body	ASTM A 479 Type 316
8	1	Back up ring	PEEK
★ 9	1	Seat retainer	ASTM A 479 Type 316
★ 10	1	End connector	ASTM A 479 Type 316
11	1	Socket cap screw	316 Stainless Steel
★ 12	1	Seat	★ Fluorocarbon Rubber
★ 13	1	Joint Seal	ASTM A 479 Type 316
★ 14	1	Stem	ASTM A 479 Type 316
★ 15	1	O-ring retainer	PEEK
★ 16	1	O-ring	★ Fluorocarbon Rubber
17	1	Spring	17-7 Stainless Steel (Colour Coded)
18	2	Tru-Loc lower plate	316 Stainless Steel

★ Wetted parts.

★ Optional seat and seal materials are located in How to Order section.

Declaration of PED Compliance

This relief valve conforms to the Pressure Equipment Directive 97/23/EC, Safety Accessories / Category IV, as per article 1 section 2.1.3. CE 0037. All valves are CE marked and supplied with a full declaration of conformity. Parker Hannifin has been audited by Zurich Risk Services and meets the requirements of assessment procedure module H1 and awarded an EC Design Examination Certificate EN - 044020/B1.

These valves also conform to Directive 94/9/EC relating to equipment intended for use in potentially explosive atmospheres and is ATEX certified.

How to Order

The correct part number is easily derived from the following number sequence. The seven product characteristics required are coded as shown below.

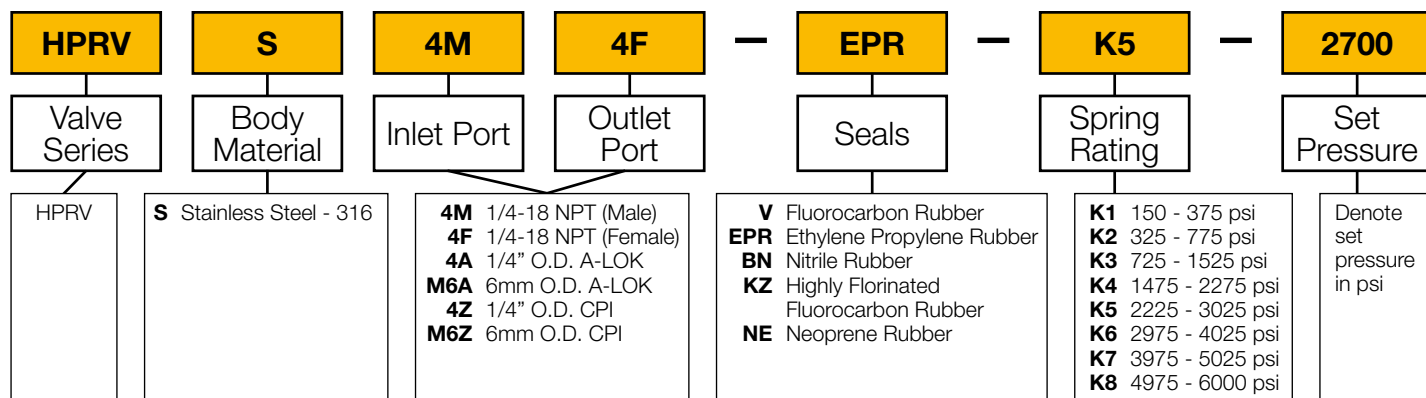

Examples

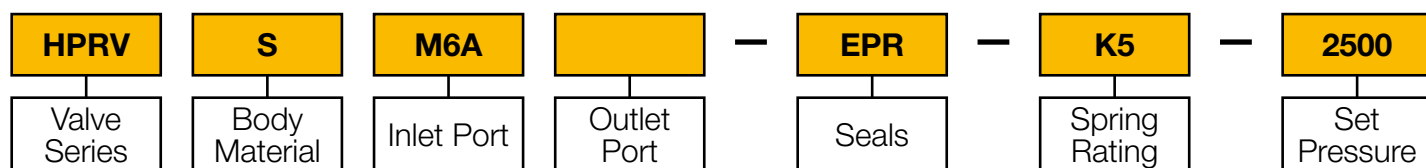

Describes an HPRV Series proportional relief valve equipped with 6mm A-Lok compression inlet and outlet ports, ethylene propylene rubber seals, stainless steel construction, fitted with a 2250 - 3000 psi spring. Supplied pre-set at 2500 psi.

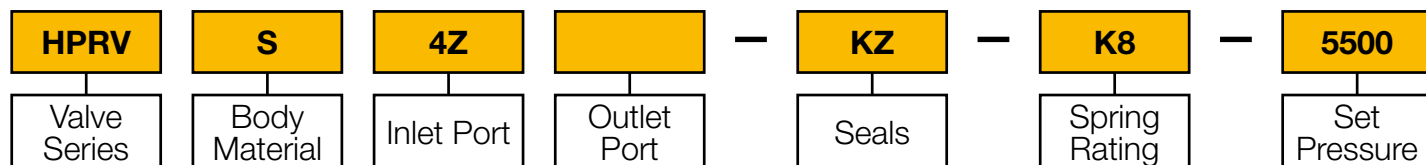

Describes an HPRV Series proportional relief valve equipped with 1/4" CPI compression inlet and outlet ports, highly florinated fluorocarbon rubber seals, stainless steel construction, fitted with a 5000 - 6000 psi spring. Supplied pre-set at 5500 psi.

WARNING

FAILURE, IMPROPER SELECTION OR IMPROPER USE OF THE PRODUCTS AND/OR SYSTEMS DESCRIBED HEREIN OR RELATED ITEMS CAN CAUSE DEATH, PERSONAL INJURY AND PROPERTY DAMAGE.

This document and other information from Parker Hannifin Corporation, its subsidiaries or its authorized distributors provide product and/or system options for further investigation by users having technical expertise. It is important that you analyze all aspects of your application and review the information concerning the product or system in the current product catalog. Due to the variety of operating conditions and applications for these products or systems, the user, through its own analysis and testing, is solely responsible for making the final selection of the products and systems and assuring that all performance, safety and warning requirements of the application are met.

The products described herein, including without limitation, product features, specifications, designs, availability and pricing, are subject to change by Parker Hannifin Corporation and its subsidiaries at any time without notice.

Offer of Sale

The items described in this document are available for sale by Parker Hannifin Corporation, its subsidiaries or its authorized distributors. Any sale contract entered into by Parker will be governed by the provisions stated in Parker's standard terms and conditions of sale (copy available upon request).

Sales Offices Worldwide

AE – United Arab Emirates,
Abu Dhabi
Tel: +971 2 67 88 587

AR – Argentina, Buenos Aires
Tel: +54 3327 44 4129

AT – Austria, Wiener Neustadt
Tel: +43 (0)2622 23501-0

AT – Austria, Wiener Neustadt
(Eastern Europe)
Tel: +43 (0)2622 23501 970

AU – Australia, Castle Hill
Tel: +61 (0)2-9634 7777

AZ – Azerbaijan, Baku
Tel: +994 50 2233 458

BE – Belgium, Nivelles
Tel: +32 (0)67 280 900

BR – Brazil, Jacareí - São Paulo
Tel: +55 12 3954 5100

BY – Belarus, Minsk
Tel: +375 17 209 9399

CA – Canada, Milton, Ontario
Tel: +1 905 693 3000

CH – Switzerland, Etoy
Tel: +41 (0)2182 10230

CN – China, Shanghai
Tel: +86 21 5031 2525

CN – China, Beijing
Tel: +86 10 6561 0520

CZ – Czech Republic, Klecany
Tel: +420 284 083 111

DE – Germany, Kaarst
Tel: +49 (0)2131 4016 0

DK – Denmark, Esbjerg
Tel: +45 49 12 17 00

ES – Spain, Madrid
Tel: +34 902 33 00 01

FI – Finland, Vantaa
Tel: +358 (0)20 753 2500

FR – France,
Contamine-sur-Arve
Tel: +33 (0)4 50 25 80 25

GR – Greece, Athens
Tel: +30 210 933 6450

HK – Hong Kong
Tel: +852 2428 8008

HU – Hungary, Budapest
Tel: +36 1 220 4155

IE – Ireland, Dublin
Tel: +353 (0)1 466 6370

IN – India, Mumbai
Tel: +91 22 6513 7081-85

IT – Italy, Corsico (MI)
Tel: +39 02 45 19 21

JP – Japan, Fujisawa
Tel: +(81) 4 6635 3050

KR – South Korea, Seoul
Tel: +82 2 559 0400

KZ – Kazakhstan, Almaty
Tel: +7 3272 505 800

LV – Latvia, Riga
Tel: +371 74 52601

MX – Mexico, Apodaca
Tel: +52 81 8156 6000

MY – Malaysia, Subang Jaya
Tel: +60 3 5638 1476

NL – The Netherlands,
Oldenzaal
Tel: +31 (0)541 585 000

NO – Norway, Stavanger
Tel: +47 (0)51 826 300

NZ – New Zealand, Mt Wellington
Tel: +64 9 574 1744

PL – Poland, Warsaw
Tel: +48 (0)22 573 24 00

PT – Portugal, Leca
da Palmeira
Tel: +351 22 999 7360

RO – Romania, Bucharest
Tel: +40 21 252 1382

RU – Russia, Moscow
Tel: +7 495 645-2156

SE – Sweden, Spånga
Tel: +46 (0)8 59 79 50 00

SG – Singapore
Tel: +65 6887 6300

SL – Slovenia, Novo Mesto
Tel: +386 7 337 6650

SK – Slovakia
See Czech Republic

TH – Thailand, Bangkok
Tel: +662 717 8140

TR – Turkey, Merter/Istanbul
Tel: +90 212 482 91 06 or 07

TW – Taiwan, Taipei
Tel: +886 2 2298 8987

UA – Ukraine, Kyiv
Tel: +380 44 494 2731

UK – United Kingdom,
Barnstaple
Tel: +44 (0)1271 313131

US – USA, Cleveland
(Industrial)
Tel: +1 216 896 3000

US – USA, Lincolnshire
(Mobile)
Tel: +1 847 821 1500

US – USA, Miami
(Pan American Division)
Tel: +1 305 470 8800

VE – Venezuela, Caracas
Tel: +58 212 238 5422

ZA – South Africa,
Kempton Park
Tel: +27 (0)11 961 0700

