

**Installation instructions  
and User guide**

**Clothes washer**

**NZ AU**



<b>Introduction</b>	<b>2</b>
<b>Installation instructions</b>	<b>3</b>
<b>Getting started</b>	
Using your washer	6
<b>Lid lock</b>	<b>8</b>
<b>Wash cycles and options</b>	
Wash cycles and options	9
Wash options and advancing the cycle	10
Water levels	11
Saving water – Eco option, Spin Hold	12
Washing bulky items, Woollens	13
<b>Before you wash</b>	
Sorting, Loading	14
Detergent	15
Fabric softener, Scrud	16
<b>Changing pre-set options</b>	
Option Adjustment mode	17
Wash temperatures, Rinse options	19
Out of Balance Recovery routine	20
<b>Machine information</b>	
Specifications	20
Cleaning your washer	21
Products that might damage your washer, Sounds and beeps	22
Automatic lint system, Water consumption	22
<b>Problem solving</b>	
If your washer beeps for help	23
Operating problems	25
Wash problems	26
<b>Manufacturers warranty</b>	<b>27</b>
<b>Customer care</b>	<b>28</b>

## ***Important!***

### **SAVE THESE INSTRUCTIONS**

*The models shown in this User Guide may not be available in all markets and are subject to change at any time. For current details about model and specification availability in your country, please visit our local website listed on the back cover or contact your local Fisher & Paykel dealer.*

Thank you for buying an Elba washing machine. We are very proud of this *Smart Drive™* washer and trust it will serve you well for many years.

At Fisher & Paykel we aim to provide innovative products that are simple to use, ergonomic and energy efficient. Compared to conventional machines, your *Smart Drive™* washer uses intelligence to adapt the wash action and water levels to save on water and electricity use; making it kinder on your wallet and the environment. Thousands of tonnes of washing and 70 years of laundry experience have been programmed into your washing machine to help give you the best possible performance.

We hope you enjoy your new washing machine, we have certainly enjoyed designing it.

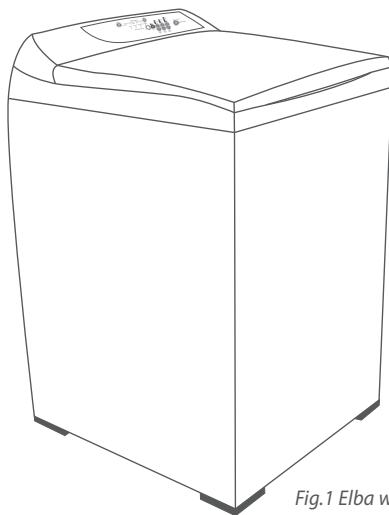

Fig.1 Elba washer

### ***Important!***

*It is important that the User Guide should be retained with the appliance for future reference. Should the appliance be sold or transferred to another owner, always ensure that the User Guide is left with the appliance in order that the new owner can familiarise themselves with the appliance and the relevant warnings.*

Note: you owe it to yourself and your Elba washer to have it installed correctly by an Authorised Service Agent.

## Unpacking

To ensure the best performance from your new *Smart Drive™* please follow the instructions below.

### Removing the packaging

- 1 Remove the outer packaging.
- 2 Tilt the machine backwards and walk it off the bottom packer one foot at a time.
- 3 Remove the bottom packer from under the machine by pulling it out the front.
- 4 Lift the lid and remove the bowl packer from the bowl.
- 5 Remove the hoses and accessories.
- 6 Keep the bottom packer and bowl packer in case they are required for future transit.

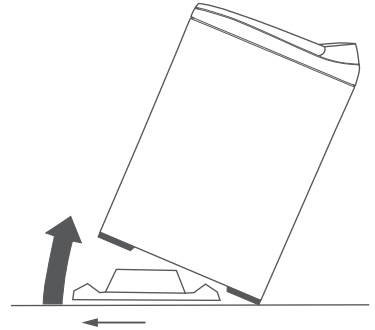

Fig.2 Tilt washer backwards to remove packer

## Important!

*Please ensure that the bottom packer has been removed before operating your machine.*

In your washer you will find:

- 4 rubber inserts for the levelling feet (joined together).
- 1 hose guide.
- 2 inlet hoses.

## Drain hose

- 1 Carefully pull the drain hose out from the back of the machine by pulling the exposed part of the hose downward and outward.
- 2 To guide the drain hose over the tub or standpipe the hose guide MUST be fitted to the drain hose.

### To prevent syphoning:

The drain hose should not extend more than 20 mm from the end of the guide.

The height of the standpipe or tub should be between 850 – 1200 mm.

The drain hose can be trimmed to length.

- 3 Place the drain hose in the tub or standpipe.

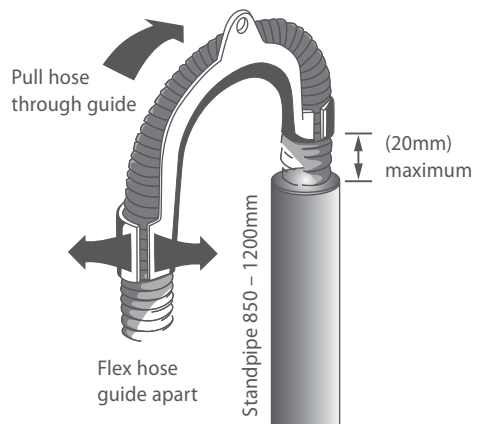

Fig.3 Fitting the drain hose guide

## 4 Installation instructions

### Inlet hoses

- 1 Connect the straight ends of the inlet hoses to the taps. There are washers fitted in both ends.
- 2 Connect the elbow ends of the inlet hoses to the machine inlet valves. Inlet valves are marked on the back of the machine.

H=Hot

C=Cold.

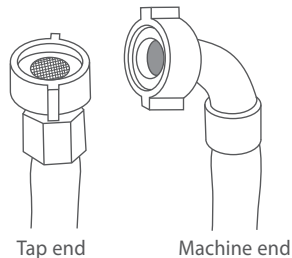

Fig.4 Inlet hose ends

Ensure you have correctly connected hot to hot and cold to cold.

### Cold supply only:

If you only have a cold water supply, an inlet valve cap (blanking cap) MUST be connected to the hot inlet valve. The cap prevents water leaking out of the hot valve. The cap is available from your Fisher & Paykel Dealer or Authorised Service Centre, Part No. 388491. This appliance incorporates backflow protection complying with AS3500.1. No further backflow protection is required for connection to the water supply.

### Levelling

It is IMPORTANT to level the machine to ensure even spin performance.

- 1 Separate the 4 rubber foot inserts from the moulding and fit into the feet on the base of the machine.
- 2 Move the machine to its final position. (We suggest a minimum clearance of 20 mm each side.)
- 3 Adjust the feet (wind down) so the machine is level and cannot rock.

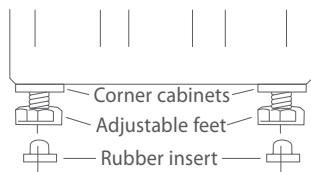

Fig.5 Adjusting levelling feet

### To check if your machine is level:

Look down on the wash bowl and make sure it sits slightly forward of centre. Close the lid. Visually check that the lid fits evenly on both sides (see Fig.6). If not, adjust one of the front feet slightly until it matches. The diagram on the top and bottom are not correct.

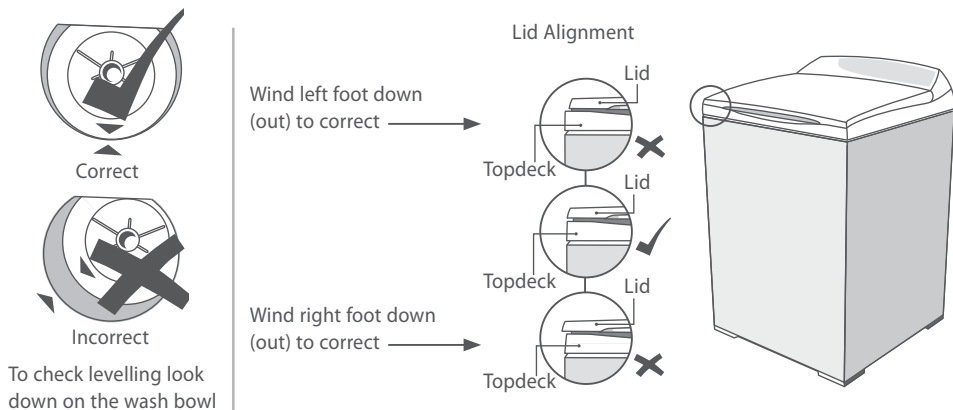

Fig.6 To assess levelling check lid alignment

- 4 Turn on the water and check all hose connections for leaks. Make sure there are no kinks in the hoses.
- 5 Uncoil power cord and plug into wall socket.

## Water supply

- For best operating conditions your hot water should be approximately 65°C. Your cold water should not exceed 35°C or your hot water exceed 75°C. Temperatures above these may cause the machine to fault or cause damage to the machine.
- If you have an uncontrolled water heating source (eg a wet back or solar heating system) you should fit a Safe Valve. This will ensure the hot water temperature remains within safe limits.
- Inlet water pressure: Max.1MPa (150 psi) Min. 34Pa (5 psi)
- Inlet water flow rate: Min. 3 litres/min
- Minimum height of taps to clear the top of the machine is 1150 mm.

### Hot 'N' Safe Valves available are:

RMC TVA 50HF

RMC TVA 75HFS

Adjustable between 35°C – 55°C

RMC TVA 50HP

For instantaneous gas hot water supply

## Draining

- Regularly check that your standpipe or tub is free from lint or other obstructions, which may affect how your machine works or may cause flooding.
- In multi-storey apartments or any upper floor, the machine should be installed on a drained floor.
- Draining must comply with local by-laws.

## Washer safety

- This washer is not intended for use by young children or infirm persons without supervision.
- Your *Smart Drive™* can now be opened while it is filling and agitating, supervise young children to ensure they do not play with it.

## ⚠ WARNING!



### Electrical Shock Hazard

If you are using an extension cord or a portable electrical outlet device (eg multi-socket outlet box), ensure that it is positioned so that it does not come into contact with water or moisture.

Failure to do so may result in death or electrical shock.

## Accessories and spare parts

Available from your Fisher & Paykel Dealer or Authorised Service Centre.

Inlet Valve Cap	Part No. 388491
Hose Inlet Long (2m)	Part No. 422680
Hose Inlet Large Bore	Part No. 426123
Drain Hose Extension	Part No. 425627p
Power Cord	If the Power Cord of your washer is damaged it must be replaced by a Fisher & Paykel Authorised Service Centre, as it is not a standard power cord.

## 6 Using your washer

- Remove fabric softener dispenser.
- Place the load evenly around the agitator. (Refer to 'Sorting and loading' page 14).

### A. Detergent

- Follow the instructions on the detergent package.
- Use the mark on the agitator, nearest to the top of the clothes, as a guide to the correct amount of detergent to use.
- Pour the detergent down the centre of the agitator stem.
- Replace the fabric softener dispenser (this stops small articles falling down the centre of the agitator). (Refer to 'Detergent' page 15).

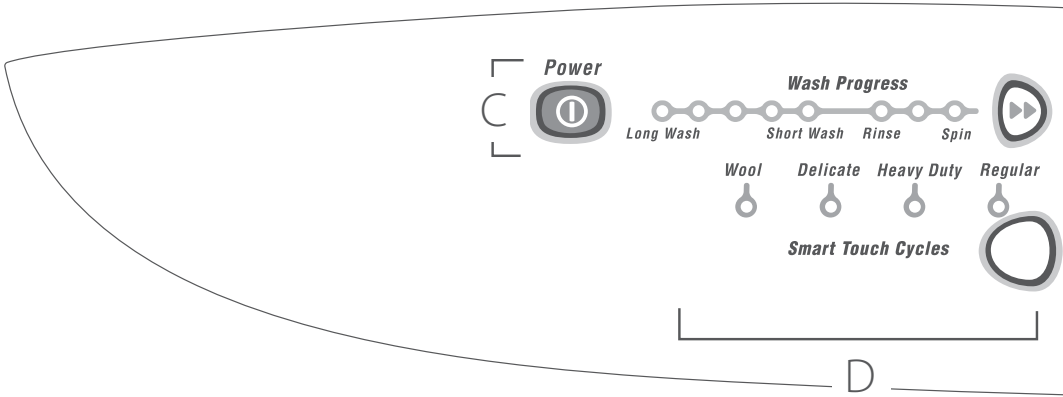
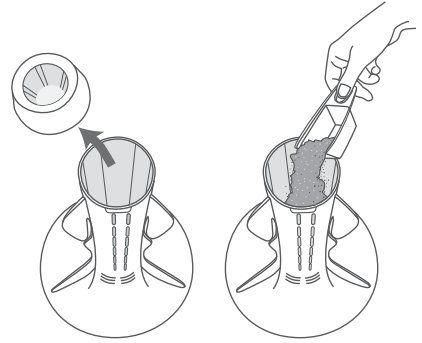

### B. Fabric softener

- If you wish to use fabric softener, place it in the dispenser on the top of the agitator.
- Fabric softener must not be used if you have selected the ECO option.** (Refer to 'Fabric softener' page 16).

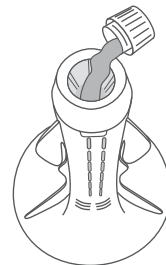



## C. Power

- Press **POWER** to turn the machine on.

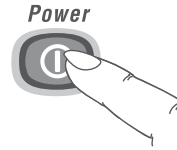

## D. Wash cycle

- Select the cycle you want by pressing the **CYCLE** button  located below the **REGULAR** option. Scroll through the cycles until the one you want is lit.

## E. Wash options

- Select the wash temperature and other wash options. (Refer to pages 9 – 13).

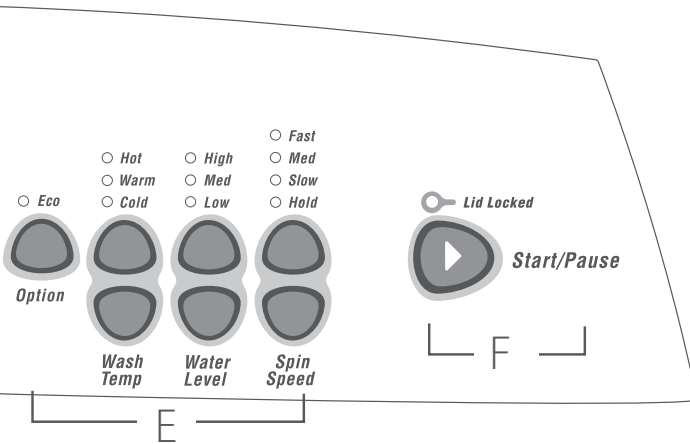

Fig.7 Control panel

## F. Start

- Press **START/PAUSE** to start the machine.

### If you wish to stop your washer

- Press **START/PAUSE**.
- If it is during spray rinse or spin there is a slight delay while the bowl is coasted to a stop and the lid is unlocked.

## **Important!**

*For best fabric and colour care remove your clothes as soon as the cycle has finished.*

## 8 Lid lock

Your *Smart Drive™* has a lid lock, which locks when your machine is spinning. This ensures the lid cannot be opened during hazardous parts of the cycle, providing added safety for you and your family.

The **LID LOCK** light (above the **START/PAUSE** button) comes on when the lid is locked to tell you when you cannot open the lid. In short it means you can open the lid while your washer is filling, agitating, and draining, but not while it is spinning.



Fig.8 **LID LOCK** light

- When the **LID LOCK** light is on, the lid is locked.
- When the **LID LOCK** light is off, the lid is not locked and the lid can be opened.
- If the **LID LOCK** light is flashing the lid lock is in process of locking or unlocking, (ie while the machine coasts down or **START/PAUSE** has been pressed). During this stage the lid still cannot be lifted.

### **Important!**

*If the lid is left open, the machine will be unable to lock and the cycle will be halted. The machine will play a tune and the **LID LOCK** light will flash until the lid is closed and **START/PAUSE** is pressed.*

The lid lock remains unlocked for the majority of the cycle allowing you to add clothes, dissolve detergent or to add fabric softener (if you do not want to use the Automatic Fabric Softener Dispenser).

The chart below shows the stages when the lid is locked.

Fill	Unlocked
Agitate	Unlocked
Spray Rinse	Locked
Deep Rinse	Unlocked
Spin	Locked

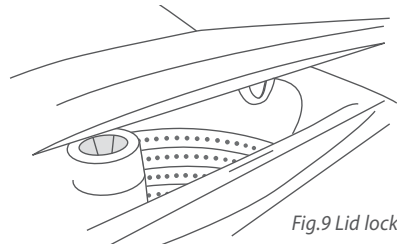

Fig.9 Lid lock catch

Keep children away from the machine, especially when you are using hot water, as the lid can be opened during fill and agitate.

### **Important!**

*DO NOT put anything down the slot in the top deck of your machine.  
DO NOT try to disable the lid lock.*

## Default settings

	REGULAR	HEAVY DUTY	DELICATE	WOOL
Wash Time	12 min	15 min	6 min	6 min
Wash Action	<b>REGULAR</b>	<b>HEAVY DUTY</b>	<b>DELICATE</b>	<b>DELICATE</b>
Wash Temp	<b>WARM</b>	<b>WARM</b>	<b>WARM</b>	<b>WARM</b>
Rinse	Spray rinse + cold deep rinse	Spray rinse + cold deep rinse	2 cold deep rinses	Spray rinse + warm-cold deep rinse
Spin Speed	<b>FAST</b>	<b>FAST</b>	<b>SLOW</b>	<b>MEDIUM</b>
Spin Time	6 min	6 min	4 min	6 min
Cycle times (min)				
Large	45	48	42	37
Medium	42	45	37	35
Compact	41	44	35	33

Cycle times are dependent on your household water pressure.

## Wash cycles

- **REGULAR** cycle (with the **ECO** option) has been designed for normally soiled, everyday washing eg sheets, towels, T-shirts.
- **HEAVY DUTY** cycle is for heavily soiled durable garments eg overalls, jeans, tea towels.
- **DELICATE** cycle uses a slow, gentle agitation designed to care for your most delicate garments eg lingerie, blouses.
- **WOOL** cycle is for machine washable woollens.

## 10 Wash options and advancing the cycle

### To select the wash options

- 1 Select the wash cycle, temperature, water level and spin speed. (Refer to page 6).
- 2 If you wish to save water press the **ECO** button. (Refer to page 12).
- 3 Press **START/PAUSE**.

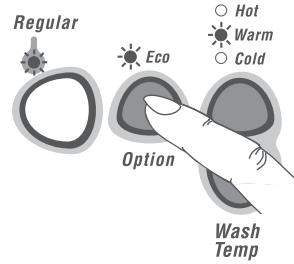

Fig.10 Selecting wash options

### The wash progress lights

The **WASH PROGRESS** lights show all the tasks your *Smart Drive™* will do during the wash cycle. As each task is completed a light goes out, so you can tell at a glance how far the cycle has to go.



Fig.11 Wash progress lights

### To advance the wash cycle

- 1 Press **POWER**.
- 2 Press the **▶▶** button repeatedly to advance the cycle, to the desired position.
- 3 Press **START/PAUSE**.

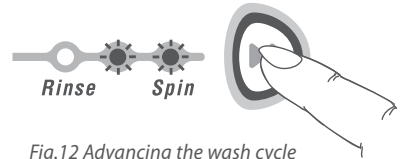

Fig.12 Advancing the wash cycle

Note: each wash progress light equals 3 minutes of agitation. The **ECO** option wash progress lights may in some cases wash for longer. This is dependent on the water level.

### Clothes care safeguards

To avoid accidentally damaging your clothes there are a few options that your washer will not accept. For example, you cannot select a hot wash on **DELICATE**, or **WOOL** cycles, or choose the **ECO** option on anything other than the **HEAVY DUTY** or **REGULAR** cycle.

## Manual water level selection

The agitator has 5 levels marked on its stem that can be used to help you select the correct water level. Select the correct water level by using the mark nearest to the top of the load.

- **The levels marked on the agitator do not correspond exactly to the level of the water. They indicate the level of dry clothes suitable for the water level.**
- Your *Smart Drive™* may occasionally add water during agitation. This is to maintain the water level due to the release of air trapped in the garments.
- Out of balance loads, tangling or splash-over can be caused by selecting a water level that is too high.

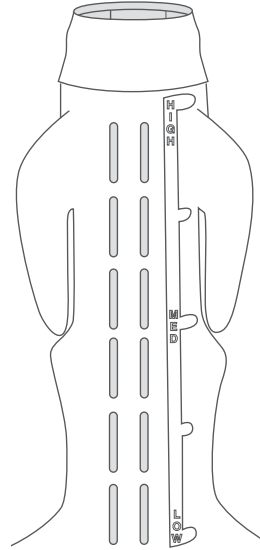

Fig.13 Water level guide on agitator

## 12 Wash options

### Saving water – Eco option

Press the **ECO** option to save large amounts of water. The **ECO** option uses an Eco Spray rinse. Use this option when you want to use less detergent and less water. **This option is not recommended if you have low water pressure or sensitive skin.**

**The ECO option has not been designed to be used with fabric softener** as it does not have a second deep rinse to dispense the softener correctly.

Note: the **ECO** option is only available on the **REGULAR** and **HEAVY DUTY** cycles. If you try to select these options on the **WOOL** or **DELICATE** cycle, your *Smart Drive™* will skip over the option. The **ECO** option will take slightly longer than a normal spray and deep rinse.

There are some wash loads that may not suit being washed using the **ECO** option. For instance, loads that have a lot of sand or sawdust in them or garments where the colour still runs from them.

### Tips for water saving

- Full loads are more efficient than part loads.
- Use the **ECO** option. (Refer above).
- Adjust the rinse option on **REGULAR**, **HEAVY DUTY** and **WOOL** cycles to one deep rinse. (Refer to page 19).
- Wash larger loads

### Spin Hold

Use the SPIN HOLD option to:

- Remove drip dry garments from a mixed load before the wash goes into spin.
- Minimise the clothes creasing when they are left to sit in the bottom of the bowl at the end of the cycle. When you have selected **HOLD**, your *Smart Drive™* will pause at the end of rinse, beep and the spin light will flash to tell you that it is waiting for another instruction. Press **START/PAUSE** to begin the spin.

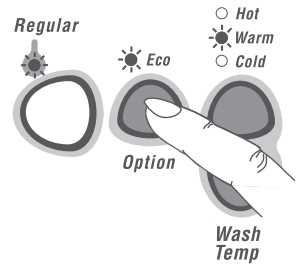

Fig.14 Selecting **ECO** option

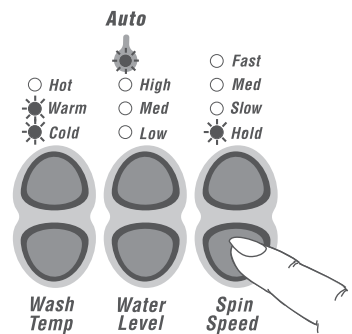

Fig.15 Selecting **SPIN HOLD** option

## Washing bulky items

Forcing large items into the machine may result in them being damaged during washing. Make sure there is enough room in the machine for items to move when being washed.

Some items float up during the wash, (eg duvets/ doonas and pillows). If they sit too high they may touch stationary parts of the machine during agitate or spin. To minimize the chance of this happening, **bulky items should be pushed down below the water level after fill and pushed to sit below the medium high water level mark on the agitator before spinning. Select a slow spin.**

**To prevent an out of balance load or splashover we recommend washing these items on the DELICATE cycle.** If you wish to re-spin the load at a faster speed make sure the load is sitting below the medium-high mark before spinning.

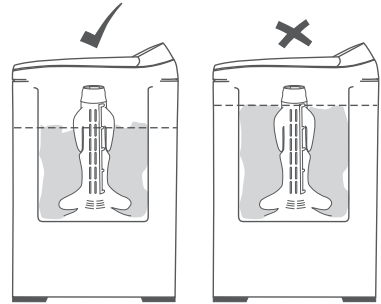

Bulky items should sit below the medium high water level mark.

## Washing woollens

The **WOOL** cycle has been approved by the New Zealand Wool Board and the Australian Wool Corporation for Woolmark products carrying a MACHINE WASHABLE care claim. The fibres of these woollens have been treated to prevent felting when they are machine washed. Most handknitted garments are not made of machine washable wool and we recommend that you wash them by hand.

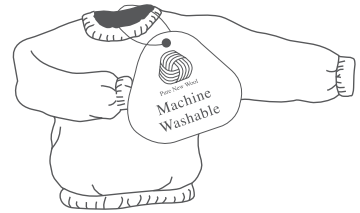

- Check the care label.
- Use a wool detergent.
- Use the **WOOL** cycle.
- Hand washed woollens may be spun in your *Smart Drive*™.
- To dry woollens lie them flat on a towel and pat into shape. Dry out of direct sunlight.
- **Some wool underlays and sheepskin products can be washed in a washing machine but may produce excessive amounts of lint that may cause pump blockages.**

## Nappy sanitisers/ Bleach

Nappy sanitisers and bleach are very corrosive to metal surfaces. **DO NOT** use your *Smart Drive*™ to soak items in bleach or sanitiser, or tip the contents of the nappy bucket into your machine. Rinse and wring items out thoroughly before placing them in your machine.

## 14 Before you wash

### Sorting

To get the best wash results it pays to sort your clothes before washing.

#### Care labels

The care label will tell you about the fabric of the garment and how it should be washed.

#### Soil

Sort clothes according to the type and amount of soil. Some soils suit warmer washes eg oily soils, while others are best washed in cold water eg mud, blood.

#### Colour

Sort white fabrics from coloured fabrics.

#### Lint

Wash lint givers and lint collectors separately. Where possible, turn lint collectors inside out.

### Loading

#### Check pockets

Loose items can damage both your *Smart Drive™* and your clothes.

#### Close zippers, hooks and eyes

This is to make sure that these items do not snag on other clothes.

#### Mend any torn garments or loose buttons

Tears or holes may become larger during washing. Remove any loose bra wires as they can damage your washing machine and/or dryer.



#### Pretreat any stains

#### Make sure the water level suits the load size

Select the correct water level by using the mark on the agitator nearest to the top of the load. Ensure that the load does not extend above the fabric softener dispenser as splashing may occur.

#### For a balanced load

- Place unfolded clothes firmly and evenly around the agitator.
- Do not wrap large items, such as sheets, around the agitator.
- A mixture of small and large items will wash the best.

	Machine Washable Warm 40°C max Warm Rinse Well Normal Spin
	Do not bleach
	Do not tumble dry Dry in shade
	Warm iron
	Dry Cleanable

Examples of different care label symbols.

Lint givers	Lint collectors
Towels	Synthetics
Chenille	Corduroy
Nappies	Poly cotton
	Socks



## Choosing the right detergent

We recommend using domestic detergents, (powder, liquid or tablets).

Soap flakes or granulated soap powders should not be used in your *Smart Drive™* eg Lux Soap Flakes.

When washing woollens remember to use a detergent recommended by the New Zealand Wool Board or Australian Wool Corporation.

## How much detergent?

Use the instructions on the back of the detergent packet as a guide to the correct amount of detergent to use. The correct amount of detergent will vary depending on the amount of soil in your clothes and the size of your load. Jeans and work clothes may need more detergent, while towels usually need less. The larger your machine the more detergent, you may have to add.

## Adding the detergent

### Tablets:

Place the required number of tablets down the centre of the agitator.

(**DO NOT** use the bag provided with the tablet products).

For low water level loads (ie washing 2 or 3 garments) do not place the tablet down the agitator. Instead place directly into the machine before adding your clothes.

## Liquid or powdered detergents:

- 1 Remove fabric softener dispenser.
- 2 Pour liquid or powdered detergent down the centre of the agitator.  
Some detergents **MUST** be fully dissolved before adding to your machine to get the best wash results. Check the instructions on the detergent packet. Pre-dissolving the detergent when washing in cold water can improve its performance.
- 3 Replace fabric softener dispenser. (This prevents small articles falling down the centre of the agitator).

Concentrate			
Model	Compact 5.5kg	Medium 6.5kg	Large 7.5kg
water level	Number of scoops		
high	1 rounded	1½	1½
med high	1 scant	1 heaped	1½
medium	¾	1 scant	1
med low	½	⅔	¾
low	⅓	⅓	½

Standard Powder			
Model	Compact 5.5kg	Medium 6.5kg	Large 7.5kg
water level	Based on a metric cup		
high	¾ cup	1 cup	1 cup
med high	⅔ cup	¾ cup	1 cup
medium	½ cup	⅔ cup	¾ cup
med low	⅓ cup	½ cup	½ cup
low	¼ cup	⅓ cup	⅓ cup

Liquid			
Model	Compact 5.5kg	Medium 6.5kg	Large 7.5kg
water level	Number of caps		
high	1 cap	1¼ cap	1½ cap
med high	1 cap	1 cap	1¼ cap
medium	¾ cap	¾ cap	1 cap
med low	½ cap	½ cap	¾ cap
low	⅓ cap	⅓ cap	½ cap

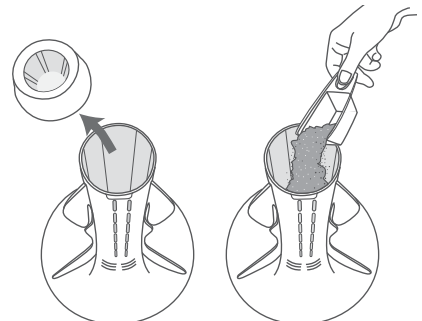

Fig.16 Adding your detergent

### How the fabric softener is dispensed

The fabric softener goes into the dispenser on the top of the agitator. During the rinse the machine spins to release the fabric softener, delivering it down the agitator stem as the machine fills for the final deep rinse.

Note: the **ECO** option is not designed to be used with fabric softener. It does not use a deep rinse so the machine cannot dispense fabric softener correctly.

### How much fabric softener?

The ring on the dispenser cup is a guide for the amount of fabric softener to add for a full load. Smaller loads require less fabric softener.

### Cleaning the dispenser

When using fabric softener, rinse your dispenser at the end of each wash.

- 1 Separate the cup from the dispenser body by pushing downward on the base of the cup.
- 2 Rinse both parts of the dispenser using warm soapy water.

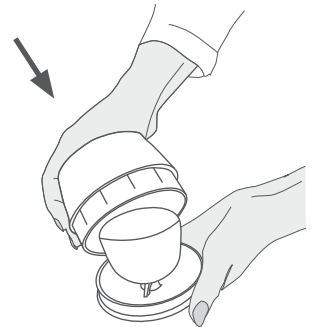

*Fig.17 Push cup through dispenser with thumb*

### Scrud

Scrud is the name given to the waxy build-up that can occur within any washer when the fabric softener comes into contact with detergent. This build-up is not brought about by a fault in the machine. If scrud is allowed to build-up in the machine it can result in stains on your clothes or an unpleasant smell in your washer.

If you wish to use fabric softener we recommend:

- Using fabric softener sparingly.
- When filling the dispenser, do not splash or overfill.
- Clean dispenser as soon as the cycle has finished.
- Clean your machine regularly. (Refer page 21).
- Cold water washing increases the chance of this build-up occurring. We recommend a warm or hot wash at regular intervals eg approx. every 5th wash.
- Fabric softener of a thinner consistency is less likely to leave residue on the dispenser and contribute to a build-up.

## Option Adjustment mode

After using your *Smart Drive™* you may want to fine tune some of the options to suit your wash needs.

There are a number of preset options, which can be altered:

- the warm wash temperature
- the rinse option on **HEAVY DUTY**, **REGULAR** and **WOOL** cycles
- the Out of Balance Recovery routine.

### To enter Option Adjustment mode

- 1 Turn machine on at the wall but do not press **POWER**. Press **START/PAUSE** and hold down, then press **POWER**. You will hear two quick beeps and the machine will show an unusual pattern of lights. In this mode the lights are used to indicate the different options available. **The diagram on page 18 shows how the lights relate to the options you can change. Pages 19 – 20 explain the different options in more detail.**
- 2 Use the buttons on the panel to make your changes to the pre-set options.
- 3 Press **POWER** to return to normal mode.
- 4 Your *Smart Drive™* will automatically remember your changes.

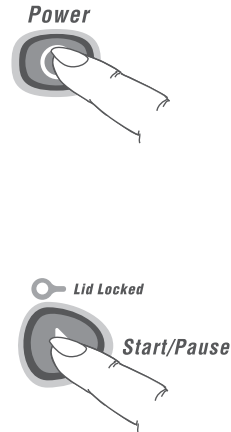

Fig.18 Entering Option Adjustment mode

## 18 Changing pre-set options

- 1 Press **START/PAUSE** and hold down. Press **POWER**.
- 2 The diagram below shows how the lights relate to the options you can change. It also shows what lights will be on when you first enter the Option Adjustment mode.

Use this diagram to help you adjust the options:

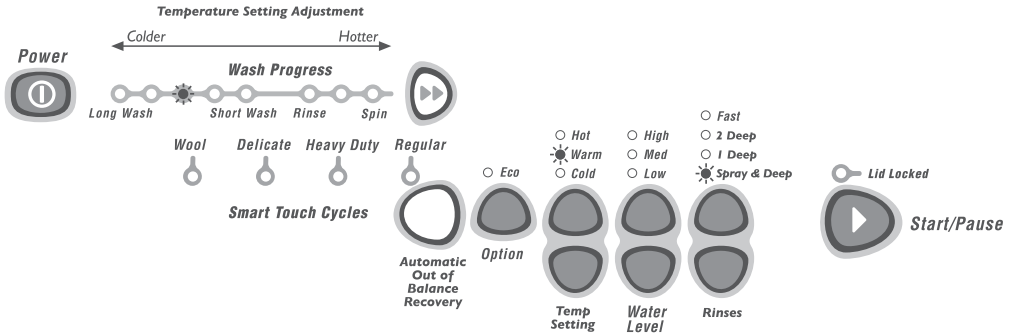

Fig.19 Option Adjustment mode options

- 3 Use the buttons on the panel to change the pre-set options.

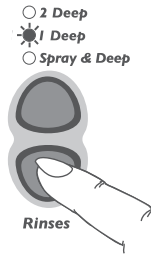

Fig.20 Modifying pre-set options

## Wash temperatures

The warm temperature can be adjusted if you think it is too hot or too cold.

Note: on these models the hot temperature will be the same as the hot water supply temperature.

- 1 Select the **WASH TEMP** you want to adjust.
  - 2 The wash progress lights show the temperature adjustment possible for that temperature.
- Pressing the **▶▶** button will cause the wash progress light that is on to change.
  - Advancing the **WASH PROGRESS** light will increase the wash temperature. If you keep pressing the **▶▶** button, the light will scroll back to the coldest setting available for that wash temperature.

Note: if you still can't get the temperature you require, advance the progress light (while in the options adjustment mode) across to spin and manually adjust the flow of the taps.

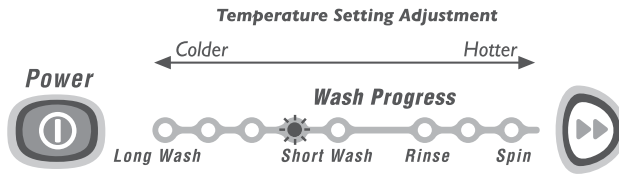

Fig.21 Adjusting the temperature setting

## Rinse options

On the **HEAVY DUTY**, **REGULAR** and **WOOL** cycles you can change the pre-set rinse option.

The pre-set rinse option on these cycles is a spray rinse followed by a deep rinse. The spray rinse may be replaced with a short spin or a deep rinse.

If you have a problem with impurities in your water supply you may get a better wash if you change the rinse option to 2 deep rinses. If you want to conserve water change the rinse option to 1 deep rinse. If you want to conserve even more water, choose the **ECO** option.

Rinse options		
<b>MED spin light on</b>	Deep rinse	Deep rinse
<b>SLOW spin light on</b>	Short spin	Deep rinse
<b>HOLD light on</b>	Spray rinse	Deep rinse

## Out of Balance Recovery routine

When your *Smart Drive™* is spinning it can sense if the wash load is out of balance and will stop and re-try spinning up to 3 times. If it still senses an unbalanced load there are two options the machine can take.

### Automatic Recovery option

Your *Smart Drive™* will try to automatically correct the out of balance load. It will fill with water and agitate to redistribute the load before trying to spin up again.

### Machine Stops option

Your *Smart Drive™* will stop, give a short burst of beeps every 5 seconds, and the **RINSE** or **SPIN** light will flash. You must redistribute the load more evenly yourself. (Use this option if you wish to conserve water).

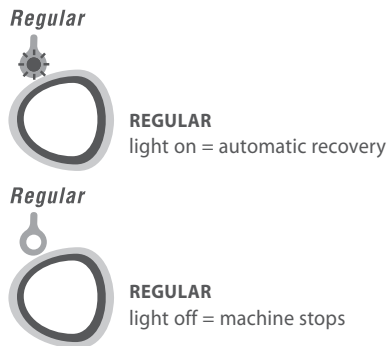

Fig.22 Adjusting Out of Balance Recovery routine

## Machine information

To find out the size of your machine, look on the back of your washer.

### Specifications

Size	Capacity	Depth	Width	Height*	Height (Lid Open)
Large	7.5 kg	650 mm	650 mm	1020 – 1050 mm	1410 – 1440 mm
Medium	6.5 kg	600 mm	600 mm	1020 – 1050 mm	1360 – 1390 mm
Compact	5.5 kg	560 mm	560 mm	1020 – 1050 mm	1320 – 1350 mm

- Electrical Supply: 220 – 240V, 50Hz Sinusoidal, 165W
- Inlet Water Pressure: Max. 1MPa (150 psi) Min. 34Pa (5 psi)
- Inlet Water Flow Rate: Min. 3 litres/min
- Standpipe Height: 850 – 1200 mm

Note: exact height of your washer is dependent on how far the feet are inserted onto the base of the machine.

\*Height is measured to the highest point on the console.

## When you have finished

- Turn off the taps to prevent the chance of flooding should a hose burst.
- Turn off the power at the wall.

## Cold water washing

If you always use cold water, we recommend that a warm or hot wash be used at regular intervals, eg every 5th wash should be at least a warm one.

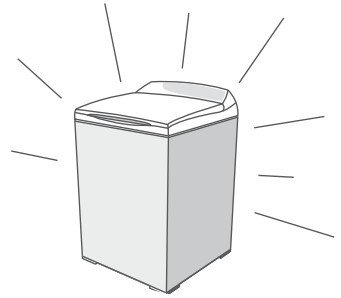

## Cleaning your washer

- Clean with a soft damp cloth and wipe dry. Do not use scouring cleaners as they can damage the paint, plastic and panel surfaces.
- Clean the fabric softener dispenser after each cycle using warm soapy water.
- You can remove the lid for cleaning. Open the lid fully, hold one side with one hand and gently tap the other side with an upward motion.  
To replace the lid, hold the lid vertically and align both hinges before pushing down firmly.
- To remove the agitator for cleaning, unscrew the nut down the centre of the agitator by turning anti-clockwise.

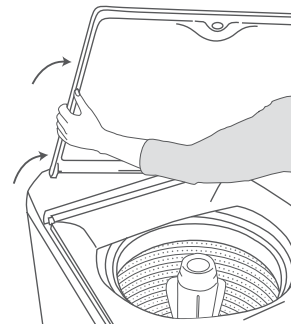

*Fig.23 Removing the lid*

**The agitator must be fully pushed on to the shaft when refitting. Tighten the nut firmly by hand. Ensure the agitator is not loose.**

## Cleaning the inside of your washer

If you use fabric softener or do regular cold water washing, it is important that you occasionally clean the inside of your machine.

- Fill your machine with hot water. Add about two cups of a powdered detergent.
- Let it agitate for 10 – 15 minutes.
- Stop the machine, **open the lid**, and leave it to soak overnight.
- After soaking, drain the machine and run the machine through a regular cycle.  
We do not recommend that you wash clothes during this procedure.

### Products that might damage your washer

- Concentrated bleaches, nappy sanitisers and hydrocarbon solvents (eg petrol and paint thinners) can cause damage to the paintwork and components of your washer. (Be careful when washing garments stained with solvents as they are flammable. DO NOT put them in your dryer).
- Do not use pre-treatment sprays or liquids on or near your washer as they can damage your machine's control panel.
- Use of dyes in your washer may cause staining of the plastic components. The dye will not damage the machine but we suggest you thoroughly clean your washer afterwards. We do not recommend the use of dye strippers in your washer.

### Sounds and beeps

Your washer will make sounds that you will not have heard from other washers.

- During drain you will hear the pump in your machine turn off and on quickly about every 10 seconds. This is part of the automatic lint removal system.
- While draining your machine may give several low thuds. Your machine is checking that the water has drained before spinning.
- Your washer will beep at the end of the cycle and if you have used Spin Hold or Soak.
- If your machine is beeping continuously or giving a musical series of beeps refer to page 23.

### Automatic lint system

Your washer has a self cleaning lint system. It automatically separates the lint from the wash water, trapping the lint between the inner and outer bowls and flushes it out at the end of the wash.

### Water consumption – litres per cycle

Size	Litres per Fill	Eco option	Spray & Deep Rinse	1 Deep Rinse	2 Deep Rinses
Large	90 L	105 L	175 L	165 L	215 L
Medium	75 L	90 L	150 L	140 L	190 L
Compact	65 L	76.5 L	130 L	120 L	160 L

(Please note these are approximate figures for high water levels.)



Your washer is capable of diagnosing its own troubles. If your washer gives a musical series of beeps every 5 seconds it is telling you that it has a problem which YOU can solve using the checklist below.

\* The beeps are the same sound your washer makes when you turn it on at the wall.

## Musical series of beeps\* every 5 seconds and... possible solutions

### **HOT water temperature light is flashing.**

Hot water supply is not hot enough to maintain the wash temperature you have selected. Select a lower wash temperature.

Inlet hose screens may be blocked.

There may be a kink in the hose (Refer to page 4).

Hot tap has not been turned on.

Inlet hoses connected to the wrong taps.

### **COLD water temperature light is flashing.**

Cold tap has not been turned on.

Inlet hose screens may be blocked.

There may be a kink in the hose. (Refer to page 4).

Inlet hoses connected to the wrong taps.

Cold water temperature exceeds recommended limits. (See 'Installation Instructions' page 5).

The flow rate of the supply water is too slow.

### **HOT and COLD water temperature lights are flashing.**

The taps have not been turned on.

Inlet hose screens may be blocked.

The hoses may be kinked. (Refer to page 4).

The drain hose is too low or the drain hose is pushed into the standpipe too far and the water is siphoning out of the machine. (See 'Installations Instructions' page 3).

The flow rate of the supply water is too slow.

### **HIGH water level light is flashing.**

The machine is overloaded and can not agitate. Ensure the machine is stationary. Remove items until the remaining ones can move freely.

Select a higher water level.

### **The first RINSE light or SPIN light is flashing.**

The machine has a suds build-up. (Too much detergent may have been used for the amount of soil in the load.) Wait for suds to dissolve (about 20min). Rinse clothes using a deep rinse.

## 24 If your washer beeps for help

### **LID LOCK light is flashing.**

Make sure the lid is closed.

Press **START/PAUSE** (refer to page 8).

If the symptom persists call your Fisher & Paykel Dealer or Authorised Service Centre.

### **First RINSE or SPIN light is flashing as well as the SPIN SPEED light.**

Wash load is out of balance. Ensure the machine is stationary. Manually redistribute the load.

Check the machine is level (refer to page 4).

## Single beep every second and... possible solutions

### **Some lights are on but the pattern of lights is unfamiliar.**

- 1 Turn your machine off at the wall,
- 2 Wait for 60 seconds and turn it back on.
- 3 Check the machine is level (Refer to Page 4).
- 4 Remove load and retry.
- 5 Put through a Deep Rinse and **SPIN** (advance wash progress to second rinse light and push **START/PAUSE**).
- 6 If the fault re-occurs repeat Step 1.

If the machine still will not work call your Fisher & Paykel Dealer or Authorised Service Agent to arrange service (refer to page 28).

---

**Pressing POWER does not turn the machine on.**

---

Is the power switched on at the wall?

Switch the power off at the wall and wait 60 seconds before turning the power on again.

Could your household power supply be at fault? Try plugging in another electrical appliance.

---

**Pressing START/PAUSE does not start the fill.**

---

Are both hot and cold taps turned on?

Are the inlet hose filters blocked?

---

**Filling continuously.**

---

Check that the machine is not syphoning (refer to page 3 in the 'Installation Instructions').

---

**Not spinning properly.**

---

Is the load out of balance? (refer pages 11,13 and 20).

Check the machine is level and does not rock (refer page 4).

It may have suds build-up (refer to rinse light or spin light flashing, page 23).

---

**Spin speed sounds slower than it should.**

---

The clothes are unevenly distributed in the bowl, your washer has compensated by lowering the spin speed.

---

**Machine is continually going out of balance.**

---

Check the machine is level and does not rock (refer to page 4).

Too much water for load (refer to page 11).

---

**Noises.**

---

Banging – load is out of balance (refer pages 11, 13 and 20).

Other noises – refer page 22.

---

**Small puddle of water coming from under the machine.**

---

The water level is too high for the amount of clothes. This has caused excessive splashing. Use a lower water level. (Refer to page 11).

Large bulky, garments (eg pillows, duvets) can cause splashing. Wash on **DELICATE** cycle (refer to page 13).

---

If the problem persists contact your Fisher & Paykel Dealer or Authorised Service Centre (refer to page 28).

## Wash problems

Listed below are possible causes and solutions to some common wash problems.

### Creasing.

Overloading the washer or dryer.

Choose the **DELICATE** cycle which has been designed to minimise creasing.

Try selecting a slower spin speed.

Do not leave wet clothes to sit in the washer or laundry basket.

### Poor Soil Removal.

Warm wash water is too cold. Refer to 'Changing pre-set options' page 19.

Not enough detergent for load size or amount of soil.

White clothes are better washed separately. Separate light and heavily soiled items, as clothes can pick up soil from dirty wash water.

Select the wash temperature according to soil type. For example, blood and mud are better washed in cold water, while oily soils wash better in warmer water.

Overloading the washer.

Loads made up of articles of varying sizes will wash better (eg full loads of sheets may not wash as well).

Hard water requires more detergent than soft water.

### Linting.

Wash lint gives eg towels, flannelette sheets, separately from lint collectors eg synthetic fabrics.

Overloading the washer.

Not enough detergent to hold the lint in suspension.

Overdrying in a dryer can cause a build-up of static electricity in synthetic fabrics and cause them to attract lint.

### Residue Detergent.

Overloading the washer.

Try using less detergent.

Some detergents need to be pre-dissolved, check the detergent instructions.

Cold ambient temperatures and cold washes or short agitation times may not let the detergent dissolve properly. Try pre-dissolving the detergent.

### Black or Grey Marks on Clothes.

A buildup caused by the interaction of fabric softener and detergent can flake off and mark clothes. (Refer to 'Scrud' page 16).

Insufficient detergent, for the amount of soil on the clothes, can result in grey marks on clothes. (Refer to 'Detergent' page 15).

### Dye Transfer.

Wash and dry non-colourfast clothes separately.

Non colourfast clothes left sitting in a washer or laundry basket can transfer dye to other clothes.

### Tangling.

Washing with too much water (ie underloading) can cause the clothes to tangle around one another.

Do not load the washer by wrapping clothes around the agitator.

You automatically receive a 2 year Manufacturer's Warranty with the purchase of this Product covering parts and labour for servicing within the country of purchase.

## **Fisher & Paykel undertakes to:**

Repair or, at its option, replace without cost to the owner either for material or labour any part of the Product, the serial number of which appears on the back of the Product, which is found to be defective within TWO YEARS of the date of purchase.

## **This warranty DOES NOT cover**

- A** Service calls which are not related to any defect in the Product. The cost of a service call will be charged if the problem is not found to be a Product fault. For example:
  - 1. Correcting the installation, eg removal of transit packer, levelling the machine, adjustment of the drain to correct syphoning, noises, crossed, kinked or leaking inlet hose connections, turning on water or power supplies.
  - 2. Noise or vibration that is considered normal, eg spin sounds, user warning beeps.
  - 3. Water on the floor due to incorrect loading or excessive suds.
  - 4. Providing instruction on use of the product or changing the set-up of the product, eg setting up Controlled Cold, instruction on correct use of detergents and fabric softeners.
  - 5. Blocked pumps, removal of foreign objects/substances from the machine, including the pump and inlet hose filters, eg bra wires, bread tags, nails, grit, crud etc.
  - 6. Replacing fuses in or correcting house wiring or correcting house plumbing, eg unblocking drains.
  - 7. Correcting corrosion or discolouration due to chemical attack.
  - 8. Correcting damage caused by pests, eg rats, cockroaches etc.
- B** Defects caused by factors other than:
  - 1. Normal domestic use or
  - 2. Use in accordance with the Product's User Guide.
- C** Defects to the Product caused by accident, neglect, misuse or 'Act of God'.
- D** Correction of unauthorised repairs.
- E** Normal recommended maintenance as set out in the Product's User Guide.

Service under this manufacturer's warranty must be provided by an Authorised Service Agent (refer to the Customer care section for contact details). Such service shall be provided during normal business hours. This warranty certificate should be shown when making any claim.

Note: this warranty is an extra benefit and does not affect your legal rights and applies only to product purchased in New Zealand and Australia.

**Please keep this User Guide in a safe place.**

**Before you call for service or assistance ...**

Check the things you can do yourself. Refer to the installation instructions and your user guide and check that:

- 1 Your appliance is correctly installed.
- 2 You are familiar with its normal operation.



If after checking these points you still need assistance, please refer to your nearest AUTHORISED SERVICE CENTRE, or contact us through our local website listed on the back cover.

**In New Zealand if you need assistance...\***

Call your Fisher & Paykel retailer who is trained to provide information on your appliance, or if we can be of any further help, please contact our Customer Care Centre,

**Toll Free:** 0800 FP CARE or 0800 37 2273

**Fax:** (09) 273 0656

**Email:** customer.care@fp.co.nz

**Postal address:** Fisher & Paykel Appliances Limited, PO Box 58732 Greenmount, Auckland

**If you need service...\***

Fisher & Paykel has a network of independent Fisher & Paykel AUTHORISED SERVICE CENTRES whose fully trained technicians can carry out any service necessary on your appliance. Your dealer or our Customer Care Centre can recommend an AUTHORISED SERVICE CENTRE in your area.

**In Australia if you need assistance...\***

Call our Fisher & Paykel Customer Care Centre and talk to one of our Customer Care consultants.

**Toll Free:** 1300 650 590

**Fax:** (07) 3826 9298

**Email:** customer.care@fp.com.au

**Postal address:** Fisher & Paykel Appliances Limited, PO Box 798, Cleveland, QLD4163

**If you need service...\***

Fisher & Paykel Australia Pty Ltd has a network of independent Fisher & Paykel AUTHORISED CUSTOMER SERVICE CENTRES whose fully trained technicians can carry out any service necessary on your appliance. Our Customer Care Centre can recommend an AUTHORISED SERVICE CENTRE in your area.

\*If you call or write, please provide: name, address, model number, serial number, date of purchase and a description of the problem. This information is needed in order to better respond to your request for assistance.

**Product details can be found on the top left hand side of the console or back panel of the washer cabinet.**

**Product details**

Fisher & Paykel Appliances Ltd

**Model/Serial No.**

**Date of Purchase** \_\_\_\_\_ **Purchaser** \_\_\_\_\_

**Dealer** \_\_\_\_\_ **Suburb** \_\_\_\_\_

**Town** \_\_\_\_\_ **Country** \_\_\_\_\_



**Copyright Reserved © Fisher & Paykel 2009.**

The product specifications in this booklet apply to the specific products and models described at the date of issue. Under our policy of continuous product improvement, these specifications may change at any time. You should therefore check with your Customer Care Centre to ensure this booklet correctly describes the product currently available.

**[www.elba.co.nz](http://www.elba.co.nz)**  
**[www.elba.com.au](http://www.elba.com.au)**

NZ AU  
Clothes washer  
Installation instructions and user guide  
Published: 04/2009  
**Part No. 421307**