

Installation instructions RACO Freestanding Classic aluminum door frames

Freestanding frames install ceiling height or less than ceiling height. Specify regular studs for 5/8" gypsum board; specify "shim" studs for 1/2" board.

Freestanding "separate studs" frames (Gyp-board screws concealed)

Freestanding "FASTRAK®" frames (Gyp-board screws outside jambs)

RACO parts list (Separate studs)

- 1 FS-1 door header with clips installed
- 1 FS-2S hinge jamb & FS-3S strike jamb
- 1 pair R-3A aluminum studs
- 10 R-4 speed screws and 2 snap-on stops
- 1 R-46 strike clip with screws and washers

RACO parts list (FASTRAK studs)

- 1 FS-1 door header with clips installed
- 1 FS-2F hinge jamb assembly with stud segments and stop installed
- 1 FS-3F strike jamb assembly with studs segments and stop installed
- 2 R-4 speed screws
- 1 R-46 strike clip with screws and washers

Rough opening = Door opening width + 1 1/4", door opening height + 1/2". Hold drywall stud back 4" each side (approximately 10" for 1/2" board).

Rough opening = Door opening width + 1 1/4", door opening height + 1/2". Hold drywall stud back 4" each side (approximately 10" for 1/2" board).

Preliminary steps: Cut RACO studs to frame height less 4".
Cut jambs to floor if necessary.

Preliminary steps: Cut jambs to floor if necessary.

Step 1: Shoot drywall track to floor. Put RACO studs in wall (no clips).

Step 1: Shoot drywall track to floor. Put RACO frames in wall. Remove short stop pieces at tops of jambs and screw jambs to header clips. Replace stop pieces.

Step 2: Plumb hinge stud and screw off gyp-board. Align strike stud with hinge stud using door opening plus 3/16" and screw off gyp-board.

Step 2: Plumb hinge stud and screw off gyp-board.

Step 3: Put frame over studs and install header. Screw jambs to header clips. Screw hinge jamb to stud. Attach stop.

Step 3: Hang door, if available, and swing closed. Adjust strike jamb for even cracks at top and edge of door. If door is not available, adjust header with level and jamb with spreader. Screw off gyp-board. Note: stud segments are drilled for hinge screws but are not threaded; RACO R-25 or R-25ND self-threading screws are recommended, pages 00 & 00.

Step 4: Hang door, if available, and swing closed. Adjust strike jamb for even cracks at top and edge of door. If door not available, adjust header with level and jamb with spreader. Screw strike jamb to stud. Attach stop. Note: Studs are not drilled for hinge screws; RACO R-25 self-drilling screws are recommended, pages 00 & 00.

Note: Install aluminum studs with 1" No. 6 drywall screws, spaced 12" on center, each side of wall. Lowermost screws shall penetrate floor track.

Note: Install hinge and strike stud segments with 1" No. 6 drywall screws, using three screws each side of wall for each segment. Lowermost screws shall penetrate floor track.

Approximate time to install frame and hinges:
One carpenter - 26 minutes

Approximate time to install frame and hinges:
One carpenter - 16 minutes

Approximate time to hang pre-machined door:
One carpenter - 4 minutes
(no lockset)

Approximate time to hang pre-machined door:
One carpenter - 4 minutes
(no lockset)

Installation times for both types of frames are based on all required tools and material being available at a prepared rough opening.

RACO FREESTANDING frame styles compared.

AS SHIPPED

AS INSTALLED

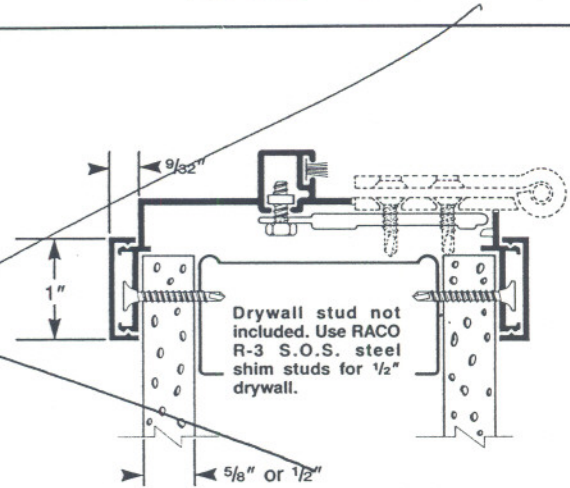
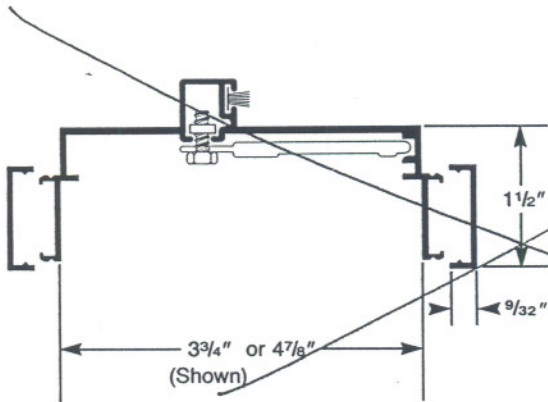

Scale: 6" = 1'0"

New TRIMSTYLE design

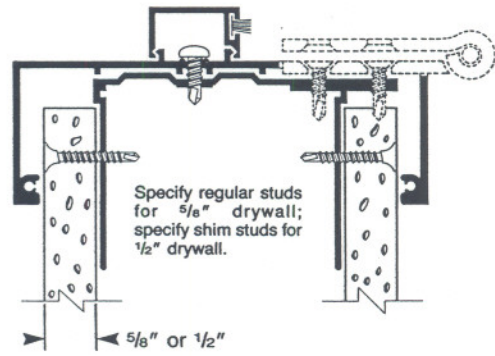
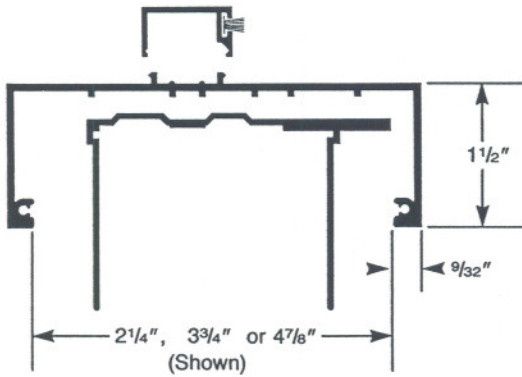

Scale: 6" = 1'0"

RACO CLASSIC design with separate studs

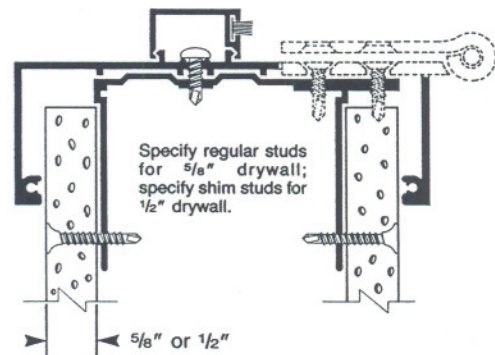
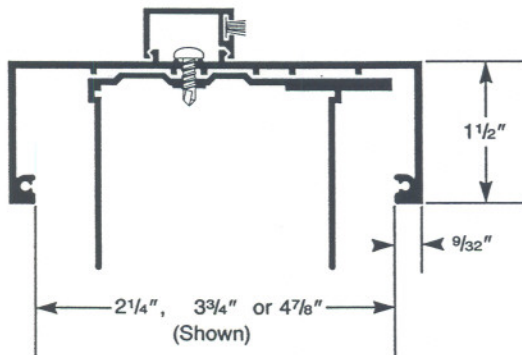

Scale: 6" = 1'0"

RACO CLASSIC design with FASTRAK® studs

RACO Freestanding CLASSIC prefinished aluminum door frames and sidelite frames. (U.S. Patent Nos. 3,676,966; 3,886,688; and 4,126,343).

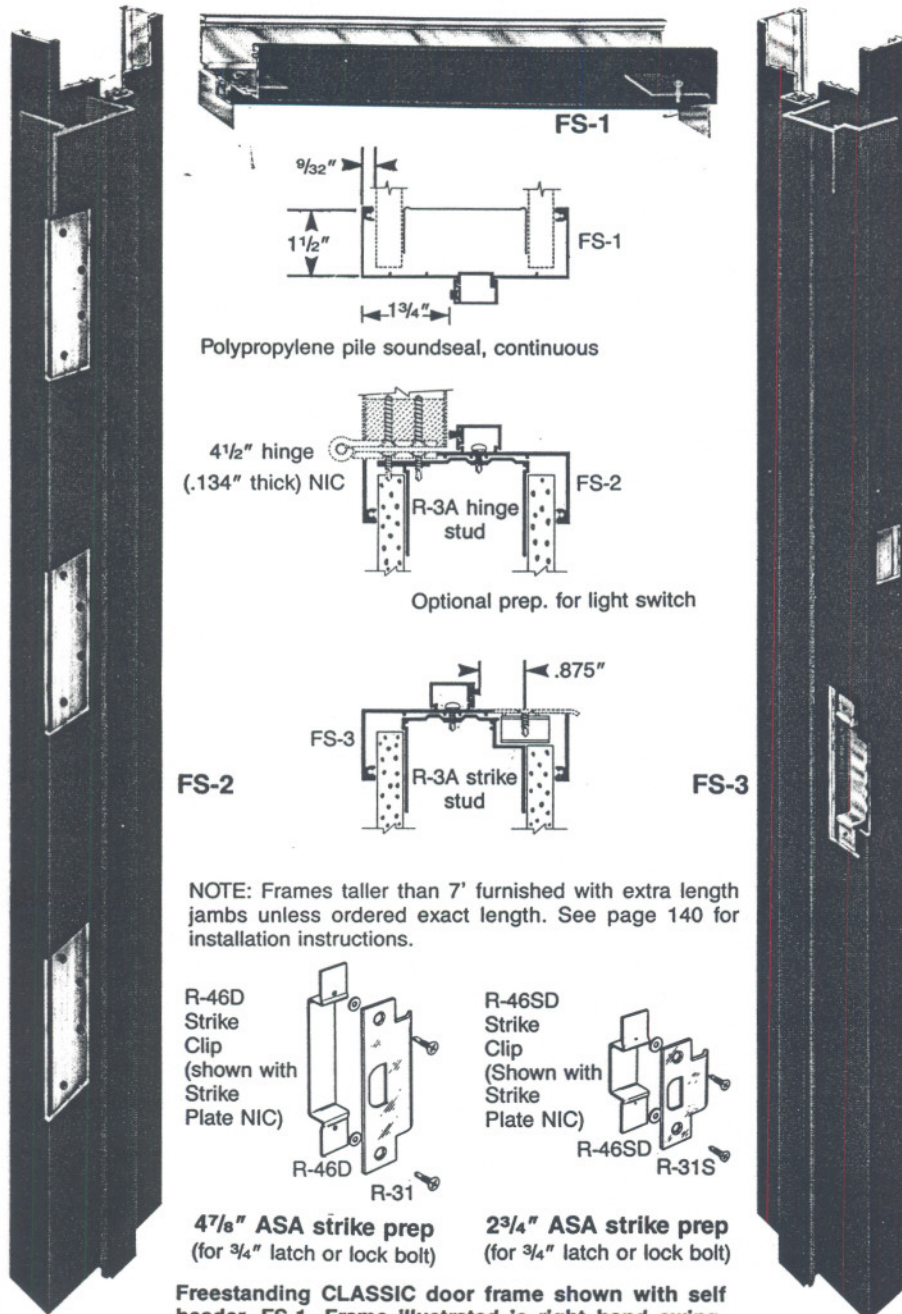

NOTE: Frames taller than 7' furnished with extra length jambs unless ordered exact length. See page 140 for installation instructions.

R-46D
Strike
Clip
(shown with
Strike
Plate NIC)

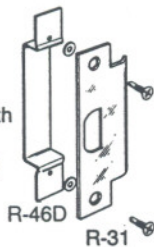

47/8" ASA strike prep
(for 3/4" latch or lock bolt)

R-46SD
Strike
Clip
(Shown with
Strike
Plate NIC)

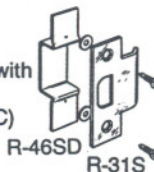

23/4" ASA strike prep
(for 3/4" latch or lock bolt)

Freestanding CLASSIC door frame shown with self header, FS-1. Frame illustrated is right hand swing. Optional prep. for light switch - pp 58, 59.

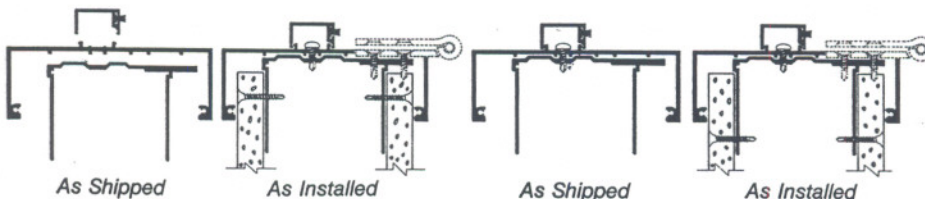

"Separate studs" is the designation for Freestanding CLASSIC frames furnished with unassembled, full-length aluminum studs; the studs are installed independently so that dry-wall screws can be covered by jamb members of the frame. Installation time for Freestanding frame with separate studs: 26 minutes for one person. (Note: Hinge holes in full lengths studs to be job drilled; use R-25 hinge screws.)

"FASTRAK studs" is the designation for Freestanding CLASSIC frames with factory assembled stud segments; frames so equipped are fastest to install and can use the door as a template for maximum precision. Drywall screws require spackling. Installation time for Freestanding FASTRAK frames: 16 minutes for one person. (Note: Hinge holes factory punched; use R-25 hinge screws.)

"Freestanding" CLASSIC frames install ceiling height or less in conjunction with FS-1 integral type door frame headers. These headers terminate at the jambs of the frame. Any type of partition header except continuous PR-1 can be used. Freestanding sidelite frames use a modified header consisting of PR-1 or PR-6 which terminate at the frame jambs and carry a section of PR-4 over the door section, and PR-5 over the glass.

Freestanding CLASSIC frames are furnished with aluminum attachment studs or stud segments. The attachment studs carry all door weight and are secured directly to wall panels for maximum strength and elimination of twisting moment. The header serves as a thrust member to carry the door weight from the hinge to the strike side of the frame. In this manner, any pull-out tendency due to door weight is effectively overcome.

Freestanding CLASSIC frames are prefinished in D-3 dark bronze, satin black, or frost white Duralaq. This hard, chip-resistant baked coating is comparable to automotive finishes. Other colors and all anodized finishes are available on special order. Series 375 frames are stocked in natural anodized finish in addition to Duralaq.

RACO Freestanding CLASSIC frames up to 3' x 9', single, and 6' x 9', double are fire-rated and 20-minute labeled for use in one-hour partitions in all throat sizes, 2 1/4", 3 3/4" and 4 7/8". Single sidelite frames can also be rated with 12 1/2" exposed width of rated glass. Only three 4 1/2" x 4" template hinges per jamb are required for any of the rated frames (.134 ga. only).

Aluminum attachment studs for each of the three throat sizes of Freestanding CLASSIC frames are available to accommodate either 1/2" or 5/8" thick gypsum board. The studs for 5/8" board are called "regular" studs and those for 1/2" board are called "shim" studs. Studs can be either screw-attached or secured with modified contact adhesive (no screws). Thus the three stock jamb members, series 225, series 375, and series 487 are readily adapted to a wide range of partition designs.

Either 2 3/4" or 4 7/8" ASA strike plates are held in place by means of cold-drawn steel clamp-in strike boxes which are furnished with each frame. Prep. is available for electric strikes (see page 56), dead bolt locks (page 55), and jamb mounted light switches (page 59).

RACO Freestanding CLASSIC aluminum sidelite frames

U.S. Patent Nos. 3,676,966; 3,886,688; and 4,126,343)

2-R56B (w/PR-6)
R-20B (w/PR-1)

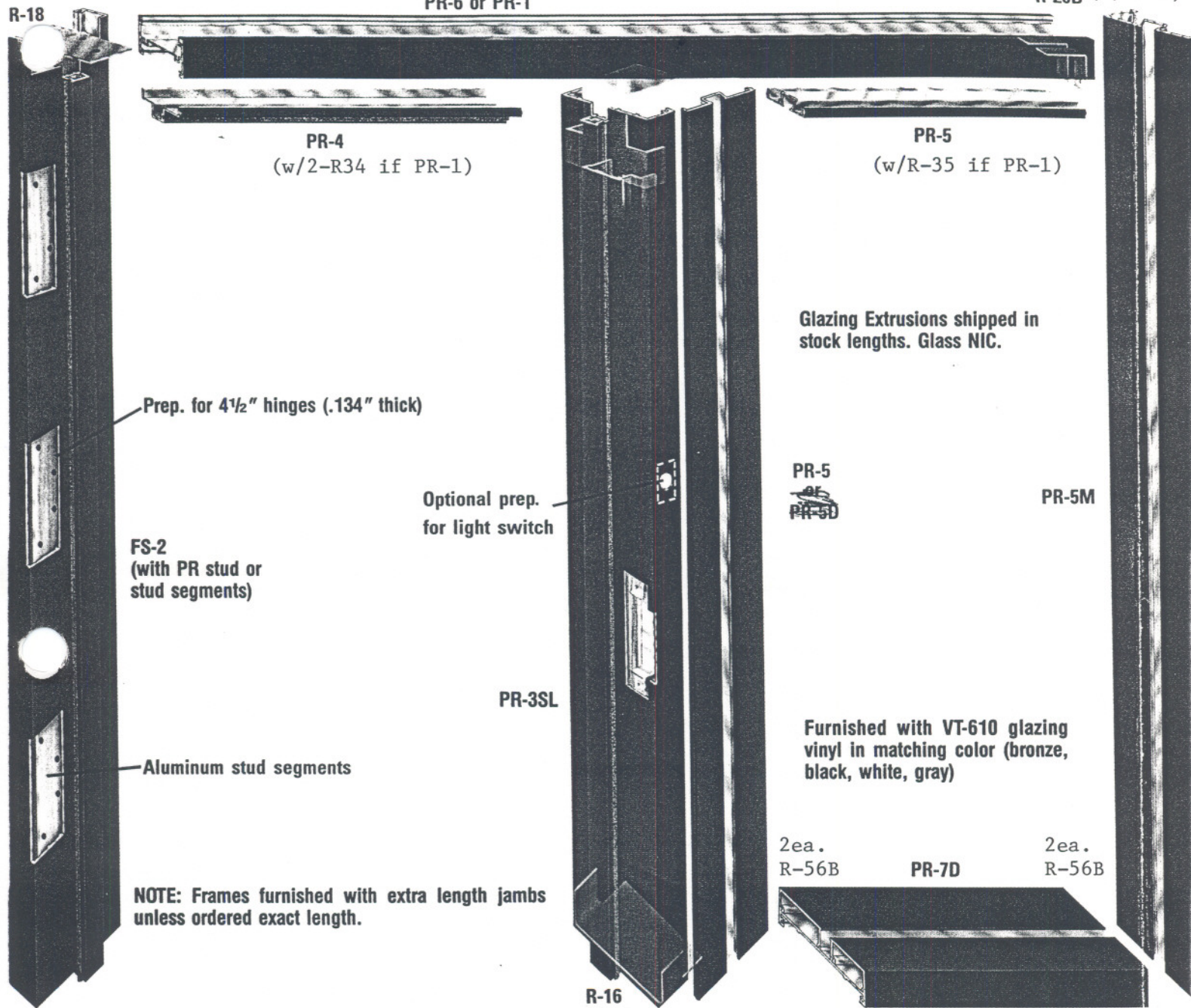

Freestanding CLASSIC single frame shown with continuous header, PR-6. Frame illustrated is right hand swing. Optional prep. for light switch – see pages 58, 59. Sidelite strike jambs are strengthened by full-strength stiff-leg sidelite studs. Additional security can be gained by use of horizontal mull at strike jamb (page 71).

Sidelites can be attached to either or both jambs of Freestanding frames. Glazing extrusions provide $\frac{5}{8}$ " total coverage for glass, a feature of particular importance to glaziers where tempered glass is installed. Frames with glass at the strike jamb are furnished with 12-gage steel stud with 10-gage clip welded on for rigid attachment to header. See page 71 for similar detail.

Installation suggestions: Gypsum board opening is door width plus exposed glass width plus $2\frac{5}{8}$ " for frame illustrated.

1. Install header. Shoot drywall track to floor each side of opening.
2. Install PR-5M. Trim bottom of jambs if required.
3. Install hinge jamb and header with R-18 clip secured to header.
4. Hang door or use spreader to position strike jamb; secure clips.
5. Install PR-5 and PR-7D base portion. Field measure for glass.
6. Install glass, add PR-7D upper portions. Install vinyl furnished with frame if rigid attachment acceptable.

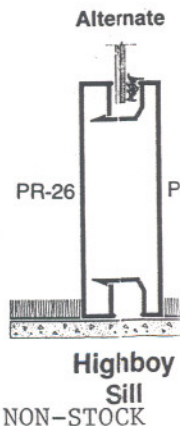

Freestanding CLASSIC prefinished aluminum door frames and sidelite frames

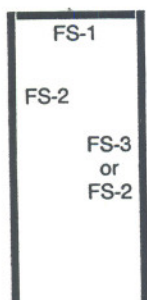
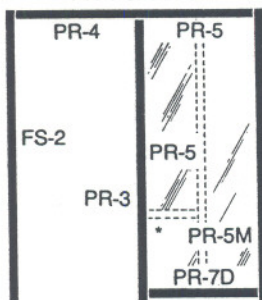
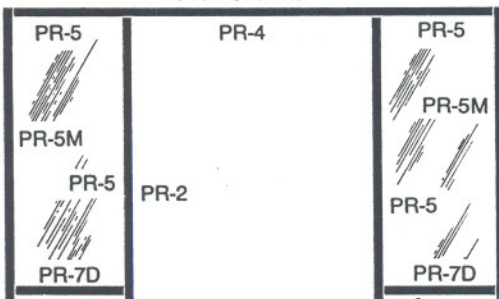
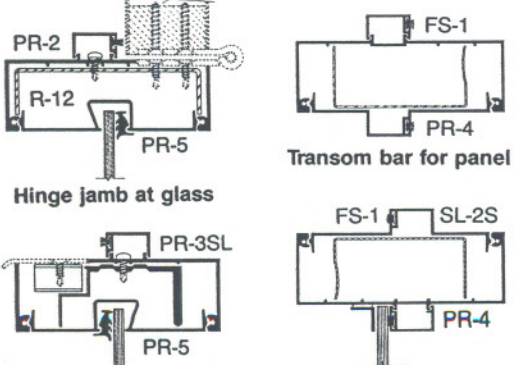
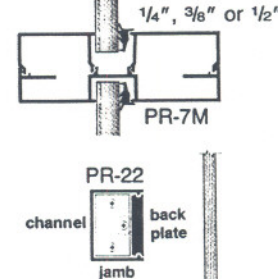
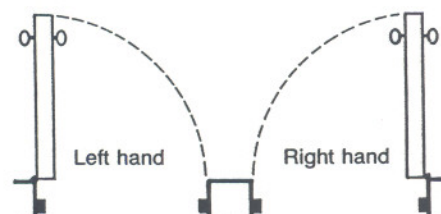
Part & Number No. Scale	Designer series 225 = 2 1/4" throat opening Universal series 375 = 3 3/4" throat opening Institutional series 487 = 4 7/8" throat opening Stock finishes: D-3 dark bronze, satin black, and frost white Duralaq, and black, bronze or natural anodized available on special order. Series 375 stocked in natural anodized in addition to Duralaq.	Typical door opening sizes All frames are fabricated to order in any size to 18' jamb height. Hardware locations are optional. Stock frames are 3-hinge spaced 5"-10" and equal with 4 7/8" ASA strike centered 38" from floor.	Shop Drawing Forms
 <p>FS-123F or S - (Single) FS-122F or S - (Double)</p>	<p>Complete Freestanding CLASSIC door frames - shipped with aluminum studs, steel mounting clips, uncut snap-in header, RACO speed screws, and R-46 strike clip.</p> <p>(a) Specify "Separate studs" (S) frames if separate full length studs are desired. Specify "FASTRAK® studs" (F) for factory installed stud segments. Prices of "F" and "S" types are same for single frames.</p> <p>(b) Specify 5/8" or 1/2" gypsum board.</p> <p>(c) Specify size, swing and finish.</p> <p>(d) Gypsum board opening required is door width plus 1 1/4". First drywall stud should be held back 4" each side of frame for 5/8" board, 10" for 1/2" board. Allow 1/2" clearance at head.</p>	<p>3' x 7' } 3' x 7' 10 1/2" } 3' x 8' 10 1/2" } 3' x 9' 10 1/2" }</p> <p>6' x 7' } 6' x 7' 10 1/2" } 6' x 8' 10 1/2" } 6' x 9' 10 1/2" }</p>	<p>F-1 F-2 F-5 F-3 F-4 F-6</p>
 <p>FS-234F or S-LT (Single) FS-224F or S-LT (Double)</p>	<p>Complete Freestanding CLASSIC door frames with sidelite frames - shipped with aluminum studs, snap-in header, steel mounting clips, glazing vinyl and RACO speed screws. (One steel stud with double frames.)</p> <p>(a) Specify "Separate studs" (S) frames if separate full length studs are desired. Specify "FASTRAK studs" (F) for factory installed stud segments at no change in prices.</p> <p>(b) Specify 5/8" or 1/2" gypsum board; specify whether 1/4", 3/8", or 1/2" glass.</p> <p>(c) Specify size, swing and finish.</p> <p>(d) Specify width of glass opening; 12 1/2" max. fire rated with horizontal safety bar*.</p> <p>(e) Gypsum board opening required is door width plus glass width plus 2 5/8", door height + 3/4" to 1".</p> <p>(f) Glazing extrusions shipped in uncut stock lengths.</p>	<p>3' x 3' x 7' } 3' x 3' x 7' 10 1/2" } 3' x 3' x 8' 10 1/2" } 3' x 3' x 9' 10 1/2" }</p> <p>6' x 3' x 7' } 6' x 3' x 7' 10 1/2" } 6' x 3' x 8' 10 1/2" } 6' x 3' x 9' 10 1/2" }</p>	<p>F-9 F-10</p>
 <p>FS-234-2 LT (Single) FS-224-2 LT (Double)</p>	<p>Complete Freestanding CLASSIC door frames with two sidelites - shipped with steel studs, mounting clips, glazing vinyl and RACO speed screws.</p> <p>(a) Specify size, swing and finish & 1/4", 3/8" or 1/2" glass.</p> <p>(b) Specify width of glass opening; 12 1/2" max. fire rated with horizontal mull safety bar.</p> <p>(c) Gypsum board opening required is door width plus glass width plus 4 1/4", door height (e).</p> <p>(d) Glazing extrusions shipped in uncut stock lengths.</p>	<p>3' x 3' x 3' x 7' } 3' x 3' x 3' x 7' 10 1/2" } 3' x 3' x 3' x 8' 10 1/2" } 3' x 3' x 3' x 9' 10 1/2" }</p> <p>3' x 6' x 3' x 7' } 3' x 6' x 3' x 7' 10 1/2" } 3' x 6' x 3' x 8' 10 1/2" } 3' x 6' x 3' x 9' 10 1/2" }</p>	<p>F-11 F-12 F-13 F-14</p>
 <p>Hinge jamb at glass</p> <p>Strike jamb at glass</p> <p>Transom bar for panel</p> <p>Transom bar for glass</p>	 <p>1/4", 3/8" or 1/2"</p> <p>PR-7M</p> <p>PR-22</p> <p>channel</p> <p>back plate</p> <p>jamb bracket</p> <p>*Horizontal safety bars. Specify type desired, PR-7M or PR-22. Bar required for fire-rated sidelite frames. Additional bars pg. 71.</p>	 <p>Left hand</p> <p>Right hand</p> <p>Swing designations for RACO frames. Non-handed frames are not available.</p>	

**INSTALLATION INSTRUCTIONS FOR A BORROWED LITE
FREESTANDING CONDITION**

Rough Opening Dimensions:

Width: daylight + 1-1/4"

Height: daylight + 1-3/4"

(add 5/8" if sill sitting on floor).

All dimensions may vary to field conditions
(allow approximately 1/8").

- 1.) Cut sample (4" - 6") of PR-6 and PR-7D, cap over rough-in opening at each corner of head and sill to determine length of PR-5M vertical jambs. Jambs must be field notched 7/8" at top and 5/8" at bottom to fit over drywall. After notching is complete, install PR-5M jambs and allow to float until next step is complete.
- 2.) Determine finish width of lite, cut PR-6 and PR-7D and attach at head and sill with drywall screws. All joints to be butt-cut.
- 3.) Using 2 each R-56B clips at each corner, secure PR-5M to head and sill making certain joints are tight.
- 4.) Measure and cut PR-5 snap-in header and PR-7D snaps (wide and narrow).
- 5.) Field measure and install desired thickness of glass (1/4" and 3/8" typical; specify when ordering RACO aluminum material). RACO rubber gasket installs on only one side of glass.

