

International Space Station Systems Engineering Case Study

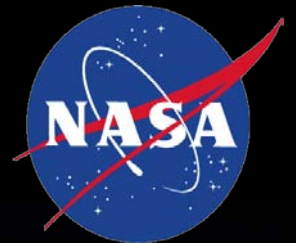

Dr. Bill Stockman
Joe Boyle
Dr. John Bacon



Air Force Center for Systems Engineering

Approved for Public Release; Distribution Unlimited

The views expressed in this Case Study are those of the author(s) and do not reflect the official policy or position of NASA, the United States Air Force, the Department of Defense, or the United States Government.

FOREWORD

One of the objectives of the Air Force Center for Systems Engineering (AFCSE) is to develop case studies focusing on the application of systems engineering principles within various aerospace programs. The intent of these case studies is to examine a broad spectrum of program types and a variety of learning principles using the Friedman-Sage Framework to guide overall analysis. In addition to this case, the following studies are available at the AFCSE website.

- Global Positioning System (space system)
- Hubble Telescope (space system)
- Theater Battle Management Core System (complex software development)
- F-111 Fighter (joint program with significant involvement by the Office of the Secretary of Defense)
- C-5 Cargo Airlifter (very large, complex aircraft)
- A-10 Warthog (ground attack)
- Global Hawk
- KC-135 Simulator

These cases support practitioners of systems engineering and are also used in the academic instruction in systems engineering within military service academies and at both civilian and military graduate schools. Each of the case studies comprises elements of success as well as examples of systems engineering decisions that, in hindsight, were not optimal. Both types of examples are useful for learning. Plans exist for future case studies focusing on various space systems, additional aircraft programs, munitions programs, joint service programs, logistics-led programs, science and technology/laboratory efforts, and a variety of commercial systems.

The Department of Defense (DOD) continues to develop and acquire joint complex systems that deliver needed capabilities to our war fighters. Systems engineering is the technical and technical management process that focuses explicitly on delivering and sustaining robust, high-quality, affordable products. The Air Force leadership has collectively stated the need to mature a sound systems engineering process throughout the Air Force.

As we uncovered historical facts and conducted key interviews with program managers and chief engineers, both within the government and those working for the various prime and subcontractors, we concluded that today's systems programs face similar challenges. Applicable systems engineering principles and the effects of communication and the environment continue to challenge our ability to provide a balanced technical solution. We look forward to your comments on this case study and the others that follow.



John Paschall, Col, USAF
Deputy Director, Air Force Center for Systems Engineering
Air Force Institute of Technology

ACKNOWLEDGMENTS

The authors wish to acknowledge the following contributors (current position and/or relevant ISS role is noted):

Jeff Arend, JSC, Integrated Test, SE Processes

Ginger Barnes, Boeing, Russian Integration, FGB Module

Frank Buzzard, JSC, ISS Chief Engineer, ISS Standing Review Board (ret.)

Lynn Cline, Deputy Associate Administrator for Space Operations, Lead for International Agreement negotiations

Brad Cohen, Boeing, ISS Specifications

Doug Cooke, Associate Administrator for Exploration Systems, NASA

Greg Dorth, JSC, Deputy for Russian Mission Evaluation

James Dunn, JSC, Deputy for Program Integration

Mike Fawcett, MSFC, ESA Columbus Module Integration

Richard Fox, JSC, ISS Program Control

Bill Gerstenmaier, NASA Associate Administrator for Space Operations, ISS PM, Deputy ISS PM

Dan Hartman, JSC, Payload Integration

Mike Hawes, Associate Administrator, Program Analysis and Evaluation, NASA

Dan Jacobs, JSC, Russian Contract

Kathy Koerner, JSC, Payload Integration

Richard Kohrs, Deputy Associate Administrator for Space Station, NASA (ret.)

Joel Montalbano, Manager Russian Spaceflight Program (NASA program presence in Russia)

George Nelson, JSC, ISS Configuration Manager

Mike Rafferty, Boeing, ISS Program Manager

Mike Ryschkewitsch, NASA Chief Engineer

Melanie Saunders, JSC Associate Center Director, ISS Associate Program Manager, NASA

Kirk Shireman, JSC Deputy ISS PM, NASA

Jeff Theall, JSC, Operations and Russian interfaces

Dale Thomas, MSFC, ISS Vehicle Analysis and Integration, Constellation Deputy PM

We must point out the extraordinary insight that was provided by Melanie Saunders from NASA. At the Air Force Center for Systems Engineering, we wish to acknowledge the contributions of the AFIT Project Leader, Charles Garland and the NASA Project Leader, Lisa Guerra.

Bill Stockman, Joe Boyle, & John Bacon

THIS PAGE INTENTIONALLY BLANK

EXECUTIVE SUMMARY

The International Council on Systems Engineering (INCOSE) defines Systems Engineering (SE) as an “interdisciplinary approach and means to enable the realization of successful systems. It focuses on defining customer needs and required functionality early in the development cycle, documenting requirements, and then proceeding with design synthesis and system validation while considering the complete problem: operations, performance, test, manufacturing, cost and schedule, training and support, and disposal.”¹ This case study on the International Space Station considers what many believe to have been the ultimate international engineering project in history.² The initial plans involved the direct participation of 16 nations, 88 launches and over 160 spacewalks—more space activities than NASA had accomplished prior to the 1993 International Space Station decision.



Probably more important was the significant leap in System Engineering (SE) execution that would be required to build and operate a multi-national space station. In a short period of time, NASA and its partners had to work out how to integrate culturally different SE approaches, designs, languages and operational perspectives on risk and safety.

The International Space Station (ISS) traces its heritage back to early plans for the United States Manned Orbiting Laboratory (MOL) program to the US Skylab, the Shuttle’s Space Lab and then through the multiple Soviet space stations culminating in the Mir. With the successful development and launch of the Space Shuttle, the United States was ready to take on a much larger space station concept. In the fall of 1985, NASA put together a plan for a dual-keel design with multiple US, European and Japanese research modules along with Canada’s planned Mobile Servicing System. By 1986, this had changed due to the Challenger accident and other safety considerations. A major new addition was a new “lifeboat” vehicle that would accommodate emergency returns to Earth. All of these changes caused the estimated price to double. By the end of the 1980s, the station design (now called Space Station Freedom) had shrunk along with total crew (down to four), electrical power generation (from 75 to 56 kw) and for budgetary reasons, there was no defined end-state for the station. By 1990, the modified station cost was several times higher than the original plan.³

By 1993, the station design had continued to evolve and cost estimates continued to grow. The new Clinton administration set up a blue ribbon panel to look at the space station and

¹ INCOSE website: <http://www.incose.org/practice/whatisystemseng.aspx>

² “Systems Engineering Challenges of the International Space Station,” Mark. D. Jenks, 2000 NAE Symposium on Frontiers in Engineering.

³ “Nasa’s Space Station Program: Evolution of its Rationale and Expected Uses,” Marcia S. Smith, Congressional Research Service, Testimony before the Subcommittee on Science and Space, United States Senate, April 20, 2005.

determine a new design that would fit within available budget. The new design, eventually called the International Space Station (ISS), would still be an international effort but would now include the addition of Russia as a major contributor of ISS modules and support. As the program progressed and assembly began, costs grew along with schedule delays. By 2002, NASA was looking for a way to significantly reduce costs and to complete the station. This involved the cancellation of a few modules along with the emergency crew return vehicle. The original plan called for 6-7 astronauts full time doing research and this was considered for a reduction to 3.⁴ Estimated cost for completion increased and the schedule slipped with a new completion date of 2004.

By 2004, in the aftermath of the Columbia accident, the schedule and budget had grown and ISS completion was now scheduled for 2010. President Bush announced a new NASA Vision for Space Exploration which placed less emphasis on the ISS and started development of a new fleet of vehicles that someday would go to the Moon, Mars and beyond. To make the budget available for this new effort, the Shuttle would be retired in 2010 with the completion of the ISS assembly. The ISS retirement date was unclear, possibly as early as 2016. These decisions do provide an end state for ISS construction, but raise risk issues about US access to the station after Shuttle retirement and before the next generation of US manned orbital vehicles will be ready.

Not to downplay the major cost and schedule issues, the systems engineering challenge on the ISS was equally monumental. NASA had to quickly learn how to adapt its SE approaches to include an awareness of those of the international partnership. NASA has its own challenges of multiple centers with their own SE differences and approaches. NASA had to learn how to operate as a “managing partner” to accommodate its International Partners (IPs). A major effort was involved in developing the partnership agreements, allocating costs and usage rights, and determining operational control. Under the new ISS partnership,⁵ NASA was the first IP among equals, with each board chaired by the NASA representative. In cases where consensus could not be reached, the NASA representative technically had the right to make a decision for the board; however, this right was rarely used in practice.

NASA was concerned about maintaining schedule and cost on the ISS program, because failures would not be tolerated by Congress. Initial program strategy was for no IP to be on the critical path, which would allow NASA more control to reduce risk. As it turned out, however, the Russians ended up providing the first two major modules that were at the front of the critical path.

NASA had to solve many major SE challenges. It had to figure out how to coordinate and integrate all of the IPs and their highly integrated modules:

⁴ “Nasa’s Space Station Program: Evolution of its Rationale and Expected Uses,” Marcia S. Smith, Congressional Research Service, Testimony before the Subcommittee on Science and Space, United States Senate, April 20, 2005.

⁵ “Lessons Learned and Recommendations on International Participation from the International Space Station Program,” Daniel V. Jacobs and Michael J. See, Lyndon B. Johnson Space Center, Sept. 2004.

- The integration challenge was further hindered by a lack of computer and information technology capability both at NASA and its partners (especially the Russians). The ISS helped accelerate NASA's upgrade of its information technology systems and adoption of a full email and web focused data exchange system. Within the constraints of federal law, NASA had to supply computers and software to the Russians.
- The Russians had a very different approach to SE, risk, and safety. The Russians had significant on-orbit experience with the MIR and its predecessors, which drove their SE approaches. For instance, they tended to be more conservative and evolutionary in design. A prime example is their Soyuz/Progress vehicle designs, which are directly traceable to their 1960s designs. They also utilized an approach that could best be described as "dissimilar redundancy". In this mode different systems can be utilized to provide a basic capability.
- The ISS design, development and construction began with Space Station Freedom design work in the 1980s and are not scheduled to conclude until 2010, with operations continuing until 2016 and possibly beyond, requiring NASA to solve major obsolescence, logistics, and technology issues. The length of the program has created major personnel challenges as NASA attempts to capture, manage, and create program knowledge while dealing with significant career progression issues of its personnel.
- The on-orbit assembly of the ISS created a major operational configuration challenge. Each on-orbit configuration had to operate as a stand-alone space station, requiring multiple design baselines for the structure, hardware, and operational systems. NASA basically developed a new version of spiral construction theory.
- NASA and its IPs had to develop innovative methods to test and verify interfaces. One of the most significant of these involved Multi-Element Integrated Testing solutions for the station components and then creating a complex test plan and hardware/software solution for each configuration.
- NASA had to develop expertise in supporting its systems engineering approach while adjusting to the realities of a complex external environment including international politics across many partner nations. At times, optimal technical solutions conflicted with political constraints, and prohibitions created by the Iran, North Korea and Syria Non-Proliferation Act, and International Traffic in Arms Regulations (ITAR).

Part of this problem was solved by adopting an integrated product team (IPT) approach. This approach was utilized in a broad manner after the 1993 redesign activity. Its use diminished as the design and development phase came to completion.

THIS PAGE INTENTIONALLY BLANK

TABLE OF CONTENTS

Foreword *i*

Acknowledgments..... *ii*

Executive Summary*iv*

Table of Contents *viii*

List of Figures *xi*

List of Tables *xiii*

1.0 SYSTEMS ENGINEERING PRINCIPLES**1**

1.1 General Systems Engineering Process**1**

 1.1.1 Introduction..... 1

 1.1.2 Case Studies 3

 1.1.3 Framework for Analysis 4

1.2 ISS Major Learning Principles and Friedman-Sage Matrix**6**

2.0 INTERNATIONAL SPACE STATION PROGRAM JOURNEY**7**

2.1 Historical Background.....**7**

 2.1.1 Soviet Space Stations 8

 2.1.2 Skylab 9

 2.1.3 Space Station Freedom 9

 2.1.4 Shuttle-Mir Program 9

2.2 Space Station Freedom Redesign**12**

 2.2.1 Budget 12

 2.2.2 Studies/Review Panels 13

 2.2.3 Changes from SSF to ISS 14

2.3 NASA Systems Engineering Environment**16**

 2.3.1 NASA Management Approach 16

 2.3.2 NASA Center Approaches 20

 2.3.3 System Engineers and the Experience Chain..... 20

 2.3.4 Systems Engineering Challenges of the ISS 22

 2.3.5 Systems Engineering Process 23

 2.3.6 International Partners 24

 2.3.7 Safety/Risk approaches 27

3.0 FULL SCALE DEVELOPMENT.....**32**

3.1 Major ISS Modules**32**

3.1.1	Zarya Control Module.....	32
3.1.2	Unity Node.....	33
3.1.3	Zvezda Service Module	33
3.1.4	Destiny Laboratory Module.....	34
3.1.5	Canadian Space Robotics System.....	36
3.1.6	Quest Joint Airlock	36
3.1.7	Russian Pirs Docking Compartment.....	38
3.1.8	Columbus Laboratory	39
3.1.9	Kibo Japanese Experimental Laboratory	40
3.1.10	Cupola.....	43
3.1.11	Russian Multi-Purpose Laboratory Module.....	43
3.1.12	Multi-Purpose Logistics Module	45
3.2	Launch Services	46
3.2.1	Shuttle	46
3.2.2	New NASA capability	47
3.2.3	Russian Vehicles	47
3.2.4	Japanese Projects	49
3.2.5	European Projects	49
3.2.6	Commercial Capabilities.....	49
3.3	Development Challenges	50
3.3.1	Technology Readiness and Obsolescence	51
3.3.2	Use of Probabilistic Risk Assessment.....	52
3.3.3	Russian Contribution and Risk	53
3.3.4	Spiral Construction Approach and Multi-configuration issues	54
3.3.5	Computer Hardware and Software.....	54
3.3.6	Power Systems	58
3.3.7	Micrometeoroid and Orbital Debris (MMOD) Protection.....	60
3.3.8	Test and Integration	61
3.4	Execution Issues	66
3.4.1	Unrealistic Estimates for Cost and Schedule	66
3.4.2	Iran, North Korea, and Syria Nonproliferation Act	68
3.4.3	ISS Logistical Support	69
3.4.4	Handling a Major Computer Failure.....	70
3.4.5	Transportation	73
3.4.6	Anomaly Resolution and the Columbia Accident	80
3.4.7	Major Risks to the ISS	81
3.5	Long Term Outlook	84
4.0	SUMMARY.....	86
4.1	Summary.....	86

4.2	Lessons Learned.....	87
<i>APPENDICES</i>		89
APPENDIX 1.	AUTHOR BIOGRAPHIES.....	90
	Among his numerous awards, he is a recipient of NASA’s Exceptional Achievement Medal, the Director’s Special Commendation, and the coveted Silver Snoopy award—the only award to fly in space. He routinely advises numerous academic programs and institutions, and he is a champion of education throughout the world.	91
APPENDIX 2.	ACRONYMS	92
APPENDIX 3.	SPACELAB MISSIONS	96
APPENDIX 4.	PHASE ONE—SHUTTLE-MIR MISSIONS	97
APPENDIX 5.	INTERNATIONAL SPACE STATION MISSION SUMMARIES	99

LIST OF FIGURES

Figure 1. The Systems Engineering Process as presented by the Defense Acquisition University	2
Figure 2. US Manned Orbiting Laboratory (USAF Image).....	7
Figure 3. Soviet ALMAZ Space Station.....	8
Figure 4. Soviet Salyut 6 Space Station.....	8
Figure 5. US Skylab Space Station.....	9
Figure 6. US Shuttle Docked with the Russian MIR Space Station	10
Figure 7. Damage to the Soviet MIR from Docking Accident	12
Figure 8. NASA and International Partner Operations Scope	16
Figure 9. Systems Engineering Integration Boards.....	19
Figure 10. Russian Zarya Module.....	32
Figure 11. US Unity Module	33
Figure 12. Zvezda Module with.....	34
Figure 13. US Destiny Laboratory Module	35
Figure 14. US Destiny Module High Grade Optical Window	35
Figure 15. Canadian Space Robotics System.....	36
Figure 16. US Quest Airlock	38
Figure 17. Russian Pirs Docking Compartment.....	38
Figure 18. ESA Columbus Research Module	40
Figure 19. Japanese Kibo Experimental Module and Facilities.....	42
Figure 20. Cupola Observation Modules	43
Figure 21. Russian Multi-Purpose Laboratory Module	44
Figure 22. Interior of Italian Multi-Purpose Logistics Modules	45
Figure 23. US Shuttle Docked with the ISS.....	46
Figure 24. Russian Soyuz Manned Vehicle	48
Figure 25. Russian Progress Unmanned Cargo Vehicle	48
Figure 26. Japanese Unmanned H-II Transfer Vehicle.....	49
Figure 27. European Unmanned Automated Transfer Vehicle.....	49
Figure 28. US SpaceX Unmanned Cargo Vehicle	50
Figure 29. Orbital Sciences Cygnus Unmanned Cargo Vehicle	50
Figure 30. Single Channel Power Flow Diagram	59

Figure 31. Average Micrometeoroid Environment for ISS	60
Figure 32. Multi Element Integrated Test Configurations for the ISS.....	64
Figure 33. Multi Element Integrated Test 2 Set Up for the ISS.....	65
Figure 34. NASA Cost and Schedule Overruns.....	66
Figure 35. NASA Schedule Outcomes	67
Figure 36. STS-117 Extra-Vehicular Activity at ISS.....	71
Figure 37. Stowed Solar Panel Being Unfolded for Deployment.....	71
Figure 38. Space Shuttle	74
Figure 39. Soyuz Manned Vehicle.....	76
Figure 40. Fire at Scene of Soyuz Capsule Landing.....	77
Figure 41. Space Exploration Falcon 1 Rocket.....	78
Figure 42. Orion Visiting the ISS	86

LIST OF TABLES

Table 1. Framework of Key Systems Engineering Concepts and Responsibilities	5
Table 2. Technology Readiness Levels.....	51
Table 3. Probability of Penetration Damage to the ISS	81

THIS PAGE INTENTIONALLY BLANK

1.0 SYSTEMS ENGINEERING PRINCIPLES

1.1 General Systems Engineering Process

1.1.1 Introduction

The United States government continues to develop and acquire new systems and to meet the scientific needs of our growing nation. With a constant objective to improve and mature the acquisition process, the United States continues to pursue new and creative methodologies to purchase these technically complex systems. A sound systems engineering process (hereafter referred to as the SE process), focused explicitly on delivering and sustaining robust, high-quality, affordable products that meet the needs of customers and stake holders, must continue to evolve and mature. Systems engineering encompasses the technical management process that results in delivered products and systems that exhibit the best balance of cost and performance with the highest resultant technical integrity. The SE process must operate effectively with desired mission-level capabilities, establish system-level requirements, allocate these down to the lowest level of the design, and ensure validation and verification of performance, meeting cost and schedule constraints. The systems engineering process evolves as the program progresses from one phase to the next, as do the tools and procedures. The process also changes over the decades, maturing, expanding, growing, and evolving from the base established during the conduct of past programs. Examples can be found demonstrating a systemic application of effective engineering and engineering management, as well as poorly applied, but well-defined processes. Throughout the many decades during which systems engineering has emerged as a discipline, many practices, processes, heuristics, and tools have been developed, documented, and applied.

Several core lifecycle stages have surfaced as consistently and continually challenging during any system program development. First, system development must proceed from a well-developed set of requirements. Secondly, regardless of the evolutionary acquisition approach, the system requirements must flow down to all subsystems and lower level components. And third, the system requirements need to be stable, balanced and must properly reflect all activities in all intended environments. However, system requirements are not unchangeable. As the system design proceeds, if a requirement or set of requirements is proving excessively expensive to satisfy or becomes otherwise unsupportable, the process must rebalance schedule, cost, and performance by changing or modifying the requirements or set of requirements with customer concurrence.

Systems engineering includes making key system and design trades early in the process to establish the system architecture. These architectural artifacts can depict any new system, legacy system, modifications thereto, introduction of new technologies, and overall system-level behavior and performance. Modeling and simulation are generally employed to organize and assess architectural alternatives at this introductory stage. System and subsystem design follows the functional architecture. System architectures are modified if the elements are too risky, expensive, or time-consuming. Both newer object-oriented analysis and design and classic structured analysis using functional decomposition and information flows/data modeling occur. Design proceeds logically using key design reviews, tradeoff analysis, and prototyping to reduce any high-risk technology areas.

Important to the efficient decomposition and creation of the functional and physical architectural designs are the management of interfaces and integration of subsystems. This is applied to subsystems within a system, or across large, complex systems of systems, and requires acknowledgement of the human as an integral element of the system. Once a solution is planned, analyzed, designed, and constructed, validation and verification take place to ensure satisfaction of requirements. Definitions of test criteria, measures of effectiveness (MOEs), and measures of performance (MOPs), established as part of the requirements process, take place well before any component/subsystem assembly design and construction occurs.

Several excellent representations of the systems engineering process are presented in the literature. These depictions present the current state of the art in the maturity and evolution of the systems engineering process. One can find systems engineering process definitions, guides, and handbooks from the National Aeronautics and Space Administration, International Council on Systems Engineering (INCOSE), Electronics Industrial Association (EIA), Institute of Electrical and Electronics Engineers (IEEE), International Standards Organization (ISO), and various Department of Defense (DoD) agencies and organizations. They show the process as it should be applied by today's experienced practitioner. One of these processes, long used by the Defense Acquisition University (DAU), is depicted in Figure 1. It should be noted that this model is not accomplished in a single pass. This iterative and nested process gets repeated to the lowest level of definition of the design and its interfaces.

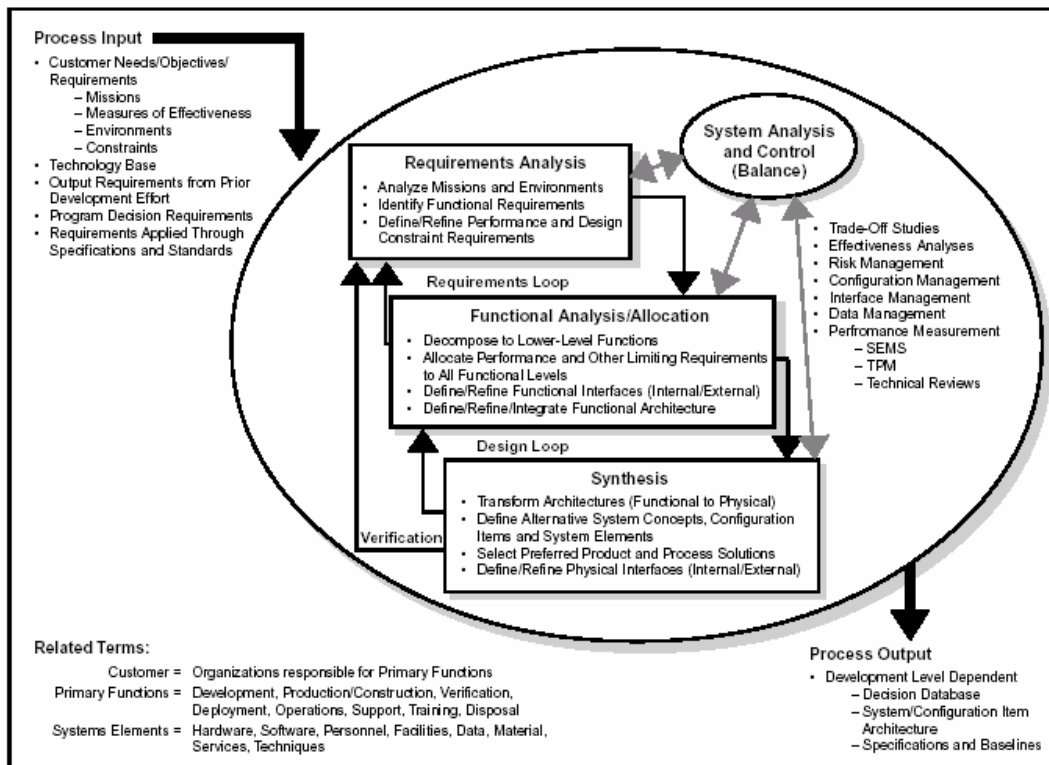

Figure 1. The Systems Engineering Process as presented by the Defense Acquisition University

The DAU model, like all others, has been documented in the last two decades and has expanded and developed to reflect a changing environment. Systems are becoming increasingly complex internally and more interconnected externally. The process used to develop aircraft and other weapons of the past was a process effective at that time. It served the needs of the practitioners and resulted in many successful systems in our inventory. However, the cost and schedule performance records of the past programs are fraught with examples of some well-managed programs and programs with less than perfect execution. As the nation entered the 1980s and 1990s, large DoD and commercial acquisitions were overrunning costs and running behind schedule. The aerospace industry and its organizations were becoming larger and more geographically and culturally distributed. As applied within the confines of a single system or a single company the early systems engineering process, was no longer the norm.

Today, many factors overshadow new acquisitions, including System-of-Systems (SoS) context, network centric warfare and operations, and the rapid growth in information technology. These factors have driven a new form of emergent systems engineering, which focuses on certain aspects of the traditional process. One of these increased areas of focus resides in the architectural definitions used during system analysis. This process is differentiated by greater reliance on reusable architectural views describing the system context and concept of operations, interoperability, information and data flows and network service-oriented characteristics.

1.1.2 Case Studies

The systems engineering process to be used in today's complex SoS projects is a process matured and founded on the principles of systems developed in the past. The examples of systems engineering used in other programs, both past and present, provide many lessons to be used in applying and understanding today's process.

The purpose of developing detailed case studies is to support the teaching of systems engineering principles. The systems engineering case studies assist in discussion of both successful and unsuccessful methodologies, processes, principles, tools, and decision material to assess the outcome of alternatives at the program/system level. In addition, the importance of using skills from multiple professions and engineering disciplines and collecting, assessing, and integrating varied functional data is emphasized. Analysis of these aspects will provide the student with real-world, detailed examples of how the process plays a significant role in balancing cost, schedule, and performance.

The utilization and mis-utilization of systems engineering principles are highlighted, with special emphasis on the conditions that foster or impede good systems engineering practices. Case studies should be used to illustrate both good and bad examples of acquisition management and learning principles, to include determining whether:

- Every system provides a balanced and optimized product to a customer.
- Effective requirements analysis was applied.
- Consistent and rigorous application of systems engineering management standards was applied.
- Effective test planning was accomplished.
- Effective major technical program reviews were conducted.

- Continuous risk assessments and management adjustments were implemented.
- Reliable cost estimates and policies were developed.
- Disciplined application of configuration management was demonstrated.
- A well-defined system boundary was defined.
- Disciplined methodologies were developed for complex systems.
- Problem solving methods incorporated understanding of the system within the larger environment (customer's customer).

The systems engineering process transforms an operational need into a set of system elements. These system elements are allocated and translated by the systems engineering process into detailed requirements. The systems engineering process, from the identification of the need to the development and utilization of the product, must continuously integrate and optimize system and subsystem performance within cost and schedule to provide an operationally effective system throughout its life cycle. Case studies highlight the various interfaces and communications to achieve this optimization, which include:

- The program manager/systems engineering interface, which is essential between the operational user and developer (acquirer) to translate the needs into the performance requirements for the system and subsystems.
- The government/contractor interface, essential for the practice of systems engineering to translate and allocate the performance requirements into detailed requirements.
- The developer (acquirer)/user interface within the project, essential for the systems engineering practice of integration and balance.

The systems engineering process must manage risk, known and unknown, as well as internal and external. This objective specifically focuses on external factors and the impact of uncontrollable influences, such as actions of Congress, changes in funding, new instructions/policies, changing stakeholders or user requirements or contractor and government staffing levels.

Lastly, the systems engineering process must respond to "Mega-Trends" in the systems engineering discipline itself, as the nature of systems engineering and related practices vary with time.

1.1.3 Framework for Analysis

This case study is presented in a format that follows the learning principles specifically derived for the International Space Station, utilizing the Friedman-Sage⁶ framework to organize the assessment of the application of the systems engineering process. The framework and the derived matrix can play an important role in developing case studies in systems engineering and systems management, especially case studies that involve systems acquisition. The framework presents a nine row by three column matrix shown in Table 1.

⁶ *Case Studies of Systems Engineering and Management in Systems Acquisition*, George Friedman and Andrew Sage, Systems Engineering, Vol. 7, No. 1, 2004, © 2003 Wiley Periodicals, Inc.

Table 1. Framework of Key Systems Engineering Concepts and Responsibilities

Concept Domain	Responsibility Domain		
	1. Contractor Responsibility	2. Shared Responsibility	3. Government Responsibility
A. Requirements Definition and Management			
B. Systems Architecting and Conceptual Design			
C. System and Subsystem Detailed Design and Implementation			
D. Systems and Interface Integration			
E. Validation and Verification			
F. Deployment and Post Deployment			
G. Life Cycle Support			
H. Risk Assessment and Management			
I. System and Program Management			

Six of the nine concept domain areas in Table 1 represent phases in the systems engineering life cycle:

- A. Requirements Definition and Management
- B. Systems Architecting and Conceptual Design
- C. System and Subsystem Design and Implementation
- D. Systems and Interface Integration
- E. Validation and Verification
- F. Deployment and Post Deployment

Three of the concept areas represent necessary process and systems management support:

- G. Life Cycle Support
- H. Risk Assessment and Management
- I. System and Program Management

While other concepts could have been identified, the Friedman-Sage framework suggests these nine are the most relevant to systems engineering in that they cover the essential life cycle processes in systems acquisition and the systems management support in the conduct of the process. Most other concept areas identified during the development of the matrix appear to be subsets of one of these areas. The three columns of this two-dimensional framework represent the responsibilities and perspectives of government, the contractor, and the shared responsibilities between the government and the contractor.

The Friedman-Sage matrix is not a unique systems engineering applications tool, but rather a disciplined approach to evaluate the systems engineering process, tools, and procedures as applied to a program. The Friedman-Sage matrix is based on two major premises as the founding objectives:

1. In teaching systems engineering, case studies can be instructive in that they relate aspects of the real world to the student to provide valuable program experience and professional practice to academic theory.
2. In teaching systems engineering, there has previously been little distinction between duties and responsibilities of the government and industry activities. More often than not, the government role in systems engineering is the role of the requirements developer.

1.2 ISS Major Learning Principles and Friedman-Sage Matrix

The authors' selection of learning principles from the Friedman-Sage matrix is reflected in the Executive Summary of this case study (separate attachment).

The systems engineering of the ISS was necessarily biased towards government-led integration, owing to the numerous intergovernmental agreements executed between the US and its International Space Station partners.

2.0 INTERNATIONAL SPACE STATION PROGRAM JOURNEY

2.1 Historical Background

Humans have always looked up at the sky and imagined what it might be like to view the earth from outer space or the heavens. The first recorded reference to a space station as we know it today was in a short story⁷ by Edward Everett Hale entitled “The Brick Moon” in 1869. The space station or brick moon was to serve as a navigation aid to sailors much as the stars or moon did for centuries. Hale’s space station was not practical, because it was constructed of bricks, had no propulsion and its inhabitants could actually wave at the ships and jump up and down to make the station vibrate as a warning signal. While not a physicist, he identified an early concept to use orbiting satellites to aid in navigation—a very crude Global Positioning Satellite (GPS). Later, in 1923⁸, Hermann Oberth wrote of space travel to the moon and beyond starting from an orbiting “space station”—which was the first coining of the term. He even published the first concept of a wheel-like space station.⁹ In 1952, Dr. Werner von Braun (a

former student of Oberth) published an important article in *Colliers* magazine about his idea for a rotating space station in a 1000-mile high orbit. In 1959, the U.S. Army began a study called Project Horizon¹⁰ to consider building a permanent outpost on the Moon along with a possible space station. The Department of Defense (DoD) began a program called Manned Orbiting Laboratory¹¹ (MOL) in December 1963 (Figure 2). Its purpose was to provide a reconnaissance capability to the Air Force and establish the first manned military space program. The program was eventually cancelled in June 1969.

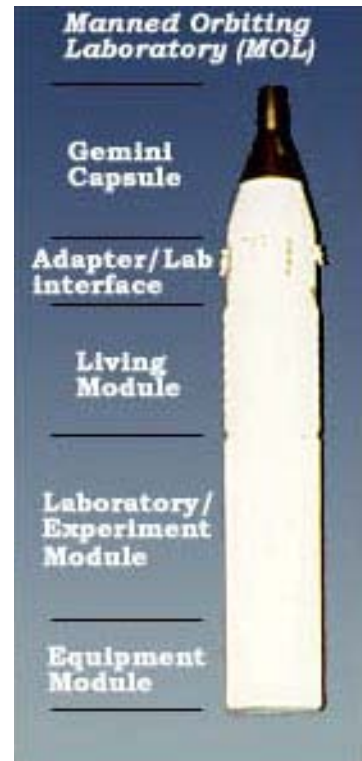

Figure 2. US Manned Orbiting Laboratory (USAF Image)

⁷ “The Brick Moon,” Edward Everett Hale, *The Atlantic Monthly*, 1869

⁸ *By Rocket to Space*, Hermann Oberth, 1923

⁹ *Frontiers of Space Exploration*, Roger D. Lanius, Greenwood Press, 1998

¹⁰ “Project Horizon Report: A US Army Study for the Establishment of a Permanent Lunar Outpost,” 9 June 1959.

¹¹ “Best Laid Plans: A History of the Manned Orbiting Laboratory,” Steven Strom, Aerospace Corporation.

2.1.1 Soviet Space Stations

The Soviet Union launched the first space station in its early Almaz and Soyuz programs. An early Almaz design is shown in Figure 3. These early space stations were developed and built in the 1964-1977 timeframe. They were relatively small and could not be refueled or resupplied (other than what the arriving crews brought in their small Soyuz capsules). These stations were placed in orbit by Proton rockets with the crew to follow in Soyuz capsules. They were marginally successful with at least five built; one failed to achieve orbit, but at least four were occupied by one or more crews. The first successful mission occurred in 1971. However, the successful docking was overshadowed by the deaths of the Soyuz-11 crew due to a failed pressure equalization system that asphyxiated Georgi Dobrovolski, Vladislav Volkov, and Viktor Patsayev

The second generation of Soviet space stations flew from 1977-1985. These were slightly larger but had the capability to be refueled and resupplied by automated Progress capsules—a major technological achievement. As shown in Figure 4, the Salyut 6 space station was considerably larger than previous stations and allowed for multiple crews and longer missions. These provided the Soviets with valuable experience in extended stays in space providing logistics support and crew transportation to the space stations. The third generation Soviet space station was the Mir which was first occupied in 1986 and remained in orbit 15 years. It was 107 feet long by 90 feet wide and weighed an estimated 135 tons when completed. The Mir provided valuable research and information on long-term habitation in space. It also became the stepping stone for the ISS and its future crews at the end of its operational life.



Figure 3. Soviet ALMAZ Space Station



Figure 4. Soviet Salyut 6 Space Station

2.1.2 Skylab

The United States launched its first space station, Skylab, in 1973 with plans to keep it in operation well into the 1980s with support flights from the new space shuttle (Figure 5). It was launched on 14 May 1973 and was occupied by three separate crews that year. The original plan was to park it in a higher orbit, shut it down and then wait for the new Shuttle to resume support flights to the station. Due to unexpected dynamics during the first reboost a second planned firing was not completed. Due to delays in the Shuttle development, the **lower orbit and a degrading altitude resulting from higher than anticipated solar activity; it reentered the atmosphere** on 11 July 1979.



Figure 5. US Skylab Space Station

As the Shuttle program began launch operations in 1981,¹² it began to take experimental laboratories in its cargo bay into orbit for research and experiments—as part of what was called Spacelab. While not a true space station, it allowed the US to conduct research in orbit and develop test equipment for the future space stations.

2.1.3 Space Station Freedom

In 1984, with the Shuttle on track, NASA announced plans for the next stage of space exploration to be a space station that would support up to eight full time astronaut scientists. The design and funding changed multiple times during the 1980s and eventually ended up as the Space Station Freedom in 1988 with Canada, Europe and Japan onboard as partners.

2.1.4 Shuttle-Mir Program

At the end of the first Bush Administration in 1992, the United States and Russia agreed to jointly engage in space exploration.¹³ At this time the Space Station Freedom was transitioning into the International Space Station (ISS), and United States and Russia were looking for ways to renew cooperation and benefit from existing space programs. Often referred to as Phase One of the eventual ISS program, the Shuttle-MIR program provided the United States access to the MIR and opportunities to engage in long duration space missions and experimentation (Figure 6). Of equal importance to the Russians, it provided an influx of badly needed revenue (in excess of \$400M) to continue and expand the MIR program.

¹² “NASA’s Space Station Program: Evolution of Its Rational and Expected Uses,” Marcia Smith, Congressional Research Services, 20 April 2005.

¹³ Russian Federation Agreement Between The United States Of America And The Russian Federation Concerning Cooperation In The Exploration And Use Of Outer Space For Peaceful Purposes (Signed at Washington D.C. on June 17, 1992, Proclaimed on June 17, 1992)

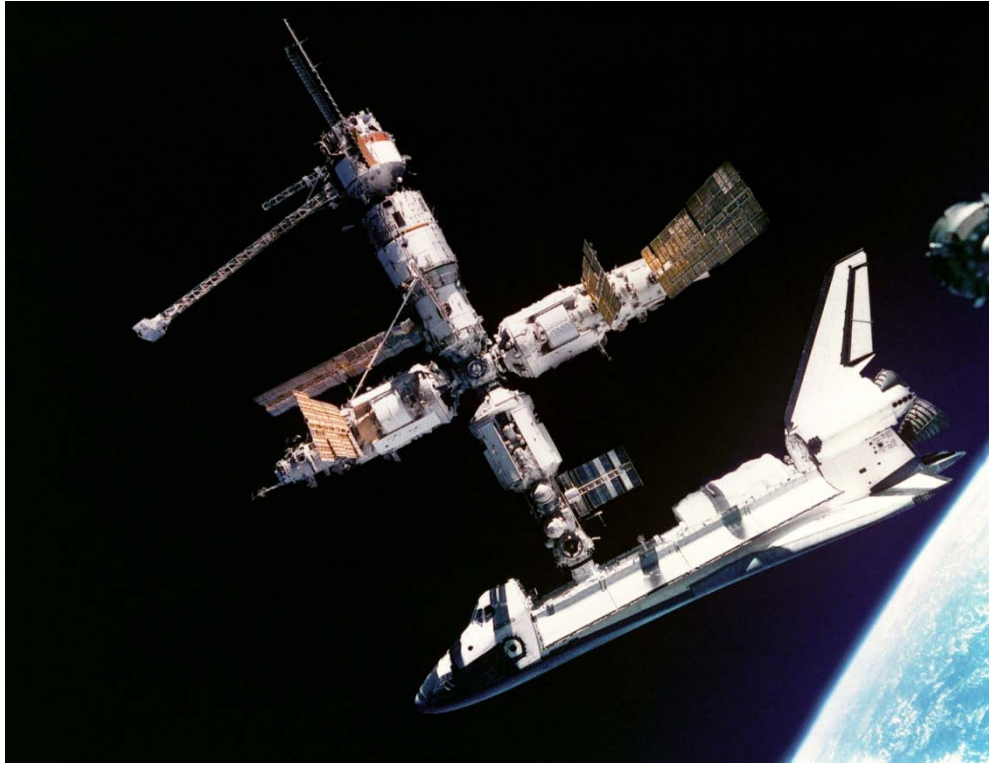

Figure 6. US Shuttle Docked with the Russian MIR Space Station

The initial cooperative program negotiated in 1992 had a single American astronaut visiting the MIR and two cosmonauts joining a Shuttle mission. By 1993, the United States had announced revised plans for ISS, and the program was expanded. The new program allowed the United States to invest in the MIR construction which allowed for the launch and integration of new modules, the Spektr and the Priroda.¹⁴ Both were modules previously begun prior to the collapse of the Soviet Union and both had initially been designed to accommodate some military missions (surveillance). While NASA had little to do with the design of the MIR, it did allow NASA to research the long term effects of micro-gravity on astronauts, gain experience on spacewalks, allow testing and research of new equipment, gain valuable experience in docking (Shuttle and Soyuz capsules with MIR) and learn critical lessons about day to day operation of long term space assets in orbit.

The program began in February 1994 with the inclusion of Cosmonaut Sergei Krikalev on board STS-60 for a nine-day Shuttle mission. The first Shuttle mission to MIR came in 1995, and Shuttle support ended in 1998. During this time, seven astronauts performed long duration flights on the MIR (up to six months) which provided valuable information for systems engineering (SE) requirements generation of the ISS. They also spent significant time in Russia training and working with the Russian system engineering staff.

While the program is hailed as a major success and valuable source of data for the ISS, much of the valuable information was learned the hard way. Although it would be incorrect to

¹⁴ In the mid-1990s with the return of US-Russian cooperation in space, NASA agreed to provide funds to complete the Spektr and Priroda modules in exchange for having 600 to 700 kg of US experiments installed.

say that the missions were totally successful and the US experience was flawless, it painted a clear picture of the risks involved in international space stations and their development.¹⁵

- The marriage of NASA with the Russian space program felt to many to be a forced marriage at best in the beginning. It was a major cultural shock for the NASA astronauts, engineers and managers to integrate with the former Soviet bureaucracy and its systems engineering establishment. Information was power in the Russian system, so documentation and sharing of information was constrained. The Russians had similar difficulties learning and understanding the engineering techniques and emphasis of their American counterparts.
- Although NASA had significant experience in multi-national projects the level of support and integration required to form the partnership with Russia was overwhelming. This was exacerbated by the condition of emergence from the Soviet era and the mammoth political and economic change occurring in Russia.
- In most NASA international projects English was the primary language of the project. With the initiation of the Russian partnership that was the accepted principle however it was not practical to have English as the primary language. Most of the NASA professionals couldn't speak Russian and few Russians spoke English, which caused communication problems across the board—even with interpreters. In addition to basic language, the teams needed to agree on a fundamental engineering and project management lexicon.
- In the difficult economic environment of the mid-1990's in Russia, the Russian space industry was encouraged to seek “off-budget” resources. This also evolved into unique payment scenarios where cosmonauts were compensated for specific mission tasks. This raised significant differences in approach to crew operations and at times caused confusion in plans and motivations for activities.
- In 1997, an oxygen-producing canister (the same as being proposed for the ISS) caught fire aboard the Mir Space Station due to a quality problem during production (apparently a piece of latex glove was accidentally left in the canister¹⁶). The resulting fire and smoke seriously compromised the station's environment and scalded one of the cosmonauts, who attempted to put it out with a water-based fire extinguisher.

¹⁵ DragonFly: NASA and the Crisis Aboard MIR, Bryan Burrough, Harper Collins Publishers.

¹⁶ “Latex Glove Sparked Fire Aboard MIR Space Station”, Michael Brooks, The Guardian, 1997.

- Also in 1997, the Russians experimented with a manual docking system for the Progress in hopes that it would allow them to avoid using an expensive automated system that had proven successful on past missions. On one attempt, they lost control of the Progress and it barely missed the station. A few months later, they attempted a similar experiment and this time the Progress hit the station and punctured the Spektr module. This caused significant damage, a total loss of power and control and initial decompression (Figure 7). Note that partial power, control, and cabin pressure were later recovered and did not affect crew survivability.



Figure 7. Damage to the Soviet MIR from Docking Accident

2.2 Space Station Freedom Redesign

On June 17, 1993, President Clinton announced¹⁷ that he was accepting the advice of a special blue ribbon panel and directing NASA to downsize the planned Space Station Freedom (SSF) to save budget. He directed NASA to work with the US's International Partners (IP) to develop this reduced cost, scaled down version of the original Space Station Freedom. By the end of 1993, the space station had a new preliminary design and the partners had invited Russia as a major contributor and partner. The name Space Station Freedom had been dropped and it became the International Space Station.

2.2.1 Budget

The primary reason driving the redesign of the Space Station Freedom was escalating cost and a desire by the Administration and Congress to reduce NASA's budget. At the time in 1993, the cost to design build and launch SSF was \$31B with estimated operational costs of \$100B over its 30-year lifespan.¹⁸ The new station, chosen by President Clinton, had an

¹⁷ "Space Station Redesign Decision Reduces Costs, Preserves Research, Ensures International Cooperation," Executive Office of the President news release, 17 June 1993

¹⁸ "NASA Unsure If Redesigned Space Station Is Viable," by Warren E. Leary, *The New York Times*, April 23, 1993.

estimated cost of \$12.8B over the first five years (develop/launch) and \$16.5B for operational costs during deployment and a reduced lifespan of just ten years after its assembly in space.¹⁹ At this point in time, SSF had already cost \$9B and it was hoped much of its technology and systems could be reused on the new design. An additional but enormously significant constraint was the direction from the Administration that the ISS program spending profile would be essentially flat, capped at \$2.1 B per year, during its development.²⁰ [Note that for large government funded efforts, not only are technical issues the causal factor of cost growth, but when the funding profile or “phasing” does not meet the planned profile, the cost tends to grow and the schedule likely slips. Thus it is not just the amount of funding, but when the project receives it.] As a program management challenge, incorporating a traditional development funding curve in a flat profile would drive the ISS program in many ways.

Despite the redesign and its presidential support, the station’s future was still in jeopardy. Just weeks after the report of the redesign team the ISS barely survived a cancellation vote in the Congress by a single vote. Over the next several years, the program would continually face cancellation votes. Although the margin of victory continued to climb, the level of Congressional interaction was a large drain on program resources.

2.2.2 Studies/Review Panels

Underestimates by NASA of the station program's cost and unwillingness by Congress to appropriate funding for the space station resulted in delays of Space Station Freedom’s design and construction; it was repeatedly redesigned and rescoped. Between 1984 and 1993 it went through seven major re-designs, losing capacity and capabilities each time. In January 1993, Vice President Dan Quayle provided the outgoing President Bush with the annual report on the US Space Program.²¹ It generally supported the Space Station Freedom and gave it the go-ahead to continue development. However, with a new administration a few weeks later, things changed dramatically. Space exploration had been a major emphasis area of President Bush and his predecessor, President Reagan. The new democratic administration had a different set of priorities and saw a need to reallocate the federal budget.

On March 9, 1993, President Clinton directed the formation of the Advisory Committee on the Redesign of the Space Station. Their task was to spend 90 days to redesign the space station with the goal of reducing costs while still retaining research capability. At the same time, NASA formed a team of 45 top NASA engineers and administrators along with 10 representatives from the International Partners to do the actual designs. The NASA team was directed to develop three options that met budget goals, provided technical and scientific capability, and reduced NASA management and operation costs. The three options, A, B, and C were targeted to different development budget targets. Option A kept much of the Freedom design but added an existing large spacecraft bus as an initial building block. Option B was an optimized version of the Space Station Freedom design, Option C was a major deviation that

¹⁹ “Space Station Will Not Be Cancelled,” Audrey Leath, American Institute of Physics, June 18, 1993.

²⁰ A flat funding profile while simple from a budget viewpoint, has little correlation with the actual development and production requirements. It causes the program managers to make sub-optimal decisions which normally result in schedule delays and cost increases.

²¹ “Final Report to the President on the US Space Program,” The National Space Council, January 1993.

utilized a very large core module similar to the Skylab. This option would require a new Shuttle-C launch vehicle to lift the Station core. The team recommended Option A as the best solution and that became the basis of negotiations with Russia. Over time and with the addition of Russia many of the aspects of the Option A were dropped. The ISS today is much more the Freedom configuration.

2.2.3 Changes from SSF to ISS

2.2.3.1 *International Partners and Management*

The Reagan plan for the Space Station Freedom intended that it would be a permanently crewed space station built by the US, operated by the US, but with added capabilities from its IPs.²² The US goal would be that the IPs would not be on the critical path and their contributions would be enhancements. As the definition of the ISS assembly task grew it became obvious that the Canadian Canadarm2 would play a critical role in the station operations and assembly. The initial invitation to participate from President Reagan was to the US Allies. This invitation was answered by Europe (the European Space Agency, ESA), Japan (NASDA, later renamed JAXA) and Canada The Canadian Space Agency (CSA).

With the new program and its IPs, the US did retain its role as the integrator (with Boeing as the prime US Contractor), but the IPs were responsible for the development and long term support of their modules and were now major investors and equal partners in the ISS. In fact the management of the ISS has been devised in the Memorandums of Understanding (MOU's) to utilize bilateral relationships to facilitate the development of the elements and a multilateral framework to integrate the overall operations of the ISS. In the multilateral framework the stated goal was consensus decision making although the US was empowered to make decisions if no consensus could be reached. As the configuration evolved, the IP contributions (particularly those from the Russians) became increasingly more important to the critical path of ISS assembly. This situation required a much more integrated plan of testing, assembly and operations. It also led to schedule impacts as partners had budget and development challenges.

Under the new ISS,²³ NASA was essentially the managing partner, with each board chaired by the NASA representative. In cases where consensus could not be reached, the NASA representative had the right to make a decision for the board; however, this right was rarely used in practice. Nothing in the ISS arrangements conferred upon NASA the right or ability to compel another IP to take specific actions against its interests; therefore, occasions were rare in which it was efficacious for NASA to make unilateral decisions. This was a significant challenge to the systems engineering process, as NASA had to negotiate processes with individual partners and across the entire partnership. In a systems engineering aspect several architectural decisions were successfully implemented across most of the elements. Since the partnership agreement with Russia allowed the use of existing or heritage equipment some of those architectural agreements were not extended to the Russian elements.

²² "Structuring Future International Cooperation: Learning from the ISS," L. Cline, P. Finarelli, G. Gibbs, I. Pryke,

²³ "Lessons Learned and Recommendations on International Participation from the International Space Station Program," Daniel V. Jacobs and Michael J. See, Lyndon B. Johnson Space Center, Sept. 2004.

The inclusion of the Russians brought major changes. Several changes were cultural, since the Russian approach to space systems, engineering and operations was different than that of the US and its contractors. The source of the differences came with respect to approaches to systems design. Basically, the Russians tended to employ a very evolutionary approach that drew heavily on heritage designs, whereas NASA and ESA engineers were much more inclined toward clean sheet designs which incorporate latest technologies. So, there were differences in the details of the respective systems engineering approaches driven by these distinctive approaches to systems design. Furthermore, the other IPs, foreign countries with different languages, operated more like the US. Many of their engineers and managers were US-trained and educated, and their aerospace firms had worked on US projects or with US contractors. That was not the case with the majority of the Russian government and private contractors. Most of the Russian contractors were cold war remnants of the Soviet Union and were struggling to remain in business. Furthermore, most of their engineers had little contact with western firms or practices—despite some contact through professional organizations and journals. Finally, the Russians as a new team member did not integrate as easily as European, Canadian, or Japanese partners, who had worked with NASA for years.

2.2.3.2 Orbit

A major change for the ISS was the decision to place the station in a 51.6 degree orbit, the inclination the Russians achieve by launching due east from Baikonour. Prior launches from the Kennedy Space Center were frequently at an inclination of 28.5 degrees to the equator (which allows for the maximum delta-v imparted to the launch vehicle by the rotation of the Earth due to a due east launch), though the Shuttle had flown several different inclinations prior to the ISS flights. This orbit provided safe launches over water into an orbit that the Soviets could not reach without incurring a substantial payload penalty. Changing the orbital inclination to 51.6 degrees allowed the Russian launch facilities to provide support to the ISS.

At the time, NASA was sensitive that future groundings of the Shuttle fleet due to accidents (Challenger had just occurred in 1986) would severely impact the ISS, and the possible use of a Russian capsule for rescue or backup crew transport was a valuable asset to bring to the team. The downside to this option was the reduction of Shuttle lift capability (almost 11,500 pounds out of its maximum capability of 55,000 pounds). Later the Shuttle program regained much of this lift through the development of a “super lightweight” version of the Shuttle External Tank and other weight savings options. This dissimilar redundancy of launch vehicle was validated with the future repeated use of the Progress and Soyuz vehicles after the Columbia accident and the grounding of the Shuttle fleet in 2003. Fourteen successive Russian crew and supply missions reached the ISS before the shuttle returned to flight.

Changing the orbital inclination was a huge SE challenge. It impacted key ISS design elements such as power and thermal subsystems, orbital debris protection, and STS operations. Moreover, none of the subsystems were redesigned to maximize operation in the new orbit. The decision was taken that in order to save design costs, much of the hardware designed for a 28 degree orbit would be flown ‘as is’ in the higher-inclination orbit. The change increased the number of assembly flights, restricted launch windows throughout the year and per launch opportunity. Changing the orbital inclination was a major decision that ended up being negotiated at the Vice Presidential Level (Al Gore and Viktor Chernomyrdin). This decision salvaged much of the design up to that point, but created major operational complexities that are

still being experienced today, and that indeed drive the size and cost of the workforce needed to operate and maintain the ISS.

2.3 NASA Systems Engineering Environment

2.3.1 NASA Management Approach

NASA had the task of leading a sixteen-country international team through the ISS system development, module production, visiting vehicle fleet scheduling and integration, on-orbit construction, and the long-term station operation. Each agency negotiated and signed detailed agency-specific Memoranda of Understanding (MOUs) that defined partner contributions, payments for support, and operational responsibilities. Operational control of the ISS in entirety was to be enabled from Houston and Moscow, while control of payloads and some partner module systems were planned for partner auxiliary sites such as St. Hubert and Huntsville. As shown in Figure 8,²⁴ multiple control centers and launch sites are in use.



Figure 8. NASA and International Partner Operations Scope

In order to appreciate the effectiveness of the post 1993 Space Station redesign management approach, a brief background of the Space Station Freedom period is useful. The original structure of the Space Station Freedom systems engineering effort involved several “levels”. The Freedom engineering hierarchy was organized as much for political/congressional funding reasons as for any other reason, and this structure led to significant integration issues, due to its wide geographic spread and the decoupled nature of the financial oversight of the

²⁴ “Final Report of the International Space Station Independent Safety Task Force,” February 2007

program. Level 1 was housed at NASA headquarters in Washington, DC. It was not directly involved in the day-to-day engineering effort, and instead handled most of the political interfaces and the highest-level program funding decisions. Level 2 was a specially created NASA center, housed in leased office space in Reston Virginia, separate from both HQ and the NASA field centers. Level 2 was explicitly designed to be a systems engineering center for the Freedom program. However, Level 2 was not empowered to control budgets of individual project offices (the work packages) at the field centers, thus it had virtually no leverage over the engineering projects it was supposed to integrate.

Level 3 handled the detailed engineering of the subsystems and the modules. Each subsystem and each module had a system development manager (SDM) and a system integration manager (SIM). The power generation system was assigned to the Lewis (later renamed Glenn) Research Center, the environmental control and life support system was assigned to Marshall Space Flight Center (MSFC), most other systems and subsystems were assigned to the Johnson Space Center, the integration of the modules and payload accommodations were assigned to the Marshall Space Flight Center, and the special dexterous human-like robotic system called the Flight Telerobotic Servicer (FTS) was assigned to the Goddard Space Flight Center. There was tremendous political pressure to have major responsibilities assigned in the different congressional districts: thus it was ambiguous in many cases to know who was actually in charge.

As an example of the confusion that could ensue from such organizational structure, consider the distribution of electrical power. The secondary power system was managed at JSC as a subsystem. Its interface with payloads occurred at the interface to racks within the US lab and inside modules developed by ESA and by NASDA (later named JAXA). The control of the power distribution was accomplished through the data management system (DMS) architected at JSC, but programmed in the individual field centers in individual Tier 1 controllers (more on Tier 1 later). At varying meetings, it was claimed that the command and control of the power management at the payload rack interface was the responsibility of the power subsystem team, the payloads team, the lab module team, and the data management team. Contractors working for the payloads community developed the obligatory Payloads to Electrical Power Subsystem (EPS) Interface Requirements Document (IRD). At the same time, contractors working on the power subsystem developed the Electrical Power Subsystem to Payloads Interface Requirements Document. Neither was developed with the cooperation of the other contractor or center. The Lab team developed IRDs to both groups that encapsulated the electrical interface control with the Lab control processor in charge. The Data Management System (DMS) team developed independent IRDs to the Lab, to payloads, and to EPS, and they in turn developed independent IRDs to the DMS, with such routine matters as closing electrical circuits as one of the major functions of the interface.

Worse, in the early days of Freedom, the contract structure required that the contractors deliver such documents by certain drop dates. The technical maturity of such contractually mandated books was not specified in the delivery dates: only the structure of the document and key contractually-mandated legal text was specified. Thus, scores of such IRDs flowed around the program with boilerplate preamble text and acronym lists, sandwiched around technical sections that were largely filled with "TBD". It was easy to get decoupled, and to stay that way for long periods. Level 2 had no power to order the elimination or merging of any duplicate documents. From the scant technical content that did emerge from the myriad boilerplate

documents, the emerging command and control team found at least seventeen command names for the act of activating a switch, including command names such as “On”, “Toggle”, “Enable” “Switch”, “Power”, “Power ON”, and “Set On”.

The concept of Level 2 and work-packages exemplified how not to conduct systems engineering on a complex system. As exemplified above, the Level 2 management had no control, specifically budgetary control, over the Level 3 Work Packages. “Influence” proved not to be a sufficient integrating lever. It was clear at that point that a single lead center with designated program management authority and control as well as resident engineering horsepower was an absolute necessity on a program this large, complicated and multi-national. The Johnson Space Center became the lead program management and SE center following the 1993 redesign (the post-Space Station Freedom era). In that role, they are supported by Boeing, who served as the integrating contractor and prime support contractor. Boeing has procured and developed several of the key modules and systems. Boeing also provides overall hardware-software integration and sustaining engineering. Along with Boeing are hundreds of large and small contractors providing key subsystems, technical supports and logistics services. Within NASA, these contractors are engaged through normal contracting channels and participation on Integrated Product Teams (IPTs).

Boeing played a critical role on this team as the lead system engineer for the program. Boeing provided the experience to co-lead the IPTs with NASA and execute the SE management that was a major challenge on this program due to the multi-partner integration. It was a challenging role, since Boeing could not officially negotiate with other countries and often had to provide the technical lead while NASA provided official signature on detailed international agreements known as “Protocols”.

The overall Program team is managed through an ISS Control Board Structure, as shown in Figure 9. The ISS team uses top-level control boards and panels to manage the ISS hardware and software configuration along with any operational products. At the very top of the process is the Space Station Control Board (SSCB) that manages the multilateral control of the configuration. A NASA Space Station Program Control Board exercises control over the several layers of more detailed ISS subsystem control boards associated with the US elements. This process is also integrated with the Space Shuttle control boards. Each partner utilizes a similar control mechanism for their elements.

Boards Integrate International Partner and Contractor Teams within their Disciplines

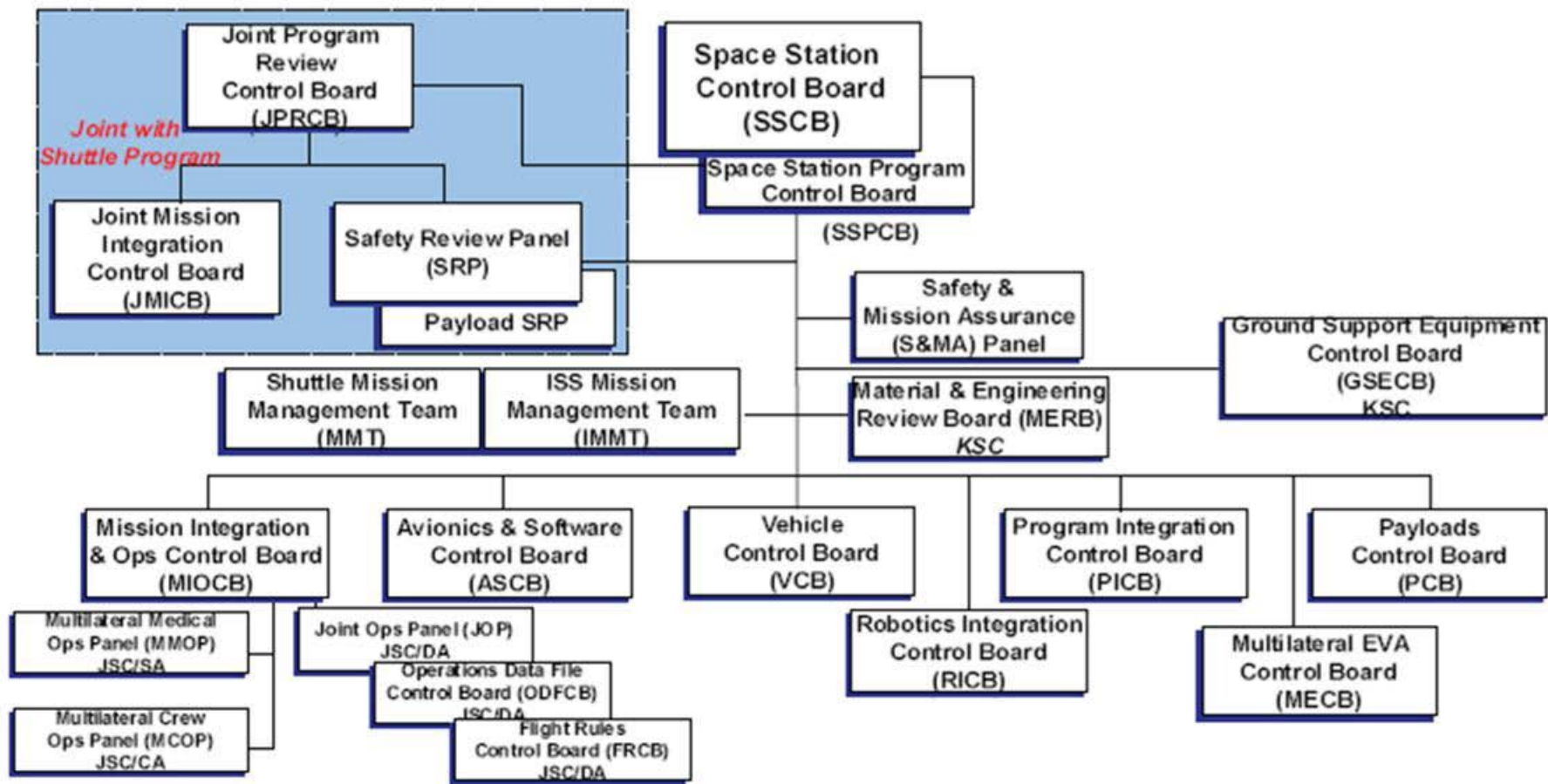

Figure 9. Systems Engineering Integration Boards

2.3.2 NASA Center Approaches

NASA has 10 major centers within its organization and in theory they are of one mind on systems engineering as it relates to major projects. As an agency, NASA maintains Systems Engineering process guidance and good practices as documented in its NASA System Engineering Handbook.²⁵ Despite this set of agency-level process requirements, the interviewees commented that each NASA center had a legacy systems engineering (SE) process that was at times, slow to conform to the agency approach. Additionally, several reported that the SE processes were driven by the lead SEs, who tended to dominate the resident programs. The approaches are also different based on the systems being developed and operated, which allows for a tailoring of the approach. In the case of the ISS, this was exacerbated by the inclusion of the international partners whose SE approaches differed significantly.

In a 1969 speech prior to the ISS and prior to becoming NASA Administrator,²⁶ Robert Frosch commented on strict adherence to mandated SE techniques and bureaucracy:

“I believe that the fundamental difficulty is that we have all become so entranced with technique that we think entirely in terms of procedures, systems, milestone charts, PERT²⁷ diagrams, reliability systems, configuration management, maintainability groups and other minor paper tools of the ‘system engineer’ and manager. We have forgotten that someone must be in control and must exercise personal management, knowledge and understanding to create a system. . . . Systems, even very large systems, are not developed by the tools of systems engineering, but only by engineers using tools.”

2.3.3 System Engineers and the Experience Chain

A major issue of any program, especially one like the ISS going on two decades, is how to recruit, develop, and retain quality system engineers. In fact, NASA’s human spaceflight programs are usually generational programs. NASA has to manage the workforce over decades while ramping up for new programs, maintaining ongoing programs and shutting down long-term programs. In the ISS case, the challenge is especially difficult.

- The initial workforce was a mix of experience, some dating all the way to Apollo, Skylab and Apollo-Soyuz. Most of the staff, however, came from the Space Shuttle, Space Station Freedom, and Shuttle-Mir programs. While the ISS program has been relatively successful to date, it has been under constant attack due to its schedule and budget issues, along with competition from other programs (inside and outside of NASA). This does not create a stable long-term work environment for some engineers.
- Many of the engineers desire career progression either in management or to other technical areas or programs. This tends to encourage engineers to leave the

²⁵ NASA System Engineering Handbook, NASA/SP-2007-6105

²⁶ “A Classic Look at Systems Engineering,” Bob Frosch, Asst. Secretary of the Navy for RDT&E, speech to the IEEE Group on Aerospace and Electronic Systems their international conference in New York, 26 March 1969.

²⁷ PERT is Program Evaluation Review Technique

program and seek other opportunities. This is particularly exacerbated in very long term programs like the ISS.

- While not unique to ISS, over the program’s history, many of the traditional NASA government positions and areas of responsibility have been absorbed by contractors in attempts to reduce cost. While this study does not allege any difference between a practicing government SE as opposed to a contractor SE—there is a difference driven by job descriptions and responsibilities. As the government SEs/engineering positions decline, the remaining personnel have less opportunity to “start at the bottom” and do detailed engineering over a full career. Rather, they often see their administrative and management responsibilities leave them little opportunity to learn and to hone their engineering skills. At the same time, more and more of the engineering and system engineering responsibilities are assigned to the contractor. This makes it very difficult for the government SE to gain in-depth SE experience.
- During the space station redesign a decision was made to dramatically modify the systems engineering and integration aspect of the program. Rather than the Freedom model of the government team (with a support contractor) providing SE&I, the team recommended selecting a single prime contractor to manage those functions across the multiple US elements and to provide support to the integration with the partners. This change was based on the potential cost savings but also to simplify what the panel felt was a confusing organizational structure and diffuse accountability. Depending on the level of the division of labor between NASA and the Prime this can lead to dissatisfaction with engineers who desire a more “hands on” level of participation in the SE process. Although it may depend on who you ask, with many NASA ISS engineers believing that the IPT structure made the system a bit more “badge-less” between the Prime and the government.

Multiple studies have researched the traits that make a good systems engineer and the environment that is required to nurture them. A recent study²⁸ from the Aerospace Corporation²⁹ investigated why certain organizations were able to develop a steady stream of qualified systems engineers. In this study, Dr. Davidz identified five foundational elements that support a system engineering development environment:

1. Componential element: this element describes those aspects that are considered in systems thinking, such as systems objectives, elements, and domain. This considers components such as political, organizational, economic and technical.³⁰

²⁸ “Developing the Next Generation of Systems Engineers” by Dr. Heidi Davidz, Aerospace Corporation 2006

²⁹ Aerospace Corporation is a federally funded research and development center (FFRDC) for the United States Air Force and the National Reconnaissance Office to support all national-security space and missile programs. They have provided independent technical and scientific research, development, and advisory services to national-security space and missile programs since 1960.

³⁰ “Enabling Systems Thinking to Accelerate the Development of Senior Systems Engineers” PhD Dissertation, Dr. Heidi Davidz, Massachusetts Institute of Technology, 2006.

2. Relational element: this element addresses the connections, interactions and interdependencies within the system or system of systems.
3. Contextual element: this element addresses the nested and embedded natures of systems
4. Dynamic element: this element links systems in time to the future and past, to include aspects such as feedback, uncertainty, risk and programmatic “ilities.”
5. Modal element: this element aids with understanding and comprehension of the system and is the “how of systems thinking.”

A NASA sponsored study³¹ focused on 38 successful, highly regarded mid-level system engineers across the NASA Centers. Despite the wide dispersal at different centers with different SE environments, the engineers demonstrated the same basic highly effective behaviors. These behaviors fell into five broad categories: leadership, attitudes and attributes, communication, problem solving and systems thinking, and technical acumen.

2.3.4 Systems Engineering Challenges of the ISS

The massive scope of budget, schedule, and technical goals of the ISS was daunting compared to previous space projects. It is one of the largest international programs in modern times directly involving sixteen nations, well over 100 launches and almost 200 space walks before the station will be completed. From the beginning, the team members were aware that they faced three major system engineering challenges³²:

1. Extended Development Cycle: The NASA team started on the initial space station program back in the 1984 time frame, then went through several changes before becoming the ISS in 1994. Initial modules weren’t launched until late 1998 with final assembly not scheduled until about 2010. Final shutdown of the station is no earlier than 2016. This creates an incredible burden of handling engineering staffs, knowledge retention and training, management, government transitions, budget fluctuations, technology maturation and obsolescence.

Over a long period of time, public and Congressional support can diminish, which puts incredible pressure on the team to make sure everything works—since failures are often rewarded with termination. As mentioned earlier the ISS program faced many cancellation votes in the Congress. Key analysts and engineers are also looking for challenges and the opportunity to work on a broad number of programs, so knowledge management and experience retention are serious issues.

2. Test and Verification: Due to the long development and build phases (not to mention the structural and size issues of the ISS), it is infeasible to test the entire ISS on the ground prior to launch. The first modules were on orbit prior to the completion of later modules. The modules and subcomponents must have high

³¹ “NASA Systems Engineering Behavior Study,” Christine Williams (NASA HQ) and Mary-Ellen Derro (JPL), October 2008.

³² “Systems Engineering Challenges of the International Space Station,” Mark. D. Jenks, 2000 NAE Symposium on Frontiers in Engineering.

reliability and be able to work immediately, since on-orbit repair options are often limited. As discussed later, new system test procedures were developed to allow for multi-element integrated testing. Other parts are designed for space (such as the solar panels) and thus can't be deployed on the ground for system checks without damaging them or required expensive special test fixtures. As will be explored later, there is the not-so-trivial issue that several modules were made by the International Partners using different system engineering approaches with the goal of meeting integration standards. Most of these modules never physically mated until they were in low Earth orbit. Finally, a major issue is that the ISS must be flight ready with the first module and then with the addition of each new module or sub-system, operate on its own as a new independent space vehicle.

3. Infrastructure Scale and Complexity: The infrastructure needed to house the program offices, engineering staffs, production facilities, and integration and test facilities is huge and represents a worldwide investment. NASA made a large investment at the Kennedy Space Center to perform these functions and to stage major ISS subsystems and parts. The infrastructure just for the launch vehicles and their support structure is a multi-billion dollar effort. The ISS relied initially on the Shuttle and the Russian launch capabilities—all major programs themselves. Eventually European and Japanese launch capabilities are also utilized.

2.3.5 Systems Engineering Process

The ISS used a system engineering process³³ based on the classical textbook model with four key elements:

- (1) The ISS is a time-phased development -- the build schedules for the ISS components are driven by the launch schedule, which was initially spread over a five year period (ultimately took 12 years including the Shuttle downtime from the Columbia accident.).
- (2) The ISS is physically integrated “in the field” -- the ISS is assembled on orbit from its 87 major component items.
- (3) The ISS is literally built “around the world” -- major component items were built in the United States, Europe, Japan, Canada, and Russia, each of whose engineering methods and cultures differ significantly. Because of this, a “meets or exceeds” process was established to allow each partner to use its own process standards rather than trying to force adoption of NASA’s process standards. In this case, a “meets or exceeds” evaluation was performed on foreign deliveries (from ESA, ASI, NASDA, and CSA) with respect to manufacturing standards, particularly on materials processes and EEE parts. With respect to Russia, the evaluation was extended to include almost all of the aerospace standards, including fracture control, human factors, and coatings.

³³ “System Engineering the International Space Station,” L. D. Thomas, Proceedings of the 33rd Space Congress, pp. 5-35 through 5-44, April 23-26, 1996.

- (4) The ISS must function as a spacecraft during its assembly – its crew inhabited the ISS beginning with the third assembly flight, both to aid in assembly and conduct scientific research. The ISS flew in 44 free-flying configurations during the assembly phase, an equal number of shuttle-mated unique configurations, and is comprised of scores of smaller flight elements.

This was a fusion of the NASA systems engineering approach (as codified in the NASA SE Handbook SP-6105) and the Boeing system engineering process (which was also well documented and executed). At program start, NASA had over 100 system engineers in the program office and Boeing provided 300-400 systems engineers. Boeing brought a great deal of SE experience plus their airplane design and production experience that NASA lacked. This allowed Boeing to share its aircraft experience in integrating parts and systems using digital preassembly techniques to form computer aided design (CAD) models.

A key ingredient of the ISS success was the successful integration of the customer's needs into requirements and specifications. Dr. Dale Thomas (former ISS Systems Engineering and Integration Manager) described the approach as:³⁴

“All too often, system engineering preoccupies itself with requirements definition for a product. Requirements definition is a means, not an end. For this reason, this section explicitly includes integration in the title. Indeed, within the scope of this paper, system engineering includes the development of a valid and cogent set of requirements and the verification of the as built design against those requirements. Hence, system engineering must provide assurance that the product as designed and built meets the customer's stated need; this is the integration half of the process.”

2.3.6 International Partners

2.3.6.1 Creating International Partnerships

A major challenge of the ISS program was how to solve the political, financial, and technical aspects of putting together a long-term international partnership. Long before the systems engineers from each country could sit down and start work, agreements on management, funding, and issue resolution had to be created. While it was not easy, NASA eventually worked out a process that accommodated multiple countries with differing cultural and engineering approaches to major program development and execution. NASA produced a lessons learned report on the process and issued the following recommendations:³⁵

- (1) Early in the program, NASA should establish the legal and policy framework for the partnership that covers intellectual property rights, liability, dispute resolution, public affairs, amendments, international and criminal jurisdiction, customs and integration, and terminations. No technical program information should be included.

³⁴ “System Engineering the International Space Station,” L. Dale Thomas, Manager VAIT, NASA Space Station Program Office.

³⁵ “Lessons Learned and Recommendations on International Participation from the International Space Station Program,” Daniel V. Jacobs and Michael J. See, Lyndon B. Johnson Space Center, Sept. 2004.

- (2) As an evolutionary type program, initial projects should be bilateral and relatively short in nature. Larger projects requiring multilateral arrangements should come later.
- (3) A governance model and agreement must be established. The ISS Program was set up to operate using a board and panel structure, each of which functioned on consensus. NASA took the role of the managing partner, with each board chaired by the NASA representative. In cases where consensus could not be reached, the NASA representative had the right to make a decision for the board; however, this right was rarely used in practice. The advantages of this arrangement were that each IP had a voice and that this system allowed IPs to abstain when it was not in their interest for cost, schedule or other programmatic reasons. The drawback was that the system could become paralyzed when no consensus was reached on an issue and NASA could not progress on it absent the support of the dissenting IP(s). The NASA report noted that the Russians had been reluctant to fully integrate itself into the board structure, preferring to handle most issues on a bilateral basis with NASA. All the partners have resisted providing staffing to support the NASA board structure to the level that NASA does.
- (4) Critical path management had to be maintained by NASA as the managing partner. The critical path had to be studied and evaluated from an integrated program perspective to determine the range of risks. This would impact how the specific program plans were made or altered to minimize risk. When partner elements or capabilities were on the critical path, NASA may have risk contingency plans in place (with the full knowledge of the IP). This was a key issue early on with the Russians delivering the first two major modules that were critical to attaining initial operational capability. After the first module (purchased by NASA) had been delivered on orbit, there was a nearly two year gap to the next critical Russian element. In this case NASA considered using a backup power and support module that had been partially developed for another program (later cancelled when not required).

2.3.6.2 ITAR and shared technology issues

The International Traffic in Arms Regulations (ITAR) posed a threat of foreclosing whole categories of cooperative efforts on the ISS.³⁶ ITAR rules were designed to protect militarily sensitive U.S. technologies from falling into the hands of U.S. adversaries. But U.S. allies are also subject to them, even in cases in which the law's application seems to have escaped the bounds of its intent. ITAR regulations apply to the ISS and all of its partners: Russia, Europe, Japan and Canada. These nations signed a treaty-level document called the Intergovernmental Agreement, which sets out each partner's rights and responsibilities, and governs relations in the station's operation. The agreement was signed before ITAR went into effect in 1999, and the partners have debated whether the treaty takes precedence over ITAR, or whether ITAR should govern the station partners' relations.

The National Aeronautics and Space Administration (NASA) Authorization Act of 2005 (Public Law 109-155), required the creation of an International Space Station Independent Safety

³⁶ "ESA Looks East," by Peter de Selding, Space New Business Report, Jul 2005

Task Force (IISTF) to assess the vulnerabilities of the International Space Station (ISS) that could lead to its destruction, compromise the health of its crew, or necessitate its premature abandonment and to report back to NASA and the Congress. The February 2007 study³⁷ reported the following:

The International Traffic in Arms Regulation (ITAR) restrictions and IP objections to signing what the IPs believe are redundant Technical Assistance Agreements are a threat to the safe and successful integration and operation of the Station. For example, a contractor workforce comprises a majority of the operations workforce and must be able to have a direct interface with the IP operations team to assure safe and successful operations. Their interactions, ability to exchange and discuss technical data relevant to vehicle operation, etc. are severely hampered by the current ITAR restrictions.

The systems engineering impact of ITAR was quite simple—it placed a constraint on the SE processes and engineers. Like any constraint in a process, it usually results in a sub-optimal outcome. At its simplest, it prevents the use of technologies on key modules or the interaction of systems engineering personnel to develop and operate systems. On orbit, it could result in certain equipment, procedures, or full modules being off limits to specific astronauts, or specified equipment could not be integrated into other systems. Obviously, the ISS could not operate with an integrated crew with those restrictions and NASA worked within the limitations of ITAR.

2.3.6.3 Differing SE Approaches among International Partners

There is a myth that science and engineering is black and white—that regardless of which country does a project they all approach it the same. The NASA experience was that this was not true and that a significant amount of planning, organization, and statesmanship was needed to run a large international program like ISS. The NASA lessons-learned report³⁸ pointed out the following key observations:

- There are no standard practices—SE approaches may differ widely (along with management, funding and scheduling approaches). The key to success was technical and integration processes that were defined for all to follow or else to integrate with key milestones. Communication protocols were essential, particularly in understanding the varying lexicons.
- The ISS had a single payload safety panel with full partner participation.
- A difficult, but key, accomplishment was forcing all Partners to integrate their schedules, budgets, and development life cycles. While each may have had different detailed levels, they all had to integrate at the top program levels for discussion and execution, particularly as the Space Shuttle was the launch vehicle for US, European, Japanese and Canadian elements.

³⁷ “Final Report of the International Space Station Independent Safety Task Force,” February 2007.

³⁸ “Lessons Learned and Recommendations on International Participation from the International Space Station Program,” Daniel V. Jacobs and Michael J. See, Lyndon B. Johnson Space Center, Sept. 2004.

- Configuration Management and Control must be established early. While this is always an issue, the ISS had a different twist with its IPs. Here, the IPs as independent agencies could use the change process to gain political or financial leverage by either not accepting changes or not following procedures.
- There were some benefits of having IP differences. While commonality is often preferred, dissimilar hardware approaches can add robustness for certain critical and complex functions. A good example is the two systems for adjusting station orientation—gyros and thrusters.

2.3.6.4 The Political Environment

Managing the disparate political environments of all partners has also been a challenge. All partners have differing constituencies, budget cycles and motivations. The economic issues in Russia in the mid-1990's created significant financial hardships and gave rise to commercial activities that were not fully embraced by the other partners. Many of the partners faced political financial issues at various times. One of the most notable issues was the Russian plan to fly space tourists to the ISS. While this caused significant strife in the partnership in the beginning, the teams have learned how to effectively manage with this component as well. Ultimately the other partners found a joint resolution which would accommodate the space tourist flights.

Despite several very high level differences the partners have worked consistently effectively at the program level. This is a tribute to all partner teams.

2.3.7 Safety/Risk approaches

2.3.7.1 NASA Safety Process

NASA has developed a rigorous safety review process that is documented in their safety review process regulation³⁹ for the overall integrated safety of the ISS. The purpose of this is to provide in-line and phased reviews for the flight and ground elements and the support equipment. NASA has signed MOUs with all international partner agencies⁴⁰ including RSA⁴¹ delegating NASA as responsible for the overall integrated safety of the ISS. In that role, NASA provides the overall certification that the system (and its elements) is safe.

NASA and its International Partners have put together a rigorous process to manage risk and to oversee the development and operation of all ISS activities:⁴²

- ISS Mission Management Team: This senior level group meets almost daily to discuss ongoing ISS operations, upcoming missions, and to discuss solutions to ongoing or developing problems. This not only includes onsite leadership, but also coordination and participation of partners.

³⁹ Safety Review Process, International Space Station, SSP 30599 Revision B, February 2000.

⁴⁰ International Partner specifications are derived from SSP 50021 (flight) and KHB 1700.7, Space Shuttle Payload Ground Safety Handbook.

⁴¹ The Russian segment specification is implemented through SSP 50146, NASA/RSA Bilateral S&MA Process Requirements Agreement.

⁴² "Final Report of the International Space Station Independent Safety Task Force," February 2007

- Safety and Mission Assurance (S&MA) Office: This group reports directly to the ISS program manager and is responsible for managing the ISS safety program. The group integrates all inputs from the IPs and manages their safety reviews. It also manages all S&MA activities, reviews and requirements with the major contractors. Finally, it supports the headquarters organization as needed.
- Safety Review Panel: This group reviews and approves the hazard reports and safety data packages required for flight approval. It assesses the safety and design of all flight ISS segments, related ISS flight support equipment, ISS visiting vehicles, and ISS assembly operations.

To achieve safety and reduce risk, NASA and the team have addressed all elements of the SE process to minimize problems with the design, test, production and operation of the ISS. These key elements were reviewed by the ISS Independent Safety Task Force⁴³:

- Basic system design requirements must address three levels of risk:
 1. Two-failure tolerant to catastrophic hazard—The on-orbit space station must be designed so that no two failures, or two operator errors, or one of each can result in a disabling or fatal injury or the loss of the Shuttle or ISS;
 2. One-failure-tolerant to critical hazards--The on-orbit space station is to be designed such that no single failure or single operator error can result in a non-disabling personal injury, severe occupational illness, loss of a major ISS element, loss of an on-orbit life sustaining function or emergency system, or damage to the Shuttle;
 3. Design for minimum risk—Hazards are controlled by safety related properties and characteristics of the design rather than failure tolerance criteria.
- Robust On-Orbit Systems: The design philosophy is that the elements must meet a two failure-tolerance requirement to avoid catastrophic outcomes. Most of the major systems have a US system and separate Russian system. Both agencies have very different approaches to providing these capabilities which reduce the likelihood of a common failure. Most redundant systems also are built capable of repair or on-orbit replacement. As an example, there are four sources of oxygen at all times: the Russian oxygen generator (Elektron), bulk oxygen in tanks, the US Oxygen Generation Assembly (OGA), and oxygen generation canisters. While there have been issues with each, there never has been a simultaneous failure of all four.
- Verification Process: This is a five-step process that verifies that all hardware and software meet requirements:
 1. Clearly identify all requirements

⁴³ “Final Report of the International Space Station Independent Safety Task Force,” February 2007

2. Define the requirement's closure strategy—verify the requirements are met via inspection, analysis, demonstration or test.
 3. Execute the necessary verification activities
 4. Develop verification reports/analysis
 5. Document closure
- **Physical Verification:** This step checks to ensure that the parts fit together and the major sub-assemblies integrate correctly. This step cannot be accomplished at the assembly level, since most of the modules and trusses are not assembled together until the parts are on orbit.
 - When possible, actual integration checks should be conducted on the ground
 - The process should develop and maintain accurate and detailed measurements of all parts for virtual integration checks and modeling
 - The process should include 3-D and virtual analysis or mating
 - Full simulation and continuity checks of all cables, electrical, and fluid connections should be conducted to ensure functionality

2.3.7.2 Safety and Off-the-Shelf Systems

A major focus of the ISS program was to use only proven systems (see page 50 for a discussion of technology readiness levels) but still meet evolving safety requirements. There were initial concerns about the Russian modules being proposed (Zarya and the Service Module) since they were already partially built prior to the final station design requirements. NASA safety officials⁴⁴ studied the systems prior to their launch and questioned four areas:

1. Inadequate shielding from orbital debris—this was a basic design tradeoff by the Russians to keep the weight down and was designed prior to the ISS requirements.⁴⁵ With the exception of the Zarya module, built under direct contract to the US government, the Russian modules were too heavy to add any more protective panels before launch. The fix would be to later install panels on orbit if needed.
2. Inability of Zarya and the Service Module to operate after losing cabin pressure. Much of the critical equipment in the modules required air for cooling electronics which would eventually fail in a vacuum. This risk has been lessened with the addition of other modules with redundant capabilities.
3. Service Module Windows not certified—at issue is whether the Russian windows meet the requirements of surviving a leak of the outside pane without causing a catastrophic failure or permanent leak. The window design planned for the

⁴⁴ “Russian Compliance with Safety Requirements,” GAO/T-NSIAD-00-128, 16 March 2000

⁴⁵ The ISS requirement was to have no more than a 2.4% probability of penetration over a 15 year life on orbit. The assessment was that the modules had a 25% probability. With the addition of shielding on orbit, the probability drops to 4% for the remaining life of the station.

Service Module windows did not meet the requirements for windows used on the other ISS elements. Several areas of concern included insufficient ultraviolet and infrared protection, no debris pane or scratch pane to protect windows from impacts or crew induced damage and no way to safe or replace a window should a window become damaged on-orbit. The windows on new modules are supposed to last 15 years, but the Russian design requirement was only five years.

4. Noise levels on the Modules—the ISS requires noise levels no more than 55 decibels over a 24-hour period, but the noise level in the Russian modules are in the 65-75 decibel range. This was an issue on the MIR, and several astronauts suffered temporary or permanent hearing loss. Several fixes have been implemented—more insulation, better crew hearing protection, and replacement of some of the noisiest equipment.

2.3.7.3 Aerospace Safety Advisory Panel

The Aerospace Safety Advisory Panel (ASAP) is a senior advisory committee that reports to NASA and Congress. The Panel was established by Congress after the Apollo Command and Service Module spacecraft fire in January 1967.⁴⁶ This panel has a 40+ year history of providing support to NASA and all of its programs. It is normally staffed with either senior or retired experts from the aerospace field to include previous NASA managers and astronauts.

The Panel's statutory duties, as prescribed in Section 6 of the NASA Authorization Act of 1968, Public Law 90-67, 42 U.S.C. 2477 are as follows:

"The Panel shall review safety studies and operations plans that are referred to it and shall make reports thereon, shall advise the Administrator with respect to the hazards of proposed operations and with respect to the adequacy of proposed or existing safety standards, and shall perform such other duties as the Administrator may request."

As part of the systems engineering process, safety plays a major role in the requirements, design, development, production and operation of the systems. In the case of NASA, this panel provides oversight to all of these areas, but does so in a limited capacity. The Panel does not work full time nor is it staffed⁴⁷ at a sufficient level to allow for detailed oversight or scrutiny. The panel also has limited authority other than recommendations to change NASA designs or operations. The panel provides recommendations to the NASA Administrator, develops an annual report, and reports to Congress.

This lack of authority and integration into the operational aspects has led to some heated discussions in the past.⁴⁸ Following the Columbia accident in 2003, the board issued a report (and gave Congressional testimony) that challenged NASA to make the ASAP more independent

⁴⁶ NASA Website: <http://www.hq.nasa.gov/office/oer/asap/history.html>

⁴⁷ The current ASAP has eleven members to include the director and an administrative officer.

⁴⁸ Testimony to the Senate Commerce, Science, and Transportation Committee on 29 October 2003 by Dr. Arthur Zygielbaum.

and to give it an operational safety role in launch decisions and other operation activities. The panel stated that in the past, NASA program managers allowed safety margins to erode in the face of schedule and budget pressures. The ASAP recommended that NASA's safety organization be placed in a separate chain of command that reported directly to the Administrator and thus provided a veto on the program managers' decisions during key operations (such as launch decisions). In a report issued prior to the Columbia accident, the board wrote:

“It is traditional in NASA for project and program managers to have the authority to authorize waivers to safety requirements. Safety critical waiver authority should reside with an independent safety organization using independent technical evaluation. Moving this authority would increase the management oversight of safety-related decisions and would strongly support the creation of a well-respected and highly-skilled safety organization.”

An independent technical, quality or safety oversight board is not a new concept. In most DoD organizations and contracts, groups like these report outside of the program managers to guarantee independence. This process is used by the US Navy Sea Systems Command.⁴⁹ In it, the technical authority is an independent expert who is isolated from the program managers' schedule and budget pressures.

The ASAP issues a yearly report that often contains warnings or recommendations challenging NASA program managers. The 2002 report was a prime example; the report listed a string of incidents or potential accidents due to miscommunication between Russian and American engineers that indicated a dangerous pattern to the committee:

- Shortly after STS-113 docked with the ISS, there was a loss of ISS attitude control due to a lack of system configuration.
- Lithium thionyl chloride batteries were brought on board over the objection of other ISS partners.
- Russian ground controllers sent commands to fire thrusters before US ground controllers had disengaged the Control Moment Gyroscope system.

A comment was made by a former ASAP member⁵⁰ that there might be communication and cultural issues between the Russians and Americans that also might contribute to increased risk of accidents.

⁴⁹ NAVSEA Instruction 5400.97A, Engineering and Technical Authority Policy, dated February 3, 2003

⁵⁰ Testimony to the Senate Commerce, Science, and Transportation Committee on 29 October 2003 by Dr. Arthur Zygielbaum. It should be noted that this testimony was triggered by the resignation of the entire ASAP the month prior (Sept 2003) due to criticism of the board by the Columbia Accident Investigation board.

3.0 FULL SCALE DEVELOPMENT

3.1 Major ISS Modules

3.1.1 Zarya Control Module

The Zarya Module (known by the technical term Functional Cargo Block and the Russian acronym FGB) was the first component launched for the International Space Station. This module was designed to provide the station's initial propulsion and power. The 19,323-kilogram (42,600-pound) pressurized module was launched on a Russian Proton rocket in November 1998 (Figure 10).

As part of the business arrangement between NASA and Russia, the United States funded this component of the station, although it was built and launched by Russia. The module was



Figure 10. Russian Zarya Module

built by the Khrunichev State Research and Production Space Center, which is also known as KhSC, in Moscow under a subcontract to The Boeing Company for NASA.

Construction of the Zarya Module began at KhSC in December 1994. It was shipped to the Baikonur Cosmodrome, Kazakhstan, launch site to begin launch preparations in January 1998. The three-stage Proton rocket launched the module into a 220.4 by 339.6 kilometer (137 by 211 statute miles) orbit.

Only two weeks after Zarya reached orbit, Space Shuttle Endeavour made a rendezvous and attached a U.S.-built connecting module called Node 1, or Unity. The Zarya Module provided orientation control, communications, and electrical power to the passive Node 1 while the station awaited launch of the third component, a Russian-provided crew living quarters and early station core known as the Zvezda Service Module. The Service Module enhanced or replaced many

functions of Zarya. The Zarya module is now used primarily for its storage capacity and external fuel tanks.

The Zarya Module is 12.6 meters (41.2 feet) long and 4.1 meters (13.5 feet wide) at its widest point. It has an operational lifetime of at least 15 years. Its solar arrays and six nickel-cadmium batteries can provide an average of 3 kilowatts of electrical power. Its nadir docking port accommodates either a Russian Soyuz piloted spacecraft or an unpiloted Progress resupply spacecraft. As the station grew, it became necessary to send an extension module (the Mini Research Module 1, or MRM1) to create a tunnel from this nadir port further towards the nadir, to provide docking clearance and additional ports for visiting vehicles. Each of the two solar

arrays is 10.7 meters (35 feet) long and 3.4 meters (11 feet) wide. The module's 16 fuel tanks combined can hold more than 5.4 metric tons (6 tons) of propellant. The attitude control system for the module included 24 large steering jets and 12 small steering jets. Its two 300 kgf engines were used for reboosting the spacecraft and making major orbital changes before Zvezda arrived. All of these engines were de-activated several months after the Service Module arrived, leaving the FGB to serve as a propellant storage and feed system to the Service Module and the visiting vehicles.

3.1.2 Unity Node

The Unity module (Node 1) was the first major U.S.-built component of the station and was delivered during STS-88 on Space Shuttle Endeavour in December 1998. It includes the Pressurized Mating Adapter 1 pre-fitted to its aft port. Assembly required crews to conduct three space walks to attach the Pressurized Mating Adapter 1 to the Zarya Control Module, and to outfit exterior gear such as handrails, cables, radio equipment, etc.

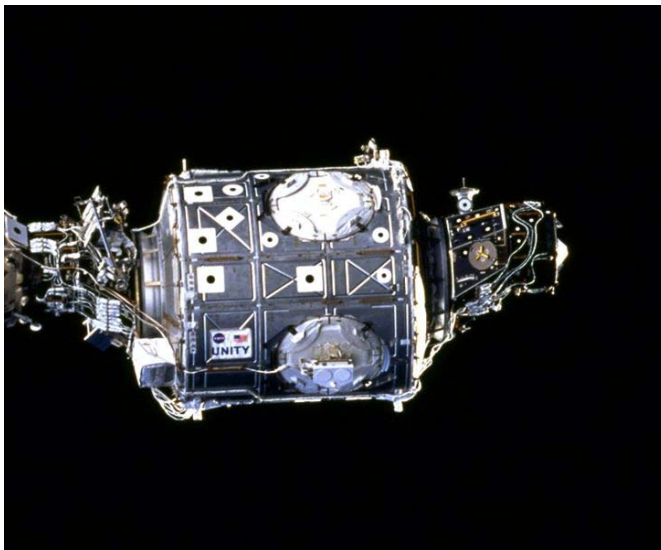

Figure 11. US Unity Module

In addition to its connection to Zarya, Unity serves as a passageway to the U.S. Laboratory Module (attached later) an airlock, and other future growth modules. It has six hatches that serve as docking ports for the other modules. It is 5.5 meters (18 feet) long, 4.6 meters (15 feet) in diameter and fabricated of aluminum. The Unity Node contains more than 50,000 mechanical items, 216 lines to carry fluids and gases, and 121 internal and external electrical cables using 9.7 kilometers (6 miles) of wire.

Two additional nodes (Node 2 Harmony and Node 3 Tranquility) were built for NASA by ESA and launched in October, 2007 and February, 2010 respectively. Harmony serves as the connection to the ESA Columbus and JAXA Kibo modules, discussed later, as well as the docking port for the Space Shuttle and later U.S. cargo and crew vehicles. Tranquility serves as the base for the cupola, also discussed later.

3.1.3 Zvezda Service Module

The history of the Zvezda module goes back to the late stages of the Cold War when it was originally intended as a cornerstone of the Russian Mir-2 space station. The service module closely resembled the core module of the Mir space station and its design lineage traces back to the Salyut and Almaz space station programs (see Figure 12). This was the first full Russian contribution to the ISS and was fully funded by the Russians. The Zvezda module was initially planned to launch in 1999. Given Russian delays, NASA embarked on development of a back-up module with the intent of securing the critical path in the assembly sequence.

Zvezda was launched on July 12, 2000 from the Baikonur Cosmodrome in Kazakhstan..It served as the early station living quarters and as the main docking port for the Russian Progress

cargo resupply vehicles. It also provided early propulsive attitude control and re-boost capabilities for the station. Zvezda's living accommodation⁵¹ provided two personal sleeping quarters, a toilet and hygiene unit, a galley with a refrigerator-freezer and a table for securing meals while eating. Its 14 windows⁵² offered direct viewing of docking activities, the Earth and other Station elements. Exercise equipment included a treadmill and a fixed bicycle. Cosmonauts wearing Orlan-M (and later, the Orlan MK) spacesuits used the Transfer Compartment as an airlock.⁵³ Zvezda also provided data, voice and TV links with mission control centers in Moscow and Houston.

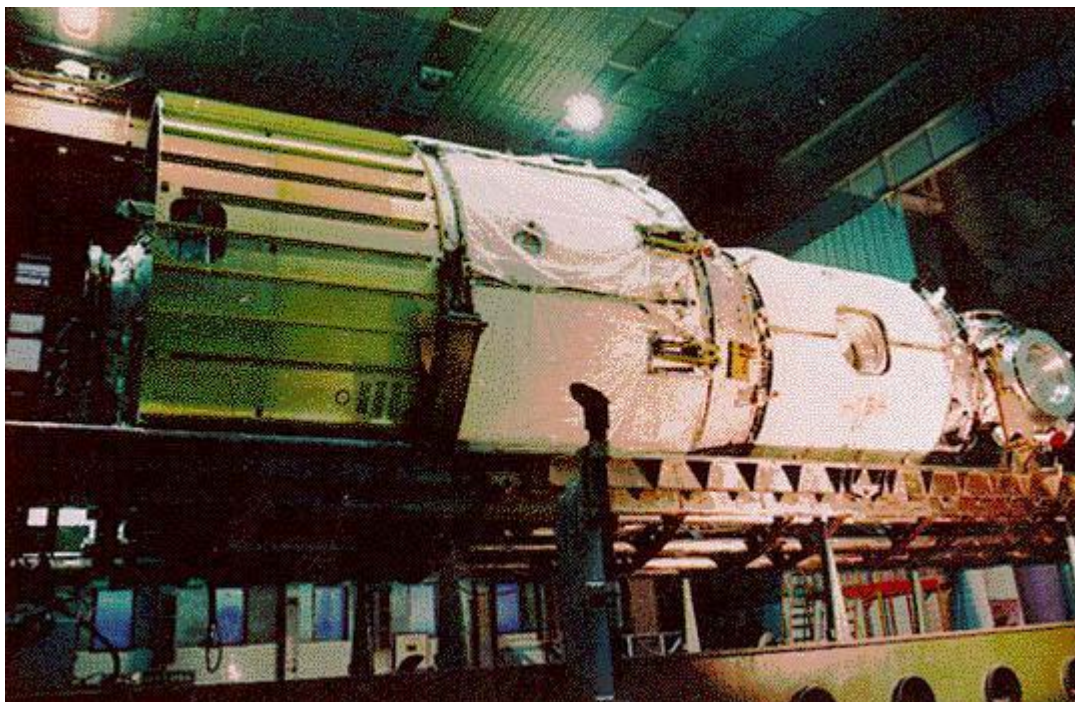

Figure 12. Zvezda Module with

3.1.4 Destiny Laboratory Module

The Boeing-built, Destiny Laboratory Module arrived at Kennedy Space Center, Fla. in November 1998 to begin final preparations for its launch on Feb. 7, 2001, aboard Space Shuttle mission STS-98, Station assembly flight 5A. As the first major laboratory, Destiny was the centerpiece of the US portion of International Space Station, where science experiments were performed in the near-zero gravity of space. The aluminum module consisted of three cylindrical sections and two end cones with hatches that were mated to the Unity module at one end, and

⁵¹ http://www.russianspaceweb.com/iss_sm.html

⁵² The windows in this module represented a difference in Russian design philosophy that placed importance on windows (for reconnaissance, research and crew considerations) vice the western designs that minimized the number of windows for safety reasons (a later US module would only contain a single, large window).

⁵³ Note, while the ISS had redundant airlocks early in assembly, the Russian airlock would only accommodate the Russian spacesuits and not the American suits.

would have the PMA-2 docking adaptor attached at the other on a later mission (See Figures 13 and 14).

When it arrived at the ISS, Destiny had five racks housing electrical and life-support systems. Subsequent shuttle missions have delivered more racks and experiment facilities, including the Microgravity Science Glove box, the Human Research Facility and five racks to hold various science experiments. Eventually, Destiny would hold 13 payload racks with experiments in human life science, materials research, Earth observations and commercial applications, plus eleven systems and storage racks.



Figure 13. US Destiny Laboratory Module

A 50.9 centimeter diameter window was located on the nadir side of the central module segment and is the largest window ever to be incorporated in a space station. Destiny's window (Figure 14), which takes up the space of one rack, is of optical quality that enables scientific quality photos, measurements and video. The window is protected by both internal and external covers to avoid degradation of the glass. The Window Observational Research Facility rack was later deployed to house scientific and observational equipment for use on the window.

The aluminum module is 28 feet long and 14 feet in diameter. The lab consisted of three cylindrical sections and two end cones with hatches that were mated to other station



Figure 14. US Destiny Module High Grade Optical Window

components. An exterior waffle pattern strengthens the hull of the lab. The exterior is covered by a debris shield blanket made of Kevlar similar to that used in bulletproof vests. A thin aluminum “sandwich” debris shield was placed over the blanket for additional protection. This module served as the primary living quarters for the non-Russian crewmembers during most of the assembly of the ISS.

3.1.5 Canadian Space Robotics System

The Canadian space robotics system, formally called the Mobile Servicing System or MSS, is an essential component of the ISS.⁵⁴ The MSS provides astronauts the ability to move equipment and supplies around the exterior of the ISS (Figure 15). It supported astronauts when they were working in space and could be used to release and capture satellites. The system has three parts:

- Canadarm 2, the Space Station Remote Manipulator System (SSRMS) - delivered to the ISS in April 2001
- the Mobile Remote Servicer Base System (MRSBS) - a work platform which moves on rails along the length of the space station - delivered to the ISS in 2002
- the Special Purpose Dexterous Manipulator (DEXTRE) - the space robotics "Canada Hand," which has two arms of its own - delivered in 2007.



Figure 15. Canadian Space Robotics System

The contribution of this technology, including Canadarm 2, helps CSA pay for its share of ISS operating costs. It means CSA has access rights to the space station lab facilities for experiments. It also means that CSA may send an astronaut to the ISS approximately every three years.

3.1.6 Quest Joint Airlock

The Joint Airlock (also known as "Quest") (Figure 16) was built by the U.S. and provided the capability for ISS-based Extravehicular Activity (EVA) using either a U.S. Extravehicular Mobility Unit (EMU) or Russian Orlan EVA suits. Before the launch of this airlock, EVAs were

⁵⁴ “Canadarm 2,” By Susan Monroe, Canada Online (<http://canadaonline.about.com>)

performed from either the U.S. Space Shuttle (while docked) or from the Transfer Chamber on the Service Module. Due to a variety of system and design differences, only U.S. space suits could be used from the Shuttle and only Russian suits could be used from the Service Module. The Joint Airlock alleviates this problem by allowing either (or both) spacesuit systems to be used. In the past, if the Shuttle was not docked, then the Russian space suits had to be used through the Russian docking port if an EVA was required. The variation in airlocks and spacesuits available on the ISS provides an important level of dissimilar redundancy for the EVA function.

The Joint Airlock was launched on ISS-7A / STS-104 in July 2001 and was attached to the starboard docking port of Node 1. The Joint Airlock is 20 feet long, 13 feet in diameter, and weighs 6.5 tons. The Joint Airlock was built by Boeing at Marshall Space Flight Center. The Joint Airlock was launched with the High Pressure Gas Assembly. The High Pressure Gas Assembly was mounted on the external surface of the Joint Airlock and supports EVA operations with breathing gases and augments the Service Module's gas resupply system.

The Joint Airlock has two main components: a crew airlock from which astronauts and cosmonauts exit the ISS and an equipment airlock designed for storing EVA gear and for so-called overnight "campouts" wherein nitrogen is purged from astronaut's bodies overnight as pressure is dropped in preparation for spacewalks the following day. This procedure prevents the bends as the astronauts are re-pressurized after their EVA. Without the 'campout' procedure, the cabin pressure in the entire ISS would have to be lowered prior to each EVA. The crew airlock was derived from the Space Shuttle's external airlock. It is equipped with lighting, external handrails, and an Umbilical Interface Assembly (UIA). The UIA is located on one wall of the crew airlock and provides a water supply line, a wastewater return line, and an oxygen supply line. The UIA also provides communication gear and spacesuit power interfaces and can support two crew in spacesuits simultaneously. These can be either two American Extravehicular Mobility Unit (EMU) spacesuits, two Russian Orlan spacesuits, or one of each design.

Before the crew airlock's hatch is opened to space, the crew airlock is depressurized to 3 pounds per square inch (psi) from the ISS pressure of 14.7 (psi) and then down to zero psi. To conduct this depressurization, a Russian-built compressor temporarily moves most of the air within the airlock to the main pressurized volume of the ISS. At the end of the EVA, the airlock is re-pressurized from this cabin air. By conserving the air, even at only 1.2 kilograms per cubic meter, several tons of logistics are saved over the life of the program. The Quest airlock is the only airlock in space history to conserve its air.

The atmosphere inside spacesuits is pure oxygen at 4.3 psi. Current spacesuit design requires these lower pressures in order for the suits to be flexible enough to work within. At higher pressures the suits stiffen and are hard to work in for prolonged periods of time.

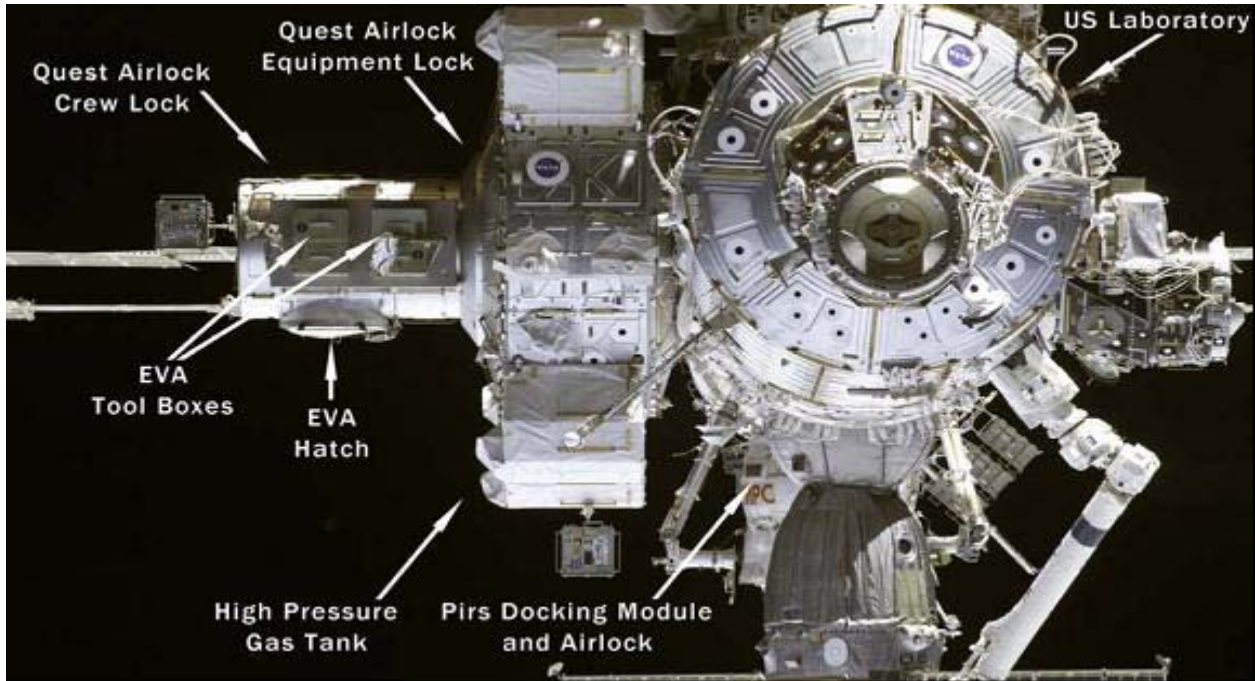

Figure 16. US Quest Airlock

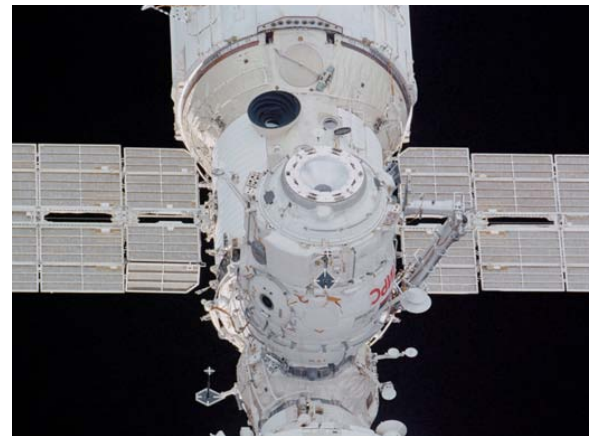

Figure 17. Russian Pirs Docking Compartment

The Equipment Airlock has stations that assist astronauts and cosmonauts as they move into and out of their spacesuits during periodic maintenance. The Equipment airlock has two racks, one for avionics, and the other for cabin air. Batteries, power tools and other supplies are also stored in the Equipment Airlock.

3.1.7 Russian Pirs Docking Compartment

The 3,580 kilogram Pirs Docking Compartment is attached to the nadir (bottom, Earth-facing) port of the Zvezda service module (Figure 17). It was docked to the ISS on September 16, 2001, and was configured during three spacewalks by the Expedition 3 crew.⁵⁵

⁵⁵ NASA official site, PIRS mission data,
http://www.nasa.gov/mission_pages/station/structure/iss_assembly_4r.html

Pirs was launched Sept. 14, 2001, as ISS Assembly Mission 4R, on a Russian Soyuz rocket, using a modified Progress spacecraft as an upper stage. The Docking Compartment has two primary functions. It serves as a docking port for the docking of Soyuz transport and Progress cargo vehicles to the ISS, and as an airlock for spacewalks by two ISS crewmembers using Russian Orlan-M spacesuits.

In addition, the Docking Compartment can transport propellants from the tanks of a docked Progress resupply vehicle to either the Zvezda Service Module Integrated Propulsion System or the Zarya Functional Cargo Block. It can also transfer propellant from Zvezda and/or from Zarya to the propulsion system of Progress. The docking compartment's planned lifetime as part of the station was five years, but significant delay of its permanent replacement: the Multipurpose Laboratory Module (MLM: built from the flight spare of the original Russian FGB module: see section 3.1.11) meant that it had to stay for several additional years. A nearly-identical Docking Compartment, dubbed the Multipurpose Research Module 2 (MRM2), joined the ISS at the Service Module Zenith port in late 2009. MRM2 replaced a cancelled prior concept for a Russian solar array tower called the Science Power Platform (SPP). MRM2 instead created a fourth docking port for Soyuz and Progress vehicles, greatly simplifying the traffic planning at the ISS.

3.1.8 Columbus Laboratory

The European Columbus Laboratory (Figure 18) was launched on the Space Shuttle on 7 February 2008 and successfully attached to the ISS on 11 February. Columbus represents the European Space Agency's largest contribution to the ISS and is a critical piece to bring the ISS research capability to fruition.⁵⁶

⁵⁶ "ISS: Columbus," A. Thirkettle, B. Patti, P. Mitschdoerer, R. Kledzik, E. Gargioli, and D. Brondolo. European Space Agency.



Figure 18. ESA Columbus Research Module

The research laboratory accommodates ten science racks, five of them for European Space Agency use, the other five for NASA use. It is used primarily for research and experimentation in microgravity conditions for:

- Microgravity Sciences, to study processes that are obscured by gravity on Earth, and to test physical theories at levels of accuracy that are impossible on Earth -- again, due to the planet's gravity.
- Fluid Physics, to learn the behavior and properties of fluids in microgravity and develop techniques to improve oil spill recovery techniques, tracking of ground water contaminants, optical lens fabrication, and many other processes.
- Life Sciences, to learn how flora and fauna growth and disease occur in microgravity and to convert what is learned into strategies for dealing with disease and disability on Earth.

The Columbus module also provides four external payload attach sites.

3.1.9 Kibo Japanese Experimental Laboratory

The Japanese Experiment Module (JEM), called Kibo, was Japan's first human space facility and the largest module system on the ISS when completed in mid 2009 (Figure 19). Experiments in Kibo focus on space medicine, biology, Earth observations, material production, biotechnology and communications research. Kibo experiments and systems are operated from

the Mission Control Room at the Space Station Integration and Promotion Center (SSIPC), at Tsukuba Space Center in Ibaraki Prefecture, Japan, just north of Tokyo.

Kibo consists of six components: two research facilities -- the Pressurized Module and Exposed Facility; a Logistics Module attached to each of them; a Remote Manipulator System; and an Inter-Orbit Communication System unit. Kibo also has a scientific airlock through which experiments are transferred and exposed to the external environment of space. The various components of Kibo were assembled in space over the course of three Space Shuttle missions.

1. Pressurized Module: The Pressurized Module (PM) provides a shirt-sleeve environment in which astronauts conduct microgravity experiments. There are a total of 23 racks, including 10 experiment racks, inside the PM providing a power supply, communications, air conditioning, hardware cooling, water control and experiment support functions. As in Columbus, of the ten experiment rack locations in Kibo, 5 are allocated to JAXA and 5 to NASA. The PM is 11.2 meters (36.7 feet) long and 4.4 meters (14.4 feet) in diameter, about the size of a large tour bus. This module was so large (at 15 tons) that it was launched empty and most racks and other equipment were added separately.
2. Exposed Facility: The Exposed Facility (EF) is located outside of the Pressurized Module and is continuously exposed to the space environment. Astronauts exchange experiment payloads or hardware from the Pressurized Module through the unique scientific airlock using the Kibo Remote Manipulator System. Items positioned on the exterior platform focus on Earth observation as well as communication, scientific, engineering and materials science experiments. The EF is a platform that can hold up to 10 experiment payloads at a time and measures 5.6 meters (18.4 feet) wide, 5 meters (16.4 feet) high and 4 meters (13.1 feet) long.



Figure 19. Japanese Kibo Experimental Module and Facilities

3. Experiment Logistics Modules (ELM) (Pressurized and Exposed Sections): The Experiment Logistics Modules, or ELMs, serve as on-orbit storage areas that house materials for experiments, maintenance tools and supplies. The Pressurized Module and the Exposed Facility each have an ELM.
 - a. Pressurized Section: The Experiment Logistics Module - Pressurized Section, or ELM-PS, is a short cylinder attached to the top of the Pressurized Module that can hold eight experiment racks. It measures 4.4 meters (14.4 feet) in diameter and 3.9 meters (12.8 feet) long.
 - b. Exposed Section: The Experiment Logistics Module - Exposed Section, or ELM-ES, is a pallet that can hold three experiment payloads. It measures 4.9 meters (16.1 feet) wide, 2.2 meters (7.2 feet) high and 4.2 meters (13.8 feet) long.
4. Remote Manipulator System: The Remote Manipulator System, or RMS, consists of two robotic arms that support operations on the outside of Kibo. The Main Arm can handle up to 6.4 metric tons (14,000 pounds) of hardware and the Small Fine Arm, when attached to the Main Arm, handles more delicate operations. Each arm has six joints that mimic the movements of a human arm. Astronauts operate the robot arms from a remote computer console inside the Pressurized Module and watch external images from a camera attached to the Main Arm on a television monitor at the RMS console. The arms are specifically used to exchange experiment payloads or hardware located on the Exposed Facility and Experiment Logistics Module - Exposed Section and from inside the Pressurized Module through a scientific airlock, support maintenance tasks of Kibo and handle orbital replacement units. The Main Arm measures 9.9 meters (32.5 feet) long, and the Small Fine Arm measures 1.9 meters (6.2 feet).

3.1.10 Cupola

The Cupola (Figure 20) is a European Space Agency (ESA)-built observatory module of the International Space Station (ISS).⁵⁷ Its purpose is to provide ISS crew members with a direct view of robotic operations and docked spacecraft, as well as an observation point for watching the Earth. The Cupola project was started by NASA and Boeing, but was cancelled as a result of cost cuts early in the ISS design period. After a barter agreement between NASA and ESA, development of the Cupola was later taken over by ESA in 1998. Designed and built by the Italian contractor Alenia, it is approximately 2 meters in diameter and 1.5 meters tall. It has six side windows and a top window, all of which are equipped with shutters to protect them from damage by micrometeoroids and orbital debris. It features a thermal control system, audio, video and MIL-STD-1553 bus interfaces, as well as the connections needed for installing in it one of the two identical robotic workstations that control the Canadarm2. The Cupola was launched aboard STS-130, in February, 2010 along with node 3..

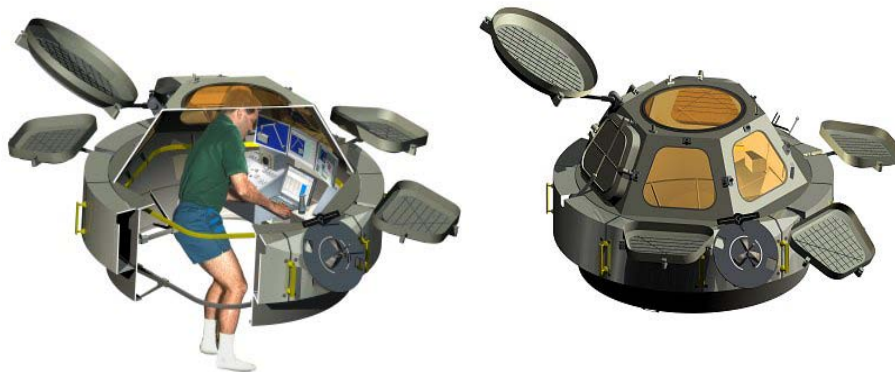

Figure 20. Cupola Observation Modules

Alenia Spazio Cupola Project Manager, Doriana Buffa, says the Cupola, with its seven windows, is very unlike any of the other modules on the Station. Its most important contribution is for making long duration space flights easier on the crew:

“The large viewing windows will provide the astronauts with a view of the Earth quite unlike any other. For long-stay crews this will provide them with an important psychological boost—an umbilical cord connecting the crew on the Station to Mother Earth.”

While not discussed in most systems engineering texts, the ability of the crew to function long term under often stressful situations must be part of the system’s design and part of the system engineering process. This specialty is part of human factors engineering, a recognized area of expertise at NASA’s Johnson Space Center.

3.1.11 Russian Multi-Purpose Laboratory Module

⁵⁷ European Space Agency News, http://www.esa.int/esaCP/SEMHAL0XDYD_Life_0.html

The Russian Multi-purpose Laboratory Module (MLM) (Figure 21) has a long history of starts and stops. It was originally started as a backup to the Zarya module (as the FGB2) and was almost 70% complete when construction was halted. Then it was to be modified and used as the universal docking module, which was later cancelled. The Russians always had plans for a research module (or two) and in 2005 it was decided to convert the existing FGB2 into the MLM. During final design discussions, an agreement was made with ESA to have the European Robotic Arm mated on its surface for a later deployment in space. The production and assembly suffered several delays and its launch on a Proton boost vehicle slipped to 2009.

The MLM is capable of supporting commercial projects to a moderate degree, limited by power and thermal constraints at its shaded nadir position. This commercial payload concept allowed the Russians to outsource off-budget funding including investments to be used to complete and commission the module. For the Russians, more so than other IP partners, the ability to generate revenue has been critical to their continued participation in the ISS.⁵⁸

Following are the requirements set for the FGB 2-based MLM as derived from the input data:

- Provide a port for Soyuz and Progress vehicles and their modifications as well as for research modules to be able to dock in either automatic or manual mode.
- Support propellant transfer from Progress vehicles into the SM and FGB tanks.
- Support the ISS roll control using its own jets.
- Provide room to accommodate European Robotic Arm, provide footprints for external experiments and for a cargo pallet, install probes for stowage and maintenance of EVA payloads.



Figure 21. Russian Multi-Purpose Laboratory Module

⁵⁸ Gunter's Space Page,
http://space.skyrocket.de/index_frame.htm?http://www.skyrocket.de/space/doc_sdat/mlm.htm

3.1.12 Multi-Purpose Logistics Module

The three Multi-Purpose Logistics Modules (MPLMs) (Figure 22), which were built by Alenia-Spazio for the Italian Space Agency, are pressurized modules that serve as the International Space Station's "moving vans," carrying equipment, experiments and supplies to and from the ISS aboard the Space Shuttle. ⁵⁹

The uncrewed, reusable MPLM functions as both a cargo carrier and a temporary Space Station module. Mounted in the Space Shuttle's cargo bay for launch and landing, it is berthed to the ISS using the Shuttle's robotic arm after the Shuttle has docked. While berthed to the ISS, racks and equipment are unloaded from the module and then old racks and equipment may be reloaded to be taken back to Earth.

The Logistics Module is then detached from the Station and positioned back into the Shuttle's cargo bay for the trip home. When in the cargo bay, the module is independent of the Shuttle cabin, and there is no passageway for Shuttle crewmembers to travel from the Shuttle cabin to the module.

In order to function as an attached Station module as well as a cargo transport, the MPLM also includes components that provide air circulation, fire detection and suppression, electrical distribution and computer functions. Ultimately, one of the MPLMs is to be re-named the Permanent Logistics Module (PLM) and will remain on the ISS. Significant upgrades to its debris protection are required for this long-duration stay, unprotected by the orbiter payload bay.



Figure 22. Interior of Italian Multi-Purpose Logistics Modules

⁵⁹ Official NASA information site: http://www.nasa.gov/mission_pages/station/structure/elements/mplm.html

Although built in Italy, the logistics modules are U.S. elements. and were provided in exchange for Italian access to U.S. research time on the Station.

Construction of the Leonardo module began in April 1996 at the Alenia Aerospazio factory in Turin, Italy. Leonardo was delivered to the Kennedy Space Center from Italy in August 1998 by a special Beluga cargo aircraft. Raffaello arrived at Kennedy in August 1999. The third module, named Donatello, was delivered to Kennedy on February 1, 2001.

Each cylindrical module is approximately 21 feet long and 15 feet in diameter, weighing almost 4.5 tons. Each module can carry up to 10 tons of cargo packed into 16 standard Space Station equipment racks. Of the 16 racks the module can carry, five can be furnished with power, data and fluid to support a refrigerator freezer.

One of the MPLM's is being modified to remain on station as a storage module when the Space Shuttle retires.

3.2 Launch Services

A major decision and assumption was that the required launch services would, at least initially, all come from existing vehicles. This meant the ISS was designed with the Shuttle and Russian launch vehicles as critical components for the long-term success of the ISS. This total dependency on these two sources of lift has become a critical issue (see 3.4.5) with the announcement by the United States to retire the Shuttle by 2010 without a direct replacement.



Figure 23. US Shuttle Docked with the ISS

3.2.1 Shuttle

The construction of the ISS was designed to rely upon the Space Shuttle to provide heavy lift and crew transportation—indeed, this was one of the main design criteria for the Space Shuttle. In addition, the Space Shuttle provided regular “house calls” of large teams of short-term, specially-skilled assembly astronauts for each key phase of assembly. While the Russians used their heavy lift Proton rockets, NASA had no plans to use expendable launch vehicles for its (or its partners’) large ISS modules. All NASA and IP hardware were designed to interface with the Space Shuttle payload bay as well as to adhere to the launch requirements (loads etc.) that are more stringent than other vehicles because of its human rating.

The Space Shuttle allowed NASA and its IPs to send up short-term “construction” crews to the ISS to assemble modules and trusses with the full support and flexibility of the Space Shuttle. The Space Shuttle serves as a stand-alone research and assembly support vehicle with significant up-load capability (Figure 23). With the advent of the Shuttle retirement, a key function will be retired without replacement: capability to return large (anything larger than can fit in the Soyuz) payloads to Earth – which also requires changes to the ISS logistics and maintenance strategy. Instead of rotating failed Orbital Replacement Units (ORUs) with spares

stored on the ground, equipment will need to be repaired on-orbit or spares will need to be pre-positioned on-orbit.

3.2.2 New NASA capability

In 2004, NASA was directed by the Administration⁶⁰ to develop not only a replacement for the Space Shuttle, but a family of vehicles that would extend space exploration to the moon and beyond. The replacement for the Space Shuttle became the Ares I rocket and Orion Crew Exploration Vehicle, part of the larger NASA Constellation Program. These were to provide transportation for the crew, but no significant ability to upload or download ISS payloads. With the Space Shuttle able to finish supporting the ISS as currently planned (through completion of assembly), this was not to be an issue.⁶¹ In January 2010 the Obama administration ordered a restructuring of Constellation activities, and a re-definition of the Orion effort to create a US-built lifeboat capability for the ISS, with an option to evolve the spacecraft for later missions. The ARES 1 booster was canceled, and the larger ARES-5 booster is to be redefined. These actions leave the final configuration and capabilities of the Orion-derived capsule to be defined at the time of this case study's publication. Any transport capability of the future will have limited ability to bring up spares. Some orbital replacement units are so large that only the Space Shuttle can deliver them, or replace key components (like solar arrays) if they fail earlier than planned. Furthermore, the lack of Space Shuttle payload capability may also impact the operational life and any recertification activities.

3.2.3 Russian Vehicles

The Russians have played a critical role in providing launch services for the astronauts and for recurring supply missions to the ISS. The early plans were that the Shuttle would supply all of the heavy lifting of key ISS components, supplies and astronauts. While the Shuttle did eventually lift the major ISS elements into orbit, the frequency of flights was never achieved and significant delays occurred after the Columbia accident. In the early years of the ISS program, NASA envisioned a new United States crewed vehicle that would serve as an ISS life raft and crew transfer vehicle. The planned US rescue vehicle was the victim of budget cuts, which placed the Russians in the position of sole provider of rescue services. The Russians launched the Zarya and Zvezda using their proven three-stage Proton rocket. The MLM module is set to launch in December 2011.

⁶⁰ "The Vision for US Space Exploration," NASA Report, February 2004

⁶¹ It is possible that with time and budget, large replacement modules or equipment transfer modules could be designed and launched as the Russians did with their two large modules. However, as of this writing, NASA has no plans to develop this capability or additional ISS components.

3.2.3.1 Russian Soyuz

The initial NASA plan (1990s) was to use the Russian Soyuz vehicle (Figure 24) as an astronaut transfer vehicle and to initially serve as the life raft until the planned US crew rescue vehicle arrived. When this didn't happen the Russians took responsibility for this role full time. The Russian plan was always to transport their crews on the Soyuz and to transport any fulltime ISS crew as needed and as funded by the US. The Soyuz normally remains docked to the Russian module for six months prior to the return of the crew that launched with it. The Soyuz system weighs approximately 14,200 pounds at launch and consists of three major elements. The top part is the roughly spherical pressurized orbital module that can be used for cargo storage and for crew accommodation during missions. This module docks with the ISS. The middle section is the "gumdrop-shaped" re-entry module that returns the crew to earth. It can carry up to three astronauts. After the de-orbit burn to slow the Soyuz, the capsule separates and follows a semi-ballistic path with normal parachute landings on land in Kazakhstan in central Asia. The third, lowest part of the Soyuz is the service module, which contains instrumentation, power and propulsion systems.



Figure 24. Russian Soyuz Manned Vehicle

3.2.3.2 Russian Progress

The Russians were always expected to provide Progress vehicle launches to supply food, water, oxygen and other needed supplies (Figure 25). This proven space vehicle has had a good record of on time deliveries with no problems. The vehicle is normally operated as an expendable vehicle that is allowed to burn up in the atmosphere after de-orbiting. As a derivative of the Soyuz spacecraft, it has the same basic structure but lacks the equipment to allow astronauts to ride inside during launch. During normal operation, it is launched with a full load of new cargo and docked with the ISS. The cargo capacity is much smaller than that of the Space Shuttle, with the size of cargo limited by relatively small hatches through which cargo is transferred to ISS. The Progress vehicle provides a maximum pressurized cargo capability in the 1800 kg range. Prior to the arrival of the next Progress vehicle, it is filled with waste and de-orbited. The Progress is launched with the same Soyuz A2-class booster (also designated in some arenas as the SL-4) that launches the Soyuz capsule. This booster is derived from the same original Korolyov design that launched Sputnik, many Earth-orbiting unmanned research and military craft, and every cargo and crew flight in



Figure 25. Russian Progress Unmanned Cargo Vehicle

support of their human space effort. After over 1000 launches of its different variants, the Soyuz-class booster is unparalleled in the world's space launch systems for reliability.

3.2.4 Japanese Projects

The Japanese have been steadfast investors in the ISS program and have provided significant engineering support. In the launch service arena, they developed the unmanned H-II Transfer Vehicle⁶² (Figure 26), which was initially launched by the Japanese expendable booster, the H-IIB in September 2009. The vehicle provides both pressurized and unpressurized cargo capability in the 5.5 metric ton range.

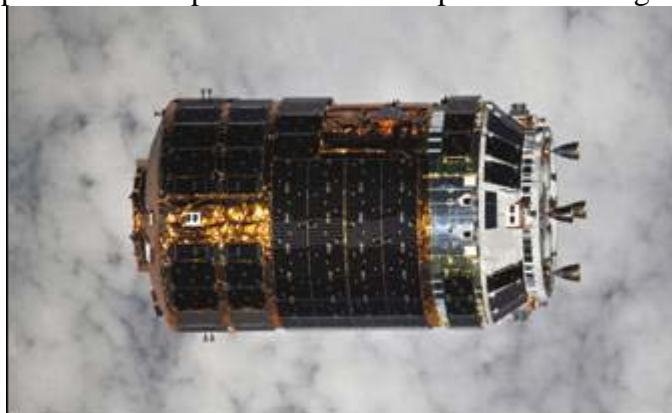

Figure 26. Japanese Unmanned H-II Transfer Vehicle

3.2.5 European Projects

The European ATV (Figure 27) is an expendable, automated cargo transfer vehicle that is launched on the Ariane V expendable rocket. The first ATV (named Jules Verne) successfully completed its first mission to the ISS on June 20, 2008.⁶³ The ATV successfully transferred over 800 kg of fuel to the Russian Zvezda module along with other supplies. The ship also demonstrated its ability to boost the ISS to a higher orbit. The European Space Agency has committed to five vehicles over the 2008-2013 period.⁶⁴



Figure 27. European Unmanned Automated Transfer Vehicle

3.2.6 Commercial Capabilities

NASA would prefer to provide transportation for crew and cargo to the ISS by using US sources to keep the dollars in the US and to encourage US development of such systems. NASA has already invested \$500M to stimulate commercial launch sources to support the ISS after 2010. The investments require the commercial sources to demonstrate various levels of capability that will eventually culminate in their ability to reach and dock with the ISS.

⁶² Statement of Administrator Michael Griffin to the Subcommittee on Space, Aeronautics and Related Sciences, 15 November 2007

⁶³ "Jules Verne Refuels the International Space Station," Science Daily, 20 June 2008.

⁶⁴ Statement of Administrator Michael Griffin to the Subcommittee on Space, Aeronautics and Related Sciences, 15 November 2007

Under the NASA Commercial Orbital Transportation Services (COTS) program, Space Exploration Technologies Corporation (SpaceX) and Orbital Sciences Corporation were selected to develop commercial cargo delivery capabilities for the ISS. Both plan to eventually also offer crew launch and return capabilities.

SpaceX is developing a family of launch vehicles intended to reduce the cost and increase the reliability of access to space. Their design and manufacturing facilities are in Southern California by the Los Angeles Airport. Their propulsion development and structural test facilities are located in central Texas. Their launches will take place from Cape Canaveral, Florida.



Figure 28. US SpaceX Unmanned Cargo Vehicle

The SpaceX Falcon 9 launch vehicle and Dragon spacecraft will be used for cargo, and later crew, delivery to the ISS. Falcon 9 is a 2 stage launch vehicle powered by LOX/RP engines. The first stage is intended to be reusable. The Dragon spacecraft has a flexible cargo and crew configuration and is also recoverable. Pressurized cargo will be transported inside the capsule while unpressurized cargo will be located in an aft “trunk”. The crew configuration will be able to accommodate up to 7 crew members per flight.

The initial test of the full up version of the Falcon successfully placed a qualification unit of the Dragon capsule into earth orbit in the spring of 2010. The first demonstration flight to ISS is scheduled for the third quarter of 2010.

Orbital’s COTS operational systems consists of the Taurus II launch vehicle, the Cygnus advanced maneuvering space vehicle, and all the necessary mission planning and operations facilities and services. Their launches will take place from NASA’s Wallops Flight Facility in Virginia.

The Taurus II is a two stage launch vehicle utilizing LOX/kerosene engines for the first stage and a solid rocket motor for the second stage. The Cygnus visiting vehicle is made up of a service module and interchangeable pressurized and unpressurized cargo modules. The pressurized cargo module is similar to the MPLM developed for the ISS by Alenia, which is a partner with Orbital for the COTS program.

The first demonstration flight to the ISS is scheduled for the second quarter of 2011.

Figure 29. Orbital Sciences Cygnus Unmanned Cargo Vehicle



3.3 Development Challenges

The ISS has been an incredible success story, but has nevertheless had many interesting challenges to overcome. The following are meant to represent a sampling of the engineering challenges and the approaches to solve them.

3.3.1 Technology Readiness and Obsolescence

A major issue with any lengthy aerospace development program is the readiness of the technology chosen. If the designer and systems engineer choose technologies that are already in use, they may become obsolete by the time the system is deployed or during its early life. Choosing cutting edge or unproven technologies also risks delays and cost increases as the technology is matured. During the developmental phase of the ISS, the design underwent a capabilities-based assessment, where along with the fundamental mission capabilities, tasks, attributes and performance metrics, the gaps, shortfalls, redundancies and risk areas were identified and proposed. Many of these solutions required extensive validation of the underlying technology to be used in space. Even though many of the technologies or prototypes were tested on the ground, the effects of microgravity, radiation, and human factors could not easily be reproduced with the desired duration and accuracy.⁶⁵ To minimize this risk, most of the systems that were chosen had already flown on the MIR, Shuttle, and Spacelab or had been developed and tested as part of Space Station Freedom. This approach created a risk of long term obsolescence but reduced the upfront schedule and cost risk. A case in point is the early baseline of the Solar Dynamic (SD) power subsystem that was to supplant the later photovoltaic arrays. The SD power subsystem was highly efficient in comparison to the photovoltaic arrays, but because of high up front development and validation costs, and the known reliability of photovoltaic arrays, the SD system was later abandoned.

NASA has conducted extensive research in this area and helped to create the Technology Readiness Levels, shown in Table 2 below:

Table 2. Technology Readiness Levels

TRL 1 Basic principles observed and reported
TRL 2 Technology concept and/or application formulated
TRL 3 Analytical and experimental critical function and/or characteristic proof-of-concept
TRL 4 Component and/or breadboard validation in laboratory environment
TRL 5 Component and/or breadboard validation in relevant environment
TRL 6 System/subsystem model or prototype demonstration in a relevant environment (ground or space)
TRL 7 System prototype demonstration in a space environment
TRL 8 Actual system completed and “flight qualified” through test and demonstration (ground or space)
TRL 9 Actual system “flight proven” through successful mission operations

The idea is to select a technology for a new system that will reach maturity (TRL 9) at the same time as the deployment of the target system. For most major aerospace programs, the technologies are normally chosen at a TRL 6 or 7 for a new program three or four years in

⁶⁵ “Reduction of Space Exploration Risk—Use of ISS as a Testbed for Enabling Technologies,” by Ilia Rosenberg, Michael Clifford, and Joe Bryant, The Boeing Company, AAI paper.

advance of deployment. In the case of the ISS, some of the systems are not easily upgradeable or replaceable, so care must be taken in choosing the best system or technology that will provide long service but won't represent a schedule or cost risk due to delayed development.

3.3.2 Use of Probabilistic Risk Assessment

NASA uses a variety of standard risk approaches for the ISS, but in particular specifies the Probabilistic Risk Assessment (PRA) procedure that details a structured risk management process for system development. The NASA requirement⁶⁶ states:

Probabilistic Risk Assessment (PRA) is a comprehensive, structured, and logical analysis methodology aimed at identifying and assessing risks in complex technological systems. PRA is generally used for low-probability, high-consequence events for which limited statistical data exist. Its application is targeted at risk environments common within NASA that may involve the compromise of safety, inclusive of the potential loss of life, personal injury, and loss or degradation of high-value property that may be found in NASA mission-related programs.

PRA is a decision support tool to help managers and engineers find design and operation weaknesses in complex space systems. It allows them to systematically uncover and prioritize safety improvements. PRA characterizes risk in terms of three questions called the triplet definition of risk:

1. What can go wrong?
2. How likely is it?
3. What are the consequences?

These simple three questions (often called the Triplet Definition of Risk) are then expanded into a full scope scenario-based PRA process.

1. Objectives Definition
2. System Familiarization
3. Identification of Initiating Events (IEs)
4. Scenario Modeling
5. Failure Modeling
6. Data Collection, Analysis, and Development
7. Quantification and Integration
8. Uncertainty Analysis
9. Sensitivity Analysis
10. Importance Ranking

⁶⁶ NPR 8705.5 Probabilistic Risk Assessment Procedure for NASA Programs and Projects, NASA Office of Safety and Mission Assurance, July 12, 2004

If these structured steps are followed, the key to success or failure is how well management is integrated into the process, along with the subject matter experts, and how that management believes and acts upon the outputs

3.3.3 Russian Contribution and Risk

The decision to invite the Russians to participate was a complicated decision that involved numerous political, operational, financial/schedule and technical considerations.

- From a political viewpoint, the US and USSR had just ended the Cold War (at great expense to both) and the USSR had split into a number of independent nations with Russia as the dominant force. The Soviets (and now Russians) had extensive space experience and technology that might be of value to the new ISS that was being proposed. However, the US and the Russians had limited experience working together (Apollo-Soyuz) to begin a major cooperative effort so soon after the Cold War ended. On top of these major political problems, there were significant cultural issues that would impact the systems engineering challenge.
- Operationally, the Russians had extensive on-orbit experience. The MIR was the state of the art in space station technology at the time. The US had been launching Shuttle missions with many different missions utilizing the Shuttle's cargo bay, but had little recent experience in long-term space habitation or system operation. NASA and its contractors did have designs for new equipment/facilities and some older technology, but significant development and production remained before the US and its original partners would have been operational on orbit.
- Russia was in financial straits following the breakup of the Soviet Union and the space program was not high as a priority for funding. A key driver was the US initiative to retain Soviet aerospace engineers and scientists for work on aerospace projects (particularly ISS). A concern at the time was that unemployed scientists and engineers from this sector could be easily attracted to work for interests not in keeping with long term US security needs if not gainfully employed on ISS. A large infusion of cash was needed. This was the primary reason the US (via NASA) was driven to pay for Russian contributions to the ISS, rather than in kind trades as with all other ISS partners. The inclusion of key Russian station elements offered the chance for NASA to reduce cost and schedule overall. NASA was under pressure to deliver a space station at a reasonable cost, and the Russian modules were already started and most of the systems were flight proven.
- In the initial assessment, the Russian participation should allow the ISS to accelerate or at least meet a shorter schedule that would put elements into orbit by 2000. The Russian modules/systems were flight proven and appeared to offer less cost, schedule, and technical risk in comparison to the challenges of NASA designing and building some critical elements.

While the Russian systems were considered off the shelf, they still presented some risk compared to the NASA SE protocols and system requirements.⁶⁷ As off-the-shelf modules (and thus high TRLs), they had been initially designed for the MIR or its replacement. More important, the Russians had different engineering and system design requirements that did not

⁶⁷ "Russian Compliance with Safety Requirements," GAO/T-NSIAD-00-128, 16 March 2000

always meet the newer ISS requirements. NASA engineers had to issue waivers for the early modules that acknowledged the additional risks and provided future fixes where necessary—such as for MMOD shielding or noise. Russian MMOD vulnerability and acoustic level exceeding requirements were respectively the number 1 and 2 program risks in 2000. Currently, the acoustic levels are no longer on the top list of concerns for ISS.

3.3.4 Spiral Construction Approach and Multi-configuration issues

A major task for the ISS program dated back to the Space Station Freedom effort. The build-up sequence of the Space Station Freedom was problematic and considered high risk by several of the systems engineers of the day. While the total system design was acceptable, the SE process at the time was only beginning to recognize the implications of spiral construction on-orbit. For ISS, spiral construction was the integrated design, configuration and assembly of up to forty elements that had to operate as a fully functioning ISS at each sub-assembly stage. This meant that full operating procedures, software builds, center-of-gravity and station moments of inertia all had to be developed for each configuration. This spiral construction and its multiple interim configurations drove the requirements for detailed Multi-element Integrated Testing (MEIT)—though it was not actually implemented until a few years into the program.

One of the senior systems engineers commented that:

“Systems engineering involved communications, so as you go between divisions, NASA centers and international partners, this makes things more difficult to engineer. Communication bandwidth in these cases is essential. A key is to make interfaces as simple as possible, then simplify further. This is more critical when crossing organizational boundaries. If its crossing government (or country) boundaries and its anything other than structure, it too complicated!”

3.3.5 Computer Hardware and Software

The ISS onboard computing architecture is a mixture of radiation-hardened Intel 386 chip based ISS mission computers for station housekeeping, environmental, and station-keeping duties combined with scores of standardized commercial, off-the-shelf (COTS) notebook computers that the crews can use as interface devices to the more controlled software environment of the systems and payloads, or use “off net” for email, internet protocol telephone, training, and a host of other non-system uses. A conscious effort was made to use COTS products where possible with minimal modifications while complying with safety to reduce cost and risk to the program. The major critical computers provided significant capacity to accommodate future requirements. The entire ISS system was designed as a distributed processing system over major nodes (multiplexors) with each dependent on a major computer system. The standard station-keeping functions were on the ISS computers. The non-critical and experimental support software is configured on the laptops.

The use of laptop computers was not originally a major part of the program. In fact, a local area network for support computers had to be retrofitted to the ISS after launch. Originally, two entire racks of computer interface equipment known as Multi-Purpose Application Consoles were to have been built as the main computing and training interface aboard the ISS, built and programmed from scratch to Mil specs, using ADA and the X-Windows software standard, similar to the systems used in mission control. Beginning in 2003,

special studies were initiated to build upon the lessons of the Space Shuttle program's experience with the Portable General Support Computer (PGSC). The PGSC was used independently of the Shuttle General Purpose Computers, but had rapidly enabled many new capabilities for the crew. These studies led to a host of concepts, including onboard electronic training and procedures, phone services, video uplink, and even command and control. A special safety position paper was drawn up to define the functions in command and control that could be assigned to a criticality-3 off-the-shelf hardware/software system, and those that must be assigned to configuration-controlled software development processes and fault-tolerant hardware. Generally this boiled down to the idea that the COTS system could *display* any data, and could send individual crew commands under an arm/check/fire transmission concept. This prevented the COTS notebook from taking any active role in the automated critical systems processes, but enabled tremendous enhancements to situational awareness and to system debugging and control.

The custom-built shuttle Grid PGSC computer has been recently replaced by COTS IBM Thinkpad computers, with vastly greater power and enough robustness to meet the demands of spaceflight. However, such COTS computers had to be qualified and modified to make them fully safe for operation on the shuttle or ultimately the ISS. The major changes that had to be made included:

1. The laptops had to be modified with fans to handle cooling. In microgravity the warm air generated around the computer circuit board does not move; it tends to stay in place unless forced air ventilation is provided. Once the heat is removed, NASA then has to determine if the ISS or its modules can handle the heat that is rejected. For instance, the Shuttle had a restriction against devices that produced heat greater than 113 degrees Fahrenheit.
2. All internal circuit boards and printed connection areas had to be conformally-coated with dielectric film, to avoid the possibility of small conducting debris floating against the circuits and shorting them out in the 3-phase flows that are typical of zero-G cabin atmospheres.
3. Power adaptors were needed to allow the computers to be plugged in to either module with 28 VDC.
4. The laptop had to function normally in low pressure (10 psia) compared to normal earth pressure of 14.7 psia. (This is more of a constraint onboard the Shuttle than aboard the ISS, whose atmosphere is regulated to sea level pressure at all times: However, for commonality and the many advantages it brings, all notebook computers are certified for either vehicle.)
5. The laptop had to be attached to a stable surface to allow the astronaut to use it without both floating away; Velcro was the common solution.

Obsolescence was mainly a problem with laptop computers with a resulting major configuration question of how to upgrade and how often. Obviously, NASA and its partners could buy new laptops every month to capture the latest technology. The major expense was maintaining back compatibility with data and software along with modifications to make them flight-safe. NASA currently has a replacement cycle that is roughly every four years.

Despite the NASA policy of using COTS hardware and software if possible, there is a cost in making them space-ready. At a minimum, the cost to qualify includes ground testing and safety checks to make sure there are no surprises in orbit.

Even with a multi-billion dollar ISS, the computers are not immune to such mundane threats as computer viruses or hackers.⁶⁸ In August of 2008, the message traffic between ground controllers and the astronauts revealed that some of the computers on board had been infected with a common gaming virus worm that is used to gather information from the infected computer and then transmit it to the remote attacker. In the end, this problem was minor and apparently caused no damage, but ensured virus protection on the ISS computers.

The ISS, its subsystems, and many space-related experiments employ a wide variety of software. When possible, COTS software was used, especially for management or administrative tasks. The laptops are all Windows-based and use the standard Microsoft products along with other more technical off-the-shelf packages. There are specific programs written to control experiments and non-critical equipment that the astronauts use on each flight.

An example of a more sophisticated software application is within the Mobile Servicing System (MSS), which is the system composed of the Canadarm 2 robotic arm that has been critical in the construction and maintenance of the ISS.⁶⁹ The operation of this equipment is safety-critical, so a software approach for “life-critical” operations was chosen. In this case ADA was the language of choice. Some system engineers believe ADA is a “dead language” which was used in the Department of Defense in the late 1970s. However, it is still the language of choice for many system developers for applications requiring safety, low cost maintenance, and near perfect reliability. At the time of Space Station Freedom, ADA was the US space systems required standard, and so was used. ISS system developers stated that:

“The most important safety features that make ADA ideal for development of fail-safe software include its information-hiding capability, its ability to provide re-useable code and its “strong typing”, which helps detect and solve many types of coding errors at compile time, very early in the development cycle.”

While very robust languages like ADA prevent most errors from ever making it to orbit, long term maintenance and changes present significant challenges, especially when considering the integration of the module, control systems and experimental packages. Here the software must be routinely torn down and rebuilt. According to Lehman's laws⁷⁰ of software evolution:

“The functionality of a system must increase continually in order to maintain user satisfaction over its lifecycle. At the same time the software complexity increases unless something is done to reduce it.”

⁶⁸ “Has the First Extraterrestrial (Computer) Virus been discovered on the Space Station,” by Ian O’Neill, Space Reference, Inc. August 26, 2008.

⁶⁹ “Case Study: Space Station Robot Embeds ADA,” Rovert Devar, Ada Core Technologies, COTS Journal, March 2002,

⁷⁰ M.M. Lehman, D.E. Perry, J.F. Ramil, W.M. Turski, and P. Wernick, “Metrics and Laws of Software Evolution - The Nineties View”, In Proceedings of the 4th International Symposium on Software Metrics, Metrics 97, Albuquerque, New Mexico, IEEE Comp. Soc. or. n. PR08093, November 5-7, 1997, pp. 20-32.

Particularly in the preliminary design phases of the complex ISS data management system, a strong typing language like ADA was a huge hindrance to the much-needed rapid prototyping of an enormously complex system. Rapid prototyping's "sloppy", instant-iteration capability might allow cooperating engineers to discover and to work out major architecture and interface problems in an environment that quickly grows progressively more "flight like." The ISS program adopted a formal requirements definition process that led from system architecture requirements to Interface Requirements to Interface Control specifications before a single line of software could be written and explored. Such a plan, while useful up to a manageable complexity level, put a burden on the software and command and control systems engineers to imagine all the intricacies of this multiple-interfaced system, and to capture all necessary interfaces, without a fully-functional test-bed.

Further, particularly in the earliest days of the development, the agency did not have a strong enough background in the advantages and techniques of object-level programming, so most software planning was more reflective of (and appropriate to) the monolithic code that was typical of the Space Shuttle General Purpose Computers or the Mission Control Complex, and not to a system of over two dozen cooperating parallel processors.

A manifestation of the lack of use of true object programming was the persistence of what can be termed "push rod" command and control. Although the grand vision of the software architecture had multiple tiers of higher and higher automation overseeing the low-level sensors and effectors working within an automated process or series of cooperating processes, the natural desire of the ground operators and astronauts was to have ultimate override capability at the effector and sensor level. Thus for every automated application "object", the architects were challenged to provide individual command paths to bypass virtually every function in the object. Sensor and effector objects were originally replicated at every level of the architecture, adding more and more resource requirement to the higher level tiers, instead of less. Thus, all tiers of automation hierarchy reverted to massive "pass through" relays of low-level commands for the operators down to the individual effectors. Automation would come later, and the complex system was thus architected from the bottom up, rather than the top down.

One study⁷¹ considered the challenges to ISS software system engineers of how to respond to design problems discovered during testing and how to incorporate new features into the software design after launch and initial implementation. The study focused on the ISS Operations Control Software (OCS), since it was a good example of a complex software system with extensive testing early on, and then a long maintenance period once the system was deployed. The study considered both cases: constructive fixes early on and adaptive fixes during operations. The study concluded:

1. Lehman's thesis was confirmed: In both maintenance scenarios, the altered designs increased the complexity of the system compared to the original architecture.

⁷¹ "The Space Station Operations Control Software: A Case Study in Architecture Maintenance," Robert Leitch and Eleni Stroulia, Proceedings of the 34th Hawaii International Conference on Sciences, 2001.

2. During maintenance, re-factoring operations helped alleviate the increased complexity introduced by new architectural elements such as hardware and software.
3. Additions as opposed to changes are often more desirable to developers, because they do not risk “breaking” already developed code.
4. Engineers tend to consider implementation cost more than maintenance cost—not necessarily best for long term operation or ISS life cycle cost. This tendency is also a by-product of the U.S. government’s year-to-year funding process which forces decisions early in the system life cycle thus impacting the operational costs.

3.3.6 Power Systems

The power system for the ISS is the largest space based electrical power system (EPS) ever developed and successfully operated.⁷² The EPS was designed as a hybrid 120-volt DC US segment and a 28/120 volt Russian segment. The two systems are independent, but can be interconnected via dc converters. The split system derives from the early decision to use the Russian modules that were essentially off-the-shelf and space proven (low risk). The power flow diagram is shown in Figure 30.

The US segment of the EPS is a channelized, load following (i.e., points at the sun) network of extensive solar photovoltaic arrays, batteries, voltage converters, remote controlled switchgear, and power routing cables.

⁷² “The Electric Power System of the International Space Station—A Platform for Power Technology Development,” Eric Gietl, Edward Gholdston, Bruce Manners, and Rex Delventhal, NASA/TM-2000-210209, June 2000.

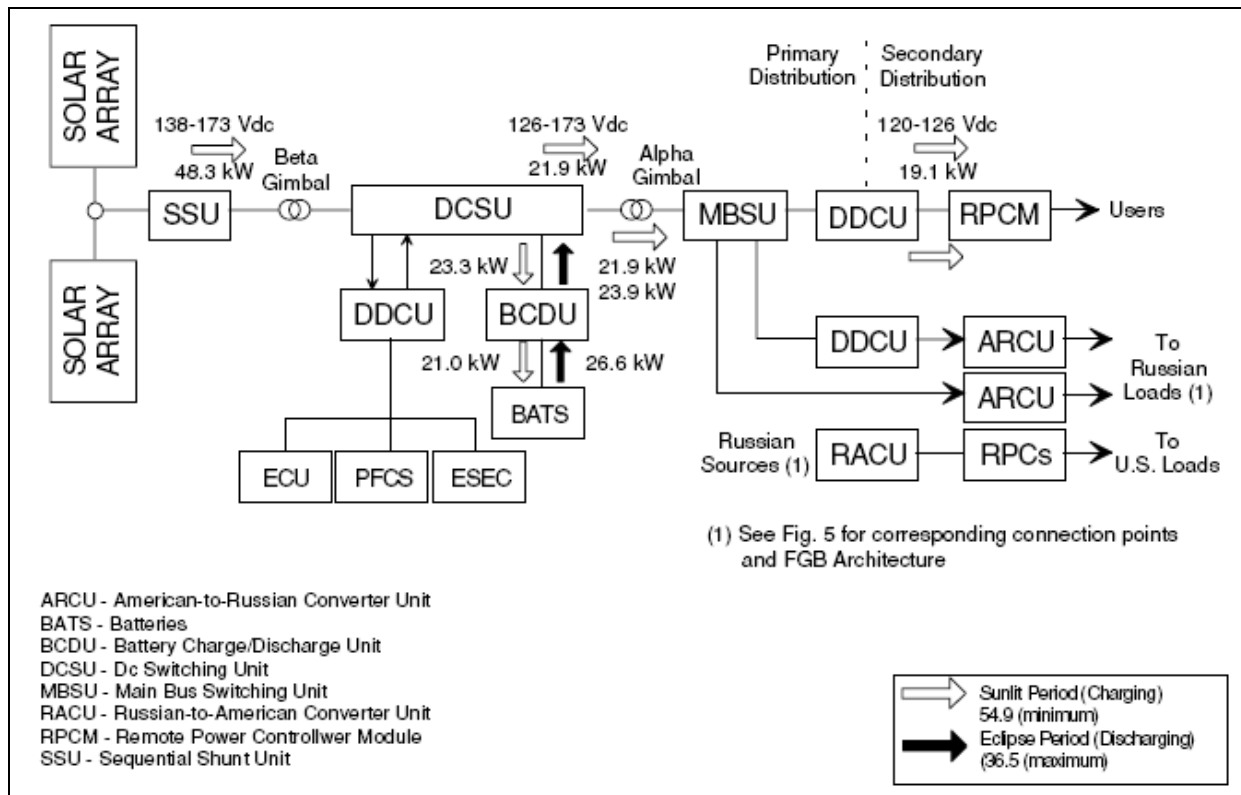

Figure 30. Single Channel Power Flow Diagram

The ISS has eight solar array wings that when fully extended are each 35 meters long by 12 meters wide. The wings are constantly adjusted to maintain an optimal tracking of the sun, simultaneously achieving orbital power balance, minimum depth of battery discharge, and minimized frontal area projected to the ram direction (thus minimizing ISS drag, and saving propellant), while constantly avoiding differential heating of the slender mast longerons, that could lead to very dangerous structural fatigue. Because the station is in and out of the sun approximately every ninety minutes, the ISS contains a large battery set to store the energy during eclipse. The US system uses actively-cooled nickel-hydrogen batteries specifically designed for high (40,000) charge/discharge cycles.

A critical requirement is to constantly track the sun with the arrays and the station to maximize photovoltaic solar cell output. A key part of the system is the solar array rotating joint (SARJ), which rotates the large solar panels. In fall 2007, the ground team noticed unusual vibrations when the starboard SARJ rotated, along with higher than normal current usage. During a scheduled EVA in October 2007, astronauts did a visual inspection and found the exterior to be free of damage—but once they removed covers over the motor and gears, they found metal shavings, indicating either debris left during assembly, or more likely, the gears were chewing themselves up. The initial fix was to lock down the unit and not adjust those solar panels; but long term, this would seriously diminish electrical output—at a time when NASA was hoping to increase electrical production for the upcoming six-person crews. Fortunately, during several 2008 EVAs, the astronauts were able to replace the bearings and other joint parts and thoroughly lubricated the system to make the joint operational.

3.3.7 Micrometeoroid and Orbital Debris (MMOD) Protection

For an aircraft program, engineers typically worry about bird-strikes while in flight or foreign object damage (FOD) that is picked up on the ramps, taxiways and runways. In the case of FOD, prevention is the major emphasis area with some degree of damage tolerance built in to the system. Bird strikes are normally defended against with material strength and engines that can tolerate bird ingestion and allow the aircraft to land safely. For space vehicles, there is a major difference: each piece of micrometeoroid or space debris contains large amounts of kinetic energy as they travel at extremely high velocities:

$$E_k = 1/2mV^2 \text{ where } V \text{ is speed and } m = \rho \frac{4}{3}\pi(\frac{d}{2})^3 \text{ is the particle mass with density } \rho$$

Even small micrometeoroid particles can have densities that range from 7-8 g/cm³ while smaller ones (mainly ice) are 1-2 g/cm³. Typical space debris velocities range from 6-16 km/sec while meteorites can be up to 70 km/sec—thus the high velocity-squared allows even tiny particles to have hazardous energy levels.

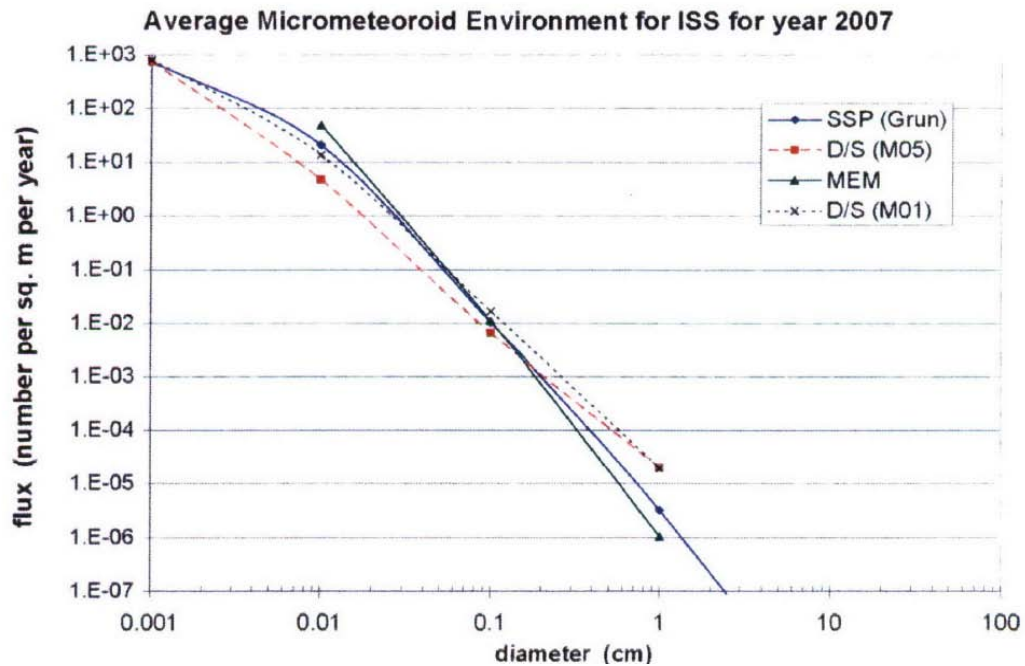

Figure 31. Average Micrometeoroid Environment for ISS

The threat has been characterized in several studies⁷³ and metrics used to measure flux, or the number of micrometeoroid hits per square meter per year on an exposed surface. Obviously with a large station and thousands of meters of exposed surface, this is not a trivial risk. A recent study looked at various models to predict the number of hits and size of the projectiles with some results shown in Figure 31. The models clearly indicate that thousands of small hits probably occur every year and this distribution is a function of orbital path, altitude,

⁷³ “Micrometeoroid and Orbital Debris Environments for the International Space Station,” Glenn Peterson and David K. Lynch, Engineering and Technology Group, The Aerospace Corporation, TR-2008-8570-1, December 15, 2007.

and speed of the satellite or ISS. At the time of this study (December 2007) the authors speculated that:

“The calculations do not include the as yet unknown change in OD particle number and distribution due to the recent Chinese ASAT experiment. Such events are certain to increase the number of orbiting particles. Some people have suggested that a relative small number of explosions in LEO can eventually render LEO space uninhabitable for satellites because one large particle can cause an explosion that leads to further particles that hit more spacecraft until a runaway situation is reached.”

Since that study came out, there has been a major collision in orbit between a dead Russian satellite and US communications satellite.⁷⁴ Both were over 680 kg (1500 lbs) in mass and created a debris field many times larger than the Chinese ASAT experiment, with thousands of new smaller objects going in a multitude of directions. While the collision occurred at an altitude of 790 KM (about 490 miles), which is well above the ISS (normally around 200-240 miles), the debris will all eventually sink to lower orbits and threaten the ISS orbit as the debris speed decays. Large debris from that event was seen re-entering the atmosphere over Texas as early as a week after the collision.

The ISS has several means of protecting itself and crew against impacts with micrometeoroids and orbital debris. First, the ISS can be moved to a different orbit if the ground controllers (with radar) can discover and track a potential threat. The ISS has been moved on occasion to avoid any possibility of collision. NASA and the DOD (plus other countries) already track over 13,000 objects larger than about two inches known to be in orbit.

The ISS has an outer skin and additional protective “curtains” to increase its protective shields. These shields and outer skins are meant to absorb the initial energy of a small strike and have the energy spread out through the protective layer much like a bullet hitting a bullet-proof vest (see 2.3.7.2). An interesting highlight of the high importance of MMOD protection to the ISS program is the fact that the US government allowed the technical export of the “BUMPER” hypersonic ballistic penetration software code to all foreign ISS partners as the de-facto analysis standard to allow technical development of better and better protective strategies. This export was quickly granted, despite the fact that such a code has obvious military benefits.

3.3.8 Test and Integration

3.3.8.1 ISS Multi Element Integrated Testing (MEIT) Program

Testing complex space systems represented a major challenge to NASA and its partners. Many of the modules were developed in different countries and delivered “just in time” for the launch. Each module had to be tested for its own internal operation; then it had to interface with the launch vehicle, and finally it had to work in space while integrated with multiple modules and systems. An early strategy at NASA to save cost was coined as “Ship and Shoot” which implied the modules or systems were delivered as late as possible to the launch site preventing extensive testing, checked for internal operation (but with little or no testing when coupled with other systems or simulators) and then “shot” into orbit where they would be installed. The

⁷⁴ “Satellite Collision Puts Hubble at Risk,” ABC News, Gina Sunsiri, 13 Feb 2009.

factory-level and subsystem checkouts were all that might have been planned or possible. Given this approach, the modules were not originally scheduled to be delivered in time to perform additional testing at the Kennedy Space Center.

By the late 1990s and with the benefit of MIR and Shuttle mission experience, NASA adopted a more integrated approach for testing.⁷⁵ It became apparent that most of the modules and major subsystems would be available prior to launch for some version of integrated testing and limited ground assembly to imitate the final “on-orbit” assembly and operation. This approach allowed for element-to-element interface capability to be tested and verified as well as systems end-to-end operability with hardware and software. To the degree that hardware could be physically connected in its final orbit configuration, it was tested as such. Otherwise, the segments were connected with simulation hardware. Four major test configurations are detailed on the following page and were [Note the truss segment designations: Z for zenith, P for port, and S for starboard. The truss numbers indicate the order from the center.]:

MEIT 1 – US Lab Module, Z1, P6, SSRMS, Node 1 (simulated since it was in orbit)

MEIT 2 – S0/MT/MBS, S1, P1, P3/4, US Lab (simulated since it was now in orbit)

MEIT 3 – JEM, Node 2, US Lab (simulated since it was in orbit)

Node 2 System Test – Node 2, US lab & Node 1 (simulated)

The MEIT 2 set-up is shown in Figures 32 and 33.

The results of this MEIT approach were significant and prevented major problems that would have been discovered only after attempting to assemble and then test the major elements while in orbit.⁷⁶ The MEIT approach for functional verification was a major SE contribution from Boeing based on their lessons learned on their 777 aircraft development program. In particular, Boeing brought the Digital Pre-Assembly (DPA) and Cable Assessment/Fluid Assessment (CA/FA) technologies to bear, which enabled the success of MEIT. DPA ensured verification of element-to-element structural interfaces without interference, while CA/FA ensured that on-orbit assembled fluid and electrical lines would mate properly once installed. Major discoveries on the ground were:

- P6 Truss failed to power up due to Auxiliary Power Converter Unit under voltage trip condition.
- US Lab activation took over 36 hours during on ground first MEIT power up due to significant computer/procedure problems.
- Multiple Command and Control (C&C) computer failures due to task overrun problems. C&C computers failed to perform synchronization with GPS time.
- Incorrect video cable harnesses which would have required difficult EVA in orbit to replace

⁷⁵ “Integrated Testing at KSC between Constellation Systems,” Tim Honeycutt, KSC Constellation Ground Operations Project Office, February 2008.

⁷⁶ “Integrated Testing at KSC between Constellation Systems,” Tim Honeycutt, KSC Constellation Ground Operations Project Office, February 2008.

- Space to ground communication audio was unacceptable and would have required a major on-orbit upgrade and fix.

The net result of these and other discoveries was a chance to fix them while on the ground at significant cost and schedule saving as well as a major risk reduction to the crew and to the future missions.

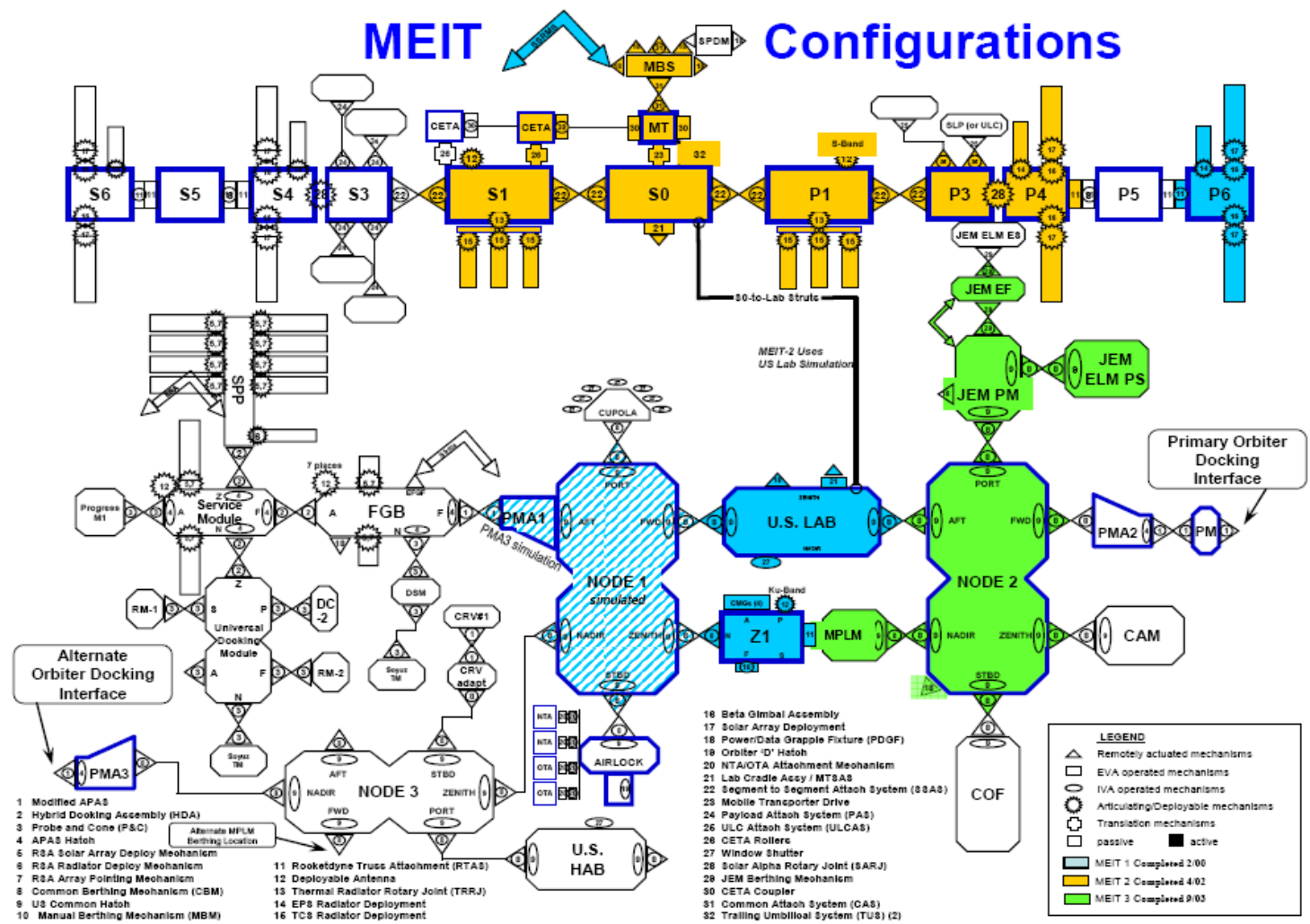

Figure 32. Multi Element Integrated Test Configurations for the ISS

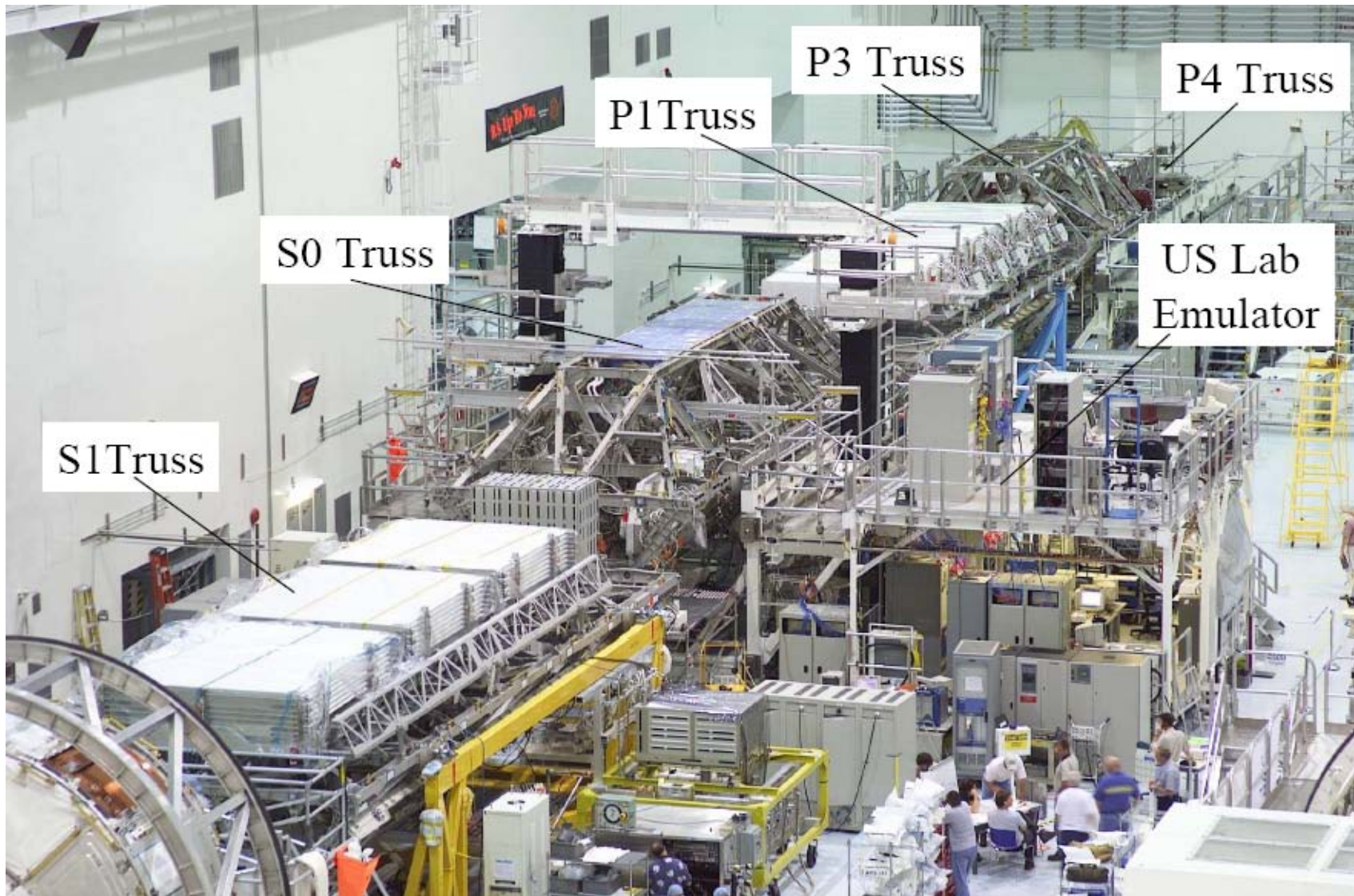

Figure 33. Multi Element Integrated Test 2 Set Up for the ISS

3.3.8.2 Software

The modules, experiments and ISS housekeeping systems all had different base programming languages and were written independent of each other during development with only specified moderately-detailed interface specification. The issues tended to be handled relatively well by the IPT process and the integrations protocols, despite the lack of a full rapid-prototyping simulation area for the integrated software. The bigger issue was the practical requirement for a different and distinct software configuration for each flight configuration. This required a major systems engineering effort to coordinate the exchange of information, followed by the process for testing and assuring that changes were producing the expected results for the new configuration. Such multiple-configuration integration was one of the more important aspects of the program and the system engineering process.

Initially, there were over 4 million lines of code in the ISS command and control system. This code had to accommodate multi-configurations to include active modules for those elements already on orbit and “inactive” software modules for elements that had not yet been delivered. As the new ISS elements arrived, the new code was turned on. The software test and evaluation took place on the ground using a duplicate of the entire ISS system architecture. This large software build has been re-written numerous times in the ISS’s lifespan.

3.4 Execution Issues

3.4.1 Unrealistic Estimates for Cost and Schedule

The ISS has one major area in common with all current NASA development programs—significant schedule and cost overruns. Multiple GAO reports have targeted NASA for these problems (See Figures 34 and 35)⁷⁷. A recent Aerospace Corporation study⁷⁸ looked at a variety of NASA programs and found results typical to those shown below for forty NASA mission projects. The vast majority all overran their budgets. The NASA experience has been to create optimistic schedules with the majority suffering schedule slippage.

Starting with the Space Station Freedom in the 1990s, cost overruns on the space station were a

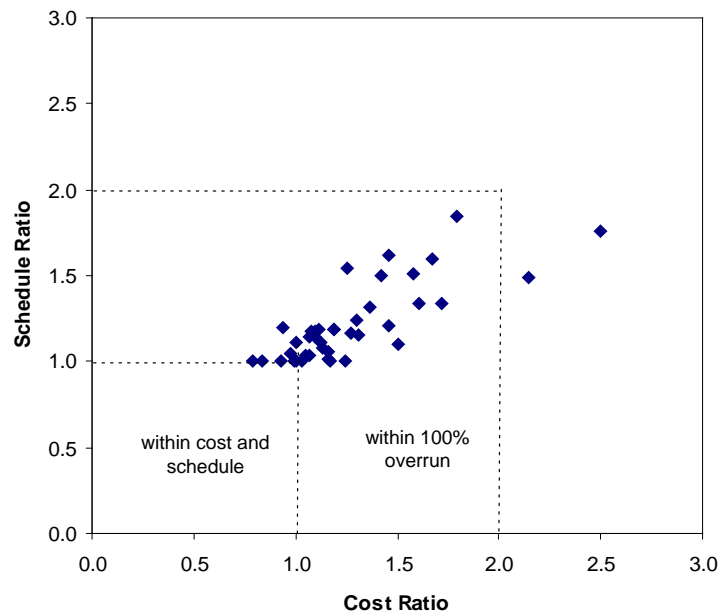

Figure 34. NASA Cost and Schedule Overruns

⁷⁷ “Perspectives on NASA Mission Cost and Schedule Performance Trends,” David Beardon, Presentation at GSFC Symposium, June 3, 2008.

⁷⁸ i.b.i.d

common problem and led to its eventual redesign. Despite excellent progress in technical areas and in integrating its IPs, the program suffered schedule and cost overruns from the very start. By 2001, the problem was getting worse, so a blue-ribbon ISS Management and Cost Evaluation Task Force was created to look at the ISS program and make recommendations.⁷⁹ This panel of senior and very experienced former NASA, government and corporate experts delivered the following findings:

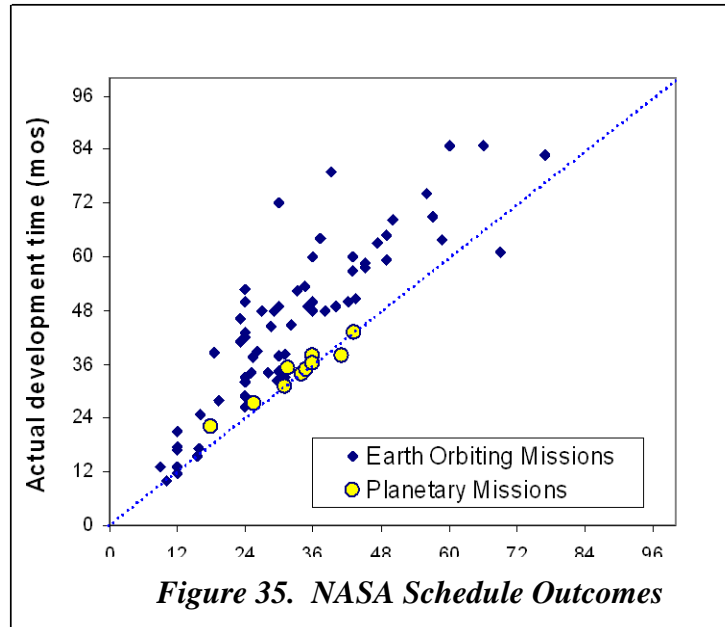

Figure 35. NASA Schedule Outcomes

1. The ISS program plans and budget were not credible. NASA had not and did not have the capability to develop and implement a rigorous ISS cost estimate. It also did not have the capability to track and audit costs in a timely fashion. NASA lacked the basic tools and financial staff to create and track a detailed life cycle cost estimate.
2. The existing estimate at the time (2001) had doubled since program inception and much of the cost and schedule growth was due to poor original estimates, requirements definition, capability creep, and program changes—all traditional reasons for cost growth in large programs. [These issues were exacerbated during the Freedom station design. In particular, the meandering mission scope which included stakeholders for micro-gravity science, Earth observation, satellite servicing, and spacecraft assembly for deep space missions. Such diverse interests drive the system design as well as cost and schedule performance.]
3. The program was being managed as an “institution” rather than a program with specific purpose, focused goals and objectives, and defined milestones. The program budget was paying for a large number of NASA staff and support contractors—a “standing army.” This flat-funding concept by Congress did not match the system’s engineering life cycle and prevented NASA from optimizing the development and construction.
4. The budget from Congress and NASA’s focus on fiscal year management provided no strategic management or focus. The Congress provided level funding, but without multi-year authority to make optimal economic decisions.
5. Lack of a defined program created confusion and inefficiencies. The budget and execution did not match reality and major changes to the program had been made (reductions) without the approval of the IPs.

⁷⁹ “Report by the International Space Station Management and Cost Evaluation Task Force to the NASA Advisory Council,” November 1, 2001

The result of the budget growth and schedule slips has been the construction of a station with less capability than planned and with a completion date that complicates needed support from all partners. After this report was presented, the ISS suffered additional delays as a result of the Columbia accident.

3.4.2 Iran, North Korea, and Syria Nonproliferation Act

The United States uses trade incentives (or bans) as a part of its foreign policy to encourage nations to achieve its national strategies and those of its partners.⁸⁰ One of the issues that the United States has been concerned about is the proliferation of nuclear weapons and of technologies for their development. In the late 1980s, the United States and its partners began an effort to stop the sales of ballistic missile technology under the Missile Technology Control Regime (MTCR).⁸¹ In 1993, Russia joined the ISS partnership and agreed to abide by the MTCR (1995). During this same period, it was perceived that entities under the control of the Russian space Agency began to sell sensitive technology to Iran. In response, Congress passed the Iran Nonproliferation Act (INA)⁸² which banned the US from doing business with entities that support Iran—in this case, it specifically targeted the Russia Space industry and the NASA human spaceflight program. Prior to this, it was estimated that the US had spent \$800M in direct buys of goods and services to support the ISS programs. However, the Iran Non-Proliferation Act (INA) would put a severe limitation to this unless Russia could demonstrate cooperation.

The INA and its actual implementation in terms of ISS had many restrictions, but NASA was still able to move ahead with the ISS program. It did not forbid the completion of any ongoing contracts or agreements. It also allowed for the US (NASA) to purchase service if the crew of the ISS was in “imminent” danger services to maintain the existing Russian service module, and \$14M for Russian docking hardware already under development and production. The Russian partnership agreement requires them to maintain a “lifeboat” at the station at all times with the capability to return three astronauts. Because it carries three, and the Soyuz normally can stay aloft only six months, this implies two launches per year. The US must provide the capability for three more crew once the station is complete (for a total of six). There was also a 1996 “Balance Agreement” to provide 11 Soyuz missions for Russian and American (or other) crew. At this point, the NASA strategy was to have either a US crew rescue vehicle in place or a new space plane. Neither of these happened in the post Columbia environment.

With the new vision of space exploration announced by the administration in 2004, the Space Shuttle is scheduled for retirement in 2010. NASA plans to contract for Soyuz flights

⁸⁰ “The Iran Nonproliferation Act and the International Space Station: Issues and Options,” Sharon Squassoni and Marcia S. Smith. 22 August 2005, Congressional Research Service.

⁸¹ The Missile Technology Control Regime is an informal and voluntary association of countries which share the goals of non-proliferation of unmanned delivery systems capable of delivering weapons of mass destruction, and which seek to coordinate national export licensing efforts aimed at preventing their proliferation. The MTCR was originally established in 1987 by Canada, France, Germany, Italy, Japan, the United Kingdom and the United States. Since that time, the number of MTCR partners has increased to a total of thirty-four countries, all of which have equal standing within the Regime.

⁸² Iran Nonproliferation Act, Public Law 106-178

through 2012 and for limited Progress flights—which should be replaced by European, Japanese or American automated supply vehicles. There remains an issue about what happens after 2012 and until the new US crew vehicle is ready in the 2015-2016 timeframe. Studies are underway for human-rating both commercial and IP launch vehicles that may provide services to ISS; although no decisions have been made to enable US crew access to ISS between 2012 and the availability of the Orion/Ares 1 vehicle.

3.4.3 ISS Logistical Support

Traditional crewed space vehicles have been designed for short term missions with maintenance and logistics a distant second to performance. The ISS challenge is more like designing a naval ship that operates in a hostile environment, but must have periodic maintenance with no chance of visiting a dry dock. The ISS has been in orbit as of this writing over 4000 days with over nine full years of crew habitation. With an expected lifetime of over 15 years (2015 and beyond), space logistics is a major portion of the ISS program and a learning laboratory for future space exploration and engineering.

As discussed previously, the transportation issues alone are complex and made more so by budget constraints and limitations on what can be brought into space. The system engineering challenge for each system and subsystem had to consider initial deployment, assembly and then possible repairs of all or part of a major component. To complicate this, the designers also had to consider spare parts, tools, diagnostic equipment and sensors (both ground and on-orbit) and how to do maintenance without disrupting the ISS operation.

An early discovery on the MIR by the Soviets was the large amount of time spent on station maintenance compared to research. The ISS has been no different. In the five-year time period since initial occupation (2000-2005), astronauts spent over 4000+ hours on ISS preventive and corrective maintenance—not counting how long it took to assemble the station.⁸³ This works out to almost two hours of maintenance per day per astronaut.

One of the challenges to system engineers when designing equipment and systems is determining the mean-time-between-failures (MTBF), which determines maintenance plans and spares inventory. Using traditional “earth” values has resulted in some ISS items far exceeding their MTBFs—which means some of the ISS stored spares are not needed and waste critical space. If the delivered MTBF is too short, then critical systems or services may suffer—such as crew lighting when the bulbs burn out too soon. In most cases, the Orbital Replacement Units (ORUs) were planned for removal and replacement on-orbit, swapped out with spares, and the failed equipment being shipped back to Earth for repair. Given the expected retirement of the Space Shuttle, this strategy for large ORU maintenance has shifted to storage of ORUs on-orbit.

A major problem has been how to deal with subsystems that fail in orbit, but which were not optimized for on-orbit repair or replacement. This can be as simple as lacking the right tool for disassembly or the problem of physically removing an item without cutting a hole in the side of the ISS. The problem manifests itself when items on the exterior break or fail and the only access is through a space walk with limited tools or ability to address the system. The tools

⁸³ “Crew Maintenance Lessons Learned from ISS and Considerations for Future Manned Missions,” Christie Bertels, Senior Operations Engineer, System Engineering Support Services (SESS), Munich Germany at the June 2006 AIAA SpaceOps Conference, Rome Italy.

themselves are an issue if they have to be calibrated or the modules require different tools—such as metric or standard. While there were attempts to standardize equipment, there are still hundreds of different fasteners, washers, etc. that all require their own tools.

Another major issue is the engineering tradeoff between designing in automated health monitoring systems--and sensors that might pinpoint failures to key parts--and how to fix malfunctioning equipment or major components. While useful, this option increases complexity, cost, and weight. One major advantage that the ISS has over other space systems is the human in the loop. On-site astronauts tied in with thousands of ground support engineers have the ability to modify the systems already in place plus innovate as needed with materials on hand.

Mundane issues have often had major impacts in ISS operations. The use of consumable parts limits ISS functionality. A lack of disposable batteries and duct tape can limit repairs or research progress. Items such as filters, carbon dioxide scrubbers, water, cleaners and many other items we take for granted have to be rationed. The design challenge is how to design a system where these are not needed or else minimized.

A last major issue mentioned by several of the past ISS systems engineers is obsolescence and shortened equipment life-spans. Some of the major equipment is not lasting as long as NASA had hoped and the failure of these parts and subsystems is forcing revised decisions about upgrades, replacement and long term repair strategies. The rotating joints that turn the large solar panels have exhibited failures. With the root cause of the joint failure unidentified, the problem has disappeared with the maintenance steps of cleaning up the filings, regreasing the joint, and installing the new array (note: EVAs performed in 2008). Some of the ISS systems continue having problems—such as oxygen generators, the new urine recycling system, and the toilets.

3.4.4 Handling a Major Computer Failure

The importance of the systems engineering process came to light during a major computer disruption that occurred on 14 June, 2007, during the STS-117 mission. In this case, it shed light on the requirements, design, integration and test and evaluation process that had been used during the ISS's early period that resulted in the existing configuration of June 2007.

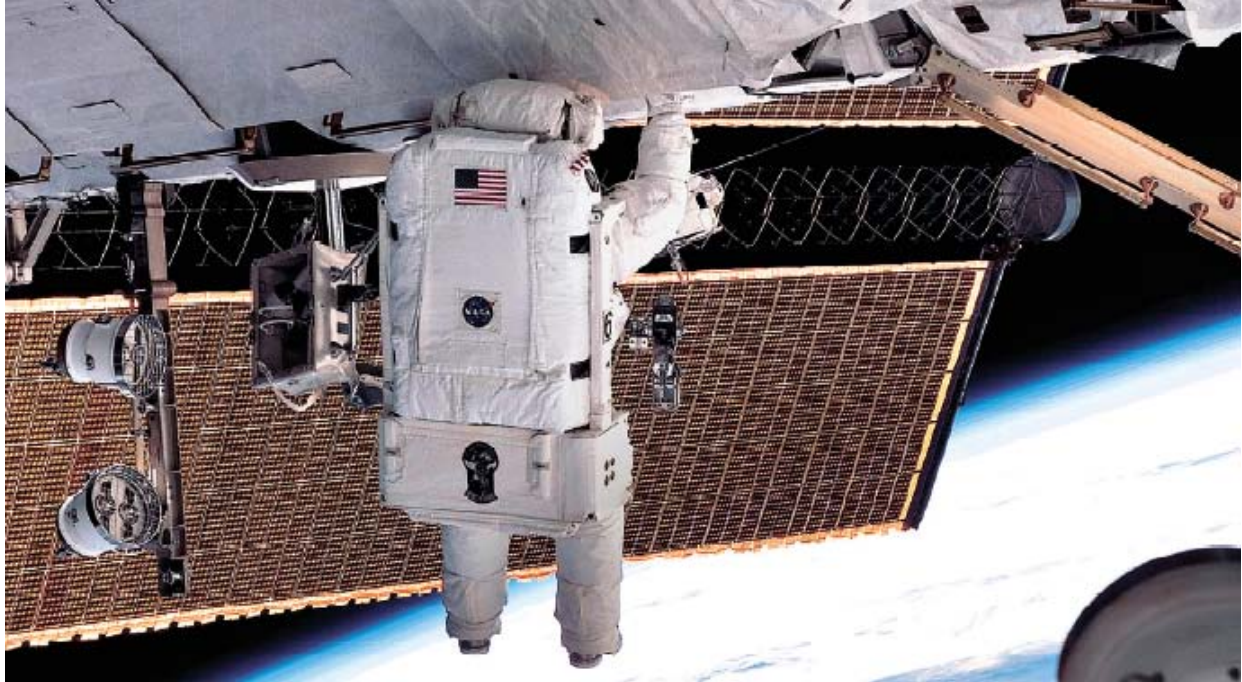

Figure 36. STS-117 Extra-Vehicular Activity at ISS

The major goal of the STS-117 mission to the ISS was to deliver and deploy the last major set of large solar arrays (See Figure 36). Each ISS solar wing contains two 115 foot long panels that attach to a central truss for a total width of almost 240 feet and a weight of 17.5 tons. Unfurling the panels is a slow, tedious procedure that has not always gone as planned. On a previous assembly mission (STS-97), a similar panel failed to deploy properly and had to be repaired during a subsequent space walk. This deployment went smoothly—considering the 120-foot panel had been in storage for several years, compressed into a block only 20-inches deep (see Figure 37). In order to provide a clear field of view for the new panels, an older solar array had to be furled and stowed. Both the new and old panels generate several KWs of power, create large static charges and can generate radio and static noise.⁸⁴

The first hint of trouble came during the deployment when the Russian navigation computer developed some anomalies forcing the ISS crew to switch to the Space Shuttle Atlantis's thrusters along with the ISS US gyroscopes to maintain attitude control. This delayed the initial power up of the solar wings (since the ISS was not initially in optimal position to charge the panels).



Figure 37. Stowed Solar Panel Being Unfolded for Deployment

⁸⁴ "Engineers Close in on Cause of ISS Computer Glitch," Tariq Mailik, Space News. 23 July 2007.

A short time later on 14 July, all six of the command and control computers in the Russian module failed.⁸⁵ The computers controlled the Russian module attitude control thrusters as well as the Elektron oxygen generators and other atmosphere control system equipment. The station did have sufficient oxygen on board for the short run (estimated at 56 days for the basic ISS crew), but this would have long-term impacts if unresolved. To control the station, the ISS used the four US control moment gyroscopes to maintain orientation along with the Space Shuttle Atlantis thrusters. The computers also controlled power to the Soyuz return vehicle (lifeboat) and the external service module cooling loops. The atmospheric control system and carbon dioxide scrubbers were also off line. As a result, the station internal temperature began to rise. After two of the computers were rebooted, this triggered a false alarm for the crew in the middle of a sleep cycle.

The computers were eventually brought back on line by running jumper cables to bypass the computers power monitoring devices. After running tests of all critical systems, the Shuttle Atlantis departed with replacement computers to be delivered on board an unmanned Russian supply ship (Progress). While the fix seemed to work, it was not immediately clear why it worked.

This was not the first command and control computer system failure—in 2001 the mass storage drives on the US side had suffered a failure and had to be replaced.⁸⁶ Again in February 2002, the main computer shut down for several hours before the crew and ground controllers were able to reboot it.⁸⁷ It was however, the first major failure of all three, redundant computer systems. The Russian computers were developed and manufactured by Daimler Benz (German company) almost a decade before. The initial starting point for a solution was to determine what might have triggered the event (root cause analysis). The astronauts had just connected the new truss elements a few minutes before the failure sequence began. Both the Russians and NASA were aware that the ISS electrical properties can change with each new configuration. It was known that the Russian computer system design was sensitive to static noise and voltage spikes – thus the need for a sophisticated power monitoring system. With the addition of a major solar array and the movement of an existing one, it appeared that this was an obvious source of a static or electrical spike that might cause a computer failure. The US modules used a structural ground system while the Russians used a floating ground approach. Adding a major new module or element could cause a potential difference between the Russian ground and the ISS structure.⁸⁸ The basic theory at the time was that the electrically charged plasma field shifted when the ISS's shape changed with the addition of the new truss and solar panels.⁸⁹ Both NASA and the Russian space companies alluded to this as a probable cause—and both proved to be premature and wrong.⁹⁰

⁸⁵ "International Systems Integration on the International Space Station," William H. Gerstenmaier, Ronald L. Ticker, IAC-07-B3-1.01

⁸⁶ NASA International Space Station Status Report #01-13, 9 May 2001

⁸⁷ International Space Station Status Report, #02-07

⁸⁸ "Legacy of the ISS Computer Crisis," Spaceflight Magazine, 2008 January.

⁸⁹ "ISS Computer Woes Concern Europe," Irene Klotz, BBC News, June 2007.

⁹⁰ "Space Station Repairs on Main Computer System Continues," Todd Weiss, Computer World, 15 June 2007.

After the Atlantis left, the ISS crew (Russians Fyodor Yurchikhin and Oleg Kotov and American Clayton Anderson) disassembled the individual systems to troubleshoot possible causes. They suspected the power monitoring system since the bypass around it allowed the computers to work (though it did present a risk to possible voltage spikes). While disassembling the power monitoring systems they discovered connection pins that were corroded and wet. Performing continuity checks, they discovered that one of the main lines had shorted out. More surprising, when they and ground personnel simulated the failure of the lines, they discovered that this created a power off command to all three of the “redundant” processing units—they had a single point failure designed into the system.

A Russian Progress 26P re-supply ship was launched on 2 Aug 2007 to bring supplies and replacement computers (new models built by ESA). On August 8, the Endeavor launched with STS-118 crew to install another major truss segment and to continue work on the computer system. Further investigation by the crew found the source of the corrosion—water condensation. They determined that the units were close to dehumidifiers that mal-functioned, ejecting water vapor on the unit. When the boxes were removed for replacement, their bases were wet and mold was discovered.

The good news for the ISS was that the computers did not have a fatal flaw. The same computer system was built into the European Columbus Laboratory Module that was scheduled to fly later in 2008. They also were on the Automated Transport Vehicle scheduled for 2008 launch. Replacing and or redesigning that system would have been a major problem for both systems.

In retrospect, this incident focused questions on key areas of the systems engineering process:

1. Did the requirements and integration process encompass all needed areas?
 - a. Grounding issues and electrical impacts of configurations changes
 - b. Impacts of humidity on electronics and the adequacy of the environmental control system
 - c. Systems integration between international systems
2. Was the test and evaluation process sufficient?
 - a. How did the German/Russian system contain a single point failure node?
 - b. How are configuration changes modeled, studied and tested?
 - c. Were the computers/electronics properly tested for the ISS environment?

3.4.5 Transportation

Transportation to the ISS is a major part of the system that is equal in importance to the safety and reliability of the ISS itself. The US Skylab experience is a painful reminder that a failure to integrate the schedule, budget and planning of a new system with all critical elements can lead to unwanted outcomes. In the case of Skylab, the system was totally dependent on the old Apollo systems for initial launch and servicing, and then the promised availability of the shuttle for continued operation and support. In hindsight, it appeared questionable why the US would launch a system that could be used for only one year (1973-74), cancel the existing

transportation system (Apollo), and then expect to park it in orbit for at least five years (until late 1978) on the hope that the Space Shuttle would be on schedule and capable of immediately performing maintenance missions. This obviously demonstrates the challenge inherent in US plans to retire the Shuttle in the 2010 timeframe with a known gap in US crew transport to service the ISS.⁹¹ This is a basic systems engineering requirements discussion coupled with budget and politics. However, the benefits of international partnership highlights the fact that even if the US is unable to sustain the ISS, the robust partnership is in place to sustain it.

3.4.5.1 Impacts of launch delays (Columbia failure)

From the beginning of the ISS program, the space shuttle fleet was considered an essential part of the ISS program and critical to its completion. The Space Shuttle (Figure 38) is the only vehicle capable of carrying large payloads of up to 36,000 lbs into low earth orbit. The remaining ISS major modules were designed to be carried on the shuttle. The shuttle also transports the multi-purpose logistics module to the ISS which is loaded with cargo, supplies, experiments and other key life support items. It is removed from the cargo bay and docked with the ISS for unloading. At the end of the mission, it is loaded with trash, waste material and experiments and placed in the shuttle bay for return to earth.



Figure 38. Space Shuttle

Throughout the program, the schedule has always been optimistic and included little slack to accommodate risk. At a very top level, much of the program cost is for the “standing army” of scientists, engineers and technicians that work for NASA, its partners, and its contractors. For the Shuttle this is the large team required to process the vehicle for flight. For the ISS the significant problem is the extended development time that requires maintaining the team at a higher staffing level. As the program slips for a variety of reasons, this “fixed yearly cost” continues and raises the total program cost. Several major government and NASA panels⁹² have studied these issues and recommended major program changes to reduce cost—most of which also reduced the final size or capability of the ISS and the number of shuttle flights.

When the shuttle Columbia was lost in February 2003, NASA grounded all remaining shuttles indefinitely pending the outcome of the accident investigation. This meant a day for day slip in the ISS construction schedule, plus a serious problem on how to logistically support the station and transport astronauts. The Russians already were providing Soyuz and Progress flights carrying six astronauts per year plus cargo. Initially, many options were contemplated, including bringing the Americans home from the ISS. The inventories of food and supplies were carefully updated and tracked closely on orbit and on the ground to determine the feasibility of continuing ISS operations relying solely on Russian capability. A strategy eventually developed

⁹¹ “The Vision for US Space Exploration,” NASA Report, February 2004

⁹² “Report by the International Space Station Management and Cost Evaluation Task Force to the NASA Advisory Council,” NASA Report, 1 Nov 2001.

that reduced the crew aboard ISS from three to two—one Russian and one American—and officially lengthened the Increment duration from approximately 4 months to a standard 6 months to fit the Soyuz rotation schedule. Upon completion of Increment 6, the ISS complement was reduced to two people. This situation was managed as a temporary situation, although it eventually lasted two and a half years.

The grounding of the Shuttle fleet lasted until July of 2005 (almost 30 months) with the launch of the shuttle Discovery. It was then another year (July 2006), before the next shuttle visited the ISS. This caused a number of impacts to the ISS program:⁹³

- The number of Progress vehicles was increased to 3-4 per year to provide logistics support. This required a modification to the exemption of the Iran, North Korea and Syria Nonproliferation Act.
- Shuttle payloads already packed and certified had to be unpacked and the contents safely stored. Some of the contents and equipment had to be serviced, and in some cases replaced due to their time sensitive natures (such as batteries and fluids)
- A solar array awaiting launch had to be unpacked and unfurled and then recertified. Another solar array wing had to be returned to the factory and replaced since it was only allowed to be in storage (tightly packed in its container) for a fixed period of time.
- The single most significant impact was the reduction of crew size for several expeditions from 3 to 2. This was done largely to improve margins on critical logistics.
- Obviously, only limited repairs could be made on the ISS without spare parts or new equipment. Without new research and or maintenance equipment, the ISS crew used the existing resources more—which contributed to higher failure rates. Very limited equipment was flown on Progress and Soyuz.
- A normal part of every shuttle mission was the return of science experiments, especially time sensitive experiments. The Soyuz vehicle had very little space to return payloads; so much of this research was not completed.

While the total cost of the delay may never be known, it was significant. NASA estimated that the following were the major issues they faced that drove cost:

- The 30-month delay before resuming normal flight schedules extended the cost of maintaining the ISS support staff and contractors to finish development
- Numerous requirements to recertify equipment
- Disassembly, reassembly and in some case repair of component parts
- Cost of additional storage
- Cost of maintaining and replacing consumables (especially batteries)
- Storage effects on the solar arrays

⁹³ “Impact of the Grounding of the Shuttle Fleet,: GAO Report GAO-03-1107, September 2003.

- Additional cost of Russia support flights and the cost of travel and working with Russians
- Continued cost of maintaining critical engineering skills on the program for an additional 30-40 months.

3.4.5.2 Russian Soyuz and Progress vehicles

From the start of the ISS program, it was assumed that there would be service and transportation missions consisting of the US Space Shuttle, Soviet expendable vehicles (Soyuz and Progress) along with future systems to be developed. The Russians had extensive experience with their early space stations through the more recent Mir program with launching cargo and cosmonauts. They developed very reliable automated docking capability that allowed them to routinely use unmanned Progress resupply vehicles.

For crewed transportation, the Russians have used their Soyuz systems successfully 16 times carrying 47 astronauts up to the ISS and returning 48 astronauts to Russia. However, recent return missions in the Soyuz have raised some fears about the safety of the Russian system. On 21 October 2007, Soyuz TMA-10 undocked from the ISS for an expected, normal return carrying two cosmonauts and a space flight participant (paying passenger). Normally, the utility module is detached and sent in a safe direction to de-orbit and burn up. The propulsion or instrument assembly module is bolted to the bottom and provides the required de-orbit burn to slow the spacecraft and align it for reentry (See Figure 39). Once on course, the propulsion module's explosive attachment bolts fire and the two are separated. The capsule then begins its reentry in a heat shield down mode where it "skims" along the atmosphere from the lift generated which limits the heat buildup and limits the G-force on the astronauts to a 4.5 G maximum.

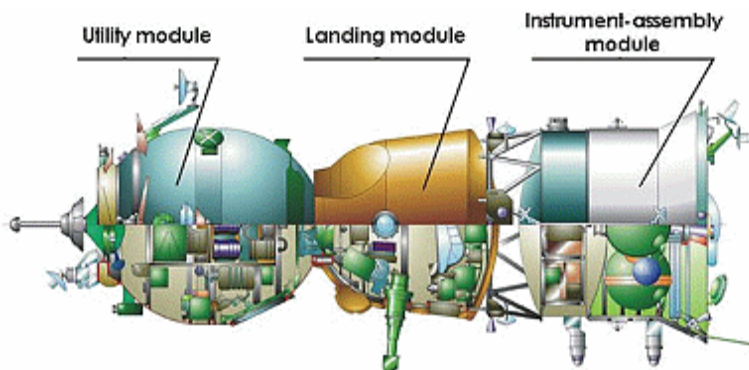

Figure 39. Soyuz Manned Vehicle

In this case, the capsule failed to properly separate from the propulsion module (apparently due to a control cable issue) and was not able to fly the normal trajectory. Instead, after the propulsion module separated, the capsule went into a fail-safe mode and took a steep, ballistic trajectory. This subjected the crew to almost 9 Gs plus generated significant burn damage to the capsule's exterior.



Figure 40. Fire at Scene of Soyuz Capsule Landing

The capsule landed hard, several hundred kilometers off course, and was so hot it started a grass fire around the capsule (see Figure 40). One of the cosmonauts reported later that the grass fire burned quite heavily causing smoke to enter the ventilation system of the capsule (normally opens upon landing) causing the three cosmonauts to switch back to their spacesuit breathing modes.

Six months later (April 2008), a similar incident occurred.⁹⁴ This time Soyuz TMA-11 was returning one American (ISS Commander Peggy Whitson), a Korean and a Russian astronaut when the capsule failed to properly separate. This time the culprit was thought to be faulty explosive separation bolt. Once again, when the normal systems failed, the capsule defaulted to the fail-safe mode and performed a ballistic trajectory subjecting the astronauts to a high G reentry. The Korean astronaut suffered back injuries as a result of the hard landing.

As a result of these two incidents, two Russian cosmonauts on the ISS made a spacewalk in July 2008 to remove one of the explosive bolts from the Soyuz TMA-12 that was docked and planned for an upcoming descent. That Soyuz did successfully return with a near perfect landing in October 2008 with two cosmonauts and an American tourist.

The Progress supply ship has an excellent record with over thirty-seven missions to the ISS. Compared to the Soyuz, it does not have to safely reenter the atmosphere and land—instead it is normally filled with waste and sent on a trajectory to burn up in the atmosphere. NASA has decided to stop using Progress after 2011 in favor of promised US-based commercial launch providers. Several firms are competing for contracts to provide logistics support to the ISS in the post 2010 time frame. (See section 3.2.6)

This policy decision to not spend money on Russian vehicles and instead invest the money in American technology made good domestic public policy sense. However, from a systems engineering risk viewpoint, it must take into account the TRL levels of the replacement systems, the cost, the schedule, the risk and the relevant MTBF of the new systems. As an example, one of the US competitors is Space Exploration Technologies Falcon 1 rocket (See

⁹⁴ “Space Crews Hard Landing Raises Hard Questions,” James Oberg, MSNBC News.

Figure 41). It completed its first successful launch on 28 September 2008 after three previous failures and plans on delivering 1000 kg payloads to low earth orbit for about \$10M.

3.4.5.3 Retirement of the Shuttle

Two key parts of any well-engineered system of systems are that all parts work well with each other (integration and performance) and that the various systems are available when needed. In the case of the ISS and the Shuttle, the Shuttle was always destined to be a key element of the successful construction and station operation.

In later testimony to Congress,⁹⁵ the Administrator explained that the decision to retire the Space Shuttle is basically one of trading off the ISS (and its completion) against future manned spaceflight capability if it requires extending the Shuttle beyond 2010:

“Retirement of the Space Shuttle is on schedule for 2010 and critical to future Exploration plans. As we approach this date, we are hopeful that we can complete the ten remaining Space Station assembly flights, the servicing mission to the Hubble Space Telescope, and the two contingency Shuttle missions to the ISS within this timeframe. If it becomes clear that we will not complete the flight manifest by 2010, NASA will evaluate options and make adjustments consistent with not flying any flights beyond 2010. Continuing to fly the Shuttle beyond 2010 does not enhance U.S. human spaceflight capability, but rather delays the time until a new capability exists and increases the total life cycle cost to bring the new capability on line. . . . Flying the Space Shuttle past 2010 would carry significant risks, particularly to our efforts to build and purchase new transportation systems that are less complex, less expensive to operate, and better suited to serving both ISS utilization and exploration missions to the Moon, Mars, and beyond.”

The decision to retire the shuttle has been controversial. From a systems engineering viewpoint, the decision should consider risk, cost, safety and performance to decide what the best overall approach should be. Further, with a significant downward trend in the economy NASA programs are not at the top of Congressional priorities, and are thus vulnerable, especially when already winding down. Such a budgetary position tends to lead to “status quo” in congressional direction: the sense that NASA should plod on with the existing year’s mode of business until directed otherwise. In this backdrop of political and financial reality, George W. Bush’s vision for NASA in February 2004 required the shutting-down of two existing programs with expensive but functioning infrastructure, with ongoing missions that had been actively cultured as priorities with the American public and with many international partners. Once the “keep on operating” status quo was replaced with a “keep on shutting down, and waiting for the next big thing” status quo, NASA was deeply limited and constrained in its ISS systems

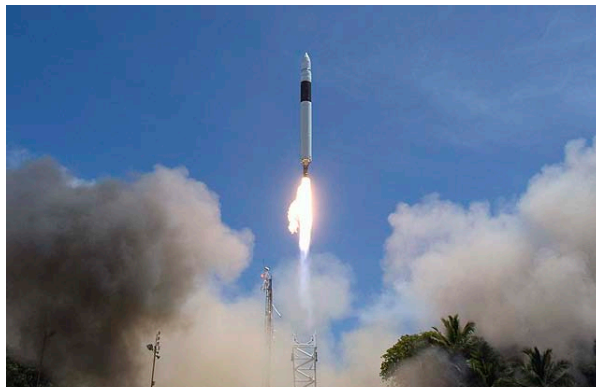

Figure 41. Space Exploration Falcon 1 Rocket

⁹⁵ Statement of Administrator Michael Griffin to the Subcommittee on Space, Aeronautics and Related Sciences, 15 November 2007

engineering options. While the shuttle program's realities were of course more dire than ISS's with their more immediate shut-down, the ISS also faced a highly uncertain and less desirable future than the one for which it had been designed. The entire ISS maintenance strategy had to be re-engineered for a slow obsolescence with no chance of major Shuttle repair flights or ground refurbishment of critical large system components. The logistics and crew rotations would be severely cut back from original plans. Meanwhile, the inevitable delays in the Orion spacecraft have led to a long forecast period of no US launch capability, significantly dulling the accustomed luster of the US Space program on the world stage.

The Shuttle has been the primary transportation for long duration US crew members and for short term US research, construction and visits by US astronauts. If the Shuttle is terminated after 2010, the US will be dependent on the Russians for crew transportation until a domestic capability is ready. Initial analysis done by NASA indicates a gross requirement for sustainment supplies of 80 metric tonnes (MT) between 2010 and 2015. Additionally, the plan is to occupy the ISS with a full time crew of six, with each crew doing six month rotations. Of the six person crew, three would be Russian and three would be from the US, Canada, Europe or Japan. The US has current arrangements with the Russians for crew launches (Soyuz) through 2011 only and for limited Progress flights.⁹⁶

Sustaining the International Partnership

A major question for the US and its partners is how well the international partnership has worked and what may be useful on future cooperative ventures. There is little doubt that the participation by the IPs allowed the program to succeed much more quickly and more successfully than if the US had shouldered the entire program. In fact, the dissimilar redundancy in launch capability ensured the continuation of the program through the Columbia accident down time.

- Despite the different systems engineering environments, the IPs were able to work with the joint SE structure and integrate modules and systems that came from very different development processes.
- It is quite possible that Congress and/or a US President would have cancelled the program had not an IP arrangement occurred to execute the new ISS design.⁹⁷

From our partner's viewpoints, there were some major challenges:⁹⁸

- The Japanese invested heavily in the program early on and met their original schedules only to face months and years of wait times prior to launch and/or on orbit participation.

⁹⁶ As a reference point, in 2005, NASA paid Russia \$43.8M for one seat up to the ISS and one seat down using the Soyuz vehicle.

⁹⁷ In January 1993, the first advice given to the new President Clinton by his Budget Director Leon Panetta was to cancel the Space Station. Lawmakers Guide to Balancing the Federal Budget. June 9, 1992.

⁹⁸ "Foreign Policy in Orbit: The International Space Station," John M. Logsdon, Director, Space Policy Institute, George Washington University's Elliot School of International Affairs.

- The Russians were essentially on schedule to deliver the first module (Functional Cargo Block—FGB) as it was funded by the US. Their next major module, Zvezda, was almost two years late, primarily due to Russian funding issues.
- ESA and CSA have all remained in the program, but like all IPs, their level of financial support has varied and is often a function of domestic politics.

3.4.6 Anomaly Resolution and the Columbia Accident

A major issue that has challenged NASA and other managers of major programs is how to handle technical and or performance anomalies that occur. This has been at the heart of the two Shuttle accidents and at incidents related to the ISS and other NASA programs. This involves the proper identification, reporting, investigation, resolution and documentation for all ISS crew, hardware and software issues. At issue is how to have the full resources of NASA (and the international team) quickly focus on and solve a problem before the ISS and its crew are placed in peril—while at the same time not declaring an emergency with every possible incident and making the operation of the ISS impossible. Following the Columbia accident, NASA reviewed its policies to include anomaly resolution for the ISS.⁹⁹ The main recommendations (October 2003) that affected the ISS were as follows:

- The ISS will provide capability to do external surveys of visiting spacecraft as well as itself. ISS external surveys of itself (to discover damage or maintenance issues) are limited in certain areas without Shuttle support. The ISS and crew since that time have completed surveys and developed procedures for regular inspections.
- The board directed the ISS team to review all of its analytical models that are used to support on-orbit operations, anomaly resolution and decision making processes.
- Evaluate and improve ISS shielding and planning to avoid damage from micrometeoroid or orbital debris damage. This has taken the form of additional shielding, movement of the station and new procedures and equipment to handle possible impact damage.
- The report directed the ISS team to address major nonconformance report issues. The most serious was that the Space Shuttle reaction jet drive system did not have adequate failure tolerance to control against an inadvertent firing when attached to the ISS. This was fixed.
- While not a hardware issue, one of the most important recommendations was a major review and validation of the ISS anomaly resolution process and its work instructions, to assure that proper resources were assigned and processes were begun in a timely manner to deal with anomalies early.

⁹⁹ “NASA’s Implementation Plan for International Space Station Continuing Flight,” October 28, 2003. This was the ISS Program’s response to the Columbia Accident Investigation Board’s Report.

3.4.7 Major Risks to the ISS

As part of the SE process, NASA and its international partners have had to carefully consider all design elements and requirements. A key consideration is the remoteness of the ISS relative to traditional systems and the inability to rapidly provide additional support (i.e., quickly supply spare parts or personnel onsite). The most likely operational safety risks are briefly discussed below along with their demonstrated or planned solutions.

- **Micrometeoroid and Orbital Debris (MMOD) Damage:**¹⁰⁰ There are millions of particles in orbit that range from micro-millimeter sized particles to large pieces of decaying spacecraft. While most large pieces are tracked, there is always a probability of impact. For the larger tracked items, the ISS can be moved given enough warning. The ISS is designed with a level of protection in its outer skin for most modules. MMOD debris panels have been added to protect the Russian modules and the living quarters. There is also the danger of impact during extravehicular activities, as the space suits have a lesser level of protection. The probabilities of MMOD impacts have been studied to show how safety is improved with service module augmentations in place and additional Russian Progress and Soyuz enhancements:

Table 3. Probability of Penetration Damage to the ISS

	Existing ISS Design	With Service Module Augmentations in Place	With Service Module Augmentations plus Progress and Soyuz Enhancements
No Penetration	45%	54%	71%
Isolate the Penetrated Element	19%	16%	11%
Penetration Leading to ISS Abandonment	18%	14%	8%
Repairable Penetration	9%	8%	5%
Penetration Leading to Loss of ISS and/or crew	9%	8%	5%

As the table indicates,¹⁰¹ there is a very good chance that the ISS will sustain some level of appreciable damage during its lifetime.

¹⁰⁰ A further discussion on micrometeorite and orbital debris protection is at 3.3.7.

¹⁰¹ SM stands for service module

- Collision with vehicles or remote manipulator systems: The MIR program demonstrated that collisions between the various vehicles and the ISS are a real possibility.¹⁰² A major engineering challenge of the ISS was how to unload cargo and personnel from arriving space vehicles and how to move the new or old module around for installation. Arriving vehicles all have a combination of automated and manual docking interfaces and procedures. These vehicles use a three-tiered approach to ensure safety:
 1. The vehicles must have at least a two-failure tolerant approach against catastrophic outcomes. The system must have onboard fault detection, isolation and reconfiguration capability plus the ability to self monitor all critical functions. It must have an independent collision avoidance maneuver function. There must be a manual ground and crew monitoring capability to follow progress and react to out of tolerance situations. It must have robustness against failed capture capabilities.
 2. The second level of protection requires that the ground station be able to monitor all aspects of the activity with the ability to abort while the ISS crew must be able to monitor and take evasive actions.
 3. The third level of protection requires the new systems to demonstrate key capabilities during their first flight while maintaining a safe distance from the ISS prior to an actual attempted docking.
- There is also a risk of damage from any of the space station's robotic arms. In some case, there are definite limits to their movement that prevent damage. However, most have to have the ability to reach most areas of the ISS to be useful. The key approaches to safety for these operations center on two-fault tolerant designs, extensive crew training, monitoring by the crew and the ground support and careful mission design and simulation.
- Fire: This is a major hazard and the primary safety approach is prevention. In the early design phase, the engineers carefully selected fire-safe materials and mechanical/electrical designs with low probability of fire creation. There is also extensive fire detection (smoke and heat alarms) throughout the ISS to provide quick warning of any dangerous situations. The ISS system was designed to identify the fire site, isolate the area (remove power, ventilation and oxygen), and extinguish the source without damaging the station or endangering the crew. The physics of a fire in space make this a very unlikely but still dangerous possibility. A chronic problem early in the program was that the very sensitive smoke detectors (particularly those in the FGB) would too often alarm ground operators and crew at nuisance levels. Although there have been dozens of alarms, not a single actual fire has occurred onboard. The ISS is also equipped with hand-held fire extinguishers and the crew is trained in their use.

¹⁰² The MIR was hit on at least two separate occasions, once with a Progress transfer vehicle and another with a Soyuz. The Progress accident caused a module to depressurize.

- Toxic Spills: The main means of preventing toxic spills is by not bringing toxic materials on board or containing them in spill-proof devices. When toxic items are allowed, the crew follows strict procedures for using the items and conducting the experiments or procedures. The crew has well-practiced procedures for cleaning spills in microgravity and has access to full protective gear if needed.¹⁰³
- Catastrophic system failure: This type of failure and its prevention permeate the SE approach to the ISS. At each stage of review, methods for reducing this risk are considered—redundancy, sound design specification, rigorous testing, and risk assessment. After the Columbia accident, the ISS management team took the opportunity to focus on the ISS to see if any significant risk remained. If found, these are documented in noncompliance reports (NCR). The only significant NCR remaining at this time dealt with the shuttle reaction jet driver (RJD) and primary jet thrusters. The danger was that they might inadvertently fire and damage the ISS. NASA quickly studied the issue and dictated no fire zones during certain key operations, performing avionics checks prior to system activation, and performing each flight’s first-time Shuttle equipment power-up before Shuttle docking to the ISS.
- Extravehicular Activity (EVA): This is primarily the safety of the astronauts, their equipment and the contamination of their equipment and danger of damaging the exterior of the ISS. The most important preventative measure has been the extensive planning and practice of the EVAs. Each EVA has been rehearsed underwater (when possible) for hundreds of hours prior to the missions to ensure the astronauts understand the repair, have the right tools, and have the EVAs orchestrated properly using the robotic arms if needed. There is also an intra-vehicular crew member always coordinating with the EVA crew. The biggest danger to date has been a concern about damaging the suits. This can happen due to a rip or tear, chemical exposure or contamination or puncture by a meteorite or orbital debris. The suits are a compromise between flexibility and impact protection. The current EVA requirement for MMOD is to meet a probability of no penetration of 91% against two member performing 2700 hours of EVAs. Current analysis puts the actual probability at 94%. So far, there has been no evidence of a MMOD impact to any of the EVA suits.
- There is a danger of contamination from ISS materials and lubricants. On a recent mission (18 November 2008) an astronaut was preparing to repair and lubricate one of the solar array joints.¹⁰⁴ In a pre-packed tool kit, the astronaut opened the bag and discovered one of the grease cartridges for the grease gun had “exploded,” contaminating everything in the bag—along with the astronaut’s

¹⁰³ On 19 Sept 2006, the first ever “emergency” was declared on the ISS when a Russian oxygen generator (Elekton) malfunctioned and began to overheat. It caused an o-ring to overheat and smoke, which allowed some potassium hydroxide to leak. The three astronauts quickly donned protective gas masks and implemented their emergency procedures to isolate the module and the spill. They cleaned up the spill with towels and used special carbon filters to scrub the air. Within a few hours, the station air was clean again and the situation was over. (*Associated Press Report, Seth Borenstein, 19 Sept 2006*)

¹⁰⁴ “Engineers Study Options for Replacing Lost Grease guns,” William Harwood, CBS News, 18 Nov 2008

gloves and sleeves. The cleanup method was to basically wipe up the grease with towels and store the dirty towel and most of the grease in plastic pouches. In this case, the problem is more than just a minor mess; the remaining grease on the space suit can contaminate the airlock, the space station interior and exterior—to include sensors and exterior experiment payloads.

- **Errant Commands or Security Compromises:** The ISS by design shares a great deal of control with the ground stations. There is always a danger of an outside source compromising the security and sending false commands. The ISS design and operation meet all NASA and National Security Agency (NSA) requirements. The systems are tested and challenged regularly to maintain system security. There is also a risk of an inadvertent critical command from NASA. Commands that could cause catastrophic damage are required to be two-stage commands—a separate “arm” and then “fire.” Additionally, these types of commands are automatically safed and require approval by Mission Control Center personnel at Houston and must also be approved by the mission flight director. There is also software protection on other critical commands that query the crew with “are you sure” messages that must be acknowledged. NASA reports that each year, over 100,000 commands are sent to the station with a command accuracy exceeding 99.95%.

3.5 Long Term Outlook

The long-term challenges for the ISS are more financial and political in nature than systems engineering problems. The United States, like its IPs, is facing economic pressures during a down economy while trying to develop a new crewed launch system (see Figure 42) and a new exploration program to the moon and beyond (dubbed the Constellation Program). As discussed earlier, the US decision to retire the shuttle has had major impacts on the ISS completion and operation. The US has also discussed possible retirement dates for the ISS and what that would mean to its partners. Many of the partners invested and developed their modules with the plan of a long station life on orbit. Many, including the Russians, are even considering possible new additions to the ISS for research.¹⁰⁵ The possibility of an early shut down of the ISS would have negative impacts on future cooperative efforts.

In May 2009 the station's crew was expanded from three to six astronauts, A record 39 Russian space launches were planned for 2009, as opposed to 27 in 2008 (not all to ISS, but an indicator of the robustness of the Russian program, even in light of the world's financial crisis).

While the Constellation Program competes for budget with the legacy ISS program, it also may become the biggest supporter and benefactor of the ISS.¹⁰⁶ During the development phase of the new program, it will have to do a capabilities-based assessment of planned technologies. Many of these new or modified technologies will be needed for long duration space missions and will require extensive validation. While some tests are quite feasible on the

¹⁰⁵ “The Role of Space Stations in Russia’s Long Term Exploration Strategy,” Valery Borisov and Andrey Golovinken, IBC Workshop, Berlin, November 17, 2006.

¹⁰⁶ “Reduction of Space Exploration Risk—Use of ISS as a Test Bed for Enabling Technologies,” Ilia Rosenberg, Michael Clifford, and Joy Bryant, The Boeing Company, AIAA conference paper.

ground, the best method is to test them in the environment in which they will operate—outer space. The ISS as a test bed for space exploration is the best tool to evaluate the acceptable tradeoff between new technology, manufacturing maturity and applicability for long duration spaceflights.

Despite political and financial challenges, there are some indications that the ISS may already be suffering premature aging issues that could shorten its lifespan. In January 2009,¹⁰⁷ ISS rockets were commanded to fire to move the station into a higher orbit as part of routine station-keeping. An incorrect delay filter was loaded for the “off pulsing” delta-V burn, allowing the jet pulses to hit a resonance with fundamental ISS structural modes. The jet firing filter is designed to prevent just such an occurrence, and the resonant excitation had the potential to severely limit the fatigue life of the ISS, which diminishes roughly as the fourth power of the magnitude of the applied load. This load reached previously unexpected levels during the incident. Onboard video confirmed that the station shook severely—much like a ship in a violent storm. The vibration episode was severe enough that the three astronauts notified mission control and ground engineers did a full check of the station’s systems. While nothing was found to be wrong, ground controllers delayed additional thruster burns for two months to give them time to recheck the systems. NASA Space Station program manager Mike Suffredini noted that while this event appears not to have harmed the station, its total lifetime has been shortened due to extra stress on its components over the years.

¹⁰⁷ “Nasa Delays Shuttle Launch, Space Station’s Relocation,” Traci Watson, USA Today, February 4, 2009.



Figure 42. Orion Visiting the ISS

4.0 SUMMARY

4.1 Summary

The International Space Station definitely has been the most complex NASA systems engineering program to date. Despite the enormous challenge of dealing with International Partners, multiple configurations and a dynamic political environment, the ISS is close to completing its final configuration and becoming fully operational. A major element of its success has been the program management and effective systems engineering process that NASA has developed and executed over the last three decades.

The success of the ISS traces back to the original decisions to use much of the demonstrated technologies from the Skylab, Space Station Freedom, Shuttle missions and eventually, the Russian contributions that were proven onboard MIR and its predecessors. While many of the systems were updated, it was done in an evolutionary manner that reduced system

risk, reduced cost and minimized schedule risk. Another major part of the success was the team effort to develop advanced element-to-element physical and functional verification methods for interfaces assembled on-orbit. While this was also applied at the sub-system level, this helped to discover and quickly fix many system problems that would have been very difficult, if not impossible to fix once on orbit. Finally, NASA and its partners developed an excellent systems engineering approach to handle the 40+ on-orbit configurations that placed demanding requirements on unique software, hardware and operational requirements every time the ISS was upgraded with the next component or modules. Such evolutionary performance is atypical of almost every other complex electromechanical system, and its complexity is compounded by the additional strict requirements of human-rated space hardware.

NASA and its partners also had problems that the system engineering approach had to either deal with or work around. The biggest issue was program uncertainty from all the countries as budgets were adjusted or eliminated during the life of the program. The current plan for the Shuttle retirement and the uncertain lifespan of the ISS (prior to decommissioning) remains a major issue for the ISS partners.

4.2 Lessons Learned

We interviewed experts and asked what they felt were the most important lessons learned for NASA systems engineers. While there were a variety of responses, those responses tended to repeat the same core topics discussed below:

- Sometimes difficult topics need to be finessed with the use of less-than-precise language. While open to interpretation or requiring future interpretation, such constructive ambiguity allows negotiators to move beyond an impasse.¹⁰⁸
- Don't be so ready to chase revolutionary designs over evolutionary designs. A key lesson from Russian experience (such as the Soyuz) is that it is often less risky to stay with a known design and provide minor improvements.
- Multi-Element Integrated Testing with actual hardware, high fidelity simulators and connectors is critical and must be in the program from day one.
- Systems engineering involves communications, critical to international partnerships, so before worrying about technical interfaces, make sure the integrated product teams and communication bandwidth between partners are optimal. This fundamentally includes face-to-face meetings, so regular international travel is a large and essential part of the systems engineering cost.
- In an ISS like project where so many different countries and companies contribute hardware and software, the interfaces must be extremely simple.
- Maintaining a high level of competent and experienced personnel over a two decade long program requires strategic level planning and execution of workforce planning. Despite budget realities, cyclical hiring and layoffs due to budget minimized workforce competence.
- Don't be too quick to allow partners (or NASA) to start building modules or expensive experiments too far in advance of locking in schedule and program baseline.¹⁰⁹

¹⁰⁸ "Structuring Future International Cooperation: Learning from the ISS," L. Cline, P. Finarelli, G. Gibbs, I. Pryke,

- Conversely, physically simple models are important, especially in the early systems engineering phase. These should be budgeted for and provided on a continuing basis. A simple turned-wood model can be produced overnight to illustrate most of the complex geometries of a typical spacecraft, and such a model definitely beats using lay-around objects such as pencils and salt shakers to imitate construction or rendezvous details. Generally, appropriate crude models were scarce, with the Program waiting for the next design iteration before commissioning an official one-of-a-kind public relations model. Such lower-fidelity models were most needed by the engineers *during* the process to get to that next iteration. Some of the most rapid gains in the US integration with Russian partners occurred with crude models cut from cardboard and wood during breaks between meetings. (One team even built a full-scale cardboard mockup of a key US-Russian interface along their meeting table during a week-long meeting, and filled in many interface control details using a tape measure against the model).

¹⁰⁹ This is not unique to the ISS. NASA previously built a back-up Skylab that was not used and today hangs in the Smithsonian as one of the most expensive exhibits. The Russian Multi-Purpose Logistic Module is another example of major hardware that was started, then stopped, then started again and finally launched into space.

APPENDICES

APPENDIX 1. AUTHOR BIOGRAPHIES

DR. WILLIAM K. STOCKMAN, LT. COL, USAF (RET)

Dr. William Stockman is currently a Senior Associate at Dayton Aerospace, Inc. and an Adjunct Professor at the Air Force Institute of Technology. He has 30 years experience in the areas of engineering, acquisition management and strategy, economics, cost estimating, graduate and undergraduate education, and acquisition research. He authored two recent AFIT case studies, JASSM and Peacekeeper.



Lt. Colonel Stockman retired from the USAF in 2002 as Deputy Department Head and Graduate Cost Degree Chairman, Department of Systems and Engineering Management, Air Force Institute of Technology, WPAFB, OH. Prior to that, he held positions as Executive Secretary and lead analyst at the OSD CAIG, Mathematics Instructor at the US Air Force Academy, Director of Depot Maintenance Cost Analysis for the Assistant Secretary of the Air Force and a Propulsion Engineer at the Air Force Rocket Propulsion Laboratory, Edwards AFB, CA.

Dr. Stockman received a BS in Mathematics and a BS in Business Administration in 1977 from Southeast Missouri University, a BS in Aeronautical Engineering in 1984 from AFIT, a MS in Engineering Management in 1986 from West Coast University, an MS in Operations Research in 1988 from AFIT, an MA in Economics in 1995 from George Mason University and a PhD in Economics in 1996 from George Mason University.

JOSEPH F. BOYLE, COL, USAF (RET)

Joseph Boyle is a seasoned program manager, researcher, space professional and engineer with 28 years hands-on experience successfully managing and guiding hardware and software intensive development, production and support programs—in the USAF, Joint, and International arenas. He served as Deputy System Program Director for the Evolved Expendable Launch Vehicle. He has assisted numerous industry and government organizations structuring complex program execution plans.



Mr. Boyle received a BS in Mechanical Engineering from Norwich University and a MS, in Systems Management from the University of Southern California. He also is a graduate of the DOD Program Manager's Course from the Defense Systems Management College and from the USAF Air Command and Staff College.

John B. Bacon, Ph.D.

Dr. Bacon is currently a systems analyst working on numerous integration assignments affecting the International Space Station, within the ISS Program Integration office at the NASA Johnson Space Center in Houston. A veteran NASA engineer since 1990, he has worked in all aspects of ISS technology and systems, and with all the ISS international partners. A graduate of

Caltech (B.S. '76) and of the University of Rochester (MS '78, Ph.D. '84) his extensive career prior to NASA includes roles in the development of many cutting edge technologies, including controlled thermonuclear fusion, the development of the electronic office, factory automation, and the globalization of business. He pioneered the deployment of several artificial intelligence systems.

He was the United States' lead systems integrator of the Zarya--the jointly-built spacecraft that forms the central bridge and adapter between all US and Russian technologies on the Space Station. This landmark in technological history was built in Moscow by American and Russian engineers and launched from the Baikonur Cosmodrome in November 1998.

Among his numerous awards, he is a recipient of NASA's Exceptional Achievement Medal, the Director's Special Commendation, and the coveted Silver Snoopy award--the only award to fly in space. He routinely advises numerous academic programs and institutions, and he is a champion of education throughout the world.

APPENDIX 2. ACRONYMS

1P Progress flight ¹¹⁰	CMS Countermeasures System
1S Soyuz flight	CNES Centre National D'Études Spatiales [French space agency]
AC Assembly Complete	COF Columbus Orbital Facility
ACU Arm Control Unit	COL-CC Columbus Control Centre
ARC Ames Research Center	COTS Commercial Orbital Transportation Services
ARIS Active Rack Isolation System	CPDS Charged Particle Directional Spectrometer
ATCS Active Thermal Control System	CRPCM Canadian Remote Power Controller Module
atm Atmospheres	CSA Canadian Space Agency
ATV Automated Transfer Vehicle, launched by Ariane [ESA]	CTB Cargo Transfer Bag
ATV-CC Automated Transfer VehicleControl Centre	CWC Contingency Water Container
BCA Battery Charging Assembly	DC Docking Compartment; Direct Current
BCDU Battery Charge Discharge Unit	DCSU Direct Current Switching Unit
BSA Battery Stowage Assembly	DDCU DC-to-DC Converter Unit
CBM Common Berthing Mechanism	DDT&E Design, Development, Test, and Evaluation
CC Control Center	DLR German Aerospace Center
CCAA Common Cabin Air Assembly	DMS Data Management System
CCC Contaminant Control Cartridge	DOS Long-Duration Orbital Station [Russian]
CDRA Carbon Dioxide Removal Assembly	EADS European Aeronautic Defence and Space Company
CETA Crew and Equipment TranslationAid/Assembly	ECLSS Environmental Control and Life Support System
CEV Crew Exploration Vehicle	ECS Exercise Countermeasures System
CEVIS Cycle Ergometer with Vibration Isolation System	ECU Electronics Control Unit
CHeCS Crew Health Care System	EDR European Drawer Rack
CMG Control Moment Gyroscope	EDV Water Storage Container [Russian]
CMRS Crew Medical Restraint System	

¹¹⁰ NASA Space Flight Guide

EF Exposed Facility

EHS Environmental Health System

ELC Expres Logistics Carrier

ELM Experiment Logistics Module

EMU Extravehicular Mobility Unit

EPM European Physiology Module

EPS Electrical Power System

ERA European Robotic Arm

ESA European Space Agency

ESTEC European Space Research and Technology Centre

ETC European Transport Carrier

EVA Extravehicular Activity

ExPCA EXPRESS Carrier Avionics

EXPRESS Expedite the Processing of Experiments to the Space Station

FGB Functional Cargo Block

FRAM Flight Releasable Attachment Mechanism

FRGF Flight Releasable Grapple Fixture

FSA Roscosmos, Russian Federal Space Agency

FSL Fluid Science Laboratory

GASMAP Gas Analyzer System for Metabolic Analysis Physiology

GB Gigabyte

GCM Gas Calibration Module

GCTC Gagarin Cosmonaut Training Center

GN&C Guidance, Navigation, and Control

GLONASS Global Navigation Satellite System [Russian]

GPS Global Positioning System

GRC Glenn Research Center

GSC Guiana Space Center

HMS Health Maintenance System

HRF Human Research Facility

HTV H-II Transfer Vehicle [JAXA]

IBMP Institute for Biomedical Problems

ICC Integrated Cargo Carrier

ICS Internal Communications System

IEA Integrated Equipment Assembly

IRU In-flight Refill Unit

ISPR International Standard Payload Rack

ISS International Space Station

ITA Integrated Truss Assembly

ITS Integrated Truss Structure

IV-CPDS Intravehicular Charged Particle Directional Spectrometer

JAXA Japan Aerospace Exploration Agency

JEM Japanese Experiment Module

JEM-ELM Japanese Experiment Module-Experiment Logistics Module

JEM-ELM-EF Japanese Experiment Module-Experiment Logistics Module-Exposed Facility

JEM-ELM-ES Japanese Experiment Module-Experiment Logistics Module-Exposed Section

JEM-ELM-PS Japanese Experiment Module-Experiment Logistics Module-Pressurized Section

JEM-PM Japanese Experiment Module-Pressurized Module

JEM-RMS Japanese Experiment Module-Remote Manipulator System

JSC Johnson Space Center

kgf Kilogram Force

kN Kilonewton

KSC Kennedy Space Center

lbf Pound Force

LF Logistics Flight
LiOH Lithium Hydroxide
LSS Life Support Subsystem
Mb Megabit
MBS Mobile Base System
MBSU Main Bus Switching Unit
MCC Mission Control Center
MDM Multiplexer-Demultiplexer
MELFI Minus Eighty-Degree Laboratory Freezer for ISS
MGBX Microgravity Science Glovebox
MLE Middeck Locker Equivalent
MLM Multipurpose Laboratory Module
MMOD Micrometeoroid/Orbital Debris
MMU Mass Memory Unit
MOC MSS Operations Complex
MPLM Multi-Purpose Logistics Module
MSFC Marshall Space Flight Center
MSS Mobile Servicing System
MT Mobile Transporter
NASA National Aeronautics and Space Administration
NAVSTAR Navigation Signal Timing and Ranging [U.S. satellite]
NPO Production Enterprise [Russian]
NTO Nitrogen Tetroxide
NTSC National Television Standards Committee
OMS Orbital Maneuvering System
OGS Oxygen Generation System
ORU Orbital Replacement Unit
OVC Oxygen Ventilation Circuit
P1, P6, etc. Port trusses
PCAS Passive Common Attach System
PDA Payload Disconnect Assembly
PDGF Payload Data Grapple Fixture
PLSS Primary Life Support System
PM Pressurized Module
PMA Pressurized Mating Adapter
POC Payload Operations Center; Primary Oxygen Circuit
PROX OPS Proximity Operations
PSA Power Supply Assembly
PSC Physiological Signal Conditioner
PTCS Passive Thermal Control System
PVGF Power Video Grapple Fixture
PVR Photovoltaic Radiator
RED Resistive Exercise Device
RGA Rate Gyro Assembly
RM Research Module
RMS Remote Manipulation, Manipulator System
RPC Remote Power Controller
rpm Revolutions Per Minute
ROEU-PDA Remotely Operated Electrical Umbilical-Power Distribution Assembly
RPCM Remote Power Controller Module
RSC Rocket and Space Corporation
RV Reentry Vehicle
S&M Structures and Mechanisms
S0 or S Zero, Starboard trusses
S1, etc.
SARJ Solar (Array) Alpha Rotation Joint
SAFER Simplified Aid for EVA Rescue
SASA S-Band Antenna Structural Assembly
SAW Solar Array Wing
SFOG Solid Fuel Oxygen Generator

SFP Space Flight Participant	TMG Thermal Micrometeoroid Garment
SGANT Space-to-Ground Antenna	TNSC Tanegashima Space Center
SM Service Module	TORU Progress Remote Control Unit [Russian]
SPDM Special Purpose Dexterous Manipulator	TSC Telescience Support Center
SS Space Shuttle	TSS Temporary Sleep Station
SSA Space Suit Assembly	TSUP Moscow Mission Control
SSIPC Space Station Integration and Promotion Center	TVIS Treadmill Vibration Isolation System
SSRMS Space Station Remote Manipulator System	UDMH Unsymmetrical Dimethylhydrazine
SSU Sequential Shunt Unit	UF Utilization Flight
STS Space Transportation System	UHF Ultra-High Frequency
TCS Thermal Control System	ULF Utilization and Logistics Flight
TDRS Tracking and Data Relay Satellite	UMA Umbilical Mating Assembly
TEPC Tissue Equivalent Proportional Counter	USOC User Support and Operations Centre
TKS Orbital Transfer System	VDC Voltage, Direct Current
TKSC Tsukuba Space Center	VDU Video Distribution Unit
TMA Transportation Modified Anthropometric	VOA Volatile Organic Analyzer
	WRS Water Recovery System
	Z1 Zenith 1, a truss segment

APPENDIX 3. SPACELAB MISSIONS

- STS-9, Spacelab 1, November 1983, Module LM1 and Pallet (*Columbia*)
- STS-51-B, Spacelab 3, April 1985, Module LM1 (*Challenger*)
- STS-51-F, Spacelab 2, July 1985, triple Pallet configuration (*Challenger*)
- STS-61-A, Spacelab D1, October 1985, Module LM2 (*Challenger*)

- STS-35, ASTRO-1, December 1990, Pallet (*Columbia*)
- STS-40, SLS-1, June 1991, Module LM1 (*Columbia*)
- STS-42, IML-1, January 1992, Module LM2 (*Discovery*)
- STS-45, ATLAS-1, March 1992, double Pallet configuration (*Atlantis*)
- STS-50, USML-1, June 1992, Module LM1 (*Columbia*)
- STS-47, Spacelab-J, September 1992, Module LM2 (*Endeavour*)
- STS-56, ATLAS-2, April 1993, Pallet (*Discovery*)
- STS-55, Spacelab D2, April 1993, Module LM1 (*Columbia*)
- STS-58, SLS-2, October 1993, Module LM2 (*Columbia*)
- STS-59, SRL-1, April 1994, Pallet (*Endeavour*)

- STS-65, IML-2, July 1994, Module LM1 (*Columbia*)
- STS-68, SRL-2, October 1994, Pallet (*Endeavour*)
- STS-66, ATLAS-3, November 1994, Pallet (*Atlantis*)
- STS-67, ASTRO-2, March 1995, Pallet (*Endeavour*)
- STS-71, Spacelab-Mir, June 1995, Module LM2 (*Atlantis*)
- STS-73, USML-2, October 1995, Module LM1 (*Columbia*)
- STS-78, LMS, June 1996, Module LM2 (*Columbia*)
- STS-83, MSL-1, April 1997, Module LM1 (*Columbia*)
- STS-94, MSL-1R, July 1997, Module LM1 (*Columbia*)
- STS-90, Neurolab, April 1998, Module LM2 (*Columbia*)
- STS-99, SRTM, February 2000, Pallet (*Endeavour*)

APPENDIX 4. PHASE ONE—SHUTTLE-MIR MISSIONS

1994

Feb 3 - 11 STS-60: First Cosmonaut on the Shuttle
Sergei K. Krikalev was the first Cosmonaut to fly aboard the Shuttle.

1995

Feb 3 - 11 STS-63: First Rendezvous with Mir
With Cosmonaut VladiMir Titov aboard, Discovery rendezvoused with Mir, closed to within 37 feet, and performed a fly-around, but did not dock.

Mar 14 - Jul 7 Thagard Increment: First Astronaut on Mir
Astronaut Norman Thagard launched with Cosmonauts VladiMir Dezhurov and Gennady Strekalov aboard a Russian Soyuz to spend 115 days on Mir.

Jun 27 - Jul 7 STS-71: First Docking
Atlantis performed the first shuttle docking with Mir; delivered a replacement crew -- cosmonauts Anatoly Solovyev and Nikolai Budarin -- and returned Dezhurov, Strekalov, and Thagard to Earth.

Nov 12 - 20 STS-74: A New Docking Module
The first shuttle assembly flight to Mir, it carried a Russian-built, U.S.-funded docking module with two attached solar arrays.

1996

Mar 22 - 31 STS-76: Starting a Continuous U.S. Presence
This mission carried Shannon Lucid to Mir, demonstrated logistics capabilities with a Spacehab module, and placed experiment packages on Mir's docking module during a spacewalk.

Mar 22 - Aug 26 Lucid Increment: One for the Records
Shannon Lucid began the continuous U.S. presence on Mir and set a U.S. single spaceflight record of 188 days. The Priroda module, with about 2,200 pounds of U.S. science hardware, was docked to Mir.

Aug 16 - 26 STS-79: Blaha Succeeds Lucid
This mission included a double Spacehab module. It brought Lucid home and replaced her with John Blaha.

Aug 16 - Jan 22, 1997 Blaha Increment: Keeping it Going
Blaha spent four months with the Mir-22 Cosmonaut crew conducting material science, fluid science, and life science research.

1997

- Jan 12 - 22** STS-81: Linenger Succeeds Blaha
On this mission, Jerry Linenger replaced Blaha.
- Jan 12 - May 24** Linenger Increment: A Spacewalk and a Fire
Linenger conducted the first spacewalk by a U.S. astronaut wearing a Russian spacesuit and experienced the onboard fire in February.
- May 15 - 24** STS-84: Foale Succeeds Linenger
This mission carried up Linenger's replacement Mike Foale, along with Russian mission specialist Elena V. Kondakova.
- May 15 - Sep 25** Foale Increment: Collision and Recovery
Foale experienced the collision with the Progress, which damaged the Spektr module and caused the loss of some science experiments. A remarkable salvage and replanning effort by Foale and the science community maximized the scientific return. Foale conducted a spacewalk with Anatoly Solovyev to survey damage to the Spektr module.
- Sep 25 - Oct 6** STS-86: Wolf Succeeds Foale
David Wolf boarded Mir with this mission, replacing Foale. Astronaut Scott Parazynski and cosmonaut VladiMir Titov conducted a joint spacewalk, the first in which a Russian wore a U.S. spacesuit.
- Sep 25 - Jan 31, 1998** Wolf Increment: Back Toward Normal
Wolf conducted a spacewalk in January with cosmonaut Solovyev to conduct scientific experiments.

1998

- Jan 22 - 31** STS-89: Thomas Succeeds Wolf
This mission replaced Wolf with Andy Thomas. The flight also carried cosmonaut Salizhan Sharipov to Mir.
- Jan 22 - Jun 12** Thomas Increment: Smoothest Sailing
Thomas studied meteorology, ocean biochemistry, and human adaptation to microgravity.
- Jun 2 - 12** STS-91: Closing Out Shuttle-Mir
This mission picked up Thomas and conducted scientific investigations. Phase 1 came to a close.

APPENDIX 5. INTERNATIONAL SPACE STATION MISSION SUMMARIES

Spacecraft	Launch	Landing/ Deorbit	Mission	Mission	Crew**
1998					
Zarya FGB	1998 Nov. 20	In progress	1A	Control Module	-
STS-88	1998 Dec. 4	1998 Dec. 15	2A	Unity (Node 1) delivery	Robert D. Cabana, Frederick W. Sturckow, Jerry Ross, Nancy J. Currie, James H. Newman, Sergei Krikalev
1999					
STS-96	1999 May 27	1999 June 6	2A.1	Strela/logistics delivery	Kent V. Rominger, Rick D. Husband, Tamara E. Jernigan, Ellen Ochoa, Daniel T. Barry, Julie Payette, Valeri Tokarev
2000					
STS-101	2000 May 19	2000 May 29	2A.2a	Logistics delivery	James D. Halsell, Scott J. Horowitz, Mary Ellen Weber, Jeffrey N. Williams, James S. Voss, Susan Helms, Yuri Usachev
<u>Zvezda</u>	2000 July 12	In progress	1R	Service Module	-
Progress M1-3	2000 Aug. 6	2000 Nov. 1	1P	Cargo supply	-
STS-106	2000 Sept. 8	2000 Sept. 19	2A.2b	Logistics delivery	Terrence W. Wilcutt, Scott D. Altman, Daniel C. Burbank, Edward Tsang Lu, Richard Mastracchio, Yuri Malenchenko, Boris Morukov
STS-92	2000 Oct. 11	2000 Oct. 24	3A	Z-1 truss, PMA-3 docking port delivery	Brian K. Duffy, Pamela A. Melroy, Koichi Wakata, Leroy Chiao, Peter J.K. Wisoff, Michael E. Lopez-Alegria, William S. McArthur
Permanent presence of the crew of three					
Soyuz TM-31	2000. Oct. 31	2001 May 6	2R	1st resident crew delivery	Bill Shepherd, Yuri Gidzenko, Sergei Krikalev (up) Talgat Musabaev, Yuri Baturin, Dennis Tito (down) **
Progress M1-4	2000 Nov. 16	2001 Feb. 8	2P	Cargo supply	-
Endeavour STS-97	2000 Dec. 1	2000 Dec. 11	4A	Delivery of the P6 section with solar arrays	Brendt Jett, Michael J. Bloomfield, Joseph R. Tanner, Marc Garneau, Carlos I. Noriega
2001					
Atlantis STS-98	2001 Feb. 7	2001 Feb. 20	5A	Destiny (US lab) delivery	Kenneth D. Cockrell, Mark L. Polansky, Robert L. Curbeam, Marsha S. Ivins, Thomas D. Jones
Progress M-44	2001 Feb. 26	2001 April 13	3P	Cargo supply	-
Discovery STS-102	2001 March 8	2001 March 21	5A.1	1st and 2nd resident crew exchange, Leonardo cargo module delivery and return	James Wetherbee, James Kelly, Andrew Thomas, Paul Richards; Yuri Usachev, James Voss, Susan Helms (ISS-2: up), Bill Shepherd, Yuri Gidzenko, Sergei Krikalev (ISS-1: down)**
Atlantis STS-100	2001 April 19	2001 May 1	6A	Remote manipulator delivery, Raffaello cargo module delivery and return	Kent V. Rominger, Jeffrey S. Ashby, Chris A. Hadfield, John L. Phillips, Scott E. Parazynski, Umberto Guidoni, Yuri V. Lonchakov
<u>Soyuz TM-32</u>	2001 April 28	2001 Oct. 31	<u>2S</u>	Soyuz rescue vehicle replacement	Talgat Musabaev, Yuri Baturin, Dennis Tito (up)** (This crew returned onboard Soyuz TM-31)

Progress M1-6	2001 May 21	2001 Aug. 22	4P	Cargo supply	-
Atlantis STS-104	2001 July 12	2001 July 24	7A	US airlock delivery and installation (four tanks on two Spacelab pallets)	Steven W. Lindsey, Charles O. Hobaugh, Michael L. Gernhardt, Janet L. Kavandi, James F. Reilly
Discovery STS-105	2001 Aug. 10	2001 Aug. 21	7A.1	2nd and 3rd resident crew exchange; Cargo module delivery and return	Scott "Doc" Horowitz, Frederick Sturckow, Patrick Forrester, Daniel Barry; Frank Culbertson, Vladimir Dezhurov, Mikhail Tyurin (ISS-3: up); Yuri Usachev, James Voss, Susan Helms (ISS-2: down)
Progress M-45	2001 Aug. 21	2001 Nov. 22	5P	Cargo supply	-
Progress / DC-1	2001 Sept. 15	In progress	3R	<u>Docking Compartment 1</u> delivery	-
<u>Soyuz TM-33</u>	2001 Oct. 21	2002 May 5	<u>3S</u>	Soyuz rescue vehicle replacement	Viktor Afanasiev, Konstantin Kazeev, Claudie Haigneré (ESA) (This crew returned onboard Soyuz TM-32)
Progress M1-7	2001 Nov. 26	2002 March 20	6P	Cargo supply	-
Endeavour STS-108	2001 Dec. 5	2001 Dec. 17	UF-1	3rd and 4th resident crew exchange; The Raffaello cargo module delivery and return; Starshine-2 deployment	Dom Gorie, Mark Kelly, Linda Godwin, Daniel Tani; Yuri Onufrienko, Daniel Bursch, Carl Walz (ISS-4: up); Frank Culbertson, Vladimir Dezhurov, Mikhail Tyurin (ISS-3: down)
2002					
Progress M1-8	2002 March 21	2002 June 25	7P	Cargo supply	-
Atlantis STS-110	2002 April 8	2002 April 19	8A	S0 truss delivery	Michael J. Bloomfield, Stephen N. Frick, Rex J. Walheim. Ellen Ochoa, Lee M. E. Morin, Jerry L. Ross, Steven L. Smith
<u>Soyuz TM-34</u>	2002 April 25	2002 Nov. 10	<u>4S</u>	Soyuz rescue vehicle replacement	Yuri Gidzenko, Roberto Vittori, Mark Shuttleworth. (This crew returned onboard Soyuz TM-33)
Endeavour STS-111	2002 June 5	2002 June 19	UF-2	4th and 5th resident crew exchange; Leonardo Multipurpose Logistics Module, Mobile Base System delivery	Ken Cockrell, Paul Lockhart, Franklin Chang-Díaz, Philippe Perrin; Yuri Onufrienko, Daniel Bursch, Carl Walz (ISS-4: down); Valery Korzun, Peggy Whitson, Sergei Treshev (ISS-5: up)
Progress M-46	2002 June 26	2002 Oct. 14	8P	Cargo supply	-
Progress M1-9	2002 Sept. 25	2003 Feb. 1	9P	Cargo supply	-
Atlantis STS-112	2002 Oct. 7	2002 Oct. 18	9A	S1 truss delivery	Jeffrey S. Ashby, Pamela A. Melroy, David A. Wolf, Piers J. Sellers, Sandra H. Magnus, Fyodor N. Yurchikhin.
<u>Soyuz TMA-1</u>	2002 Oct. 30	2003 May 4	5S	Soyuz rescue vehicle replacement; ISS-6 return	Sergei Zalyotin, Yuri Lonchakov, Frank De Winne (Belgium/ESA: up). (This crew returned onboard Soyuz TM-34) Ken Bowersox, Don Petit, Nikolai Budarin (ISS-6: down)
Endeavour STS-113	2002 Nov. 23	2002 Dec. 7	11A	P1 truss, Expedition 6 and 5 exchange	Jim Wetherbee, Paul Lockhart, Michael Lopez-Alegria, John Herrington, Ken Bowersox, Don Petit, Nikolai Budarin. (ISS-6: up); Valery Korzun,

Progress M1-6	2001 May 21	2001 Aug. 22	4P	Cargo supply	-
Atlantis STS-104	2001 July 12	2001 July 24	7A	US airlock delivery and installation (four tanks on two Spacelab pallets)	Steven W. Lindsey, Charles O. Hobaugh, Michael L. Gernhardt, Janet L. Kavandi, James F. Reilly
Discovery STS-105	2001 Aug. 10	2001 Aug. 21	7A.1	2nd and 3rd resident crew exchange; Cargo module delivery and return	Scott "Doc" Horowitz, Frederick Sturckow, Patrick Forrester, Daniel Barry; Frank Culbertson, Vladimir Dezhurov, Mikhail Tyurin (ISS-3: up); Yuri Usachev, James Voss, Susan Helms (ISS-2: down)
Progress M-45	2001 Aug. 21	2001 Nov. 22	5P	Cargo supply	-
Progress / DC-1	2001 Sept. 15	In progress	3R	<u>Docking Compartment 1</u> delivery	-
<u>Soyuz TM-33</u>	2001 Oct. 21	2002 May 5	<u>3S</u>	Soyuz rescue vehicle replacement	Viktor Afanasiev, Konstantin Kazeev, Claudie Haigneré (ESA) (This crew returned onboard Soyuz TM-32)
Progress M1-7	2001 Nov. 26	2002 March 20	6P	Cargo supply	-
Endeavour STS-108	2001 Dec. 5	2001 Dec. 17	UF-1	3rd and 4th resident crew exchange; The Raffaello cargo module delivery and return; Starshine-2 deployment	Dom Gorie, Mark Kelly, Linda Godwin, Daniel Tani; Yuri Onufrienko, Daniel Bursch, Carl Walz (ISS-4: up); Frank Culbertson, Vladimir Dezhurov, Mikhail Tyurin (ISS-3: down)
2002					
Progress M1-8	2002 March 21	2002 June 25	7P	Cargo supply	-
Atlantis STS-110	2002 April 8	2002 April 19	8A	S0 truss delivery	Michael J. Bloomfield, Stephen N. Frick, Rex J. Walheim. Ellen Ochoa, Lee M. E. Morin, Jerry L. Ross, Steven L. Smith
<u>Soyuz TM-34</u>	2002 April 25	2002 Nov. 10	<u>4S</u>	Soyuz rescue vehicle replacement	Yuri Gidzenko, Roberto Vittori, Mark Shuttleworth. (This crew returned onboard Soyuz TM-33)
Endeavour STS-111	2002 June 5	2002 June 19	UF-2	4th and 5th resident crew exchange; Leonardo Multipurpose Logistics Module, Mobile Base System delivery	Ken Cockrell, Paul Lockhart, Franklin Chang-Diaz, Philippe Perrin; Yuri Onufrienko, Daniel Bursch, Carl Walz (ISS-4: down); Valery Korzun, Peggy Whitson, Sergei Treshev (ISS-5: up)
Progress M-46	2002 June 26	2002 Oct. 14	8P	Cargo supply	-
Progress M1-9	2002 Sept. 25	2003 Feb. 1	9P	Cargo supply	-
Atlantis STS-112	2002 Oct. 7	2002 Oct. 18	9A	S1 truss delivery	Jeffrey S. Ashby, Pamela A. Melroy, David A. Wolf, Piers J. Sellers, Sandra H. Magnus, Fyodor N. Yurchikhin.
<u>Soyuz TMA-1</u>	2002 Oct. 30	2003 May 4	5S	Soyuz rescue vehicle replacement; ISS-6 return	Sergei Zalyotin, Yuri Lonchakov, Frank De Winne (Belgium/ESA: up). (This crew returned onboard Soyuz TM-34) Ken Bowersox, Don Petit, Nikolai Budarin (ISS-6: down)
Endeavour STS-113	2002 Nov. 23	2002 Dec. 7	11A	P1 truss, Expedition 6 and 5 exchange	Jim Wetherbee, Paul Lockhart, Michael Lopez-Alegria, John Herrington, Ken Bowersox, Don Petit, Nikolai Budarin . (ISS-6: up); Valery Korzun, Peggy Whitson, Sergei Treshev (ISS-5: down)

Columbia accident grounds the Shuttle fleet, forces the reduction of the ISS crew to two

Progress M-47	2003 Feb. 2	2003 Aug. 28	10P	Cargo supply	-
<u>Soyuz TMA-2</u>	2003 April 26	2003 Oct. 28	6S	Soyuz rescue vehicle replacement; ISS-7 crew delivery	Yuri Malenchenko, Ed Lu (ISS-7)
Progress M1-10 No. 259	2003 June 8	2003 Oct. 3	11P	Cargo supply	-
Progress M-48	2003 Aug. 29	2004 Jan. 28	12P	Cargo supply	-
<u>Soyuz TMA-3</u>	2003 Oct. 18	2004 April 30	7S	Soyuz rescue vehicle replacement; ISS-8 crew delivery	Alexander Kaleri, Michael Foale (ISS-8), Pedro Duque (ESA/Spain) (Duque returned onboard Soyuz TMA-2)
2004					
Progress M1-11 No. 260	2004 Jan. 29	2004 June 3	13P	Cargo supply	-
<u>Soyuz TMA-4</u>	2004 April 19	2004 Oct. 24	8S	Soyuz rescue vehicle replacement; ISS-9 crew delivery	Gennady Padalka, Michael Fincke (ISS-9), André Kuipers (ESA) (Kuipers returned onboard Soyuz TMA-3)
Progress M-49 No. 249	2004 May 25	2004 July 30	14P	Cargo supply	-
Progress M-50 No. 350	2004 Aug. 11	2004 Dec. 23	15P	Cargo supply	-
<u>Soyuz TMA-5</u>	2004 Oct. 14	2005 April 24	9S	Soyuz rescue vehicle replacement; ISS-10 crew delivery	Leroy Chiao, Salizhan Sharipov (ISS-10), Yuri Shargin (Shargin returned onboard Soyuz TMA-4)
Progress M-51 No. 351	2004 Dec. 24	2005 March 9	16P	Cargo supply	-
2005					
Progress M-52 No. 352	2005 Feb. 28	2005 June 16	17P	Cargo supply	-
<u>Soyuz TMA-6</u>	2005 April 15	2005 Oct. 11	10S	Soyuz rescue vehicle replacement; ISS-11 crew delivery	Sergei Krikalev, John Phillips (ISS-11), Roberto Vittori (Italy) (Vittori returned onboard Soyuz TMA-5) (Gregory Olsen: down only)
Progress M-53 No. 353	2005 June 17	2005 Sept. 7	18P	Cargo supply	-
Discovery STS-114	2005 July 26	2005 Aug. 9	LF1	Raffaello Multi-Purpose Logistics Module delivery and return, cargo supply	Eileen Collins, James Kelly, Charles Camarda, Wendy Lawrence, Soichi Noguchi (Japan), Steve Robinson, Andy Thomas
Progress M-54 No. 354	2005 Sept. 8	2006 March 3	19P	Cargo supply	-
<u>Soyuz TMA-7</u>	2005 Oct. 1	2006 April 9	11S	Soyuz rescue vehicle replacement; ISS-12 crew delivery	William McArthur, Valery Tokarev, Gregory Olsen (up only) (Gregory Olsen returned onboard Soyuz TMA-6) Marcos Pontes (Brazil) down only
Progress M-55 No. 355	2005 Dec. 24	2006 June 19	20P	Cargo supply	-
2006					
<u>Soyuz TMA-8</u>	2006 March 30	2006 Sept. 29	12S	Soyuz rescue vehicle replacement; ISS-13 crew delivery	Pavel Vinogradov, Jeffrey Williams, Marcos Pontes (Brazil) (up only) (Pontes returned onboard Soyuz TMA-7); Anousheh Ansari (down only)

Progress M-56 No. 356	2006 April 24	2006 Sept. 19	21P	Cargo supply	-
Progress M-57 No. 357	2006 June 24	2007 Jan. 17	22P	Cargo supply	-
Discovery STS-121	2006 July 4	2006 July 17	ULF1.1	Multi-Purpose Logistics Module (MPLM); Integrated Cargo Carrier (ICC); Lightweight Multi-Purpose Experiment Support Structure Carrier (LMC); ESA astronaut delivery	Steven Lindsey, Mark Kelly, Lisa Nowak, Michael Fossum, Stephanie Wilson, Piers Sellers, Thomas Reiter (up only)(ESA).
Atlantis STS-115	2006 Sept. 9	2006 Sept. 21	12A	Second port truss segment (ITS P3/P4) Second set of solar arrays and batteries	Brent W. Jett Jr., Christopher J. Ferguson, Heidemarie M. Stefanyshyn-Piper, Joseph R. Tanner, Daniel C. Burbank and Steven G. MacLean, CSA.
<u>Soyuz TMA-9</u>	2006 Sept. 18	2007 April 21	13S	Soyuz rescue vehicle replacement; ISS-14 crew delivery	Michael E. Lopez-Alegria, Mikhail Tyurin, Anousheh Ansari (up only) (returned onboard Soyuz TMA-8) Charles Simonyi (down only)
<u>Progress M-58 No. 358</u>	2006 Oct. 23	2007 March 28	23P	Cargo supply	-
Discovery STS-116	2006 Dec. 9	2006 Dec. 22	12A.1	Third port truss segment (ITS P5) delivery; SPACEHAB single cargo module and Integrated Cargo Carrier (ICC) remain in the cargo bay	Mark Polansky, William Oefelein, Robert Curbeam, Joan Higginbotham, Nicholas Patrick, Christer Fuglesang (ESA); Sunita Williams (up only; returns onboard STS-117); Thomas Reiter (ESA) (down only);
2007					
Progress M-59 No. 359	2007 Jan. 18	2007 Aug. 1	24P	Cargo supply	-
<u>Soyuz TMA-10</u>	2007 April 7	2007 Oct. 21	14S	Expedition 15 delivery	Fyodor Yurchikhin, Oleg Kotov , Charles Simonyi (up only; returned onboard Soyuz TMA-9); Muszaphar Shukor (Malaysia); (down only, launched onboard Soyuz TMA-11)
Progress M-60 No. 360	2007 May 12	2007 Sept. 25	25P	Cargo supply	-
Atlantis STS-117	2007 June 8	2007 June 22	13A	Second starboard truss segment (ITS S3/S4) with Photovoltaic Radiator (PVR) Third set of solar arrays and batteries	Frederick W. Sturckow, Lee Joseph Archambault, James F. Reilly II, Steven R. Swanson, Patrick G. Forrester, John D. Olivas, Clayton C. Anderson (up only), Sunita L. Williams (down only)
Progress M-61 No. 361	2007 Aug. 2	2008 Jan. 22	26P	Cargo supply	-
Endeavour STS-118	2007 Aug. 8	2007 Aug. 21	13A.1	SPACEHAB Single Cargo Module Third starboard truss segment (ITS S5) External Stowage Platform 3 (ESP3)	Scott Kelly, Charlie Hobaugh, Tracy Caldwell, Rick Mastracchio, Dave Williams, Barbara Morgan, Al Drew
<u>Soyuz TMA-11</u>	2007 Oct. 10	2008 April 19	15S	Expedition 16 delivery	Peggy A. Whitson, Yuri Malenchenko , Sheikh Muszaphar Shukor (Malaysia) (up only; returns onboard Soyuz TMA-10); So-yeon Yi, (South Korea) (down only; launched onboard <u>Soyuz TMA-12</u>)

					Pamela A. Melroy, George D. Zamka; Douglas H. Wheelock, Scott E. Parazynski, Stephanie D. Wilson, Paolo Nespoli (ESA); Daniel M. Tani ; (up only) Clayton C. Anderson (down only)
Discovery STS-120	2007 Oct. 23	2007 Nov. 7	10A	Node 2 (Harmony) Sidewall - Power and Data Grapple Fixture (PDGF)	
Progress M-62 No. 362	2007 Dec. 23	2008 Feb. 15	27P	Cargo supply	-
2008					
Progress M-63	2008 Feb. 5	2008 April 7	28P	Cargo supply	-
<u>Columbus European Laboratory Module</u>					
Atlantis STS-122	2008 Feb. 7	2008 Feb. 20	1E	Multi-Purpose Experiment Support Structure Non-Deployable (MPSS-ND)	Stephen Frick, Alan Poindexter, Leland Melvin, Rex Walheim, Stanley Love, Leopold Eyharts (ESA) (up only), Hans Schlegel (ESA)
<u>ATV-1</u>	2008 March 9	2008 Sept. 29	ATV1	Cargo supply	-
<u>Kibo Japanese Experiment Logistics Module - Pressurized Section (ELM-PS)</u>					
Endeavour STS-123	2008 March 11	2008 March 26	1J/A	Spacelab Pallet - Deployable 1 (SLP-D1) with Canadian Special Purpose Dexterous Manipulator, Dextre	Dominic Gorie, Gregory H. Johnson, Robert L. Behnken, Mike Foreman, Rick Linnehan, Garrett Reisman , (up only; returns with STS-124) Takao Doi (JAXA); Leopold Eyharts (ESA) (down only; arrived with STS-122)
<u>Soyuz TMA-12</u>	2008 April 8	2008 Oct. 24	16S	Expedition 17 delivery	<u>Sergei Volkov, Oleg Kononenko, So-yeon Yi, (South Korea) (up only; returns onboard Soyuz TMA-11); Richard Garriott (down only; arrived onboard Soyuz TMA-13)</u>

Progress M-64	2008 May 15	2008 Sept. 9	29P	Cargo supply	-
				Kibo Japanese Experiment Module Pressurized Module (JEM-PM)	
Discovery STS-124	2008 May 31	2008 June 14	1J	Japanese Remote Manipulator System (JEM RMS)	Mark Kelly, Ken Ham, Karen Nyberg, Ron Garan, Mike Fossum, Akihiko Hoshide, Greg Chamitoff (up only); Garrett Reisman (down only; arrived with STS-123)
Progress M-65	2008 Sept. 10	2008 Dec. 7	30P	Cargo supply	-
<u>Soyuz TMA-13</u>	2008 Oct. 12	In progress	17S	Expedition 18 delivery	<u>E. Michael Fincke, Yury Lonchakov, Richard Garriott, (USA) (up only; returns onboard Soyuz TMA-12)</u>
Endeavour STS-126	2008 Nov. 14	2008 Nov. 30	ULF2	Leonardo Multi-Purpose Logistics Module (MPLM)	Christopher J. Ferguson, Eric A. Boe, Stephen G. Bowen, Donald R. Pettit, Robert S. (Shane) Kimbrough and Heidemarie M. Stefanyshyn-Piper; Sandra H. Magnus , (up only, returns with STS-119), Greg Chamitoff (down only; arrived with STS-124)
<u>Progress M-01M</u>	2008 Nov. 26	2009 Feb. 8	31P	Cargo supply	-
2009					
Progress M-66	2009 Feb. 10	In progress	32P	Cargo supply	-

