

Operator's Manual

Lycoming

IO-320 Series

Approved by FAA

3rd Edition

Part No. 60297-31

LYCOMING

652 Oliver Street
Williamsport, PA. 17701 U.S.A.
570/323-6181

January 2007

IO-320 Series Operator's Manual

Lycoming Part Number: 60297-31

©2006 by Lycoming. All rights reserved.

Lycoming and "Powered by Lycoming" are trademarks or registered trademarks of Lycoming.

All brand and product names referenced in this publication are trademarks or registered trademarks of their respective companies.

For additional information:

Mailing address:

Lycoming Engines
652 Oliver Street
Williamsport, PA 17701 U.S.A.

Phone:

Factory: 570-323-6181
Sales Department: 570-327-7268
Fax: 570-327-7101

Lycoming's regular business hours are Monday through Friday from 8:00 AM through 5:00 PM Eastern Time (-5 GMT)

Visit us on the World Wide Web at:

<http://www.lycoming.com>

LYCOMING OPERATOR'S MANUAL

ATTENTION

OWNERS, OPERATORS, AND MAINTENANCE PERSONNEL

This operator's manual contains a description of the engine, its specifications, and detailed information on how to operate and maintain it. Such maintenance procedures that may be required in conjunction with periodic inspections are also included. This manual is intended for use by owners, pilots and maintenance personnel responsible for care of Lycoming powered aircraft. Modifications and repair procedures are contained in Lycoming overhaul manuals; maintenance personnel should refer to these for such procedures.

SAFETY WARNING

Neglecting to follow the operating instructions and to carry out periodic maintenance procedures can result in poor engine performance and power loss. Also, if power and speed limitations specified in this manual are exceeded, for any reason, damage to the engine and personal injury can happen. Consult your local FAA approved maintenance facility.

SERVICE BULLETINS, INSTRUCTIONS, AND LETTERS

Although the information contained in this manual is up-to-date at time of publication, users are urged to keep abreast of later information through Lycoming Service Bulletins, Instructions and Service Letters which are available from all Lycoming distributors or from the factory by subscription. Consult the latest revision of Service Letter No. L114 for subscription information.

NOTE

The illustrations, pictures and drawings shown in this publication are typical of the subject matter they portray; in no instance are they to be interpreted as examples of any specific engine, equipment or part thereof.

LYCOMING OPERATOR'S MANUAL

IMPORTANT SAFETY NOTICE

Proper service and repair is essential to increase the safe, reliable operation of all aircraft engines. The service procedures recommended by Lycoming are effective methods for performing service operations. Some of these operations require the use of tools specially designed for the task. These special tools must be used when and as recommended.

It is important to note that most Lycoming publications contain various Warnings and Cautions which must be carefully read in order to minimize the risk of personal injury or the use of improper service methods that may damage the engine or render it unsafe.

It is also important to understand that these Warnings and Cautions are not all inclusive. Lycoming could not possibly know, evaluate or advise the service trade of all conceivable ways in which service might be done or of the possible hazardous consequences that may be involved. Accordingly, anyone who uses a service procedure must first satisfy themselves thoroughly that neither their safety nor aircraft safety will be jeopardized by the service procedure they select.

LYCOMING OPERATOR'S MANUAL

TABLE OF CONTENTS

		Page
SECTION 1	DESCRIPTION	1-1
SECTION 2	SPECIFICATIONS	2-1
SECTION 3	OPERATING INSTRUCTIONS	3-1
SECTION 4	PERIODIC INSPECTIONS	4-1
SECTION 5	MAINTENANCE PROCEDURES	5-1
SECTION 6	TROUBLE-SHOOTING	6-1
SECTION 7	INSTALLATION AND STORAGE	7-1
SECTION 8	TABLES	8-1

LYCOMING OPERATOR'S MANUAL

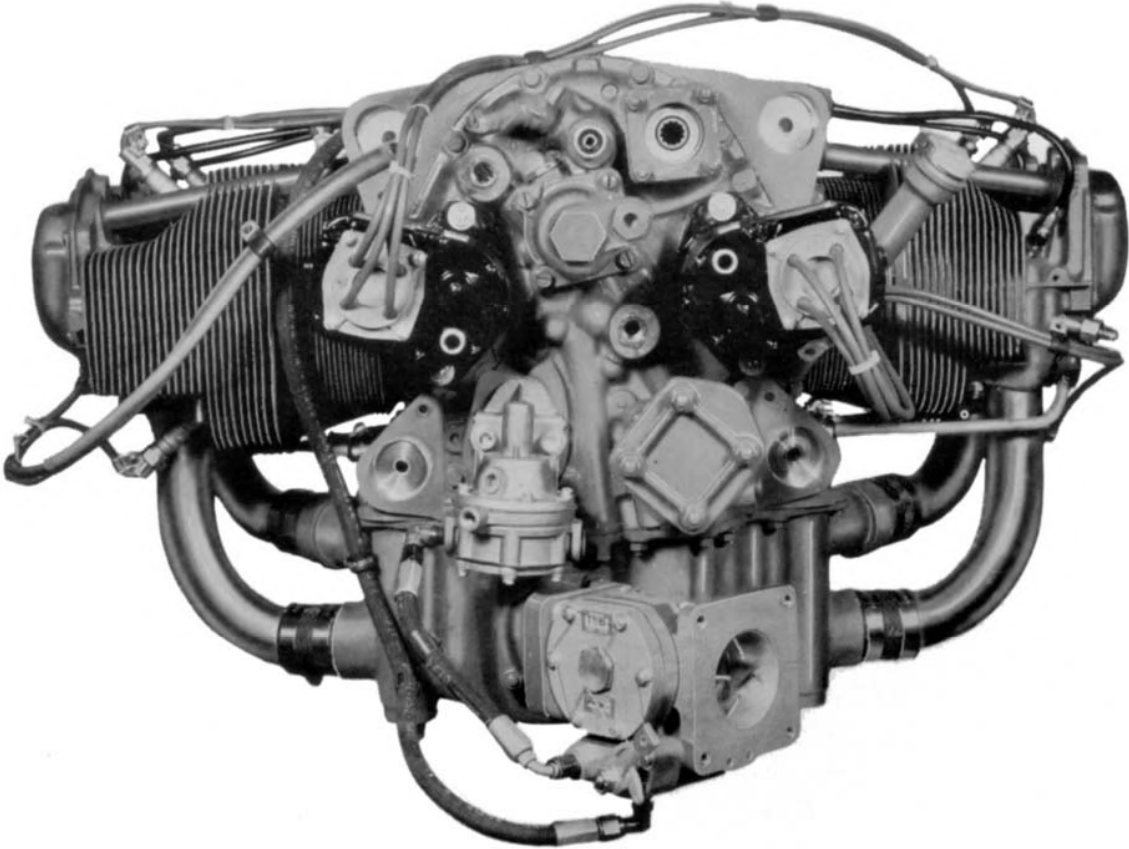

Rear View – Typical IO-320-B Series

LYCOMING OPERATOR'S MANUAL

SECTION 1 DESCRIPTION

	Page
General.....	1-1
Cylinders.....	1-1
Valve Operating Mechanism	1-1
Crankcase	1-1
Crankshaft.....	1-1
Connecting Rods	1-1
Pistons	1-2
Accessory Housing	1-2
Oil Sump	1-2
Cooling System.....	1-2
Induction System.....	1-2
Lubrication System.....	1-2
Priming System	1-3
Ignition System.....	1-3
Model Application Table.....	1-3

This Page Intentionally Left Blank.

SECTION 1

DESCRIPTION

The IO, AIO and LIO-320 series are four cylinder, direct drive, and horizontally opposed air-cooled engines.

In referring to the location of the various engine components, the parts are described in their relationship to the engine as installed in the airframe. Thus, the power take-off end is considered the front and the accessory drive end the rear. The sump section is considered the bottom and the opposite side of the engine where the shroud tubes are located the top. Reference to the left and right side is made with the observer facing the rear of the engine. The cylinders are numbered from front to rear, odd numbers on the right, even numbers on the left. The direction of rotation for accessory drives is determined with the observer facing the drive pad. The direction of rotation of the crankshaft, viewed from the rear, is clockwise.

NOTE

The letter "L" in the model prefix denotes the reverse rotation of the basic model. Example: model IO-320-C has clockwise rotation of the crankshaft. Therefore, LIO-320-C has counterclockwise rotation of the crankshaft. Likewise, the rotation of the accessory drives of the LIO-320-C are opposite those of the basic model as listed in Section 2 of this manual

Operational aspects of both engines are the same and performance curves and specifications for the basic model will apply to the model with reverse rotation.

Cylinders – The cylinders are of the conventional air-cooled construction with the two major parts, head and barrel, screwed and shrunk together. The heads are made from an aluminum alloy casting with a fully machined combustion chamber. Rocker shaft bearing supports are cast integral with the head along with housings to form the rocker boxes for both valve rockers. The cylinder barrels, which are machined from chrome nickel molybdenum steel forgings, have deep integral cooling fins and the inside of the barrels are ground and honed to a specified finish.

Valve Operating Mechanism – A conventional type camshaft is located above and parallel to the crankshaft. The camshaft actuates hydraulic tappets, which operate the valves through push rods and valve rockers. The valve rockers are supported on full floating steel shafts. The valve springs bear against hardened steel seats and is retained on the valve stems by means of split keys.

Crankcase – The crankcase assembly consists of two reinforced aluminum alloy castings, fastened together by means of studs, bolts and nuts. The mating surfaces of the two castings are joined without the use of a gasket, and the main bearing bores are machined for use of prevision type main bearing inserts.

Crankshaft – The crankshaft is made from a chrome nickel molybdenum steel forging. All bearing journal surfaces are nitrided.

Connecting Rods – The connecting rods are made in the form of "H" sections from alloy steel forgings. They have replaceable bearing inserts in the crankshaft ends and bronze bushings in the piston ends. Two bolts and nuts through each cap retain the bearing caps on the crankshaft ends.

SECTION 1
DESCRIPTION

LYCOMING OPERATOR'S MANUAL
IO-320 SERIES

Pistons – The pistons are machined from an aluminum alloy. The piston pin is of a full floating type with a plug located in each end of the pin. Depending on the cylinder assembly, pistons may employ either half wedge or full wedge rings. Consult the latest revision of Service Instruction No. 1037 for proper piston and ring combinations.

Accessory Housing – The accessory housing is made from an aluminum casting and is fastened to the rear of the crankcase and the top rear of the sump. It forms a housing for the oil pump and the various accessory drives.

Oil Sump (Except AIO Series) – The sump incorporates an oil drain plug, oil suction screen, mounting pad for fuel injector, the intake riser and intake pipe connections.

Crankcase Covers (AIO Series) – Crankcase covers are employed on the top and bottom of the engine. These covers incorporate oil suction screens and oil scavenge line connections. The top cover incorporates a connection for a breather line and the lower cover a connection for an oil suction line.

Cooling System – These engines are designed to be cooled by air pressure. Baffles are provided to build up a pressure and force the air through the cylinder fins. The air is then exhausted to the atmosphere through gills or augments tubes usually located at the rear of the cowling.

Induction System – Lycoming IO-320 series engines are equipped with a Bendix type RSA fuel injector. The fuel injection system schedules fuel flow in proportion to air flow and fuel vaporization takes place at the intake ports.

A brief description of the fuel injector follows:

The Bendix RSA type fuel injection system is based on the principle of measuring airflow and using the airflow signal in a stem type regulator to convert the air force into a fuel force. This fuel force (fuel pressure differential) when applied across the fuel metering section (jetting system) makes fuel flow proportional to airflow. A manual mixture control and idle-cut-off are provided.

Lubrication System – The lubrication system is of the pressure wet sump type. The main bearings, connecting rod bearings, camshaft bearings, valve tappets, push rods and crankshaft idler gears are lubricated by means of oil collectors and spray. The oil pump, which is located in the accessory housing, draws oil through a drilled passage leading from the oil suction screen located in the sump. The oil from the pump then enters a drilled passage in the accessory housing, where a flexible line leads the oil to the external oil cooler. In the event that cold oil or an obstruction should restrict the flow of oil to the cooler, an oil cooler bypass valve is provided. Pressure oil from the cooler returns to a second threaded connection on the accessory housing from which point a drilled passage conducts the oil to the oil pressure screen, which is contained in a cast chamber located on the accessory housing below the tachometer drive.

The oil pressure screen is provided to filter from the oil any solid particles that may have passed through the suction screen in the sump. After being filtered in the pressure screen chamber, the oil is fed through a drilled passage to the oil relief valve, located in the upper right side of the crankcase in front of the accessory housing.

This relief valve regulates the engine oil pressure by allowing excessive oil to return to the sump, while the balance of the pressure oil is fed to the main oil gallery in the right half of the crankcase. During its travel through this main gallery, the oil is distributed by means of separate drilled passages to the main bearings of the crankshaft. Separate passages from the rear main bearings supply pressure oil to both crankshaft idler gears. Angular holes are drilled through the main bearings to the rod journals. Oil from the main oil gallery also flows to the cam and valve gear passages, and is then conducted through branch passages to the hydraulic tappets and camshaft bearings. Oil enters the tappets through indexing holes and travels out through the hollow push rods to the valve mechanism, lubricating the valve rocker bearings and valve stems. Residual oil from the bearings, accessory drives and the rocker boxes is returned by gravity to the sump, where after passing through a screen it is again circulated through the engine. Pressure build up within the crankcase is held to a minimum by means of a breather located on the accessory housing.

In addition, model IO-320-C1A incorporates oil jets in the crankcase. The oil jets furnish an oil spray to provide internal cooling for the pistons.

Priming System – Provision for a primer system is provided on all engines employing a carburetor. Fuel injected engines do not require a priming system.

Ignition System – Two magnetos furnish dual ignition. Consult Table 1 for model application. Bendix magnetos are designed to permit periodic internal maintenance; Slick Electro magnetos are designed to operate approximately 900 hours without internal maintenance.

TABLE 1

MODEL APPLICATION					
Model	Magnetos		Dimensions		
IO-320	Left	Right	Height	Width	Length
-A1A, -A2A*	S4LN-200	S4LN-204	19.22	32.24	33.59
-B1A, -B2A*	S4LN-21	S4LN-20	19.22	32.24	33.59
-B1B	S4LN-21	S4LN-20	19.22	32.24	33.59
-B1C	S4LN-21	S4LN-20	19.22	32.24	32.09
-B1D	S4LN-1208	S4LN-1209	19.22	32.24	32.09
-B1E	4251	4250	19.22	32.24	32.09
-C1A, -C1B	S4LN-21	S4LN-21	19.22	32.24	33.59
-D1A, -D1B	S4LN-1227	S4LN-1209	23.18	32.24	30.70
-D1C	4251	4250	23.19	32.24	29.05
-E1A, -E2A*	S4LN-21	S4LN-20	23.18	32.24	29.56
-E1B	4051	4050	23.19	32.24	29.05
-E2B*	4051	4050	23.18	32.24	29.05
AIO-320					
-A1A, -A2A*	S4LN-1208	S4LN-1209	20.76	32.24	30.08
-A1B, -A2B*	S4LN-1227	S4LN-1209	20.76	32.24	30.08
-B1B	S4LN-1227	S4LN-1209	20.76	32.24	30.08
-C1B	S4LN-1227	S4LN-1209	25.57	32.24	30.08
LIO-320					
-B1A	S4RN-21	S4RN-20	19.22	32.24	33.59
-C1A	S4RN-21	S4RN-21	19.22	32.24	33.59

* - Fixed Pitch Propeller

This Page Intentionally Left Blank.

LYCOMING OPERATOR'S MANUAL

SECTION 2 SPECIFICATIONS

	Page
Explanatory Note	2-1
Specifications – IO-320-A1A, -A2A, -E1A, -E1B, -E2A, -E2B.....	2-2
Specifications – IO-320-B1A, -B1B, -B1C, -B1D, -B2A, -E1A, -D1B; AIO-320; LIO-320.....	2-2
Specifications – IO-320-C1A, -C1B	2-2
Specifications – IO-320-B1E, -D1C	2-3
Accessory Drive Ratio.....	2-3
Detail Weights	2-3

This Page Intentionally Left Blank.

SECTION 2

SPECIFICATIONS

The model specifications shown on the following pages of this section are divided according to model designation. When differences among models can be clearly stated, the specifications of more than one model are combined in a single group; otherwise each model has its specifications listed separately. Also, as additional models are added to this series, new specification pages containing data pertinent to the new models will be added.

**SECTION 2
SPECIFICATIONS**

**LYCOMING OPERATOR'S MANUAL
IO-320 SERIES**

SPECIFICATIONS

IO-320-A1A, -A2A, -E1A, -E1B, -E2A, -E2B

FAA Type Certificate	1E12
Rated horsepower.....	150
Rated speed, RPM.....	2700
Bore, inches.....	5.125
Stroke, inches.....	3.875
Displacement, cubic inches.....	319.8
Compression ratio	7.0:1
Firing order	1-3-2-4
Spark occurs, degrees BTC.....	25
Valve rocker clearance (hydraulic tappets collapsed)028-.080
Propeller drive ratio	1:1
Propeller drive rotation (viewed from rear).....	Clockwise

IO-320-B1A, -B1B, -B1C, -B1D, -B2A, -D1A, -D1B; AIO-320; LIO-320

FAA Type Certificate	1E12
Rated horsepower.....	160
Rated speed, RPM.....	2700
Bore, inches.....	5.125
Stroke, inches.....	3.875
Displacement, cubic inches.....	319.8
Compression ratio	8.5:1
Firing order*	1-3-2-4
Spark occurs, degrees BTC.....	25
Valve rocker clearance (hydraulic tappets collapsed)028-.080
Propeller drive ratio	1:1
Propeller drive rotation	
All but LIO-320 Series.....	Clockwise
LIO-320 Series.....	Counterclockwise

IO-320-C1A, -C1B

FAA Type Certificate	1E12
Rated horsepower.....	160
Rated speed, RPM.....	2700
Bore, inches.....	5.125
Stroke, inches.....	4.375
Displacement, cubic inches.....	319.8
Compression ratio	8.5:1
Firing order*	1-3-2-4
Spark occurs, degrees BTC.....	25
Valve rocker clearance (hydraulic tappets collapsed)028-.080
Propeller drive ratio	1:1
Propeller drive rotation	
All but LIO-320 Series.....	Clockwise
LIO-320 Series.....	Counterclockwise

* - LIO-320 Series Only – Firing order 1-4-2-4.

SPECIFICATIONS (CONT.)

IO-320-B1E, -D1C

FAA Type Certificate	1E12
Rated horsepower.....	160
Rated speed, RPM.....	2700
Bore, inches.....	5.125
Stroke, inches.....	4.875
Displacement, cubic inches.....	319.8
Compression ratio	8.5:1
Firing order	1-3-2-4
Spark occurs, degrees BTC.....	25
Valve rocker clearance (hydraulic tappets collapsed)028-.080
Propeller drive ratio	1:1
Propeller drive rotation (viewed from rear).....	Clockwise

*Accessory Drive	Drive Ratio	**Direction of Rotation
Starter	13.556:1	Counterclockwise
Starter	16.556:1	Counterclockwise
Generator	1.910:1	Clockwise
Generator	2.500:1	Clockwise
Alternator	3.250:1	Clockwise
Tachometer	0.500:1	Clockwise
Magneto	1.000:1	Clockwise
Vacuum Pump	1.300:1	Counterclockwise
Prop. Gov. AN20010		
Mounted on Accy. Hsg.	0.866:1	Clockwise
Mounted on Crankcase	0.895:1	Clockwise
Fuel Pump AN20003	1.000:1	Counterclockwise
Fuel Pump – Plunger Operated	0.500:1	
Dual Drives		
Vacuum – Hydraulic Pump	1.300:1	Counterclockwise
Vacuum Pump – Prop. Governor	1.300:1	Counterclockwise

* - When applicable.

** - Viewed facing drive pad.

NOTE that LIO-320 series engines will have opposite rotation to the above.

DETAIL WEIGHTS

1. Engine, Standard, Dry Weight.

Includes fuel injector, magnetos, spark plugs, ignition harness, intercylinder baffles, tachometer drive, starter and generator (alternator) drive, starter and generator (alternator) with mounting bracket.

DETAIL WEIGHTS (CONT.)

IO-320 SERIES

	LBS.
-A1A, -A2A	280
-E1B	283
-B1B, -E1A, -E2A, -E2B	285
-B1A, -B2A, -B1C	287
-B1D	288
-D1A	291
-D1B	293
-C1A	301
-D1C	306
-B1E	307
-C1B	313

AIO-320 SERIES

	LBS.
-A1A, -A2A	306
-A1B, A2B, -B1B, -C1B	307

LYCOMING OPERATOR'S MANUAL

SECTION 3 OPERATING INSTRUCTIONS

	Page
General.....	3-1
Prestarting Items of Maintenance	3-1
Starting Procedures	3-1
Cold Weather Starting	3-2
Ground Running and Warm-Up	3-2
Ground Check	3-3
Operation in Flight	3-4
Fuel Mixture Leaning Procedure	3-4
Leaning to Exhaust Gas Temperature Gage	3-4
Leaning to Flowmeter	3-5
Leaning with Manual Mixture Control	3-5
Engine Flight Chart	3-5
Operating Conditions	3-6
Engine Shut Down	3-7
Performance Curves	3-9

This Page Intentionally Left Blank.

SECTION 3

OPERATING INSTRUCTIONS

1. *GENERAL.* Close adherence to these instructions will greatly contribute to long life, economy and satisfactory operation of the engine.

NOTE

YOUR ATTENTION IS DIRECTED TO THE WARRANTIES THAT APPEAR IN THE FRONT OF THIS MANUAL REGARDING ENGINE SPEED, THE USE OF SPECIFIED FUELS AND LUBRICANTS, REPAIRS AND ALTERATIONS. PERHAPS NO OTHER ITEM OF ENGINE OPERATION AND MAINTENANCE CONTRIBUTES QUITE SO MUCH TO SATISFACTORY PERFORMANCE AND LONG LIFE AS THE CONSTANT USE OF CORRECT GRADES OF FUEL AND OIL, CORRECT ENGINE TIMING, AND FLYING THE AIRCRAFT AT ALL TIMES WITHIN THE SPEED AND POWER RANGE SPECIFIED FOR THE ENGINE. DO NOT FORGET THAT VIOLATION OF THE OPERATION AND MAINTENANCE SPECIFICATIONS FOR YOUR ENGINE WILL NOT ONLY VOID YOUR WARRANTY BUT WILL SHORTEN THE LIFE OF YOUR ENGINE AFTER ITS WARRANTY PERIOD HAS PASSED.

New engines have been carefully run-in by Lycoming; therefore, no further break-in is necessary insofar as operation is concerned; however, new or newly overhauled engines should be operated on straight mineral oil for a minimum of 50 hours or until oil consumption has stabilized. After this period, a change to an approved additive oil may be made, if so desired.

NOTE

Cruising should be done at 65% to 75% power until a total of 50 hours has accumulated or oil consumption has stabilized. This is to ensure proper seating of the rings and is applicable to new engines, and engines in service following cylinder replacement or top overhaul of one or more cylinders.

The minimum fuel octane rating is listed in the flight chart, Part 8 of this section. Under no circumstances should fuel of a lower octane rating or automotive fuel (regardless of octane rating) be used.

2. *PRESTARTING ITEMS OF MAINTENANCE.* Before starting the aircraft engine for the first flight of the day, there are several items of maintenance inspection that should be performed. These are described in Section 4 under Daily Pre-Flight Instruction. They must be observed before the engine is started.

3. *STARTING PROCEDURES.*

The following starting procedures are recommended, however, the starting characteristics of various installations will necessitate some variation from these procedures.

NOTE

Cranking periods must be limited to ten (10) to twelve (12) seconds with a five (5) minute rest between cranking periods.

**SECTION 3
OPERATING INSTRUCTIONS**

**LYCOMING OPERATOR'S MANUAL
IO-320 SERIES**

a. Fuel Injected Engines (Cold).

- (1) Perform preflight inspection.
- (2) Set alternate air control in "off" position.
- (3) Set propeller governor control in "Full RPM" position (where applicable).
- (4) Turn fuel valve "On".
- (5) Turn boost pump "On".
- (6) Open throttle wide open, move mixture control to "Full Rich" until a slight but steady flow is noted (approximately 3 to 5 seconds) then return throttle to "Closed" and return mixture control to "Idle Cut-Off".
- (7) Turn boost pump "Off".
- (8) Open throttle ¼ of travel.
- (9) Set magneto selector switch. (Consult airframe manufacturer's handbook for correct position.)
- (10) Engage starter.
- (11) When engine fires move the magneto switch to "Both".
- (12) Move mixture control slowly and smoothly to "Full Rich".
- (13) Check oil pressure gage. If minimum oil pressure is not indicated within thirty seconds, stop engine and determine trouble.

b. Fuel Injected Engines (Hot). Because of the fact that the fuel percolates and the system must be cleared of vapor, it is recommended that the same procedure be used as outlined for cold engine start.

4. COLD WEATHER STARTING. During extreme cold weather, it may be necessary to preheat the engine and oil before starting.

5. GROUND RUNNING AND WARM-UP.

The engines covered in this manual are air-pressure cooled and depend on the forward speed of the aircraft to maintain proper cooling. Particular care is necessary, therefore, when operating these engines on the ground. To prevent overheating, it is recommended that the following precautions be observed.

NOTE

Any ground check that requires full throttle operation must be limited to three minutes, or less if the indicated cylinder head temperature should exceed the maximum stated in this manual.

- a. Head the aircraft into the wind.
- b. Leave mixture in "Full Rich".
- c. Operate only with the propeller in minimum blade angle setting.
- d. Warm-up at approximately 1000-1200 RPM. Avoid prolonged idling and do not exceed 2200 RPM on the ground.
- e. Engine is warm enough for take-off when the throttle can be opened without the engine faltering.

6. GROUND CHECK.

- a. Warm-up as directed above.
- b. Check both oil pressure and oil temperature.
- c. Leave mixture in "Full Rich".
- d. (Where applicable.) Move the propeller control through its complete range to check operation and return to full low pitch position. Full feathering check (twin engine) on the ground is not recommended but the feathering action can be checked by running the engine between 1000-1500 RPM; then momentarily pulling the propeller control into the feathering position. Do not allow the RPM to drop more than 500 RPM.
- e. A proper magneto check is important. Additional factors, other than the ignition system, affect magneto drop-off. They are load-power output, propeller pitch and mixture strength. The important thing is that the engine runs smoothly because magneto drop-off is affected by the variables listed above. Make the magneto check in accordance with the following procedures.
 - (1) *Controllable Pitch Propeller* – With propeller in minimum pitch angle, set the engine to produce 50-65% power as indicated by the manifold pressure gage. Mixture control should be in the full rich position. At these settings, the ignition system and spark plugs must work harder because of the greater pressure within the cylinders. Under these conditions ignition problems, if they exist, will occur. Magneto checks at low power settings will only indicate fuel-air distribution quality.

NOTE

Aircraft that are equipped with fixed pitch propeller, or not equipped with manifold pressure gage, may check magneto drop-off with engine operating at a maximum of 2000-2100 RPM.

- (2) Switch from both magnetos to one and note drop-off, return to both until engine regains speed and switch to the other magneto and note drop-off, then return to both. Drop-off should not exceed 175 RPM and should not exceed 50 RPM between magnetos. A smooth drop-off past normal is usually a sign of a too lean or too rich mixture.
- f. Do not operate on a single magneto for too long a period, a few seconds is usually sufficient to check drop-off and will minimize plug fouling.

7. OPERATION IN FLIGHT.

- a. See airframe manufacturer's instructions for recommended power settings.
- b. *Fuel Mixture Leaning Procedure.*

Improper fuel/air mixture during flight is responsible for many engine problems, particularly during take-off and climb power settings. The procedures described in this manual provide proper fuel/air mixture when leaning Lycoming engines; they have proven to be both economical and practical by eliminating excessive fuel consumption and reducing damaged parts replacement. It is therefore recommended that operators of all Lycoming aircraft power plants utilize the instructions in this publication any time the fuel/air mixture is adjusted during flight.

Manual leaning may be monitored by exhaust gas temperature indication, fuel flow indication, and by observation of engine speed and/or airspeed. However, whatever instruments are used in monitoring the mixture, the following general rules should be observed by the operator of Lycoming engines.

GENERAL RULES

Never exceed the maximum red line cylinder head temperature limit.

For maximum service life, cylinder head temperatures should be maintained below 435°F (224°C) during high performance cruise operation and below 400°F (205°C) for economy cruise powers.

Do not manually lean engines equipped with automatically controlled fuel system.

Maintain mixture control in "Full Rich" position for rated take-off, climb and maximum cruise powers (above approximately 75%). However, during take-off from high elevation airport or during climb, roughness or loss of power may result from over-richness. In such a case adjust mixture control only enough to obtain smooth operation – not for economy. Observe instruments for temperature rise.

Always return the mixture to full rich before increasing power settings.

Operate the engine at maximum power mixture for performance cruise powers and at best economy mixture for economy cruise power; unless otherwise specified in the airplane owners manual.

During let-down flight operations it may be necessary to manually lean uncompensated fuel injected engines to obtain smooth operation.

1. LEANING TO EXHAUST GAS TEMPERATURE GAGE.

- a. *Normally aspirated engines with fuel injectors.*

(1) *Maximum Power Cruise (approximately 75% power) – Never lean beyond 150°F on rich side of peak EGT unless aircraft operator's manual shows otherwise. Monitor cylinder head temperatures.*

(2) *Best Economy Cruise (approximately 75% power and below) – Operate at peak EGT, or if desired, drop 50°F on rich side of peak EGT.*

2. LEANING TO FLOWMETER.

Lean to applicable fuel-flow tables or lean to indicator marked for correct fuel-flow for each power setting.

3. LEANING WITH MANUAL MIXTURE CONTROL (Economy Cruise, 75% power or less) without flowmeter or EGT gage.

a. Fuel Injected Engines.

(1) *Slowly move mixture control from "Full Rich" position toward lean position.*

(2) *Continue leaning until slight loss of power is noted (loss of power may or may not be accomplished by roughness).*

(3) *Enrich until engine runs smoothly and power is regained.*

As shown in Figure 3-1, if engine speed and throttle setting are kept constant at normal cruise conditions, the affect of leaning on engine power and engine temperatures will be as shown. Power drops rapidly when the engine is leaned beyond peak exhaust gas temperature; also, best power is attained on the rich side of peak exhaust gas temperature.

8. ENGINE FLIGHT CHART.

Fuel and Oil –

Model	Aviation Grade Fuel
IO-320-A1A, -A2A, -E1A, -E2A, -E1B, -E2B	80/87 octane, minimum
IO-320-B1A, -B2A, -B2B, -B2C, -B1D	91/96 or 100/130 octane, minimum
IO-320-D1A, -D1B	91/96 or 100/130 octane, minimum
IO-320-B1E, -C1A, -C1B, -D1C	100/100LL octane, minimum
AIO-320 Series	91/96 or 100/130 octane, minimum
LIO-320-B Series	91/96 or 100/130 octane, minimum
LIO-320-C Series	100/130 octane, minimum

NOTE: Aviation grade 100LL fuels in which the lead content is limited to 2 c.c. per gal. are approved for continuous use in the above listed engines.

**SECTION 3
OPERATING INSTRUCTIONS**

**LYCOMING OPERATOR'S MANUAL
IO-320 SERIES**

ALL MODELS

Average Ambient Air	*Recommended Grade Oil	
	MIL-L-6082 Grades	Ashless Dispersant Grades
Above 80°F (26.66°C)	SAE 60	SAE 60
Above 60°F (15.55°C)	SAE 50	SAE 40 or SAE 50
30°F to 90°F (-1.11°C to 32.22°C)	SAE 40	SAE 40
0°F to 70°F (-17.77°C to 21.11°C)	SAE 20	SAE 30 or SAE 40
Below 10°F (-12.22°C)	SAE 20	SAE 30

* - Refer to the latest edition of Service Instruction No. 1014.

Oil Sump Capacity 8 U.S. Quarts

Minimum Safe Quantity in Sump 2 U.S. Quarts

OPERATING CONDITIONS

Average Ambient Air	Oil Inlet Temperature	
	Desired	Maximum
Above 80°F (26.66°C)	180°F (82°C)	245°F (118°C)
Above 60°F (15.55°C)	180°F (82°C)	245°F (118°C)
30°F to 90°F (-1.11°C to 32.22°C)	180°F (82°C)	245°F (118°C)
0°F to 70°F (-17.77°C to 21.11°C)	170°F (77°C)	225°F (107°C)
Below 10°F (-12.22°C)	160°F (71°C)	210°F (99°C)

Oil Pressure, psi	Maximum	Minimum	Idling
	Normal Operating	90	60
Start and Warm-Up	100		

Fuel Pressure, psi	Maximum	Desired	Min.
	IO-320-B, -D, -E Series; AIO-320; LIO-320-B		
Inlet to fuel pump	35	----	-2
Inlet to fuel injector	45	----	12
Inlet to fuel pump with injector in idle cut-off	55	----	----
IO-320-C Series; LIO-320-C			
Inlet to fuel pump	45	----	-2
Inlet to fuel injector	45	----	14
Inlet to fuel pump with injector in idle cut-off	55	----	----

OPERATING CONDITIONS (CONT.)

Operation	RPM	HP	Fuel Cons. Gal./Hr.	Max. Oil Cons. Qts./Hr.	*Max. Cyl.Head Temp.
IO-320-A, -E Series					
Normal Rated	2700	150	-----	.67	500°F (260°C)
Performance Cruise (75% Rated)	2450	110	10.0	.37	500°F (260°C)
Economy Cruise (65% Rated)	2350	97	8.8	.33	500°F (260°C)
IO-320-B, -C, -D; AIO-320; LIO-320 Series					
Normal Rated	2700	160	-----	.72	500°F (260°C)
Performance Cruise (75% Rated)	2450	120	10.0	.40	500°F (260°C)
Economy Cruise (65% Rated)	2350	104	8.8	.35	500°F (260°C)

* - At Bayonet Location – For maximum service life of the engine, maintain cylinder head temperatures between 150°F and 435°F during continuous operation.

9. ENGINE SHUT-DOWN.

- a. Set propeller at minimum blade angle (where applicable).
- b. Idle until there is a decided decrease in cylinder head temperature.
- c. Move mixture control to “Idle Cut-Off”.
- d. When engine stops, turn ignition switch off.

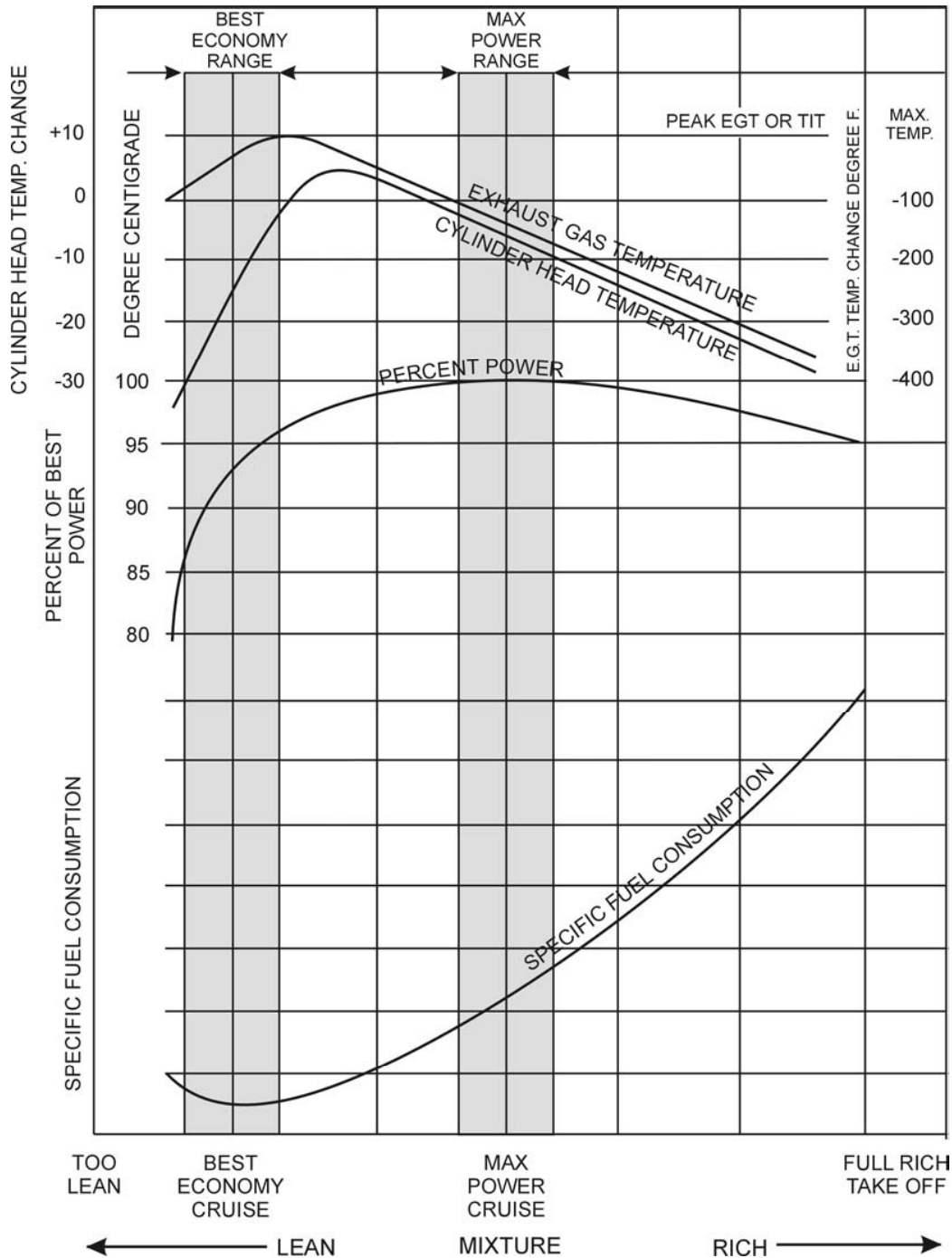

Figure 3-1. Representative Effect of Leaning on Cylinder Head Temperature, EGT (Exhaust Gas Temperature), Engine Power and Specific Fuel Consumption at Constant Engine RPM and Manifold Pressure

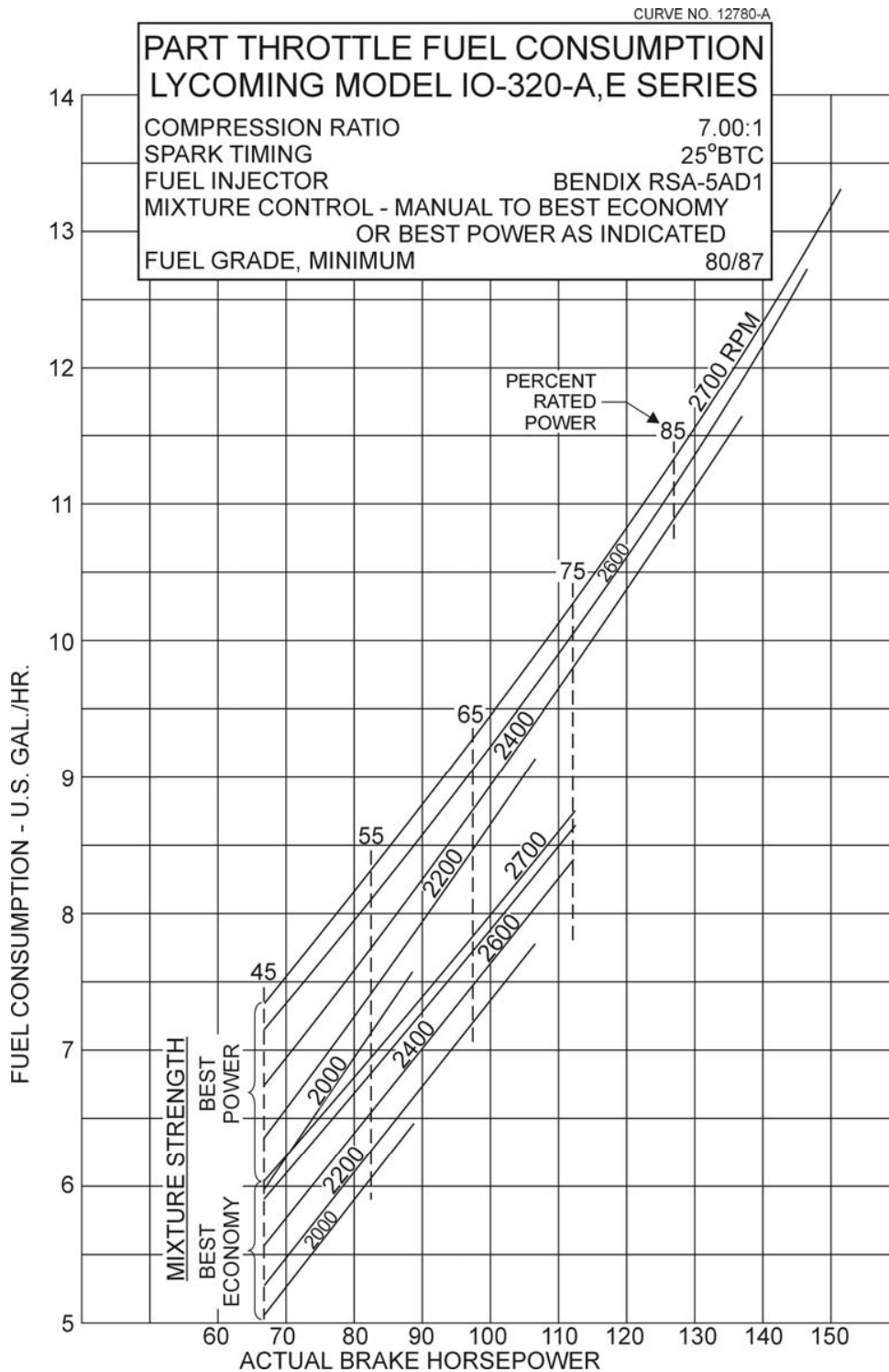

Figure 3-2. Part Throttle Fuel Consumption –
IO-320-A, -E Series

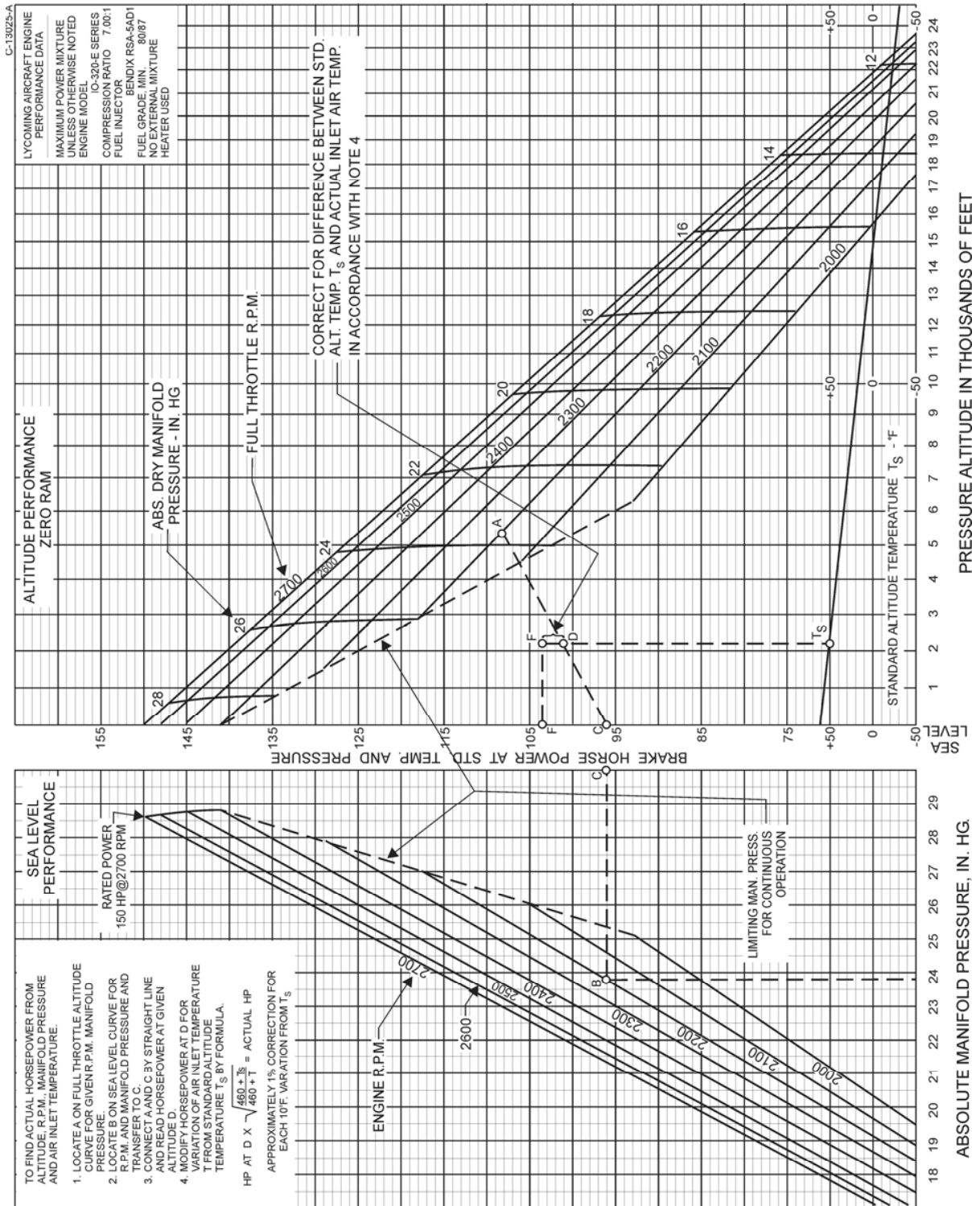

Figure 3-4. Sea Level and Altitude Performance – IO-320-E Series

PART THROTTLE FUEL CONSUMPTION
LYCOMING MODEL IO-320-B,-D SERIES

COMPRESSION RATIO 8.5:1
 SPARK TIMING 25°BTC
 FUEL INJECTOR BENDIX RSA-5AD1
 MIXTURE CONTROL - MANUAL TO BEST POWER OR BEST ECONOMY AS INDICATED
 FUEL GRADE, MINIMUM 91/96

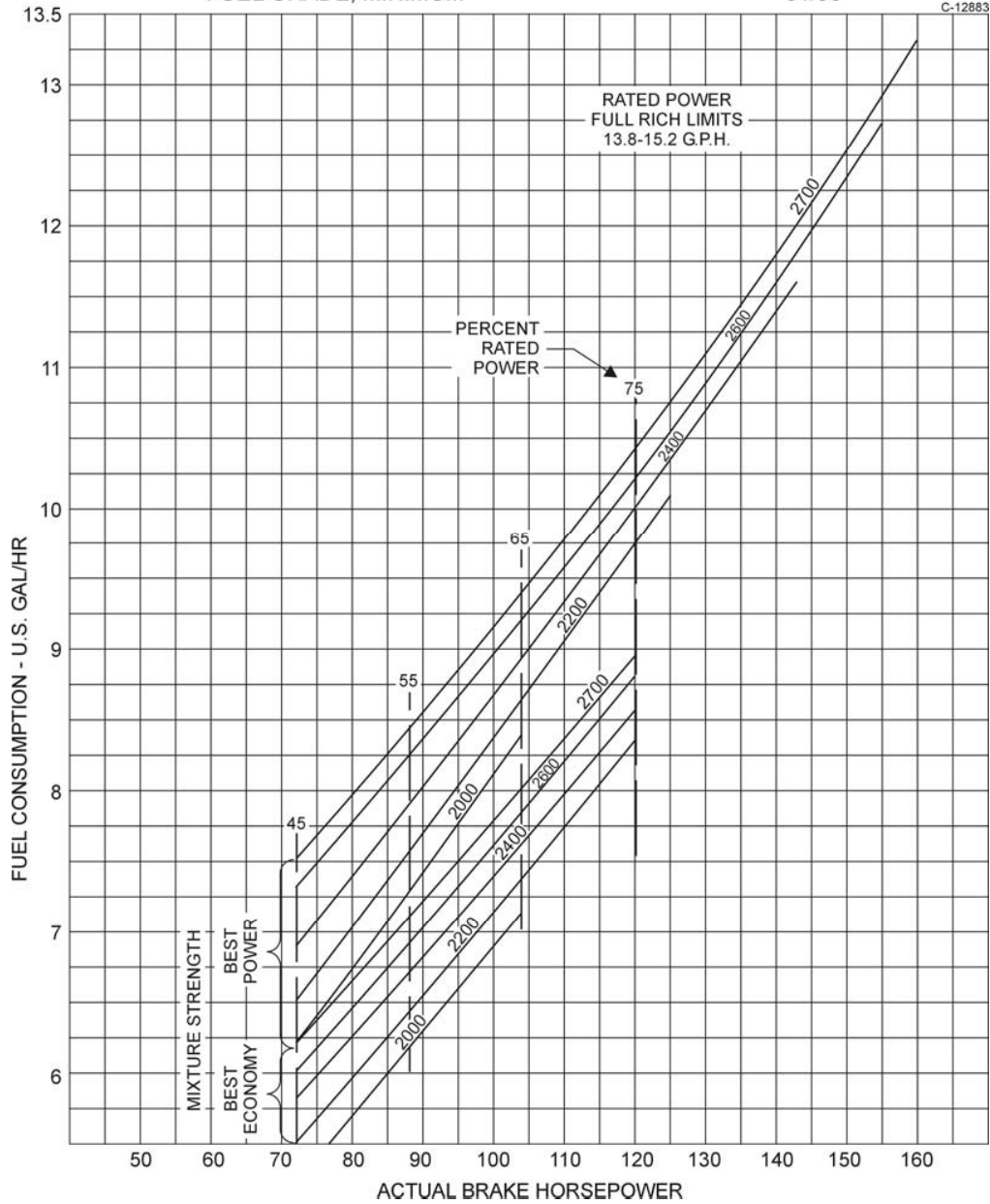

Figure 3-5. Part Throttle Fuel Consumption –
IO-320-B, -D Series; AIO-320; LIO-320-B

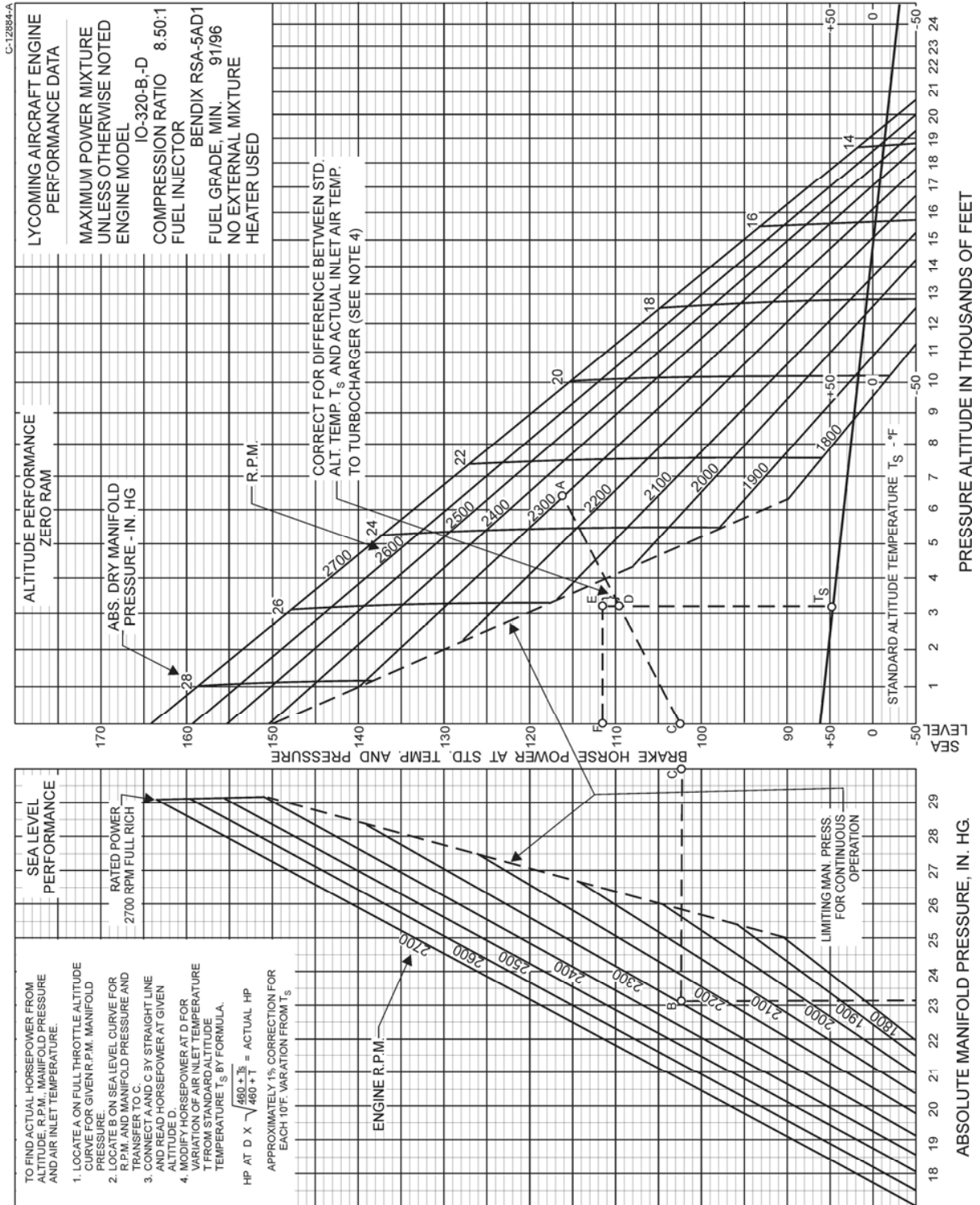

Figure 3-6. Sea Level and Altitude Performance – IO-320-B, -D; AIO-320; LIO-320

PART THROTTLE FUEL CONSUMPTION
LYCOMING MODEL IO-320-C SERIES

COMPRESSION RATIO 8.5:1
 SPARK TIMING 25°BTC
 FUEL INJECTOR BENDIX RSA-5AD1
 MIXTURE CONTROL - MANUAL TO BEST POWER OR BEST ECONOMY AS INDICATED
 FUEL GRADE, MINIMUM 100/130

C-12999

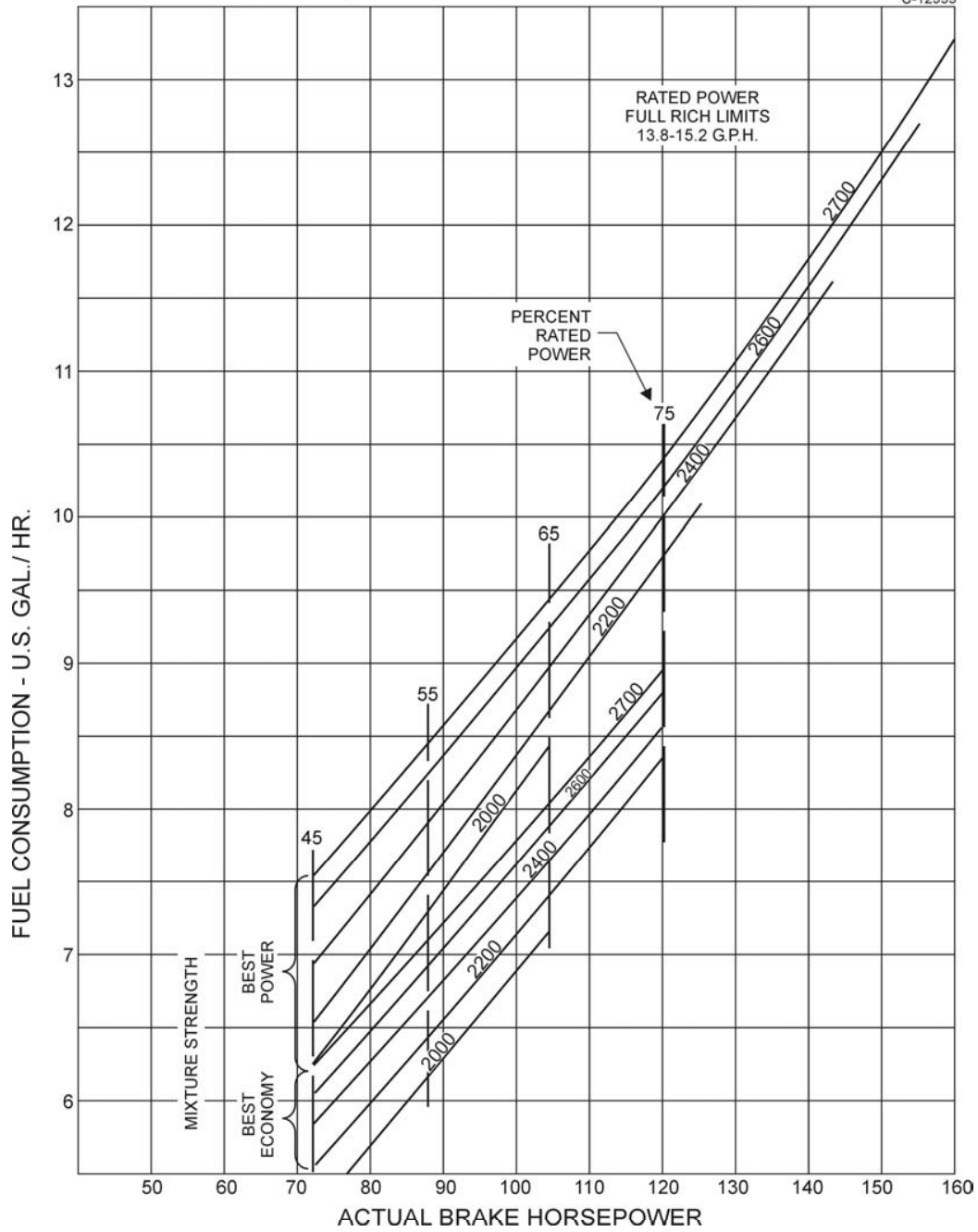

Figure 3-7. Part Throttle Fuel Consumption –
IO-320-C Series; LIO-320-C

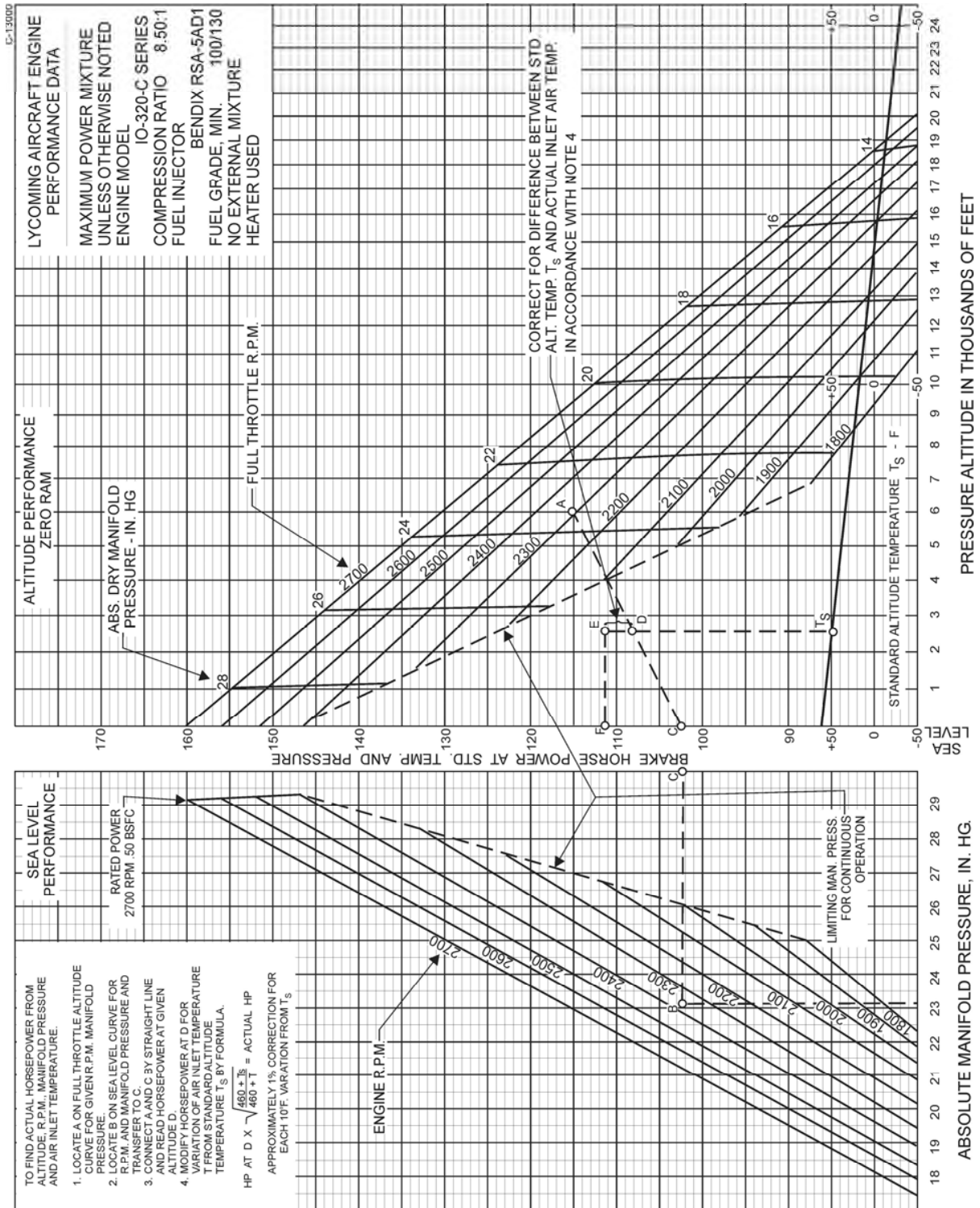

Figure 3-8. Sea Level and Altitude Performance – IO-320-C Series; LIO-320-C

This Page Intentionally Left Blank.

LYCOMING OPERATOR'S MANUAL

**SECTION 4
PERIODIC INSPECTIONS**

	Page
General.....	4-1
Pre-Starting Inspection	4-1
Daily Pre-Flight.....	4-2
25-Hour Inspection	4-2
50-Hour Inspection	4-2
100-Hour Inspection	4-3
400-Hour Inspection	4-4
Non-Scheduled Inspection.....	4-4

This Page Intentionally Left Blank.

**SECTION 4
PERIODIC INSPECTIONS**

NOTE

Perhaps no other factor is quite so important to safety and durability of the aircraft and its components as faithful and diligent attention to regular checks for minor troubles and prompt repair when they are found.

The operator should bear in mind that the items listed in the following pages do not constitute a complete aircraft inspection, but are meant for the engine only. Consult the airframe manufacturer's handbook for additional instructions.

Pre-Starting Inspection – The daily pre-flight inspection is a check of the aircraft prior to the first flight of the day. This inspection is to determine the general condition of the aircraft and engine.

The importance of proper pre-flight inspection cannot be over emphasized. Statistics prove several hundred accidents occur yearly directly responsible to poor pre-flight inspection.

Among the major causes of poor pre-flight inspection are lack of concentration, reluctance to acknowledge the need for a check list, carelessness bred by familiarity and haste.

SECTION 4
PERIODIC INSPECTIONS

LYCOMING OPERATOR'S MANUAL
IO-320 SERIES

1. DAILY PRE-FLIGHT.

- a. Be sure all switches are in the "Off" position.
- b. Be sure magneto ground wires are connected.
- c. Check oil level.
- d. See that fuel tanks are full.
- e. Check fuel and oil connections, note minor indications for repair at 50-hour inspection. Repair any major leaks before aircraft is flown.
- f. Open the fuel drain to remove any accumulation of water and sediment.
- g. Make sure all shields and cowling are in place and secure. If any are missing or damaged, repair or replacement should be made before the aircraft is flown.
- h. Check controls for general condition, travel and freedom of operation.
- i. Induction system air filter should be inspected and serviced in accordance with the airframe manufacturer's recommendations.

2. 25-HOUR INSPECTION. After the first twenty-five hours operating time, new, rebuilt, or newly overhauled engines should undergo a 50-hour inspection including draining and renewing lubricating oil. Engines equipped with oil pressure screen are required to comply with the following inspection after every 25 hours of operating time.

a. Lubrication System (Engines Equipped with Oil Pressure Screen)-

- (1) Remove oil suction and oil pressure screens and check carefully for presence of metal particles that are indicative of internal engine damage. Clean and reinstall the oil suction and oil pressure screens. Drain and renew the lubricating oil.

NOTE

Change the oil at least every four (4) months even if the engine has not accumulated 25 hours since the last oil change.

3. 50-HOUR INSPECTION. In addition to the items listed for daily pre-flight inspection, the following maintenance checks should be made after every 50 hours of operation.

a. Ignition System –

- (1) If fouling of spark plugs has been apparent, rotate bottom plugs to upper position.
- (2) Examine spark plug leads of cable and ceramics for corrosion and deposits. This condition is evidence of either leaking spark plugs, improper cleaning of the spark plug walls or connector ends. Where this condition is found, clean the cable ends, spark plug walls and ceramics with a dry, clean cloth or a clean cloth moistened with methyl-ethyl-ketone. All parts should be clean and dry before reassembly.

- (3) Check ignition harness for security of mounting clamps and be sure connections are tight at spark plug and magneto terminals.
- b. Fuel and Induction System* – Check the primer lines (where applicable) for leaks and security of the clamps. Remove and clean the fuel inlet strainers. Check the mixture control and throttle linkage for travel, freedom of movement, security of the clamps and lubricate if necessary. Check the air intake ducts for leaks, security, filter damage; evidence of dust or other solid material in the ducts is indicative of inadequate filter care or damaged filter. Check vent lines for evidence of fuel or oil seepage; if present, fuel pump may require replacement.
- c. Lubrication System (Engines Equipped with an External Full Flow Oil Filter)* –
 - (1) Remove oil suction and oil pressure screens and check carefully for presence of metal particles that are indicative of internal engine damage.
 - (2) Replace external full flow oil filter element. Drain and renew lubricating oil.

NOTE

Change the oil at least every four (4) months event if the engine has not accumulated 50 hours since the last oil change.

- (3) Check oil leaks, particularly at connections for security of anchorage and for wear due to rubbing or vibration, for dents and cracks.
- d. Exhaust System* – Check attaching flanges at exhaust ports on cylinder for evidence of leakage. If they are loose, they must be removed and machined flat before they are reassembled and tightened. Examine exhaust manifolds for general condition.
- e. Cooling System* – Check cowling and baffles for damage and secure anchorage. Any damaged or missing part of the cooling system must be repaired or replaced before the aircraft resumes operation.
- f. Cylinders* – Check rocker box covers for evidence of oil leaks. If found, replace gasket and tighten screws to specified torque (50 inch lbs.).

Check cylinders for evidence of excessive heat which is indicated by burned paint on the cylinder. This condition is indicative of internal damage to the cylinder and, if found, its cause must be determined and corrected before the aircraft resumes operation.

4. 100-HOUR INSPECTION. In addition to the items listed for daily pre-flight and 50-hour inspection, the following maintenance checks should be made after every one hundred hours of operation.

- a. Electrical System* –
 - (1) Check all wiring connected to the engine or accessories. Any shielded cables that are damaged should be replaced. Replace clamps or loose wires and check terminals for security and cleanliness.
 - (2) Remove spark plugs; test, clean and regap. Replace if necessary.

SECTION 4
PERIODIC INSPECTIONS

LYCOMING OPERATOR'S MANUAL
IO-320 SERIES

- b. Magnetos* – Check breaker points for pitting and minimum gap. Check for excessive oil in the breaker compartment, if found, wipe dry with a clean lint free cloth. The felt located at the breaker points should be lubricated in accordance with the magneto manufacturer's instructions. Check magneto to engine timing. Timing procedure is described in Section 5, 1, b of this manual.
- c. Engine Accessories* – Engine mounted accessories such as pumps, temperature and pressure sensing units should be checked for secure mounting, tight connections.
- d. Cylinders* – Check cylinders visually for cracked or broken fins.
- e. Engine Mounts* – Check engine mounting bolts and bushings for security and excessive wear. Replace any bushings that are excessively worn.
- f. Fuel Injector Nozzles and Fuel Lines* – Check fuel injector nozzles for looseness. Tighten to 60 inch pounds torque. Check fuel lines for fuel stains which are indicative of fuel leaks. Repair or replacement must be accomplished before the aircraft resumes operation.

5. 400-HOUR INSPECTION – In addition to the items listed for daily pre-flight, 50-hour and 100-hour inspections, the following maintenance check should be made after every 400 hours of operation.

Valve Inspection – Remove rocker box covers and check for freedom of valve rockers when valves are closed. Look for evidence of abnormal wear or broken parts in the area of the valve tips, valve keeper, springs and spring seats. If any indications are found, the cylinder and all of its components should be removed (including the piston and connecting rod assembly) and inspected for further damage. Replace any parts that do not conform with limits shown in the latest revision of Special Service Publication No. SSP-1776.

6 NON-SCHEDULED INSPECTIONS. Occasionally, service bulletins or service instructions are issued by Lycoming Engines that require inspection procedures that are not listed in this manual. Such publications, usually are limited to specified engine models and become obsolete after corrective modification has been accomplished. All such publications are available from Lycoming distributors, or from the factory by subscription. Consult the latest revision of Service Letter No. L114 for subscription information. Maintenance facilities should have an up-to-date file of these publications available at all times.

LYCOMING OPERATOR'S MANUAL

SECTION 5 MAINTENANCE PROCEDURES

	Page
General.....	5-1
Ignition and Electrical System	
Ignition Harness and Wire Replacement.....	5-1
Timing Magneto to Engine	
Bendix Magneto	5-1
Slick Magneto	5-1
Fuel System	
Repair of Fuel Leaks.....	5-4
Fuel Injector Fuel Inlet Screen Assembly.....	5-4
Fuel Grade and Limitations	5-5
Air Intake Ducts and Filter	5-5
Idle Speed and Mixture Adjustment	5-5
Lubrication System	
Oil Grades and Limitations.....	5-5
Oil Suction and Oil Pressure Screens	5-6
Oil Pressure Relief Valve.....	5-6
Cylinders.....	5-6
Generator or Alternator Belt Tension	5-10

This Page Intentionally Left Blank.

SECTION 5

MAINTENANCE PROCEDURES

The procedures described in this section are provided to guide and instruct personnel in performing such maintenance operations that may be required in conjunction with the periodic inspections listed in the preceding section. No attempt is made to include repair and replacement operations that will be found in the applicable Lycoming Overhaul Manual.

1. IGNITION AND ELECTRICAL SYSTEM.

- a. *Ignition Harness and Wire Replacement* – In the event that an ignition harness or an individual lead is to be replaced, consult the wiring diagram to be sure harness is correctly installed. Mark location of clamps and clips to be certain the replacement is clamped at correct locations.
- b. *Timing Magnetos to Engine* – Although several combinations of magnetos are used on this series engine, (see Table of Models for model application) the timing procedures, with the exception of the method of turning the magnetos to the correct breaker position, are the same for all magnetos.

NOTE

Either the impulse coupling or retard breaker magneto (whichever is applicable) is installed on the left side of the engine.

- (1) Remove a spark plug from No. 1 cylinder and place a thumb over the spark plug hole. Rotate the crankshaft in direction of normal rotation until the compression stroke is reached, this is indicated by a positive pressure inside the cylinder tending to push the thumb off the spark plug hole. Continue rotating the crankshaft until the advance timing mark on the front face of the starter ring gear is in exact alignment with the small hole located at the two o'clock position on the front face of the starter housing. (Starter ring gear may be marked at 20° and 25°. Consult engine specifications or nameplate for correct timing mark of your installation.)

NOTE

If the crankshaft is accidentally turned in the direction opposite normal rotation, repeat the above procedure as accumulated backlash will make the final timing incorrect.

- (2) At this point, the engine is ready for assembly of the magnetos.
 - (a) *Bendix Magnetos* – Remove the inspection plugs from both magnetos and turn the drive shaft in direction of normal rotation until the first painted chamfered tooth on the distributor gear is aligned in the center of the inspection window.
 - (b) *Slick Magnetos* – Remove the bottom vent plugs and “spark out” the magnetos. This is accomplished in the following manner.

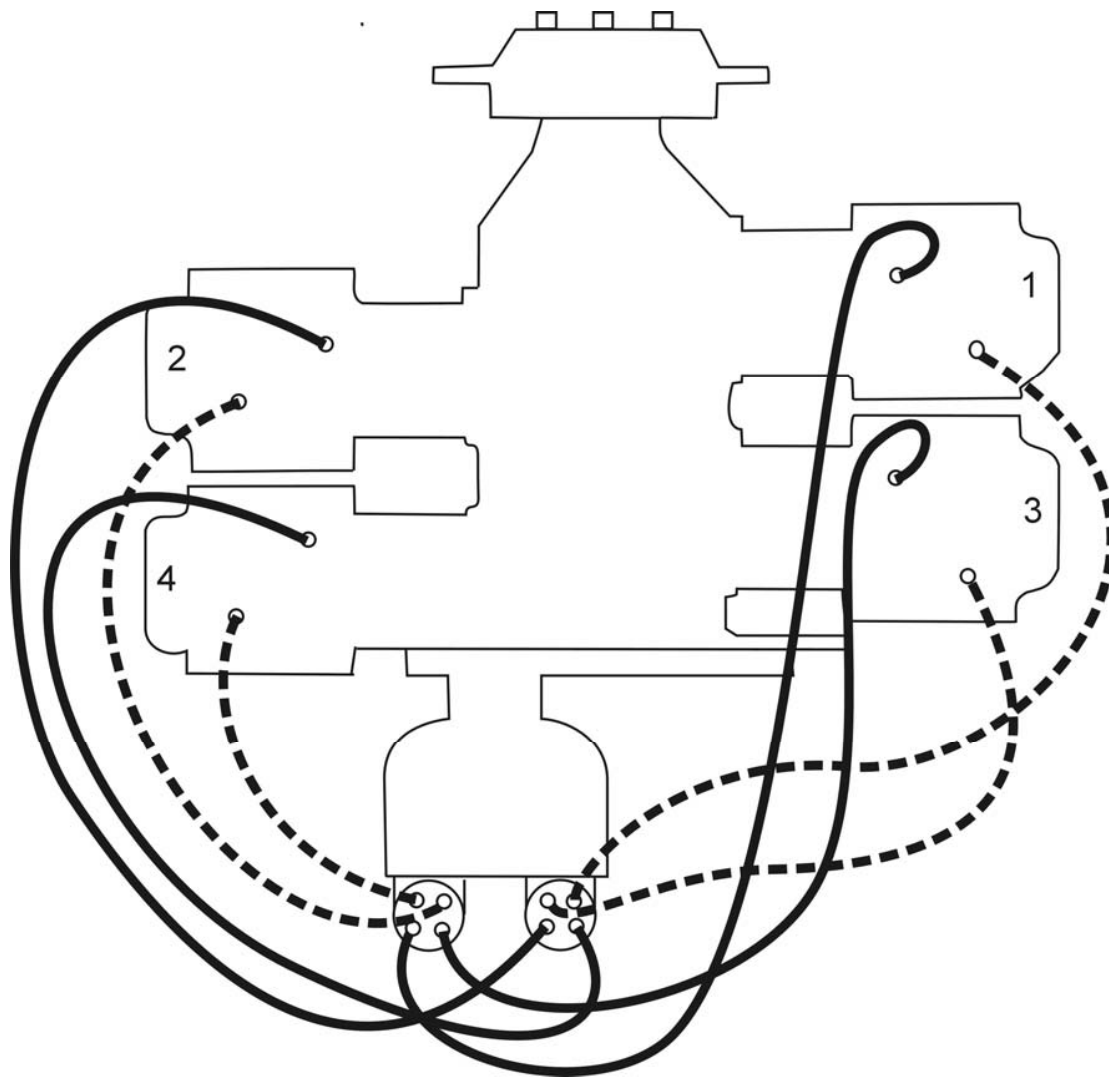

FIRING ORDER
MAGNETO – Left Hand Rotation – 1-3-2-4
MAGNETO – Right Hand Rotation – 1-4-2-3

Figure 5-1 Ignition Wiring Diagram

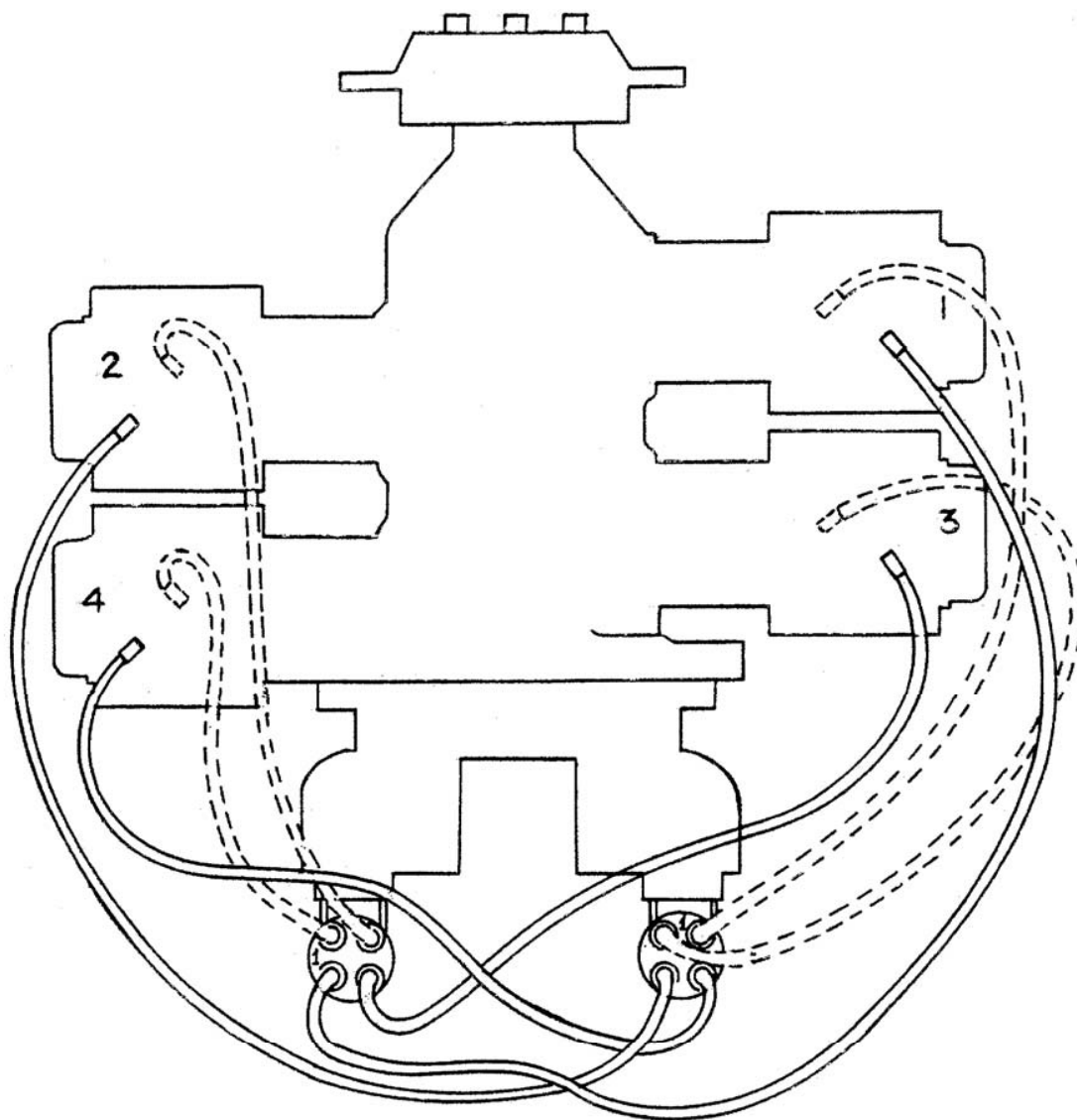

FIRING ORDER
MAGNETO – Left Hand Rotation – 1-3-2-4
MAGNETO – Right Hand Rotation – 1-4-2-3

Figure 5-2. Ignition Wiring Diagram (Optional)

Impulse Coupling Magneto – Hold the T1 or B1 lead wire spring 1/16 in. to 1/8 in. away from the magneto frame and turn the impulse coupling one click at a time until a strong spark jumps between the spring and the frame. Hold the magneto firmly so the coupling will not move beyond the point where it trips and the spark occurs. Reverse the rotation approximately 25° until the timing pin hole appears in the center of the vent plug hole. Hold the rotor by inserting the timing pin and line the timing pin with the center of the vent plug hole.

Conventional Magneto – Hold the B1 head wire spring 1/8 in. away from the frame. Turn the gear counterclockwise vigorously through the flux lines until a strong spark occurs at the lead. Reverse the rotation into the flux until the timing pin hole appears in the center of the vent plughole and insert the timing pin into the hole.

- (3) Being sure that the gear does not move from this position, install gaskets and magnetos on the engine. Secure with washers and nuts; tighten only finger tight.

NOTE

In order to turn the shaft on an impulse coupling magneto, depress the pawl on the impulse coupling with the finger.

- (4) Using a battery powered timing light, attach the positive lead to a suitable terminal connected to the ground terminal of the magneto and the negative lead to any unpainted portion of the engine. Rotate the magneto in its mounting flange to a point where the light comes on, then slowly turn it in the opposite direction until the light goes out. Bring the magneto back slowly until the light just comes on. Repeat this with the second magneto.

NOTE

Some timing lights operate in the reverse manner as described above, the light comes on when the breaker points open. Check your timing light instructions.

- (5) After both magnetos have been timed to the engine, check, as described below, to ascertain that both magnetos are set to fire together.
 - (6) Back off the crankshaft a few degrees, the timing lights should go out. Bring the crankshaft slowly back in direction of normal rotation until the timing mark and the hole in the starter housing are in alignment. At this point, both lights should go on simultaneously. Tighten nuts to specified torque.
- c. *Generator or Alternator Output* – The generator or alternator (whichever is applicable) should be checked to determine that the specified voltage and current are being obtained.

2. FUEL SYSTEM.

- a. *Repair of Fuel Leaks* – In the event a line or fitting in the fuel system is replaced, only a fuel-soluble lubricant, such as clean engine oil or Loctite Hydraulic Sealant, may be used on the threads. Any other thread lubricant or compound must not be used.
- b. *Fuel Injector Fuel Inlet Screen Assembly* – Remove the assembly and check the screen for distortion or openings in the strainer. Replace for either of these conditions. Clean screen assembly in solvent and dry with compressed air and reinstall. The fuel inlet screen assembly is tightened to 65-70 inch pounds on fuel injectors.

- c. *Fuel Grades and Limitations* – The recommended aviation grade fuel for the subject engines is listed in Section 3, Item 9.

In the event that the specified fuel is not available at some locations, it is permissible to use higher octane fuel. Fuel of a lower octane than specified is not to be used. Under no circumstances should automotive fuel be used (regardless of octane rating).

NOTE

It is recommended that personnel be familiar with latest revision of Service Instruction No. 1070 regarding specified fuel for Lycoming engines.

- d. *Air Intake Ducts and Filter* – Check all air intake ducts for dirt or restrictions. Inspect and service air filters as instructed in the airframe manufacturer's handbook.

- e. *Idle Speed and Mixture Adjustment* –

- (1) Start the engine and warm up in the usual manner until oil and cylinder head temperatures are normal.
- (2) Check magnetos. If the "mag-drop" is normal, proceed with idle adjustment.
- (3) Set throttle stop screw so that the engine idles at the airframe manufacturer's recommended idling RPM. If the RPM changes appreciably after making idle mixture adjustment during the succeeding steps, readjust the idle speed to the desired RPM.
- (4) When the idling speed has been stabilized, move the cockpit mixture control lever with a smooth, steady pull toward the "Idle Cut-Off" position and observe the tachometer for any change during the leaning process. Caution must be exercised to return the mixture control to the "Full Rich" position before the RPM can drop to a point where the engine cuts out. An increase of more than 50 RPM while "leaning out" indicates an excessively rich idle mixture. An immediate decrease in RPM (if not preceded by a momentary increase) indicates the idle mixture is too lean.

If step (4) indicates that the idle adjustment is too rich or too lean, turn the idle mixture adjustment in direction required for correction, and check this new position by repeating the above procedure. Make additional adjustments as necessary until a check results in a momentary pick-up of approximately 50 RPM. Each time the adjustment is changed, the engine should be run up to 2000 RPM to clean the engine before proceeding with the RPM check. Make final adjustment of the idle speed adjustment to obtain the desired idling RPM with closed throttle. The above method aims at a setting that will obtain maximum RPM with minimum manifold pressure. In case the setting does not remain stable, check the idle linkage; any looseness in this linkage would cause erratic idling. In all cases, allowance should be made for the effect of weather conditions and field altitude upon idling adjustment.

3. LUBRICATION SYSTEM.

- a. *Oil Grades and Limitations* – Service the engine in accordance with the recommended grade oil as specified in Section 3, Item 8.

- b. *Oil Suction and Oil Pressure Screens* – At each 25-hour inspection remove, inspect for metal particles, clean and reinstall, not to exceed four (4) months between oil changes.

NOTE

On installations employing full flow oil filters, this step is not practical at this time, but should be observed at the 50-hour inspection, not to exceed four (4) months between oil changes.

- (1) *Non-Adjustable Oil Pressure Relief Valve* – The function of the oil pressure relief valve is to maintain engine oil pressure within specified limits. The valve, although not adjustable, may be controlled by the addition of a maximum of nine (9) P/N STD-425 washers under the cap to increase the pressure or the use of a spacer (Lycoming P/N 73629 or 73630) to decrease pressure. A modification on later models has eliminated the need for the spacers. Particles of metal or other foreign matter lodged between the ball and seat will result in faulty readings. It is advisable, therefore, to disassemble, inspect and clean the valve if excessive pressure fluctuations are noted.
- (2) *Oil Pressure Relief Valve (Adjustable)* – The adjustable oil relief valve enables the operator to maintain engine oil pressure within the specified limits. If the pressure under normal operating conditions should consistently exceed the maximum or minimum specified limits, adjust the valve as follows:

With the engine warmed up and running approximately 2000 RPM, observe the reading on the oil pressure gage. If the pressure is above maximum or below minimum specified limits, stop engine and screw the adjusting screw outward to decrease pressure or inward to increase pressure. Depending on installation, the adjusting screw may have only a screw driver slot and is turned with a screw driver; or may have the screw driver slot plus a pinned .375-24 castellated nut and may be turned with either a screw driver or a box wrench.

4. **CYLINDERS.** It is recommended that as a field operation, cylinder maintenance be confined to replacement of the entire assembly. For valve replacement, consult the proper overhaul manual. This should be undertaken only as an emergency measure.

a. *Removal of Cylinder Assembly.*

- (1) Remove exhaust manifold.
- (2) Remove rocker box drain tube, intake pipe, baffle and any clips that might interfere with the removal of the cylinder.
- (3) Disconnect ignition cables and remove the bottom spark plug.
- (4) Remove rocker box cover and rotate crankshaft until piston is approximately at top center of the compression stroke. This approximate position may be located by observing top of piston through the spark plug hole and also watching the valve action.

- (5) Slide valve rocker shafts from cylinder head and remove the valve rockers. Valve rocker shafts can be removed when the cylinder is removed from the engine. Remove rotator cap from exhaust valve stem.
- (6) Remove push rods by grasping ball end and pulling rod out of shroud tube. Detach shroud tube spring and lock plate and pull shroud tubes through holes in cylinder head.

NOTE

The hydraulic tappets, push rods, rocker arms and valves must be assembled in the same location from which they were removed.

- (7) Remove cylinder base nuts and hold down plates (where employed) then remove cylinder by pulling directly away from crankcase. Be careful not to allow the piston to drop against the crankcase, as the piston leaves the cylinder.
- b. Removal of Valves and Valve Springs from Cylinder* – Place the cylinder over a block of wood so as to hold the valves in a closed position. Compress the valve springs using the valve spring compressor. Remove the split keys from the end of the valve stem. The valve springs and valve spring seats may now be removed from the cylinder head. Hold the valve stems so that the valves will not fall out and remove the cylinder from the holding block. The valves may now be removed from the inside of the cylinder.
 - c. Removal of Piston from Connecting Rod* – Remove the piston pin plugs. Insert piston pin puller through piston pin, assemble puller nut; then proceed to remove piston pin. Do not allow connecting rod to rest on the cylinder bore of the crankcase. Support the connecting rod with heavy rubber band, discarded cylinder base oil ring seal, or any other non-marring method.
 - d. Removal of Hydraulic Tappet Sockets and Plunger Assemblies* – It will be necessary to remove and bleed the hydraulic tappet plunger assembly so that dry tappet clearance can be checked when the cylinder assembly is reinstalled. This is accomplished in the following manner:
 - (1) Remove the hydraulic tappet push rod socket by inserting the forefinger into the concave end of the socket and withdrawing. The sock will usually stick to the finger firmly enough to be pulled out of the tappet body. If the socket cannot be removed in this manner, it may be removed by grasping the edge of the socket with a pair of needle nose pliers. However, care must be exercised to avoid scratching the socket.
 - (2) To remove the hydraulic tappet plunger assembly, use the special Lycoming service tool. In the event the tool is not available, the hydraulic tappet plunger assembly may be removed by a hook in the end of a short piece of lockwire, inserting the lockwire so that the hook engages the spring of the plunger assembly. Draw the plunger assembly out of the tappet body by gently pulling the wire.

CAUTION

NEVER USE A MAGNET TO REMOVE HYDRAULIC PLUNGER ASSEMBLIES FROM THE CRANKCASE. THIS CAN CAUSE THE CHECK BALL TO REMAIN OFF ITS SEAT, RENDERING THE UNIT INOPERATIVE.

SECTION 5
MAINTENANCE PROCEDURES

LYCOMING OPERATOR'S MANUAL
IO-320 SERIES

- e. *Assembly of Hydraulic Tappet Plunger Assemblies* – To assemble the unit, unseat the ball by inserting a thin clean bronze wire through the oil inlet hole. With the ball off its seat, insert the plunger and twist clockwise so that the spring catches.
- f. *Assembly of Valves in Cylinder* – Prelubricate valve stems with Molytex Grease O or equivalent and insert each valve stem in its respective valve guide. Place cylinder over a block of wood so that the valves are held against the seats and assemble the lower valve spring seat, auxiliary valve spring and outer valve spring over the valve stem and guide. Place the upper valve spring seat on top of the springs.

NOTE

When installing valve springs, place the dampened end of spring (close wound coils marked with dye or lacquer) toward the cylinder.

Using a valve spring compressor, compress the valve springs and place the split keys in the groove around the upper end of the valve stem. Slowly release the pressure on the valve spring compressor and allow the upper spring seat to lock itself in place around the valve keys.

- d. *Assembly of Cylinder and Related Parts* – Rotate the crankshaft so that the connecting rod of the cylinder being assembled is at the top center position that corresponds with both valves closed.
 - (1) Place each plunger assembly in its respective tappet body and assemble the socket on top of plunger assembly.
 - (2) Assemble piston with rings so that the cylinder number stamped on the piston pin boss is toward the front of the engine. The piston pin should be a hand push fit. If difficulty is experienced in inserting the piston pin, it is probably caused by carbon or burrs in the piston pin hole. During assembly, always use a generous quantity of oil, both in the piston hole and on the piston pin.
 - (3) Assemble one piston pin plug at each end of the piston pin and place a new rubber oil seal ring around the cylinder skirt. Coat piston and rings and the inside of the cylinder generously with oil.
 - (4) Using a piston ring compressor, assemble the cylinder over the piston so that the intake and exhaust ports are at the bottom of the engine. Push the cylinder all the way on, catching the ring compressor as it is pushed off.

NOTE

Before installing cylinder hold-down nuts, lubricate crankcase thru-stud threads with any one of the following lubricants, or combination of lubricants.

- 1. 90% SAE 50W engine oil and 10% STP.
 - 2. Parker Thread Lube.
 - 3. 60% SAE 30W engine oil and 40% Parker Thread Lube.
- (5) Assemble hold-down plates (where applicable) and cylinder base hold-down nuts and tighten as directed in the following steps.

NOTE

At any time a cylinder is replaced, it is necessary to retorque the thru-studs on the cylinder on the opposite side of the engine.

- (a) *Engines Using Hold-Down Plates* – Install shims between cylinder base hold-down plates and cylinder barrel, as directed in Figure 5-3, and tighten $\frac{1}{2}$ inch hold-down nuts to 300 in.-lbs. (25 ft.-lbs.) torque, using the sequence shown in Figure 5-3.
- (b) Remove shims, and using the same sequence, tighten the $\frac{1}{2}$ inch cylinder base nuts to 600 in.-lbs. (50 ft.-lbs.) torque.

NOTE

Cylinder assemblies not using hold-down plate are tightened in the same manner as above omitting the shims.

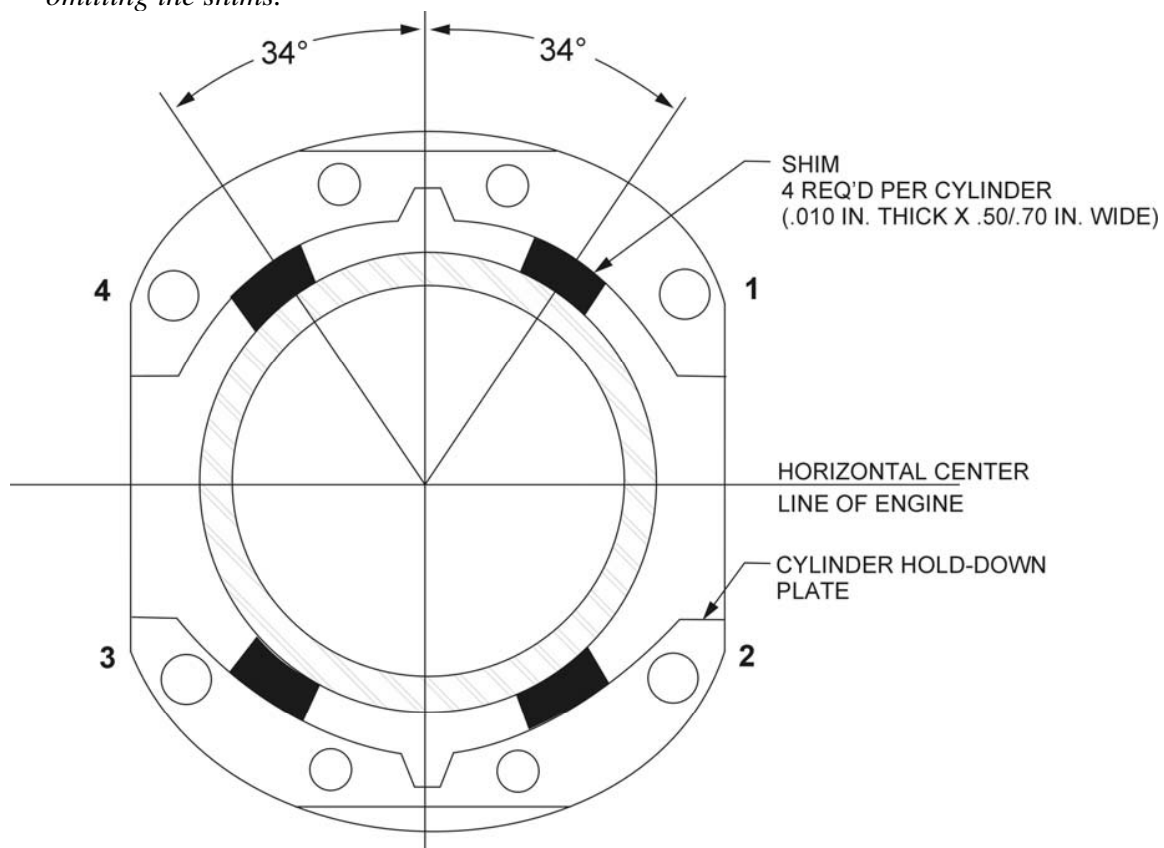

INSTRUCTIONS - ON ENGINES USING CYLINDER HOLD-DOWN PLATES, DURING INITIAL TIGHTENING, USE TWO SHIMS BETWEEN EACH PLATE AND THE BARREL, LOCATED AS SHOWN. REMOVE SHIMS BEFORE FINAL TIGHTENING

Figure 5-3. Location of Shims Between Cylinder Barrel and Hold-Down Plates (where applicable) and Sequence of Tightening Cylinder Base Hold-Down Nuts

- (c) Tighten the $\frac{3}{8}$ inch hold-down nuts to 300 in.-lbs. (25 ft.-lbs.) torque. Sequence of tightening is optional.
- (d) As a final check, hold the torque wrench on each nut for about five seconds. If the nut does not turn, it may be presumed to be tightened to correct torque.

CAUTION

AFTER ALL CYLINDER BASE NUTS HAVE BEEN TIGHTENED, REMOVE ANY NICKS IN THE CYLINDER FINS BY FILING OR BURRING.

- (6) Install a new shroud tube oil seal on the crankcase end of each shroud tube and fit a new annular ring in the groove provided in the rocker box and of each shroud tube. Install each shroud tube through rocker box and seat the end firmly in the crankcase. Place a spacer, two springs, a lock plate and nut over the stud provided in the rocker box and secure both shroud tubes in place. Bend the tang of the lock plate to prevent the nut and spring from loosening.
- (7) Assemble each push rod in its respective shroud tube, and assemble each rocker in its respective position by placing rocker between bosses and sliding valve rocker shaft in place to retain rocker. Before installing exhaust valve rocker, place rotator cap over end of exhaust valve stem.
- (8) Be sure that the piston is at top center of compression stroke and that both valves are closed. Check clearance between the valve stem tip and the valve rocker. In order to check this clearance, place the thumb of one hand on the valve rocker directly over the end of the push rod and push down so as to compress the hydraulic tappet spring. While holding the spring compressed, the valve clearance should be between .028 and .080 inch. If clearance does not come within these limits, remove the push rod and insert a longer or shorter push rod, as required, to correct clearance.

NOTE

Inserting a longer push rod will decrease the valve clearance.

- (9) Install intercylinder baffles, rocker box covers, intake pipes, rocker box drain tubes and exhaust manifold.

5. GENERATOR OR ALTERNATOR DRIVE BELT TENSION.

Check the tension of a new belt 25 hours after installation. Refer to latest revision of Service Instruction No. 1129 for methods of checking generator or alternator drive belt tension.

LYCOMING OPERATOR'S MANUAL

SECTION 6 TROUBLE-SHOOTING

	Page
Failure of Engine to Start.....	6-1
Failure of Engine to Idle Properly.....	6-2
Low Power and Uneven Running.....	6-2
Failure of Engine to Develop Full Power.....	6-3
Rough Engine.....	6-3
Low Oil Pressure.....	6-3
High Oil Temperature.....	6-3
Excessive Oil Consumption.....	6-4

This Page Intentionally Left Blank.

**SECTION 6
TROUBLE-SHOOTING**

Experience has proven that the best method of trouble-shooting is to decide on the various causes of the given trouble and then to eliminate causes one by one, beginning with the most probable. The following charts list some of the more common troubles, which may be encountered in maintaining engines; their probable causes and remedies.

1. TROUBLE-SHOOTING – ENGINE.

TROUBLE	PROBABLE CAUSE	REMEDY
Failure of Engine to Start	Lack of fuel	Check fuel system for leaks. Fill fuel tank. Clean dirty lines, strainers or fuel valves.
	Overpriming	Leave ignition "off" and mixture control in "Idle Cut-Off", open throttle and "unload" engine by cranking for a few seconds. Turn ignition switch on and proceed to start in a normal manner.
	Defective spark plugs	Clean and adjust or replace spark plugs.
	Defective ignition wire	Check with electric tester, and replace any defective wires.
	Defective battery	Replace with charged battery.
	Improper operation of magneto breaker	Clean points. Check internal timing of magnetos.
	Lack of sufficient fuel flow	Disconnect fuel line and check fuel flow.
	Water in fuel injector	Drain fuel injector and fuel lines.
	Internal failure	Check oil screens for metal particles. If found, complete overhaul of the engine may be indicated.

**SECTION 6
TROUBLE-SHOOTING**

**LYCOMING OPERATOR'S MANUAL
IO-320 SERIES**

TROUBLE	PROBABLE CAUSE	REMEDY
Failure of Engine to Idle Properly	Incorrect idle mixture	Adjust mixture.
	Leak in induction system	Tighten all connections in the induction system. Replace any parts that are defective.
	Incorrect idle adjustment	Adjust throttle stop to obtain correct idle.
	Uneven cylinder compression	Check condition of piston rings and valve seats.
	Faulty ignition system	Check entire ignition system.
Low Power and Uneven Running	Insufficient fuel pressure	Adjust fuel pressure.
	Mixture too rich indicated by sluggish operation, red exhaust flame at night. Extreme cases indicated by black smoke from exhaust.	Readjustment of fuel injector by authorized personnel is indicated.
	Mixture too lean; indicated by overheating or backfiring.	Check fuel lines for dirt or other restrictions. Readjustment of fuel injector by authorized personnel is indicated.
	Leaks in induction system	Tighten all connections. Replace defective parts.
	Defective spark plugs	Clean and gap or replace spark plugs.
	Improper fuel	Fill tank with fuel of recommended grade.
	Magneto breaker points not working properly	Clean points. Check internal timing of magnetos.
	Defective ignition wire	Check wire with electric tester. Replace defective wire.
Defective spark plug terminal connectors.	Replace connectors on spark plug wire.	

TROUBLE	PROBABLE CAUSE	REMEDY
Failure of Engine to Develop Full Power	Leak in induction system	Tighten all connections and replace defective parts.
	Throttle lever out of adjustment	Adjust throttle lever.
	Improper fuel flow	Check strainer, gage and flow at the fuel inlet.
	Restriction in air scoop	Examine air scoop and remove restrictions.
	Improper fuel	Drain and refill tank with recommended fuel.
Rough Engine	Faulty ignition	Tighten all connections. Check system with tester. Check ignition timing.
	Cracked engine mount	Replace or repair mount.
	Defective mounting bushings	Install new mounting bushings.
Low Oil Pressure	Uneven compression	Check compression.
	Insufficient oil	Fill to proper level with recommended oil.
	Air lock or dirt in relief valve	Remove and clean oil pressure relief valve.
	Leak in suction line or pressure line	Check gasket between accessory housing and crankcase.
	High oil temperature	See "High Oil Temperature" in "Trouble" column.
	Defective pressure gage	Replace.
	Stoppage in oil pump intake passage	Check line for obstruction. Clean suction strainer.
High Oil Temperature	Insufficient air cooling	Check air inlet and outlet for deformation or obstruction.
	Insufficient oil supply	Fill to proper level with specified oil.

**SECTION 6
TROUBLE-SHOOTING**

**LYCOMING OPERATOR'S MANUAL
IO-320 SERIES**

TROUBLE	PROBABLE CAUSE	REMEDY
High Oil Temperature (Cont.)	Low grade of oil	Replace with oil conforming to specifications.
	Clogged oil lines or strainers	Remove and clean oil strainers.
	Excessive blow-by	Usually caused by worn or stuck rings.
	Failing or failed bearings	Examine sump for metal particles. If found, overhaul of engine is indicated.
	Defective temperature gage	Replace gage.
Excessive Oil Consumption	Low grade of oil	Fill tank with oil conforming to specifications.
	Failing or failed bearings	Check sump for metal particles.
	Worn piston rings	Install new rings.
	Incorrect installation of piston rings	Install new rings.
	Failure of rings to seat (new nitrided cylinders)	Use mineral base oil. Climb to cruise altitude at full power and operate at 75% cruise power setting until oil consumption stabilizes.

LYCOMING OPERATOR'S MANUAL

SECTION 7 INSTALLATION AND STORAGE

	Page
Preparation of Engine for Installation.....	7-1
General.....	7-1
Inspection of Engine Mounting	7-1
Attaching Engine to Mounts	7-1
Oil and Fuel Line Connections	7-1
Propeller Installation.....	7-1
Preparation of Fuel Injectors for Installation.....	7-2

This Page Intentionally Left Blank.

SECTION 7

INSTALLATION AND STORAGE

1. PREPARATION OF ENGINE FOR INSTALLATION. Before installing an engine that has been prepared for storage, remove all dehydrator plugs, bags of desiccant and preservative oil from the engine. Preservative oil can be removed by removing the bottom spark plugs and turning the crankshaft three or four revolutions by hand. The preservative oil will then drain through the spark plug holes. Draining will be facilitated if the engine is tilted from side to side during the above operation. Preservative oil which has accumulated in the sump can be drained by removing the oil sump plug. Engines that have been stored in a cold place should be removed to an environment of at least 70°F (21°C) for a period of 24 hours before preservative oil is drained from the cylinders. If this is not possible, heat the cylinders with heat lamps before attempting to drain the engine.

After the sump has been drained, the plug should be replaced and safety-wired. Fill the sump with lubricating oil. The crankshaft should again be turned several revolutions to saturate the interior of the engine with the clean oil. When installing spark plugs, make sure that they are clean, if not, wash them in clean petroleum solvent. Of course, there will be a small amount of preservative oil remaining in the engine, but this can cause no harm. However, after twenty-five hours of operation, the lubricating oil should be drained while the engine is hot. This will remove any residual preservative oil that may have been present.

CAUTION

DO NOT ROTATE THE CRANKSHAFT OF AN ENGINE CONTAINING PRESERVATIVE OIL BEFORE REMOVING THE SPARK PLUGS, BECAUSE IF THE CYLINDERS CONTAIN ANY APPRECIABLE AMOUNT OF THE MIXTURE, THE RESULTING ACTION, KNOWN AS HYDRAULICING, WILL CAUSE DAMAGE TO THE ENGINE. ALSO, ANY CONTACT OF THE PRESERVATIVE OIL WITH THE PAINTED SURFACES SHOULD BE AVOIDED.

General – Should any of the dehydrator plugs, containing crystals of silica-gel or similar material, be broken during their term of storage or upon their removal from the engine, and if any of the contents should fall into the engine, that portion of the engine must be disassembled and thoroughly cleaned before using the engine. The oil strainers should be removed and cleaned in gasoline or some other hydrocarbon solvent. The fuel drain screen located in the fuel inlet of the fuel injector should also be removed and cleaned in hydrocarbon solvent. The operator should also note if any valves are sticking. If they are, this condition can be eliminated by coating the valve stem generously with a mixture of gasoline and lubricating oil.

Inspection of Engine Mounting – If the aircraft is one from which an engine has been removed, make sure that the engine mount is not bent or damaged by distortion or misalignment as this can produce abnormal stresses within the engine.

Attaching Engine to Mounts – See airframe manufacturer's recommendations for method of mounting the engine.

Oil and Fuel Line Connections – The oil and fuel line connections are called out in the accompanying installation drawings.

Propeller Installation – Consult the airframe manufacturer for information relative to propeller installation.

2. PREPARATION OF FUEL INJECTORS FOR STORAGE.

Fuel injectors that have been prepared for storage should undergo the following procedures before being placed in service.

Remove and clean the fuel inlet strainer assembly and reinstall. Inject clean fuel into the fuel inlet connection with the fuel outlet uncapped until clean fuel flows from the outlets. Do not exceed 15 psi inlet pressure.

3. PREPARATION OF ENGINE FOR STORAGE OR SHIPMENT.

General – The following procedure is intended for application to installed engines, which are being removed from aircraft and will provide protection from corrosion for a period of 30 to 60 days.

Preservation Run – Immediately prior to removal of the engine from the aircraft, the engine should be given a preservation run under the following operating conditions.

Fuel – Normal service fuel

Oil – Fill sump to normal capacity with preservative type lubricating oil (Soconoy's Avrex 901, Esso's "Rust-Ban 626" or equivalent).

Duration of Run – Operate the engine for a period of four minutes, holding the engine speed to a maximum of 1800 RPM. All precautions pertaining to ground running should be carefully observed. Cylinder head, ignition harness, and magneto temperatures should not be allowed to exceed the prescribed limits.

Compound Injection – Upon completion of the preservation run, drain the preservative oil from the engine and remove, clean and replace the oil suction and oil pressure screens. Perform any of the engine checks, such as valve clearance or ignition timing, which require rotation of the crankshaft. Disconnect the ignition harness and remove the spark plugs. Starting with cylinder no. 1, make certain piston is at the bottom of compression stroke. Fill cylinder with preservative oil (use same oil as specified for preservation run) and rotate crankshaft until piston is at top center. Oil will spill out of spark plug hole. In order to preserve the top wall of the cylinder, it will be necessary to either rock the engine, or blow compressed air with very light pressure into the spark plug hole. Following the engine firing order, preserve the remainder of the cylinders in the same manner. When all cylinders have been treated, then spray the exhaust port and valve of each cylinder with the piston ¼ turn before top center on the exhaust stroke. When absolutely certain that no further need exists for turning the crankshaft, again spray each cylinder through the spark plug holes. (Maintain spray nozzle temperature at 200°F to 200°F (93°C to 104°C) for all spraying operations.)

Installation of Seals and Plugs – Install cylinder dehydrator plugs (Lycoming P/N 40238 or equivalent) in spark plug holes. Install ignition cable protectors (Lycoming P/N 40239 or equivalent) over the spark plug terminal of each ignition cable and secure by attaching to the end of the dehydrator plug. Flush all accessory drives for which oil seals are provided with preservative oil before assembling the drive covers. Suitable covers should be used in sealing the exhaust ports; moisture resistant tape (Minnesota Mining and Manufacturing Company, 711 Acetate Fibre Tape or equivalent) will be sufficient for the ground connections and similar openings. Install a plug (Lycoming P/N 1540 or equivalent) in the thermometer well at the rear of the oil pressure screen housing. Install sealing caps (Lycoming P/N 61595 or equivalent) over the breather opening and (Lycoming P/N 61596 or equivalent) over the generator or alternator blast tube. Install tachometer drive cap (Lycoming P/N 61545 or equivalent) over tachometer drive. Make sure all other openings are properly sealed.

Exterior Surfaces – All exposed cadmium plated and machined surfaces should be coated with soft film corrosion preventative compound (E.F. Houghton and Company, Cosmoline 1059 or equivalent). The starter ring gear and propeller mounting surfaces in particular should receive a liberal coating of the compound.

Fuel Injector – Any unit taken out of service, or units being returned for overhaul, must be flushed with preserving oil (Specification MIL-O-6081, Grade 1010), using the following procedure.

Remove plugs and drain all fuel oil from the injector. If available, apply 10 to 15 psi air pressure to the fuel inlet, until all fuel is discharged from the injector.

Replace plugs and apply flushing oil filtered through a 10 micron filter at 13 to 15 psi to the fuel inlet until oil is discharged from the servo line.

Replace fuel inlet plug.

CAUTION

DO NOT EXCEED THE RECOMMENDED AIR PRESSURE AS INTERNAL DAMAGE TO THE INJECTOR MAY RESULT.

After filling with preservative oil the injector should be protected from dust and dirt, and given such protection against moisture as climatic conditions at the point of storage require.

The injector shall be tagged as follows: The fuel chambers and passages of this fuel injector were preserved with oil conforming to Specification MIL-O-6081, Grade 1010. Before using de-preserve in accordance with instructions in operator's manual.

Shipping Case – Upon completion of the preceding steps, the engine should be secured in a suitable engine shipping container. The date of preservation and the following legend should be legibly marked on the side of the container:

“On (Date) the engine was preserved for 60 days short term storage with preservative oil and cylinder and crankcase dehydrator plugs shall be inspected on arrival at destination or 30 days after the above date (whichever occurs sooner) to determine if renewal of the dehydrating agent is necessary.”

4. RECOMMENDED PROCEDURE FOR RE-PRESERVATION. The engine shall be examined every 30 days (or less, depending on weather and locality). If any evidence of corrosion is present, the affected area should be cleaned free of corrosion and the engine re-preserved.

Engines prepared in the preceding manner are not adequately protected for extended periods of storage. If at the end of 60 days, it is found that the engine must remain in storage for an additional period, the engine must be re-preserved according to the foregoing procedure.

NOTE

Inspection and re-preservation will not be the responsibility of the engine manufacturer after engines have been shipped from the engine manufacturer's plant. It shall be the responsibility of the consignee to put engines into service in the order of storage preparation date to reduce the storage period to a minimum

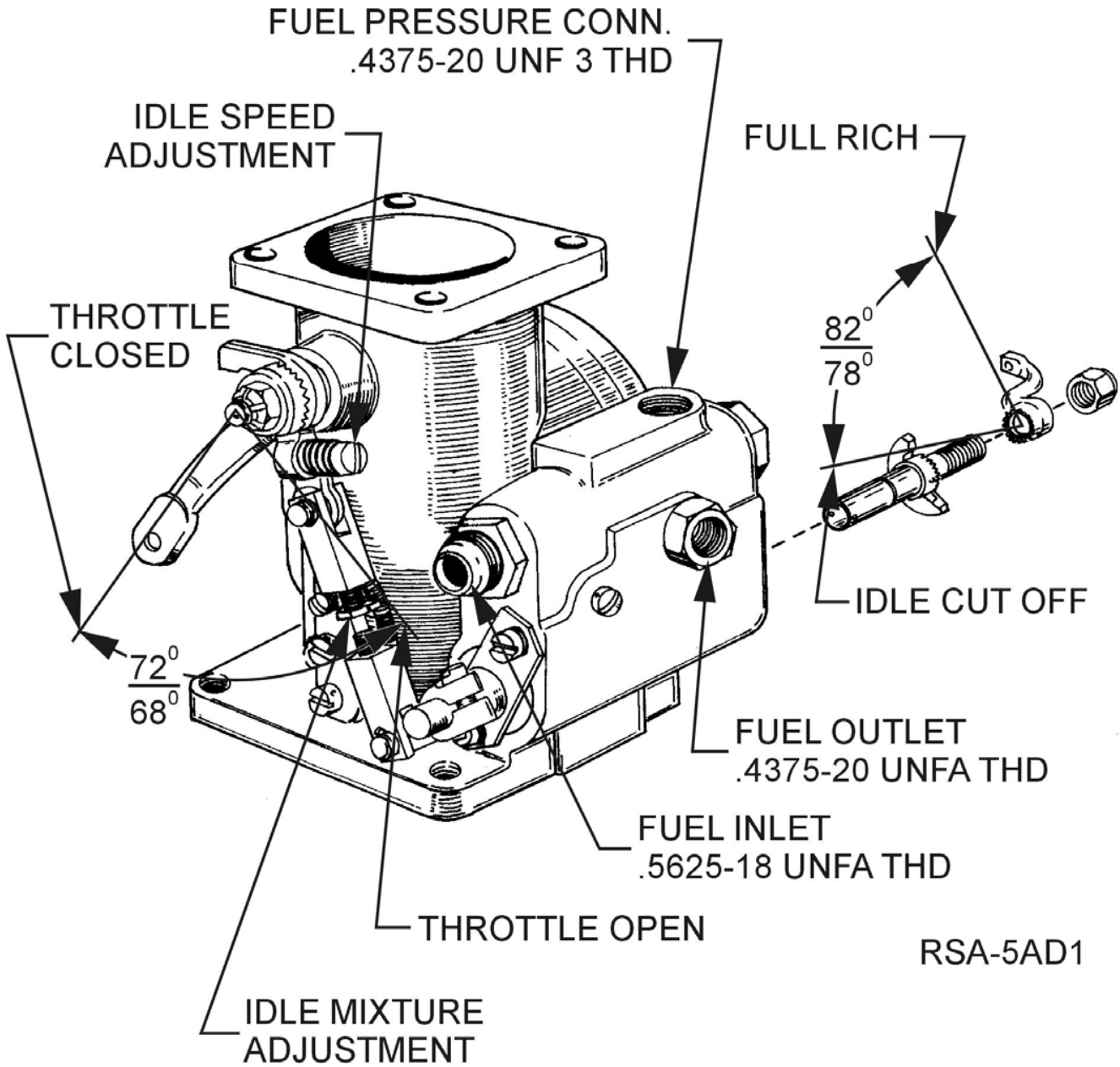

Figure 7-1. Fuel Metering System

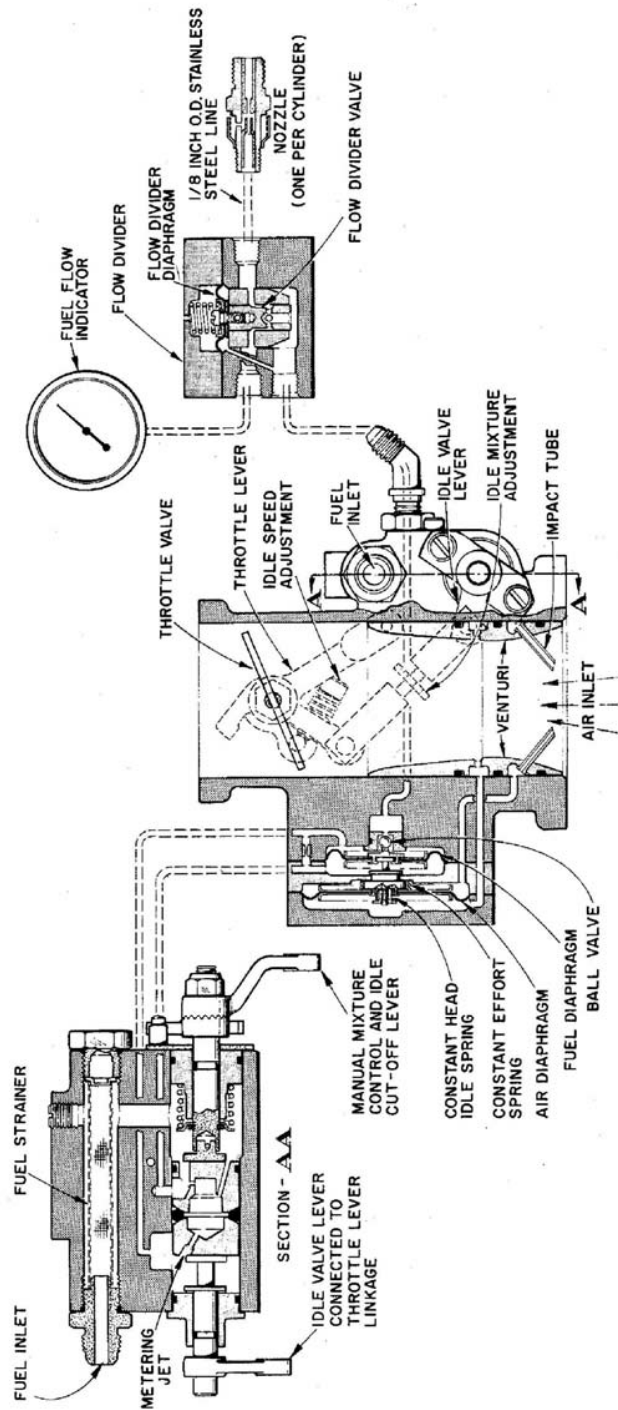

Figure 7-2. Fuel Injector System – RSA-5AD1

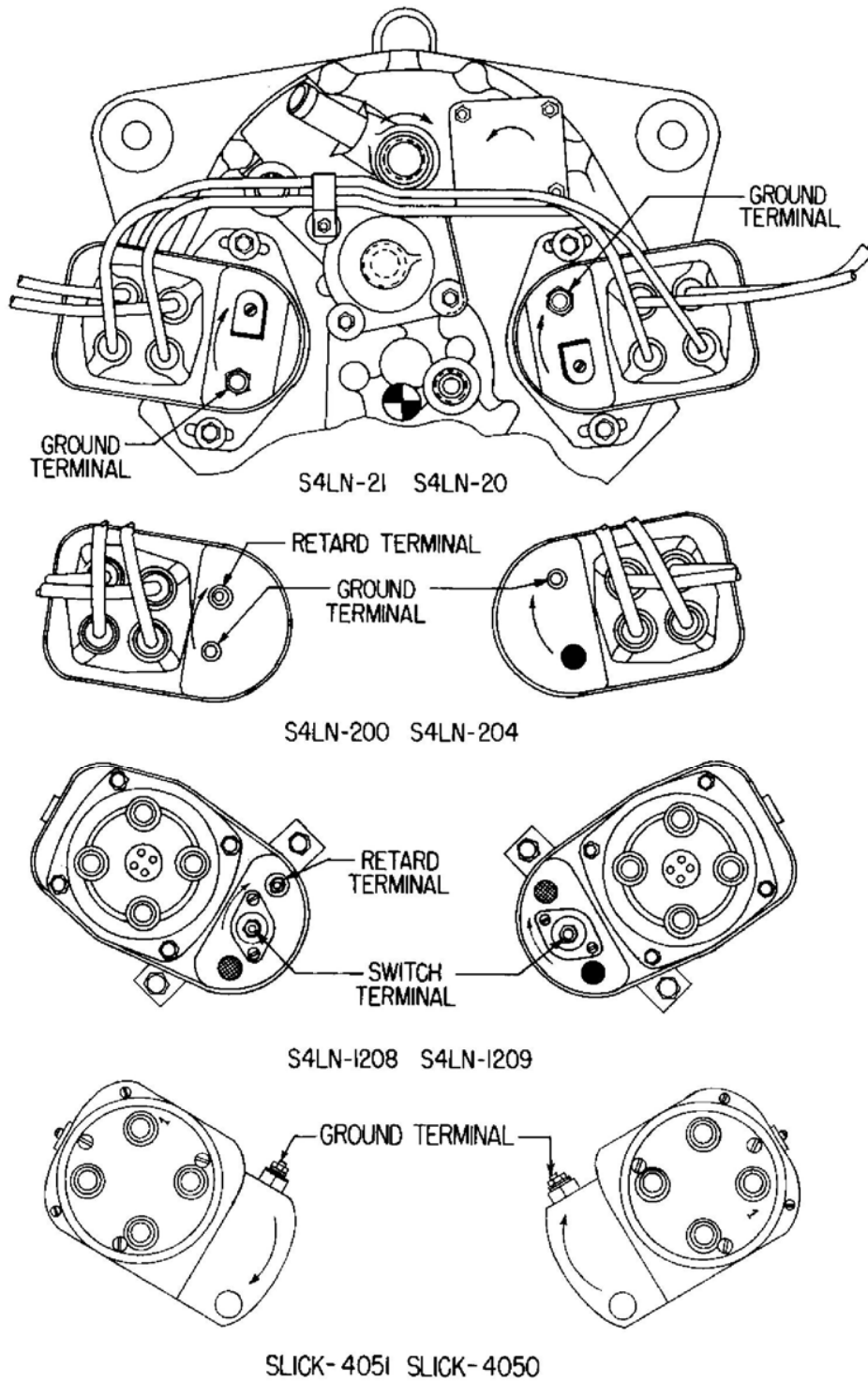

Figure 7-3. Magneto Connections

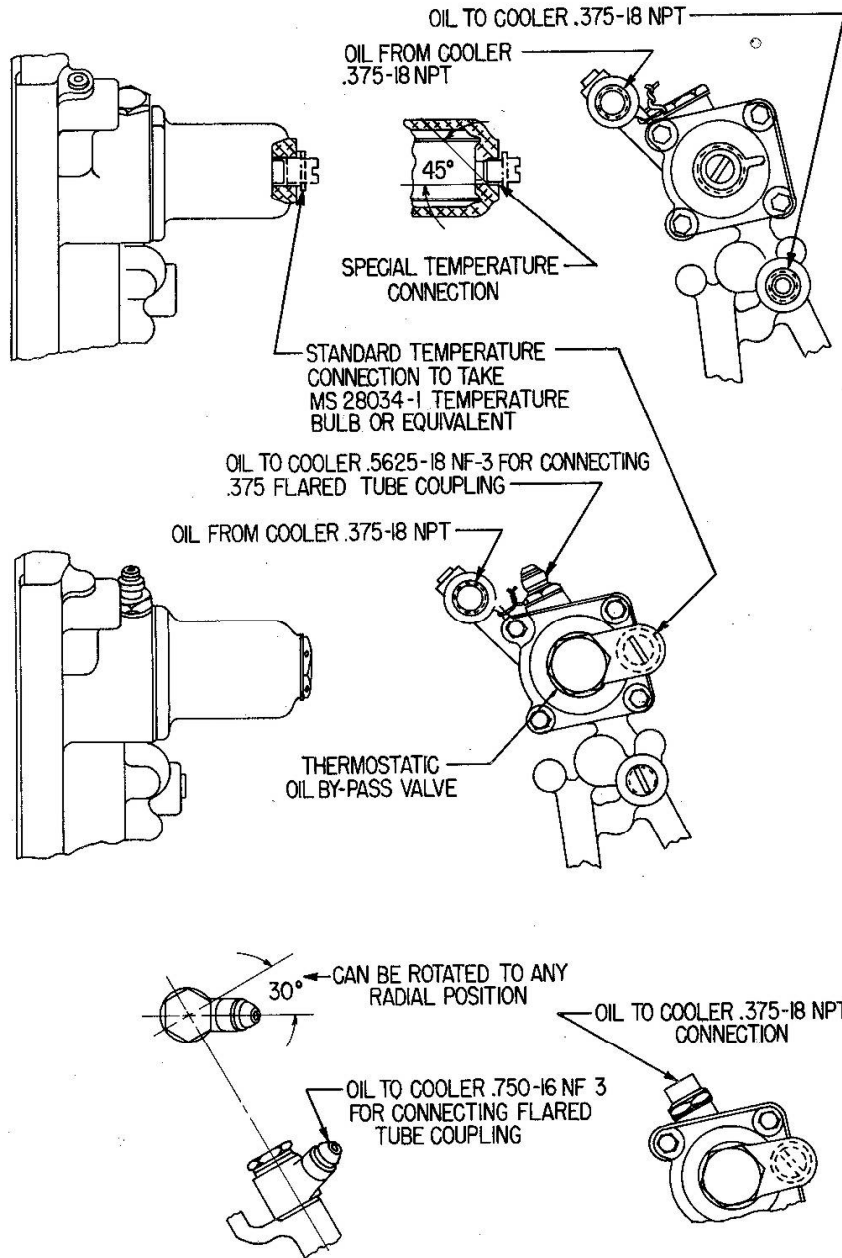

Figure 7-4. Optional Oil Cooler Connections

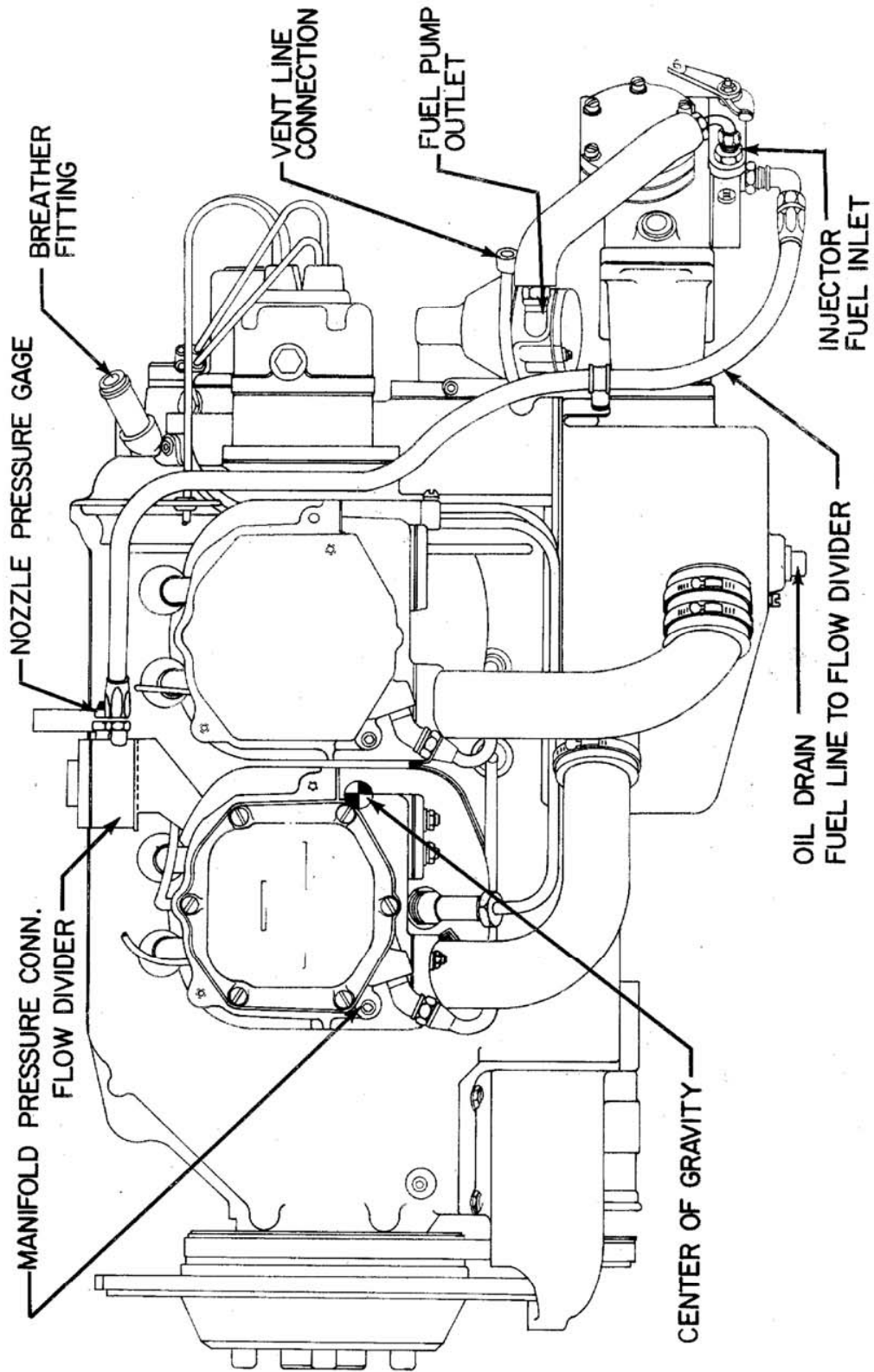

Figure 7-5. Installation Drawing – Left Side View – Typical IO-320-B Series

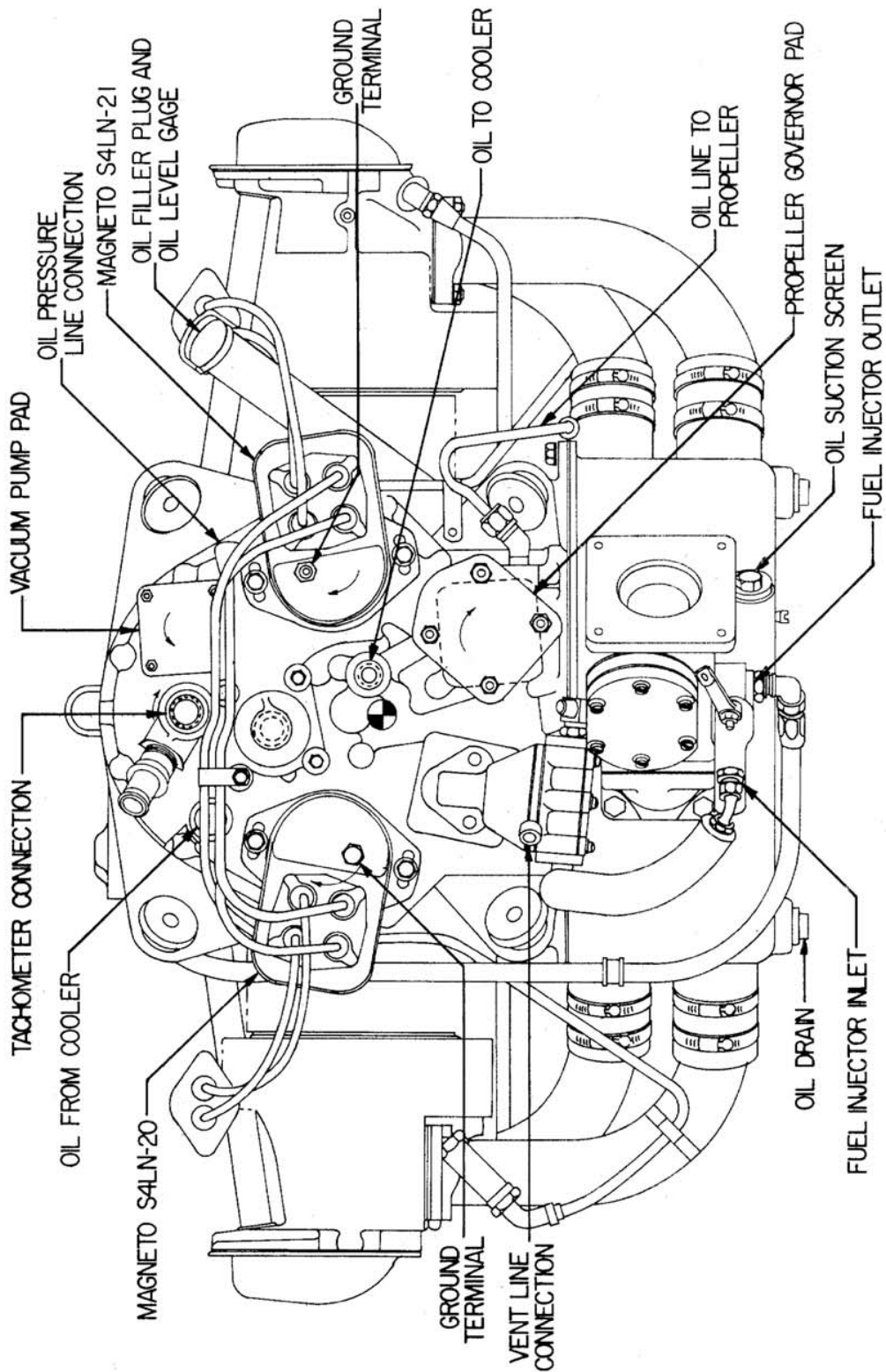

Figure 7-6. Installation Drawing – Rear View – Typical IO-320-B Series

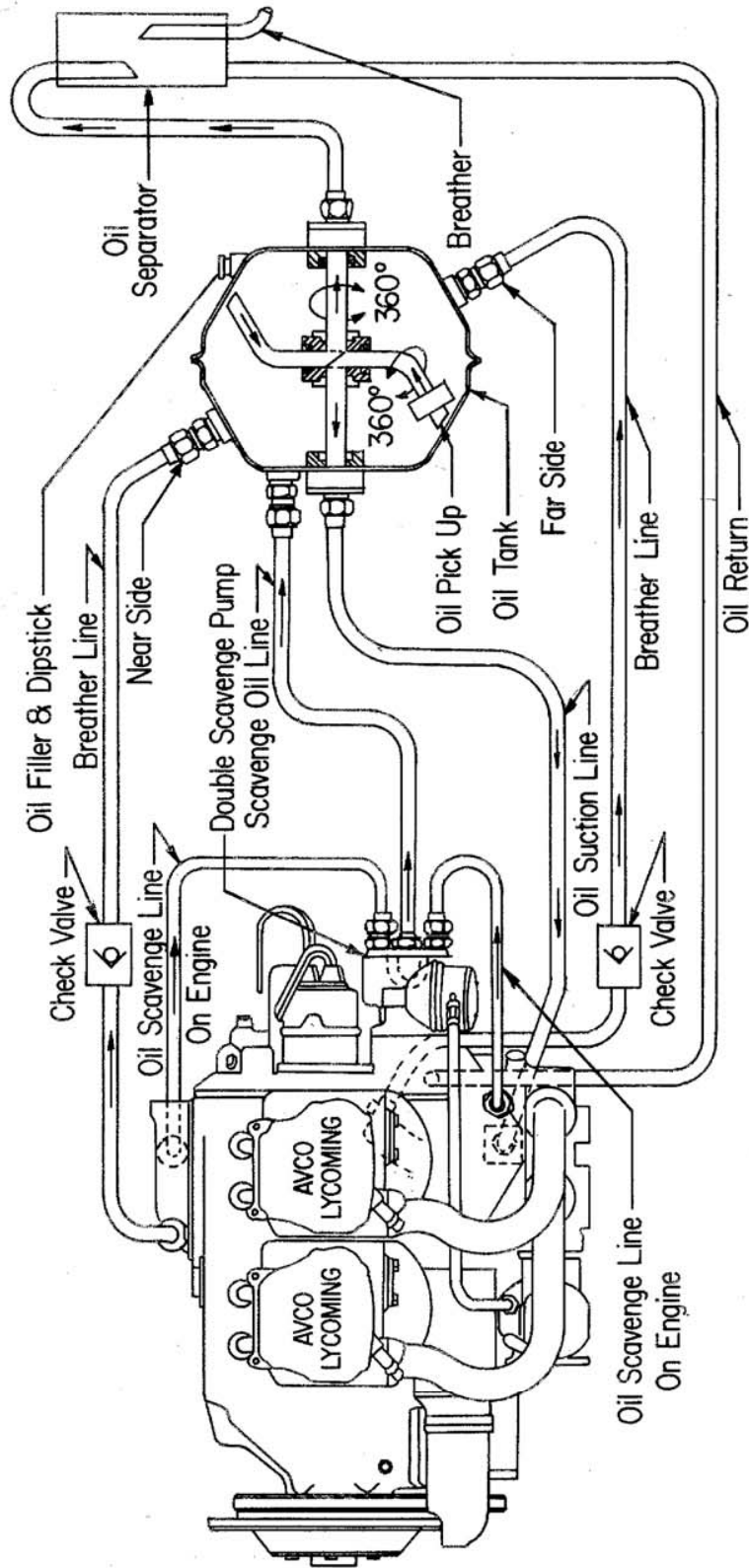

Figure 7-7. Oil System Schematic – AIO-320 Series

LYCOMING OPERATOR'S MANUAL

**SECTION 8
TABLES**

	Page
Table of Limits	8-1
Ground Run After Top Overhaul	8-2
Flight Test After Top Overhaul.....	8-3
Full Throttle HP at Altitude.....	8-4
Table of Speed Equivalents	8-4
Centigrade-Fahrenheit Conversion Table.....	8-5
Inch-Fraction Conversions.....	8-6

This Page Intentionally Left Blank.

SECTION 8

TABLES

FOR TIGHTENING TORQUE RECOMMENDATIONS AND INFORMATION CONCERNING TOLERANCES AND DIMENSIONS THAT MUST BE MAINTAINED IN LYCOMING AIRCRAFT ENGINES, CONSULT LATEST REVISION OF SPECIAL SERVICE PUBLICATION NO. SSP-1776.

CONSULT LATEST REVISION OF SERVICE INSTRUCTION NO. 1029 AND NO. 1150 FOR INFORMATION PERTINENT TO CORRECTLY INSTALLING CYLINDER ASSEMBLY.

FIXED WING ONLY

**GROUND RUN AFTER TOP OVERHAUL
OR CYLINDER CHANGE WITH NEW RINGS
(DO NOT USE AFTER MAJOR OVERHAUL)**

1. Avoid dusty location and loose stones.
2. Head aircraft into the wind.
3. All cowling should be in place, cowl flaps open.
4. Accomplish ground run in full flat pitch.
5. Never exceed 200°F. oil temperature.
6. If cylinder head temperatures reach 400°F., shut down and allow engine to cool before continuing.

Type Aircraft _____
 Registration No. _____
 Aircraft No. _____
 Owner _____
 Engine Model _____ S/N _____
 Date _____
 Run-Up By _____

GROUND RUN

Time	RPM	MAP	Temperature			Pressure			Temperature			Fuel Flow					
			L. oil	R. oil	L. cyl.	R. cyl.	L. oil	R. oil	L. fuel	R. fuel	L. carb.	R. carb.	Amb. Air	Left	Right		
5 min	1000																
10 min	1200																
10 min	1300																
5 min	1500																
5 min	1600																
5 min	1700																
5 min	1800																

Mag. Check _____ Adjustment Required _____ After Completion of Ground Run
 Power Check _____ 1. Visually inspect engine(s)
 Idle Check _____ 2. Check oil levels

**FLIGHT TEST AFTER TOP OVERHAUL
OR CYLINDER CHANGE WITH NEW RINGS**

1. Test fly aircraft one hour.
2. Use standard power for climb, and at least 75% power for cruise.
3. Make climb shallow and at good airspeed for cooling.
4. Record engine instrument readings during climb and cruise.

Tested by _____

FLIGHT TEST RECORD

Time (Climb) Cruise	RPM	MAP	Temperature				Pressure				Temperature		Fuel Flow				
			L. oil	R. oil	L. cyl.	R. cyl.	L. oil	R. oil	L. fuel	R. fuel	L. carb	R. carb	Amb. Air	Left	Right		

Adjustment Required After Flight

After Test Flight.

1. Make careful visual inspection of engine(s).
2. Check oil level(s).
3. If oil consumption is excessive, (see operator's manual for limits), remove spark plugs and check cylinder barrels for scoring.

**FULL THROTTLE HP AT ALTITUDE
(Normally Aspirated Engines)**

Altitude Ft.	% S.L. H.P.	Altitude Ft.	% S.L. H.P.	Altitude Ft.	% S.L. H.P.
0	100	10,000	70.8	19,500	49.1
500	98.5	11,000	68.3	20,000	48.0
1,000	96.8	12,000	65.8	20,500	47.6
2,000	93.6	13,000	63.4	21,000	46.0
2,500	92.0	14,000	61.0	21,500	45.2
3,000	90.5	15,000	58.7	22,000	44.0
4,000	87.5	16,000	56.5	22,500	43.3
5,000	84.6	17,000	54.3	23,000	42.2
6,000	81.7	17,500	53.1	23,500	41.4
7,000	78.9	18,000	52.1	24,000	40.3
8,000	76.2	18,500	51.4	24,500	39.5
9,000	73.5	19,000	50.0	25,000	38.5

TABLE OF SPEED EQUIVALENTS

Sec./Mi.	M.P.H.	Sec./Mi.	M.P.H.	Sec./Mi.	M.P.H.
72.0	50	24.0	150	14.4	250
60.0	60	22.5	160	13.8	260
51.4	70	21.2	170	13.3	270
45.0	80	20.0	180	12.8	280
40.0	90	18.9	190	12.4	290
36.0	100	18.0	200	12.0	300
32.7	110	17.1	210	11.6	310
30.0	120	16.4	220	11.2	320
27.7	130	15.6	230	10.9	330
25.7	140	15.0	240	10.6	340

CENTIGRADE-FAHRENHEIT CONVERSION TABLE

Example: To convert 20°C to Fahrenheit, find 20 in the center column headed (F-C); then read 68.0°F in the column (F) to the right. To convert 20°F to Centigrade; find 20 in the center column and read -6.67°C in the (C) column to the left.

C	F-C	F	C	F-C	F
-56.7	-70	-94.0	104.44	220	428.0
-51.1	-60	-76.0	110.00	230	446.0
-45.6	-50	-58.0	115.56	240	464.0
-40.0	-40	-40.0	121.11	250	482.0
-34.0	-30	-22.0	126.67	260	500.0
-28.9	-20	-4.0	132.22	270	518.0
-23.3	-10	14.0	137.78	280	536.0
-17.8	0	32.0	143.33	290	554.0
-12.22	10	50.0	148.89	300	572.0
-6.67	20	68.0	154.44	310	590.0
-1.11	30	86.0	160.00	320	608.0
4.44	40	104.0	165.56	330	626.0
10.00	50	122.0	171.11	340	644.0
15.56	60	140.0	176.67	350	662.0
21.11	70	158.0	182.22	360	680.0
26.67	80	176.0	187.78	370	698.0
32.22	90	194.0	193.33	380	716.0
37.78	100	212.0	198.89	390	734.0
43.33	110	230.0	204.44	400	752.0
48.89	120	248.0	210.00	410	770.0
54.44	130	266.0	215.56	420	788.0
60.00	140	284.0	221.11	430	806.0
65.56	150	302.0	226.67	440	824.0
71.00	160	320.0	232.22	450	842.0
76.67	170	338.0	237.70	460	860.0
82.22	180	356.0	243.33	470	878.0
87.78	190	374.0	248.89	480	896.0
93.33	200	392.0	254.44	490	914.0
98.89	210	410.0	260.00	500	932.0

**INCH FRACTIONS CONVERSIONS
Decimals, Area of Circles and Millimeters**

Inch Fraction	Decimal Equiv.	Area Sq. In.	MM Equiv.	Inch Fraction	Decimal Equiv.	Area Sq. In.	MM Equiv.
1/64	.0156	.0002	.397	1/2	.5	.1964	12.700
1/32	.0312	.0008	.794	17/32	.5312	.2217	13.494
3/64	.0469	.0017	1.191	35/64	.5469	.2349	13.891
1/16	.0625	.0031	1.587	9/16	.5625	.2485	14.288
3/32	.0937	.0069	2.381	19/32	.5937	.2769	15.081
7/64	.1094	.0094	2.778	39/64	.6094	.2916	15.478
1/8	.125	.0123	3.175	5/8	.625	.3068	15.875
5/32	.1562	.0192	3.969	21/32	.6562	.3382	16.669
11/64	.1719	.0232	4.366	43/64	.6719	.3545	17.065
3/16	.1875	.0276	4.762	11/16	.6875	.3712	17.462
7/32	.2187	.0376	5.556	23/32	.7187	.4057	18.256
15/64	.2344	.0431	5.593	47/64	.7344	.4235	18.653
1/4	.25	.0491	6.350	3/4	.75	.4418	19.050
9/32	.2812	.0621	7.144	25/32	.7812	.4794	19.844
19/64	.2969	.0692	7.540	51/64	.7969	.4987	20.241
5/16	.3125	.0767	7.937	13/16	.8125	.5185	20.637
11/32	.3437	.0928	8.731	27/32	.8437	.5591	21.431
23/64	.3594	.1014	9.128	55/64	.8594	.5800	21.828
3/8	.375	.1105	9.525	7/8	.875	.6013	22.225
13/32	.4062	.1296	10.319	29/32	.9062	.6450	23.019
27/64	.4219	.1398	10.716	59/64	.9219	.6675	23.416
7/16	.4375	.1503	11.112	15/16	.9375	.6903	23.812
15/32	.4687	.1725	11.906	31/32	.9687	.7371	24.606
31/64	.4844	.1842	12.303	63/64	.9488	.7610	25.003