



Grinnell®

Mechanical Products

Grinnell® Mechanical Products



a vital part of your world
M06-1

tyco
Fire & Building
Products



Grinnell®



www.grinnell.com

TABLE OF CONTENTS

1. GENERAL DATA	5 – 10
The Engineered Coupling	6
Features & Benefits	7
ISO 9001:2000 Certificate of Registration	8
Approvals	9
Manufacturing Process	10
2. GROOVED COUPLINGS & FITTINGS	11 – 46
Coupling Material Specifications	12-13
Figure 772 Rigid Coupling	14
Figure 705 Flexible Coupling	15
Figure 707 Heavy Duty Flexible Coupling	16
Figure 716 Flexible Reducing Coupling	17
Figure 71 Flange Adapter (ANSI Class 125/150)	18
Flange Washer Adapter	19
Fittings Material Specifications	20
Fittings Flow Data	21
Figure 210 & 310 90° Elbow	22
Figure 201 & 301 45° Elbow	23
Figure 312 22 ¹ / ₂ ° Elbow	24
Figure 313 11 ¹ / ₄ ° Elbow	24
Long Radius Elbows 3D, 5D & 6D	25-27
Figure 219 & 319 Tee	28
Figure 315 Groove x Male Thread 90° Elbow	29
Figure 320 Groove x Groove x Male Thread Tee	29
Figure 260 & 360 End Cap	30
Figure 327 Cross	31
Figure 221 & 321 Reducing Tee	32-33
Figure 323 Groove x Groove x Male Thread Reducing Tee	34-35
Figure 250, 350 & 372 Concentric Reducer	36-37
Figure 251 & 351 Eccentric Reducer	38
Figure 397, 398 & 399 Swagged Nipples	39
Figure 391, 392 & 393 Adapter Nipples	40
Figure 395 Hose Adapter Nipple	40
Figure 380 Female Thread Adapter	40
Figure 314 45° Lateral	41
Figure 325 45° Reducing Lateral	42
Figure 324 90° True Y	43
Figure 331 Reducing Tee Wye	43
Figure 330 Tee Wye	44
Figure 341 & 342 Flange Adapter	45
Figure 407GT & 407T Clearflow® Dielectric Waterway	46
3. BRANCH OUTLETS	47 – 52
Figure 730 Mechanical Tee Material Specifications	48
Figure 730 Mechanical Tee - Threaded	49-50
Figure 730 Mechanical Tee - Grooved	51-52
4. VALVES	53 – 62
Model B302 Grooved End Butterfly Valve	54-56
Model B308 14"-24" Butterfly Valve	57-58
Model B8101 Low Profile Butterfly Valve	59
Model BV835 Ball Valve	60
Model 590 Grooved End Check Valve	61-62

TABLE OF CONTENTS

5. ACCESSORIES	63 – 70
Figure S853 “Y” Strainer	64
Figure S855 Tee Strainer	65
Figure S810 Suction Diffuser	66-67
Model CB800 Balancing Valve	68-70
6. COPPER GROOVED SYSTEM	71 – 80
Couplings - Copper System Material Specifications	72
Figure 672 Rigid Coupling - Patented	73
Figure 61 Flange Adapter	74
Fittings - Copper System Material Specifications	75
Figures 610, 601, 619, & 660	76
Figure 621 & 618 Reducing Tee	77
Figure 650 & 652 Concentric Reducer	78
Model B680 Grooved End Butterfly Valve	79
Figure 407GG Dielectric Waterway Transition Fitting	80
7. STAINLESS STEEL	81 – 88
Couplings Material Specifications	82
Figure 472 Rigid Coupling	83
Figure 405 Flexible Coupling	84
Figure 410 & 401 Elbow	85
Figure 419 Tee	85
Figure 460 End Cap	85
Figure 450 Concentric & 451 Eccentric Reducer	86
Figure 421 Reducing Tee	87
Figure 441 Flange Adapter	88
8. GASKETS	89 – 94
Gasket Types	90
Gasket Styles	91
Gasket Grade & Recommendations	92-93
Gasket Lubricants	94
9. PIPE PREPARATION EQUIPMENT & GROOVE DATA	95 - 106
Model 1112 Portable Roll Groover (1" - 12" Pipe)	96
Model 1012 Portable Roll Groover (1" - 12" Pipe)	97
Model 1022 Pipe Groover (1 ¹ / ₄ " - 16" Pipe)	97
Model 1041 Roll Grooving Attachment (1" - 12" Pipe)	98
Model 1010 Portable Roll Groover (1 ¹ / ₂ " - 12" Pipe)	98
Model 1023 Portable Roll Groover (1 ¹ / ₄ " - 24" Pipe)	99
Model 4037 Nipple Bracket (8" - 24" Pipe)	99
Model 2021 Automated Roll Groover (1 ¹ / ₄ " - 24" Pipe)	100
Model 3013 Porta-Bore (1 ¹ / ₄ " - 12" Pipe, up to 4 ¹ / ₂ " dia. holes)	101
Models 4031/4000/4033 Pipe Support Stands	102
Models 1039/1034/1066 Mini-Mites™ Roll Groovers	103
Roll Groove & Cut Groove Standard Specification	104-106
10. PRESSURE & DESIGN DATA	107 – 118
Design Data	108-115
Typical General & Guide Specifications	116
Guide & Building Service Systems Specifications	117-118

General Data

GENERAL DATA



THE ENGINEERED COUPLING

Grinnell® Mechanical Piping Products are designed for grooved end pipe and are available in nominal sizes of 1 $\frac{1}{4}$ " (32mm) to 24" (600mm) depending on the coupling figure required. The Grinnell Coupling design provides several economic advantages when compared to welded or flanged systems. They also provide a universal means for the connection of pipe, fittings and pipe system components.

Grinnell Couplings and Gaskets permit the selection of suitable combinations for specific applications. Field modifications are easily accommodated with Grinnell Grooved Couplings as the couplings can be easily rotated, eliminated and/or added to facilitate the necessary modification.

Flexible couplings act as an "expansion joint", allowing linear and angular movement of the pipe. They are designed with the coupling keys engaging the pipe without gripping on the bottom of the grooves, while still providing for a restrained mechanical joint. This is particularly useful to allow for pipe expansion or contraction and piping misalignment.

Rigid couplings provide rigid gripping of the pipe. They are designed to bring the pipe ends closely together while the coupling clamps firmly onto the pipe OD and also onto the bottom of the grooves. Because rigid couplings clamp around the entire pipe surface, they provide resistance to flexural loads and therefore permit longer spacing to ASME/ANSI B31.1 (Power Piping) and ASME/ANSI B39.1 (Building Services) requirements.



MATERIAL SPECIFICATIONS

GASKETS

Grinnell offers a variety of gasket grades and styles for a wide range of applications.

Grade "E" EPDM (green color code) recommended for hot water not to exceed 230°F (110°C) plus a variety of dilute acids, oil-free air, and many chemical services. Not recommended for petroleum services. For low temperature and vacuum systems, a tri-seal Grade "E" EPDM gasket with rigid coupling is recommended.

Grade "T" Nitrile (orange color code) recommended for petroleum products, vegetable oils, mineral oils, and air with oil vapors. Not recommended for hot water systems.

Grade "L" Silicone (red gasket) recommended for air without hydrocarbons, dry heat.

Grade "O" Fluoroelastomer (color code blue) recommended for oxidizing acids, petroleum products, hydraulic fluids, lubricants, halogenated hydrocarbons.

Grade "EN" (color code copper) NSF 61 approved for potable water. Not recommended for petroleum service.

For further information on gasket grades, styles and applications, see Section 8.



First Seal

C-shaped rubber gasket seals on pipe ends.

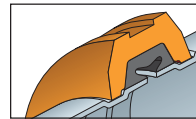

Second Seal

The housings compress the gasket to increase the sealing capacity.

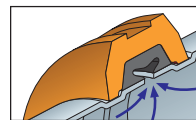

Third Seal

The system pressure or vacuum will then maximize the leak-tight seal.

BOLTS & NUTS

Coupling bolts and nuts are heat treated carbon steel, oval-neck track head bolts and heavy hex nuts, conforming to the physical properties of ASTM A-183 minimum tensile strength of 110,000 psi (758,422 kPa). Bolts and nuts are Zinc electroplated.

Gold color coded metric bolts conforming to the physical properties of ASTM F568M are available upon request. Contact Tyco Fire & Building Products.

The oval neck design allows for tightening the hex nut with a single wrench.

COATINGS

All housings are standard coated with an orange, non-lead waterbased paint. RAL Red non-lead waterbased paint and hot dipped zinc galvanized are optional. Copper system coupling housings are standard coated with a copper acrylic enamel.

FEATURES & BENEFITS

• FLEXIBILITY

Grinnell® flexible couplings are able to absorb linear movement of the pipework due to temperature changes. This eliminates or minimizes the use of expansion joints.

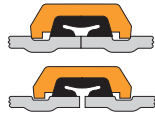

• DEPENDABILITY

The coupling housings are designed to engage into the grooves and provide a secure joint. The pipe ends are sealed by a pressure responsive gasket which is encapsulated by the ductile iron housing.



• RETROFIT

Grinnell Mechanical Piping Products allow for quick economical changes as necessary for field retrofit, with the ability to isolate equipment and piping systems for tenant changes and system repair.

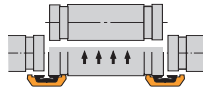

• MISALIGNMENT

The Grinnell Flexible Couplings will accommodate misalignments. The maximum deflection information per coupling can be found in this catalogue.

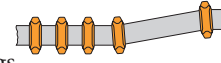

• NOISE & VIBRATION

The resiliency of Grinnell Grooved Couplings with various elastomer gaskets provide excellent noise and vibration dampening. The engineering design of the couplings provide for pipe end gapping which helps to dissipate, isolate, and minimize noise and vibration transmission throughout the piping system.

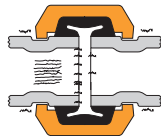

• JOINT DEFLECTION

Grinnell Flexible Couplings are able to absorb pipe deflection to a certain value. This feature is a great advantage in tunnel, bridge and mine applications.

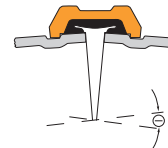

• SUPERIOR QUALITY

Grinnell Mechanical Piping Products are manufactured according to the ISO 9001:2000 Quality Assurance standard.

• QUICK

Grinnell Mechanical Piping Products will offer you time savings compared to welding, flanging or threading.



• EASY

Grinnell Mechanical Piping Products only require a wrench for installation. No special expensive equipment or skilled labor is required for installation as compared to welded or flanged systems.



• COST-SAVING

Total installed costs for Grinnell Mechanical Piping Products will be far below any other method currently used.

• SAFE

Due to the absence of flames, from welding torches, Grinnell Mechanical Piping Products can be used in hazardous areas without special precautions.

• DEPENDABLE

Grinnell Mechanical Piping Products are designed to last the lifetime of the pipeline and have been tested and approved by major Approval Bodies. Since roll grooving does not remove metal from the pipe, the pipe integrity is fully maintained. The maximum working pressure of the system goes up to 1000 psi (69 Bar) depending on the coupling and pipe wall thickness used.



• COMPACT

Grinnell Mechanical Piping Products require far less space than traditional welded or flanged systems.



• CLEAN



Unlike welding, Grinnell Mechanical Piping Products do not lead to hazardous fumes or to the possible introduction of foreign material in the pipeline.

• WARRANTY

All Grinnell Mechanical Products have a 10 year limited warranty against defects and workmanship. For details, see page 119.



ISO 9001:2000 CERTIFIED

Loss Prevention Certification Board	
	
CERTIFICATE OF QUALITY SYSTEM REGISTRATION	
This is to certify	
TYCO FIRE & BUILDING PRODUCTS 260 Central Castings Drive, Anniston, AL 36206, USA*	
has complied with the requirements identified in	
ISO 9001 : 2000	
and is authorised to use the LPCB mark on stationery and publications related to the following products and/or services	
Design and manufacture of pipe couplings, fittings, related piping systems components and castings.	
<small>further clarifications regarding the scope of this certificate and the applicability of ISO 9001:2000 requirements may be obtained by consulting the organisation</small>	
<small>* Also at 1550 Valley Center Parkway, Suite 135, Bethlehem, PA18017, USA</small>	
Certificate No. 669	
Issued	1 March 2005
Valid Until	29 February 2008
Signed on behalf of the LPCB	
C JUDGE	
<small>LPCB is part of BRE Certification Ltd., Garston, Watford WD25 9XX. Tel 01923 664100 Fax 01923 664603 www.brecertification.co.uk This certificate remains the property of BRE Certification Ltd and is issued subject to terms and conditions and is maintained and held in force through regular surveillance activities. To check the authenticity of this certificate, please visit our website or contact us.</small>	
	
BF040	

APPROVALS

GOVERNMENT AGENCIES

Coast Guard -

Approved each vessel individually

Corps of Engineers (COE) -

GECS 15000

Federal Aviation Administration (FAA) -

HVAC, Plumbing and Fire Protection

Federal Housing Administration (FHA)

General Services Administration (GSA) -

15000 Series

Military Specifications (MIL)

- MIL P - 10388 Fittings;
- MIL - C - 10387 Couplings;
- MIL - P - 11087A (CE) Steel Pipe,
- Grooved MIL - I - 45208 Inspection Procedure

National Aeronautics and Space Administration (NASA)

Naval Facilities Engineering Command (NAVFAC) -

NFGS 15000 Series

National Institute of Health (NIH) -

Dept. of Health - 15000 Series

Veterans Affairs (VA) -

15000 Series



For Fire Protection Pressure Rating and Listing / Approval information contact Tyco Fire & Building Products.

GENERAL CODE GROUPS, ASSOCIATIONS, LABORATORIES & APPROVAL BODIES

American Bureau of Shipping (ABS)

American National Standards Institute / American Water Works Association (ANSI / AWWA)

American Petroleum Institute (API) -

API Std. 5L, Sect. 7.5

American Society of Heating, Refrigeration and Air Conditioning Engineers (ASHRAE)

American Society of Mechanical Engineers (ASME)

- Power Piping, B-31.1;
- Chemical Plant and Petroleum Refinery Piping, B-31.3;
- Refrigeration Piping, B-31.5;
- Building Services Piping, B31.9

Building Officials and Code Administrators (BOCA)

Bureau Veritas (BV)

Factory Mutual Engineering Corp. (FM) -

Approved for Fire Protection Services

International Association of Plumbing and Mechanical Officials (IAPMO)

Loss Prevention Certification Board (LPCB) -

Approved for Fire Protection Services

Material Equipment and Acceptance (MEA)

National Fire Protection Association (NFPA)

National Sanitation Foundation (NSF) -

The Public Health and Safety Company

Southern Building Code Congress International (SBCCI) - Standard Plumbing

Underwriter's Laboratories, Inc. (UL) -

Listed for Fire Protection Services

Underwriters Laboratories of Canada (ULC) -

Listed for Fire Protection Services

Uniform Plumbing Code (UPC)

Verband der Sachversichere e.V. (VdS) -

Approved for Fire Protective Service

MANUFACTURING PROCESS

CASTING

Tyco Fire & Building Products produces ductile iron, ASTM A-536, Grade 65-45-12 for all of its Grinnell® Grooved Products. Once the base iron is produced, magnesium is added in precise measurements to develop the ductile iron grade. The metal is tested chemically, physically, and microscopically prior to being released for production. Once cast, the ductile iron is again checked to ensure conformance with these specifications.



RUBBER INJECTION

Tyco Fire & Building Products understands the complexity of providing gaskets capable of exceeding customer demands. With state of the art rubber injection presses and tooling, we are able to mold several types of rubber compounds to meet the various needs of the mechanical market. Our gaskets are manufactured in our facility in Alabama and each gasket is inspected to ensure it is defect free. Physical tests are performed on the gaskets to verify compliance with specifications such as ASTM D-2000.

THE PAINT PROCESS

Grinnell Grooved Products are painted using a computer controlled semi-automatic process. This process ensures that each product is spray washed, dried, pre-heated, dipped and fully cured prior to being assembled or packaged for shipment. All painted parts are quality controlled to maintain consistent paint coverage and surface condition.



TOOLING

Grinnell Products are designed utilizing the finest engineering talent and innovative practices available. Our engineering department provides product designs to our pattern centers as well as contracted pattern makers. The Grinnell patterns and our foundry molding machines are capable of providing the closest tolerance parts available using the green sand method of casting. With our in-house process, we have the ability to construct, maintain and modify patterns to meet the demands of the market place.

Grooved Couplings & Fittings

GROOVED COUPLINGS & FITTINGS



FOUNDED 185

COUPLINGS

Grinnell® Mechanical Piping Products are designed for grooved end pipe and are available in nominal sizes of 1 1/4" (32mm) to 24" (600mm).

The Grinnell Coupling design provides several economical advantages when compared to welded or flanged systems. They also provide a universal means for the connection of pipe, fittings and pipe system components.

Grinnell Couplings and Gaskets permit the selection of suitable combinations for specific applications.

Field modifications are easily accommodated with Grinnell Mechanical Piping Products as the couplings can be easily rotated, eliminated and/or added to facilitate the necessary modification.

Tech Data: G1900



Rigid Connection

The Figure 772 coupling has a patented design that allows the coupling housings to grip along the full 360° of circumference of the pipe groove. This means a more rigid and stronger connection through a range of pipe tolerances. The coupling design eliminates distortion of the gasket as the housing sections come together.

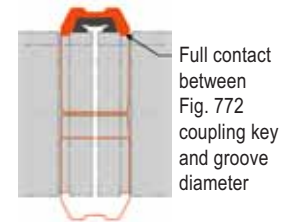

Trouble Free Design

The patented universal tongue and groove design of the coupling housings assures trouble free installation. Potential misalignment of the coupling housings that could lead to a joint failure is a thing of the past.



Quick Installation

The Grinnell Figure 772 and 705 Coupling in sizes up to 8" features a clamshell design that allows for an easy one bolt installation thus saving time in the field.

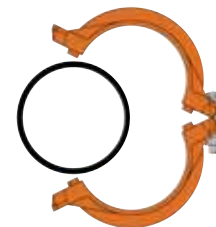

COUPLINGS

MATERIAL SPECIFICATIONS

The applicable material specifications for ductile iron, galvanizing and rubber gaskets apply:

Ductile Iron Housing Specifications

- ASTM A-536 - Standard Specification for Ductile Iron Castings Grade 65-45-12
- Tensile Strength, minimum psi-65,000 (MPa-448)
- Yield Strength, minimum psi-45,000 (MPa-310)
- Elongation in 2" (50mm), minimum 12%
- ASTM A-153 - Standard Specification for Hot Dip Galvanizing

Bolt / Nut Specifications

Carbon steel oval neck bolts and nuts are heat treated and conform to the physical properties of ASTM A-183 with a minimum tensile strength of 110,000psi (758,422 kPa). Bolts and nuts are Zinc electroplated to ASTM B633.

Gold color coded metric bolts conforming to the physical properties of ASTM F568M are available upon request. Contact Tyco Fire & Building Products.

Gasket Specifications

Grade "E" EPDM gaskets have a green color code identification and conform to ASTM D-2000 for service temperatures from -30°F (-34°C) to 230°F (110°C). They are recommended for hot water not to exceed 230°F (110°C), plus a variety of dilute acids, oil free air and many chemical services. They are not recommended for petroleum services. For low temperature and vacuum systems, a Tri-Seal Grade "E" EPDM gasket with rigid coupling is recommended.

Grade "T" Nitrile gaskets have an orange color code identification and conform to ASTM D-2000 for service temperatures from -20°F (-29°C) to 180°F (82°C). They are recommended for petroleum products, vegetable oils, mineral oils, and air with oil vapors.

Grade "I" Silicone gaskets are red and conform to ASTM D-2000 for service -30°F (-34°C) to 350°F (+177°C). They are recommended for air without hydrocarbons, dry heat.

Grade "O" Fluoroelastomer gaskets have a blue color code and conform to ASTM D-2000 for service +20°F (-7°C) to +300°F (+149°C). They are recommended for oxidizing acids, petroleum products, hydraulic fluids, lubricants, halogenated hydrocarbons.

Grade "EN" NSF 61 approved gaskets have a copper color code and are for potable water systems up to +180°F (+82°C). Not recommended for petroleum service.

Coatings

- Orange - non lead (standard)
- RAL Red - non lead (optional)
- Hot Dipped Zinc Galvanized (optional)
- Copper acrylic enamel

GROOVED
COUPLINGS
& FITTINGS

COUPLINGS

Figure 772 Rigid Coupling - Patented

The Figure 772 Rigid Coupling is capable of pressures up to 750 psig (51.7 Bar) and provides a rigid joint by firmly gripping along the circumference of the pipe grooves. It is a proven, dependable method of joining pipe and is an economical alternative to welding, threading, or flanges and can be used on a variety of pipe and wall thicknesses.

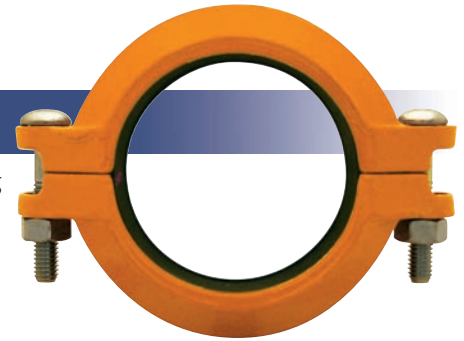

Tech Data: G140

The Figure 772 Rigid Coupling, in sizes 1¹/₄" (DN32) to 4" (DN100), has an Anti-Rotational Feature of "gripping teeth" along the coupling keys that make it suited for installations where the likelihood of rotation is greatest.

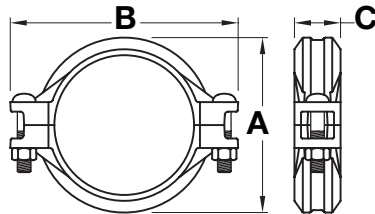

Sizes 1¹/₄" (DN32) - 14" (DN350)



For Fire Protection Pressure Rating and Listing / Approval information contact Tyco Fire & Building Products.

Nominal Size Inches DN	Pipe OD Inches mm	Max.† Pressures psi Bar	Max. End† Load Lbs. kN	Max. End*‡ Gap Inches mm	Nominal Dimensions			Coupling Bolts Qty	Approx. Weight Lbs. Kg	
					A Inches mm	B Inches mm	C Inches mm			
1 ¹ / ₄ DN32	1.660 42.4	750 51.7	1,623.2 7.22	0.06 1.5	2.75 69.9	4.38 111.3	1.81 46.0	2	³ / ₈ x 2 ¹ / ₄ M10 x 57	1.0 0.5
1 ¹ / ₂ DN40	1.900 48.3	750 51.7	2,126.5 9.46	0.08 2.0	3.00 76.2	4.62 117.3	1.81 46.0	2	³ / ₈ x 2 ¹ / ₄ M10 x 57	1.0 0.5
2 DN50	2.375 60.3	750 51.7	3,322.6 14.78	0.13 3.3	3.41 86.6	5.12 130.0	1.88 47.8	2	³ / ₈ x 2 ¹ / ₄ M10 x 57	1.5 0.7
2 ¹ / ₂ DN65	2.875 73.0	750 51.7	4,868.9 21.66	0.13 3.3	3.91 99.3	5.63 143.0	1.88 47.8	2	³ / ₈ x 2 ¹ / ₄ M10 x 57	2.5 1.1
	3.000 76.1	750 51.7	5,301.4 23.58	0.13 3.3	4.19 106.4	5.72 145.3	2.00 50.8	2	M10 x 57	2.6 1.2
3 DN80	3.500 88.9	750 51.7	7,215.8 32.10	0.13 3.3	4.63 117.6	6.25 158.8	1.88 47.8	2	³ / ₈ x 2 ¹ / ₄ M10 x 57	2.6 1.2
4 DN100	4.500 114.3	750 51.7	11,928.2 53.06	0.19 4.8	5.81 147.6	7.50 190.5	1.97 50.0	2	³ / ₈ x 2 ¹ / ₄ M10 x 57	3.5 1.6
	5.500 139.7	750 51.7	17,818.7 79.26	0.19 4.8	7.02 178.3	9.72 246.9	2.06 52.3	2	M16 x 83	7.5 3.4
5 DN125	5.563 141.3	750 51.7	18,229.3 81.09	0.19 4.8	7.09 180.1	9.71 246.6	2.04 51.8	2	⁵ / ₈ x 3 ¹ / ₄ M16 x 83	7.5 3.4
	6.500 165.1	700 48.2	23,228.2 103.18	0.19 4.8	8.09 205.5	10.53 267.5	2.13 54.1	2	M16 x 83	7.6 3.4
6 DN150	6.625 168.3	700 48.2	24,130.1 107.34	0.19 4.8	8.09 205.5	10.53 267.5	2.13 54.1	2	⁵ / ₈ x 3 ¹ / ₄ M16 x 83	7.6 3.4
8 DN200	8.625 219.1	600 41.4	35,055.8 155.94	0.19 4.8	10.56 268.2	13.56 344.4	2.62 66.5	2	³ / ₄ x 4 ³ / ₄ M20 x 121	18.0 8.2
10 DN250	10.750 273.0	500 34.5	45,381.3 201.87	0.13 3.3	12.84 326.1	16.41 416.8	2.62 66.5	2	1 x 6 ¹ / ₂ M24 x 165	24.6 11.2
12 DN300	12.750 323.9	400 27.6	51,070.5 227.17	0.13 3.3	15.41 391.4	18.84 478.5	2.62 66.5	2	1 x 6 ¹ / ₂ M24 x 165	42.0 19.1

† Maximum pressure and end load are total from all loads based on standard weight steel pipe. Pressure ratings and end loads may differ on other pipe materials and/or wall thickness. Contact Tyco Fire & Building Products for details.

* Maximum available gap between pipe ends. Minimum gap = 0.

** Gold color coded metric bolt sizes for DN32 - DN300 couplings available upon request.

‡ Maximum End Gap and Deflection is for cut grooved standard weight pipe. Values for roll grooved pipe will be 1/2 that of cut grooved.

• Only available in ANSI bolt sizes.

General Notes: Additional information is included in our data sheets and is available upon request. It is the Designer's responsibility to select products suitable for the intended service and to ensure that pressure ratings and performance data is not exceeded. Always read and understand the installation instructions (IH-1000). Never remove any piping components or correct or modify any piping deficiencies without first depressurizing and draining the system. Material and gasket selection should be verified to be compatible for the specific application.

COUPLINGS

Figure 772 Rigid Coupling - Patented

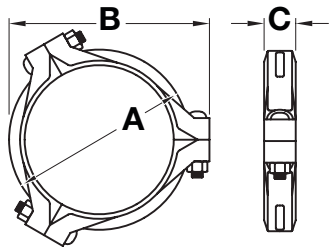

Sizes 16" (DN400) - 18" (DN450)

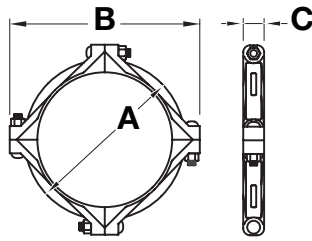

Sizes 20" (DN500) - 24" (DN600)

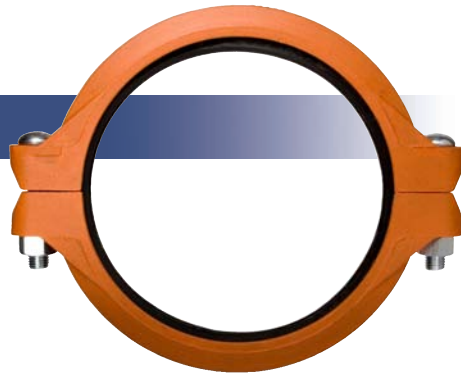

Tech Data: G140

GROOVED
COUPLINGS
& FITTINGS

Nominal Size Inches DN	Pipe OD Inches mm	Max.† Pressures psi Bar	Max. End† Load Lbs. kN	Max. End*‡ Gap Inches mm	Nominal Dimensions			Coupling Bolts		Approx. Weight Lbs. Kg
					A Inches mm	B Inches mm	C Inches mm	Qty	Size Inches mm	
14 DN350	14.000 355,6	300 20,7	46,181.4 205,43	0.13 3,3	16.68 423,7	20.38 517,6	2.93 74,4	2	1 x 5½*	48.0 21,7
16 DN400	16.000 406,4	300 20,7	60,318.6 268,31	0.13 3,3	18.50 469,9	22.64 575,1	2.93 74,4	3	1 x 5½*	52.1 23,6
18 DN450	18.000 457,2	300 20,7	76,340.7 339,58	0.25 6,4	21.31 541,3	25.12 638,0	3.06 77,7	3	1 x 5½*	52.1 30,8
20 DN500	20.000 508,0	300 20,7	94,247.8 419,23	0.25 6,4	23.50 596,9	27.88 708,2	3.06 77,7	4	1½ x 5¾*	89.0 40,4
24 DN600	24.000 609,6	250 17,2	113,097.3 503,08	0.25 6,4	27.63 701,8	32.00 812,8	3.19 81,0	4	1½ x 5¾*	96.0 43,5

† Maximum pressure and end load are total from all loads based on standard weight steel pipe. Pressure ratings and end loads may differ on other pipe materials and/or wall thickness. Contact Tyco Fire & Building Products for details.

* Maximum available gap between pipe ends. Minimum gap = 0.

** Gold color coded metric bolt sizes for DN32 - DN300 couplings available upon request.

‡ Maximum End Gap and Deflection is for cut grooved standard weight pipe. Values for roll grooved pipe will be ½ that of cut grooved.

• Only available in ANSI bolt sizes.

Please refer to General Notes on page 14.

COUPLINGS

Figure 705 Flexible Coupling

The Figure 705 Flexible Coupling is capable of pressures up to 500 psig (34.5 Bar) depending on pipe size and wall thickness. It provides a dependable method of joining pipe and is suitable for use in a variety of applications.

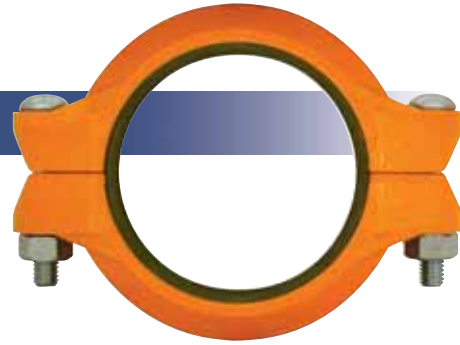

Tech Data: G110

GROOVED
COUPLINGS
& FITTINGS

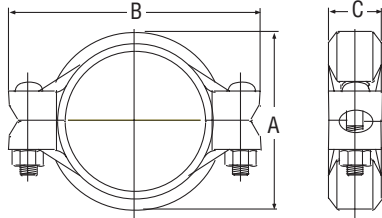

For Fire Protection Pressure Rating and Listing / Approval information contact Tyco Fire & Building Products.

Nominal Size Inches mm	Pipe OD Inches mm	Max.† Pressures psi Bar	Max. End† Load Lbs. kN	Max. End*‡ Gap Inches mm	Deflection ‡		Nominal Dimensions			Coupling Bolts		Approx. Weight Lbs. Kg
					Degrees Per Coupling	Inches/ Foot mm/m	A Inches mm	B Inches mm	C Inches mm	Qty	Size Inches mm	
1¼ 32	1.660 42.4	500 34.5	1,082.1 4.81	0.13 3.3	4°19'	0.90 75.0	2.56 65.0	4.19 106.4	1.81 46.0	2	¾ x 2¼ M10 x 57	1.5 0.7
1½ 40	1.900 48.3	500 34.5	1,417.6 6.30	0.13 3.3	3°46'	0.79 65.8	2.75 69.9	4.44 112.8	1.81 46.0	2	¾ x 2¼ M10 x 57	1.6 0.7
2 50	2.375 60.3	500 34.5	2,215.1 9.85	0.13 3.3	3°1'	0.63 52.5	3.25 82.6	4.88 124.0	1.88 47.8	2	¾ x 2¼ M10 x 57	1.7 0.8
2½ 65	2.875 73.0	500 34.5	3,245.9 14.43	0.13 3.3	2°29'	0.52 43.3	3.69 93.7	5.50 139.7	1.88 47.8	2	¾ x 2¼ M10 x 57	2.0 0.9
	3.000 76.1	500 34.5	3,534.3 15.72	0.13 3.3	2°23'	0.50 41.7	4.00 101.6	5.75 146.1	1.88 47.8	2	M12 x 76	3.1 1.4
3 80	3.500 88.9	500 34.5	4,810.6 21.39	0.13 3.3	2°3'	0.43 35.8	4.38 111.3	6.50 165.1	1.88 47.8	2	½ x 3 M12 x 76	3.1 1.4
	4.250 108.0	500 34.5	7,093.1 31.55	0.25 6.4	3°22'	0.70 58.3	5.50 139.7	7.50 190.5	2.06 52.3	2	M12 x 76	4.2 1.9
4 100	4.500 114.3	500 34.5	7,952.2 35.35	0.25 6.4	3°11'	0.67 55.8	5.69 144.5	7.75 196.9	2.06 52.3	2	½ x 3 M12 x 76	4.0 1.8
	5.250 133.0	450 31.0	9,741.4 43.33	0.25 6.4	2°44'	0.56 46.7	6.56 166.6	9.50 241.3	2.06 52.3	2	M16 x 83	7.2 3.3
	5.500 139.7	450 31.0	10,691.2 47.56	0.25 6.4	2°36'	0.55 45.5	6.81 173.0	9.75 247.7	2.06 52.3	2	M16 x 83	7.2 3.3
5 125	5.563 141.3	450 31.0	10,937.6 48.63	0.25 6.4	2°35'	0.54 45.0	6.88 174.8	9.75 247.7	2.06 52.3	2	⅝ x 3¼ M16 x 83	7.1 3.2
	6.250 159.0	450 31.0	13,805.8 61.41	0.25 6.4	2°17'	0.48 40.0	7.56 192.0	10.31 261.9	2.06 52.3	2	M16 x 83	7.4 3.4
	6.500 165.1	450 31.0	14,932.4 66.36	0.25 6.4	2°12'	0.46 38.3	7.75 196.9	10.69 271.5	2.06 52.3	2	M16 x 83	7.1 3.2
6 150	6.625 168.3	450 31.0	15,512.2 68.97	0.25 6.4	2°10'	0.45 37.5	7.94 201.7	10.69 271.5	2.06 52.3	2	⅝ x 3¼ M16 x 83	7.1 3.2
	8.500 216.3	450 31.0	25,535.3 113.59	0.25 6.4	1°40'	0.35 29.2	10.07 255.8	13.50 342.9	2.31 58.7	2	M20 x 121	12.4 5.6
8 200	8.625 219.1	450 31.0	26,291.8 116.89	0.25 6.4	1°40'	0.35 29.2	10.19 258.8	13.56 344.4	2.50 63.5	2	¾ x 4¾ M20 x 121	14.5 6.6
10 250	10.750 273.0	350 24.1	31,766.9 141.31	0.25 6.4	1°20'	0.28 23.3	12.69 322.3	16.38 416.1	2.63 66.8	2	1 x 6½ M24 x 165	28.0 12.7
12 300	12.750 323.9	350 24.1	44,686.7 198.78	0.25 6.4	1°7'	0.23 19.2	14.94 379.5	18.88 479.6	2.63 66.8	2	1 x 6½ M24 x 165	36.5 16.6

† Maximum pressure and end load are total from all loads based on standard weight steel pipe. Pressure ratings and end loads may differ on other pipe materials and/or wall thickness. Contact Tyco Fire & Building Products for details.

* Maximum available gap between pipe ends. minimum gap = 0.

‡ Maximum end gap and deflection are for cut grooved standard weight pipe. Values for roll grooved pipe will be ½ that of cut grooved.

Please refer to General Notes on page 14.

COUPLINGS

Figure 707 Heavy Duty Flexible Coupling

The Figure 707 Heavy Duty Flexible Coupling is capable of pressures up to 1000 psig (69 Bar) depending on pipe size and wall thickness. It provides a dependable method of joining pipe and is suitable for use in a variety of applications. Flexible couplings can act as an “expansion joint” allowing linear and angular movement of the pipes when properly installed.

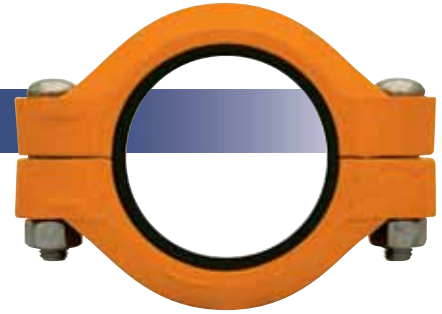

Tech Data: G130

GROOVED
COUPLINGS
& FITTINGS

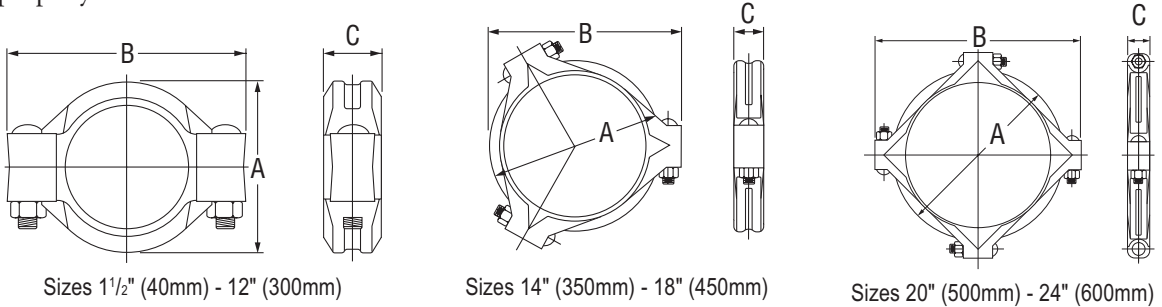





 For Fire Protection Pressure Rating and Listing / Approval information contact Tyco Fire & Building Products.

Nominal Size Inches mm	Pipe OD Inches mm	Max.† Pressures psi Bar	Max. End† Load Lbs. kN	Max. End*‡ Gap Inches mm	Deflection ‡		Nominal Dimensions			Coupling Bolts Qty	Approx. Weight Lbs. Kg	
					Degrees Per Coupling	Inches/ Foot mm/m	A Inches mm	B Inches mm	C Inches mm			
1 25	1.315 33.7	1000 69.0	1,360.0 6.10	0.13 3.3	5°26'	1.14 98.4	2.38 60.5	4.00 101.6	1.81 46.0	2	1/2 x 3 M12 x 76	2.0 0.9
1 1/2 40	1.900 48.3	1000 69.0	2,835.3 12.61	0.13 3.3	3°46'	0.79 65.8	2.97 75.4	4.63 117.6	1.81 46.0	2	1/2 x 3 M12 x 76	2.5 1.1
2 50	2.375 60.3	1000 69.0	4,430.1 19.71	0.13 3.3	3°1'	0.63 52.5	3.54 89.9	5.25 133.4	1.88 47.8	2	1/2 x 3 M12 x 76	3.0 1.4
2 1/2 65	2.875 73.0	1000 69.0	6,491.8 28.88	0.13 3.3	2°29'	0.52 43.3	4.06 103.1	5.75 146.1	1.88 47.8	2	1/2 x 3 M12 x 76	3.5 1.6
	3.000 76.1	1000 69.0	7,068.6 31.44	0.13 3.3	2°23'	0.50 41.7	4.19 106.4	5.75 146.1	1.88 47.8	2	M12 x 76	3.7 1.7
3 80	3.500 88.9	1000 69.0	9,621.1 42.80	0.13 3.3	2°3'	0.43 35.8	4.69 119.1	6.38 162.1	1.88 47.8	2	1/2 x 3 M12 x 76	4.0 1.8
4 100	4.500 114.3	1000 69.0	15,904.3 70.75	0.25 6.4	3°11'	0.67 55.8	5.95 151.1	8.25 209.6	2.06 52.3	2	5/8 x 3 1/4 M16 x 83	7.0 3.2
5 125	5.563 141.3	1000 69.0	24,305.7 108.12	0.25 6.4	2°35'	0.54 45.0	7.08 179.8	10.00 254.0	2.06 52.3	2	3/4 x 4 3/4 M20 x 121	10.5 4.8
	6.500 165.1	1000 69.0	33,183.1 147.61	0.25 6.4	2°12'	0.46 38.3	8.19 208.0	11.25 285.8	2.06 52.3	2	M20 x 121	12.5 5.7
6 150	6.625 168.3	1000 69.0	34,471.6 153.34	0.25 6.4	2°10'	0.45 37.5	8.30 210.8	11.25 285.8	2.06 52.3	2	3/4 x 4 3/4 M20 x 121	12.5 5.7
8 200	8.625 219.1	800 55.1	46,741.0 207.91	0.25 6.4	1°40'	0.35 29.2	10.68 271.3	14.00 355.6	2.47 62.7	2	7/8 x 6 1/2 M22 x 165	23.5 10.7
10 250	10.750 273.0	800 55.1	72,610.1 322.99	0.25 6.4	1°20'	0.28 23.3	13.06 331.7	16.44 417.6	2.63 66.8	2	1 x 6 1/2 M24 x 165	33.0 15.0
12 300	12.750 323.9	800 55.1	102,141.0 454.35	0.25 6.4	1°7'	0.23 19.2	15.39 390.9	18.84 478.5	2.63 66.8	2	1 x 6 1/2 M24 x 165	37.0 16.8
14 350	14.000 355.6	300 20.7	46,181.4 205.43	0.25 6.4	1°2'	0.22 18.3	16.67 423.4	20.38 517.7	2.94 74.7	2	1 x 5 1/2**	44.0 20.0
16 400	16.000 406.4	300 20.7	60,318.6 268.31	0.25 6.4	0°54'	0.19 15.8	18.83 478.3	22.64 575.1	2.94 74.7	2	1 x 5 1/2**	52.1 23.6
18 450	18.000 457.2	300 20.7	76,340.7 339.58	0.25 6.4	0°48'	0.17 14.2	21.31 541.3	25.12 638.0	3.06 77.7	2	1 x 5 1/2**	68.0 30.8
20 500	20.000 508.0	300 20.7	94,247.8 419.23	0.25 6.4	0°43'	0.15 12.5	23.47 596.1	27.88 708.2	3.06 77.7	2	1 1/8 x 5 3/4**	89.0 40.4
24 600	24.000 609.6	250 17.2	113,097.3 503.08	0.25 6.4	0°36'	0.13 10.8	27.58 700.5	32.00 812.8	3.19 81.0	2	1 1/8 x 5 3/4**	96.0 43.5

† Maximum pressure and end load are total from all loads based on standard weight steel pipe. Pressure ratings and end loads may differ on other pipe materials and/or wall thickness. Contact Tyco Fire & Building Products for details.
 * Maximum available gap between pipe ends. minimum gap = 0.
 ‡ Maximum end gap and deflection are for cut grooved standard weight pipe. Values for roll grooved pipe will be 1/2 that of cut grooved.
 ** Only available in ANSI bolt sizes.
 Please refer to General Notes on page 14.

COUPLINGS

Figure 716 Flexible Reducing Coupling

The Figure 716 Reducing Coupling is capable of pressures up to 500 psig (34.5 Bar) depending on pipe size and wall thickness. It provides a direct transition between two different pipe sizes, replacing two couplings and a reducing fitting.

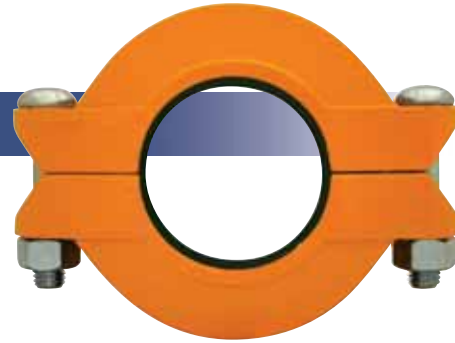

Tech Data: G120

GROOVED
COUPLINGS
& FITTINGS

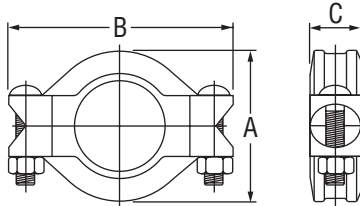

For Fire Protection Pressure Rating
and Listing / Approval information
contact Tyco Fire & Building Products.

Nominal Size Inches mm	Pipe OD Inches mm	Max.† Pressures psi Bar	Max. End† Load Lbs. kN	Max. End*‡ Gap Inches mm	Deflection ‡		Nominal Dimensions			Coupling Bolts		Approx. Weight Lbs. Kg
					Degrees Per Coupling	Inches/ Foot mm/m	A Inches mm	B Inches mm	C Inches mm	Qty	Size Inches mm	
2 x 1½ 50 x 40	2.375 x 1.900 60.3 x 48.3	500 34.5	1,417.6 6.31	0.13 3.3	1°53'	0.39 32.5	3.50 88.9	5.06 128.5	1.88 47.8	2	¾ x 2¼ M10 x 57	2.0 0.9
2½ x 2 65 x 50	2.875 x 2.375 73.0 x 60.3	500 34.5	2,215.1 9.85	0.13 3.3	1°33'	0.32 26.7	4.00 101.6	5.50 139.7	1.88 47.8	2	¾ x 2¼ M10 x 57	2.5 1.1
	3.000 x 2.375 76.1 x 60.3	500 34.5	2,215.1 9.85	0.13 3.3	1°34'	0.32 26.7	4.19 106.4	5.88 149.4	1.88 47.8	2	M12 x 76	3.1 1.4
3 x 2 80 x 50	3.500 x 2.375 88.9 x 60.3	500 34.5	2,215.1 9.85	0.13 3.3	1°17'	0.27 22.5	4.69 119.1	6.50 165.1	1.88 47.8	2	½ x 3 M12 x 76	4.5 2.0
3 x 2½ 80 x 65	3.500 x 2.875 88.9 x 73.0	500 34.5	3,245.9 14.44	0.13 3.3	1°17'	0.27 22.5	4.69 119.1	6.50 165.1	1.88 47.8	2	½ x 3 M12 x 76	4.6 2.1
	3.500 x 3.000 88.9 x 76.1	500 34.5	3,534.3 15.72	0.13 3.3	1°17'	0.27 22.5	4.69 119.1	6.50 165.1	1.88 47.8	2	M12 x 76	4.5 2.0
4 x 2 100 x 60	4.500 x 2.375 114.3 x 60.3	500 34.5	2,215.1 9.85	0.19 4.8	2°38'	0.55 45.8	6.00 152.4	8.13 206.5	2.00 50.8	2	⅝ x 3¼ M16 x 83	7.0 3.2
4 x 2½ 100 x 65	4.500 x 2.875 114.3 x 73.0	500 34.5	3,245.9 14.44	0.19 4.8	2°38'	0.55 45.8	6.00 152.4	8.13 206.5	2.00 50.8	2	⅝ x 3¼ M16 x 83	6.1 2.8
	4.500 x 3.000 114.3 x 76.1	500 34.5	3,534.3 15.72	0.19 4.8	2°38'	0.55 45.8	6.00 152.4	8.13 206.5	2.00 50.8	2	M16 x 83	6.2 2.8
4 x 3 100 x 80	4.500 x 3.500 114.3 x 88.9	500 34.5	4,810.6 21.40	0.19 4.8	2°38'	0.55 45.8	6.00 152.4	8.13 206.5	2.00 50.8	2	⅝ x 3¼ M16 x 83	6.2 2.8
	5.500 x 4.500 139.7 x 114.3	500 34.5	7,952.2 35.37	0.25 6.4	2°38'	0.55 45.8	7.06 179.3	9.50 241.3	2.06 52.3	2	M20 x 121	11.0 5.0
5 x 4 125 x 100	5.563 x 4.500 141.3 x 114.3	500 34.5	7,952.2 35.37	0.25 6.4	2°5'	0.44 36.7	7.13 181.1	9.56 242.8	2.06 52.3	2	¾ x 4¾ M20 x 121	10.1 4.6
	6.500 x 4.500 165.1 x 114.3	400 27.6	6,361.7 28.30	0.25 6.4	1°50'	0.38 31.7	8.18 207.8	10.81 274.6	2.06 52.3	2	M20 x 121	12.5 5.7
6 x 4 150 x 100	6.625 x 4.500 168.3 x 114.3	400 27.6	6,361.7 28.30	0.25 6.4	1°44'	0.36 30.0	8.38 212.9	10.88 276.4	2.06 52.3	2	¾ x 4¾ M20 x 121	12.5 5.7
6 x 5 150 x 125	6.625 x 5.563 168.3 x 141.3	400 27.6	9,722.3 43.25	0.25 6.4	1°44'	0.36 30.0	8.38 212.9	10.88 276.4	2.06 52.3	2	¾ x 4¾ M20 x 121	11.7 5.3
8 x 6 200 x 150	8.625 x 6.625 219.1 x 168.3	400 27.6	13,788.6 61.33	0.25 6.4	1°15'	0.26 21.7	10.69 271.5	13.75 349.3	2.25 57.2	2	7/8 x 6½ M22 x 165	23.5 10.7

† Maximum pressure and end load are total from all loads based on standard weight steel pipe. Pressure ratings and end loads may differ on other pipe materials and/or wall thickness. Contact Tyco Fire & Building Products for details.

* Maximum available gap between pipe ends. minimum gap = 0.

‡ Maximum end gap and deflection are for cut grooved standard weight pipe. Values for roll grooved pipe will be ½ that of cut grooved. Please refer to General Notes on page 14.

FLANGES

Figure 71 Flange Adapter (ANSI Class 125/150)

The Figure 71 Flange Adapter is capable of pressures up to 300 psig (20.7 Bar) depending on pipe size and wall thickness. It provides a direct transition from flanged components into a grooved piping system. I.P.S. size flange bolt patterns conform to ANSI Class 125 and 150.

The gasket seal is designed with optimum amount of rubber to provide a dependable seal and also avoid the overfilling of the gasket pocket which may cause assembly difficulties.

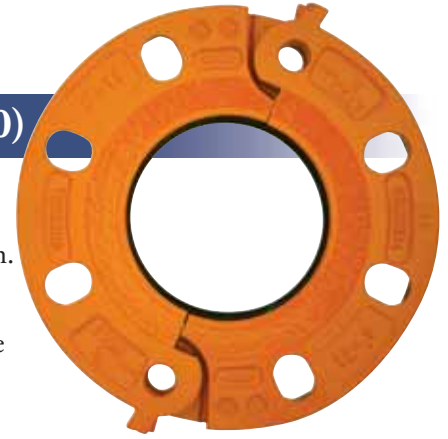

Tech Data: G150

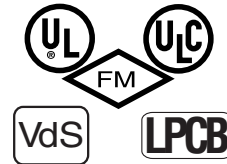
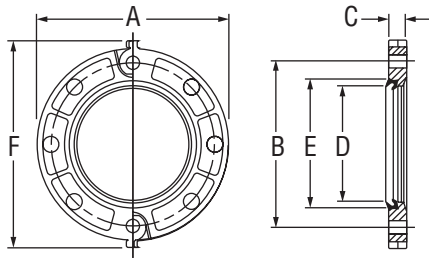

For Fire Protection Pressure Rating and Listing / Approval information contact Tyco Fire & Building Products.

Nominal Size Inches mm	Pipe OD Inches mm	Max.† Pressures psi Bar	Max. End† Load Lbs. kN	Nominal Dimensions						Bolts**		Approx. Weight Lbs. Kg
				A Inches mm	B Inches mm	C Inches mm	D* Inches mm	E* Inches mm	F Inches mm	Qty	Size Inches mm	
2 50	2.375 60.3	300 20.7	1,329.0 5.91	6.38 162.1	4.75 120.7	0.75 19.1	2.38 60.5	3.41 86.6	7.25 184.2	4	5/8 x 3	3.0 1.4
2½ 65	2.875 73.0	300 20.7	1,947.5 8.66	7.00 178.0	5.50 140.0	0.88 22.0	2.88 73.0	3.91 99.0	7.88 200.0	4	5/8 x 3	5.0 2.3
3 80	3.500 88.9	300 20.7	2,886.3 12.84	7.50 190.5	6.00 152.4	0.94 23.9	3.50 88.9	4.53 115.1	9.88 251.0	4	5/8 x 3	5.6 2.5
4 100	4.500 114.3	300 20.7	4,771.3 21.22	9.00 228.6	7.50 190.5	0.94 23.9	4.50 114.3	5.53 140.5	9.90 251.5	8	5/8 x 3	7.0 3.2
5 125	5.563 141.3	300 20.7	7,291.7 32.44	10.00 254.0	8.50 215.9	1.00 25.4	5.56 141.2	6.72 170.7	11.38 289.1	8	¾ x 3½	9.2 4.2
6 150	6.625 168.3	300 20.7	10,341.5 46.02	11.00 279.4	9.50 241.3	1.00 25.4	6.62 168.1	7.78 197.6	11.88 301.8	8	¾ x 3½	10.0 4.5
8 200	8.625 219.1	300 20.7	17,527.9 77.99	13.50 342.9	11.75 298.5	1.13 28.7	8.62 218.9	9.94 252.5	14.36 365.3	8	¾ x 3½	16.6 7.5
10 250	10.750 273.0	300 20.7	27,228.8 121.08	16.00 406.4	14.25 362.0	1.19 30.2	10.75 273.1	12.31 312.7	16.88 428.8	12	7/8 x 4	21.8 9.9
12 300	12.750 323.9	300 20.7	38,302.9 170.44	19.00 482.6	17.00 431.8	1.25 31.8	12.75 323.9	14.31 363.9	20.00 508.0	12	7/8 x 4	24.2 11.0

† Maximum pressure and end load are total from all loads based on standard weight steel pipe. Pressure ratings and end loads may differ on other pipe materials and/or wall thickness. Contact Tyco Fire & Building Products for details.

* Dimensions D and E represent minimum and maximum sealing surfaces.

** Bolts are not supplied. Bolt lengths shown are standard; it is the responsibility of the purchaser to verify correct length for the intended application.

Note: Metal flange washer adapters are required when the Figure 71 Flange Adapter is used against surfaces such as:

- Rubber surfaces
- Adapting to AWWA cast flanges
- Rubber faced wafer valves
- Serrated flange surfaces

Figure 71 Flange Adapters are not recommended for applications which incorporate tie rods for anchoring or on a standard fitting within 90° of each other. Contact Tyco Fire & Building Products for recommendations prior to using with plastic pipe.

Please refer to General Notes on page 14.

FLANGES

Flange Washer Adapter

Material: Stainless Steel ASTM A666 Type 304-2B

GROOVED
COUPLINGS
& FITTINGS

Nominal Size Inches mm	Pipe OD Inches mm	Nominal Dimensions	
		A Inches mm	B Inches mm
†2 50	2.375 60.3	3.94 100.0	2.75 69.9
‡2½ 65	2.875 73.0	4.69 119.1	2.75 69.9
*	3.000 76.1	4.89 124.2	2.88 73.2
‡	3.500 88.9	5.19 131.8	3.38 85.9
*3 80	3.500 88.9	5.48 139.2	3.38 85.9
‡4 100	4.500 114.3	6.69 169.9	4.38 111.3
*4 100	4.500 114.3	6.27 159.3	4.38 111.3
‡5 125	5.563 141.3	7.56 192.0	5.38 136.7
*	5.500 139.7	7.45 189.2	5.32 135.1
*	6.500 165.1	8.47 215.1	6.32 160.5
†6 150	6.625 168.3	8.56 217.4	6.44 163.6
‡8 200	8.625 219.1	10.81 274.6	8.44 214.4
*8 200	8.625 219.1	10.64 270.3	8.44 214.4
‡10 250	10.750 273.0	13.19 335.0	10.50 266.7
*10 250	10.750 273.0	12.85 326.4	10.50 266.7
‡12 300	12.750 323.9	15.94 404.9	12.50 317.5
*12 300	12.750 323.9	15.01 381.3	12.50 317.5

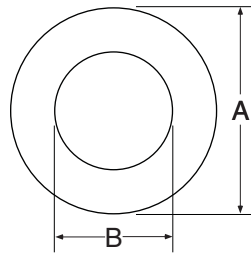

* DIN

† DIN and ANSI

‡ ANSI

Note: Metal flange washer adapters are required when the Figure 71

Flange Adapter is used against surfaces such as:

- Rubber surfaces
- Adapting to AWWA cast flanges
- Rubber faced wafer valves
- Serrated flange surfaces

Please refer to General Notes on page 14.

COUPLINGS

Figure 770 High Pressure Rigid Coupling

The Figure 770 High Pressure Rigid Coupling provides a rigid joint by firmly gripping along the full 360° circumference of the pipe grooves. The Figure 770 Rigid Coupling is a proven dependable method of joining pipe and is an economical alternative to welding, threading or using flanges. It is capable of pressures up to 1000 psi (69,0 bar) depending on pipe size and wall thickness.

Rigid Couplings are recommended for low temperature and vacuum applications.

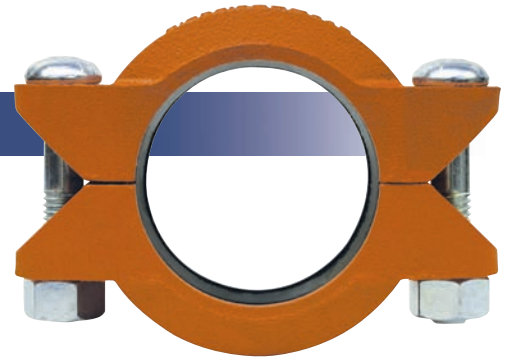

Tech Data: G138

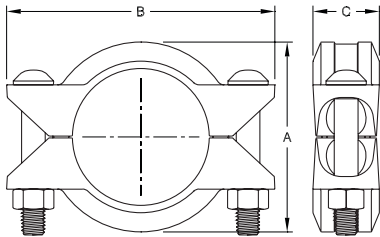

Nominal Size Inches DN	Pipe OD Inches mm	Max.† Pressures psi Bar	Max. End† Load Lbs. kN	Max. End*‡ Gap Inches mm	Nominal Dimensions			Coupling Bolts Qty	Approx. Weight Lbs. Kg
					A Inches mm	B Inches mm	C Inches mm		
2 DN50	2.375 60,3	1000 69,0	4,430.1 19,71	0.14 3,6	3.53 89,7	5.72 145,3	1.88 47,8	2 5/16 x 2 3/4 M16 x 70	4.3 2,0
2 1/2 DN65	2.875 73,0	1000 69,0	6,497.8 28,88	0.14 3,6	4.06 103,1	6.00 152,4	1.88 47,8	2 5/16 x 3 1/2 M16 x 89	5.0 2,3
3 DN80	3.500 88,9	1000 69,0	9,621.1 42,79	0.14 3,6	4.78 121,4	6.76 171,7	1.88 47,8	2 5/16 x 3 1/2 M16 x 89	5.3 2,4
4 DN100	4.500 114,3	1000 69,0	15,904.3 70,74	0.25 6,4	6.01 152,7	8.50 215,9	2.10 53,3	2 3/4 x 4 1/4 M20 x 108	7.7 3,5
6 DN150	6.625 168,3	1000 69,0	34,471.6 153,33	0.25 6,4	8.51 216,2	11.25 285,8	2.10 53,3	2 7/8 x 5 1/2 M22 x 140	16.2 7,3
8 DN200	8.625 219,1	800 55,1	46,741.0 207,90	0.25 6,4	10.93 277,6	13.75 349,3	2.60 66,0	2 1 x 5 1/2 M24 x 140	24.0 10,9
10 DN250	10.750 273,0	800 55,1	72,610.1 322,97	0.25 6,4	13.46 341,9	16.00 406,4	2.60 66,0	2 1 x 6 1/2 M24 x 165	32.0 14,5
12 DN300	12.750 323,9	800 55,1	102,141.0 454,32	0.25 6,4	15.52 394,2	18.00 457,2	2.60 66,0	2 1 x 6 1/2 M24 x 165	40.0 18,1

† Maximum pressure and end load are total from all loads based on standard weight steel pipe. Pressure ratings and end loads may differ on other pipe materials and/or wall thickness. Contact Tyco Fire & Building Products for details.

* Maximum available gap between pipe ends. minimum gap = 0.

** Gold color coded metric bolt sizes for DN50 - DN300 couplings are available upon request.

‡ Maximum end gap is for cut grooved standard weight pipe. Values for roll grooved pipe will be 1/2 that of cut grooved.

FITTINGS

Grinnell® Grooved Fittings provide an economical and efficient method of changing direction, adding an outlet, reducing, or capping grooved piping systems.

Grinnell Grooved Fittings are rated at the pressure rating of the coupling being used.

Tech Data: G180

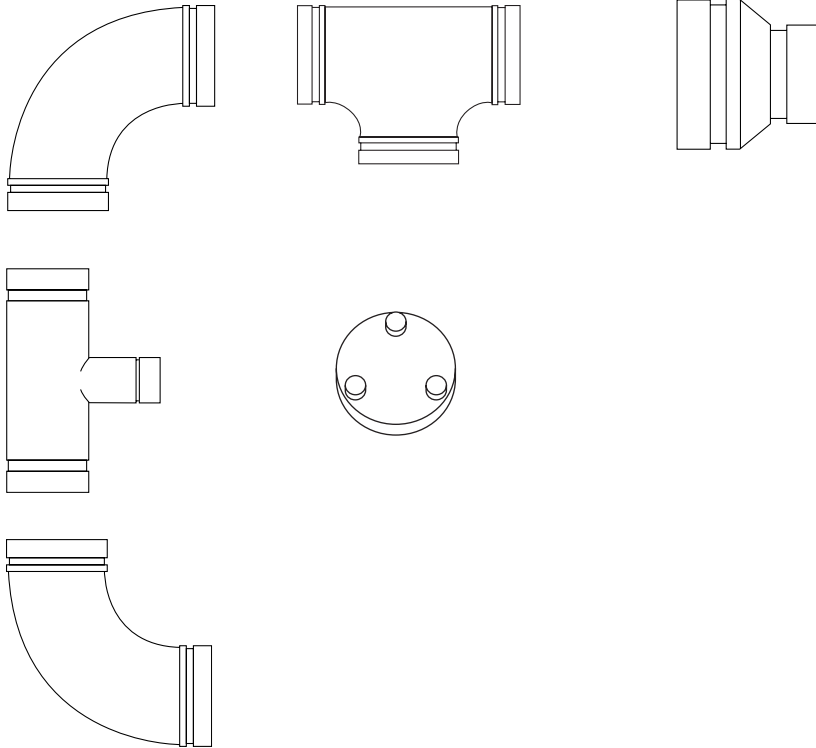

MATERIAL SPECIFICATIONS

Ductile Iron Fitting Specifications

- ASTM A-536 - Standard Specification for Ductile Iron Castings Grade 65-45-12
- Tensile Strength, minimum psi-65,000 (MPa-448)
- Yield Strength, minimum psi-45,000 (MPa-310)
- Elongation in 2" (50mm), minimum 12%
- ASTM A-153 - Standard Specification for Hot Dip Galvanizing

Fabricated Steel Fitting Specifications

- Carbon Steel: According to ASTM A-53 Grade B
- Tensile Strength, minimum psi-60,000 (MPa-415)
- Yield Strength, minimum psi-35,000 (MPa-240)
- Sizes 1¹/₄" – 6" are Schedule 40
- Sizes 8" – 12" are Schedule 30
- Sizes 14" – 24" are STD (.375)

Coatings

- Orange - non lead (standard)
- RAL Red - non lead (optional)

FITTINGS

Flow Data

Friction Resistance (Expressed as Equivalent Straight Pipe)					
Nominal Size	Pipe OD	Elbows 90°	Elbows 45°	Tee Branch	Tee Run
Inches	Inches	Feet	Feet	Feet	Feet
mm	mm	Meters	Meters	Meters	Meters
1¼	1.660	1.9	1.0	4.8	1.9
32	42.4	0.6	0.3	1.5	0.6
1½	1.900	2.3	1.2	5.8	2.3
40	48.3	0.7	0.4	1.8	0.7
2	2.375	3.2	1.6	8.0	3.2
50	60.3	1.0	0.5	2.5	1.0
2½	2.875	3.9	2.0	9.8	3.9
65	73.0	1.2	0.6	3.0	1.2
	3.000	4.1	2.1	10.3	4.1
	76.1	1.2	0.6	3.1	1.2
3	3.500	4.9	2.4	12.2	4.9
80	88.9	1.5	0.7	3.7	1.5
	4.250	6.5	3.3	16.3	6.5
	108.0	2.0	1.0	5.0	2.0
4	4.500	6.5	3.3	16.3	6.5
100	114.3	2.0	1.0	5.0	2.0
	5.250	8.0	4.0	20.0	8.0
	133.0	2.4	1.2	6.1	2.4
	5.500	8.0	4.1	20.0	8.0
	139.7	2.4	1.3	6.1	2.4
5	5.563	8.2	4.1	20.5	8.2
125	141.3	2.5	1.3	6.3	2.5
	6.250	9.5	4.8	23.8	9.5
	159.0	2.9	1.4	7.2	2.9
	6.500	9.5	4.8	23.8	9.5
	165.1	2.9	1.4	7.2	2.9
6	6.625	9.9	5.0	24.8	9.9
150	168.3	3.0	1.5	7.6	3.0
	8.500	13.1	6.6	32.8	13.1
	216.3	4.0	2.0	10.0	4.0
8	8.625	13.1	6.6	32.8	13.1
200	219.1	4.0	2.0	10.0	4.0
10	10.750	16.5	8.3	41.3	16.5
250	273.0	5.0	2.5	12.6	5.0
12	12.750	19.9	9.9	49.7	19.9
300	323.9	6.1	3.0	15.1	6.1
14	14.000	23.0	18.0	67.9	23.0
350	355.6	7.0	5.5	20.7	7.0
16	16.000	25.9	20.0	78.1	25.9
400	406.4	7.9	6.1	23.8	7.9
18	18.000	28.9	23.0	85.0	28.9
450	457.2	8.8	7.0	25.9	8.8
20	20.000	33.1	25.9	100.1	33.1
500	508.0	10.1	7.9	30.5	10.1
24	24.000	40.0	29.9	115.2	40.0
600	609.6	12.2	9.1	35.1	12.2

For the reducing tee branches, use the value that is corresponding to the branch size. *Example:* For 8" x 8" x 2" (200mm x 200mm x 50mm) tee, the branch value of 2" (50mm) is 8.0 feet (2.5 meters).

For sizes not listed, interpolate from the values shown.

Please refer to General Notes on page 14.



GROOVED
COUPLINGS
& FITTINGS

FITTINGS

Figure 210 & 310 90° Elbow

Nominal Size	Pipe OD	210 Cast		310 Fabricated Long Radius	
		Nominal C to E	Approx Weight	Nominal C to E	Approx Weight
Inches	Inches	Inches	Lbs.	Inches	Lbs.
mm	mm	mm	Kg	mm	Kg
1 1/4 32	1.660 42.4	2.75 69.9	1.0 0.5	3.88 98.6	1.4 0.6
1 1/2 40	1.900 48.3	2.75 69.9	1.2 0.6	4.25 108.0	1.8 0.8
2 50	2.375 60.3	3.25 82.6	2.0 0.9	4.38 111.3	2.5 1.1
2 1/2 65	2.875 73.0	3.75 95.3	3.0 1.4	5.75 146.1	5.0 2.3
	3.000 76.1	3.75 95.3	3.0 1.4	—	—
3 80	3.500 88.9	4.25 108.0	4.5 2.0	5.88 149.4	6.5 2.9
	4.250 108.0	4.75 120.7	8.5 3.9	—	—
4 100	4.500 114.3	5.00 127.0	8.5 3.9	7.50 190.5	11.7 5.3
	5.250 133.0	5.25 133.4	11.3 5.1	—	—
	5.500 139.7	5.50 139.7	11.3 5.1	—	—
5 125	5.563 141.3	5.50 139.7	13.5 6.1	9.50 241.3	21.0 9.5
	6.250 159.0	6.00 152.4	14.6 6.6	—	—
	6.500 165.1	6.50 165.1	18.5 8.4	—	—
6 150	6.625 168.3	6.50 165.1	18.5 8.4	10.75 273.1	30.0 13.6
	8.500 216.3	7.75 196.9	36.5 16.6	—	—
8 200	8.625 219.1	7.75 196.9	36.5 16.6	15.00 381.0	60.0 27.2
10 250	10.750 273.0	9.00 228.6	60.0 27.2	18.00 457.2	100.0 45.4
12 300	12.750 323.9	10.00 254.0	67.0 30.4	21.00 533.4	140.0 63.5
14 350	14.000 355.6	—	—	21.00 533.4	180.0 81.6
16 400	16.000 406.4	—	—	24.00 609.6	220.0 99.8
18 450	18.000 457.2	—	—	27.00 685.8	280.0 127.0
20 500	20.000 508.0	—	—	32.00 838.2	350.0 158.8
24 600	24.000 609.6	—	—	36.00 914.4	480.0 217.7

Please refer to General Notes on page 14.

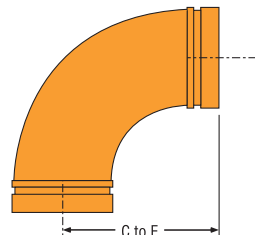

FIGURE 210 CAST

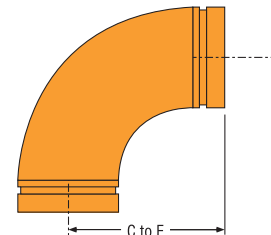

FIGURE 310 FABRICATED (FULL FLOW)

Figure 316 Reducing Base Support Elbow

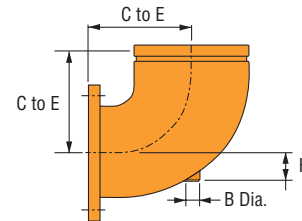

FIGURE 316 FABRICATED GROOVED X FLANGED

316 Fabricated					
Nominal Size	Grooved End OD	Center to End	H	B Dia.	Approx. Wt. Ea.
Inches	Inches	Inches	Inches	Threaded	Lbs
mm	mm	mm	mm	NPSC	Kg
6 x 4 150 x 100	6.625 168.3	12 305	2 1/2 64	1 1/2 38	38.5 17.5
6 x 5 150 x 125	6.625 168.3	12 1/2 318	2 1/2 64	1 1/2 38	45.4 20.6
8 x 5 200 x 125	8.625 219.1	16 406	3 76	1 1/2 38	65.5 29.7
8 x 6 200 x 150	8.625 219.1	16 406	3 76	1 1/2 38	73 33.1
10 x 6 250 x 150	10.750 273.1	19 483	3 1/2 89	1 1/2 38	100 45.4
10 x 8 250 x 200	10.750 273.1	19 483	3 1/2 89	1 1/2 38	127 57.6
12 x 8 300 x 200	12.750 323.9	22 559	4 102	1 1/2 38	155 70.3
12 x 10 300 x 250	12.750 323.9	22 559	4 102	1 1/2 38	186 84.4

FITTINGS

Figure 201 & 301 45° Elbow

Nominal Size	Pipe OD	201 Cast		301 Fabricated Long Radius	
		Nominal C to E	Approx Weight	Nominal C to E	Approx Weight
Inches mm	Inches mm	Inches mm	Lbs. Kg	Inches mm	Lbs. Kg
1¼ 32	1.660 42.4	1.75 44.5	0.9 0.4	2.50 63.5	1.1 0.5
1½ 40	1.900 48.3	1.75 44.5	1.1 0.5	2.50 63.5	1.3 0.6
2 50	2.375 60.3	2.00 50.8	1.8 0.8	2.75 69.9	1.8 0.8
2½ 65	2.875 73.0	2.25 57.2	2.2 1.0	3.00 76.2	2.9 1.3
	3.000 76.1	2.25 57.2	2.2 1.0	— —	— —
3 80	3.500 88.9	2.50 63.5	3.5 1.6	3.38 85.9	4.6 2.1
	4.250 108.0	2.88 73.0	5.5 2.5	— —	— —
4 100	4.500 114.3	3.00 76.2	5.2 2.4	4.00 101.6	7.5 3.4
	5.250 133.0	3.25 82.6	7.7 3.5	— —	— —
	5.500 139.7	3.25 82.6	7.7 3.5	— —	— —
5 125	5.563 141.3	3.25 82.6	8.5 3.9	5.00 127.0	12.5 5.7
	6.250 159.0	3.50 88.9	12.0 5.4	— —	— —
	6.500 165.1	3.50 88.9	12.0 5.4	— —	— —
6 150	6.625 168.3	3.50 88.9	12.0 5.4	5.50 139.7	12.0 5.4
	8.500 216.3	4.25 108.0	23.0 10.4	— —	— —
8 200	8.625 219.1	4.25 108.0	23.0 10.4	7.25 184.2	34.0 15.4
10 250	10.750 273.0	4.75 120.7	31.0 14.1	8.50 215.9	56.0 25.4
12 300	12.750 323.9	5.25 133.4	40.0 18.1	10.00 254.0	98.0 44.5
14 350	14.000 355.6	— —	— —	8.75 228.3	105.0 47.6
16 400	16.000 406.4	— —	— —	10.00 254.0	115.0 52.2
18 450	18.000 457.2	— —	— —	11.25 285.8	145.0 65.8
20 500	20.000 508.0	— —	— —	12.50 317.5	180.0 81.6
24 600	24.000 609.6	— —	— —	15.00 381.0	250.0 113.4

Please refer to General Notes on page 14.



GROOVED
COUPLINGS
& FITTINGS

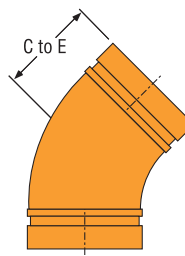

FIGURE 201 CAST

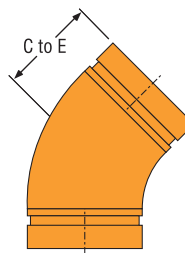

FIGURE 301 FABRICATED (FULL FLOW)

FITTINGS

Figure 312 22¹/₂° Elbow

Nominal Size	Pipe OD	312 Fabricated	
		Nominal C to E	Approx Weight
Inches <i>mm</i>	Inches <i>mm</i>	Inches <i>mm</i>	Lbs. <i>Kg</i>
1 ¹ / ₄	1.660	1.75	0.4
32	42.4	44.5	0.2
1 ¹ / ₂	1.900	1.75	0.5
40	48.3	44.5	0.2
2	2.375	1.88	0.6
50	60.3	47.8	0.3
2 ¹ / ₂	2.875	2.00	0.7
65	73.0	50.8	0.3
3	3.500	2.25	1.4
80	88.9	57.2	0.6
4	4.500	2.63	2.4
100	114.3	66.8	1.1
5	5.563	2.88	4.1
125	141.3	73.2	1.9
6	6.625	3.13	5.6
150	168.3	79.5	2.5
8	8.625	3.88	11.1
200	219.1	98.6	5.0
10	10.750	4.38	14.0
250	273.0	111.3	6.4
12	12.750	4.88	22.0
300	323.9	124.0	10.0
14	14.000	5.00	46.0
350	355.6	127.0	20.9
16	16.000	5.00	52.2
400	406.4	127.0	23.7
18	18.000	5.50	65.0
450	457.2	139.7	29.5
20	20.000	6.00	80.0
500	508.0	152.4	36.3
24	24.000	7.00	112.0
600	609.6	177.8	50.8

Please refer to General Notes on page 14.

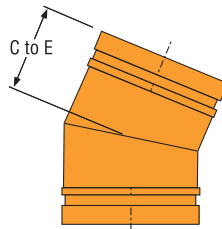

FIGURE 312 FABRICATED

Figure 313 11¹/₄° Elbow

Nominal Size	Pipe OD	313 Fabricated	
		Nominal C to E	Approx Weight
Inches <i>mm</i>	Inches <i>mm</i>	Inches <i>mm</i>	Lbs. <i>Kg</i>
1 ¹ / ₄	1.660	1.38	0.4
32	42.4	35.1	0.2
1 ¹ / ₂	1.900	1.38	0.5
40	48.3	35.1	0.2
2	2.375	1.38	0.6
50	60.3	35.1	0.3
2 ¹ / ₂	2.875	1.50	1.1
65	73.0	38.1	0.5
3	3.500	1.50	1.2
80	88.9	38.1	0.5
4	4.500	1.75	2.2
100	114.3	44.5	1.0
5	5.563	2.00	3.3
125	141.3	50.8	1.5
6	6.625	2.00	4.6
150	168.3	50.8	2.1
8	8.625	2.00	8.7
200	219.1	50.8	3.9
10	10.750	2.13	9.1
250	273.0	54.1	4.1
12	12.750	2.25	16.7
300	323.9	57.2	7.6
14	14.000	3.50	32.1
350	355.6	88.9	14.6
16	16.000	4.00	42.0
400	406.4	101.6	19.1
18	18.000	4.50	53.2
450	457.2	114.3	24.2
20	20.000	5.00	65.7
500	508.0	127.0	29.8
24	24.000	6.00	96.0
600	609.6	152.4	43.5

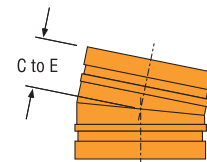
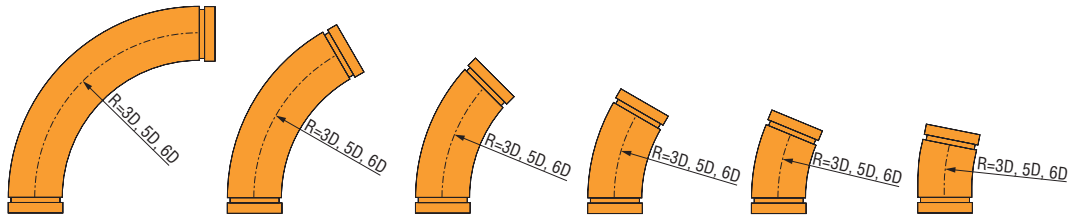

FIGURE 313 FABRICATED

Please refer to General Notes on page 14.

FITTINGS

Long Radius Elbows 3D



GROOVED
COUPLINGS
& FITTINGS

Nominal Size Inches mm	Pipe OD Inches mm	310-3D 90° Elbow		306-3D 60° Elbow		301-3D 45° Elbow		303-3D 30° Elbow		312-3D 22½° Elbow		313-3D 11¼° Elbow	
		Center to End Inches mm	Approx Weight Lbs. Kg	Center to End Inches mm	Approx Weight Lbs. Kg	Center to End Inches mm	Approx Weight Lbs. Kg	Center to End Inches mm	Approx Weight Lbs. Kg	Center to End Inches mm	Approx Weight Lbs. Kg	Center to End Inches mm	Approx Weight Lbs. Kg
2 50	2.375 60.3	10 254	5.3 2.4	7½ 191	4.3 2	6½ 165	3.9 1.8	5¾ 146	3.4 1.5	5¼ 133	3.2 1.5	4½ 114	2.8 1.3
2½ 65	2.875 73.0	11½ 292	9.5 4.3	8¾ 210	7.7 3.5	7¼ 184	6.7 3	6 152	5.8 2.6	5½ 140	5.3 2.4	4¾ 121	4.6 2.1
3 80	3.500 88.9	13 330	14 6.4	9¼ 235	11 5	7¾ 197	9.5 4.3	6½ 165	8 3.6	5¾ 146	7.3 3.3	5 127	6.2 2.8
3½ 90	4.000 101.6	14½ 368	18.6 8.4	10 254	14.4 6.5	8½ 216	12.3 5.6	6¾ 171	10.2 4.6	6 152	9.2 4.2	5 127	7.6 3.4
4 100	4.500 114.3	16 406	24.1 10.9	11 279	18.5 8.4	9 229	15.7 7.1	7¼ 184	12.8 5.8	6½ 165	11.4 5.2	5¼ 133	9.3 4.2
5 125	5.563 141.3	20 508	40.9 18.6	13¾ 349	31.3 14.2	11¼ 286	26.5 12	9 229	21.8 9.9	8 203	19.4 8.8	6½ 165	15.8 7.2
6 150	6.625 168.3	24 610	63.7 28.9	16½ 419	48.8 22.1	13½ 343	41.3 18.7	10¾ 273	33.9 15.4	9½ 241	30.1 13.7	7¾ 197	24.6 11.2
8 200	8.625 219.1	32 813	127.8 58	22 559	97.9 44.4	18 457	82.9 37.6	14½ 368	68 30.8	12¾ 324	60.5 27.4	10½ 267	49.3 22.4
10 250	10.750 273.1	40 1016	226.4 102.7	27¼ 692	173.4 78.7	22½ 572	146.9 66.6	18 457	120.5 54.7	16 406	107.2 48.6	13 330	87.3 39.6
12 300	12.750 323.9	48 1219	332.7 150.9	32¾ 832	254.8 115.6	27 686	215.9 97.9	21¾ 552	177 80.3	19¼ 489	157.5 71.4	15½ 394	128.3 58.2
14 350	14.000 355.6	56 1422	427.3 193.8	38¼ 972	327.3 148.5	31½ 800	227.3 103.1	25¼ 641	227.3 103.1	22½ 572	202.3 91.8	18¼ 464	164.8 74.8
16 400	16.000 406.4	64 1626	560.1 254.1	43¾ 1111	429 194.6	36 914	363.5 164.9	29 737	297.9 135.1	25½ 648	265.2 120.3	20¾ 527	216 98
18 450	18.000 457.2	72 1829	710.7 322.4	49¼ 1251	544.4 246.9	40½ 1029	461.3 209.2	32½ 826	378.1 171.5	28¾ 730	336.5 152.6	23.35 593	274.1 124.3
20 500	20.000 508.0	80 2032	879.3 398.8	54¾ 1391	673.5 305.5	45 1143	540.7 245.3	36 914	467.8 212.2	32 813	416.3 188.8	26 660	339.2 153.9
24 600	24.000 609.6	96 2438	1270.3 576.2	65½ 1664	973 441.3	53¾ 1365	824.4 373.9	43¼ 1099	675.7 306.5	38¼ 972	601.4 272.8	31 787	490 222.3

Notes: Long radius elbows 3D, 5D and 6D in sizes up to and including 4" are provided with 4" (101.6mm) long integral tangent. Remaining sizes provided with integral tangents with lengths equal to nominal pipe size.

Grooved or plain-end available – specify choice on order.

Material: standard wall steel pipe to ASTM A53, Grade B. (Other materials available on request).

Bends to conform to above radii.

C to E tolerances: 2" through 6" ± 1/8" (3.2 mm); 8" through 16" ± 1/4" (6.4 mm); 18" through 24" + 3/8" (9.5mm).

All weights are approximate, based on calculated weight of pipe.

FITTINGS

Long Radius Elbows 5D

GROOVED
COUPLINGS
& FITTINGS

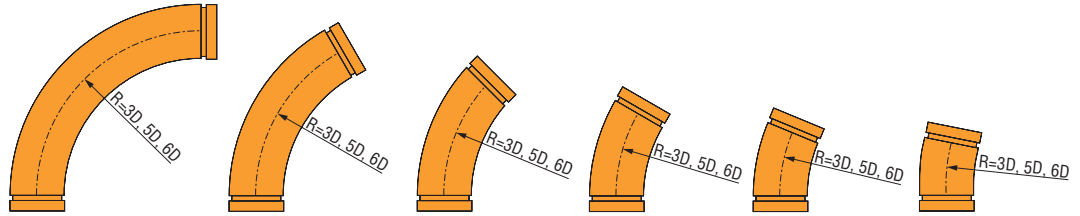

Nominal Size Inches mm	Pipe OD Inches mm	310-5D 90° Elbow		306-5D 60° Elbow		301-5D 45° Elbow		303-5D 30° Elbow		312-5D 22½° Elbow		313-5D 11¼° Elbow	
		Center to End Inches mm	Approx Weight Lbs. Kg	Center to End Inches mm	Approx Weight Lbs. Kg	Center to End Inches mm	Approx Weight Lbs. Kg	Center to End Inches mm	Approx Weight Lbs. Kg	Center to End Inches mm	Approx Weight Lbs. Kg	Center to End Inches mm	Approx Weight Lbs. Kg
2	2.375	14	7.2	9¼	5.6	8¼	4.8	6¾	4	6	3.6	5	3
50	60.3	356	3.3	248	2.5	210	2.2	171	1.8	152	1.6	127	1.4
2½	2.875	16½	13.3	11¼	10.2	9¼	8.6	7½	7	6½	6.2	5¼	5
65	73.0	419	6	286	4.6	235	3.9	191	3.2	165	2.8	133	2.3
3	3.500	19	19.9	12¾	15	10¼	12.5	8	10	7	8.8	5½	6.9
80	88.9	483	9	324	6.8	260	5.7	203	4.5	178	4	140	3.1
3½	4.000	21½	26.9	12¼	20	11¼	16.5	8¾	13	7½	11.3	5¼	8.7
90	101.6	546	12.2	311	9.1	286	7.5	222	5.9	191	5.1	146	3.9
4	4.500	24	35.4	15½	26	12½	21.3	9½	16.6	8	14.3	6	10.7
100	114.3	610	16.1	394	11.8	318	9.7	241	7.5	203	6.5	152	4.9
5	5.563	30	60	19½	44.1	15½	36.1	11¾	28.1	10	24.1	7½	18.2
125	141.3	762	27.2	495	20	394	16.4	298	12.7	254	10.9	191	8.3
6	6.625	36	93.5	23¼	68.6	18½	56.2	14	43.8	12	37.6	9	28.3
150	168.3	914	42.4	591	31.1	470	25.5	356	19.9	305	17.1	229	12.8
8	8.625	48	187.6	31	137.7	24½	112.8	18¾	87.9	16	75.4	12	56.8
200	219.1	1219	85.1	787	62.5	622	51.2	476	39.9	406	34.2	305	25.8
10	10.750	60	332.4	39	244.1	30¾	199.9	23½	155.8	20	133.7	15	100.6
250	273.1	1524	150.8	991	110.7	781	90.7	597	70.7	508	60.6	381	45.6
12	12.750	72	488.4	46¾	358.6	37	293.7	28	228.9	24	196.4	18	147.8
300	323.9	1829	221.5	1187	162.7	940	133.2	711	103.8	610	89.1	457	67
14	14.000	84	627.4	54½	460.7	43	377.3	32¾	294	28	252.3	21	189.8
350	355.6	2134	284.6	1384	209	1092	171.1	832	133.4	711	114.4	533	86.1
16	16.000	96	822.2	62¼	603.8	49¼	494.5	37½	385.3	32	330.7	24	248.8
400	406.4	2438	372.9	1581	273.9	1251	224.3	953	174.8	813	150	610	112.9
18	18.000	108	1,043.40	70	766.2	55¼	627.6	42¼	489	36	419.7	27	315.7
450	457.2	2743	473.3	1778	347.5	1403	284.7	1073	221.8	914	190.4	686	143.2
20	20.000	120	1,290.90	77¾	947.90	61½	776.4	46¾	605	40	519.2	30	390.6
500	508.0	3048	585.5	1975	430	1562	352.2	1187	274.4	1016	235.5	762	177.2
24	24.0000	144	1,864.80	93¼	1,369.30	73¾	1,121.60	56¼	873.9	48	750.1	35¾	564.3
600	609.6	3658	845.9	2369	621.1	1873	508.7	1429	396.4	1219	340.2	908	256

Notes: Long radius elbows 3D, 5D and 6D in sizes up to and including 4" are provided with 4" (101.6mm) long integral tangent. Remaining sizes provided with integral tangents with lengths equal to nominal pipe size.

Grooved or plain-end available – specify choice on order.

Material: standard wall steel pipe to ASTM A53, Grade B. (Other materials available on request).

Bends to conform to above radii.

C to E tolerances: 2" through 6" ± 1/8" (3.2 mm); 8" through 16 ± 1/4" (6.4 mm); 18" through 24" + 3/8" (9.5mm).

All weights are approximate, based on calculated weight of pipe.

FITTINGS

Long Radius Elbows 6D

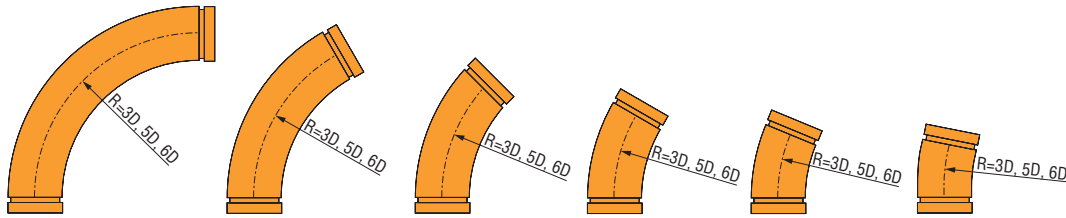

GROOVED
COUPLINGS
& FITTINGS

Nominal Size Inches mm	Pipe OD Inches mm	310-6D 90° Elbow		306-6D 60° Elbow		301-6D 45° Elbow		303-6D 30° Elbow		312-6D 22½° Elbow		313-6D 11¼° Elbow	
		Center to End Inches mm	Approx Weight Lbs. Kg	Center to End Inches mm	Approx Weight Lbs. Kg	Center to End Inches mm	Approx Weight Lbs. Kg	Center to End Inches mm	Approx Weight Lbs. Kg	Center to End Inches mm	Approx Weight Lbs. Kg	Center to End Inches mm	Approx Weight Lbs. Kg
2	2.375	16	8.2	11	6.3	9	5.3	7¼	4.3	6½	3.9	5¼	3.2
50	60.3	406	3.7	279	2.9	229	2.4	184	2	165	1.8	133	1.5
2½	2.875	19	15.2	12¾	11.4	10¼	9.5	8	7.7	7	6.7	5½	5.3
65	73.0	483	6.9	324	5.2	260	4.3	203	3.5	178	3	140	2.4
3	3.500	22	22.9	14½	17	11½	14	8¾	11	7½	9.5	5¾	7.3
80	88.9	559	10.4	368	7.7	292	6.4	222	5	191	4.3	146	3.3
3½	4.000	25	31.1	16¼	22.8	12¾	18.6	9¾	14.4	8¼	12.3	6	9.2
90	101.6	635	14.1	413	10.3	324	8.4	248	6.5	210	5.6	152	4.2
4	4.500	28	41.1	18	29.8	14	24.1	10½	18.5	8¾	15.7	6½	11.4
100	114.3	711	18.6	457	13.5	356	10.9	267	8.4	222	7.1	165	5.2
5	5.563	35	69.6	22¼	50.5	17½	40.9	13	31.3	11	26.5	8	19.4
125	141.3	889	31.6	565	22.9	445	18.6	330	14.2	279	12	203	8.8
6	6.625	42	108.4	26¾	78.6	21	63.7	15¾	48.8	13¼	41.3	9½	30.1
150	168.3	1067	49.2	679	35.7	533	28.9	400	22.1	337	18.7	241	13.7
8	8.625	56	217.5	35¾	157.7	28	127.8	21	97.9	17½	82.9	12¾	60.5
200	219.1	1422	98.7	908	71.5	711	58	533	44.4	445	37.6	324	27.4
10	10.750	70	385.4	44¾	279.4	35	226.4	26	173.4	22	146.9	16	107.2
250	273.1	1778	174.8	1137	126.7	889	102.7	660	78.7	559	66.6	406	48.6
12	12.750	84	566.2	53¼	410.5	41¾	332.7	31¼	254.8	26¼	215.9	19	157.5
300	323.9	2134	256.8	1359	186.2	1060	150.9	794	115.6	667	97.9	483	71.4
14	14.000	98	727.4	62½	527.3	48¾	427.3	36½	327.3	30¾	277.3	22¼	202.3
350	355.6	2489	329.9	1588	239.2	1238	193.8	927	148.5	781	125.8	565	91.8
16	16.000	112	953.3	71½	691.1	55¾	560.1	41¾	429	35¼	363.5	25½	265.2
400	406.4	2845	432.4	1816	313.5	1416	254.1	1060	194.6	895	164.9	648	120.3
18	18.000	126	1,209.70	80½	877.1	62¾	710.7	47	544.4	39½	461.3	28¾	336.5
450	457.2	3200	548.7	2045	397.8	1594	322.4	1194	246.9	1003	209.2	730	152.6
20	20.000	140	1,496.60	89¼	1,085.10	69¾	879.3	52¼	673.5	44	570.7	31¾	416.3
500	508.0	3556	678.8	2267	492.2	1772	398.8	1327	305.5	1118	258.9	806	188.8
24	24.000	168	2,162.00	107¼	1,567.50	83¾	1,270.30	62½	973	52.34	824.4	38¼	601.4
600	609.6	4267	980.7	2724	711	2127	576.2	1588	441.3	1329	373.9	972	272.8

Notes: Long radius elbows 3D, 5D and 6D in sizes up to and including 4" are provided with 4" (101.6mm) long integral tangent. Remaining sizes provided with integral tangents with lengths equal to nominal pipe size.

Grooved or plain-end available – specify choice on order.

Material: standard wall steel pipe to ASTM A53, Grade B. (Other materials available on request).

Bends to conform to above radii.

C to E tolerances: 2" through 6" $\pm \frac{1}{8}$ " (3.2 mm); 8" through 16" $\pm \frac{1}{4}$ " (6.4 mm); 18" through 24" $\pm \frac{3}{8}$ " (9.5mm).

All weights are approximate, based on calculated weight of pipe.

FITTINGS

Figure 219 & 319 Tee

Nominal Size	Pipe OD	219 Cast		319 Fabricated	
		Nominal C to E	Approx Weight	Nominal C to E	Approx Weight
Inches mm	Inches mm	Inches mm	Lbs. Kg	Inches mm	Lbs. Kg
1 1/4 32	1.660 42.4	2.75 69.9	1.4 0.6	- -	- -
1 1/2 40	1.900 48.3	2.75 69.9	1.8 0.8	- -	- -
2 50	2.375 60.3	3.25 82.6	2.7 1.2	- -	- -
2 1/2 65	2.875 73.0	3.75 95.3	5.8 2.6	- -	- -
	3.000 76.1	3.75 95.3	5.8 2.6	- -	- -
3 80	3.500 88.9	4.25 108.0	7.0 3.2	- -	- -
	4.250 108.0	4.75 120.7	11.5 5.2	- -	- -
4 100	4.500 114.3	5.00 127.0	11.8 5.4	- -	- -
	5.250 133.0	5.25 133.4	10.6 4.8	- -	- -
	5.500 139.7	5.50 139.7	15.2 6.9	- -	- -
5 125	5.563 141.3	5.50 139.7	17.0 7.7	- -	- -
	6.250 159.0	6.00 152.4	13.9 6.3	- -	- -
	6.500 165.1	6.50 165.1	26.0 11.8	- -	- -
6 150	6.625 168.3	6.50 165.1	26.0 11.8	- -	- -
	8.500 216.3	7.75 196.9	45.0 20.4	- -	- -
8 200	8.625 219.1	7.75 196.9	45.0 20.4	- -	- -
10 250	10.750 273.0	9.00 228.6	72.1 32.7	- -	- -
12 300	12.750 323.9	10.00 254.0	92.5 42.0	- -	- -
14 350	14.000 355.6	- -	- -	11.00 279.0	48.0 53.5
16 400	16.000 406.4	- -	- -	12.00 305.0	146.0 66.2
18 450	18.000 457.2	- -	- -	15.50 394.0	218.0 98.9
20 500	20.000 508.0	- -	- -	17.25 438.0	275.0 125.0
24 600	24.000 609.6	- -	- -	20.00 508.0	379.0 172.0

Please refer to General Notes on page 14.

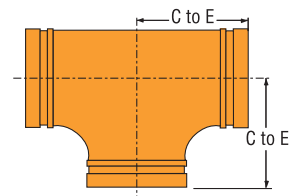

FIGURE 219 CAST

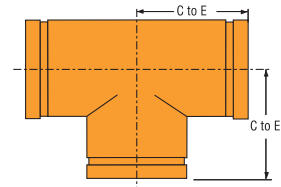

FIGURE 319 FABRICATED

FITTINGS

Figure 315 Groove x Male Thread 90° Elbow Figure 320 Groove x Groove x Male Thread Tee

Nominal Size	Pipe OD	315 Fabricated			320 Fabricated		
		Nominal C to GE	Nominal C to TE	Approx Weight	Nominal C to GE	Nominal C to TE	Approx Weight
Inches mm	Inches mm	Inches mm	Inches mm	Lbs. Kg	Inches mm	Inches mm	Lbs. Kg
1 1/4 32	1.660 42.4	2.75 69.9	2.75 69.9	1.0 0.5	2.75 69.9	2.75 69.9	1.5 0.7
1 1/2 40	1.900 48.3	2.75 69.9	2.75 69.9	1.2 0.5	2.75 69.9	2.75 69.9	1.9 0.9
2 50	2.375 60.3	3.25 82.6	4.25 108.0	2.3 1.0	3.25 82.6	4.25 108.0	3.2 1.5
2 1/2 65	2.875 73.0	3.75 95.3	3.75 95.3	3.7 1.7	3.75 95.3	3.75 95.3	4.0 1.8
3 80	3.500 88.9	4.25 108.0	6.00 152.4	6.5 2.9	4.25 108.0	6.00 152.4	6.0 2.7
4 100	4.500 114.3	5.00 127.0	7.25 184.2	11.0 5.0	5.00 127.0	7.25 184.2	11.0 5.0
5 125	5.563 141.3	–	–	–	5.50 139.7	5.50 139.7	23.0 10.5
6 150	6.625 168.3	6.50 165.1	6.50 165.1	19.8 9.0	6.50 165.1	6.50 165.1	23.0 10.5
8 200	8.625 219.1	–	–	–	7.75 196.9	7.75 196.9	38.7 17.6
10 250	10.750 273.0	–	–	–	9.00 228.6	9.00 228.6	72.1 32.8
12 300	12.750 323.9	–	–	–	10.00 254.0	10.00 254.0	92.5 42.0

Please refer to General Notes on page 14.

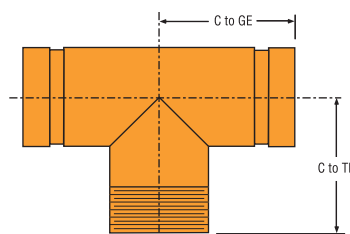

FIGURE 320 FABRICATED

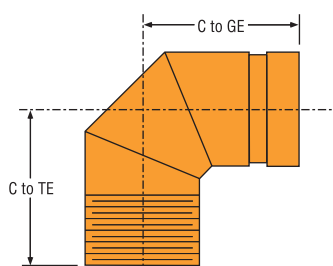

FIGURE 315 FABRICATED

GROOVED
COUPLINGS
& FITTINGS

FITTINGS

Figure 260 & 360 End Cap

GROOVED
COUPLINGS
& FITTINGS

Nominal Size	Pipe OD	260 Cast		360 Fabricated	
		Nominal E to E Inches	Approx Weight Lbs.	Nominal E to E Inches	Approx Weight Lbs.
Inches	Inches	Inches	Kg	Inches	Kg
1 1/4	1.660	0.88	0.4	-	-
32	42.4	22.4	0.2	-	-
1 1/2	1.900	0.88	0.6	-	-
40	48.3	22.4	0.3	-	-
2	2.375	0.88	0.9	-	-
50	60.3	22.4	0.4	-	-
2 1/2	2.875	0.88	0.9	-	-
65	73.0	22.4	0.4	-	-
	3.000	0.94	1.1	-	-
	76.1	23.9	0.5	-	-
3	3.500	0.88	1.1	-	-
80	88.9	22.4	0.5	-	-
4	4.500	1.00	2.6	-	-
100	114.3	25.4	1.2	-	-
	5.500	0.92	4.7	-	-
	139.7	23.4	2.1	-	-
5	5.563	1.00	5.0	-	-
125	141.3	25.4	2.3	-	-
	6.500	1.00	7.5	-	-
	165.1	25.4	3.4	-	-
6	6.625	1.00	7.5	-	-
150	168.3	25.4	3.4	-	-
8	8.625	1.19	12.8	-	-
200	219.1	30.2	5.8	-	-
10	10.750	1.25	20.0	-	-
250	273.0	31.8	9.1	-	-
12	12.750	1.25	36.0	-	-
300	323.9	31.8	16.3	-	-
14	14.000	-	-	8.50	45.0
350	355.6	-	-	215.9	20.4
16	16.000	-	-	9.00	50.3
400	406.4	-	-	228.6	22.8
18	18.000	-	-	10.00	66.0
450	457.2	-	-	254.0	29.9
20	20.000	-	-	11.00	88.00
500	508.0	-	-	279.4	39.9
24	24.000	-	-	12.50	11.90
600	609.6	-	-	317.5	54.0

* Sizes 1 1/4" through 12" are available with 1/2", 3/4" and 1" tap plug. Contact Tyco Fire & Building Products.

Please refer to General Notes on page 14.

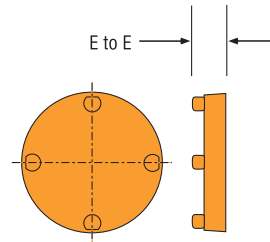

FIGURE 260
CAST
1 1/4" - 12"

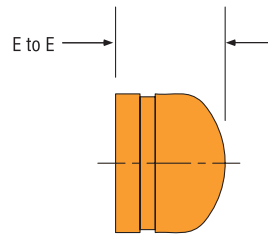

FIGURE 360
FABRICATED
14" - 24"

FITTINGS

Figure 327 Cross

Nominal Size	Pipe OD	327 Fabricated	
		Nominal C to E	Approx Weight
Inches <i>mm</i>	Inches <i>mm</i>	Inches <i>mm</i>	Lbs. <i>Kg</i>
1¼ 32	1.660 42.4	2.75 69.9	2.0 0.9
1½ 40	1.900 48.3	2.75 69.9	2.2 1.0
2 50	2.375 60.3	3.25 82.6	2.7 1.2
2½ 65	2.875 73.0	3.75 95.3	5.0 2.3
3 80	3.500 88.9	4.25 108.0	7.1 3.2
4 100	4.500 114.3	5.00 127.0	11.9 5.4
5 125	5.563 141.3	5.50 139.7	17.1 7.8
6 150	6.625 168.3	6.50 165.1	27.5 12.5
8 200	8.625 219.1	7.75 196.9	47.0 21.3
10 250	10.750 273.0	9.00 278.6	68.0 30.8
12 300	12.750 323.9	10.00 254.0	107.0 48.5
14 350	14.000 355.6	11.00 279.4	135.0 61.8
16 400	16.000 406.4	12.00 304.8	164.0 74.4
18 450	18.000 457.2	15.50 393.7	250.0 113.4
20 500	20.000 508.0	17.25 438.2	310.0 140.6
24 600	24.000 609.6	20.00 508.0	575.0 260.8

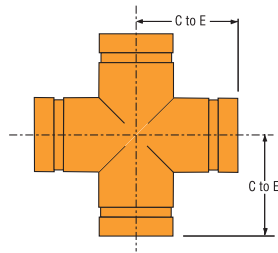

FIGURE 327
FABRICATED

GROOVED
COUPLINGS
& FITTINGS

Please refer to General Notes on page 14.

FITTINGS

Figure 221 & 321 Reducing Tee

Nominal Size Inches mm	Pipe OD Inches mm	221 Cast		321 Fabricated	
		Nominal C to E Inches mm	Approx Weight Lbs. Kg	Nominal C to E Inches mm	Approx Weight Lbs. Kg
1½ x 1½ x 1¼ 40 x 40 x 32	1.900 x 1.900 x 1.660 48.3 x 48.3 x 42.4	–	–	2.75 69.9	1.5 0.7
2 x 2 x 1½ 50 x 50 x 40	2.375 x 2.375 x 1.900 60.3 x 60.6 x 48.3	3.25 82.6	2.7 1.2	3.25 82.6	2.7 1.2
2½ x 2½ x 1¼ 65 x 65 x 32	2.875 x 2.875 x 1.660 73.0 x 73.0 x 42.4	–	–	3.75 95.3	4.2 1.9
2½ x 2½ x 1½ 65 x 65 x 40	2.875 x 2.875 x 1.900 73.0 x 73.0 x 48.3	–	–	3.75 95.3	4.2 1.9
2½ x 2½ x 2 65 x 65 x 50	2.875 x 2.875 x 2.375 73.0 x 73.0 x 60.3	–	–	3.75 95.3	4.3 2.0
3 x 3 x 1 80 x 80 x 25	3.500 x 3.500 x 1.315 88.9 x 88.9 x 33.7	4.25 108.0	7.0 3.2	–	–
3 x 3 x 1½ 80 x 80 x 40	3.500 x 3.500 x 1.900 88.9 x 88.9 x 48.3	–	–	4.25 108.0	5.3 2.4
3 x 3 x 2 80 x 80 x 50	3.500 x 3.500 x 2.375 88.9 x 88.9 x 60.3	4.25 108.0	5.5 2.5	4.25 108.0	5.5 2.5
3 x 3 x 2½ 80 x 80 x 65	3.500 x 3.500 x 2.875 88.9 x 88.9 x 73.0	–	–	4.25 108.0	5.8 2.6
4 x 4 x 1¼ 100 x 100 x 32	4.500 x 4.500 x 1.660 114.3 x 114.3 x 42.4	–	–	5.00 127.0	9.8 4.4
4 x 4 x 1½ 100 x 100 x 40	4.500 x 4.500 x 1.900 114.3 x 114.3 x 48.3	–	–	5.00 127.0	9.9 4.5
4 x 4 x 2 100 x 100 x 50	4.500 x 4.500 x 2.375 114.3 x 114.3 x 60.3	5.00 127.0	10.2 4.6	5.00 127.0	10.1 4.6
4 x 4 x 2½ 100 x 100 x 65	4.500 x 4.500 x 2.875 114.3 x 114.3 x 73.0	–	–	5.00 127.0	10.3 4.7
4 x 4 x 3 100 x 100 x 80	4.500 x 4.500 x 3.500 114.3 x 114.3 x 88.9	5.00 127.0	11.4 5.2	5.00 127.0	10.5 4.8
5 x 5 x 2 125 x 125 x 50	5.563 x 5.563 x 2.375 141.3 x 141.3 x 60.3	–	–	5.50 139.7	14.5 6.6
5 x 5 x 2½ 125 x 125 x 65	5.563 x 5.563 x 2.875 141.3 x 141.3 x 73.0	–	–	5.50 139.7	14.8 6.7
5 x 5 x 3 125 x 125 x 80	5.563 x 5.563 x 3.500 141.3 x 141.3 x 88.9	–	–	5.50 139.7	15.2 6.9
5 x 5 x 4 125 x 125 x 100	5.563 x 5.563 x 4.500 141.3 x 141.3 x 114.3	–	–	5.50 139.7	15.8 7.2
6 x 6 x 2 150 x 150 x 50	6.625 x 6.625 x 2.375 168.3 x 168.3 x 60.3	6.5 165.1	26.4 12.0	6.50 165.1	26.3 11.9
6 x 6 x 2½ 150 x 150 x 65	6.625 x 6.625 x 2.875 168.3 x 168.3 x 73.0	–	–	6.50 165.1	26.5 12.0
6 x 6 x 3 150 x 150 x 80	6.625 x 6.625 x 3.500 168.3 x 168.3 x 88.9	6.5 165.1	26.5 12.0	6.50 165.1	26.5 12.0
6 x 6 x 4 150 x 150 x 100	6.625 x 6.625 x 4.500 168.3 x 168.3 x 114.3	6.5 165.1	26.5 12.0	6.50 165.1	26.6 12.1
6 x 6 x 5 150 x 150 x 125	6.625 x 6.625 x 5.563 168.3 x 168.3 x 141.3	–	–	6.50 165.1	27.0 12.2
8 x 8 x 2 200 x 200 x 50	8.625 x 8.625 x 2.375 219.1 x 219.1 x 60.3	–	–	7.75 196.9	36.2 16.4
8 x 8 x 3 200 x 200 x 80	8.625 x 8.625 x 3.500 219.1 x 219.1 x 88.9	–	–	7.75 196.9	36.5 16.6
8 x 8 x 4 200 x 200 x 100	8.625 x 8.625 x 4.500 219.1 x 219.1 x 114.3	–	–	7.75 196.9	36.6 16.6
8 x 8 x 5 200 x 200 x 125	8.625 x 8.625 x 5.563 219.1 x 219.1 x 141.3	–	–	7.75 196.9	36.8 16.7
8 x 8 x 6 200 x 200 x 150	8.625 x 8.625 x 6.625 219.1 x 219.1 x 168.3	–	–	7.75 196.9	37.0 16.8
10 x 10 x 2 250 x 250 x 50	10.750 x 10.750 x 2.375 273.0 x 273.0 x 60.3	–	–	9.00 228.6	57.1 25.9

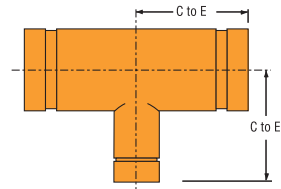

FIGURE 221 CAST
FIGURE 321 FABRICATED

Please refer to General Notes on page 14.

FITTINGS

Figure 321 Reducing Tee

Nominal Size Inches mm	Pipe OD Inches mm	321 Fabricated	
		Nominal C to E Inches mm	Approx Weight Lbs. Kg
10 x 10 x 3 250 x 250 x 80	10.750 x 10.750 x 3.500 273.0 x 273.0 x 88.9	9.00 228.6	57.4 26.0
10 x 10 x 4 250 x 250 x 100	10.750 x 10.750 x 4.500 273.0 x 273.0 x 114.3	9.00 228.6	57.6 26.1
10 x 10 x 5 250 x 250 x 125	10.750 x 10.750 x 5.563 273.0 x 273.0 x 141.3	9.00 228.6	57.8 26.2
10 x 10 x 6 250 x 250 x 150	10.750 x 10.750 x 6.625 273.0 x 273.0 x 168.3	9.00 228.6	58.0 26.3
10 x 10 x 8 250 x 250 x 200	10.750 x 10.750 x 8.625 273.0 x 273.0 x 219.1	9.00 228.6	58.4 26.5
12 x 12 x 3 300 x 300 x 80	12.750 x 12.750 x 3.500 323.9 x 323.9 x 88.9	10.00 254.0	80.2 36.4
12 x 12 x 4 300 x 300 x 100	12.750 x 12.750 x 4.500 323.9 x 323.9 x 114.3	10.00 254.0	80.5 36.5
12 x 12 x 5 300 x 300 x 125	12.750 x 12.750 x 5.563 323.9 x 323.9 x 141.3	10.00 254.0	80.7 36.6
12 x 12 x 6 300 x 300 x 150	12.750 x 12.750 x 6.625 323.9 x 323.9 x 168.3	10.00 254.0	80.9 36.7
12 x 12 x 8 300 x 300 x 200	12.750 x 12.750 x 8.625 323.9 x 323.9 x 219.1	10.00 254.0	91.4 41.5
12 x 12 x 10 300 x 300 x 250	12.750 x 12.750 x 10.750 323.9 x 323.9 x 273.0	10.00 254.0	91.8 41.6
14 x 14 x 6 350 x 350 x 150	14.000 x 14.000 x 6.625 355.6 x 355.6 x 168.3	11.00 279.4	108.0 49.0
14 x 14 x 8 350 x 350 x 200	14.000 x 14.000 x 8.625 355.6 x 355.6 x 219.1	11.00 279.4	110.0 49.9
14 x 14 x 10 350 x 350 x 250	14.000 x 14.000 x 10.750 355.6 x 355.6 x 273.0	11.00 279.4	113.0 51.3
14 x 14 x 12 350 x 350 x 300	14.000 x 14.000 x 12.750 355.6 x 355.6 x 323.9	11.00 279.4	115.0 52.2
16 x 16 x 4 400 x 400 x 100	16.000 x 16.000 x 4.500 406.4 x 406.4 x 114.3	12.00 304.8	132.0 59.9
16 x 16 x 8 400 x 400 x 200	16.000 x 16.000 x 8.625 406.4 x 406.4 x 219.1	12.00 304.8	140.0 63.5
16 x 16 x 10 400 x 400 x 250	16.000 x 16.000 x 10.750 406.4 x 406.4 x 273.0	12.00 304.8	143.0 64.9
16 x 16 x 12 400 x 400 x 300	16.000 x 16.000 x 12.750 406.4 x 406.4 x 323.9	12.00 304.8	147.0 66.7
16 x 16 x 14 400 x 400 x 350	16.000 x 16.000 x 14.000 406.4 x 406.4 x 355.6	12.00 304.8	150.0 68.0
18 x 18 x 8 450 x 450 x 200	18.000 x 18.000 x 8.625 457.2 x 457.2 x 219.1	15.50 393.7	193.0 87.5
18 x 18 x 10 450 x 450 x 250	18.000 x 18.000 x 10.750 457.2 x 457.2 x 273.0	15.50 393.7	197.0 89.4
18 x 18 x 12 450 x 450 x 300	18.000 x 18.000 x 12.750 457.2 x 457.2 x 323.9	15.50 393.7	200.0 90.7

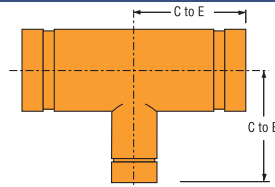

FIGURE 321 FABRICATED

Nominal Size Inches mm	Pipe OD Inches mm	321 Fabricated	
		Nominal C to E Inches mm	Approx Weight Lbs. Kg
18 x 18 x 14 450 x 450 x 350	18.000 x 18.000 x 14.000 457.2 x 457.2 x 355.6	15.50 393.7	204.0 92.5
18 x 18 x 16 450 x 450 x 400	18.000 x 18.000 x 16.000 457.2 x 457.2 x 406.4	15.50 393.7	210.0 95.3
20 x 20 x 14 500 x 500 x 350	20.000 x 20.000 x 14.000 508.0 x 508.0 x 355.6	17.25 450.9	255.0 115.7
20 x 20 x 16 500 x 500 x 400	20.000 x 20.000 x 16.000 508.0 x 508.0 x 406.4	17.25 450.9	260.0 117.9
20 x 20 x 18 500 x 500 x 450	20.000 x 20.000 x 18.000 508.0 x 508.0 x 457.2	17.25 450.9	275.0 124.7
24 x 24 x 10 600 x 600 x 250	24.000 x 24.000 x 10.750 609.6 x 609.6 x 273.0	20.00 508.0	345.0 156.5
24 x 24 x 12 600 x 600 x 300	24.000 x 24.000 x 12.750 609.6 x 609.6 x 323.9	20.00 508.0	347.0 157.4
24 x 24 x 14 600 x 600 x 350	24.000 x 24.000 x 14.000 609.6 x 609.6 x 355.6	20.00 508.0	350.0 158.8
24 x 24 x 16 600 x 600 x 400	24.000 x 24.000 x 16.000 609.6 x 609.6 x 406.4	20.00 508.0	355.0 161.0
24 x 24 x 18 600 x 600 x 450	24.000 x 24.000 x 18.000 609.6 x 609.6 x 457.2	20.00 508.0	360.0 163.3
24 x 24 x 20 600 x 600 x 500	24.000 x 24.000 x 20.000 609.6 x 609.6 x 508.0	20.00 508.0	370.0 167.8

GROOVED
COUPLINGS
& FITTINGS

Please refer to General Notes on page 14.

FITTINGS

Figure 323 Groove x Groove x Male Thread Reducing Tee

Nominal Size Inches mm	Pipe OD Inches mm	323 Fabricated		
		Nominal C to GE Inches mm	Nominal C to TE Inches mm	Approx Weight Lbs. Kg
1 1/2 x 1 1/2 x 1 1/4 40 x 40 x 32	1.900 x 1.900 x 1.660 48.3 x 48.3 x 42.4	3.25 82.6	3.25 82.6	2.7 1.2
2 x 2 x 1 1/2 50 x 50 x 40	2.375 x 2.375 x 1.900 60.3 x 60.6 x 48.3	3.25 82.6	3.25 82.6	2.7 1.2
2 1/2 x 2 1/2 x 1 1/4 65 x 65 x 32	2.875 x 2.875 x 1.660 73.0 x 73.0 x 42.4	3.75 95.3	3.75 95.3	4.3 2.0
2 1/2 x 2 1/2 x 1 1/2 65 x 65 x 40	2.875 x 2.875 x 1.900 73.0 x 73.0 x 48.3	3.75 95.3	3.75 95.3	4.2 1.9
2 1/2 x 2 1/2 x 2 65 x 65 x 50	2.875 x 2.875 x 2.375 73.0 x 73.0 x 60.3	3.75 95.3	3.75 95.3	4.3 2.0
3 x 3 x 1 1/2 80 x 80 x 40	3.500 x 3.500 x 1.900 88.9 x 88.9 x 48.3	4.25 108.0	4.25 108.0	5.3 2.4
3 x 3 x 2 80 x 80 x 50	3.500 x 3.500 x 2.375 88.9 x 88.9 x 60.3	4.25 108.0	4.25 108.0	5.5 2.5
3 x 3 x 2 1/2 80 x 80 x 65	3.500 x 3.500 x 2.875 88.9 x 88.9 x 73.0	4.25 108.0	4.25 108.0	5.8 2.6
4 x 4 x 1 1/2 100 x 100 x 40	4.500 x 4.500 x 1.900 114.3 x 114.3 x 48.3	5.00 127.0	5.00 127.0	9.9 4.5
4 x 4 x 2 100 x 100 x 50	4.500 x 4.500 x 2.375 114.3 x 114.3 x 60.3	5.00 127.0	5.00 127.0	10.1 4.6
4 x 4 x 2 1/2 100 x 100 x 65	4.500 x 4.500 x 2.875 114.3 x 114.3 x 73.0	5.00 127.0	5.00 127.0	10.3 4.7
4 x 4 x 3 100 x 100 x 80	4.500 x 4.500 x 3.500 114.3 x 114.3 x 88.9	5.00 127.0	5.00 127.0	10.5 4.8
5 x 5 x 2 125 x 125 x 50	5.563 x 5.563 x 2.375 141.3 x 141.3 x 60.3	5.50 139.7	5.50 139.7	14.5 6.6
5 x 5 x 3 125 x 125 x 80	5.563 x 5.563 x 3.500 141.3 x 141.3 x 88.9	5.50 139.7	5.50 139.7	15.2 6.9
5 x 5 x 4 125 x 125 x 100	5.563 x 5.563 x 4.500 141.3 x 141.3 x 114.3	5.50 139.7	5.50 139.7	15.8 7.2
6 x 6 x 2 150 x 150 x 50	6.625 x 6.625 x 2.375 168.3 x 168.3 x 60.3	6.50 165.1	6.50 165.1	26.3 11.9
6 x 6 x 2 1/2 150 x 150 x 65	6.625 x 6.625 x 2.875 168.3 x 168.3 x 73.0	6.50 165.1	6.50 165.1	26.5 12.0
6 x 6 x 3 150 x 150 x 80	6.625 x 6.625 x 3.500 168.3 x 168.3 x 88.9	6.50 165.1	6.50 165.1	26.5 12.0
6 x 6 x 4 150 x 150 x 100	6.625 x 6.625 x 4.500 168.3 x 168.3 x 114.3	6.50 165.1	6.50 165.1	26.6 12.1
6 x 6 x 5 150 x 150 x 125	6.625 x 6.625 x 5.563 168.3 x 168.3 x 141.3	6.50 165.1	6.50 165.1	27.0 12.2
8 x 8 x 2 200 x 200 x 50	8.625 x 8.625 x 2.375 219.1 x 219.1 x 60.3	7.75 196.9	7.75 196.9	36.2 16.4
8 x 8 x 3 200 x 200 x 80	8.625 x 8.625 x 3.500 219.1 x 219.1 x 88.9	7.75 196.9	7.75 196.9	36.5 16.6
8 x 8 x 4 200 x 200 x 100	8.625 x 8.625 x 4.500 219.1 x 219.1 x 114.1	7.75 196.9	7.75 196.9	36.6 16.6
8 x 8 x 5 200 x 200 x 125	8.625 x 8.625 x 5.563 219.1 x 219.1 x 141.3	7.75 196.9	7.75 196.9	36.8 16.7
8 x 8 x 6 200 x 200 x 150	8.625 x 8.625 x 6.625 219.1 x 219.1 x 168.3	7.75 196.9	7.75 196.9	37.0 16.8

Please refer to General Notes on page 14.

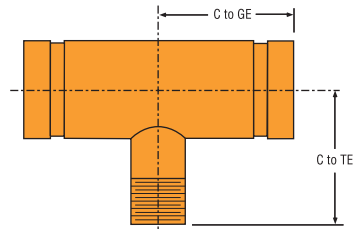

FIGURE 323
FABRICATED

FITTINGS

Figure 323 Groove x Groove x Male Thread Reducing Tee

Nominal Size Inches mm	Pipe OD Inches mm	323 Fabricated		
		Nominal C to GE Inches mm	Nominal C to TE Inches mm	Approx Weight Lbs. Kg
10 x 10 x 2 250 x 250 x 50	10.750 x 10.750 x 2.375 273.0 x 273.0 x 60.3	9.00 228.6	9.00 228.6	57.1 25.9
10 x 10 x 3 250 x 250 x 80	10.750 x 10.750 x 3.500 273.0 x 273.0 x 88.9	9.00 228.6	9.00 228.6	57.4 26.0
10 x 10 x 4 250 x 250 x 100	10.750 x 10.750 x 4.500 273.0 x 273.0 x 114.3	9.00 228.6	9.00 228.6	57.6 26.1
10 x 10 x 5 250 x 250 x 125	10.750 x 10.750 x 5.563 273.0 x 273.0 x 141.3	9.00 228.6	9.00 228.6	57.8 26.2
10 x 10 x 6 250 x 250 x 150	10.750 x 10.750 x 6.625 273.0 x 273.0 x 168.3	9.00 228.6	9.00 228.6	58.0 26.3
10 x 10 x 8 250 x 250 x 200	10.750 x 10.750 x 8.625 273.0 x 273.0 x 219.1	9.00 228.6	9.00 228.6	58.4 26.5
12 x 12 x 3 300 x 300 x 80	12.750 x 12.750 x 3.500 323.9 x 323.9 x 88.9	10.00 254.0	10.00 254.0	80.2 36.4
12 x 12 x 4 300 x 300 x 100	12.750 x 12.750 x 4.500 323.9 x 323.9 x 114.3	10.00 254.0	10.00 254.0	80.5 36.5
12 x 12 x 5 300 x 300 x 125	12.750 x 12.750 x 5.563 323.9 x 323.9 x 141.3	10.00 254.0	10.00 254.0	80.7 36.6
12 x 12 x 6 300 x 300 x 150	12.750 x 12.750 x 6.625 323.9 x 323.9 x 168.3	10.00 254.0	10.00 254.0	80.9 36.7
12 x 12 x 8 300 x 300 x 200	12.750 x 12.750 x 8.625 323.9 x 323.9 x 219.1	10.00 254.0	10.00 254.0	91.4 41.5
12 x 12 x 10 300 x 300 x 250	12.750 x 12.750 x 10.750 323.9 x 323.9 x 273.0	10.00 254.0	10.00 254.0	91.8 41.6
14 x 14 x 6 350 x 350 x 150	14.000 x 14.000 x 6.625 355.6 x 355.6 x 168.3	11.00 279.4	11.00 279.4	109.6 49.7
14 x 14 x 8 350 x 350 x 200	14.000 x 14.000 x 8.625 355.6 x 355.6 x 219.1	11.00 279.4	11.00 279.4	110.0 49.9
14 x 14 x 10 350 x 350 x 250	14.000 x 14.000 x 10.750 355.6 x 355.6 x 273.0	11.00 279.4	11.00 279.4	113.0 51.3
14 x 14 x 12 350 x 350 x 300	14.000 x 14.000 x 12.750 355.6 x 355.6 x 323.9	11.00 279.4	11.00 279.4	115.0 52.2
16 x 16 x 8 400 x 400 x 200	16.000 x 16.000 x 8.625 406.4 x 406.4 x 219.1	12.00 304.8	12.00 304.8	140.0 63.5
16 x 16 x 10 400 x 400 x 250	16.000 x 16.000 x 10.750 406.4 x 406.4 x 273.0	12.00 304.8	12.00 304.8	143.0 64.9
16 x 16 x 12 400 x 400 x 300	16.000 x 16.000 x 12.750 406.4 x 406.4 x 323.9	12.00 304.8	12.00 304.8	147.0 66.7
18 x 18 x 8 450 x 450 x 200	18.000 x 18.000 x 8.625 457.2 x 457.2 x 219.1	15.50 393.7	15.50 393.7	193.0 87.5
18 x 18 x 10 450 x 450 x 250	18.000 x 18.000 x 10.750 457.2 x 457.2 x 273.0	15.50 393.7	15.50 393.7	197.0 89.4
18 x 18 x 12 450 x 450 x 300	18.000 x 18.000 x 12.750 457.2 x 457.2 x 323.9	15.50 393.7	15.50 393.7	200.0 90.7
18 x 18 x 14 450 x 450 x 350	18.000 x 18.000 x 14.000 457.2 x 457.2 x 355.6	15.50 393.7	15.50 393.7	211.0 95.7
18 x 18 x 16 450 x 450 x 400	18.000 x 18.000 x 16.000 457.2 x 457.2 x 406.4	15.50 393.7	15.50 393.7	216.0 98.0
24 x 24 x 8 600 x 600 x 200	24.000 x 24.000 x 8.625 609.6 x 609.6 x 219.1	20.00 508.0	20.00 508.0	334.0 151.5
24 x 24 x 10 600 x 600 x 250	24.000 x 24.000 x 10.750 609.6 x 609.6 x 273.0	20.00 508.0	20.00 508.0	345.0 156.5
24 x 24 x 12 600 x 600 x 300	24.000 x 24.000 x 12.750 609.6 x 609.6 x 323.9	20.00 508.0	20.00 508.0	347.0 157.4

Please refer to General Notes on page 14.

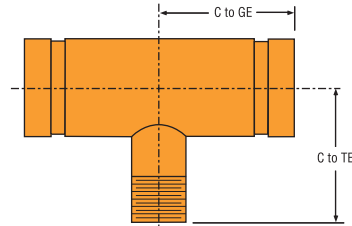

FIGURE 323
FABRICATED

GROOVED
COUPLINGS
& FITTINGS

FITTINGS

Figure 250, 350 & 372 Concentric Reducer

Nominal Size	Pipe OD	250 Cast		350 Fabricated		372 Fabricated Groove x Thread	
		Nominal E to E Inches	Approx Weight Lbs.	Nominal E to E Inches	Approx Weight Lbs.	Nominal E to E Inches	Approx Weight Lbs.
Inches mm	Inches mm	Inches mm	Kg	Inches mm	Kg	Inches mm	Kg
1½ x 1 40 x 25	1.900 x 1.315 48.3 x 33.7	—	—	—	—	2.50 63.5	0.6 0.3
1½ x 1¼ 40 x 32	1.900 x 1.660 48.3 x 42.4	—	—	2.50 63.5	0.6 0.3	—	—
2 x 1 50 x 25	2.375 x 1.315 60.3 x 33.7	—	—	—	—	2.50 63.5	0.8 0.4
2 x 1¼ 50 x 32	2.375 x 1.660 60.3 x 42.4	—	—	2.50 63.5	0.8 0.4	2.50 63.5	0.8 0.4
2 x 1½ 50 x 40	2.375 x 1.900 60.3 x 48.3	—	—	2.50 63.5	0.8 0.4	2.50 63.5	0.8 0.4
2½ x 1¼ 65 x 32	2.875 x 1.660 73.0 x 42.4	2.50 63.5	1.5 0.7	2.50 63.5	1.0 0.5	2.50 63.5	1.0 0.5
2½ x 1½ 65 x 40	2.875 x 1.900 73.0 x 48.3	2.50 63.5	1.5 0.7	2.50 63.5	1.3 0.6	2.50 63.5	1.3 0.6
2½ x 2 65 x 50	2.875 x 2.375 73.0 x 60.3	2.50 63.5	1.2 0.5	2.50 63.5	1.2 0.5	2.50 63.5	1.2 0.5
3 x 1 80 x 25	3.500 x 1.315 88.9 x 33.7	—	—	—	—	2.50 63.5	1.3 0.6
3 x 1¼ 80 x 32	3.500 x 1.660 88.9 x 42.4	—	—	2.50 63.5	1.3 0.6	—	—
3 x 1½ 80 x 40	3.500 x 1.900 88.9 x 48.3	2.50 63.5	2.0 0.9	2.50 63.5	1.3 0.6	2.50 63.5	1.3 0.6
3 x 2 80 x 50	3.500 x 2.375 88.9 x 60.3	2.50 63.5	1.6 0.7	2.50 63.5	1.3 0.6	2.50 63.5	1.3 0.6
3 x 2½ 80 x 65	3.500 x 2.875 88.9 x 73.0	2.50 63.5	1.8 0.8	2.50 63.5	1.5 0.7	2.50 63.5	1.5 0.7
	4.000 x 3.500 101.6 x 88.9	—	—	—	—	2.50 63.5	1.5 0.7
4 x 1¼ 100 x 32	4.500 x 1.660 114.3 x 42.4	—	—	3.00 76.2	2.2 1.0	—	—
4 x 1½ 100 x 40	4.500 x 1.900 114.3 x 48.3	—	—	3.00 76.2	2.3 1.0	3.00 76.2	2.3 1.0
4 x 2 100 x 50	4.500 x 2.375 114.3 x 60.3	3.00 76.2	2.7 1.2	3.00 76.2	2.3 1.0	3.00 76.2	2.3 1.0
4 x 2½ 100 x 65	4.500 x 2.875 114.3 x 73.0	3.00 76.2	2.8 1.3	3.00 76.2	2.3 1.0	3.00 76.2	2.3 1.0
4 x 3 100 x 80	4.500 x 3.500 114.3 x 88.9	3.00 76.2	3.0 1.4	3.00 76.2	2.6 1.2	3.00 76.2	2.6 1.2
5 x 1½ 125 x 40	5.563 x 1.900 141.3 x 48.3	—	—	3.50 88.9	4.6 2.1	—	—
5 x 2 125 x 50	5.563 x 2.375 141.3 x 60.3	—	—	3.50 88.9	4.6 2.1	—	—
5 x 2½ 125 x 65	5.563 x 2.875 141.3 x 73.0	—	—	3.50 88.9	4.5 2.0	—	—
5 x 3 125 x 80	5.563 x 3.500 141.3 x 88.9	3.5 88.9	4.4 2.0	3.50 88.9	4.4 2.0	—	—
5 x 4 125 x 100	5.563 x 4.500 141.3 x 114.3	3.50 88.9	4.6 2.1	3.50 88.9	4.5 2.0	3.50 88.9	4.5 2.0
6 x 2 150 x 50	6.625 x 2.375 168.3 x 60.3	4.00 101.6	5.4 2.5	4.00 101.6	6.0 2.7	4.00 101.6	6.0 2.7
6 x 2½ 150 x 65	6.625 x 2.875 168.3 x 73.0	4.0 101.6	5.4 2.5	4.00 101.6	6.0 2.7	—	—
	6.625 x 2.875 168.3 x 76.1	—	—	—	—	—	—
6 x 3 150 x 80	6.625 x 3.500 168.3 x 88.9	4.00 101.6	5.8 2.6	4.00 101.6	6.0 2.7	4.00 101.6	6.0 2.7
6 x 4 150 x 100	6.625 x 4.500 168.3 x 114.3	4.00 101.6	5.9 2.7	4.00 101.6	5.9 2.7	4.00 101.6	5.9 2.7
6 x 5 150 x 125	6.625 x 5.563 168.3 x 141.3	4.00 101.6	6.3 2.9	4.00 101.6	5.8 2.6	4.00 101.6	5.8 2.6

Please refer to General Notes on page 14.

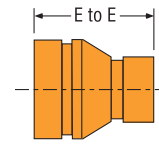

FIGURE 250
CAST

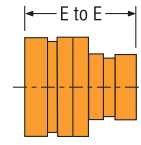

FIGURE 350
FABRICATED
SIZES 1½" - 6"

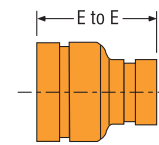

FIGURE 350
FABRICATED
SIZES 8" - 24"

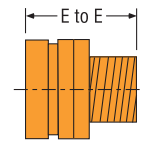

FIGURE 372
FABRICATED
Groove x Male Thread

FITTINGS

Figure 250, 350 & 372 Concentric Reducer

Nominal Size	Pipe OD	250 Cast		350 Fabricated		372 Fabricated Groove x Thread	
		Nominal E to E Inches	Approx Weight Lbs.	Nominal E to E Inches	Approx Weight Lbs.	Nominal E to E Inches	Approx Weight Lbs.
8 x 2 200 x 50	8.625 x 2.375 219.1 x 60.3	-	-	5.00 127.0	12.2 5.5	-	-
8 x 2 1/2 200 x 65	8.625 x 2.875 219.1 x 73.0	-	-	5.00 127.0	12.1 5.5	-	-
8 x 3 200 x 80	8.625 x 3.500 219.1 x 88.9	5.0 127.0	11.7 5.3	5.00 127.0	12.0 5.5	-	-
8 x 4 200 x 100	8.625 x 4.500 219.1 x 114.3	5.0 127.0	11.1 5.0	5.00 127.0	11.9 5.4	-	-
8 x 5 200 x 125	8.625 x 5.563 219.1 x 141.3	5.0 127.0	11.7 5.3	5.00 127.0	11.3 5.1	-	-
8 x 6 200 x 150	8.625 x 6.625 219.1 x 168.3	5.0 127.0	11.8 5.4	5.00 127.0	10.8 4.9	-	-
10 x 4 250 x 100	10.750 x 4.500 273.0 x 114.3	-	-	6.00 152.4	21.9 10.0	-	-
10 x 5 250 x 125	10.750 x 5.563 273.0 x 141.3	-	-	6.00 152.4	21.6 9.8	-	-
10 x 6 250 x 150	10.750 x 6.625 273.0 x 168.3	-	-	6.00 152.4	21.1 9.6	-	-
10 x 8 250 x 200	10.750 x 8.625 273.0 x 219.1	-	-	6.00 152.4	19.5 8.9	-	-
12 x 4 300 x 100	12.750 x 4.500 323.9 x 114.3	-	-	7.00 177.8	28.0 12.7	-	-
12 x 6 300 x 150	12.750 x 6.625 323.9 x 168.3	-	-	7.00 177.8	30.0 13.6	-	-
12 x 8 300 x 200	12.750 x 8.625 323.9 x 219.1	-	-	7.00 177.8	28.0 12.7	-	-
12 x 10 300 x 250	12.750 x 10.750 323.9 x 273.0	-	-	7.00 177.8	33.0 15.0	-	-
14 x 6 350 x 150	14.000 x 6.625 355.6 x 168.3	-	-	13.00 330.2	58.0 26.4	-	-
14 x 8 350 x 200	14.000 x 8.625 355.6 x 219.1	-	-	13.00 330.2	58.5 26.6	-	-
14 x 10 350 x 250	14.000 x 10.750 355.6 x 273.0	-	-	13.00 330.2	59.3 27.0	-	-
14 x 12 350 x 300	14.000 x 12.750 355.6 x 323.9	-	-	13.00 330.2	60.0 27.3	-	-
16 x 8 400 x 200	16.000 x 8.625 406.4 x 219.1	-	-	14.00 355.6	68.5 31.1	-	-
16 x 10 400 x 250	16.000 x 10.750 406.4 x 273.0	-	-	14.00 355.6	69.5 31.6	-	-
16 x 12 400 x 300	16.000 x 12.750 406.4 x 323.9	-	-	14.00 355.6	70.0 31.8	-	-
16 x 14 400 x 350	16.000 x 14.000 406.4 x 355.6	-	-	14.00 355.6	71.0 32.3	-	-
18 x 12 450 x 300	18.000 x 12.750 457.2 x 323.9	-	-	15.00 381.0	83.0 37.7	-	-
18 x 14 450 x 350	18.000 x 14.000 457.2 x 355.6	-	-	15.00 381.0	84.0 38.2	-	-
18 x 16 450 x 400	18.000 x 16.000 457.2 x 406.4	-	-	15.00 381.0	85.0 38.6	-	-
20 x 10 500 x 250	20.000 x 10.750 508.0 x 273.0	-	-	20.00 508.0	115.0 52.3	-	-
20 x 12 500 x 300	20.000 x 12.750 508.0 x 323.9	-	-	20.00 508.0	120.0 54.5	-	-
20 x 14 500 x 350	20.000 x 14.000 508.0 x 355.6	-	-	20.00 508.0	122.0 55.5	-	-
20 x 16 500 x 400	20.000 x 16.000 508.0 x 406.4	-	-	20.00 508.0	124.0 56.4	-	-
20 x 18 500 x 450	20.000 x 18.000 508.0 x 457.2	-	-	20.00 508.0	125.0 56.8	-	-
24 x 10 600 x 250	24.000 x 10.750 609.6 x 273.0	-	-	20.00 508.0	147.0 66.8	-	-

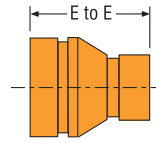

FIGURE 250
CAST

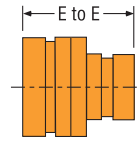

FIGURE 350
FABRICATED
SIZES 1 1/2" - 6"

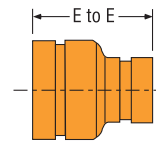

FIGURE 350
FABRICATED
SIZES 8" - 24"

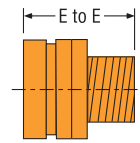

FIGURE 372
FABRICATED
Groove x Male Thread

GROOVED
COUPLINGS
& FITTINGS

Nominal Size	Pipe OD	250 Cast		350 Fabricated		372 Fabricated Groove x Thread	
		Nominal E to E Inches	Approx Weight Lbs.	Nominal E to E Inches	Approx Weight Lbs.	Nominal E to E Inches	Approx Weight Lbs.
24 x 12 600 x 300	24.000 x 12.750 609.6 x 323.9	-	-	20.00 508.0	138.0 62.7	-	-
24 x 14 600 x 350	24.000 x 14.000 609.6 x 355.6	-	-	20.00 508.0	140.0 63.6	-	-
24 x 16 600 x 400	24.000 x 16.000 609.6 x 406.4	-	-	20.00 508.0	145.0 65.9	-	-
24 x 18 600 x 450	24.000 x 18.000 609.6 x 457.2	-	-	20.00 508.0	148.0 67.3	-	-
24 x 20 600 x 500	24.000 x 20.000 609.6 x 508.0	-	-	20.00 508.0	150.0 68.2	-	-

Please refer to General Notes on page 14.

FITTINGS

Figure 251 & 351 Eccentric Reducer

Nominal Size	Pipe OD	251 Cast		351 Fabricated	
		Nominal E to E Inches	Approx Weight Lbs. Kg	Nominal E to E Inches	Approx Weight Lbs. Kg
1 1/2 x 1 1/4 40 x 32	1.900 x 1.660 48.3 x 42.4	-	-	8.50 215.9	4.5 2.0
2 x 1 1/4 50 x 32	2.375 x 1.660 60.3 x 42.4	-	-	9.00 228.6	2.4 1.1
2 x 1 1/2 50 x 40	2.375 x 1.900 60.3 x 48.3	-	-	9.00 228.6	2.5 1.1
2 1/2 x 1 1/4 65 x 32	2.875 x 1.660 73.0 x 42.4	-	-	9.50 241.3	3.4 1.5
2 1/2 x 1 1/2 65 x 40	2.875 x 1.900 73.0 x 48.3	-	-	9.50 241.3	3.6 1.6
2 1/2 x 2 65 x 50	2.875 x 2.375 73.0 x 60.3	-	-	9.50 241.3	4.0 1.8
3 x 1 1/4 80 x 32	3.500 x 1.660 88.9 x 42.4	-	-	9.50 241.3	4.3 2.0
3 x 1 1/2 80 x 40	3.500 x 1.900 88.9 x 48.3	-	-	9.50 241.3	4.5 2.0
3 x 2 80 x 50	3.500 x 2.375 88.9 x 60.3	3.50 88.9	1.8 .8	9.50 241.3	4.8 2.2
3 x 2 1/2 80 x 65	3.500 x 2.875 88.9 x 73.0	3.50 88.9	2.0 .9	9.50 241.3	5.6 2.5
4 x 1 1/4 100 x 32	4.500 x 1.660 114.3 x 42.4	-	-	10.00 254.0	6.3 2.9
4 x 1 1/2 100 x 40	4.500 x 1.900 114.3 x 48.3	-	-	10.00 254.0	6.4 2.9
4 x 2 100 x 50	4.500 x 2.375 114.3 x 60.3	4.0 101.6	2.8 1.3	10.00 254.0	6.7 3.0
4 x 2 1/2 100 x 65	4.500 x 2.875 114.3 x 73.0	4.0 101.6	3.1 1.4	10.00 254.0	7.3 3.3
4 x 3 100 x 80	4.500 x 3.500 114.3 x 88.9	4.0 101.6	3.3 1.5	10.00 254.0	7.9 3.6
5 x 2 125 x 50	5.563 x 2.375 141.3 x 60.3	-	-	11.00 279.4	9.3 4.2
5 x 2 1/2 125 x 65	5.563 x 2.875 141.3 x 73.0	-	-	11.00 279.4	9.9 4.5
5 x 3 125 x 80	5.563 x 3.500 141.3 x 88.9	-	-	11.00 279.4	10.7 4.9
5 x 4 125 x 100	5.563 x 4.500 141.3 x 114.3	5.0 127.0	5.7 2.6	11.00 279.4	11.9 5.4
6 x 2 150 x 50	6.625 x 2.375 168.3 x 60.3	-	-	11.50 292.1	12.2 5.5
6 x 2 1/2 150 x 65	6.625 x 2.875 168.3 x 73.0	-	-	11.50 292.1	12.8 5.8
6 x 3 150 x 80	6.625 x 3.500 168.3 x 88.9	5.5 139.7	6.7 3.0	11.50 292.1	13.6 6.2
6 x 4 150 x 100	6.625 x 4.500 168.3 x 114.3	5.5 139.7	7.2 3.3	11.50 292.1	14.9 6.8
6 x 5 150 x 125	6.625 x 5.563 168.3 x 141.3	5.5 139.7	7.8 3.5	11.50 292.1	16.2 7.3
8 x 3 200 x 80	8.625 x 3.500 219.1 x 88.9	-	-	12.00 304.8	17.9 8.1
8 x 4 200 x 100	8.625 x 4.500 219.1 x 114.3	-	-	12.00 304.8	19.7 8.9
8 x 5 200 x 125	8.625 x 5.563 219.1 x 141.3	-	-	12.00 304.8	21.4 9.7
8 x 6 200 x 150	8.625 x 6.625 219.1 x 168.3	-	-	12.00 304.8	23.2 10.5
10 x 4 250 x 100	10.750 x 4.500 273.0 x 114.3	-	-	13.00 330.2	29.7 13.5
10 x 5 250 x 125	10.750 x 5.563 273.0 x 141.3	-	-	13.00 330.2	31.7 14.4
10 x 6 250 x 150	10.750 x 6.625 273.0 x 168.3	-	-	13.00 330.2	34.0 15.4

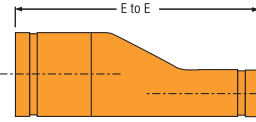

FIGURE 251 CAST
FIGURE 351 FABRICATED
Groove x Groove

Nominal Size	Pipe OD	251 Cast		351 Fabricated	
		Nominal E to E Inches	Approx Weight Lbs. Kg	Nominal E to E Inches	Approx Weight Lbs. Kg
10 x 8 250 x 200	10.750 x 8.625 273.0 x 219.1	-	-	13.00 330.2	34.4 15.6
12 x 4 300 x 100	12.750 x 4.500 323.9 x 114.3	-	-	14.00 355.6	44.8 20.3
12 x 6 300 x 150	12.750 x 6.625 323.9 x 168.3	-	-	14.00 355.6	45.2 20.5
12 x 8 300 x 200	12.750 x 8.625 323.9 x 219.1	-	-	14.00 355.6	47.7 21.6
12 x 10 300 x 250	12.750 x 10.750 323.9 x 273.0	-	-	14.00 355.6	52.0 23.6
14 x 6 350 x 150	14.000 x 6.625 355.6 x 168.3	-	-	13.00 330.2	78.0 35.4
14 x 8 350 x 200	14.000 x 8.625 355.6 x 219.1	-	-	13.00 330.2	80.0 36.3
14 x 10 350 x 250	14.000 x 10.750 355.6 x 273.0	-	-	13.00 330.2	84.0 38.1
14 x 12 350 x 300	14.000 x 12.750 355.6 x 323.9	-	-	13.00 330.2	88.0 39.9
16 x 8 400 x 200	16.000 x 8.625 406.4 x 219.1	-	-	14.00 355.6	91.0 41.3
16 x 10 400 x 250	16.000 x 10.750 406.4 x 273.0	-	-	14.00 355.6	96.0 43.5
16 x 12 400 x 300	16.000 x 12.750 406.4 x 323.9	-	-	14.00 355.6	99.0 44.9
16 x 14 400 x 350	16.000 x 14.000 406.4 x 355.6	-	-	14.00 355.6	104.0 47.2
18 x 10 450 x 250	18.000 x 10.750 457.2 x 273.0	-	-	15.00 381.0	110.0 49.9
18 x 12 450 x 300	18.000 x 12.750 457.2 x 323.9	-	-	15.00 381.0	113.0 51.3
18 x 14 450 x 350	18.000 x 14.000 457.2 x 355.6	-	-	15.00 381.0	117.0 53.1
18 x 16 450 x 400	18.000 x 16.000 457.2 x 406.4	-	-	15.00 381.0	121.0 54.9
20 x 10 500 x 250	20.000 x 10.750 508.0 x 273.0	-	-	20.00 508.0	145.0 65.8
20 x 12 500 x 300	20.000 x 12.750 508.0 x 323.9	-	-	20.00 508.0	149.0 67.6
20 x 14 500 x 350	20.000 x 14.000 508.0 x 355.6	-	-	20.00 508.0	152.0 68.9
20 x 16 500 x 400	20.000 x 16.000 508.0 x 406.4	-	-	20.00 508.0	156.0 70.8
20 x 18 500 x 450	20.000 x 18.000 508.0 x 457.2	-	-	20.00 508.0	160.0 72.6
24 x 10 600 x 250	24.000 x 10.750 609.6 x 273.0	-	-	20.00 508.0	147.0 78.9
24 x 12 600 x 300	24.000 x 12.750 609.6 x 323.9	-	-	20.00 508.0	179.0 81.2
24 x 14 600 x 350	24.000 x 14.000 609.6 x 355.6	-	-	20.00 508.0	184.0 83.5
24 x 16 600 x 400	24.000 x 16.000 609.6 x 406.4	-	-	20.00 508.0	189.0 85.7
24 x 18 600 x 450	24.000 x 18.000 609.6 x 457.2	-	-	20.00 508.0	194.0 88.0
24 x 20 600 x 500	24.000 x 20.000 609.6 x 508.0	-	-	20.00 508.0	199.0 90.3

Please refer to General Notes on page 14.

FITTINGS

Figure 397, 398 & 399 Swaged Nipples

Nominal Size	Pipe OD	397, 398 & 399 Fabricated	
		Nominal E to E Inches	Approx Weight Lbs. Kg
Inches mm	Inches mm	Inches mm	
2 x 1 ¹ / ₄ 50 x 32	2.375 x 1.660 60.3 x 42.4	6.50 165.1	2.0 0.9
2 x 1 ¹ / ₂ 50 x 40	2.375 x 1.900 60.3 x 48.3	6.50 165.1	2.0 0.9
2 ¹ / ₂ x 1 ¹ / ₄ 65 x 32	2.875 x 1.660 73.0 x 42.4	7.00 177.8	3.5 1.6
2 ¹ / ₂ x 1 ¹ / ₂ 65 x 40	2.875 x 1.900 73.0 x 48.3	7.00 177.8	3.5 1.6
2 ¹ / ₂ x 2 65 x 50	2.875 x 2.375 73.0 x 60.3	7.00 177.8	3.5 1.6
3 x 1 ¹ / ₄ 80 x 32	3.500 x 1.660 88.9 x 42.4	8.00 203.2	5.0 2.3
3 x 1 ¹ / ₂ 80 x 40	3.500 x 1.900 88.9 x 48.3	8.00 203.2	5.0 2.3
3 x 2 80 x 50	3.500 x 2.375 88.9 x 60.3	8.00 203.2	5.0 2.3
3 x 2 ¹ / ₂ 80 x 65	3.500 x 2.875 88.9 x 73.0	8.00 203.2	5.0 2.3
4 x 1 ¹ / ₄ 100 x 32	4.500 x 1.660 114.3 x 42.4	9.00 228.6	8.0 3.6
4 x 1 ¹ / ₂ 100 x 40	4.500 x 1.900 114.3 x 48.3	9.00 228.6	8.0 3.6
4 x 2 100 x 50	4.500 x 2.375 114.3 x 60.3	9.00 228.6	8.0 3.6
4 x 2 ¹ / ₂ 100 x 65	4.500 x 2.875 114.3 x 73.0	9.00 228.6	8.0 3.6
4 x 3 100 x 80	4.500 x 3.500 114.3 x 88.9	9.00 228.6	8.0 3.6
5 x 1 ¹ / ₂ 125 x 40	5.563 x 1.900 141.3 x 48.3	11.00 279.4	12.0 5.4
5 x 2 125 x 50	5.563 x 2.375 141.3 x 60.3	11.00 279.4	12.0 5.4
5 x 2 ¹ / ₂ 125 x 65	5.563 x 2.875 141.3 x 73.0	11.00 279.4	12.0 5.4
5 x 3 125 x 80	5.563 x 3.500 141.3 x 88.9	11.00 279.4	12.0 5.4
5 x 4 125 x 100	5.563 x 4.500 141.3 x 114.3	11.00 279.4	12.0 5.4
6 x 2 150 x 50	6.625 x 2.375 168.3 x 60.3	12.00 304.8	19.0 8.6
6 x 2 ¹ / ₂ 150 x 65	6.625 x 2.875 168.3 x 73.0	12.00 304.8	19.0 8.6
6 x 3 150 x 80	6.625 x 3.500 168.3 x 88.9	12.00 304.8	19.0 8.6
6 x 4 150 x 100	6.625 x 4.500 168.3 x 114.3	12.00 304.8	19.0 8.6
6 x 5 150 x 125	6.625 x 5.563 168.3 x 141.3	12.00 304.8	19.0 8.6

Please refer to General Notes on page 14.

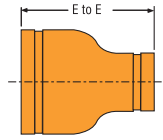

FIGURE 397
FABRICATED
Groove x Groove

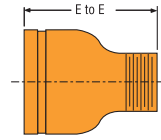

FIGURE 398
FABRICATED
Groove x Male Thread

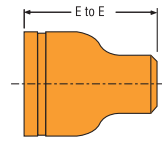

FIGURE 399
FABRICATED
Groove x Plain End

GROOVED
COUPLINGS
& FITTINGS

FITTINGS

Figure 391, 392 & 393 Adapter Nipples

Nominal Size Inches <i>mm</i>	Pipe OD Inches <i>mm</i>	391, 392 & 393 Fabricated	
		Nominal E to E Inches <i>mm</i>	Approx Weight Lbs. <i>Kg</i>
1¼ 32	1.660 42.4	4.00 101.6	0.8 0.4
1½ 40	1.900 48.3	4.00 101.6	0.9 0.4
2 50	2.375 60.3	4.00 101.6	1.2 0.5
2½ 65	2.875 73.0	4.00 101.6	1.9 0.9
3 80	3.500 88.9	4.00 101.6	2.5 1.1
4 100	4.500 114.3	6.00 152.4	5.5 2.5
5 125	5.563 141.3	6.00 152.4	7.4 3.4
6 150	6.625 168.3	6.00 152.4	9.5 4.3
8 200	8.625 219.1	6.00 152.4	14.2 6.4
10 250	10.750 273.0	8.00 203.2	27.0 12.2
12 300	12.750 323.9	8.00 203.2	33.0 15.0

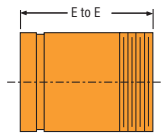

FIGURE 391
FABRICATED
Groove x Male Thread

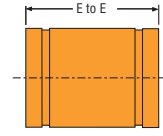

FIGURE 392
FABRICATED
Groove x Groove

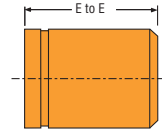

FIGURE 393
FABRICATED
Groove x Plain End

Please refer to General Notes on page 14.

Figure 395 Hose Adapter Nipple

Nominal Size Inches <i>mm</i>	395 Fabricated	
	End to End Inches <i>mm</i>	Approx Weight Lbs. <i>Kg</i>
1 25	3.25 82.6	0.4 0.2
1¼ 32	3.63 92.1	0.7 0.3
1½ 40	4.00 101.6	0.8 0.4
2 50	4.63 117.5	1.3 0.6
2½ 65	5.50 139.7	2.1 1.0
3 80	6.00 152.4	3.3 1.5
3½ 90	— —	— —
4 100	7.25 184.2	5.5 2.5
5 125	9.75 247.7	8.1 3.7
6 150	11.00 279.4	13.2 6.0
8 200	12.50 317.5	24.0 10.9
10 250	14.00 355.6	29.0 13.2
12 300	16.00 406.4	46.0 20.9

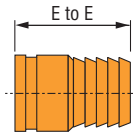

FIGURE 395
FABRICATED
Groove x Hose

Figure 380 Female Thread Adapter

Nominal Size Inches <i>mm</i>	380 Fabricated		
	Grooved End OD Inches <i>mm</i>	End to End Inches <i>mm</i>	Approx Weight Lbs. <i>Kg</i>
1 25	1.32 33.4	2½/₁₆ 533	0.7 0.3
1¼ 32	1.66 42.2	2⁹/₁₆ 635	1.4 0.6
1½ 40	1.90 48.3	2⁹/₁₆ 635	1.5 0.7
2 50	2.38 60.3	2½/₂ 64	1.6 0.7
3 80	3.50 88.9	2¾/₄ 70	2.5 1.1
4 100	4.50 114.3	3¼/₄ 83	4.5 2.0

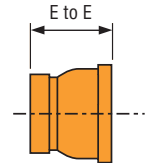

FIGURE 380
FABRICATED
Groove x Female Thread

FITTINGS

Figure 314 45° Lateral

Nominal Size	Pipe OD	314 Fabricated		
		Nominal C to LE	Nominal C to SE	Approx Weight
Inches <i>mm</i>	Inches <i>mm</i>	Inches <i>mm</i>	Inches <i>mm</i>	Lbs. <i>Kg</i>
2 50	2.375 60.3	7.00 177.8	2.75 69.9	4.5 2.0
2½ 65	2.875 73.0	7.75 196.9	3.00 76.2	10.1 4.6
3 80	3.500 88.9	8.50 215.9	3.25 82.6	11.0 5.0
4 100	4.500 114.3	10.50 266.7	3.75 95.3	18.2 8.3
5 125	5.563 141.3	12.50 317.5	4.00 101.6	28.9 13.1
6 150	6.625 168.3	14.00 355.6	4.50 114.3	46.0 20.9
8 200	8.625 219.1	18.00 457.2	6.00 152.4	83.0 37.6
10 250	10.750 273.0	20.50 520.7	6.50 165.1	127.0 57.6
12 300	12.750 323.9	23.00 584.2	7.00 177.8	166.0 75.3
14 350	14.000 355.6	26.50 673.1	7.50 190.5	210.0 95.3
16 400	16.000 406.4	29.00 736.6	8.00 203.2	340.0 154.2
18 450	18.000 457.2	32.00 812.8	8.50 215.9	415.0 188.2
20 500	20.000 508.0	35.00 889.0	9.00 238.6	500.0 226.8
24 600	24.000 609.6	40.00 1016.0	10.00 254.0	925.0 419.6

Please refer to General Notes on page 14.

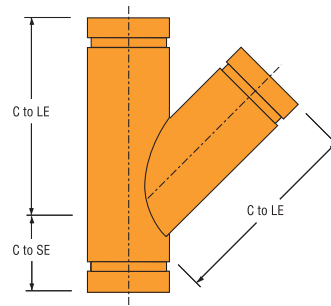

FIGURE 314
FABRICATED

GROOVED
COUPLINGS
& FITTINGS

FITTINGS

Figure 325 45° Reducing Lateral

Nominal Size Inches mm	Pipe OD Inches mm	325 Fabricated		
		Nominal C to LE Inches mm	Nominal C to SE Inches mm	Approx Weight Lbs. Kg
3 x 3 x 2 80 x 80 x 50	3.500 x 3.500 x 2.375 88.9 x 88.9 x 60.3	8.50 215.9	3.25 82.6	9.9 4.5
3 x 3 x 2½ 80 x 80 x 65	3.500 x 3.500 x 2.875 88.9 x 88.9 x 73.0	8.50 215.9	3.25 82.6	11.5 5.2
4 x 4 x 2 100 x 100 x 50	4.500 x 4.500 x 2.375 114.3 x 114.3 x 60.3	10.50 266.7	3.75 95.3	16.0 7.3
4 x 4 x 2½ 100 x 100 x 65	4.500 x 4.500 x 2.875 114.3 x 114.3 x 73.0	10.50 266.7	3.75 95.3	17.0 7.7
4 x 4 x 3 100 x 100 x 80	4.500 x 4.500 x 3.500 114.3 x 114.3 x 88.9	10.50 266.7	3.75 95.3	18.6 8.4
5 x 5 x 2 125 x 125 x 50	5.563 x 5.563 x 2.375 141.3 x 141.3 x 60.3	12.50 317.5	4.00 101.6	23.0 10.4
5 x 5 x 2½ 125 x 125 x 65	5.563 x 5.563 x 2.875 141.3 x 141.3 x 73.0	12.50 317.5	4.00 101.6	23.5 10.7
5 x 5 x 3 125 x 125 x 80	5.563 x 5.563 x 3.500 141.3 x 141.3 x 88.9	12.50 317.5	4.00 101.6	27.0 12.2
5 x 5 x 4 125 x 125 x 100	5.563 x 5.563 x 4.500 141.3 x 141.3 x 114.3	12.50 317.5	4.00 101.6	31.0 14.1
6 x 6 x 2 150 x 150 x 50	6.625 x 6.625 x 2.375 168.3 x 168.3 x 60.3	14.00 355.6	4.50 114.3	33.0 15.0
6 x 6 x 2½ 150 x 150 x 65	6.625 x 6.625 x 2.875 168.3 x 168.3 x 73.0	14.00 355.6	4.50 114.3	34.0 15.4
6 x 6 x 3 150 x 150 x 80	6.625 x 6.625 x 3.500 168.3 x 168.3 x 88.9	14.00 355.6	4.50 114.3	37.1 16.8
6 x 6 x 4 150 x 150 x 100	6.625 x 6.625 x 4.500 168.3 x 168.3 x 114.3	14.00 355.6	4.50 114.3	40.1 18.2
6 x 6 x 5 150 x 150 x 125	6.625 x 6.625 x 5.563 168.3 x 168.3 x 141.3	14.00 355.6	4.50 114.3	45.1 20.5
8 x 8 x 4 200 x 200 x 100	8.625 x 8.625 x 4.500 219.1 x 219.1 x 114.1	18.00 457.2	6.00 152.4	60.0 27.2
8 x 8 x 5 200 x 200 x 125	8.625 x 8.625 x 5.563 219.1 x 219.1 x 141.3	18.00 457.2	6.00 152.4	68.1 30.9
8 x 8 x 6 200 x 200 x 150	8.625 x 8.625 x 6.625 219.1 x 219.1 x 168.3	18.00 457.2	6.00 152.4	76.0 34.5
10 x 10 x 4 250 x 250 x 100	10.750 x 10.750 x 4.500 273.0 x 273.0 x 114.3	20.50 520.7	6.50 165.1	83.1 37.7
10 x 10 x 5 250 x 250 x 125	10.750 x 10.750 x 5.563 273.0 x 273.0 x 141.3	20.50 520.7	6.50 165.1	100.2 45.5
10 x 10 x 6 250 x 250 x 150	10.750 x 10.750 x 6.625 273.0 x 273.0 x 168.3	20.50 520.7	6.50 165.1	106.0 48.1
10 x 10 x 8 250 x 250 x 200	10.750 x 10.750 x 8.625 273.0 x 273.0 x 219.1	20.50 520.7	6.50 165.1	117.0 53.1
12 x 12 x 4 300 x 300 x 100	12.750 x 12.750 x 4.500 323.9 x 323.9 x 114.3	23.00 584.2	7.00 177.8	138.0 62.6
12 x 12 x 6 300 x 300 x 150	12.750 x 12.750 x 6.625 323.9 x 323.9 x 168.3	23.00 584.2	7.00 177.8	139.9 63.5
12 x 12 x 8 300 x 300 x 200	12.750 x 12.750 x 8.625 323.9 x 323.9 x 219.1	23.00 584.2	7.00 177.8	148.0 67.1
12 x 12 x 10 300 x 300 x 250	12.750 x 12.750 x 10.750 323.9 x 323.9 x 273.0	23.00 584.2	7.00 177.8	166.0 75.3
14 x 14 x 4 350 x 350 x 100	14.000 x 14.000 x 4.500 355.6 x 355.6 x 114.3	26.50 673.1	7.50 190.5	167.9 76.2
14 x 14 x 6 350 x 350 x 150	14.000 x 14.000 x 6.625 355.6 x 355.6 x 168.3	26.50 673.1	7.50 190.5	177.2 80.4
14 x 14 x 8 350 x 350 x 200	14.000 x 14.000 x 8.625 355.6 x 355.6 x 219.1	26.50 673.1	7.50 190.5	182.5 82.8

Please refer to General Notes on page 14.

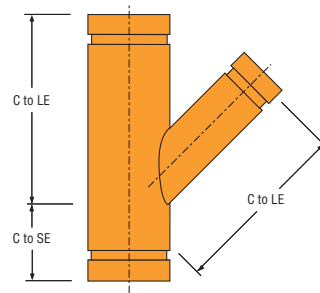

FIGURE 325
FABRICATED

Nominal Size Inches mm	Pipe OD Inches mm	325 Fabricated		
		Nominal C to LE Inches mm	Nominal C to SE Inches mm	Approx Weight Lbs. Kg
14 x 14 x 10 350 x 350 x 250	14.000 x 14.000 x 10.750 355.6 x 355.6 x 273.0	26.50 673.1	7.50 190.5	193.0 87.5
14 x 14 x 12 350 x 350 x 300	14.000 x 14.000 x 12.750 355.6 x 355.6 x 323.9	26.50 673.1	7.50 190.5	203.0 92.1
16 x 16 x 6 400 x 400 x 150	16.000 x 16.000 x 6.625 406.4 x 406.4 x 168.3	29.00 736.6	8.00 203.0	217.2 98.5
16 x 16 x 8 400 x 400 x 200	16.000 x 16.000 x 8.625 406.4 x 406.4 x 219.1	29.00 736.6	8.00 203.0	223.0 101.2
16 x 16 x 10 400 x 400 x 250	16.000 x 16.000 x 10.750 406.4 x 406.4 x 273.0	29.00 736.6	8.00 203.0	234.1 106.2
16 x 16 x 12 400 x 400 x 300	16.000 x 16.000 x 12.750 406.4 x 406.4 x 323.9	29.00 736.6	8.00 203.0	245.4 111.3
16 x 16 x 14 400 x 400 x 350	16.000 x 16.000 x 14.000 406.4 x 406.4 x 355.6	29.00 736.6	8.00 203.0	261.0 118.4
18 x 18 x 6 450 x 450 x 150	18.000 x 18.000 x 6.625 457.2 x 457.2 x 168.3	32.00 812.8	8.50 215.9	265.1 120.2
18 x 18 x 8 450 x 450 x 200	18.000 x 18.000 x 8.625 457.2 x 457.2 x 219.1	32.00 812.8	8.50 215.9	271.5 123.2
18 x 18 x 10 450 x 450 x 250	18.000 x 18.000 x 10.750 457.2 x 457.2 x 273.0	32.00 812.8	8.50 215.9	283.5 128.6
18 x 18 x 12 450 x 450 x 300	18.000 x 18.000 x 12.750 457.2 x 457.2 x 323.9	32.00 812.8	8.50 215.9	296.0 134.3
18 x 18 x 14 450 x 450 x 350	18.000 x 18.000 x 14.000 457.2 x 457.2 x 355.6	32.00 812.8	8.50 215.9	312.6 141.8
18 x 18 x 16 450 x 450 x 400	18.000 x 18.000 x 16.000 457.2 x 457.2 x 406.4	32.00 812.8	8.50 215.9	322.6 146.3
20 x 20 x 12 500 x 500 x 300	20.000 x 20.000 x 12.750 508.0 x 508.0 x 323.9	35.00 889.0	9.00 228.6	351.4 159.4
20 x 20 x 14 500 x 500 x 350	20.000 x 20.000 x 14.000 508.0 x 508.0 x 355.6	35.00 889.0	9.00 228.6	369.1 167.4
20 x 20 x 16 500 x 500 x 400	20.000 x 20.000 x 16.000 508.0 x 508.0 x 406.4	35.00 889.0	9.00 228.6	379.7 172.2
24 x 24 x 16 600 x 600 x 400	24.000 x 24.000 x 16.000 609.6 x 609.6 x 406.4	40.00 1016.0	10.00 254.0	495.6 224.8
24 x 24 x 20 600 x 600 x 500	24.000 x 24.000 x 20.000 609.6 x 609.6 x 508.0	40.00 1016.0	10.00 254.0	518.4 235.1

FITTINGS

Figure 324 90° True Y

Nominal Size	Pipe OD	324 Fabricated		
		Nominal C to LE	Nominal C to SE	Approx Weight
Inches	Inches	Inches	Inches	Lbs.
mm	mm	mm	mm	Kg
1 1/4	1.660	2.75	2.50	1.5
32	42.4	69.9	63.5	0.7
1 1/2	1.900	2.75	2.75	1.8
40	48.3	69.9	69.9	0.8
2	2.375	3.25	2.75	2.3
50	60.3	82.6	69.9	1.0
2 1/2	2.875	3.75	3.00	4.8
65	73.0	95.3	76.2	2.2
3	3.500	4.25	3.25	6.0
80	88.9	108.0	82.6	2.7
4	4.500	5.00	3.75	10.5
100	114.3	127.0	95.3	4.8
5	5.563	5.50	4.00	15.0
125	141.3	139.7	101.6	6.8
6	6.625	6.50	4.50	21.0
150	168.3	165.1	114.3	9.5
8	8.625	7.75	6.00	35.0
200	219.1	196.9	152.4	15.9
10	10.750	9.00	6.50	50.0
250	273.0	228.6	165.1	22.7
12	12.750	10.00	7.00	87.7
300	323.9	254.0	177.8	39.8
14	14.000	11.00	7.50	105.3
350	355.6	279.4	190.5	47.8

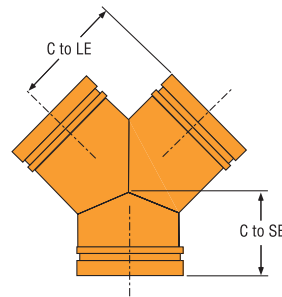

FIGURE 324 FABRICATED

Nominal Size	Pipe OD	324 Fabricated		
		Nominal C to LE	Nominal C to SE	Approx Weight
Inches	Inches	Inches	Inches	Lbs.
mm	mm	mm	mm	Kg
16	16.000	12.00	8.00	129.1
400	406.4	304.8	203.2	58.6
18	18.000	15.50	8.50	184.4
450	457.2	393.7	215.9	83.6
20	20.000	17.25	9.00	225.8
500	508.0	438.2	228.6	102.4
24	24.000	20.00	10.00	308.5
600	609.6	508.0	254.0	139.9

Please refer to General Notes on page 14.

GROOVED COUPLINGS & FITTINGS

Figure 331 Reducing Tee Wye

Nominal Size	Pipe OD	331 Fabricated				Approx Weight
		Nominal G	Nominal H	Nominal E1	Nominal E2	
Inches	Inches	Inches	Inches	Inches	Inches	Lbs.
mm	mm	mm	mm	mm	mm	Kg
4 x 3 x 3	4.500 x 3.500 x 3.500	1.63	7.38	10.75	5.63	15.9
100 x 80 x 80	114.3 x 88.9 x 88.9	41.4	187.5	273.1	143.0	7.2
4 x 3 x 4	4.500 x 3.500 x 4.500	3.75	10.50	13.63	8.13	26.8
100 x 80 x 100	114.3 x 88.9 x 114.3	95.3	266.7	346.2	206.5	12.2
5 x 3 x 3	5.563 x 3.500 x 3.500	1.25	9.75	11.50	6.50	24.8
125 x 80 x 80	141.3 x 88.9 x 88.9	31.8	247.7	292.1	165.1	11.2
5 x 3 x 5	5.563 x 3.500 x 5.563	4.00	12.50	16.13	10.00	44.1
125 x 80 x 100	141.3 x 88.9 x 141.3	101.6	317.5	409.7	254.0	20.0
5 x 4 x 3	5.563 x 4.500 x 3.500	1.88	9.13	11.88	6.88	21.1
125 x 100 x 80	141.3 x 114.3 x 88.9	47.8	231.9	301.88	174.8	9.6
5 x 4 x 4	5.563 x 4.500 x 4.500	1.88	9.13	12.75	7.25	25.6
125 x 100 x 100	141.3 x 114.3 x 114.3	47.8	231.9	323.9	184.2	11.6
6 x 4 x 6	6.625 x 4.500 x 6.625	4.50	14.00	18.25	11.50	62.0
150 x 100 x 150	168.3 x 114.3 x 168.3	114.3	355.6	463.6	292.1	28.1
6 x 5 x 3	6.625 x 5.563 x 3.500	1.25	10.75	13.00	8.00	26.7
150 x 125 x 80	168.3 x 141.3 x 88.9	31.8	273.1	330.2	203.2	12.1
6 x 5 x 4	6.625 x 5.563 x 4.500	1.25	10.75	13.88	8.38	32.0
150 x 125 x 100	168.3 x 141.3 x 114.3	31.8	273.1	352.6	212.9	14.5
8 x 6 x 4	8.625 x 6.625 x 4.500	1.00	12.00	14.75	9.25	46.0
200 x 150 x 100	219.1 x 168.3 x 114.1	25.4	304.8	374.7	235.0	20.9
8 x 6 x 8	8.625 x 6.625 x 8.625	6.00	18.00	23.25	15.25	93.0
200 x 150 x 200	219.1 x 168.3 x 219.1	152.4	457.2	590.6	387.4	42.2

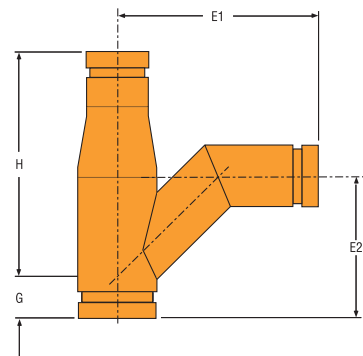

FIGURE 331 FABRICATED

Please refer to General Notes on page 14.

FITTINGS

Figure 330 Tee Wye

Nominal Size Inches mm	Pipe OD Inches mm	330 Fabricated				Approx Weight Lbs. Kg
		Nominal G Inches mm	Nominal H Inches mm	Nominal E1 Inches mm	Nominal E2 Inches mm	
2 x 2 x 2 50 x 50 x 50	2.375 x 2.375 x 2.375 60.3 x 60.6 x 60.6	2.75 69.9	7.00 177.8	9.00 228.6	4.63 117.6	6.5 2.9
2 1/2 x 2 1/2 x 2 1/2 65 x 65 x 65	2.875 x 2.875 x 2.875 73.0 x 73.0 x 73.0	3.00 76.2	7.75 196.9	10.50 266.7	5.75 146.1	11.6 5.3
3 x 3 x 3 80 x 80 x 80	3.500 x 3.500 x 3.500 88.9 x 88.9 x 88.9	3.25 82.6	8.50 215.9	11.50 292.1	6.50 165.1	16.6 7.5
4 x 4 x 3 100 x 100 x 80	4.500 x 4.500 x 3.500 114.3 x 114.3 x 88.9	3.75 95.3	10.50 266.7	12.88 327.2	7.88 200.2	24.0 10.9
4 x 4 x 4 100 x 100 x 100	4.500 x 4.500 x 4.500 114.3 x 114.3 x 114.3	3.75 95.3	10.50 266.7	13.63 346.2	8.13 206.5	26.1 11.8
5 x 5 x 3 125 x 125 x 80	5.563 x 5.563 x 3.500 141.3 x 141.3 x 88.9	4.00 101.6	12.50 317.5	14.25 362.0	9.25 235.0	32.1 14.6
5 x 5 x 4 125 x 125 x 100	5.563 x 5.563 x 4.500 141.3 x 141.3 x 114.3	4.00 101.6	12.50 317.5	15.13 384.3	9.63 244.6	35.5 16.1
5 x 5 x 5 125 x 125 x 125	5.563 x 5.563 x 5.563 141.3 x 141.3 x 141.3	4.00 101.6	12.50 317.5	16.13 409.7	10.00 254.0	41.0 18.6
6 x 6 x 3 150 x 150 x 80	6.625 x 6.625 x 3.500 168.3 x 168.3 x 88.9	4.50 114.3	14.00 355.6	15.31 388.9	10.31 261.9	51.1 23.2
6 x 6 x 4 150 x 150 x 100	6.625 x 6.625 x 4.500 168.3 x 168.3 x 114.3	4.50 114.3	14.00 355.6	16.25 412.8	10.75 273.1	55.1 25.0
6 x 6 x 5 150 x 150 x 125	6.625 x 6.625 x 5.563 168.3 x 168.3 x 141.3	4.50 114.3	14.00 355.6	17.25 438.2	11.13 282.7	58.2 26.4
6 x 6 x 6 150 x 150 x 150	6.625 x 6.625 x 6.625 168.3 x 168.3 x 168.3	4.50 114.3	14.00 355.6	18.25 463.6	11.50 292.1	61.0 27.7
8 x 8 x 3 200 x 200 x 80	8.625 x 8.625 x 3.500 219.1 x 219.1 x 88.9	6.00 152.4	18.00 457.2	18.19 462.0	13.19 355.0	101.0 45.8
8 x 8 x 4 200 x 200 x 100	8.625 x 8.625 x 4.500 219.1 x 219.1 x 114.1	6.00 152.4	18.00 457.2	19.00 482.6	13.50 342.9	111.5 50.6
8 x 8 x 5 200 x 200 x 125	8.625 x 8.625 x 5.563 219.1 x 219.1 x 141.3	6.00 152.4	18.00 457.2	20.00 508.0	13.88 352.6	112.0 50.8
8 x 8 x 6 200 x 200 x 150	8.625 x 8.625 x 6.625 219.1 x 219.1 x 168.3	6.00 152.4	18.00 457.2	21.13 536.7	14.38 365.3	113.0 51.3
8 x 8 x 8 200 x 200 x 200	8.625 x 8.625 x 8.625 219.1 x 219.1 x 219.1	6.00 152.4	18.00 457.2	23.25 590.6	15.25 387.4	119.0 54.0
10 x 10 x 3 250 x 250 x 80	10.750 x 10.750 x 3.500 273.0 x 273.0 x 88.9	6.50 165.1	20.50 520.7	19.88 505.0	14.88 378.0	131.0 59.4
10 x 10 x 4 250 x 250 x 100	10.750 x 10.750 x 4.500 273.0 x 273.0 x 114.3	6.50 165.1	20.50 520.7	20.75 527.1	15.25 387.4	136.0 61.7
10 x 10 x 5 250 x 250 x 125	10.750 x 10.750 x 5.563 273.0 x 273.0 x 141.3	6.50 165.1	20.50 520.7	21.88 555.8	15.75 400.1	139.0 63.1
10 x 10 x 6 250 x 250 x 150	10.750 x 10.750 x 6.625 273.0 x 273.0 x 168.3	6.50 165.1	20.50 520.7	22.88 581.2	16.13 409.7	146.0 66.2
10 x 10 x 8 250 x 250 x 200	10.750 x 10.750 x 8.625 273.0 x 273.0 x 219.1	6.50 165.1	20.50 520.7	27.25 692.2	19.25 489.0	155.0 70.3
10 x 10 x 10 250 x 250 x 250	10.750 x 10.750 x 10.750 273.0 x 273.0 x 273.0	6.50 165.1	20.50 520.7	27.25 692.2	18.00 457.2	195.0 88.5
12 x 12 x 3 300 x 300 x 80	12.750 x 12.750 x 3.500 323.9 x 323.9 x 88.9	7.00 177.8	23.00 584.2	20.75 527.1	15.75 400.1	140.0 63.5
12 x 12 x 4 300 x 300 x 100	12.750 x 12.750 x 4.500 323.9 x 323.9 x 114.3	7.00 177.8	23.00 584.2	21.50 546.1	16.00 406.4	145.0 65.8
12 x 12 x 6 300 x 300 x 150	12.750 x 12.750 x 6.625 323.9 x 323.9 x 168.3	7.00 177.8	23.00 584.2	23.75 603.3	17.00 431.8	165.0 74.8
12 x 12 x 8 300 x 300 x 200	12.750 x 12.750 x 8.625 323.9 x 323.9 x 219.1	7.00 177.8	23.00 584.2	26.00 660.4	18.00 457.2	175.0 79.4
12 x 12 x 10 300 x 300 x 250	12.750 x 12.750 x 10.750 323.9 x 323.9 x 273.0	7.00 177.8	23.00 584.2	28.00 711.2	18.75 476.3	200.0 90.7
12 x 12 x 12 300 x 300 x 300	12.750 x 12.750 x 12.750 323.9 x 323.9 x 323.9	7.00 177.8	23.00 584.2	31.00 787.4	20.50 520.7	240.0 108.9

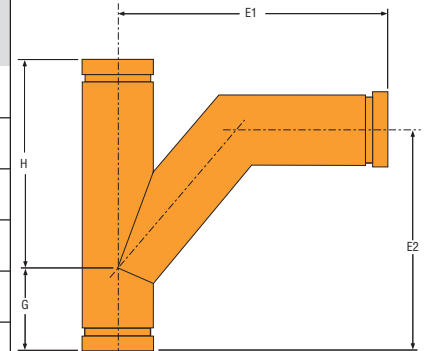

FIGURE 330
FABRICATED

Please refer to General Notes on page 14.

FITTINGS

Figure 341 Flange Adapter (ANSI Class 150 Lbs.)

Figure 342 Flange Adapter (ANSI Class 300 Lbs.)

Nominal Size	Pipe OD	Nominal E to E	341 Fabricated		342 Fabricated	
			Mating Flange Bolt Qty	Approx Weight Lbs. Kg	Mating Flange Bolt Qty	Approx Weight Lbs. Kg
1¼ 32	1.660 42.4	4.00 101.6	4	2.8 1.3	4	4.6 2.1
1½ 40	1.900 48.3	4.00 101.6	4	3.2 1.5	4	7.1 3.2
2 50	2.375 60.3	4.00 101.6	4	5.2 2.4	8	8.2 3.7
2½ 65	2.875 73.0	4.00 101.6	4	8.0 3.6	8	11.9 5.4
3 80	3.500 88.9	4.00 101.6	4	10.2 4.6	8	15.5 7.0
4 100	4.500 114.3	6.00 152.4	8	17.2 7.8	8	28.0 12.7
5 125	5.563 141.3	6.00 152.4	8	21.4 9.7	8	35.0 15.9
6 150	6.625 168.3	6.00 152.4	8	26.0 11.8	12	50.0 22.7
8 200	8.625 219.1	6.00 152.4	8	38.4 17.4	12	73.0 32.7
10 250	10.750 273.0	8.00 203.2	12	65.0 29.5	16	103.0 46.7
12 300	12.750 323.9	8.00 203.2	12	91.0 41.3	16	143.0 64.9
14 350	14.000 355.6	8.00 203.2	12	123.0 55.8	20	199.0 90.3
16 400	16.000 406.4	8.00 203.2	12	151.0 68.5	20	255.0 115.7
18 450	18.000 457.2	8.00 203.2	16	165.0 74.8	24	303.0 137.4
20 500	20.000 508.0	8.00 203.2	20	205.0 93.0	24	365.0 165.6
24 600	24.000 609.6	8.00 203.2	20	265.0 120.2	24	550.0 249.5

Please refer to General Notes on page 14.

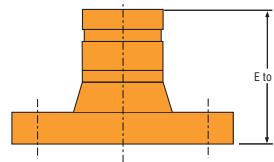

FIGURE 341 & 342
FABRICATED

GROOVED
COUPLINGS
& FITTINGS

FITTINGS

Figure 407GT & 407T Clearflow® Dielectric Waterway

Clearflow® fittings protect plumbing systems through an innovative steel-to-plastic design that establishes a dielectric waterway. The Clearflow line of dielectric fittings separates dissimilar metals in the electrolyte (waterway) eliminating the local galvanic cell.

Clearflow's metal-to-metal joint design maintains external electrical continuity, thereby preventing stray current corrosion. This feature is critical when stray current is present due to intentional or non-intentional grounding of direct current (DC) sources, such as phone systems and appliances.

Clearflow fittings meet the requirements of ASTM standard F-492 for continuous use at temperatures up to 230°F (110°C).

Test Data/Results and Listings:

Test data provided by Pittsburgh Testing Laboratory can be provided upon request.

®Registered Trademark of Perfection Corp.



FIGURE 407GT

FIGURE 407T

Nominal Size	Pipe OD	407GT	
		Grooved x Threaded	
Inches	Inches	Nominal End to End	Approx Weight
mm	mm	Inches	Lbs.
		mm	Kg
1¼	1.660	4.0	0.6
32	42.4	101.6	0.3
1½	1.900	4.0	0.8
40	48.3	101.6	0.4
2	2.375	4.0	1.0
50	60.3	101.6	0.5
2½	2.875	6.0	1.6
65	73.0	152.4	0.7
3	3.500	6.0	2.0
80	88.9	152.4	0.9
4	4.500	6.0	4.5
100	114.3	152.4	2.0

Please refer to General Notes on page 14.

Nominal Size	Pipe OD	407T	
		Threaded x Threaded	
Inches	Inches	Nominal End to End	Approx Weight
mm	mm	Inches	Lbs.
		mm	Kg
½	0.840	3.0	0.2
15	21.3	76.2	0.1
¾	1.050	3.0	0.2
20	26.7	76.2	0.1
1	1.315	4.0	0.3
25	33.7	101.6	0.1
1¼	1.660	4.0	0.3
32	42.4	101.6	0.1
1½	1.900	4.0	0.8
40	48.3	101.6	0.4
2	2.375	4.0	0.8
50	60.3	101.6	0.4
2½	2.875	6.0	1.6
65	73.0	152.4	0.7
3	3.500	6.0	2.0
80	88.9	152.4	0.9
4	4.500	6.0	4.5
100	114.3	152.4	2.0

Branch Outlets

BRANCH OUTLETS

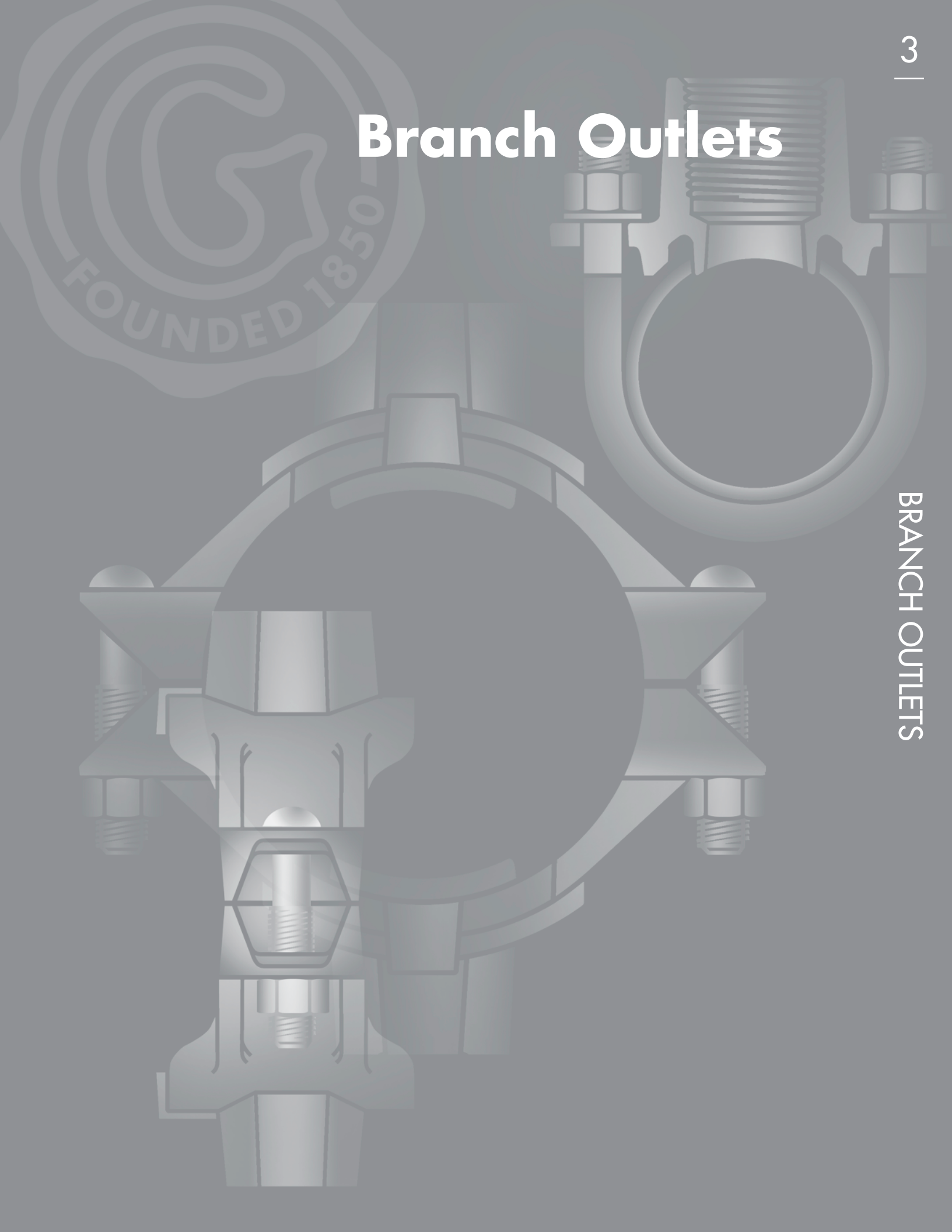

BRANCH OUTLETS

The Figure 730 Mechanical Tees are rated at 500 psi (34.5 Bar) on standard weight pipe and can be used in place of a tee, a cross connection, or a welded outlet where a threaded or grooved outlet is needed. The Mechanical Tee is ideal for use in retrofit or equipment hookup installations, as it can

Tech Data: G210

be positioned along the pipe at the proper location in the field, ensuring exact lineup of the branch outlet connection. All Figure 730 Mechanical Tees are provided with a ductile iron lower housing section for increased strength and dependability. This provides stability, rigidity, and inhibits damage to the pipe during tightening.



Figure 730 Branch Outlet with Female NPT/ISO 7-1 Threaded Branch



Figure 730 Branch Outlet with Grooved Branch



For Fire Protection Pressure Rating and Listing / Approval information contact Tyco Fire & Building Products.

BRANCH
OUTLETS

Various end configurations are obtainable:



Threaded x Threaded



Grooved x Grooved



Threaded x Grooved

MATERIAL SPECIFICATIONS

Housing Specifications

- ASTM A-536 - Standard Specification for Ductile Iron Castings Grade 65-45-12
- Tensile Strength, minimum psi-65,000 (MPa-448)
- Yield Strength, minimum psi-45,000 (MPa-310)
- Elongation in 2" (50mm), minimum 12%
- ASTM A-153 - Standard Specification for Hot Dip Galvanizing

Bolt / Nut Specifications

Carbon steel oval neck bolts and nuts are heat treated and conform to the physical properties of ASTM A-183 with a minimum tensile strength of 110,000psi (758,422 kPa). Bolts and nuts are Zinc electroplated to ASTM B633.

Gold color coded metric bolts conforming to the physical properties of ASTM F568M are available upon request. Contact Tyco Fire & Building Products.

Gasket Specifications

Grade "E" EPDM gaskets have a green color code identification and conform to ASTM D-2000 for service temperatures from -30°F (-34°C) to 230°F (110°C). They are recommended for hot water not to exceed 230°F (110°C), plus a variety of dilute acids, oil free air and many chemical services. They are not recommended for petroleum services.

Grade "T" Nitrile gaskets have an orange color code identification and conform to ASTM D-2000 for service temperatures from -20°F (-29°C) to 180°F (82°C). They are recommended for petroleum products, vegetable oils, mineral oils, and air with oil vapors.

Coatings

- Orange - non lead (standard)
- RAL Red - non lead (optional)
- Hot Dipped Zinc Galvanized (optional)

BRANCH OUTLETS

Figure 730 Mechanical Tee - Threaded

Nominal Size Run x Branch Inches mm	Hole Dia.†		Max.‡ End Load (Branch) Lbs. kN	Nominal Dimensions					Bolt Size Inches mm	Tee Approx. Weight Lbs. Kg	Cross Approx. Weight Lbs. Kg
	Hole Inches mm	Max. Inches mm		A Inches mm	B Inches mm	C Inches mm	D Inches mm	E Inches mm			
2 x 1/2 50 x 15	1.50 38.1	1.63 41.3	277.1 1.2	2.62 66.5	4.88 124.0	3.07 78.0	2.12 53.8	1.59 40.4	3/8 x 2 1/4 M10 x 57	2.2 1.0	2.6 1.2
2 x 3/4 50 x 20	1.50 38.1	1.63 41.3	433.0 1.9	2.62 66.5	4.88 124.0	3.07 78.0	2.12 53.8	1.59 40.4	3/8 x 2 1/4 M10 x 57	2.2 1.0	2.6 1.2
2 x 1 50 x 25	1.50 38.1	1.63 41.3	679.1 3.0	2.62 66.5	4.88 124.0	3.07 78.0	2.12 53.8	1.59 40.4	3/8 x 2 1/4 M10 x 57	2.2 1.0	2.6 1.2
2 x 1 1/4 50 x 32	1.75 44.5	1.88 47.6	1082.1 4.8	2.78 70.6	4.88 124.0	3.32 84.3	1.93 49.0	1.59 40.4	3/8 x 2 1/4 M10 x 57	2.5 1.1	3.3 1.5
2 x 1 1/2 50 x 40	1.75 44.5	1.88 47.6	1417.6 6.3	2.75 69.9	4.88 124.0	3.32 84.3	1.93 49.0	1.59 40.4	3/8 x 2 1/4 M10 x 57	2.5 1.1	3.7 1.7
2 1/2 x 1/2 65 x 15	1.50 38.1	1.63 41.3	277.1 1.2	2.88 73.2	5.25 133.4	3.07 78.0	2.38 60.5	1.81 46.0	3/8 x 2 1/4 M10 x 57	2.7 1.2	3.1 1.4
2 1/2 x 3/4 65 x 20	1.50 38.1	1.63 41.3	433.0 1.9	2.88 73.2	5.25 133.4	3.07 78.0	2.38 60.5	1.81 46.0	3/8 x 2 1/4 M10 x 57	2.7 1.2	3.1 1.4
2 1/2 x 1 65 x 25	1.50 38.1	1.63 41.3	679.1 3.0	2.88 73.2	5.25 133.4	3.07 78.0	2.38 60.5	1.81 46.0	3/8 x 2 1/4 M10 x 57	2.7 1.2	3.1 1.4
2 1/2 x 1 1/4 65 x 32	2.00 50.8	2.13 54.0	1082.1 4.8	3.00 76.2	5.25 133.4	3.56 90.4	2.19 55.6	1.81 46.0	3/8 x 2 1/4 M10 x 57	3.1 1.4	3.9 1.8
2 1/2 x 1 1/2 65 x 40	2.00 50.8	2.13 54.0	1417.6 6.3	3.07 78.0	5.25 133.4	3.59 91.2	2.17 55.1	1.81 46.0	3/8 x 2 1/4 M10 x 57	3.3 1.5	4.3 1.9
2 1/2 x 2 65 x 50	2.00 50.8	2.13 54.0	2215.1 9.9	3.19 81.0	5.25 133.4	4.00 101.6	2.44 62.0	1.81 46.0	3/8 x 2 1/4 M10 x 57	3.5 1.6	4.4 2.0
76.1mm x 1/2 65 x 15	1.50 38.1	1.63 41.3	277.1 1.2	2.94 74.5	5.62 142.7	3.07 78.0	2.44 62.0	1.87 47.5	M10 x 57	2.7 1.2	3.1 1.4
76.1mm x 3/4 65 x 20	1.50 38.1	1.63 41.3	433.0 1.9	2.94 74.5	5.62 142.7	3.07 78.0	2.44 62.0	1.87 47.5	M10 x 57	2.7 1.2	3.1 1.4
76.1mm x 1 65 x 25	1.50 38.1	1.63 41.3	679.1 3.0	2.94 74.5	5.62 142.7	3.07 78.0	2.44 62.0	1.87 47.5	M10 x 57	2.7 1.2	3.1 1.4
76.1mm x 1 1/4 65 x 32	2.00 50.8	2.13 54.0	1082.1 4.8	3.06 77.7	5.62 142.7	3.56 90.4	2.25 57.2	1.87 47.5	M10 x 57	3.1 1.4	3.9 1.8
76.1mm x 1 1/2 65 x 40	2.00 50.8	2.13 54.0	1417.6 6.3	3.13 79.5	5.62 142.7	3.56 90.4	2.25 57.2	1.87 47.5	M10 x 57	3.3 1.5	5.1 2.3
76.1mm x 2 65 x 50	2.50 63.5	2.63 66.7	2215.1 9.9	3.25 82.6	5.62 142.7	4.00 101.6	2.50 63.5	1.87 47.5	M10 x 57	4.1 1.9	5.9 2.7
3 x 1/2 80 x 15	1.50 38.1	1.63 41.3	277.1 1.2	3.19 81.0	6.13 155.7	3.07 78.0	2.56 65.0	2.21 56.1	1/2 x 3 M12 x 76	3.7 1.7	4.5 2.0
3 x 3/4 80 x 20	1.50 38.1	1.63 41.3	433.0 1.9	3.19 81.0	6.13 155.7	3.07 78.0	2.56 65.0	2.21 56.1	1/2 x 3 M12 x 76	3.7 1.7	4.5 2.0
3 x 1 80 x 25	1.50 38.1	1.63 41.3	679.1 3.0	3.19 81.0	6.13 155.7	3.07 78.0	2.56 65.0	2.21 56.1	1/2 x 3 M12 x 76	3.7 1.7	4.5 2.0
3 x 1 1/4 80 x 32	1.75 44.5	1.88 47.6	1082.1 4.8	3.34 84.8	6.13 155.7	3.32 84.3	2.50 63.5	2.21 56.1	1/2 x 3 M12 x 76	3.9 1.8	4.9 2.2
3 x 1 1/2 80 x 40	2.00 50.8	2.13 54.0	1417.6 6.3	3.38 85.9	6.13 155.7	3.56 90.4	2.48 63.0	2.21 56.1	1/2 x 3 M12 x 76	4.2 1.9	5.5 2.5
3 x 2 80 x 50	2.50 63.5	2.63 66.7	2215.1 9.9	3.50 88.9	6.13 155.7	4.09 103.9	2.75 69.9	2.21 56.1	1/2 x 3 M12 x 76	4.7 2.1	6.5 2.9
4 x 1/2 100 x 15	1.50 38.1	1.63 41.3	277.1 1.2	3.69 93.7	7.13 181.1	3.07 78.0	3.06 77.7	2.78 70.6	1/2 x 3 M12 x 76	5.5 2.5	7.1 3.2
4 x 3/4 100 x 20	1.50 38.1	1.63 41.3	433.0 1.9	3.69 93.7	7.13 181.1	3.07 78.0	3.06 77.7	2.78 70.6	1/2 x 3 M12 x 76	5.5 2.5	7.1 3.2
4 x 1 100 x 25	1.50 38.1	1.63 41.3	679.1 3.0	3.69 93.7	7.13 181.1	3.07 78.0	3.06 77.7	2.78 70.6	1/2 x 3 M12 x 76	5.5 2.5	7.1 3.2
4 x 1 1/4 100 x 32	1.75 44.5	1.88 47.6	1082.1 4.8	3.92 99.6	7.13 181.1	3.32 84.3	3.00 76.2	2.78 70.6	1/2 x 3 M12 x 76	5.5 2.5	7.1 3.2
4 x 1 1/2 100 x 40	2.00 50.8	2.13 54.0	1417.6 6.3	4.00 101.6	7.13 181.1	3.56 90.4	2.98 75.7	2.78 70.6	1/2 x 3 M12 x 76	5.5 2.5	7.1 3.2

† Proper hole preparation is required for effective sealing and performance. Check the pipe seal surface within 5/8" (15.9mm) of the hole to be certain it is free from conditions that would affect proper gasket sealing. Remove any sharp or rough edges from the hole or upper housing contact area, that might affect assembly, proper seating of the locating collar or flow from the outlet. For crosses, ensure double outlet holes are aligned on opposite sides of the pipe. The use of threaded products other than steel pipe, such as dry pendants, etc. may not be compatible with the female threaded outlet on the Mechanical Tee. Always confirm compatibility by contacting Tyco Fire & Building Products.

‡ Maximum pressure and end load are total from all loads based on standard weight steel pipe. Pressure ratings and end loads may differ on other pipe materials and/or wall thickness. Contact Tyco Fire & Building Products for details.

Note: Outlet Threads conforming to ISO 7-1 are available, contact Tyco Fire & Building Products.

Please refer to General Notes on page 14.

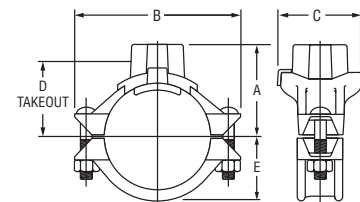

FIGURE 730 BRANCH OUTLET WITH FEMALE NPT/ISO 7-1 THREADED BRANCH (TEE CONFIGURATION)

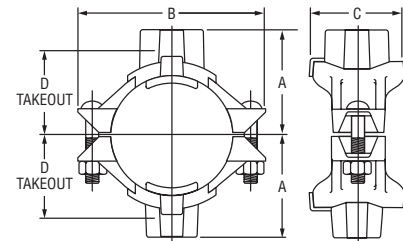

FIGURE 730 BRANCH OUTLETS WITH FEMALE NPT/ISO 7-1 THREADED BRANCH (CROSS CONFIGURATION)

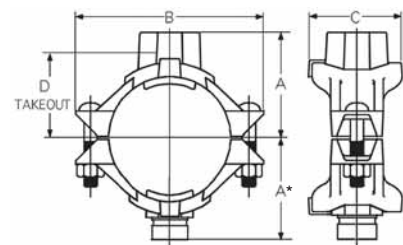

FIGURE 730 BRANCH OUTLET WITH ONE FEMALE NPT/ISO 7-1 THREADED BRANCH & ONE GROOVED BRANCH (CROSS CONFIGURATION)

* see pages 51 & 52 for dimensions

BRANCH
OUTLETS

BRANCH OUTLETS

Figure 730 Mechanical Tee - Threaded

Nominal Size Run x Branch Inches mm	Hole Dia.†		Max.‡ End Load (Branch) Lbs. kN	Nominal Dimensions					Bolt Size Inches mm	Tee Approx. Weight Lbs. Kg	Cross Approx. Weight Lbs. Kg
	Hole Inches mm	Max. Inches mm		A Inches mm	B Inches mm	C Inches mm	D Inches mm	E Inches mm			
4 x 2 100 x 50	2.50 63.5	2.63 66.7	2215.1 9.9	4.00 101.6	7.13 181.1	4.06 103.1	3.25 82.6	2.78 70.6	1/2 x 3 M12 x 76	6.0 2.7	8.1 3.7
4 x 2 1/2 100 x 65	2.75 69.9	2.88 73.0	3245.9 14.4	4.00 101.6	7.13 181.1	4.38 111.3	3.12 79.2	2.78 70.6	1/2 x 3 M12 x 76	6.0 2.7	8.1 3.7
4 x 76.1mm 100 x 65	2.75 69.9	2.88 73.0	3534.3 15.7	4.00 101.6	7.13 181.1	4.38 111.3	3.12 79.2	2.78 70.6	M12 x 76	6.0 2.7	8.1 3.7
4 x 3 100 x 80	3.50 88.9	3.63 92.1	4810.6 21.4	4.13 104.9	7.13 181.1	5.13 130.3	3.31 84.1	2.78 70.6	1/2 x 3 M12 x 76	7.0 3.2	13.5 6.1
5 x 1 1/2 125 x 40	2.00 50.8	2.13 54.0	1417.6 6.3	4.63 117.6	8.13 206.5	3.56 90.4	4.00 101.6	3.37 85.6	5/8 x 4 3/4 M16 x 121	6.5 2.9	7.7 3.5
5 x 2 125 x 50	2.50 63.5	2.63 66.7	2215.1 9.9	4.63 117.6	8.13 206.5	4.06 103.1	3.88 98.6	3.37 85.6	5/8 x 4 3/4 M16 x 121	7.1 3.2	8.1 3.7
5 x 2 1/2 125 x 65	2.75 69.9	2.88 73.0	3245.9 14.4	4.75 120.7	8.13 206.5	4.38 111.3	3.88 98.6	3.37 85.6	5/8 x 4 3/4 M16 x 121	7.3 3.3	8.7 3.9
5 x 76.1mm 125 x 65	2.75 69.9	2.88 73.0	3534.3 15.7	4.75 120.7	8.13 206.5	4.38 111.3	3.88 98.6	3.37 85.6	M16 x 121	7.3 3.3	8.7 3.9
5 x 3 125 x 80	3.50 88.9	3.63 92.1	4810.6 21.4	5.00 127.0	8.13 206.5	5.13 130.3	4.06 103.1	3.37 85.6	5/8 x 4 3/4 M16 x 121	7.6 3.4	14.7 6.7
165.1mm x 1 1/4 150 x 32	2.00 50.8	2.13 54.0	1082.1 4.8	5.13 130.3	9.25 235.0	3.56 90.4	4.25 108.0	3.90 99.1	M16 x 121	6.9 3.1	7.9 3.6
165.1mm x 1 1/2 150 x 40	2.00 50.8	2.13 54.0	1417.6 6.3	5.13 130.3	9.25 235.0	3.56 90.4	4.04 102.6	3.90 99.1	M16 x 121	7.4 3.4	8.9 4.0
165.1mm x 2 150 x 50	2.50 63.5	2.63 66.7	2215.1 9.9	5.13 130.3	9.25 235.0	4.06 103.1	4.31 109.5	3.90 99.1	M16 x 121	7.5 3.4	8.9 4.0
165.1mm x 2 1/2 150 x 65	2.75 69.9	2.88 73.0	3245.9 14.4	5.13 130.3	9.25 235.0	4.38 111.3	4.18 106.2	3.90 99.1	M16 x 121	7.5 3.4	11.1 5.0
165.1mm x 76.1mm 150 x 65	2.75 69.9	2.88 73.0	3584.3 15.7	5.13 130.3	9.25 235.0	4.38 111.3	4.18 106.2	3.90 99.1	M16 x 121	7.5 3.4	11.1 5.0
165.1mm x 3 150 x 80	3.50 88.9	3.63 92.1	4810.6 21.4	5.50 139.7	9.25 235.0	5.13 130.3	4.37 111.0	3.90 99.1	M16 x 121	9.5 4.3	14.1 6.4
165.1mm x 4 150 x 100	4.50 114.3	4.63 117.5	7952.2 35.4	5.38 136.7	9.25 235.0	6.13 155.7	4.56 115.8	3.90 99.1	M16 x 121	10.0 4.5	20.1 9.1
6 x 1 1/4 150 x 32	2.00 50.8	2.13 54.0	1082.1 4.8	5.13 130.3	9.25 235.0	3.56 90.4	4.25 108.0	3.90 99.1	5/8 x 4 3/4 M16 x 121	6.9 3.1	7.9 3.6
6 x 1 1/2 150 x 40	2.00 50.8	2.13 54.0	1417.6 6.3	5.13 130.3	9.25 235.0	3.56 90.4	4.04 102.6	3.90 99.1	5/8 x 4 3/4 M16 x 121	7.4 3.4	8.9 4.0
6 x 2 150 x 50	2.50 63.5	2.63 66.7	2215.1 9.9	5.13 130.3	9.25 235.0	4.06 103.1	4.31 109.5	3.90 99.1	5/8 x 4 3/4 M16 x 121	7.5 3.4	8.9 4.0
6 x 2 1/2 150 x 65	2.75 69.9	2.88 73.0	3245.9 14.4	5.13 130.3	9.25 235.0	4.38 111.3	4.18 106.2	3.90 99.1	5/8 x 4 3/4 M16 x 121	7.5 3.4	11.1 5.0
6 x 76.1mm 150 x 65	2.75 69.9	2.88 73.0	3534.3 15.7	5.13 130.3	9.25 235.0	4.38 111.3	4.18 106.2	3.90 99.1	M16 x 121	7.5 3.4	11.1 5.0
6 x 3 150 x 80	3.50 88.9	3.63 92.1	4810.6 21.4	5.50 139.7	9.25 235.0	5.13 130.3	4.37 111.0	3.90 99.1	5/8 x 4 3/4 M16 x 121	9.5 4.3	14.1 6.4
6 x 4 150 x 100	4.50 114.3	4.63 117.5	7952.2 35.4	5.38 136.7	9.25 235.0	6.13 155.7	4.56 115.8	3.90 99.1	5/8 x 4 3/4 M16 x 121	10.0 4.5	20.1 9.1
8 x 2 1/2 200 x 65	2.75 69.9	2.88 73.0	3245.9 14.4	6.25 158.8	12.50 317.5	4.38 111.3	5.12 130.0	4.90 124.5	3/4 x 4 3/4 M20 x 121	10.2 4.6	12.1 5.5
8 x 76.1mm 200 x 65	2.75 69.9	2.88 73.0	3534.3 15.7	6.25 158.8	12.50 317.5	4.38 111.3	5.12 130.0	4.90 124.5	M20 x 121	10.2 4.6	12.1 5.5
8 x 3 200 x 80	3.50 88.9	3.63 92.1	4810.6 21.4	6.50 165.1	12.50 317.5	5.13 130.3	5.37 136.4	4.90 124.5	3/4 x 4 3/4 M20 x 121	12.5 5.7	15.1 6.8
8 x 4 200 x 100	4.50 114.3	4.63 117.5	7952.2 35.4	6.38 162.1	12.50 317.5	6.13 155.7	5.56 141.2	4.90 124.5	3/4 x 4 3/4 M20 x 121	12.5 5.7	21.1 9.6

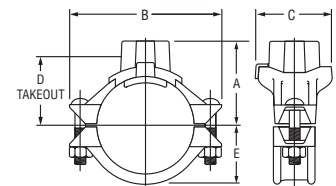

FIGURE 730 BRANCH OUTLET WITH FEMALE NPT/ISO 7-1 THREADED BRANCH (TEE CONFIGURATION)

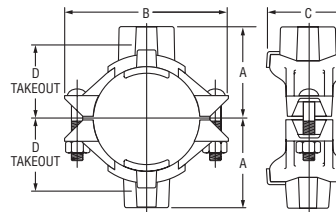

FIGURE 730 BRANCH OUTLETS WITH FEMALE NPT/ISO 7-1 THREADED BRANCH (CROSS CONFIGURATION)

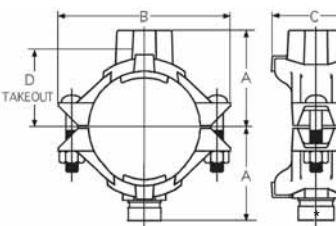

FIGURE 730 BRANCH OUTLET WITH ONE FEMALE NPT/ISO 7-1 THREADED BRANCH & ONE GROOVED BRANCH (CROSS CONFIGURATION)

* see pages 51 & 52 for dimensions

† Proper hole preparation is required for effective sealing and performance. Check the pipe seal surface within 5/8" (15.9mm) of the hole to be certain it is free from conditions that would affect proper gasket sealing. Remove any sharp or rough edges from the hole or upper housing contact area, that might affect assembly, proper seating of the locating collar or flow from the outlet. For crosses, ensure double outlet holes are aligned on opposite sides of the pipe. The use of threaded products other than steel pipe, such as dry pendants, etc. may not be compatible with the female threaded outlet on the Mechanical Tee. Always confirm compatibility by contacting Tyco Fire & Building Products.

‡ Maximum pressure and end load are total from all loads based on standard weight steel pipe. Pressure ratings and end loads may differ on other pipe materials and/or wall thickness. Contact Tyco Fire & Building Products for details.

Note: Outlet Threads conforming to ISO 7-1 are available, contact Tyco Fire & Building Products.

Please refer to General Notes on page 14.

BRANCH OUTLETS

Figure 730 Mechanical Tee - Grooved

Nominal Size Run x Branch Inches mm	Hole Dia.†		Max.‡ End Load (Branch) Lbs. kN	Nominal Dimensions				Bolt Size Inches mm	Tee Approx. Weight Lbs. Kg	Cross Approx. Weight Lbs. Kg
	Hole Inches mm	Max. Inches mm		A Inches mm	B Inches mm	C Inches mm	E Inches mm			
2 x 1¼ 50 x 32	1.75 44.5	1.88 47.6	1082.1 4.8	2.78 70.6	4.88 124.0	3.32 84.3	1.59 40.4	3/8" x 2¼" M10 x 57	2.5 1.1	3.3 1.5
2 x 1½ 50 x 40	1.75 44.5	1.88 47.6	1417.6 6.3	2.62 66.5	4.88 124.0	3.32 84.3	1.59 40.4	3/8" x 2¼" M10 x 57	2.5 1.1	3.7 1.7
2½ x 1¼ 65 x 32	2.00 50.8	2.13 54.0	1082.1 4.8	3.00 76.2	5.25 133.4	3.56 90.4	1.81 46.0	3/8" x 2¼" M10 x 57	3.1 1.4	3.9 1.8
2½ x 1½ 65 x 40	2.00 50.8	2.13 54.0	1417.6 6.3	3.07 78.0	5.25 133.4	3.59 91.2	1.81 46.0	3/8" x 2¼" M10 x 57	3.3 1.5	4.3 1.9
2½ x 2 65 x 50	2.00 50.8	2.13 54.0	2215.1 9.9	3.19 81.0	5.25 133.4	4.00 101.6	1.81 46.0	3/8" x 2¼" M10 x 57	3.5 1.6	4.4 2.0
76.1mm x 1¼ 65 x 32	2.00 50.8	2.13 54.0	1082.1 4.8	3.06 77.7	5.62 142.7	3.56 90.4	1.87 47.5	M10 x 57	3.1 1.4	3.9 1.8
76.1mm x 1½ 65 x 40	2.00 50.8	2.13 54.0	1417.6 6.3	3.13 79.5	5.62 142.7	3.56 90.4	1.87 47.5	M10 x 57	3.3 1.5	5.1 2.3
76.1mm x 2 65 x 50	2.50 63.5	2.63 66.7	2215.1 9.9	3.25 82.6	5.62 142.7	4.00 101.6	1.87 47.5	M10 x 57	4.1 1.9	5.9 2.7
3 x 1¼ 80 x 32	1.75 44.5	1.88 47.6	1082.1 4.8	3.34 84.8	6.13 155.7	3.32 84.3	2.21 56.1	½" x 3" M12 x 76	3.9 1.8	4.9 2.2
3 x 1½ 80 x 40	2.00 50.8	2.13 54.0	1417.6 6.3	3.38 85.9	6.13 155.7	3.56 90.4	2.21 56.1	½" x 3" M12 x 76	4.2 1.9	5.5 2.5
3 x 2 80 x 50	2.50 63.5	2.63 66.7	2215.1 9.9	3.50 88.9	6.13 155.7	4.09 103.9	2.21 56.1	½" x 3" M12 x 76	4.7 2.1	6.5 2.9
4 x 1¼ 100 x 32	1.75 44.5	1.88 47.6	1082.1 4.8	3.92 99.6	7.13 181.1	3.32 84.3	2.78 70.6	½" x 3" M12 x 76	5.5 2.5	7.1 3.2
4 x 1½ 100 x 40	2.00 50.8	2.13 54.0	1417.6 6.3	4.00 101.6	7.13 181.1	3.56 90.4	2.78 70.6	½" x 3" M12 x 76	5.5 2.5	7.1 3.2
4 x 2 100 x 50	2.50 63.5	2.63 66.7	2215.1 9.9	4.00 101.6	7.13 181.1	4.06 103.1	2.78 70.6	½" x 3" M12 x 76	6.0 2.7	8.1 3.7
4 x 2½ 100 x 65	2.75 69.9	2.88 73.0	3245.9 14.4	4.00 101.6	7.13 181.1	4.38 111.3	2.78 70.6	½" x 3" M12 x 76	6.0 2.7	8.1 3.7
4 x 76.1mm 100 x 65	2.75 69.9	2.88 73.0	3534.3 15.7	4.00 101.6	7.13 181.1	4.38 111.3	2.78 70.6	M12 x 76	6.0 2.7	8.1 3.7
4 x 3 100 x 80	3.50 88.9	3.63 92.1	4810.6 21.4	4.13 104.9	7.13 181.1	5.13 130.3	2.78 70.6	½" x 3" M12 x 76	7.0 3.2	13.5 6.1
5 x 1½ 125 x 40	2.00 50.8	2.13 54.0	1417.6 6.3	4.63 117.6	8.13 206.5	3.56 90.4	3.37 85.6	5/8" x 4¾" M16 x 121	6.5 2.9	7.7 3.5
5 x 2 125 x 50	2.50 63.5	2.63 66.7	2215.1 9.9	4.63 117.6	8.13 206.5	4.06 103.1	3.37 85.6	5/8" x 4¾" M16 x 121	7.1 3.2	8.1 3.7
5 x 2½ 125 x 65	2.75 69.9	2.88 73.0	3245.9 14.4	4.75 120.7	8.13 206.5	4.38 111.3	3.37 85.6	5/8" x 4¾" M16 x 121	7.3 3.3	8.7 3.9

† Proper hole preparation is required for effective sealing and performance. Check the pipe seal surface within 5/8" (15.9mm) of the hole to be certain it is free from conditions that would affect proper gasket sealing. Remove any sharp or rough edges from the hole or upper housing contact area, that might affect assembly, proper seating of the locating collar or flow from the outlet. For crosses, ensure double outlet holes are aligned on opposite sides of the pipe.

‡ Maximum pressure and end load are total from all loads based on standard weight steel pipe. Pressure ratings and end loads may differ on other pipe materials and/or wall thickness. Contact Tyco Fire & Building Products for details. Please refer to General Notes on page 14.

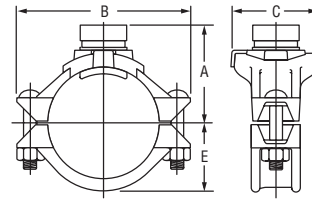

FIGURE 730 BRANCH OUTLET WITH GROOVED BRANCH (TEE CONFIGURATION)

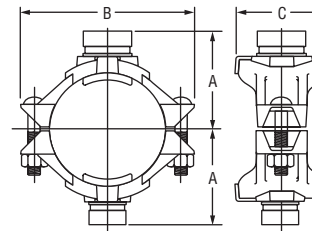

FIGURE 730 BRANCH OUTLETS WITH GROOVED BRANCH (CROSS CONFIGURATION)

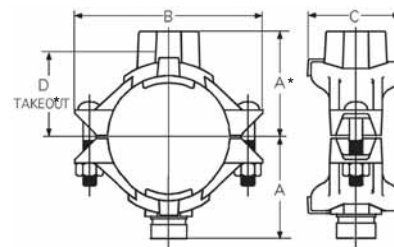

FIGURE 730 BRANCH OUTLET WITH ONE FEMALE NPT/ISO 7-1 THREADED BRANCH & ONE GROOVED BRANCH (CROSS CONFIGURATION)

* see pages 49 & 50 for dimensions

BRANCH
OUTLETS

BRANCH OUTLETS

Figure 730 Mechanical Tee - Grooved

Nominal Size Run x Branch Inches mm	Hole Dia.†		Max.‡ End Load (Branch) Lbs. kN	Nominal Dimensions				Bolt Size Inches mm	Tee Approx. Weight Lbs. Kg	Cross Approx. Weight Lbs. Kg
	Hole Inches mm	Max. Inches mm		A Inches mm	B Inches mm	C Inches mm	E Inches mm			
5 x 76.1mm 125 x 65	2.75 69.9	2.88 73.0	3534.3 15.7	4.75 120.7	8.13 206.5	4.38 111.3	3.37 85.6	M16 x 121	7.3 3.3	8.7 3.9
5 x 3 125 x 80	3.50 88.9	3.63 92.1	4810.6 21.4	5.00 127.0	8.13 206.5	5.13 130.3	3.37 85.6	5/8" x 4 3/4" M16 x 121	7.6 3.4	14.7 6.7
165.1mm x 1 1/4 150 x 32	2.00 50.8	2.13 54.0	1082.1 4.8	5.13 130.3	9.25 235.0	3.56 90.4	3.90 99.1	M16 x 121	6.9 3.1	7.9 3.6
165.1mm x 1 1/2 150 x 40	2.00 50.8	2.13 54.0	1417.6 6.3	5.13 130.3	9.25 235.0	3.56 90.4	3.90 99.1	M16 x 121	7.4 3.4	8.9 4.0
165.1mm x 2 150 x 50	2.50 63.5	2.63 66.7	2215.1 9.9	5.13 130.3	9.25 235.0	4.06 103.1	3.90 99.1	M16 x 121	7.5 3.4	8.9 4.0
165.1mm x 2 1/2 150 x 65	2.75 69.9	2.88 73.0	3245.9 14.4	5.13 130.3	9.25 235.0	4.38 111.3	3.90 99.1	M16 x 121	7.5 3.4	11.1 5.0
165.1mm x 76.1mm 150 x 65	2.75 69.9	2.88 73.0	3534.3 15.7	5.13 130.3	9.25 235.0	4.38 111.3	3.90 99.1	M16 x 121	7.5 3.4	11.1 5.0
165.1mm x 3 150 x 80	3.50 88.9	3.63 92.1	4810.6 21.4	5.50 139.7	9.25 235.0	5.13 130.3	3.90 99.1	M16 x 121	9.5 4.3	14.1 6.4
165.1mm x 4 150 x 100	4.50 114.3	4.63 117.5	7952.2 35.4	5.38 136.7	9.25 235.0	6.13 155.7	3.90 99.1	M16 x 121	10.0 4.5	20.1 9.1
6 x 1 1/4 150 x 32	2.00 50.8	2.13 54.0	1082.1 4.8	5.13 130.3	9.25 235.0	3.56 90.4	3.90 99.1	5/8" x 4 3/4" M16 x 121	6.9 3.1	7.9 3.6
6 x 1 1/2 150 x 40	2.00 50.8	2.13 54.0	1417.6 6.3	5.13 130.3	9.25 235.0	3.56 90.4	3.90 99.1	5/8" x 4 3/4" M16 x 121	7.4 3.4	8.9 4.0
6 x 2 150 x 50	2.50 63.5	2.63 66.7	2215.1 9.9	5.13 130.3	9.25 235.0	4.06 103.1	3.90 99.1	5/8" x 4 3/4" M16 x 121	7.5 3.4	8.9 4.0
6 x 2 1/2 150 x 65	2.75 69.9	2.88 73.0	3245.9 14.4	5.13 130.3	9.25 235.0	4.38 111.3	3.90 99.1	5/8" x 4 3/4" M16 x 121	7.5 3.4	11.1 5.0
6 x 76.1mm 150 x 65	2.75 69.9	2.88 73.0	3534.3 15.7	5.13 130.3	9.25 235.0	4.38 111.3	3.90 99.1	M16 x 121	7.5 3.4	11.1 5.0
6 x 3 150 x 80	3.50 88.9	3.63 92.1	4810.6 21.4	5.50 139.7	9.25 235.0	5.13 130.3	3.90 99.1	5/8" x 4 3/4" M16 x 121	9.5 4.3	14.1 6.4
6 x 4 150 x 100	4.50 114.3	4.63 117.5	7952.2 35.4	5.38 136.7	9.25 235.0	6.13 155.7	3.90 99.1	5/8" x 4 3/4" M16 x 121	10.0 4.5	20.1 9.1
8 x 2 1/2 200 x 65	2.75 69.9	2.88 73.0	3245.9 14.4	6.25 158.8	12.50 317.5	4.38 111.3	4.90 124.5	M20 x 121	10.2 4.6	12.1 5.5
8 x 76.1mm 200 x 65	2.75 69.9	2.88 73.0	3534.3 15.7	6.25 158.8	12.50 317.5	4.38 111.3	4.90 124.5	M20 x 121	10.2 4.6	12.1 5.5
8 x 3 200 x 80	3.50 88.9	3.63 92.1	4810.6 21.4	6.50 165.1	12.50 317.5	5.13 130.3	4.90 124.5	3/4" x 4 3/4" M20 x 121	12.5 5.7	15.1 6.8
8 x 4 200 x 100	4.50 114.3	4.63 117.5	7952.2 35.4	6.38 162.1	12.50 317.5	6.13 155.7	4.90 124.5	3/4" x 4 3/4" M20 x 121	12.5 5.7	21.1 9.6

† Proper hole preparation is required for effective sealing and performance. Check the pipe seal surface within 5/8" (15.9mm) of the hole to be certain it is free from conditions that would affect proper gasket sealing. Remove any sharp or rough edges from the hole or upper housing contact area, that might affect assembly, proper seating of the locating collar or flow from the outlet. For crosses, ensure double outlet holes are aligned on opposite sides of the pipe.

‡ Maximum pressure and end load are total from all loads based on standard weight steel pipe. Pressure ratings and end loads may differ on other pipe materials and/or wall thickness. Contact Tyco Fire & Building Products for details.
Please refer to General Notes on page 14.

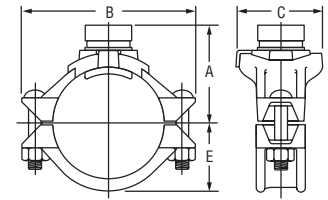

FIGURE 730 BRANCH OUTLET WITH GROOVED BRANCH (TEE CONFIGURATION)

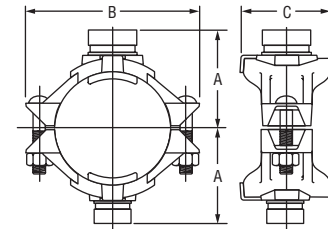

FIGURE 730 BRANCH OUTLETS WITH GROOVED BRANCH (CROSS CONFIGURATION)

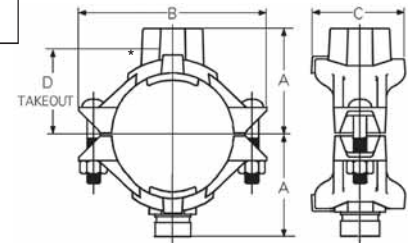

FIGURE 730 BRANCH OUTLET WITH ONE FEMALE NPT/ISO 7-1 THREADED BRANCH & ONE GROOVED BRANCH (CROSS CONFIGURATION)

* see pages 49 & 50 for dimensions

Valves



CHECK
VALVE



VALVES



BUTTERFLY VALVES

Model B302

Grinnell® Model B302 Butterfly Valves are capable of pressures of 300 psi (20.7 Bar) for sizes 2" - 8" (60.3mm - 219.1mm) and 200 psi for sizes 10" and 12" (273.0mm and 323.9mm). The valves are designed for efficient control of: on/off or throttling/balancing service, fluid flow and "bubble tight" shut off in piping systems. Flow may be from either direction and the valve may be positioned in any orientation. The valves are available with either a Gear Operator, for sizes 2" - 12" (60.3mm - 323.9mm) or Lever-Lock Operator, for sizes 2" - 8" (60.3mm - 219.1mm). The valves are furnished with grooved ends for use with grooved couplings and can be easily adapted to flanged components utilizing Grinnell Figure 71 Class 150 Flange Adapters.

The body and disc construction provides for increased strength and durability. The disc seal and body coatings are compatible with a variety of chemicals and temperature ranges (Contact Tyco Fire & Building Products for specific recommendations on seal and coating selections).

The Model B302 Butterfly Valve with Gear Operator is a self-locking worm gear type. It is equipped with adjustable stops at the open and shut positions.

The Model B302 Butterfly Valve with Lever-Lock Operator has a throttling plate which provides throttling notches every 10° for manual control in balancing up to 90° or shut off service. The lever may be padlocked in any one of the positions including opened or closed by virtue of a locking hole located in the handle and lever.

Tech Data: G310



Model B302 with Gear Operator



Model B302 with Lever-Lock Operator

BUTTERFLY VALVES

Model B302 Grooved End Butterfly Valve with Gear Operator

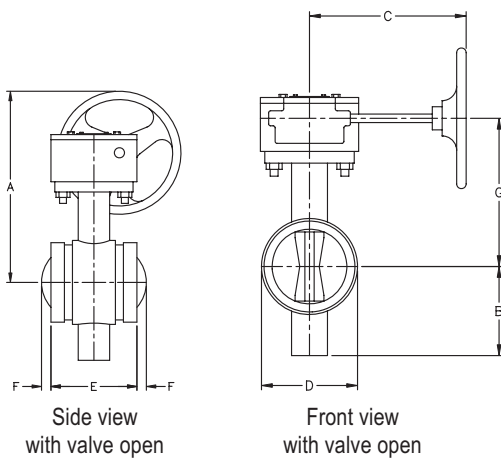

Nominal Size Inches mm	Nominal Dimensions							Approx. Weight Lbs. Kg
	A Inches mm	B Inches mm	C Inches mm	D Inches mm	E Inches mm	F Inches mm	G Inches mm	
2 50	8.46 214.9	3.14 79.8	7.64 194.1	2.89 73.4	3.33 84.6	N/A*	5.50 139.7	14.5 6.6
2½ 65	8.65 219.7	3.25 82.6	7.64 194.1	3.46 87.9	3.85 97.8	N/A*	5.69 144.5	15.5 7.0
3 80	8.99 226.1	3.54 89.9	7.64 194.1	3.97 100.8	3.85 97.8	N/A*	5.94 150.9	17.0 7.7
4 100	9.79 248.7	4.35 110.5	7.64 194.1	5.03 127.8	4.56 115.8	N/A*	8.00 203.2	20.5 9.3
5 125	9.30 236.2	4.84 122.9	7.64 194.1	6.28 159.3	5.86 148.8	N/A*	7.33 186.2	25.0 11.3
6 150	13.53 343.7	5.93 150.6	9.53 242.1	7.25 184.2	5.86 148.8	N/A*	8.61 218.7	33.0 15.0
8 200	14.47 367.5	6.87 174.5	9.53 242.1	9.25 235.0	5.26 133.6	1.30 33.0	9.55 242.6	45.0 20.4
10 250	16.53 418.9	9.17 232.9	11.54 293.1	11.25 285.8	6.29 159.8	1.65 41.9	11.61 294.9	83.0 37.6
12 300	17.52 445.0	10.17 258.3	11.54 293.1	13.14 333.8	6.52 165.6	2.56 65.0	12.60 320.0	100.0 45.4

* End of disc does not extend beyond valve body.

Please refer to General Notes on page 14.

PERFORMANCE

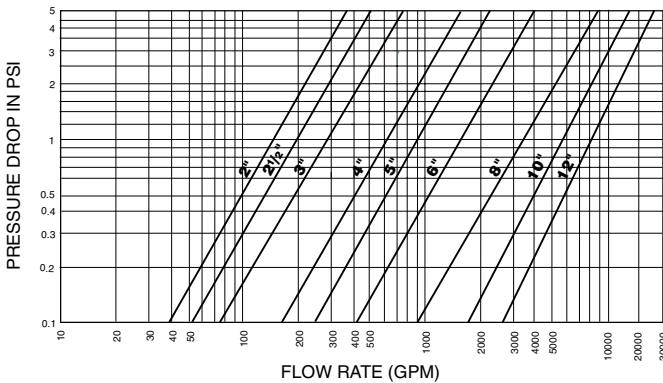

Note: It is good piping practice to apply a safety factor of 15% to 20% to the values in the above table.

MATERIAL SPECIFICATIONS

Ductile Iron Body and Disc Specifications

- ASTM A-395 - Standard Specification for Ductile Iron Castings
- Grade 60-40-18
- Tensile Strength, minimum psi-60,000 (MPa-414)
- Yield Strength, minimum psi-40,000 (MPa-276)
- Elongation in 2" (50mm), minimum 18%

Body Coating Black Polyimid Coated

Upper and Lower Stem

Type 416 Stainless Steel

Gear Operator Cast Iron Housing

Disc Seal Specifications

Encapsulated Rubber

EPDM - for service temperatures from -20°F (-29°C) to 250°F (121°C), intermittent service at 250°F (121°C) and continuous service at 225°F (107°C). They are recommended for hot water not to exceed the temperature ratings above, plus a variety of dilute acids, alkalines and many chemical services. They are not recommended for petroleum oil, strong acid, strong alkaline or compressed air services.

Nitrile - for service temperatures from -20°F (-29°C) to 180°F (82°C). They are recommended for solvents, oils, water and hydraulic fluid resistance. They are not recommended for highly polar solvents such as acetone and methyl ethyl ketone, chlorinated hydrocarbons, ozone or nitro hydrocarbons and some aviation fuels.

VALVES

BUTTERFLY VALVES

Model B302 Grooved End Butterfly Valve with Lever Lock Operator

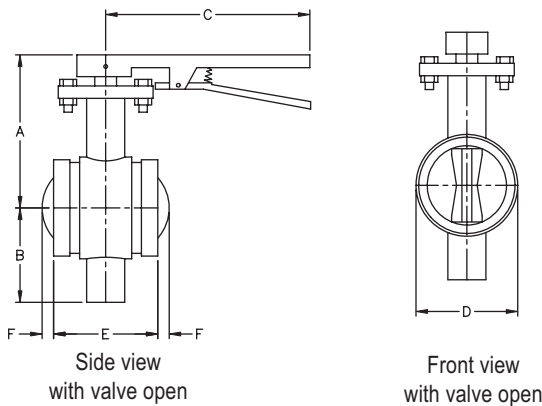

Nominal Size Inches mm	Nominal Dimensions						Approx. Weight Lbs. Kg
	A Inches mm	B Inches mm	C Inches mm	D Inches mm	E Inches mm	F Inches mm	
2 50	5.00 127.0	3.14 79.8	10.50 266.7	2.89 73.4	3.33 84.6	N/A*	6.5 2.9
2½ 65	5.19 131.8	3.25 82.6	10.50 266.7	3.46 87.9	3.85 97.8	N/A*	7.0 3.2
3 80	5.44 138.2	3.54 89.9	10.50 266.7	3.97 100.8	3.85 97.8	N/A*	8.5 3.9
4 100	6.33 160.8	4.35 110.5	13.75 349.3	5.03 127.8	4.56 115.8	N/A*	13.0 5.9
5 125	6.83 173.5	4.84 122.9	13.75 349.3	6.27 159.3	5.86 148.8	N/A*	18.0 8.2
6 150	8.11 206.0	5.93 150.6	13.75 349.3	7.25 184.2	5.86 148.8	N/A*	25.0 11.3
8 200	9.05 229.9	6.87 174.5	13.75 349.3	9.25 235.0	5.26 133.6	1.30 33.0	33.0 15.0

* End of disc does not extend beyond valve body.

Please refer to General Notes on page 14.

PERFORMANCE

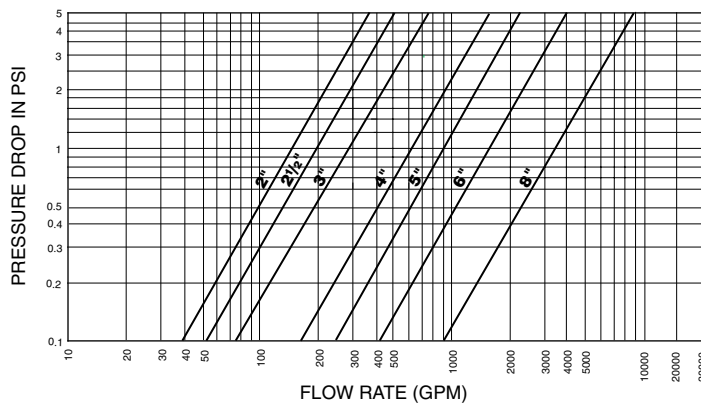

Note: It is good piping practice to apply a safety factor of 15% to 20% to the values in the above table.

MATERIAL SPECIFICATIONS

Ductile Iron Body & Disc Specifications

- ASTM A-395 - Standard Specification for Ductile Iron Castings
- Grade 60-40-18
- Tensile Strength, minimum psi-60,000 (MPa-414)
- Yield Strength, minimum psi-40,000 (MPa-276)
- Elongation in 2" (50mm), minimum 18%

Body Coating Black Polyimid Coated

Upper and Lower Stem

Type 416 Stainless Steel

Lever-Lock Operator

- Handle - Iron Polymer Coated
- Lever-Lock - Steel Zinc Plated
- Throttling Plate - Steel Zinc Plated

Disc Seal Specifications Encapsulated Rubber

EPDM - for service temperatures from -20°F (-29°C) to 250°F (121°C), intermittent service at 250°F (121°C) and continuous service at 225°F (107°C). They are recommended for hot water not to exceed the temperature ratings above, plus a variety of dilute acids, alkalines and many chemical services. They are not recommended for petroleum oil, strong acid, strong alkaline or compressed air services.

Nitrile - for service temperatures from -20°F (-29°C) to 180°F (82°C). They are recommended for solvents, oils, water and hydraulic fluid resistance. They are not recommended for highly polar solvents such as acetone and methyl ethyl ketone, chlorinated hydrocarbons, ozone or nitro hydrocarbons and some aviation fuels.

BUTTERFLY VALVES

Model 308 14" - 24" Butterfly Valve

The Model 308 Butterfly Valve provides dependable, long-term service and superior control of fluid flow in piping systems. Flow may be from either direction and the valve may be positioned in any orientation. The valve is furnished with grooved ends for use with grooved couplings. The body and disc design provides exceptional flow characteristics and low operating torque. The disc has a streamline profile that optimizes flow. The body is lined with an elastomer seat that is reinforced with a phenolic backing ring, reducing seat distortion, and wear.

The Model 308 Butterfly Valve is provided with a gear operator with adjustable stops at the open and shut positions.

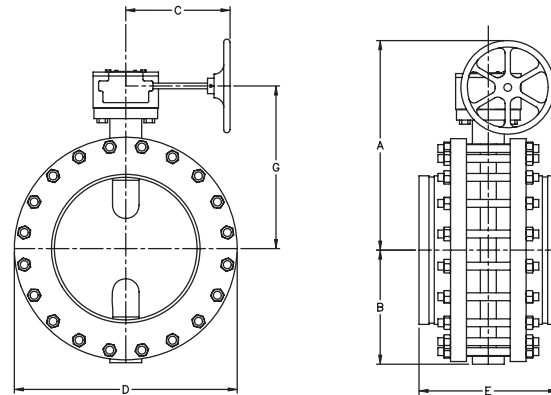

Tech Data: G320

Maximum Working Pressure is 150 psi (10.3 Bar) with 316 S.S. Stem and 200 psi (13.8 Bar) with 416 S.S. Stem. Special order is available upon request: Vacuum Service to 29.5" (750mm) Hg.

Temperature rating for Grade E EPDM seat material is -40°F (-40°C) to $+230^{\circ}\text{F}$ ($+110^{\circ}\text{C}$), recommended for water service, dilute acids, alkalis, oil-free air and many chemical services. **NOT RECOMMENDED FOR USE IN PETROLEUM SERVICES.** The temperature rating for Grade T (Nitrile) seat material is -20°F (-29°C) to $+180^{\circ}\text{F}$ ($+82^{\circ}\text{C}$), recommended for petroleum products, air with oil vapors, vegetable oils and mineral oils. **NOT RECOMMENDED FOR USE IN HOT WATER SERVICES.** (Contact Tyco Fire & Building Products for specific recommendations on seat material.)

VALVES

BUTTERFLY VALVES

Model 308 14" - 24" Butterfly Valve

MATERIAL SPECIFICATIONS

Body

- Cast Iron conforming to ASTM A-126, Class B

Body Seat (Liner)

- Grade E EPDM, Grade T Nitrile or Viton®

Body Coating

Epoxy Coated

Disc

- Stainless Steel conforming to ASTM A-351, Grade CF8M
- Aluminum Bronze conforming to ASTM B-148, C95400
- Ductile Iron conforming to ASTM A-536 Grade 65-45-12

Drive and Bottom Shaft

Stainless Steel conforming to ASTM A-582, Type 416 or Stainless Steel conforming to ASTM A-276, Type 316

Gear Operator

Cast Iron Housing

Upper and Lower Bearings

Reinforced Teflon

Plug

Cast Iron ASTM A-126

Nominal Size Inches mm	Nominal Dimensions						Approx. Weight Lbs. Kg
	A Inches mm	B Inches mm	C Inches mm	D Inches mm	E Inches mm	F Inches mm	
14 350	23.25 590.6	10.75 273.1	10.00 254.0	21.00 533.4	13.06 331.7	15.25 387.4	378.0 171.8
16 400	24.75 628.7	12.50 317.5	10.00 254.0	23.50 596.9	14.33 364.0	16.75 425.5	452.0 205.5
18 450	25.75 654.1	14.00 355.6	10.00 254.0	25.00 635.0	15.40 391.2	17.75 450.9	548.0 249.1
20 500	27.25 692.2	15.00 381.0	10.00 254.0	27.50 698.5	16.38 416.1	18.25 463.6	728.0 330.9
24 600	30.12 765.0	16.75 425.5	10.25 260.4	32.00 812.8	18.26 463.8	21.12 536.4	1097.0 498.6

VALVES

Viton® is an E.I. Dupont trademark

PERFORMANCE

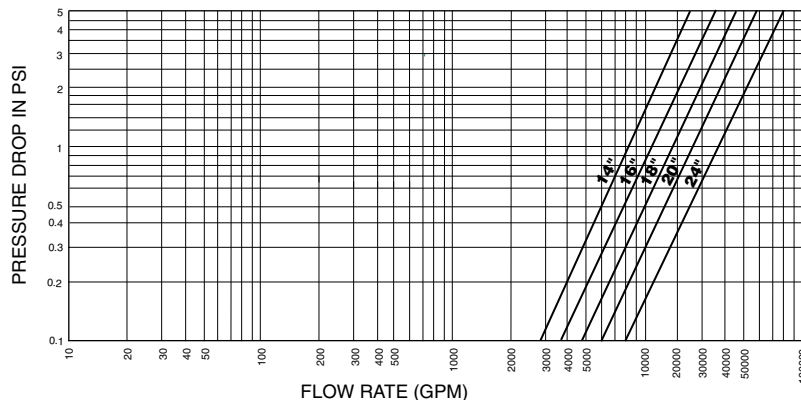

Note: It is good piping practice to apply a safety factor of 15% to 20% to the values in the above table for design purposes.

BUTTERFLY VALVES

Model B8101 Low Profile Butterfly Valve

The Model B8101 Low Profile Butterfly Valve has a rated working pressure of 200 PSI and provides efficient control of fluid in piping systems. Flow may be from either direction, and the valve may be positioned in any orientation. The ductile iron body is epoxy coated to resist atmospheric corrosion and the disc is EPDM encapsulated ductile iron to be compatible with a variety of chemicals and temperature ranges.



Tech Data: G330

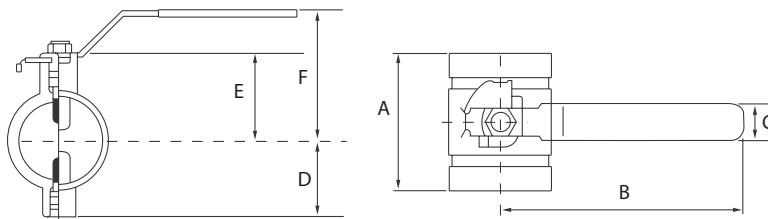

VALVES

MATERIAL SPECIFICATIONS

Body

- Ductile Iron

Body Coating

Black Epoxy Coated

Disc

Ductile Iron

Disc Seal

EPDM encapsulated rubber

Stem

Two-piece Stainless Steel, splined

Stem Seal

O-rings, upper and lower stem

Handle

Carbon Steel zinc plated

Nominal Size Inches	A Inches mm	B Inches mm	C Inches mm	D Inches mm	E Inches mm	F Inches mm
2 50	3.39 86.0	5.98 152.0	0.98 25.0	1.81 46.0	1.97 50.0	3.15 80.0
2½ 65	3.78 96.0	5.98 152.0	0.98 25.0	2.05 52.0	2.40 61.0	3.58 91.0
3 80	3.78 96.0	8.27 210.0	0.98 25.0	2.56 65.0	2.64 67.0	4.21 107.0
4 100	4.53 115.0	8.27 210.0	0.98 25.0	3.27 83.0	3.27 83.0	4.84 123.0
6 150	5.20 132.0	12.01 305.0	1.26 32.0	4.29 109.0	4.29 109.0	6.85 174.0

BALL VALVES

Model BV835 Ball Valve

The Model BV835 Ball Valve is capable of a working pressure of 1,000 P.S.I. in sizes 2", 2 1/2", and 3". Flow may be from either direction and the valves may be positioned in any orientation. The Model BV835 is furnished with grooved ends and features a handle that accepts a padlock device for locking in either the open or closed position.



Tech Data: G380

Valve Size Inches <i>mm</i>	Pipe O.D. Inches <i>mm</i>	Nominal Size			Approx. Weight lbs. <i>Kgs</i>
		A Inches <i>mm</i>	B Inches <i>mm</i>	C Inches <i>mm</i>	
2" 50	2.375 60.3	5.50 140.0	3.75 95.0	7.00 178.0	6.9 3.1
2 1/2" 65	2.875 73.0	6.25 159.0	5.20 132.0	10.43 265.0	13.0 5.9
3" 80	3.500 88.9	6.56 167.0	5.63 143.0	10.43 265.0	27.5 12.5

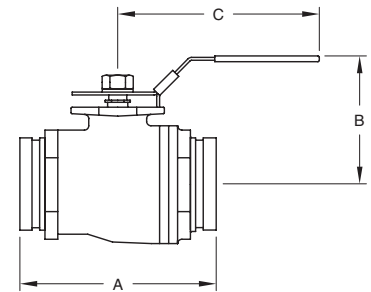

VALVES

MATERIAL SPECIFICATIONS

Body

- Ductile iron conforming to ASTM A-536, Grade 65-45-12

Body Coating

Black Enamel

Ball

304SS

Ball Seal

Teflon

Upper Stem

Carbon Steel Nickel Plated

Operator

Lever with locking device

Performance

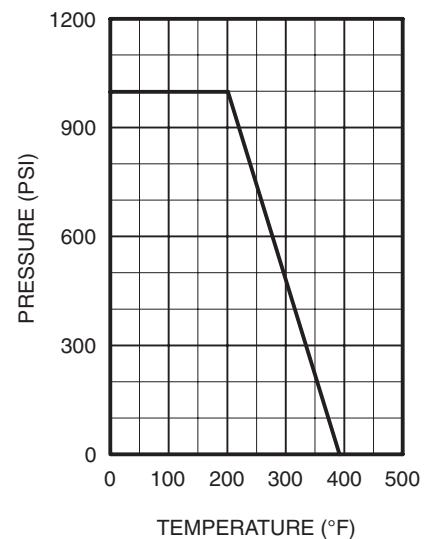

CHECK VALVES

Model 590 Grooved End Check Valve

Grinnell® Model 590 Check Valves are capable of pressures up to 300 psi (20.7 Bar) and are designed as compact and rugged swing-type units that allow water flow in one direction and prevent flow in the opposite direction. They are manufactured with a ductile iron body, nickel seat and a stainless steel clapper assembly for sizes 2"-8" (60.3mm - 219.1 mm), and a ductile iron clapper assembly for sizes 10"-12" (273.0mm - 323.9 mm). A resilient elastomer seal facing on the spring loaded clapper ensures a leak tight seal and a non-sticking operation. All Model 590 Check Valves are designed to minimize water hammer caused by flow reversal.

The valves are furnished with grooved ends and can be installed using grooved couplings. The Model 590 can be installed with ANSI class 150 Flanges utilizing our Figure 71 flange adapters and also ANSI class 300 Flange Adapters. All Model 590 Check Valves have been designed with a removable cover for ease of field maintenance. They may be installed in either horizontal or vertical piping systems with the flow in the upward or downward direction.



Tech Data: G350

MATERIAL SPECIFICATIONS

Ductile Iron Body & Cap Specifications

- ASTM A-536 - Standard Specification for Ductile Iron Castings Grade 65-45-12
- Tensile Strength, minimum psi-65,000 (MPa-448)
- Yield Strength, minimum psi-45,000 (MPa-310)
- Elongation in 2" (50mm), minimum 12%

Seat

Nickel

Coating

Non-lead paint

Seal Specifications

Grade "E" EPDM seals have a green color code identification and conform to ASTM D-2000 for service temperatures from -30°F (-34°C) to 230°F (110°C). They are recommended for hot water not to exceed 230°F (110°C), plus a variety of dilute acids, oil free air and many chemical services. They are not recommended for petroleum services.

Grade "T" Nitrile seals have an orange color code identification and conform to ASTM D-2000 for service temperatures from -20°F (-29°C) to 180°F (82°C). They are recommended for petroleum products, vegetable oils, mineral oils, and air with oil vapors.

VALVES

CHECK VALVES

Model 590 Grooved End Check Valve

Nominal Size	Nominal Dimensions					Cover Bolt Torque	Approx. Weight
	A	B	C	D	E		
Inches mm	Inches mm	Inches mm	Inches mm	Inches mm	Inches mm	Lb.-ft/mm	Lbs. Kg
2	6.75	4.38	2.55	2.57	3.25	15	9.0
50	171.5	111.3	64.8	65.3	82.3	21	4.5
2½	8.00	5.42	3.41	3.09	3.88	39	10.0
65	203.2	136.7	86.6	78.5	98.6	54	4.5
76.1mm	8.00	5.42	3.41	3.09	3.88	39	10.0
	203.2	136.7	86.6	78.5	98.6	54	4.5
3	8.38	5.76	3.60	3.31	3.88	39	11.0
80	212.9	146.3	91.4	84.1	98.6	54	5.0
4	9.63	6.74	4.61	3.63	4.53	39	25.0
100	245.6	171.2	117.1	92.2	115.4	54	11.3
139.7mm	10.50	7.50	5.29	4.13	4.90	39	29.0
	266.7	190.5	134.4	104.9	124.5	54	13.2
5	10.50	7.50	5.29	4.13	4.90	39	29.0
125	266.7	190.5	134.4	104.9	124.5	54	13.2
165.1mm	11.50	8.05	5.75	4.50	5.00	60	47.0
	292.1	204.4	146.1	114.3	127.0	82	21.3
6	11.50	8.05	5.75	4.50	5.00	60	47.0
150	292.1	204.4	146.1	114.3	127.0	82	21.3
8	14.00	10.25	7.75	5.62	5.45	120	66.0
200	355.6	260.4	196.9	142.7	138.4	164	30.0
10	18.00	13.00	10.21	6.38	7.50	120	109.7
250	457.2	330.2	259.3	162.1	190.5	164	49.4
12	21.0	14.28	11.31	7.26	7.62	120	151.0
300	533.4	362.7	287.2	184.4	193.5	164	68.0

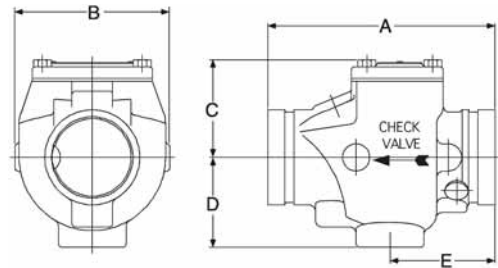

VALVES

Please refer to General Notes on page 14.

PERFORMANCE

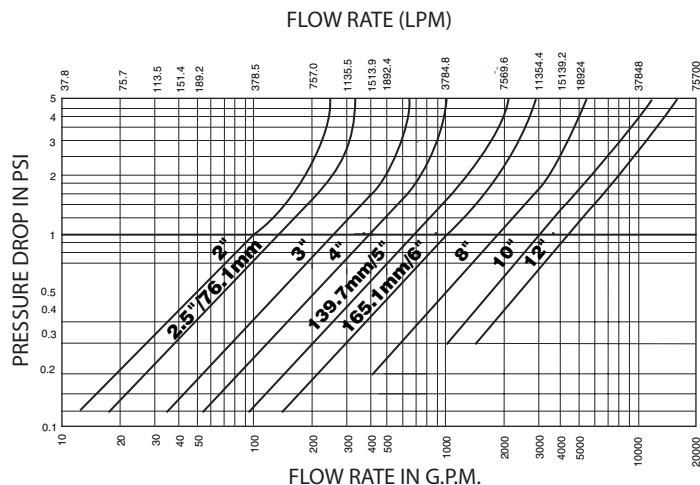

Note: It is good piping practice to apply a safety factor of 15% to 20% to the values in the above table.

TRIPLE DUTY VALVES

Model TD830 Triple Duty Valve

The Model TD830 Triple Duty Valve is designed for installation in pump discharge piping where it functions as a spring loaded silent check valve, flow control valve and shut-off valve.

The Model TD830 Triple Duty Valve operates automatically and silently. Line pressure of approximately 1/4 PSI will open the disc. The spring closes the disc as the line flow approaches zero in order to prevent flow reversal and water hammer. The flow through the valve can be adjusted from bubble tight shut-off to full flow by the acme threaded rising stem.

The Model TD830 Triple Duty Valve can be installed quickly into grooved end piping systems with two Grinnell couplings. The externally guided disc has a soft seat to ensure a leak-tight seal. It lifts 1/3 inch for each inch of pipe diameter. The rising stem design incorporates a graduated position indicator to ensure accurate disc positioning for throttling service. The yoke and valve stem are unwetted external parts so they cannot be corroded or eroded by the line fluid. All mating threaded parts are made of dissimilar, non-galling metals. An NPT drain plug is provided, as well as bosses for gauge taps at the inlet and outlet.

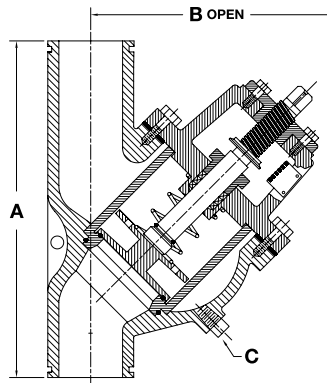

Tech Data: G390

Nominal Pipe Size		Nominal Dimensions			Approx. Weight Lbs. (kg)
ANSI Inches DN	O.D. Inches (mm)	A Inches (mm)	B Inches (mm)	C NPT	
2 DN50	2.375 (60.3)	9.375 (238.1)	9.625 (244.5)	1/2 (15)	23.0 (10.0)
2 1/2 DN65	2.875 (73.0)	10.250 (260.4)	9.625 (244.5)	1/2 (15)	24.0 (10.9)
3 DN80	3.500 (88.9)	11.250 (285.8)	10.125 (257.2)	1/2 (15)	33.0 (15.0)
4 DN100	4.500 (114.3)	15.625 (397.9)	11.125 (282.6)	1/2 (15)	84.0 (38.0)
5 DN125	5.563 (141.3)	15.625 (397.9)	11.125 (282.6)	1/2 (15)	84.0 (38.0)
6 DN150	6.625 (168.3)	19.625 (498.5)	17.500 (444.5)	3/4 (20)	156.0 (70.0)
8 DN200	8.625 (219.1)	23.625 (600.0)	18.000 (457.2)	3/4 (20)	300.0 (136.0)
10 DN250	10.750 (273.1)	28.000 (711.2)	19.875 (504.8)	1 (25)	392.0 (178.0)
12 DN300	12.750 (323.9)	31.625 (803.3)	25.000 (635.0)	1 (25)	496.0 (225.0)
14 DN340	14.000 (355.6)	33.500 (851.0)	25.000 (635.0)	1 (25)	790.0 (358.3)

MATERIAL SPECIFICATIONS

Body & Yoke Specifications

- Ductile iron conforming to ASTM A-536 or A-395

Seat Guide

- Bronze conforming to ASTM B-62, 85/5/5/5

Disc

- Cast Iron conforming to ASTM A-126-B

Spring

302 Stainless Steel

Stem

- Bronze conforming to ASTM B-21

Seat, Disc, and Stem O-Rings

EPDM

Seat

Bronze

Flanged Gland

- Cast Iron conforming to ASTM A-126-B

Cover Gasket and Packing

Non Asbestos

Stem Guide

- Ductile iron conforming to ASTM A-536 or A-395

Finish

- Black Paint

VALVES

Accessories



FOUNDED 1850

ACCESSORIES

"Y" STRAINER

Figure S853 "Y" Strainer

The Figure S853 "Y" Strainer is rated for 640 psi (44.1 Bar) at 100°F (38°C). The "Y" Strainer provides economical strainer protection for piping equipment such as pumps, meters, valves, compressors, traps and similar equipment. The inlet and outlet ends are suitable for installation with Figure 705, 707 and 772 couplings.

The Figure S853 "Y" Strainer perforated screen has the following standard perforations:

- Sizes 2" - 4" (50mm - 100mm) = 1/16" (1.6mm)
- Sizes 5" - 12" (125mm - 300mm) = 1/8" (3.2mm)

All covers have an NPT blowoff outlet (pipe plugs not included) and recessed seat in the cover to ensure screen alignment.

Self cleaning is done by opening the valve (not supplied) connected to the blowoff outlet. Advise when ordering strainers that are mounted in vertical piping so that the cover will be rotated to position the blowoff at the lowest point.



Tech Data: G420

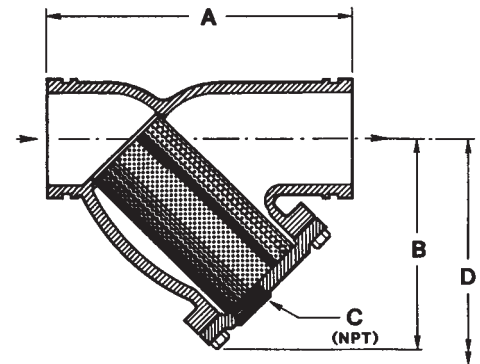

MATERIAL SPECIFICATIONS

Ductile Iron Body & Cover Specifications

- ASTM A-536 - Standard Specification for Ductile Iron Castings
- Grade 65-45-12
- Tensile Strength, minimum psi-65,000 (MPa-448)
- Yield Strength, minimum psi-45,000 (MPa-310)
- Elongation in 2" (50mm), minimum 12%

Screen Type 304 Stainless Steel ASTM A-240.
(Other alloys are available, contact Tyco Fire & Building Products).

Gasket Non-Asbestos

Coating Black Fusion Bonded Epoxy

PERFORMANCE

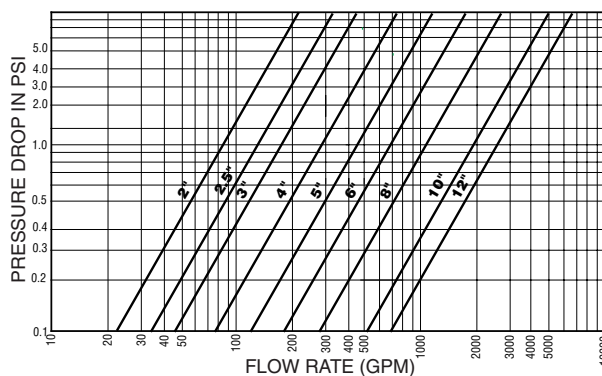

Note: It is good piping practice to apply a safety factor of 15% to 20% to the values in the above table.

Nominal Size	Nominal Dimensions					Approx. Weight
	Pipe OD	A	B	C*	D Screen Removal	
Inches	Inches	Inches	Inches	Inches	Inches	Lbs.
2	2.375	7.88	5.25	0.50	7.00	12.0
50	60.3	200.2	133.4	12.7	177.8	5.4
2½	2.875	10.00	6.50	1.00	9.75	18.0
65	73.0	254.0	165.1	25.4	247.7	8.2
3	3.500	10.13	7.00	1.00	10.00	23.0
80	88.9	257.3	177.8	25.4	254.0	10.4
4	4.500	12.13	8.25	1.50	12.00	42.0
100	114.3	308.1	209.6	38.1	304.8	19.1
5	5.563	15.63	11.25	2.00	17.00	80.0
125	141.3	397.0	285.8	50.8	431.8	36.3
6	6.625	18.50	13.50	2.00	20.00	112.0
150	168.3	469.9	342.9	50.8	508.0	50.8
8	8.625	21.63	15.50	2.00	22.75	205.0
200	219.1	549.4	393.7	50.8	577.9	93.0
10	10.750	29.13	21.00	2.00	30.50	277.0
250	273.1	739.8	533.4	50.8	774.7	125.6
12	12.750	33.75	25.00	2.00	35.50	470.0
300	323.9	857.3	635.0	50.8	901.7	213.2

* Blowoff outlet threads conforming to ISO 7-1 are available upon request. Contact Tyco Fire & Building Products.

Please refer to General Notes on page 14.

TEE STRAINER

Figure S855 Tee Strainer

The Figure S855 Tee Strainer is rated for the following pressures:

- Sizes 2" - 5", 750 psi (51.7 Bar) at 100°F (38°C)
- Size 6", 700 psi (48.2 Bar) at 100°F (38°C)
- Size 8", 600 psi (41.4 Bar) at 100°F (38°C)
- Size 10", 500 psi (34.5 Bar) at 100°F (38°C)
- Size 12", 400 psi (27.6 Bar) at 100°F (38°C)

The Tee Strainer is designed to remove particles from pipelines where a compact, accessible strainer is needed for the protection of pumps, meters, valves and similar mechanical equipment. The inlet and outlet ends are suitable for installation with Figure 705, 707 and 772 couplings that provide quick and easy installation. The cover and its gasket are secured by a compression coupling for easy access to the screen.

The Figure S855 Tee Strainer perforated screen has the following standard perforations:

- Sizes 2" - 6" (50mm - 150mm) = 1/8" (3.2mm)
- Sizes 8" - 12" (200mm - 300mm) = 5/32" (4.0mm)

Other perforation sizes are available upon request. Particle retention size should be specified when ordering nonstandard screens.

MATERIAL SPECIFICATIONS

Ductile Iron Body, Cover & Coupling Disc Specifications

- ASTM A-536 - Standard Specification for Ductile Iron Castings
- Grade 65-45-12
- Tensile Strength, minimum psi-65,000 (MPa-448)
- Yield Strength, minimum psi-45,000 (MPa-310)
- Elongation in 2" (50mm), minimum 12%

Screen

- 20 Gauge Type 304 Stainless Steel ASTM A-240 for sizes 2" - 6"
- 18 Gauge Type 304 Stainless Steel ASTM A-240 for sizes 8" - 12"

Coating Black Fusion Bonded Epoxy

PERFORMANCE

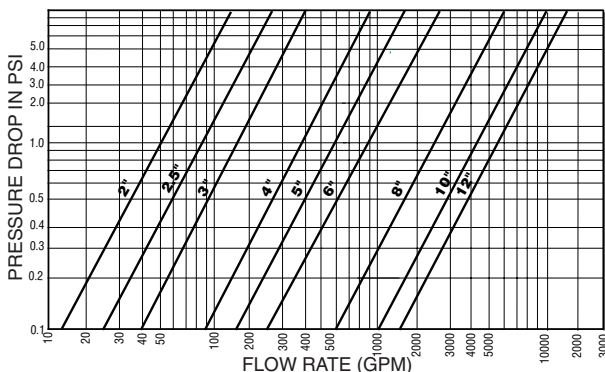

Note: It is good piping practice to apply a safety factor of 15% to 20% to the values in the above table.



Tech Data: G430

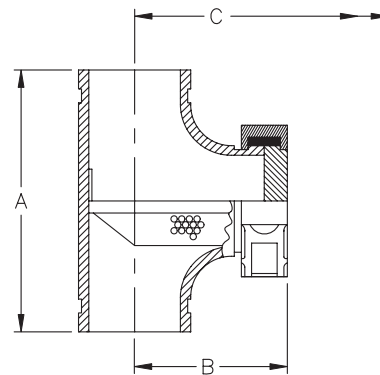

Nominal Size	Nominal Dimensions				Approx. Weight
	Pipe OD	A	B	C	
Inches mm	Inches mm	Inches mm	Inches mm	Screen Removal Inches mm	Lbs. Kg
2 50	2.375 60.3	6.50 165.0	4.25 108.0	7.50 191.0	6.0 2.7
2½ 65	2.875 73.0	7.50 191.0	4.75 110.0	8.75 222.0	11.0 5.0
3 80	3.500 88.9	8.50 216.0	5.25 133.0	10.00 254.0	12.0 5.4
4 100	4.500 114.3	10.00 254.0	6.13 156.0	12.00 305.0	20.0 9.0
5 125	5.563 141.3	11.00 279.0	6.63 168.0	13.50 342.0	30.0 13.0
6 150	6.625 168.3	13.00 330.0	7.63 194.0	16.00 406.0	40.0 18.0
8 200	8.625 219.1	15.50 394.0	9.13 232.0	19.44 494.0	81.0 36.0
10 250	10.750 273.0	18.00 457.0	10.38 264.0	22.94 583.0	126.0 57.0
12 300	12.750 323.9	20.00 508.0	11.38 289.0	25.94 659.0	174.0 79.0

Please refer to General Notes on page 14.

ACCESSORIES

SUCTION DIFFUSER

Figure S810 Suction Diffuser

The Figure S810 Suction Diffuser is compact and rugged for direct mounting to the suction side of a pump in either a horizontal or vertical position. In addition to removing foreign particles, the Figure S810 also provides proper flow conditions to the pump. Where space is limited, the Figure S810 can be used to replace the straight pipe normally required to reduce turbulence. The Figure S810 Suction Diffuser can be used for primary or additional strainer protection, especially for controls, meters and other rotating equipment. The Figure S810 Suction Diffuser's permanent perforated stainless steel screen helps remove foreign particles. The inlet end is suitable for installation with Figure 705, 707 and 772 couplings. The outlet end is provided with a 150# ANSI flat face flange. The large 5 to 1 open area ratio and the blow-off mean minimum servicing with easy draining and flushing.



Tech Data: G410

Sizes: 3", 4", 5", 6", 8", 10", 12", 14" and 16"

Maximum working pressure is 300 psi (20.7 bar) at 100°F (38°C)

MATERIAL SPECIFICATIONS

Body and Cover

Ductile Iron conforming to ASTM A-536

Knobs

Ductile Iron conforming to ASTM A-536
Grade 65-45-12 for sizes 3" x 2" – 10" x 8"
(Stud/Nuts Carbon Steel conforming to ASTM
A-193/194, for sizes 10" x 10" and larger)

Screen

$\frac{5}{32}$ " perforated Stainless Steel for sizes
3" x 2" – 6" x 6"; $\frac{1}{8}$ " perforated Stainless Steel
for sizes 8" x 5" and larger. Start up screen is 20
mesh Stainless Steel.

Coating

Black Fusion Bonded Epoxy

PERFORMANCE

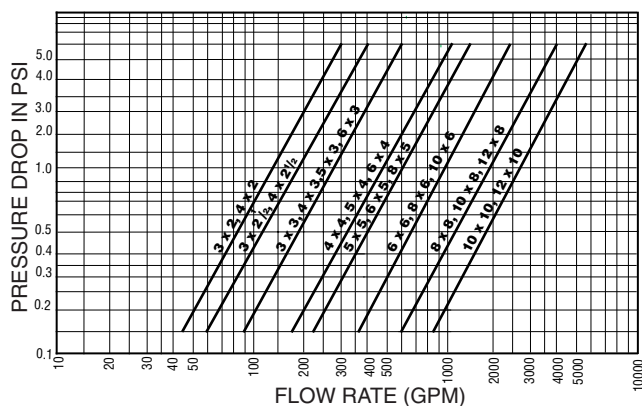

For sizes not shown, contact Tyco Fire & Building Products

Note: It is good piping practice to apply a safety factor of 15% to 20% to the values in the above table.

SUCTION DIFFUSER

Figure S810 Suction Diffuser

Nominal Dimensions									Approx. Weight Lbs. Kg.
Pipe Size Inlet x Outlet <i>Inches</i>	A Inches <i>mm</i>	B Inches <i>mm</i>	C Inches <i>mm</i>	D Inches <i>mm</i>	E Inches <i>mm</i>	F Screen Removal Inches <i>mm</i>	G Plug <i>NPT</i>	H Pipe Support ID Inches <i>mm</i>	
3 x 2 80 x 50	5.50 139.7	5.50 139.7	8.48 215.4	7.38 187.5	11.56 293.6	9.63 244.6	0.75	1.38 35.1	38.0 17.2
3 x 2½ 80 x 65	5.50 139.7	5.50 139.7	8.48 215.4	7.38 187.5	11.56 293.6	9.63 244.6	0.75	1.38 35.1	39.0 17.7
3 x 3 80 x 80	5.50 139.7	5.50 139.7	8.48 215.4	7.38 187.5	11.56 293.6	9.63 244.6	0.75	1.38 35.1	40.0 18.1
4 x 2 100 x 50	5.75 146.1	5.75 146.1	9.13 231.9	7.63 193.8	11.81 300.0	11.18 284.0	0.75	1.38 35.1	48.0 21.8
4 x 2½ 100 x 65	6.50 165.1	6.50 165.1	10.48 266.2	8.75 222.3	13.13 333.5	9.63 244.6	1.00	1.38 35.1	49.0 22.2
4 x 3 100 x 80	6.50 165.1	6.50 165.1	10.48 266.2	8.75 222.3	13.13 333.5	9.63 244.6	1.00	1.38 35.1	50.0 22.7
4 x 4 100 x 100	6.50 165.1	6.50 165.1	10.48 266.2	8.75 222.3	13.13 333.5	9.63 244.6	1.00	1.38 35.1	52.0 23.6
5 x 3 125 x 80	6.50 165.1	6.50 165.1	10.48 266.2	8.75 222.3	13.13 333.5	11.50 292.1	1.00	1.38 35.1	94.0 42.6
5 x 4 125 x 100	6.50 165.1	6.50 165.1	11.94 303.3	10.00 254.0	15.75 400.1	14.00 355.6	1.00	1.38 35.1	96.0 43.5
5 x 5 125 x 125	7.50 190.5	7.50 190.5	11.94 303.3	10.00 254.0	15.75 400.1	14.88 378.0	1.00	1.38 35.1	101.0 45.8
6 x 3 150 x 80	8.00 203.2	8.00 203.2	13.31 338.1	10.50 266.7	16.88 428.8	16.56 420.6	1.00	1.38 35.1	103.0 46.7
6 x 4 150 x 100	8.00 203.2	8.00 203.2	13.31 338.1	10.50 266.7	16.88 428.8	16.56 420.6	1.00	1.38 35.1	106.0 48.1
6 x 5 150 x 125	8.00 203.2	8.00 203.2	13.31 338.1	10.50 266.7	16.88 428.8	16.56 420.6	1.00	1.38 35.1	110.0 49.9
6 x 6 150 x 150	8.00 203.2	8.00 203.2	13.31 338.1	10.50 266.7	16.88 428.8	16.56 420.6	1.00	1.38 35.1	113.0 51.2
8 x 5 200 x 125	9.00 228.6	9.00 228.6	14.38 365.3	11.50 292.1	17.88 454.2	16.88 428.8	1.00	1.38 35.1	135.0 61.2
8 x 6 200 x 150	9.00 228.6	9.00 228.6	15.31 388.9	11.50 292.1	17.88 454.2	16.88 428.8	1.00	1.38 35.1	137.0 62.1
8 x 8 200 x 200	9.00 228.6	9.00 228.6	16.75 425.5	11.75 298.5	20.75 527.1	22.88 581.2	1.25	1.38 35.1	222.0 100.7
10 x 6 250 x 150	9.48 240.8	9.48 240.8	15.50 393.7	11.94 303.3	18.31 465.1	16.88 428.8	1.00	1.38 35.1	230.0 104.3
10 x 8 250 x 200	9.00 228.6	9.00 228.6	18.44 468.4	11.75 298.5	20.75 527.1	22.88 581.2	1.25	1.38 35.1	236.0 107.0
10 x 10 250 x 250	11.00 279.4	11.00 279.4	20.00 508.0	14.00 355.6	26.38 670.1	30.75 781.1	1.25	1.38 35.1	343.0 155.6
12 x 8 300 x 200	9.00 228.6	9.00 228.6	19.63 498.6	11.75 298.5	20.75 527.1	22.88 581.2	1.25	1.38 35.1	357.0 161.9
12 x 10 300 x 250	11.00 279.4	12.75 323.9	21.00 533.4	14.00 355.6	26.38 670.1	30.75 781.1	1.25	1.38 35.1	357.0 161.9
12 x 12 300 x 300	12.00 304.8	12.00 304.8	22.06 560.3	15.25 387.4	26.18 665.0	30.75 781.1	1.25	1.38 35.1	357.0 161.9
14 x 10 350 x 250	11.00 279.4	11.00 279.4	22.50 571.5	14.00 355.6	26.38 670.1	30.75 781.1	1.25	1.38 35.1	507.0 229.9
14 x 12 350 x 300	12.00 304.8	12.00 304.8	22.38 568.5	15.25 387.4	26.18 665.0	31.00 787.4	1.25	1.38 35.1	601.0 272.6
14 x 14 350 x 350	14.00 355.6	14.00 355.6	25.00 635.0	17.50 444.5	27.75 704.9	33.13 841.5	2.00	1.38 35.1	706.0 320.2
16 x 14 400 x 350	14.00 355.6	14.00 355.6	26.00 660.4	17.50 444.5	27.88 708.2	31.00 787.4	2.00	1.38 35.1	750.0 340.1

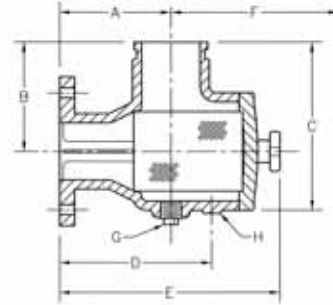

ACCESSORIES

BALANCING VALVES

Each Grinnell® Model CB800 Balancing Valve, as manufactured by Mepco, offers the specifier, installer and owner the features necessary to achieve accurate and efficient balancing of hydronic heating or cooling systems.

Common features include:

- Location of handwheel and test points on the same side for easy access
- Location of test points on one end for even easier access
- Easy to reorient digital/vernier handwheel
- Self-sealing pressure/temperature test points use standard insertion probes to eliminate additional components
- One valve for five functions
 - throttling
 - measuring (pressure & temp.)
 - draining
 - filling
 - positive shutoff
- Optional hose connection with ball valve for either test point (drain the pipe you want regardless of whether the valve is in the supply or return piping)
- Low minimum pressure drop (Y-pattern)
- Precise throttling (globe style)

- Minimum of 70 unique handwheel positions
- Install valve in the supply or return line - with flow in direction of arrow cast in body
- Install horizontally or vertically
- Install with handwheel up, down or on the side
- Rated for 235 psi (PN16) at 300°F (150°C)
- Dezincification resistant brass and bronze components
- Built-in hidden memory stop ensures return to balanced position after shutoff
- Enclosed red handwheel lock cap prevents handwheel movement - easily defeated for authorized valve repositioning
- Thread and sweat connections for 1/2" - 2" sizes
- 125# flanges on 2 1/2" - 12" sizes
- Groove connections for 2 1/2" - 12" sizes

Tech Data: G450

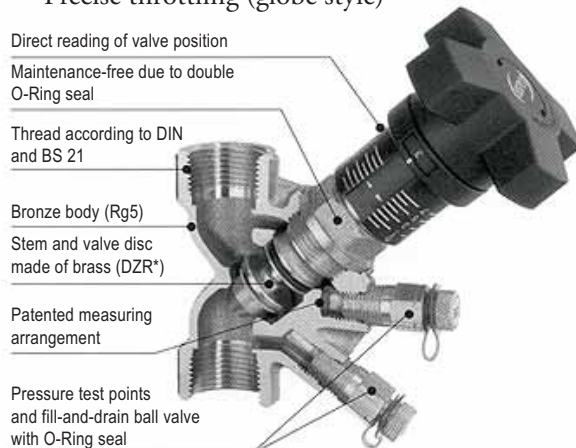

* DZR = de-zincification resistant brass

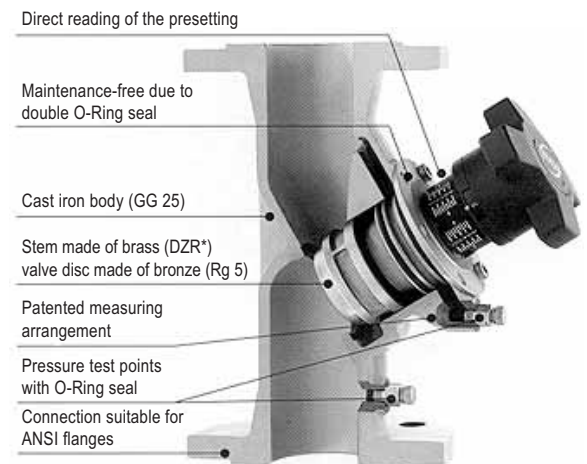

* DZR = de-zincification resistant brass

MATERIAL SPECIFICATIONS

- Sizes 1/2" (DN15) through 2" (DN50), solder or NPT threaded connection - body is bronze
- Sizes 2 1/2" (DN16) through 12" (DN300), grooved or flanged connection is to #125 standards - body is cast iron equivalent to ASME/ANSI B16.5
- All wetted brass parts are alloyed to resist dezincification.
- Dielectric fittings are not required for installation.

VALVE SIZING

All balancing valves are sized to perform in a normal operation range between 25% and 100% of the full open position, at a minimum differential pressure between 1 to 3 ft. water.

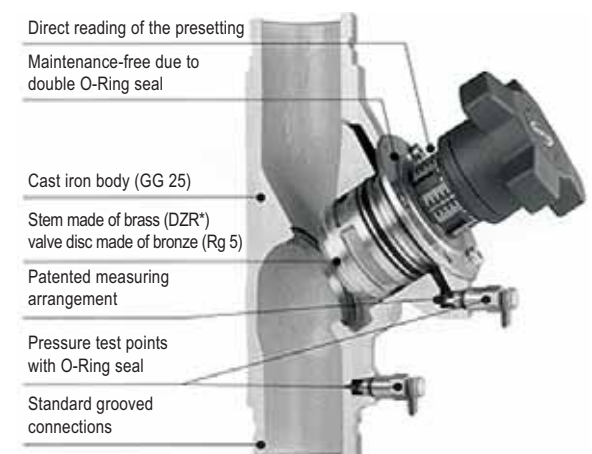

* DZR = de-zincification resistant brass

BALANCING VALVES

Model CB800

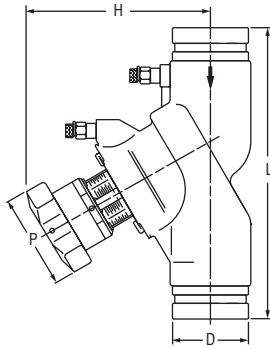

Size Inches	Connection	Nominal Dimensions			Approx. Weight Lbs. Kg.	Limits PSI / °F PN / °C	Hand- wheel Turns
		L Inches mm	H Inches mm	D Inches mm			
2½ 65	Groove	11 ⁷ / ₁₆ 290	2 ⁷ / ₈ 73.0	7 ³ / ₈ 188	18.7 8.5	235 / 300 16 / 150	8.0
3 80	Groove	12 ¹ / ₄ 310	3 ¹ / ₂ 88.9	8 203	27.5 12.5	235 / 300 16 / 150	8.0
4 100	Groove	13 ³ / ₄ 350	4 ¹⁵ / ₁₆ 114	9 ¹ / ₂ 240	45.1 20.5	235 / 300 16 / 150	8.0
5 125	Groove	15 ³ / ₄ 400	5 ⁹ / ₁₆ 141	11 ¹ / ₄ 283	70.4 32	235 / 300 16 / 150	8.0
6 150	Groove	18 ⁷ / ₈ 480	6 ⁵ / ₈ 168	11 ¹ / ₄ 285	95.7 43.5	235 / 300 16 / 150	8.0
8 200	Groove	23 ⁵ / ₈ 600	8 ⁵ / ₈ 219	18 ³ / ₈ 467	255.2 116	235 / 300 16 / 150	12.0
10 250	Groove	28 ³ / ₄ 730	10 ¹³ / ₁₆ 273	18 ¹⁵ / ₁₆ 480	376.2 171	235 / 300 16 / 150	12.0
12 300	Groove	33 ⁷ / ₁₆ 850	12 ³ / ₄ 324	20 ¹ / ₄ 515	519.2 136	235 / 300 16 / 150	12.0

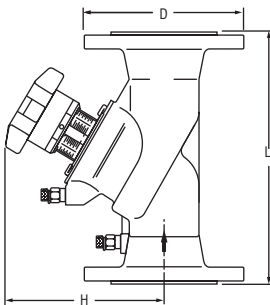

Size Inches	Connection	Nominal Dimensions			Approx. Weight Lbs. Kg.	Limits PSI / °F PN / °C	Hand- wheel Turns
		L Inches mm	H Inches mm	D Inches mm			
2½ 65	125# Flange	11 ⁷ / ₁₆ 290	7 ³ / ₈ 188	7 ¹ / ₄ 185	29.7 13.5	235 / 300 16 / 150	8.0
3 80	125# Flange	12 ¹ / ₄ 310	8 203	7 ⁷ / ₈ 200	39.6 18.0	235 / 300 16 / 150	8.0
4 100	125# Flange	13 ³ / ₄ 350	9 ¹ / ₈ 232	8 ¹¹ / ₁₆ 220	61.6 28	235 / 300 16 / 150	8.0
5 125	125# Flange	15 ³ / ₄ 400	10 ⁷ / ₈ 275	9 ⁷ / ₈ 250	89.1 40.5	235 / 300 16 / 150	8.0
6 150	125# Flange	18 ⁷ / ₈ 480	10 ⁷ / ₈ 277	11 ¹ / ₄ 285	113.3 51.5	235 / 300 16 / 150	8.0
8 200	125# Flange	23 ⁵ / ₈ 600	18 ³ / ₈ 467	13 ³ / ₈ 340	284.9 129.5	235 / 300 16 / 150	12.0
10 250	125# Flange	28 ³ / ₄ 730	18 ¹⁵ / ₁₆ 481	15 ¹⁵ / ₁₆ 405	431.2 196.0	235 / 300 16 / 150	12.0
12 300	125# Flange	33 ⁷ / ₁₆ 850	20 ¹ / ₄ 515	19 ¹ / ₁₆ 485	580.8 264	235 / 300 16 / 150	12.0

ACCESSORIES

BALANCING VALVES

Model CB800

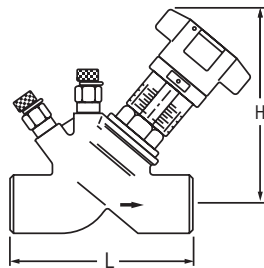
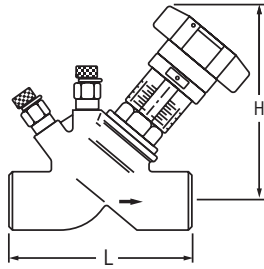

Size Inches	Connection	Nominal Dimen.		Approx. Weight Lbs. Kg.	Limits PSI / °F PN / °C	Hand- wheel Turns
		L Inches mm	H Inches mm			
1/2 15	Female NPT	3 1/8 80	4 1/4 114	1.37 0.62	235 / 300 16 / 150	7.0
3/4 20	Female NPT	3 5/16 84	4 9/16 115	1.44 0.65	235 / 300 16 / 150	7.0
1 25	Female NPT	3 3/8 97.5	4 11/16 119	2.20 1.00	235 / 300 16 / 150	7.0
1 1/4 32	Female NPT	4 3/8 110	5 3/8 136	3.00 1.36	235 / 300 16 / 150	10.0
1 1/2 40	Female NPT	4 3/4 120	5 7/16 138	3.86 1.75	235 / 300 16 / 150	10.0
2 50	Female NPT	5 5/16 150	5 13/16 148	5.64 2.56	235 / 300 16 / 150	10.0
1/2 15	Female Sweat	3 1/8 80	4 1/4 114	1.37 0.62	235 / 300 16 / 150	7.0
3/4 20	Female Sweat	3 5/16 84	4 9/16 115	1.44 0.65	235 / 300 16 / 150	7.0
1 25	Female Sweat	3 3/8 97.5	4 11/16 119	2.20 1.00	235 / 300 16 / 150	7.0
1 1/4 32	Female Sweat	4 3/8 110	5 3/8 136	3.00 1.36	235 / 300 16 / 150	10.0
1 1/2 40	Female Sweat	4 3/4 120	5 7/16 138	3.86 1.75	235 / 300 16 / 150	10.0
2 50	Female Sweat	5 5/16 150	5 13/16 148	5.64 2.56	235 / 300 16 / 150	10.0

Valve Sizing & Selection Guide

When maximum flow is known but a pressure drop through the balancing valve is unknown, select a balancing valve for a maximum pressure drop of 2 ft. water (5.7 kPa) in the full open position as shown in the table below:

Flow		Size		Connection
GPM	(l/h)	Inches	(DN)	Sw-tlhrd / Flng grv
0.5 - 4.1	(100 - 1000)	1/2	(15)	sweat thread
4.1 - 6.0	(1.0k - 1.5k)	3/4	(20)	sweat thread
6.1 - 9.2	(1.5k - 2.3k)	1	(25)	sweat thread
9.2 - 20	(2.3k - 5.0k)	1 1/4	(32)	sweat thread
20 - 29	(5.0k - 7.2k)	1 1/2	(40)	sweat thread
29 - 40	(7.2k - 10k)	2	(50)	sweat thread
40 - 102	(10k - 25k)	2 1/2	(65)	flanged grooved
102 - 125	(25k - 31k)	3	(80)	flanged grooved
125 - 210	(31k - 50k)	4	(100)	flanged grooved
210 - 300	(50k - 76k)	5	(125)	flanged grooved
300 - 430	(76k - 108k)	6	(150)	flanged grooved
430 - 760	(108k - 190k)	8	(200)	flanged grooved
760 - 1350	(190k - 340k)	10	(250)	flanged grooved
1350 - 1500	(340k - 377k)	12	(300)	flanged grooved

Valve Installation Guide

Accurate flow measurement requires that the velocity distribution near the balancing valve stays constant, regardless of the total flow through the pipe. Fittings, such as elbows and tees, disturb the normal flow profile which is established through straight pipe. Pumps create even greater disturbances. Failure to allow water flows around fittings and pumps to normalize can affect measuring accuracy by as much as 20% when the valve is in the worst, fully open, position. Minimum lengths (diameters, D) of straight pipe before and after the balancing valve prevent these errors. Follow the flow direction arrow on the valve body for best accuracy. Valves are designed for vertical, horizontal or inclined installation.

Minimum Pipe Diameters from Fittings

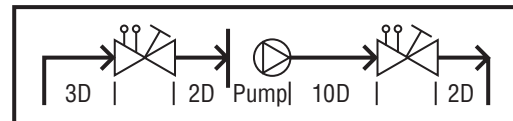

Copper Grooved System

COPPER GROOVED SYSTEM

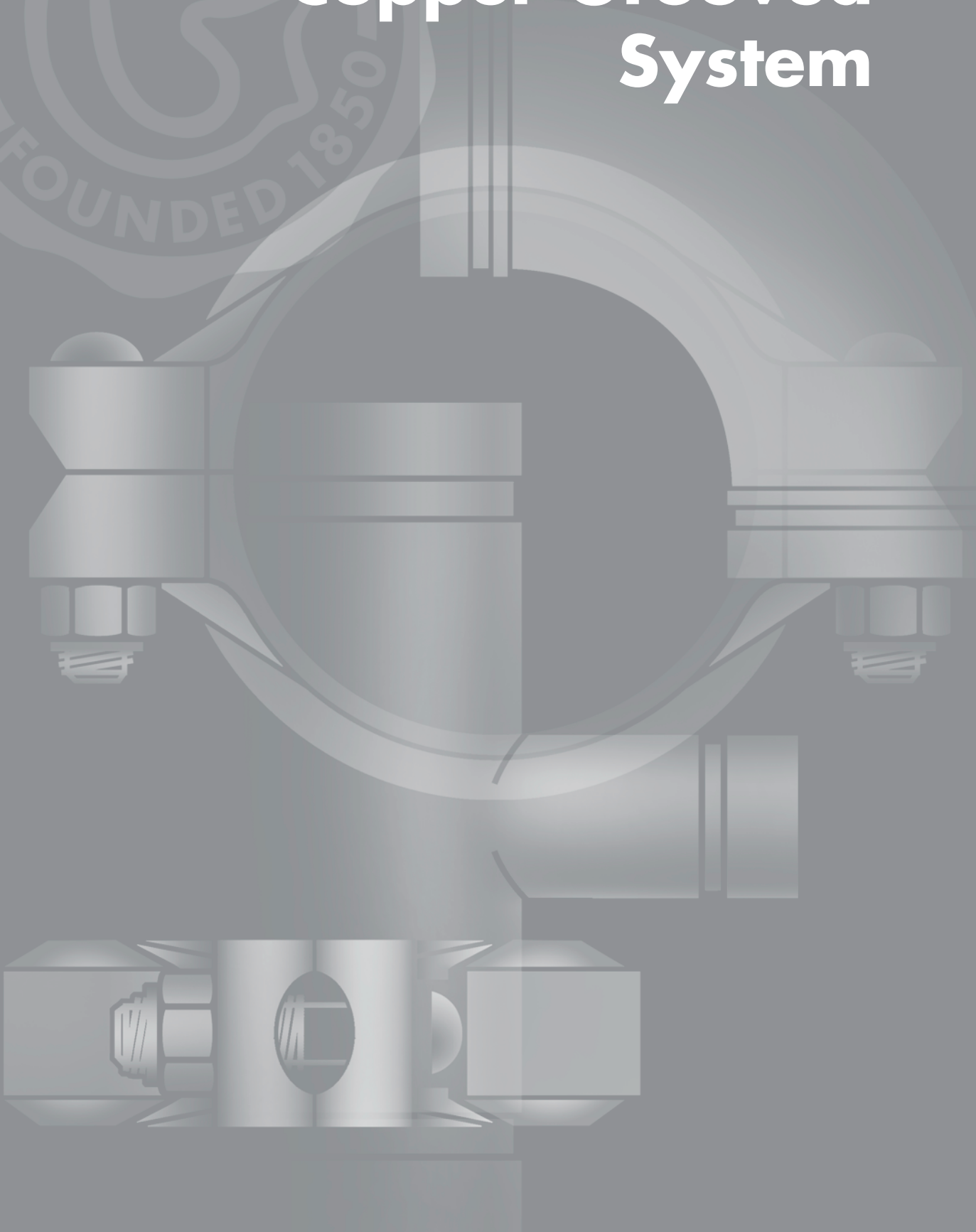

COUPLINGS - COPPER SYSTEM

Grinnell® Copper Grooved System is designed for joining copper tube size components 2" to 8" (54,0mm to 206,4mm) type K, L, M and DWV. All couplings and fittings are rated for working pressures up to 300 psi depending on copper tubing size and type (see pressure rating chart).

The Figure 672 coupling is patented and incorporates a design that allows the coupling housings to grip along the full 360° of circumference of the copper tube. This results in a more rigid and stronger connection.

The Figure 61 flange adapter allows a direct transition from flanged components to the grooved copper components.

MATERIAL SPECIFICATIONS

The applicable material specifications for ductile iron and rubber gaskets apply:

Ductile Iron Housing Specifications

- ASTM A-536 - Standard Specification for Ductile Iron Castings Grade 65-45-12

Gasket Specifications

Tri-Seal Grade "EN" EPDM, NSF 61 approved compound, has a copper color code, for cold +86°F (+30°C) and hot +180°F (+82°C) potable water. Not recommended for petroleum service.

Bolt / Nut Specifications

Carbon steel oval neck bolts and nuts are heat treated and conform to the physical properties of ASTM A-183 with a minimum tensile strength of 110,000psi (758,422 kPa). Bolts and nuts are Zinc electroplated to ASTM B633.

Coatings

- Copper - Acrylic Enamel

Performance Pressure Ratings:

Nominal Size	Type "K" ASTM B-88			Type "L" ASTM B-88			Type "M" ASTM B-88			DWV ASTM B-306		
	Wall Thick. Inch. mm	Max. Work. Press. PSI/kPa	Max. End Load Lbs./kN	Wall Thick. Inch. mm	Max. Work. Press. PSI/kPa	Max. End Load Lbs./kN	Wall Thick. Inch. mm	Max. Work. Press. PSI/kPa	Max. End Load Lbs./kN	Wall Thick. Inch. mm	Max. Work. Press. PSI/kPa	Max. End Load Lbs./kN
2 54	0.083 2,1	300 2065	1.065 4,74	0.070 1,8	300 2065	1.065 4,74	0.058 1,5	250 1725	890 3,96	0.042 1,1	-	-
2½ 67	0.095 2,4	300 2065	1.625 7,23	0.080 2,0	300 2065	1.625 7,23	0.065 1,7	250 1725	1.350 6,01	-	-	-
3 79	0.109 2,8	300 2065	2.300 10,23	0.090 2,3	300 2065	2.300 10,23	0.072 1,8	250 1725	1.415 6,30	0.045 1,1	100 690	765 3,40
4 105	0.134 3,4	300 2065	4.005 17,82	0.110 2,8	300 2065	4.005 17,82	0.095 2,4	250 1725	3.340 14,86	0.058 1,5	100 690	1.335 5,94
5 130	0.160 4,1	300 2065	6.190 27,55	0.125 3,2	300 2065	6.190 27,55	0.109 2,8	200 1375	4.125 18,36	0.072 1,8	100 690	2.060 9,17
6 156	0.192 4,9	300 2065	8.840 39,34	0.140 3,6	300 2065	8.840 39,34	0.122 3,1	200 1375	5.890 26,21	0.083 2,1	100 690	2.945 13,10
8 206	0.271 6,9	300 2065	15.550 69,2	0.200 5,1	300 2065	15.550 69,20	0.170 4,3	200 1375	10.370 46,10	0.109 2,8	100 690	5.180 23,0

COPPER
GROOVED
SYSTEM

COUPLINGS

Figure 672 Rigid Coupling - Patented

The Figure 672 Rigid Coupling, size range 2" to 8" (54,0 mm to 206,4 mm) is capable of pressures up to 300 psig (2065 kPa) depending on copper tubing size and type. It provides a rigid joint by firmly gripping along the circumference of the copper tube grooves.

Figure 672 Rigid Couplings are a proven dependable method of joining copper tubing and are an economical alternative to soldering (sweating) joints and can be used on type K, L, M, DWV copper tube.



Tech Data: G510

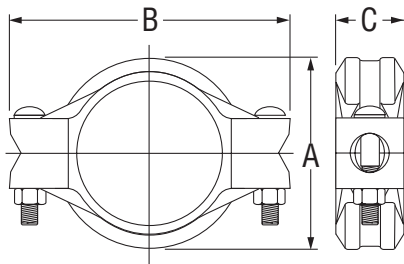

See Tyco Fire &
Building Products
Publication TFP1800

Nominal Size	Copper Tubing OD	Max.* Gap	Nominal Dimensions			Coupling Bolts		Approx. Weight
			A	B	C	Qty	Size	
Inches <i>mm</i>	Inches <i>mm</i>	Inches <i>mm</i>	Inches <i>mm</i>	Inches <i>mm</i>	Inches <i>mm</i>		Inches	Lbs. <i>Kg</i>
2 54	2.125 54,0	0.06 1,5	3.09 78,6	4.65 118,1	1.72 43,7	2	$\frac{3}{8} \times 2\frac{1}{4}$	2.1 0,9
2½ 67	2.625 66,7	0.06 1,5	3.59 91,3	5.38 136,7	1.72 43,7	2	$\frac{3}{8} \times 2\frac{1}{4}$	2.3 1,1
3 79	3.125 79,4	0.06 1,5	4.12 104,7	6.25 158,8	1.72 43,7	2	$\frac{1}{2} \times 3$	2.9 1,3
4 105	4.125 104,8	0.09 2,3	5.33 135,3	7.75 196,9	1.86 47,2	2	$\frac{1}{2} \times 3$	3.9 1,8
5 130	5.125 130,7	0.09 2,3	6.48 164,6	9.25 235,0	1.86 47,2	2	$\frac{5}{8} \times 3\frac{1}{4}$	6.0 2,7
6 156	6.125 155,6	0.09 2,3	7.25 184,1	10.25 260,4	1.86 47,2	2	$\frac{5}{8} \times 3\frac{1}{4}$	6.7 3,0
8 206	8.125 206,4	0.09 2,3	9.64 244,8	12.75 323,9	1.86 47,2	2	$\frac{3}{4} \times 4\frac{3}{4}$	10.5 4,8

* Maximum available gap between pipe ends. Minimum gap = 0.

COPPER
GROOVED
SYSTEM

FLANGES

Figure 61 Flange Adapter (ANSI Class 125/150)

The Figure 61 Flange Adapter is capable of pressures up to 300 psig (20,7 Bar) depending on copper tubing size and type. It provides a direct transition from flanged components to a grooved copper tube system. I.P.S. size flange bolt patterns conform to ANSI Class 125 and 150.

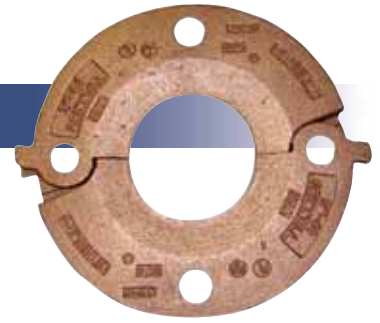

Tech Data: G515

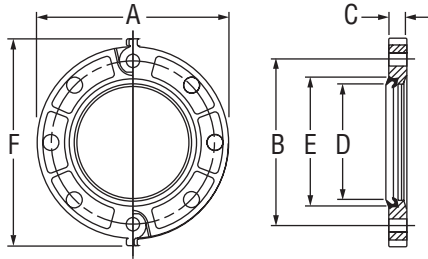

Certified to
NSF/ANSI 61



See Tyco Fire &
Building Products
Publication TFP1800

Nominal Size	Copper Tubing OD	Nominal Dimensions						Bolts**		Approx Weight
		A	B	C	D*	E*	F	Qty	Size	
Inches mm	Inches mm	Inches mm	Inches mm	Inches mm	Inches mm	Inches mm	Inches mm		Inches	Lbs. Kg
2 54	2.125 54,0	6.38 162,1	4.75 120,7	0.75 19,1	2.13 54,0	3.41 86,6	7.25 184,2	4	5/8 x 3	4.1 1,9
2 1/2 67	2.625 66,7	7.00 178,0	5.50 140,0	0.88 22,0	2.63 67,0	3.91 99,0	7.88 200,0	4	5/8 x 3	5.7 2,6
3 79	3.125 79,4	7.50 190,5	6.00 152,4	0.94 23,9	3.13 80,0	4.53 115,1	9.88 251,0	4	5/8 x 3	6.7 3,0
4 105	4.125 104,8	9.00 228,6	7.50 190,5	0.94 23,9	4.13 105,0	5.53 140,5	9.90 251,5	8	5/8 x 3	8.5 3,9
5 130	5.125 130,2	10.00 254,0	8.50 215,9	1.00 25,4	5.13 130,0	6.72 170,7	11.38 289,1	8	3/4 x 3 1/2	10.3 4,7
6 156	6.125 155,6	11.00 279,4	9.50 241,3	1.00 25,4	6.13 156,0	7.78 197,6	11.88 301,8	8	3/4 x 3 1/2	11.5 5,2

* Dimensions D and E represent minimum and maximum sealing surfaces.

** Bolts are not supplied. Bolt lengths shown are standard; it is the responsibility of the purchaser to verify correct length for the intended application.

Note: Phenolic Type "F" flange washer adapters are required when the Figure 61 Flange Adapter is used against surfaces such as:

- Rubber surfaces
- Adapting to AWWA cast flanges
- Rubber faced wafer valves
- Serrated flange surfaces

Figure 61 Flange Adapters are not recommended for applications that incorporate tie rods for anchoring or on a standard fitting within 90° of each other.

COPPER
GROOVED
SYSTEM

FITTINGS - COPPER SYSTEM

Cast fittings in 90°, 45° elbow, tees, caps, concentric reducers, and reducing tees are cast with a copper Alloy conforming to CDA C89833. Cast fittings are stronger and more durable than wrought copper fittings and are less susceptible to damage in transit or during installation. Reducing fittings are available with Groove x Groove or Groove x Cup end configurations.

Fittings are standard radius, full flow, designed for installation with Grinnell® Copper System Figure 672 Couplings or Figure 61 Flange Adapters.

Fittings are rated at the pressure rating of the Figure 672 coupling or Figure 61 Flange being used.

Tech Data: G520



MATERIAL SPECIFICATIONS

Cast Copper Alloy Fittings

- Copper Alloy conforming to CDA C89833

Wrot Copper Fittings

- ASTM B-75 C12200; Wall thickness per ASTM B-88 Type L

COPPER
GROOVED
SYSTEM

FITTINGS

Figures 610, 601, 619 & 660

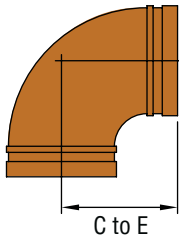

FIGURE 610
90° ELBOW

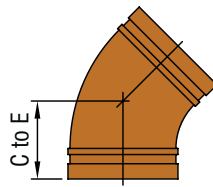

FIGURE 601
45° ELBOW

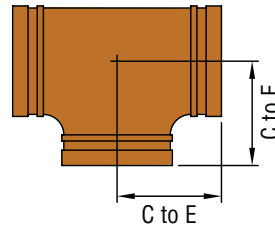

FIGURE 619
TEE

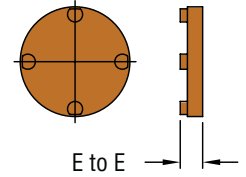

FIGURE 660
END CAP

Nominal Size	Copper Tube OD	Figure 610		Figure 601		Figure 619		Figure 660	
		Nominal C to E*	Approx. Weight	Nominal C to E*	Approx. Weight	Nominal C to E*	Approx. Weight	Nominal E to E*	Approx. Weight
Inches mm	Inches mm	Inches mm	Lbs. Kg.	Inches mm	Lbs. Kg.	Inches mm	Lbs. Kg.	Inches mm	Lbs. Kg.
2 54	2.125 54,0	2.91 73,9	1.95 0,9	2.19 55,6	1.6 0,7	2.69 68,3	2.5 1,13	.92 23,4	.7 ,3
2½ 67	2.625 66,7	3.31 84,1	2.65 1,2	2.31 58,7	2.1 1,0	3.20 81,3	3.0 1,36	.92 23,4	1.0 ,5
3 79	3.125 79,4	3.81 96,8	3.65 1,66	2.59 65,8	2.8 1,3	3.52 89,4	4.05 2,2	.92 23,4	1.4 ,6
4 105	4.125 104,8	4.75 120,7	7.0 3,18	3.19 81,0	5.7 2,6	4.25 108,0	9.15 4,15	.92 23,4	2.4 1,1
5 130	5.125 130,2	5.94 150,9	11.6 5,26	3.25 82,6	8.0 3,6	5.94 150,9	17.75 8,05	.92 23,4	4.2 1,9
6 156	6.125 155,6	6.94 176,7	16.62 7,54	3.5 88,9	10.5 4,8	6.94 176,3	24.4 11,07	.92 23,4	5.9 2,7
8 206	8.125 206,4	7.75 196,9	23.6 10,7	4.25 108,0	16.9 7,7	7.75 196,9	36.25 16,44	.92 23,4	10.2 4,6

* Dimensional information in this chart is for cast fittings.



See Tyco Fire &
Building Products
Publication TFP1800

COPPER
GROOVED
SYSTEM

FITTINGS

Figure 621 Reducing Tee

Nominal Size Inches	Copper Tube OD Inches mm	Nominal C to E Inches mm	Nominal C to RE Inches mm	Approx. Weight Lbs. Kg.
2 1/2 x 2 1/2 x 2 67 x 67 x 54	2.625 x 2.625 x 2.125 66.7 x 66.7 x 54.0	3.28 83.3	3.38 85.9	3.47 1.57
3 x 3 x 2 79 x 79 x 54	3.125 x 3.125 x 2.125 79.4 x 79.4 x 54.0	3.00 76.2	3.38 85.9	3.69 1.67
3 x 3 x 2 1/2 79 x 79 x 67	3.125 x 3.125 x 2.625 79.4 x 79.4 x 66.7	3.25 82.6	3.5 88.9	4.13 1.87
4 x 4 x 2 105 x 105 x 54	4.125 x 4.125 x 2.125 104.8 x 104.8 x 54.0	3.66 93.0	4.13 104.9	6.75 3.06
4 x 4 x 2 1/2 105 x 105 x 67	4.125 x 4.125 x 2.625 104.8 x 104.8 x 66.7	3.94 100.1	4.06 103.1	7.31 3.32
4 x 4 x 3 105 x 105 x 79	4.125 x 4.125 x 3.125 104.8 x 104.8 x 79.4	4.19 106.4	4.16 105.7	7.84 3.56
5 x 5 x 3 130 x 130 x 79	5.125 x 5.125 x 3.125 130.2 x 130.2 x 79.4	3.75 95.3	4.63 117.6	9.35 4.24
5 x 5 x 4 130 x 130 x 105	5.125 x 5.125 x 4.125 130.2 x 130.2 x 104.8	4.25 108.0	4.56 115.8	10.95 4.97
6 x 6 x 2 1/2 156 x 156 x 67	6.125 x 6.125 x 2.625 155.6 x 155.6 x 66.7	3.63 92.2	5.13 130.3	10.78 4.89
6 x 6 x 3 156 x 156 x 79	6.125 x 6.125 x 3.125 155.6 x 155.6 x 79.4	3.69 93.7	5.19 131.8	11.05 5.01
6 x 6 x 4 156 x 156 x 105	6.125 x 6.125 x 4.125 155.6 x 155.6 x 104.8	4.19 106.4	5.13 130.3	12.86 5.83
6 x 6 x 5 156 x 156 x 130	6.125 x 6.125 x 5.125 155.6 x 155.6 x 130.2	4.69 119.1	5.196 131.8	14.75 6.69

Dimensional information in this chart is for cast fittings.

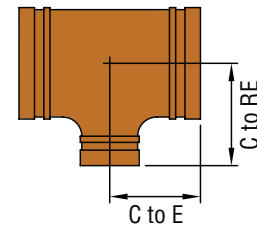

FIGURE 621 REDUCING TEE
CAST
GR x GR x GR

Figure 618 Reducing Tee

Nominal Size Inches mm	618 Groove x Groove x Cup, Wrot Copper			Approx. Weight Lbs. Kg.
	C to E Inches mm	C to RE Inches mm	Cup Inches mm	
2 x 2 x 3/4 54 x 54 x 20	3.25 82.5	3.68 93.5	0.75 19.1	1.1 0.5
2 x 2 x 1 54 x 54 x 25	3.25 82.5	3.62 91.9	0.91 23.1	1.1 0.5
2 x 2 x 1 1/4 54 x 54 x 32	3.25 82.5	3.68 93.5	0.97 24.6	1.2 0.5
2 x 2 x 1 1/2 54 x 54 x 40	3.25 82.5	3.56 90.4	1.09 27.7	1.2 0.5
2 1/2 x 2 1/2 x 3/4 67 x 67 x 20	3.75 95.2	3.93 99.8	0.75 19.1	1.7 0.8
2 1/2 x 2 1/2 x 1 67 x 67 x 25	3.75 95.2	3.87 98.3	0.91 23.1	1.7 0.8
2 1/2 x 2 1/2 x 1 1/4 67 x 67 x 32	3.75 95.2	3.93 99.8	0.97 24.6	1.8 0.8
2 1/2 x 2 1/2 x 1 1/2 67 x 67 x 40	3.75 95.2	3.81 96.8	1.09 27.7	1.8 0.8
3 x 3 x 3/4 79 x 79 x 20	4.25 108.0	4.18 106.2	0.75 19.1	2.5 1.1
3 x 3 x 1 79 x 79 x 25	4.25 108.0	4.12 104.6	0.91 23.1	2.5 1.1
3 x 3 x 1 1/4 79 x 79 x 32	4.25 108.0	4.18 106.2	0.97 24.6	2.6 1.2
3 x 3 x 1 1/2 79 x 79 x 40	4.25 108.0	4.06 103.1	1.09 27.7	2.7 1.2
4 x 4 x 3/4 105 x 105 x 20	5.00 127.0	5.18 131.6	0.75 19.1	4.6 2.1
4 x 4 x 1 105 x 105 x 25	5.00 127.0	5.12 130.0	0.91 23.1	4.7 2.1
4 x 4 x 1 1/4 105 x 105 x 32	5.00 127.0	5.18 131.6	0.97 24.6	4.8 2.2
4 x 4 x 1 1/2 105 x 105 x 40	5.00 127.0	5.06 128.5	1.09 27.7	4.9 2.2

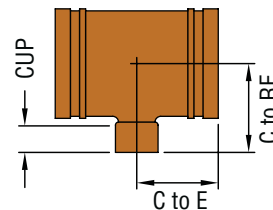

FIGURE 618 REDUCING TEE
WROT COPPER
GR x GR x CUP

COPPER
GROOVED
SYSTEM

Dimensional information in this chart is for wrot copper fittings.

FITTINGS

Figures 650 & 652 Concentric Reducer

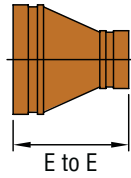

FIGURE 650 CONCENTRIC REDUCER
CAST
GR x GR

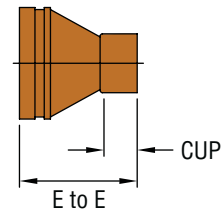

FIGURE 652 CONCENTRIC REDUCER
WROT COPPER
GR x CUP

Nominal Size Inches <i>mm</i>	650 Groove x Groove	
	E to E Inches <i>mm</i>	Approx. Weight Lbs. <i>Kg.</i>
2½ x 2 <i>67 x 54</i>	3.29 <i>83,6</i>	1.4 <i>0,6</i>
3 x 2 <i>79 x 54</i>	2.50 <i>63,5</i>	1.4 <i>0,6</i>
3 x 2½ <i>79 x 67</i>	2.50 <i>63,5</i>	1.4 <i>0,6</i>
4 x 2 <i>105 x 54</i>	4.75 <i>120,7</i>	3.2 <i>1,5</i>
4 x 2½ <i>105 x 67</i>	3.00 <i>76,2</i>	2.3 <i>1,1</i>
4 x 3 <i>105 x 79</i>	3.00 <i>76,2</i>	2.4 <i>1,1</i>
5 x 3 <i>130 x 79</i>	3.88 <i>98,6</i>	3.8 <i>1,7</i>
5 x 4 <i>130 x 105</i>	3.38 <i>85,9</i>	3.8 <i>1,7</i>
6 x 3 <i>156 x 79</i>	4.38 <i>111,3</i>	5.0 <i>2,3</i>
6 x 4 <i>156 x 105</i>	3.88 <i>98,6</i>	5.1 <i>2,3</i>
6 x 5 <i>156 x 130</i>	3.38 <i>85,9</i>	4.9 <i>2,2</i>
8 x 6 <i>206 x 156</i>	5.00 <i>127,0</i>	9.5 <i>4,3</i>

Dimensional information in this chart is for cast fittings.

Nominal Size Inches <i>mm</i>	652 Groove x Groove x Cup		
	E to E Inches <i>mm</i>	Cup Inches <i>mm</i>	Approx. Weight Lbs. <i>Kg.</i>
2 x 1 <i>54 x 29</i>	2.70 <i>68,6</i>	0.91 <i>23,1</i>	0.5 <i>0,2</i>
2 x 1¼ <i>54 x 35</i>	3.00 <i>76,2</i>	0.97 <i>24,6</i>	0.4 <i>0,2</i>
2 x 1½ <i>54 x 41</i>	2.94 <i>74,7</i>	1.09 <i>27,7</i>	0.4 <i>0,2</i>
2½ x 1 <i>67 x 29</i>	2.28 <i>57,9</i>	0.91 <i>23,1</i>	0.5 <i>0,2</i>
2½ x 1¼ <i>67 x 35</i>	3.52 <i>89,4</i>	0.97 <i>24,6</i>	0.6 <i>0,3</i>
2½ x 1½ <i>67 x 41</i>	3.45 <i>87,6</i>	1.09 <i>27,7</i>	0.6 <i>0,3</i>
2½ x 2 <i>67 x 54</i>	3.30 <i>83,8</i>	1.34 <i>34,0</i>	0.6 <i>0,3</i>
3 x 1½ <i>79 x 41</i>	2.59 <i>65,8</i>	1.09 <i>27,7</i>	0.7 <i>0,3</i>
3 x 2 <i>79 x 54</i>	4.10 <i>104,1</i>	1.34 <i>34,0</i>	1.0 <i>0,5</i>
4 x 2 <i>105 x 54</i>	3.41 <i>86,6</i>	1.34 <i>34,0</i>	1.4 <i>0,6</i>

Dimensional information in this chart is for wrot copper.

COPPER
GROOVED
SYSTEM

VALVES

Model B680 Copper System Grooved End Butterfly Valve with Lever Handle

The Model B680 is a lever handle bronze body butterfly valve designed for use with grooved copper tubing (CTS), fittings and couplings. The valve is rated to 300 psi (20 bar) and features a 10 position locking lever handle and EPDM encapsulated ductile iron disc.

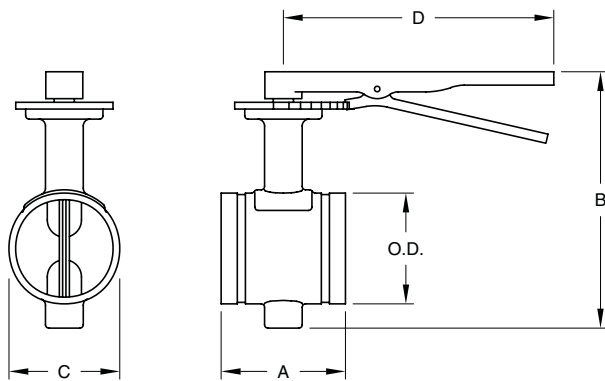

Tech Data: G530

MATERIAL SPECIFICATIONS

Body

- Cast bronze to ASTM B584-87 Copper Alloy UNS C90500

Disc

- Ductile Iron to ASTM A536 Gr. 65-45-12 encapsulated with EPDM

Upper & Lower Shafts

- Stainless Steel Type 416 of ASTM A582

Note: Bronze body and EPDM disc encapsulation compound conforms to ANSI / NSF 61 for cold +86°F (+30°C) and hot +180°F (+82°C) potable water systems.

Nominal Size	Pipe O.D.	Dimensions				Weight
		A	B	C	D	
2	2.125	3.19	5.31	2.45	10.0	4.9
50	54,0	81,0	135,0	57,0	254,0	2,2
2½	2.625	3.75	5.91	2.63	10.0	5.9
65	66,7	96,0	150,0	67,0	254,0	2,7
3	3.125	3.75	7.68	3.13	10.0	6.6
80	79,4	96,0	195,0	79,0	254,0	3,0
4	4.125	4.63	8.78	4.13	10.0	11.0
100	104,8	118,0	223,0	105,0	254,0	5,0
5	5.125	5.88	9.80	5.13	10.0	17.6
125	130,2	149,0	249,0	130,0	254,0	8,0
6	6.125	5.88	10.86	6.13	10.0	21.6
150	155,6	149,0	276,0	156,0	254,0	9,8

Notes: Pressure ratings listed are CWP (cold water pressure) or maximum working pressure within the service temperature range of the gasket used in the coupling.

Maximum working pressures and end loads listed are total of internal and external pressures and loads based on roll-grooved Type K – ASTM B-88 copper tubing.

COPPER
GROOVED
SYSTEM

FITTINGS

Figure 407GG Dielectric Waterway Transition Fitting

The Figure 407GG fitting protects systems through an innovative steel-to-plastic design that establishes a dielectric waterway. The transition fitting separates dissimilar metals in the electrolyte (waterway) eliminating the local galvanic cell.

The Figure 407GG transition fitting allows the connection between steel (IPS) size pipe and copper tube (CTS) size.

Nominal Size Inches <i>mm</i>	Outside Diameter		407GG Groove x Groove	
	Steel (IPS)	Copper (CTS)	Nominal End to End Inches <i>mm</i>	Approx. Weight Lbs. <i>Kg.</i>
	2 54	2.375 60,3	2.125 54,0	4.00 101,6
2½ 67	2.875 73,0	2.625 66,7	4.00 101,6	3.3 1,5
3 79	3.500 88,9	3.125 79,4	4.00 101,6	4.5 2,1
4 105	4.500 114,3	4.125 104,8	4.00 101,6	5.8 2,6
5 130	5.563 141,3	5.125 130,2	4.00 101,6	7.8 3,5
6 156	6.625 168,3	6.125 155,6	4.00 101,6	10.1 4,6
8 206	8.625 219,1	8.125 206,4	4.00 101,6	15.1 6,9

Copper Roll Groover Model 1039

- 1¼" - 6" SCH 40
- 2" - 8" Copper Tube

With ratchet hand crank, roll grooves 1¼" - 6", Schedule 40 or thin wall steel pipe on the scaffold or anywhere power is unavailable.

Capacity: 1¼" - 6" SCH 40 (7mm)
 2" - 8" Copper Tube K, L, M and DWV

Model 1039 Mini-Mite Roll Groover service tool goes from in-place grooving and can be chucked in a Ridgid Model 300 in seconds with no gearbox removal.

Model 1039 Mini-Mite is self contained and can be entirely operated with its own multi-function crank so there are no other tools needed! All hex drives on Model 1039 Mini-Mite are 15/16", so one wrench fits everything.

Mini-Mites require no modifications or parts changes to groove any pipe or tubing in their size range.

Each comes with multi-step depth gauge.



COPPER
GROOVED
SYSTEM

Stainless Steel

STAINLESS STEEL

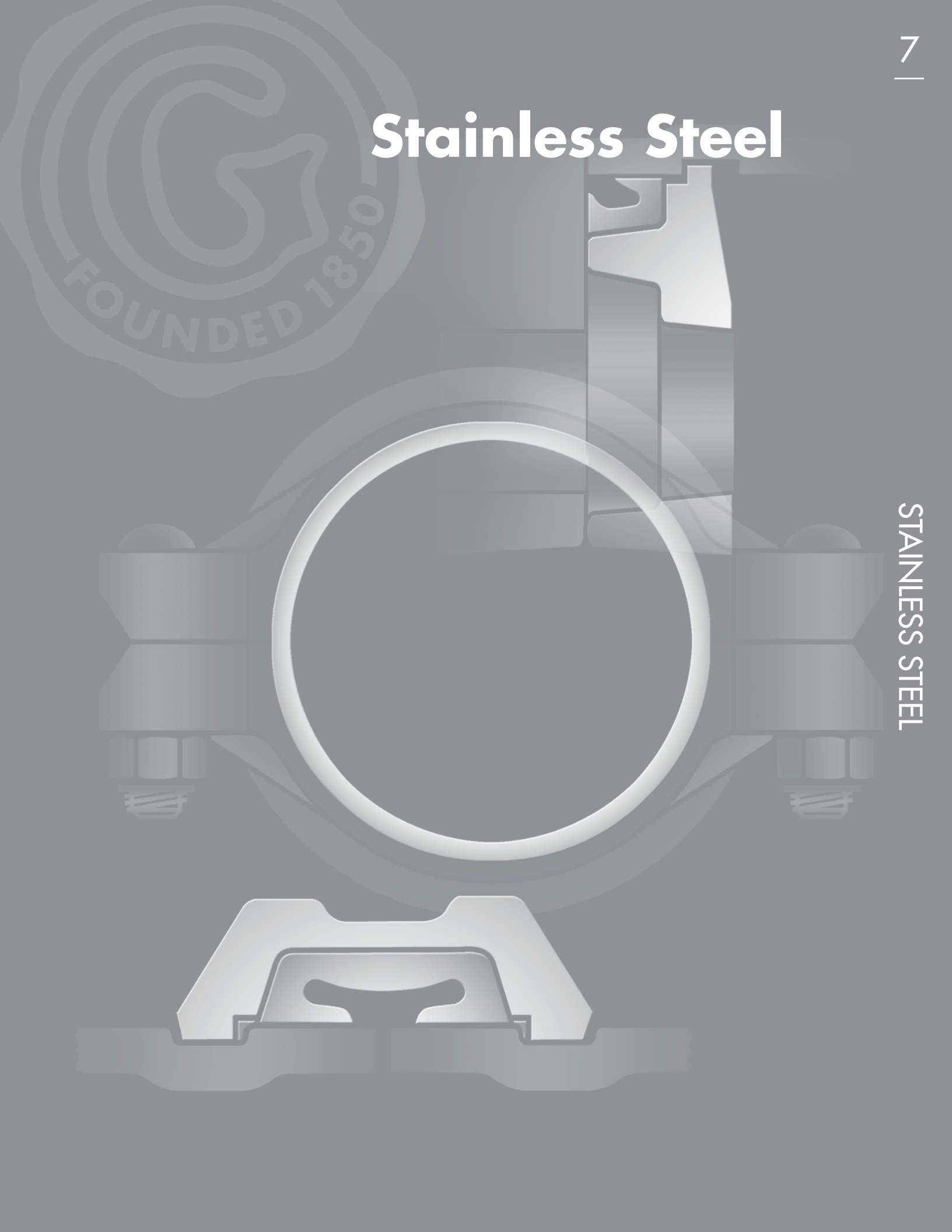

COUPLINGS

STAINLESS STEEL SYSTEM

The Grinnell® Stainless Steel System is designed for joining 2" to 12" (54,0mm to 206,4mm) stainless steel piping, schedules 5, 10, and 40.

The Figure 472 coupling patented Universal Tongue and Groove design makes for a trouble free installation and allows the coupling housing to grip along the full 360° of circumference of the pipe. This results in a more rigid and stronger connection. Coupling housings have gripping teeth in sizes 2" to 4" (54,0mm to 101,6 mm) that makes the Figure 472 perfectly suited for installations where the likelihood of rotation is greatest.

The Grinnell Stainless Steel Couplings are made of 316L and are generally compatible with grade 304 stainless steel material.

MATERIAL SPECIFICATIONS

Stainless Steel Housing Specifications

- Type 316L, ASTM A-743/A-743M – Standard Specification for Castings, Iron-Chromium, Iron-Chromium-Nickel, Corrosion resistant, for General Application Grade CR-8M
- Tensile Strength, minimum psi – 70,000 (Mpa-485)
- Yield Strength, minimum psi – 30,000 (Mpa-205)
- Elongation in 2" minimum 30%

Bolt / Nut Specifications

Stainless Steel bolts are metric track head bolts conforming to ASTM A-193M Class 2, Type 316 Grade B8M.

Class 2 Stainless Steel nuts are heavy hex nuts conforming to ASTM A-194M, Type 316, Grade 8M.

Gasket Specifications

Grade "E" EPDM gaskets have a green color code identification and conform to ASTM D-2000 for service temperatures from -30°F (-34°C) to 230°F (110°C). They are recommended for hot water not to exceed 230°F (110°C) plus a variety of dilute acids, oil free air and many chemical services. They are not recommended for petroleum services.

Grade "T" Nitrile gaskets have an orange color code identification and conform to ASTM D-2000 for service temperatures from -20°F (-29°C) to 180°F (82°C). They are recommended for petroleum products, vegetable oils, mineral oils and air with oil vapors.

Grade "O" Fluoroelastomer gaskets have a blue color code and conform to ASTM D-2000. They are recommended for oxidizing acids, petroleum products, hydraulic fluids, lubricants, halogenated hydrocarbons.

STAINLESS
STEEL

COUPLINGS

Figure 472 Stainless Steel Rigid Coupling



Tech Data: G560

Nominal Size Inches mm	Pipe OD Inches mm	Max. Pressures			Max. End Load Lbs. kN	Max. End Gap Inches mm	Nominal Dimension			Coupling Bolts		Approx. Weight Lbs. Kg
		Sch 5 psi Bar	Sch 10 psi Bar	Sch 40 psi Bar			A Inches mm	B Inches mm	C Inches mm	Qty.	Size mm	
1 1/4 32	1.660 42.4	200 14	300 21	600 41	649.7 2.89	0.06 1.5	2.76 70	4.37 111	1.81 46	2	M10 x 57	1.1 0.5
1 1/2 40	1.900 48.3	200 14	300 21	600 41	852.0 3.79	0.08 2.0	2.99 76	4.61 117	1.81 46	2	M10 x 57	1.1 0.5
2 50	2.375 60.3	200 14	300 21	600 41	1,328.6 5.91	0.13 3.3	3.43 87	5.12 130	1.89 48	2	M10 x 57	1.5 0.7
2 1/2 65	2.875 73.0	200 14	300 21	600 41	1,949.0 8.67	0.13 3.3	3.90 99	5.63 143	1.89 48	2	M10 x 57	2.4 1.1
3 80	3.500 88.9	200 14	300 21	600 41	2,886.4 12.84	0.13 3.3	4.65 118	6.26 159	1.89 48	2	M12 x 76	2.6 1.2
4 100	4.500 114.3	200 14	300 21	600 41	4,772.5 21.23	0.19 4.8	5.83 148	7.52 191	1.97 50	2	M12 x 76	3.5 1.6
5 125	5.563 141.3	200 14	300 21	600 41	7,292.5 32.44	0.19 4.8	7.09 180	9.72 247	2.05 52	2	M16 x 83	7.5 3.4
6 150	6.625 168.3	200 14	300 21	600 41	10,340.8 46.00	0.19 4.8	8.11 206	10.55 268	2.13 54	2	M16 x 83	7.5 3.4
8 200	8.625 219.1	200 14	300 21	600 41	17,527.7 77.97	0.19 4.8	10.55 268	13.54 344	2.64 67	2	M20 x 121	18.1 8.2
10 250	10.750 273.0	200 14	300 21	600 41	27,227.8 121.12	0.13 3.3	12.83 326	16.42 417	2.64 67	2	M24 x 165	24.7 11.2
12 300	12.750 323.9	— —	— —	— —	43,696.6 194.38	0.13 3.3	15.39 391	18.86 479	2.64 67	2	M24 x 165	42.1 19.1

The Fig. 472 Stainless Steel heavy Duty Rigid Coupling does not provide compensation for pipe system expansion and/or contraction associated with pipe system changes.

Maximum pressure and end load are total from all loads based on standard weight steel pipe. Pressure ratings and end loads may differ on pipe materials and/or wall thickness. Contact Tyco Fire and Building Products for details.

Maximum end gap and deflection is for cut grooved standard weight pipe. Values for roll grooved will be 1/2 that of cut grooved.

Please refer to general Notes on page 14.

STAINLESS
STEEL

COUPLINGS

Figure 405 Stainless Steel Flexible Coupling



Tech Data: G565

Nominal Size Inches mm	Pipe OD Inches mm	Max. Pressures			Max. End Load Lbs. kN	Max. End Gap Inches mm	Deflection		Nominal Dimension			Coupling Bolts		Approx. Weight Lbs. Kg
		Sch. 5 psi Bar	Sch. 10 psi Bar	Sch. 40 psi Bar			Degrees per Coupling	Inches/ Foot mm/m	A Inches mm	B Inches mm	C Inches mm	Qty.	Size mm	
1 1/4 32	1.660 42.4	325 22	500 34	750 52	658.7 2.93	0.13 3.3	4...19'	0.90 75.0	2.56 65	4.17 106	1.81 46	2	M10 x 57	1.5 0.7
1 1/2 40	1.900 48.3	325 22	500 34	750 52	849.7 3.78	0.13 3.3	3...46'	0.79 65.8	2.76 70	4.45 113	1.81 46	2	M10 x 57	1.5 0.7
2 50	2.375 60.3	225 16	350 24	500 34	1,328.6 5.91	0.13 3.3	3...01'	0.63 52.5	3.27 83	4.88 124	1.89 48	2	M10 x 57	1.8 0.8
2 1/2 65	2.875 73.0	225 16.0	350 24	500 34	1,946.8 8.66	0.13 3.3	2...29'	0.52 43.3	3.70 94	5.51 140	1.89 48	2	M10 x 57	2.0 0.9
3 80	3.500 88.9	225 16	350 24	500 34	2,884.2 12.83	0.13 3.3	2...03'	0.43 35.8	4.37 111	6.50 165	1.89 48	2	M12 x 76	3.1 1.4
4 100	4.500 114.3	200 14	300 21	325 22	4,768.0 21.21	0.25 6.4	3...11'	0.67 55.8	5.71 145	7.76 197	2.05 52	2	M12 x 76	4.0 1.8
5 125	5.563 141.3	125 9	200 14	200 14	7,737.6 34.42	0.25 6.4	2...35'	0.54 45.0	6.89 175	9.76 248	2.05 52	2	M16 x 83	7.1 3.2
6 150	6.625 168.3	125 9	200 14	200 14	10,336.3 45.98	0.25 6.4	2...10'	0.45 37.5	7.95 202	10.67 271	2.05 52	2	M16 x 83	7.1 3.2
8 200	8.625 219.1	50 3	75 5	200 14	17,516.4 77.92	0.25 6.4	1...40'	0.35 29.2	10.20 259	13.54 344	2.52 64	2	M20 x 121	14.6 6.6

Maximum pressure and end load are total from all loads based on standard weight steel pipe. Pressure ratings and end loads may differ on pipe materials and/or wall thickness. Contact Tyco Fire and Building Products for details.

Maximum available gap between pipe ends, minimum gap = 0.

Maximum end gap is for cut grooved standard weight pipe. Values for roll grooved will be 1/2 that of cut grooved.

Please refer to general Notes on page 14.

STAINLESS
STEEL

FITTINGS

Figure 410 & 401 Stainless Steel Elbow

Nominal Size Inches <i>mm</i>	Pipe O.D. Inches <i>mm</i>	Fig. 410 90... Elbow		Fig. 401 45... Elbow	
		C to E Inches <i>mm</i>	Approx. Weight Lbs. <i>Kg.</i>	C to E Inches <i>mm</i>	Approx. Weight Lbs. <i>Kg.</i>
1 <i>25</i>	1.315 <i>33.4</i>	3.50 <i>88.9</i>	— —	2.50 <i>63.5</i>	.6 .3
1¼ <i>32</i>	1.660 <i>42.4</i>	3.88 <i>98.4</i>	.9 .4	2.50 <i>63.5</i>	.6 .3
1½ <i>40</i>	1.900 <i>48.3</i>	4.25 <i>108.0</i>	1.3 .6	2.50 <i>63.5</i>	.8 .4
2 <i>50</i>	2.375 <i>60.3</i>	4.38 <i>111.1</i>	2.0 .9	2.75 <i>69.9</i>	.9 .4
2½ <i>65</i>	2.875 <i>73.0</i>	5.75 <i>146.1</i>	2.8 1.3	3.0 <i>76.2</i>	1.0 .5
3 <i>80</i>	3.500 <i>88.9</i>	5.88 <i>149.2</i>	3.8 1.7	3.38 <i>85.7</i>	2.1 1.0
4 <i>100</i>	4.500 <i>114.3</i>	7.50 <i>190.5</i>	5.7 2.6	4.00 <i>101.6</i>	3.6 1.6
6 <i>150</i>	6.625 <i>168.3</i>	10.75 <i>273.1</i>	14.4 6.5	5.50 <i>139.7</i>	8.4 3.8
8 <i>200</i>	8.625 <i>219.1</i>	15.00 <i>381.0</i>	29.3 13.3	7.25 <i>184.2</i>	16.5 7.5
10 <i>250</i>	10.750 <i>273.0</i>	18.00 <i>457.2</i>	41.8 19.0	8.50 <i>215.9</i>	21.0 9.5
12 <i>300</i>	12.750 <i>323.9</i>	21.00 <i>533.4</i>	46.5 21.1	10.00 <i>254.0</i>	23.0 10.4

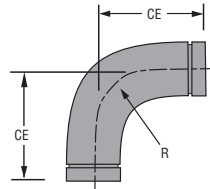

FIGURE 410
90... ELBOW
FABRICATED,
LONG RADIUS
FULL FLOW FITTINGS

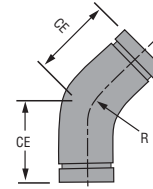

FIGURE 401
45... ELBOW
FABRICATED,
LONG RADIUS
FULL FLOW FITTINGS

Figure 419 Tee

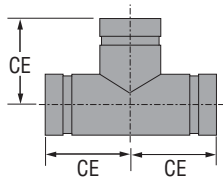

FIGURE 419 TEE
SEGMENT WELDED, FULL FLOW

Nominal Size Inches <i>mm</i>	Pipe O.D. Inches <i>mm</i>	C to E Inches <i>mm</i>	Approx. Weight Lbs. <i>Kg.</i>
1 <i>25</i>	1.315 <i>33.4</i>	2.75 <i>69.8</i>	1.3 0.6
1¼ <i>32</i>	1.660 <i>42.4</i>	2.75 <i>69.8</i>	1.5 0.7
1½ <i>40</i>	1.900 <i>48.3</i>	3.25 <i>82.5</i>	2.1 .9
2 <i>50</i>	2.375 <i>60.3</i>	3.75 <i>95.2</i>	2.8 1.3
2½ <i>65</i>	2.875 <i>73.0</i>	4.25 <i>107.9</i>	3.9 1.8
3 <i>80</i>	3.500 <i>88.9</i>	5.00 <i>127.0</i>	7.8 3.2
4 <i>100</i>	4.500 <i>114.3</i>	6.50 <i>165.1</i>	15.2 6.9
6 <i>150</i>	6.625 <i>168.3</i>	7.75 <i>196.8</i>	18.1 8.2
8 <i>200</i>	8.625 <i>219.1</i>	9.00 <i>228.6</i>	35.6 16.2
10 <i>250</i>	10.750 <i>273.0</i>	10.00 <i>254.0</i>	51.4 23.4

Figure 460 End Cap

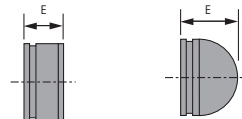

FIGURE 460
END CAP

Nominal Size Inches <i>mm</i>	Pipe O.D. Inches <i>mm</i>	E to E Inches <i>mm</i>	Approx. Weight Lbs. <i>Kg.</i>
1 <i>25</i>	1.315 <i>33.4</i>	1.63 <i>41.3</i>	0.23 0.1
1¼ <i>32</i>	1.660 <i>42.4</i>	1.63 <i>41.3</i>	0.3 0.1
1½ <i>40</i>	1.900 <i>48.3</i>	1.63 <i>41.3</i>	0.4 0.2
2 <i>50</i>	2.375 <i>60.3</i>	1.63 <i>41.3</i>	0.5 0.2
2½ <i>65</i>	2.875 <i>73.0</i>	1.75 <i>44.5</i>	0.7 0.3
3 <i>80</i>	3.500 <i>88.9</i>	1.75 <i>44.5</i>	1.0 0.4
4 <i>100</i>	4.500 <i>114.3</i>	1.75 <i>44.5</i>	1.6 0.7
6 <i>150</i>	6.625 <i>168.3</i>	1.88 <i>47.6</i>	3.7 1.7
8 <i>200</i>	8.625 <i>219.1</i>	4.00 <i>101.6</i>	8.0 3.6
10 <i>250</i>	10.750 <i>273.0</i>	4.00 <i>101.6</i>	11.5 5.2
12 <i>300</i>	12.750 <i>323.9</i>	4.00 <i>101.6</i>	15.1 6.8

STAINLESS
STEEL

FITTINGS

Figure 450 Concentric Reducer

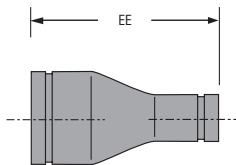

FIGURE 450
CONCENTRIC REDUCER
FABRICATED FULL FLOW

Nominal Size Inches <i>mm</i>	Pipe O.D. Inches <i>mm</i>	E to E Inches <i>mm</i>	Approx. Weight Lbs. <i>Kg.</i>
1½ x 1¼ 40 x 32	1.900 x 1.660 48.3 x 42.4	3.38 85.9	.55 .25
2 x 1 50 x 25	2.375 x 1.315 60.33 x 33.7	3.38 85.9	.57 .25
2 x 1½ 50 x 40	2.375 x 1.900 60.3 x 48.3	3.38 85.9	.66 .28
2½ x 2 65 x 50	2.875 x 2.375 73.0 x 60.3	5.00 127.0	1.28 .58
3 x 1 80 x 25	3.500 x 1.315 88.9 x 33.7	5.00 127.0	1.28 .58
3 x 2 80 x 50	3.500 x 2.375 88.9 x 60.3	5.00 127.0	1.45 .65
3 x 2½ 80 x 65	3.500 x 2.875 88.9 x 73.0	5.00 127.0	1.64 .74
4 x 2 100 x 50	4.500 x 2.375 114.3 x 60.3	6.00 152.4	2.67 1.21
4 x 2½ 100 x 65	4.500 x 2.875 114.3 x 73.0	6.00 152.4	2.78 1.26
4 x 3 100 x 80	4.500 x 3.500 114.3 x 88.9	6.00 152.4	2.92 1.33
5 x 3 125 x 80	5.563 x 3.500 141.3 x 88.9	7.00 177.8	4.17 1.89
5 x 4 125 x 100	5.563 x 4.500 141.3 x 114.3	7.00 177.8	4.26 1.94
6 x 2 150 x 50	6.625 x 2.375 168.3 x 60.3	9.00 228.6	4.92 2.24
6 x 2½ 150 x 65	6.625 x 2.875 168.3 x 73.0	9.00 228.6	5.06 2.3
6 x 3 150 x 80	6.625 x 3.500 168.3 x 88.9	9.00 228.6	5.72 2.6
6 x 4 150 x 100	6.625 x 4.500 168.3 x 114.3	9.00 228.6	6.07 2.76
8 x 3 200 x 80	8.625 x 3.500 219.1 x 88.9	9.50 241.3	9.98 4.54
8 x 4 200 x 100	8.625 x 4.500 219.1 x 114.3	9.50 241.3	10.30 4.68
8 x 6 200 x 150	8.625 x 6.625 219.1 x 168.3	9.50 241.3	10.64 4.84
10 x 4 250 x 100	10.750 x 4.500 273.0 x 114.3	10.00 254.0	15.14 6.88
10 x 6 250 x 150	10.750 x 6.625 273.0 x 168.3	10.00 254.0	15.75 7.15
10 x 8 250 x 200	10.750 x 8.625 273.0 x 219.1	10.00 254.0	15.77 7.17
12 x 6 300 x 150	12.750 x 6.625 323.9 x 168.3	10.50 266.7	22.38 10.17
12 x 8 300 x 200	12.750 x 8.625 323.9 x 219.1	10.50 266.7	23.00 10.45
12 x 10 300 x 250	12.750 x 10.750 323.9 x 273.0	10.50 266.7	23.69 10.77

STAINLESS
STEEL

Figure 451 Eccentric Reducer

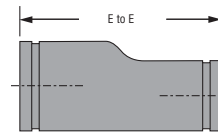

FIGURE 451
ECCENTRIC REDUCER
FABRICATED FULL FLOW

Nominal Size Inches <i>mm</i>	Pipe O.D. Inches <i>mm</i>	E to E Inches <i>mm</i>	Approx. Weight Lbs. <i>Kg.</i>
1½ x 1¼ 40 x 32	1.900 x 1.660 48.3 x 42.4	8.50 215.9	1.5 .7
2 x 1 50 x 25	2.375 x 1.315 60.33 x 33.7	9.00 228.6	2.0 .9
2 x 1½ 50 x 40	2.375 x 1.900 60.3 x 48.3	9.00 228.6	2.0 .9
2½ x 2 65 x 50	2.875 x 2.375 73.0 x 60.3	9.50 241.3	2.8 1.3
3 x 1 80 x 25	3.500 x 1.315 88.9 x 33.7	9.50 241.3	3.2 1.5
3 x 2 80 x 50	3.500 x 2.375 88.9 x 60.3	9.50 241.3	3.4 1.5
3 x 2½ 80 x 65	3.500 x 2.875 88.9 x 73.0	9.50 241.3	3.5 1.6
4 x 2 100 x 50	4.500 x 2.375 114.3 x 60.3	10.00 254	4.6 2.7
4 x 2½ 100 x 65	4.500 x 2.875 114.3 x 73.0	10.00 254	4.7 2.1
4 x 3 100 x 80	4.500 x 3.500 114.3 x 88.9	10.00 254	4.7 2.1
5 x 3 125 x 80	5.563 x 3.500 141.3 x 88.9	11.00 279.4	6.1 2.8
5 x 4 125 x 100	5.563 x 4.500 141.3 x 114.3	11.00 279.4	6.1 2.8
6 x 2½ 150 x 65	6.625 x 2.875 168.3 x 73.0	11.50 292.1	8.0 3.6
6 x 3 150 x 80	6.625 x 3.500 168.3 x 88.9	11.50 292.1	8.7 4.0
6 x 4 150 x 100	6.625 x 4.500 168.3 x 114.3	11.50 292.1	9.1 4.2
8 x 3 200 x 80	8.625 x 3.500 219.1 x 88.9	12.00 304.8	13.2 6.0
8 x 4 200 x 100	8.625 x 4.500 219.1 x 114.3	12.00 304.8	13.4 6.1
8 x 6 200 x 150	8.625 x 6.625 219.1 x 168.3	12.00 304.8	13.6 6.2
10 x 6 250 x 150	10.750 x 6.625 273.0 x 168.3	13.00 330.2	20.4 9.3
10 x 8 250 x 200	10.750 x 8.625 273.0 x 219.1	13.00 330.2	20.9 9.5
12 x 6 300 x 150	12.750 x 6.625 323.9 x 168.3	14.00 355.6	20.6 9.3
12 x 8 300 x 200	12.750 x 8.625 323.9 x 219.1	14.00 355.6	29.1 13.2
12 x 10 300 x 250	12.750 x 10.750 323.9 x 273.0	14.00 355.6	29.9 13.6

FITTINGS

Figure 421 Stainless Steel Reducing Tee

Nominal Size Inches mm	Pipe O.D. Inches mm	C to E Inches mm	Approx. Weight Lbs. Kg.
1½ x 1½ x ¾ 40 x 40 x 20	1.900 x 1.900 x 1.050 48.3 x 48.3 x 26.7	2.75 69.9	1.3 0.6
1½ x 1½ x 1 40 x 40 x 25	1.900 x 1.900 x 1.315 48.3 x 48.3 x 33.4	2.75 69.9	1.3 0.6
1½ x 1½ x 1¼ 40 x 40 x 32	1.900 x 1.900 x 1.660 48.3 x 48.3 x 42.4	2.75 69.9	1.3 0.6
2 x 2 x ¾ 50 x 50 x 20	2.375 x 2.375 x 1.050 60.3 x 60.3 x 26.7	3.25 82.6	1.8 0.8
2 x 2 x 1 50 x 50 x 25	2.375 x 2.375 x 1.315 60.3 x 60.3 x 33.4	3.25 82.6	1.8 0.8
2 x 2 x 1¼ 50 x 50 x 32	2.375 x 2.375 x 1.660 60.3 x 60.3 x 42.4	3.25 82.6	1.8 0.8
2 x 2 x 1½ 50 x 50 x 40	2.375 x 2.375 x 1.900 60.3 x 60.3 x 48.3	3.25 82.6	1.9 0.9
2½ x 2½ x 1 65 x 65 x 25	2.875 x 2.875 x 1.660 73.0 x 73.0 x 42.4	3.75 95.3	2.3 1.0
2½ x 2½ x 1½ 65 x 65 x 40	2.875 x 2.875 x 1.900 73.0 x 73.0 x 48.3	3.75 95.3	2.4 1.1
2½ x 2½ x 2 65 x 65 x 50	2.875 x 2.875 x 2.375 73.0 x 73.0 x 60.3	3.75 95.3	2.4 1.1
3 x 3 x ¾ 80 x 80 x 20	3.500 x 3.500 x 1.050 88.9 x 88.9 x 26.7	4.25 108.0	3.2 1.5
3 x 3 x 1 80 x 80 x 25	3.500 x 3.500 x 1.315 88.9 x 88.9 x 33.4	4.25 108.0	3.2 1.5
3 x 3 x 1¼ 80 x 80 x 32	3.500 x 3.500 x 1.660 88.9 x 88.9 x 42.2	4.25 108.0	3.2 1.5
3 x 3 x 1½ 80 x 80 x 40	3.500 x 3.500 x 1.900 88.9 x 88.9 x 48.3	4.25 108.0	3.2 1.5
3 x 3 x 2 80 x 80 x 50	3.500 x 3.500 x 2.375 88.9 x 88.9 x 60.3	4.25 108.0	3.3 1.5
3 x 3 x 2½ 80 x 80 x 65	3.500 x 3.500 x 2.875 88.9 x 88.9 x 73.0	4.25 108.0	3.5 1.6
4 x 4 x 2 100 x 100 x 50	4.500 x 4.500 x 2.375 114.3 x 114.3 x 60.3	5.00 127.0	5.6 2.5
4 x 4 x 2½ 100 x 100 x 65	4.500 x 4.500 x 2.875 114.3 x 114.3 x 73.0	5.00 127.0	6.2 2.8
4 x 4 x 3 100 x 100 x 80	4.500 x 4.500 x 3.500 114.3 x 114.3 x 88.9	5.00 127.0	6.3 2.9
6 x 6 x 3 150 x 150 x 80	6.625 x 6.625 x 3.500 168.3 x 168.3 x 88.9	6.50 165.1	12.7 5.8
6 x 6 x 4 150 x 150 x 100	6.625 x 6.625 x 4.500 168.3 x 168.3 x 114.3	6.50 165.1	12.7 5.8
8 x 8 x 4 200 x 200 x 100	8.625 x 8.625 x 4.500 219.1 x 219.1 x 114.1	7.75 196.9	15.7 7.1
8 x 8 x 6 200 x 200 x 150	8.625 x 8.625 x 6.625 219.1 x 219.1 x 168.3	7.75 196.9	16.5 7.5
10 x 10 x 6 250 x 250 x 150	10.750 x 10.750 x 6.625 273.0 x 273.0 x 168.3	9.00 228.6	24.8 11.2
10 x 10 x 8 250 x 250 x 200	10.750 x 10.750 x 8.625 273.0 x 273.0 x 219.1	9.00 228.6	29.1 13.2
12 x 12 x 8 300 x 300 x 200	12.750 x 12.750 x 8.625 323.9 x 323.9 x 219.1	10.00 254.0	52.6 23.9
12 x 12 x 10 300 x 300 x 250	12.750 x 12.750 x 10.750 323.9 x 323.9 x 273.0	10.00 254.0	55.8 25.3

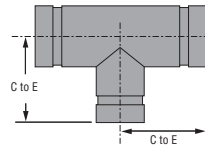

FIGURE 421
REDUCING TEE
SEGMENT WELDED

STAINLESS
STEEL

FITTINGS

Figure 441 Flange Adapter

Groove x Class 150 Flange			
Nominal Size Inches <i>mm</i>	Pipe O.D. Inches <i>mm</i>	E to E Inches <i>mm</i>	Approx. Weight Lbs. <i>Kg.</i>
1 25	1.315 33.4	3.00 76.2	2.5 1.1
1¼ 32	1.660 42.2	4.00 101.6	3.8 1.7
1½ 40	1.900 48.3	4.00 101.6	4.1 1.9
2 50	2.375 60.3	4.00 101.6	6.0 2.7
2½ 65	2.875 73.0	4.00 101.6	9.2 4.2
3 80	3.500 88.9	4.00 101.6	10.4 4.7
4 100	4.500 114.3	6.00 152.4	19.1 8.7
5 125	5.563 141.3	6.00 152.4	23.0 10.4
6 150	6.625 168.3	6.00 152.4	29.5 13.4
8 200	8.625 219.1	6.00 152.4	43.5 19.7
10 250	10.750 273.1	8.00 203.2	68.2 30.9
12 300	12.750 323.9	8.00 203.2	96.1 43.6

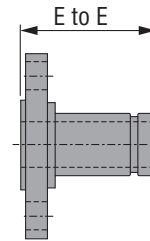

FIGURE 441
FLANGE ADAPTER

Tech Data: G568

STAINLESS
STEEL

Gaskets

GASKETS



GASKETS

GRINNELL® GASKET TYPES

Pressure responsive gaskets are offered in a variety of types. Although they each serve a specific function they all utilize the same sealing design.

The Grinnell Gasket is designed to provide a three-way sealing action.

- (1) Installation of the gasket over the outside sealing surface of the pipe compresses the lip seal thus forming the initial seal.
- (2) The installation of the housing segments around the gasket and into the pipe groove properly positions the gasket. Tightening of the housing segments forms the gasket to the inside of the housing and compresses it around the pipe-sealing surface thus increasing the gasket's sealing against the pipe.
- (3) The introduction of the system pressure energizes the pressure responsive seal of the gasket and further enhances the sealing action.

Tech Data: G610

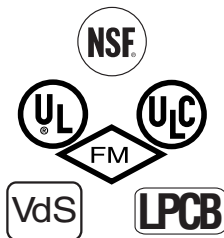

For Fire Protection Pressure Rating and Listing / Approval information contact Tyco Fire & Building Products.

GASKETS

STYLES

Standard

The standard style gasket, with a “C” shape configuration, is the most commonly used. It is provided as the standard in the Figure 705, 707, & 772 Grinnell Couplings. The gasket is available in two types of material, Grade “E” EPDM and Grade “T” Nitrile.

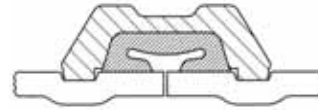

Tri-Seal

The Tri-Seal gasket is designed to close off the gap or gasket cavity. This is accomplished by positioning the center “rib” of the gasket over the gap between the pipes. The Tri-Seal gasket has two tapered sealing edges in addition to the center rib for additional strength and sealing.

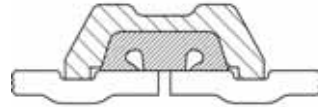

The Tri-Seal gasket can be used with the Figure 705, 707, & 772 Grinnell Couplings. It is recommended for use in low temperature and vacuum services (greater than 10" Hg) applications. Note only a petroleum-free silicone based lubricant is recommended for low temperature applications. The gasket is available in Grade “E” EPDM.

Note: Rigid couplings are recommended for vacuum and low temperature applications.

Reducing Coupling

The gasket is provided with ribs used to position the larger pipe so that the sealing lip is located on the sealing surface of the pipe. This gasket is used only with the Figure 716 Grinnell Reducing Coupling and is available in Grade “E” EPDM.

Reducing couplings are not recommended for low temperature applications.

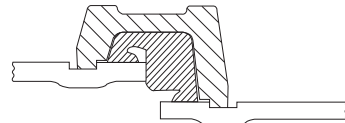

Flange Adapter

This gasket is specifically designed for use with the Figure 71 Flange Adapter. The gasket has an optimum amount of rubber to provide a dependable seal between both the pipe and mating surface, and to avoid overfilling of the gasket pocket, which causes assembly difficulties. The gasket is available in Grade “E” EPDM.

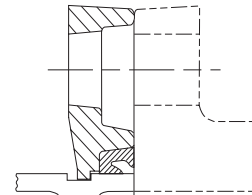

Mechanical Tee and Strap

The gasket provides a compression type seal, which is designed to conform to the exterior curve (OD) of the pipe. This design is unique to both the Figure 730 Mechanical Tee (threaded and grooved) and Figure 40-5 Strap. The gasket is available in Grade “E” EPDM.

Note: When used in low temperature applications, use a petroleum-free silicone based lubricant otherwise no lubricant is required on Mechanical Tee and Strap gaskets.

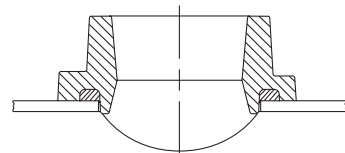

GASKETS

GASKETS

Grinnell® Gasket Grade & Recommendations

The Gasket Recommendation Table has been developed to assure maximum service life. The table was developed from information supplied by the material manufacturers of the elastomer, technical reference literature and testing conducted by Tyco Fire & Building Products.

In evaluating the gasket grade for intended service applications the following consideration must be reviewed: system operating temperature, fluid or solution concentration, and duration of service.

All gasket recommendations are based on a temperature of 70°F (21°C) unless otherwise noted.

Technical and Engineering Services should be consulted if combinations of service solutions are being considered.

Contact Tyco Fire & Building Products for recommendations for services not listed.

Gasket recommendations apply to Grinnell gaskets and valves only.

Grade	Temp. Range	Compound	Color Code	General Service Application
E	-30°F (-34°C) to +230°F (+110°C)	EPDM	Green	Hot water, dilute acids, alkalies, oil free air, and many chemical services not involving petroleum products. Excellent oxidation resistance. NOT FOR USE WITH HYDROCARBONS.
E Tri-Seal	-30°F (-34°C) to +230°F (+110°C)	EPDM	Green	Hot water, dilute acids, alkalies, and many chemical services not involving petroleum products. Excellent oxidation resistance. NOT FOR USE WITH HYDROCARBONS. Recommended for low temperature and vacuum services.
T	-20°F (-29°C) to +180°F (+82°C)	Nitrile	Orange	Petroleum products, vegetable oils, mineral oils and air with oils. Not Recommended for Hot Water Systems. Not Recommended for Hot Dry Air Systems.
O	+20°F (-7°C) to +300°F (+149°C)	Fluoroelastomer	Blue	Oxidizing acids, petroleum products, hydraulic fluids, lubricants, halogenated hydrocarbons.
L	-30°F (-34°C) to +350°F (+177°C)	Silicone	Red Gasket	Air without hydrocarbons, dry heat.
EN & EN Tri-Seal	Cold and Hot Potable Water up to +180°F (+82°C)		Copper	NSF 61 Approved for potable water. Not recommended for petroleum service.

GASKETS

- Contact Tyco Fire & Building Products for an Engineering evaluation and recommendation where the gasket grade is shown in parenthesis.
- Specify gasket grade when ordering.
- For vacuum or low temperature systems, use Tri-Seal gasket. For low temperature applications, use a petroleum-free silicone lubricant.
- Check gasket color code to be certain it is recommended for the service intended.
- Unless otherwise noted, all gasket listings are based upon a temperature of 70°F (21°C).
- For services not listed contact Tyco Fire & Building Products for recommendation.
- Where more than one gasket is shown, the preferred gasket grade is listed first.

WATER AND AIR

Service	Gasket Grade
Air, (no oil vapors) Temp. -30°F (-34°C) to +230°F (+110°C)	E
Air, Oil Vapor Temp. -20°F (-29°C) to +150°F (+66°C)	T
Water, Temp. to +230°F (+110°C) (NOT RECOMMENDED FOR STEAM SERVICE)	E
Water, Acid Mine	E/T
Water, Chlorine	E
Water, Deionized	E
Water, Seawater	E
Water, Waste (NO PETROLEUM PRODUCTS)	E

Chemical Composition	Gasket Grade	Chemical Composition	Gasket Grade	Chemical Composition	Gasket Grade	Chemical Composition	Gasket Grade
Acetic Acid up to 10%	E	Carbon Dioxide, Wet	E/T	Hexylene Glycol	T	Soda Ash, Sodium Carbonate	E/T
Acetone	E	Carbon Monoxide	E	Hydrochloric Acid to 36%, 75°F (24°C) Max	E	Sodium Bicarbonate	E/T
Acetylene	E/T	Caustic Potash	T	Hydrofluosilicic Acid	E	Sodium Bisulphate	E/T
Alkalis	E	Chrome Alum	T	Isobutyl Alcohol	E	Sodium Bisulphite (black liquor)	E/T
Aluminum Chloride	E/T	Citric Acid	E/T	Isopropyl Alcohol	E	Sodium Bromide	E/T
Aluminum Fluoride	E/T	Copper Chloride	T	Lead Acetate	T	Sodium Chlorate	E
Aluminum Hydroxide	E	Copper Cyanide	E/T	Lithium Bromide	T	Sodium Chloride	E/T
Aluminum Nitrate	E/T	Copper Sulphate	E/T	Magnesium Chloride	E/T	Sodium Cyanide	E/T
Aluminum Salts	T	Cupric Fluoride	E	Magnesium Hydroxide	E/T	Sodium Hydroxide, to 50%	E
Ammonia Gas, Cold	E	Cupric Sulphate	E/T	Magnesium Sulphate	E/T	Sodium Hypochlorite, to 20%	E
Ammonia Liquid	E	Diocetyl Phthalate	E	Methyl Alcohol, Methanol	E/T	Sodium Metaphosphate	T
Ammonium Chloride	E/T	Ethane	E	Methyl Isobutyl Carbinol	E	Sodium Nitrate	E
Amyl Acetate	E	Ethanolamine	E	Mineral Oils	T	Sodium Peroxide	E
Amyl Alcohol	E	Ethyl Alcohol	E	Nickel Chloride	E/T	Sodium Phosphate	T
Aniline	E	Ethyl Chloride	E	Nickel Plating Solution 125°F (52°C) Max	E/T	Sodium Silicate	T
Arsenic Acid to 75%	T	Ethylene Chlorohydrin	E	Nitric Acid, to 10%, 75°F (24°C) Max	E	Sodium Sulfide	T
Barium Carbonate	E	Ethylene Diamine	T	Nitrous Oxide	E	Sodium Sulphite Solution, to 20%	T
Barium Chloride	E/T	Ethylene Glycol	E/T	Ozone	E	Sodium Thiosulphate, "Hypo"	T
Barium Hydroxide	E/T	Ferric Sulphate	T	Phosphate Ester	E	Stannous Chloride, to 15%	T
Benzoic Acid	E	Fluoboric Acid	E/T	Phosphoric Acid to 75%, 70°F (21°C) Max	E/T	Stearic Acid	T
Benzyl Alcohol	E	Fly Ash	E	Potassium Bromide	E/T	Sulphur	E
Borax Solutions	E	Fomaldehyde	E/T	Potassium Carbonate	E/T	Sulphuric Acid, to 25%, 150°F (66°C) Max	E
Boric Acid	E/T	Formamide	E/T	Potassium Chloride	E	Toluene 30%	T
Butyl Alcohol	E/T	Formic Acid	E	Potassium Chromate	T	Triethanolamine	E/T
Butylene	T	Fructose	E/T	Potassium Hydroxide	T	Trisdodium Phosphate - 11lbs./50gal. (5Kg/189L)	E
Calcium Bisulphate	T	Furfuryl Alcohol	E	Propylene Glycol	E	Urea	T
Calcium Chloride	E/T	Glycerin	E/T	Salicylic Acid	E	Vegetable Oil	T
Calcium Hydroxide (Lime)	E/T	Glycerol	E/T	Silver Nitrate	E	Vinyl Acetate	E
Calcium Sulfate	E/T	Glycol	E/T				
Calcium Sulfide	E	Heptane	T				
Carbitol	E/T	Hexaldehyde	E				
Carbon Dioxide, Dry	E/T	Hexane	T				

GASKETS

GASKET LUBRICANTS

During installation of a Grinnell® Coupling, always lubricate the gasket. For couplings using the Tri-Seal gasket in a low temperature application, use a petroleum-free silicone based lubricant. For mechanical tees and straps when used in low temperature applications, use a petroleum-free silicone based lubricant, otherwise no lubricant is required.

Grinnell Mechanical Piping Products recommends two kinds of lubricant;

La-Co Industries Lubri-Joint

Dow Corning® 7 Release Compound (Silicone)

Check lubricant chart to be certain of the proper lubricant recommended for the service intended. For information on health safety contact Tyco Fire & Building Products for Material Safety Data Sheets (MSDS).

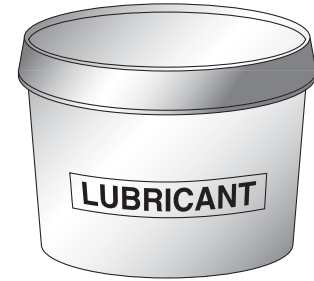

Application	La-Co Industries Lubri-Joint	Dow Corning® 7 Release Compound (Silicone)
Chilled Water	•	•
Heating	•	•
Compressed Air	•	•
Drainage	•	•
Sewage	•	•
Low Temp./Vacuum	•	•
Fire Protection	•	•

Available in:

- 1 quart
- 1 gallon

The table below will give an indication on the approximate number of gaskets which can be lubricated with one container of lubricant.

Gasket Size	Lubri-Joint 1 qt. (946ml) container	Silicone 5.3oz. (150g) tube
1 1/4" / 32mm	650	116
1 1/2" / 40mm	570	94
2" / 50mm	440	73
3" / 80mm	300	50
4" / 100mm	220	36
6" / 150mm	135	22
8" / 200mm	110	18
10" / 250mm	85	14
12" / 300mm	65	10
14" / 350mm	55	9
16" / 400mm	50	8
18" / 450mm	38	6
20" / 500mm	33	5
24" / 600mm	20	3

Silicone Gasket Lubricant available in:

- 8 lb. can

Pipe Preparation Equipment & Groove Data

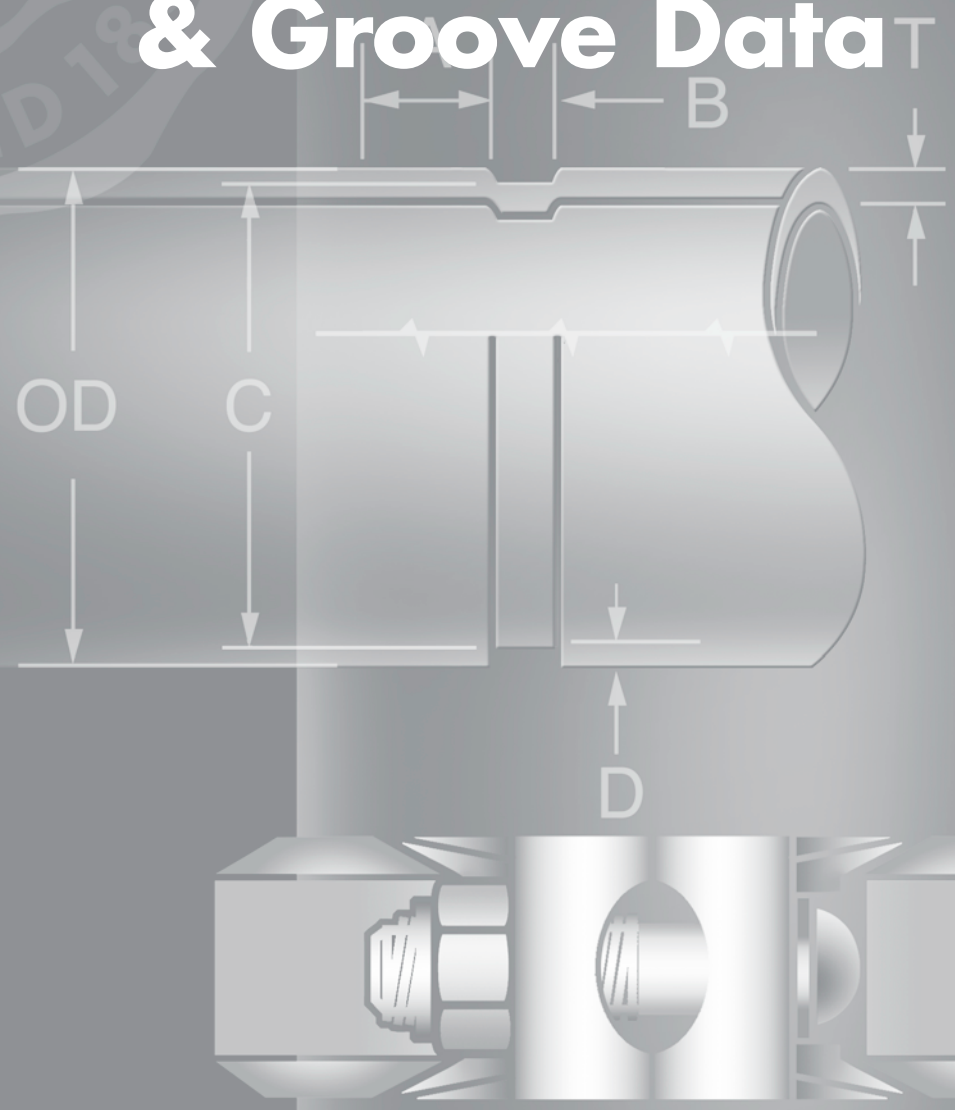

PIPE PREP. EQUIPMENT

Model 1112 • 1" – 12" Pipe

Portable Roll Groover

Model 1112 requires just three Top Rollers and three Bottom Rollers to produce specification quality grooves in pipe from 1" through 12" diameter Schedule 40. Easily portable for on-the-job work, the Model 1112's electric motor rotates pipe at speeds of 35 RPM. The hand hydraulic pump will deliver up to 15,000 psi pressure at the point of roll grooving. The Model 1112 is ruggedly built to deliver long, trouble-free service.

Model 1112 Specifications

Capacity: 1" - 12" SCH 40 (10mm)
2" - 6" Copper Tubing K, L, M and DWV

Pipe Rotation Speed: 35 RPM

Hydraulic Pressure at Roller: 15,000 psi max

Spindle Height from Floor: 35" (889mm)

Electric Motor: 1½ HP 60Hz 110 V.1 PH.*

Floor Space Required: 32" x 32" (813 x 813mm)

Shipping Weight: 220 lbs. (100 kg)

Interchangeable Rollers:

Top Pipe Diameter:

- 1" - 1½" (25mm - 38mm)
- 2" - 6" (51mm - 152mm)
- 8" - 12" (203mm - 305mm)

Bottom Pipe Diameter:

- 1" - 1½" (25mm - 38mm)
- 2" - 6" (51mm - 152mm)
- 8" - 12" (203mm - 305mm)

*Other current characteristics available.

Standard Equipment: Electric Drive Motor • Groove Depth Gauge • Hydraulic Hand Pump • Top and Bottom Rollers 1 - 12" • Shipping/Storage Box • Guards • Foot Switch

Optional Equipment: Top and Bottom Copper Rollers 2 - 8"; Nipple Bracket



Portable Roll Groover

PIPE PREP. EQUIPMENT

Model 1012 • 1" – 12" Pipe

Portable Roll Groover

For Grooving 1" - 12" schedule 40, the Model 1012 is designed with a new hydraulic ratio along with an advanced spindle design which allows greater strength and pressure in a compact package for grooving up to 12" Schedule 40, using a standard model Ridgid® 300.

A hydraulic hand pump will deliver increased pressure for grooving up to 0.406 wall pipe to specification quality grooves. Top and bottom roll change is made easy with cross taper pin in the bottom roll and socket set screw in the top roll for positive no slip design.



Portable Roll Groover

Model 1012 Specifications

Capacity: 1" - 12" SCH 40 (10mm)
2" - 6" Copper Tubing K, L, M and DWV

Shipping Weight: 125 lbs.

Interchangeable Rollers:

Top Pipe Diameter:

- 1" - 1½" (25mm - 38mm)
- 2" - 6" (51mm - 152mm)
- 8" - 12" (203mm - 305mm)

Bottom Pipe Diameter:

- 1" - 1½" (25mm - 38mm)
- 2" - 6" (51mm - 152mm)
- 8" - 12" (203mm - 305mm)

Optional Equipment: Pipe Nipple and Stabilizer Bracket

Model 1022 • 1¼" – 16" Pipe

Pipe Groover for Mounting on Ridgid® 300 Pipe Threader

Get double duty from the Ridgid 300 Pipe Threader by converting it to a pipe groover with the Model 1022 Pipe Groover. Designed for quick, easy mounting on standard Model 300, the 1022 Pipe Groover can roll grooves in pipe from 1¼" - 16" diameter. The hand hydraulic pump will deliver up to 16,000 psi pressure at the point of roll grooving. Pipe Threader's motor will rotate the pipe to produce specification quality grooves in pipe.

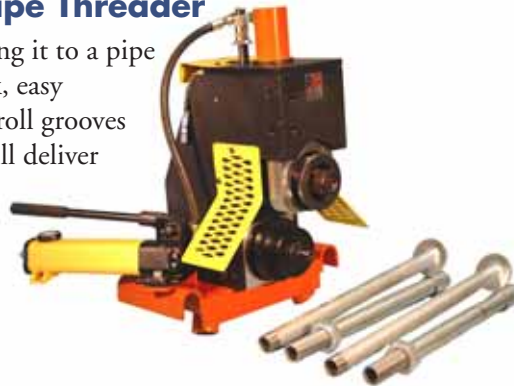

Pipe Groover for Mounting on Ridgid 300 Pipe Threader

Model 1022 Specifications

Capacity: 1¼" - 12" SCH 40 (10mm)
12" - 16" Standard Wall 0.375 (9.5mm)
2" - 6" Copper Tubing K, L, M and DWV

Hydraulic Pressure at Roller: 16,000 psi. max.

Shipping Weight: 285 lbs. (129.3 kg)

Interchangeable Rollers:

Top Pipe Diameter:

- 1¼" - 1½" (32mm - 38mm)
- 2" - 3½" (51mm - 89mm)
- 4" - 6" (102mm - 152mm)
- 8" - 12" (203mm - 305mm)
- 14" - 16" (356mm - 407mm)

Bottom Pipe Diameter:

- 1¼" - 1½" (32mm - 38mm)
- 2" - 3½" (51mm - 89mm)
- 4" - 6" (102mm - 152mm)
- 8" - 12" (203mm - 305mm)
- 14" - 16" (356mm - 407mm)

Standard Equipment:

Grooved Depth Gauge • Hydraulic Hand Pump • Rollers 1¼" - 16" • Shipping/Storage Box • Pipe Nipple and Stabilizer Bracket • Guards

PIPE PREP.
EQUIPMENT
& GROOVE
DATA

PIPE PREP. EQUIPMENT

Model 1041 • 1" – 12" Pipe

Roll Grooving Attachment for use with Rigid® 300 Pipe Threader

- Quickly converts your Rigid 300 Threader to a production roll groover.
- Mounts/dismounts easily on standard Model 300.

Model 1041 Specifications

Capacity: 1" - 6" SCH 40 (6mm)
1" - 12" SCH 10 (5mm)
2" - 6" Copper Tubing K, L, M and DWV

Maximum Pressure at Roller: 8000 psi

Shipping Weight: 94 lbs. (42.6 kgs)

Interchangeable Rollers:

Top Pipe Diameter:

- 1" - 6" (25mm - 152mm)
- 8" - 12" (203mm - 305mm)

Bottom Pipe Diameter:

- 1" - 1½" (25mm - 38mm)
- 2" - 6" (51mm - 152mm)
- 8" - 12" (203mm - 305mm)



Roll Grooving Attachment mounted on Rigid 300 Pipe Threader

Model 1010 • 1½" - 12" Pipe

Portable Roll Groover

Produces accurately rolled grooves in a wide range of pipe types-including newer varieties of thin-wall pipe. Use it in the shop or at the job site. Easily operated hydraulic hand pump delivers up to 8000 psi of rolling force to the pipe face. Pre-set depth gauge automatically controls depth of rolled groove. Pipe is rotated by means of a speed reducer driven by the unit's electric motor. The drive shaft and idler shaft are machined from Vacuum Melt Aircraft quality alloy steel to insure long service life. Easily interchangeable Top and Bottom Rollers (average time: less than 3 minutes) permits rapid change of pipe diameters with nominal set-up costs.

Shipped in a durable, reuseable hinged box.

Model 1010 Specifications

Capacity: 1½" - 6" SCH 40 (6mm)
1½" - 12" SCH 10 (5mm)

Pipe Rotation Speed: 30 RPM

Hydraulic Pressure at Roller: 8,000 psi. max.

Spindle Height from Floor: 33" (838mm)

Electric Motor: 1½ HP 60 Hz 110 V. 1 PH*

Floor Space Required: 32" x 32" (813mm x 813mm)

Shipping Weight: 300 lbs. (136 kgs)

Interchangeable Rollers:

Top Pipe Diameter:

- 1½" - 6" (38mm - 152mm)
- 8" - 12" (203mm - 305mm)

Bottom Pipe Diameter:

- 1½" (38mm)
- 2" - 3½" (51mm - 89mm)
- 4" - 6" (102mm - 152mm)
- 8" - 12" (203mm - 305mm)

*Other current characteristics available.

Standard Equipment:

Electric Motor • Groove Depth Gauge • Hydraulic Pump • Shipping/Storage Box •
Rolls as Specified in Price List • Guards • Foot Switch



Portable Roll Groover

PIPE PREP. EQUIPMENT

Model 1023 • 1¹/₄" – 24" Pipe

Portable Roll Groover

Portable Pipe Groover has been designed with a heavy-duty, high efficiency gear reducer. The helical inline gear reducer with only 5 percent energy loss, will allow grooving 1¹/₄" - 24" with a 110 volt electrical service. The hand hydraulic pump applies up to 16,000 psi at the point of roll grooving to produce accurate grooves for quick installation of pipe couplings. Use it at the job site or in the shop. Top and bottom rollers are easily interchanged to handle a wide range of pipe diameters. Additional roll sets are available for copper tube grooving and also flush seal gasket dimensions.



Portable Roll Groover

Model 1023 Specifications

Capacity: 1¹/₄" - 12" SCH 40 (10mm)
12" - 24" Standard Wall 0.375 (9.5mm)
2" - 6" Copper Tubing K, L, M and DWV

Spindle Speed: 30 RPM

Hydraulic Pressure at Roller: 16,000 psi. max.

Spindle Height from Floor: 33" (838mm)

Electric Motor: 1¹/₂ HP 60 Hz 110 V. 1 PH

Floor Space Required: 31¹/₂" x 33¹/₂" (800mm x 857mm)

Shipping Weight: 430 lbs.

Interchangeable Rollers:

Top Pipe Diameter:

- 1¹/₄" - 1¹/₂" (32mm - 38mm)
- 2" - 3¹/₂" (51mm - 89mm)
- 4" - 6" (102mm - 152mm)
- 8" - 12" (203mm - 305mm)
- 14" - 16" (356mm - 407mm)
- 18" - 24" (457mm - 610mm)

Bottom Pipe Diameter:

- 1¹/₄" - 1¹/₂" (32mm - 38mm)
- 2" - 3¹/₂" (51mm - 89mm)
- 4" - 6" (102mm - 152mm)
- 8" - 12" (203mm - 305mm)
- 14" - 16" (356mm - 407mm)
- 18" - 24" (457mm - 610mm)

Standard Equipment:

Electric Motor • Grooved Depth Gauge • Hydraulic Hand Pump • Shipping/Storage Box • Rolls as Specified in Price List • Guards • Foot Switch

Model 4037 • 8" – 24" Pipe

Nipple Bracket

The Model 4037 Nipple Bracket was developed to permit safer, more efficient roll grooving of pipe too short to mount in a pipe stand. The plastic composition clamp-roller fixes the pipe nipple in a controlled, slightly eccentric position so that the pipe is held firmly against the back flange of the bottom roller as it rotates. Pipe nipples as short as 6" can be grooved using this tool, permitting high production rates without the need for manual positioning by shop personnel.

Model 4037 Specifications

Capacity: 8" - 24" Pipe
Fits Model 1023 Roll Groovers



Nipple Bracket

PIPE PREP.
EQUIPMENT
& GROOVE
DATA

PIPE PREP. EQUIPMENT

Model 2021 • 1¹/₄" – 24" Pipe

Automated Roll Groover

Six easily interchanged Top and Bottom Rollers give Model 2021 the versatility to meet virtually any piping system requirement. The self-contained hydraulic system provides up to 16,000 psi pressure at the point of roll grooving. Hydraulic pressure is adjustable to provide optimum grooving efficiency for all diameters and wall thicknesses within the machine's range. Model 2021 is shipped completely assembled with Top and Bottom Rollers 4" - 6" installed on machine.

Model 2021 Specifications

Capacity: 1¹/₄" - 12" SCH 40 (10mm)
 12" - 24" Standard Wall 0.375 (9.5mm)
 2" - 6" Copper Tubing K, L, M and DWV

Pipe Rotation Speed: 30 RPM

Hydraulic Pressure at Roller: 16,000 psi. max.

Spindle Height from Floor: 33" (838mm)

Electric Motor: 3 HP 60 Hz 220 V. 3 PH*

Hydraulic Pump Motor: 1 HP 60 Hz 220 V. 3 PH

Floor Space Required: 30" x 22" (762mm x 559mm)

Shipping Weight: 640 lbs. (290 kgs)

Interchangeable Rollers:

Top Pipe Diameter:

1¹/₄" - 1¹/₂" (32mm - 38mm)
 2" - 3¹/₂" (51mm - 89mm)
 4" - 6" (102mm - 152mm)
 8" - 12" (203mm - 305mm)
 14" - 16" (356mm - 407mm)
 18" - 24" (457mm - 610mm)

Bottom Pipe Diameter:

1¹/₄" - 1¹/₂" (32mm - 38mm)
 2" - 3¹/₂" (51mm - 89mm)
 4" - 6" (102mm - 152mm)
 8" - 12" (203mm - 305mm)
 14" - 16" (356mm - 407mm)
 18" - 24" (457mm - 610mm)

*Other current characteristics available.

Standard Equipment:

Electric Drive Motor • Limit Switch for Depth Gauging • Grooved Depth Gauge • Hydraulic Pump • Model 4037 Nipple Bracket • Rolls as Specified in Price List • Guards • Foot Switch



Automated Roll Groover

PIPE PREP. EQUIPMENT

Model 3013 • 1¹/₄" - 12" Pipe, up to 4¹/₂" dia. holes

Porta-Bore

- Solid alloy aluminum construction
 - Slide and gibbs are heat treated aluminum that is Teflon® coated to insure long life. Slide assembly is positioned together by gauge block machining. This assembly is located by dowelled gibbs that are precisely aligned with the V-block. There are no elongated holes which could allow missaligment.
 - Motor is a 10 Amp draw industrial drill motor with internal 4-speed gear box 110, 175, 245, 385 RPM. Spindle bore is a No. 3 Morse Taper.
 - Electrical panel meets the highest standard of operating safety. A circuit breaker assures no safety hazard to the operator or machine.
 - Arbor support design for use with Slugger cutters, or drill chuck for use with hole saws or drills.
 - Chain clamp is standard on all units and clamps to pipe diameters 1¹/₄" - 12"*
 - Optional speed toggle clamp, clamps to 1¹/₄" - 6" pipe*.
- * Both clamps ensure positive holding during hole cutting operations and can be used in any position.*
- Oil Feed - the arbor is designed with an oil reservoir for automatic gravity feed during the cutting operation in the vertical position.
 - Easy part replacement. Building block design allows easy part repair or replacement. (No need to ship machine out for repair.)



Porta-Bore

Model 3013 Specifications

- Heavy Duty - 42 lbs.; 110, 175, 245, 385 RPM.
- Cuts up to 4¹/₂" diameter holes in 1¹/₄" - 12" pipe.
- 110 volts 10 amps (220 volts available).

PIPE PREP. EQUIPMENT

Pipe Support Stands

Pipe support stands should always be used when rolling or cutting grooves in pipe. For cut grooving they are essential to keep the pipe level; for roll grooving, stands are adjusted to provide the slight downward pitch needed to keep the end of the pipe in firm contact with the back flange of the bottom roller.

MODEL 4031

Capacity: 1" - 4" Pipe; 600 lbs. max.

A 22" diameter base and 2" column give this stand plenty of strength for supporting any pipe in its size range. The Saddle has two roller bearings for free rotation of the pipe and absorbs vibration to ensure a smooth, uniform groove. Saddle height is adjustable over a 10" (254mm) range.

The two-roller-bearing saddle may be ordered alone as no. 4032 . Replacement roller bearing is no. 4025



MODEL 4000

Capacity: 2" - 8" Pipe; 900 lbs. max.

The base of this stand is the same as used in Model 4031, above. A Saddle with four roller bearings provides greater side support for the pipe and increased dampening of vibration without impairing the unit's free-rolling characteristics. Saddle height is adjustable over a 10" (254mm) range.

The four-roller-bearing saddle may be ordered alone as no. 4001. Replacement roller bearing is no. 4025



MODEL 4033

Capacity: 2" - 14" Pipe; 1200 lbs. max.

This extra heavy duty pipe support stand uses two 2" columns on a 22" diameter base to give it exceptional stability and resistance to vibration and pendulum effect. Each column incorporates a sturdy, threaded post, adjustable over a 10" (254mm) range. The saddle utilizes six roller bearings in an array that provides excellent support for all pipes in its size range.

Replacement roller bearing is no. 4025



PIPE PREP. EQUIPMENT

MINI-MITES™

Roll Groovers for handling the unexpected

Mini-Mite roll groovers allow you handle anything when you get on the job site. They're handy, portable job-site tools that can save you hours of waiting for pipe to come back from the shop. New design has roller bearing front and back on main shaft.

Model 1039

1 1/4" - 6" SCH 40, 2" - 8" Copper Tube

With ratchet hand crank, roll grooves 1 1/4" - 6", Schedule 40 or thin wall steel pipe on the scaffold or anywhere power is unavailable.

Capacity: 1 1/4" - 6" SCH 40 (7mm)
2" - 8" Copper Tube K, L, M and DWV

Model 1039 Mini-Mite Roll Groover service tool goes from in-place grooving and can be chucked in a Ridgid Model 300 in seconds with no gearbox removal.

Model 1039 Mini-Mite is self contained and can be entirely operated with its own multi-function crank so there are no other tools needed! All hex drives on Model 1039 Mini-Mite are 15/16", so one wrench fits everything.

Mini-Mites require no modifications or parts changes to groove any pipe or tubing in their size range.

Each comes with multi-step depth gauge.



MODEL 1034

1 1/4" - 6" SCH 40

Same capacity as the 1039, but is used with the Ridgid® Model 300 Threader for faster easier grooving.

Capacity: 1 1/4" through 6" SCH 40 (7mm)



MODEL 1066

2" - 8" Copper Tube

Is also used with the Model 300, but is designed to groove 2" - 8" copper tube.

Capacity: 2" - 8" Copper Tube K, L, M and DWV



PIPE PREP.
EQUIPMENT
& GROOVE
DATA

GROOVE DATA

Roll Groove Standard Specification for Steel & Other IPS Pipe

- 1 – The maximum allowable tolerances for IPS Pipe from square cut ends is: 0.030" (0.76mm) for sizes 1 1/4" thru 3"; 0.045" (1.14mm) for sizes 4" thru 6"; and 0.060" (1.52mm) for sizes 8" and above.
- 2 – Gasket Seating Surface "A" must be free from score marks, ridges, indentations, projections, loose paint, scale, dirt chips, grease, rust, etc. that would prevent a positive seal.
- 3 – Groove Diameter "C" must be uniform depth around the circumference of the pipe.
- 4 – Groove Depth "D" is a reference dimension only. The Groove Diameter "C" must be maintained.
- 5 – Minimum Wall Thickness "T" is the minimum wall thickness that should be roll grooved.
- 6 – Maximum allowable pipe end flare diameter is measured at the pipe end diameter.

Tech Data: G710

Nominal Pipe Size Inches mm	Pipe O.D. Inches mm			A ±0.030" ±0.76mm Inches mm	B ±0.030" ±0.76mm Inches mm	C Groove Diameter Inches mm		D Groove Depth (ref. only) Inches mm	T Minimum Wall Inches mm	Maximum Allow Flare Diameter Inches mm
	O.D.	Tolerance				Actual	Tol.+0.000			
		+	-							
1 1/4 32	1.660 42.4	0.016 0.41	0.016 0.41	0.625 15.88	0.281 7.14	1.535 38.99	-0.015 -0.38	0.062 1.60	0.065 1.65	1.77 44.96
1 1/2 40	1.900 48.3	0.019 0.48	0.019 0.48	0.625 15.88	0.281 7.14	1.775 45.09	-0.015 -0.38	0.062 1.60	0.065 1.65	2.01 51.05
2 50	2.375 60.3	0.024 0.61	0.024 0.61	0.625 15.88	0.344 8.74	2.250 57.15	-0.015 -0.38	0.062 1.60	0.065 1.65	2.48 62.99
2 1/2 65	2.875 73.0	0.029 0.74	0.029 0.74	0.625 15.88	0.344 8.74	2.720 69.09	-0.018 -0.46	0.078 1.98	0.083 2.11	2.98 75.69
76.1mm	3.000 76.1	0.030 0.76	0.030 0.76	0.625 15.88	0.344 8.74	2.845 72.26	-0.018 -0.46	0.076 1.93	0.083 2.11	3.10 78.74
3 80	3.500 88.9	0.035 0.89	0.031 0.79	0.625 15.88	0.344 8.74	3.344 84.94	-0.018 -0.46	0.078 1.98	0.083 2.11	3.60 91.44
108.0mm	4.250 108.0	0.043 1.09	0.031 0.79	0.625 15.88	0.344 8.74	4.084 103.73	-0.020 -0.51	0.083 2.11	0.083 2.11	4.35 110.49
4 100	4.500 114.3	0.045 1.14	0.031 0.79	0.625 15.88	0.344 8.74	4.334 110.08	-0.020 -0.51	0.083 2.11	0.083 2.11	4.60 116.84
133.0mm	5.250 133.4	0.053 1.35	0.031 0.79	0.625 15.88	0.344 8.74	5.084 129.13	-0.022 -0.56	0.083 2.11	0.109 2.77	5.35 135.89
139.7mm	5.500 139.7	0.056 1.42	0.031 0.79	0.625 15.88	0.344 8.74	5.334 135.48	-0.022 -0.56	0.083 2.11	0.109 2.77	5.60 142.24
5 125	5.563 141.3	0.056 1.42	0.031 0.79	0.625 15.88	0.344 8.74	5.395 137.03	-0.022 -0.56	0.084 2.13	0.109 2.77	5.66 143.76
159.0mm	6.250 159.0	0.063 1.60	0.031 0.79	0.625 15.88	0.344 8.74	6.084 154.53	-0.030 -0.76	0.083 2.11	0.109 2.77	6.35 161.29
165.1mm	6.500 165.1	0.063 1.60	0.031 0.79	0.625 15.88	0.344 8.74	6.330 160.78	-0.022 -0.56	0.085 2.16	0.109 2.77	6.60 167.64
6 150	6.625 168.3	0.063 1.60	0.031 0.79	0.625 15.88	0.344 8.74	6.455 163.96	-0.022 -0.56	0.085 2.16	0.109 2.77	6.73 170.94
216.3mm	8.516 216.3	0.063 1.60	0.031 0.79	0.750 19.05	0.469 11.91	8.331 211.61	-0.025 -0.64	0.092 2.34	0.109 2.77	8.69 220.73
8 200	8.625 219.1	0.063 1.60	0.031 0.79	0.750 19.05	0.469 11.91	8.441 214.40	-0.025 -0.64	0.092 2.34	0.109 2.77	8.80 223.52
10 250	10.750 273.0	0.063 1.60	0.031 0.79	0.750 19.05	0.469 11.91	10.562 268.27	-0.027 -0.69	0.094 2.39	0.134 3.40	10.92 277.37
12 300	12.750 323.9	0.063 1.60	0.031 0.79	0.750 19.05	0.469 11.91	12.531 318.19	-0.030 -0.76	0.109 2.77	0.156 3.96	12.92 328.17
14 350	14.000 355.6	0.063 1.60	0.031 0.79	0.938 23.83	0.469 11.91	13.781 350.04	-0.30 -0.76	0.109 2.77	0.156 3.96	14.10 358.14
16 400	16.000 406.4	0.063 1.60	0.031 0.79	0.938 23.83	0.469 11.91	15.781 400.84	-0.30 -0.76	0.109 2.77	0.165 4.19	16.10 408.94
18 450	18.000 457.2	0.063 1.60	0.031 0.79	1.000 25.40	0.469 11.91	17.781 451.64	-0.30 -0.76	0.109 2.77	0.165 4.19	18.16 461.26
20 500	20.000 508.0	0.063 1.60	0.031 0.79	1.000 25.40	0.469 11.91	19.781 502.44	-0.30 -0.76	0.109 2.77	0.188 4.78	20.16 512.06
24 600	24.000 609.6	0.063 1.60	0.031 0.79	1.000 25.40	0.500 12.70	23.656 600.86	-0.30 -0.76	0.172 4.37	0.218 5.54	24.20 614.68

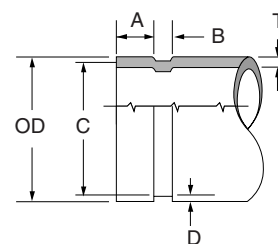

PIPE PREP.
EQUIPMENT
& GROOVE
DATA

Please refer to General Notes on page 14.

GROOVE DATA

Cut Groove Standard Specification for Steel & Other IPS Pipe

- 1 – The maximum allowable tolerances for IPS Pipe from square cut ends is: 0.030" (0.76mm) for sizes 1¹/₄" thru 3"; 0.045" (1.14mm) for sizes 4" thru 6"; and 0.060" (1.52mm) for sizes 8" and above.
- 2 – Gasket Seating Surface "A" must be free from score marks, ridges, indentations, projections, loose paint, scale, dirt chips, grease, rust, etc. that would prevent a positive seal.
- 3 – Groove Diameter "C" must be uniform depth around the circumference of the pipe.
- 4 – Groove Depth "D" is a reference dimension only. The Groove Diameter "C" must be maintained.
- 5 – Minimum Wall Thickness "T" is the minimum wall thickness that should be cut grooved.

Tech Data: G710

Nominal Pipe Size Inches mm	Pipe O.D. Inches mm			A ±0.030" ±0.76mm Inches mm	B ±0.030" ±0.76mm Inches mm	C Groove Diameter Inches mm		D Groove Depth (ref. only) Inches mm	T Minimum Wall Inches mm
	O.D.	Tolerance				Actual	Tol.+0.000		
		+	-						
1 ¹ / ₄ 32	1.660 42.4	0.016 0.41	0.016 0.41	0.625 15.88	0.313 7.95	1.535 38.99	-0.015 -0.38	0.062 1.60	0.062 1.60
1 ¹ / ₂ 40	1.900 48.3	0.019 0.48	0.019 0.48	0.625 15.88	0.313 7.95	1.775 45.09	-0.015 -0.38	0.062 1.60	0.062 1.60
2 50	2.375 60.3	0.024 0.61	0.024 0.61	0.625 15.88	0.313 7.95	2.250 57.15	-0.015 -0.38	0.062 1.60	0.062 1.60
2 ¹ / ₂ 65	2.875 73.0	0.029 0.74	0.029 0.74	0.625 15.88	0.313 7.95	2.720 69.09	-0.018 -0.46	0.078 1.98	0.078 1.98
76.1mm	3.000 76.1	0.030 0.76	0.030 0.76	0.625 15.88	0.313 7.95	2.845 72.26	-0.018 -0.46	0.076 1.93	0.076 1.93
3 80	3.500 88.9	0.035 0.89	0.031 0.79	0.625 15.88	0.313 7.95	3.344 84.94	-0.018 -0.46	0.078 1.98	0.078 1.98
108.0mm	4.250 108.0	0.042 1.07	0.031 0.79	0.625 15.88	0.375 9.53	4.084 103.73	-0.020 -0.51	0.083 2.11	0.083 2.11
4 100	4.500 114.3	0.045 1.14	0.031 0.79	0.625 15.88	0.375 9.53	4.334 110.08	-0.020 -0.51	0.083 2.11	0.083 2.11
133.0mm	5.250 133.4	0.052 1.32	0.031 0.79	0.625 15.88	0.375 9.53	5.084 129.13	-0.020 -0.51	0.083 2.11	0.083 2.11
139.7mm	5.500 139.7	0.056 1.42	0.031 0.79	0.625 15.88	0.375 9.53	5.334 135.48	-0.020 -0.51	0.083 2.11	0.083 2.11
5 125	5.563 141.3	0.056 1.42	0.031 0.79	0.625 15.88	0.375 9.53	5.395 137.03	-0.022 -0.56	0.084 2.13	0.084 2.13
159.0mm	6.250 159.0	0.063 1.60	0.031 0.79	0.625 15.88	0.375 9.53	6.084 154.53	-0.022 -0.56	0.083 2.11	0.083 2.11
165.1mm	6.500 165.1	0.063 1.60	0.031 0.79	0.625 15.88	0.375 9.53	6.330 160.78	-0.022 -0.56	0.085 2.16	0.085 2.16
6 150	6.625 168.3	0.063 1.60	0.031 0.79	0.625 15.88	0.375 9.53	6.455 163.96	-0.022 -0.56	0.085 2.16	0.085 2.16
216.3mm	8.516 216.3	0.063 1.60	0.031 0.79	0.750 19.05	0.438 11.13	8.331 211.61	-0.025 -0.64	0.092 2.34	0.092 2.34
8 200	8.625 219.1	0.063 1.60	0.031 0.79	0.750 19.05	0.438 11.13	8.441 214.40	-0.025 -0.64	0.092 2.34	0.092 2.34
10 250	10.750 273.0	0.063 1.60	0.031 0.79	0.750 19.05	0.500 12.70	10.562 268.27	-0.027 -0.69	0.094 2.39	0.094 2.39
12 300	12.750 323.9	0.063 1.60	0.031 0.79	0.750 19.05	0.500 12.70	12.531 318.19	-0.030 -0.76	0.109 2.77	0.109 2.77
14 350	14.000 355.6	0.063 1.60	0.031 0.79	0.938 23.83	0.500 12.70	13.781 350.04	-0.30 -0.76	0.109 2.77	0.281 7.14
16 400	16.000 406.4	0.063 1.60	0.031 0.79	0.938 23.83	0.500 12.70	15.781 400.84	-0.30 -0.76	0.109 2.77	0.312 7.92
18 450	18.000 457.2	0.063 1.60	0.031 0.79	1.000 25.40	0.500 12.70	17.781 451.64	-0.30 -0.76	0.109 2.77	0.312 7.92
20 500	20.000 508.0	0.063 1.60	0.031 0.79	1.000 25.40	0.500 12.70	19.781 502.44	-0.30 -0.76	0.109 2.77	0.312 7.92
24 600	24.000 609.6	0.063 1.60	0.031 0.79	1.000 25.40	0.562 14.27	23.656 600.86	-0.30 -0.76	0.172 4.37	0.375 9.53

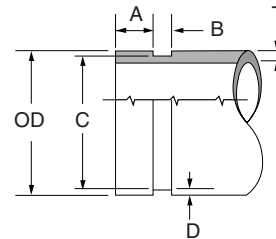

PIPE PREP.
EQUIPMENT
& GROOVE
DATA

Please refer to General Notes on page 14.

GROOVE DATA

Roll Groove Standard Specification for Copper Tubing

- 1 – Nominal Tubing, ASTM B-88 drawn copper tubing size.
- 2 – Outside Diameter "OD", of roll grooved tubing shall not vary more than the tolerance listed. The maximum tolerance from square cut ends is: 0.030" (0.76mm) for sizes 2" – 3" (54.0 – 79.4mm); 0.045" (1.14mm) for sizes 4" – 6" (104.8 – 155.6mm); measured from true square line.
- 3 – Gasket Seating Surface "A", must be free from roll marks, indentations, projections, loose scale, dirt, chips, grease, etc. that would prevent a positive seal.
- 4 – Groove Width Bottom, to be free of loose dirt, chips and scale that may interfere with proper coupling assembly.
- 5 – The Groove Diameter "C", must be uniform in depth for the entire circumference of the tubing. Groove must be maintained within the tolerance listed.
- 6 – Groove Depth "D", is a reference dimension only. The Groove Diameter "C" must be maintained.
- 7 – Minimum Wall Thickness "T", per ASTM B-306 drain waste and vent (DWV) is minimum wall thickness copper tubing, which may be, roll grooved.
- 8 – Maximum flare diameter is the OD at the most extreme tubing diameter.

Tech Data: G720

Nominal Tubing Size Inches mm	Tubing O.D. Inches mm			A ±0.030" ±0.76mm Inches mm	B ±0.030" ±0.76mm Inches mm	C Groove Diameter Inches mm		D Nominal Groove Depth Inches mm	T Minimum Wall Thickness Inches mm	Maximum Flare Diameter Inches mm
	O.D.	Tolerance				Actual	Tol.+0.000			
		+	-							
2"	2.125 54.0	0.002 0.05	0.002 0.05	0.610 15.5	0.300 7.6	2.029 51.5	-0.020 -0.51	0.048 1.2	0.064 1.6	2.220 56.4
2½"	2.625 66.7	0.002 0.05	0.002 0.05	0.610 15.5	0.300 7.6	2.525 64.1	-0.020 -0.51	0.050 1.2	0.065 1.7	2.720 69.1
3"	3.125 79.4	0.002 0.05	0.002 0.05	0.610 15.5	0.300 7.6	3.025 76.8	-0.020 -0.51	0.050 1.2	DWV	3.220 81.8
4"	4.125 104.8	0.002 0.05	0.002 0.05	0.610 15.5	0.300 7.6	4.019 102.1	-0.020 -0.51	0.053 1.4	DWV	4.220 107.2
5"	5.125 130.2	0.002 0.05	0.002 0.05	0.610 15.5	0.300 7.6	4.999 127.0	-0.020 -0.51	0.053 1.4	DWV	5.220 132.6
6"	6.125 155.6	0.002 0.05	0.002 0.05	0.610 15.5	0.300 7.6	5.999 152.3	-0.020 -0.51	0.063 1.6	DWV	6.220 158.0
8"	8.125 206.4	0.002 0.05	0.004 0.10	0.610 15.5	0.300 7.6	7.959 202.2	-0.020 -0.51	0.083 2.1	DWV	8.220 208.8

Tolerances for 8" (206.4mm) are +0.002 (0.5mm); -0.004 (-0.10mm).

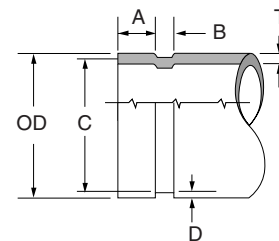

See Tyco Fire & Building Products
Publication TFP1800

Pressure & Design Data

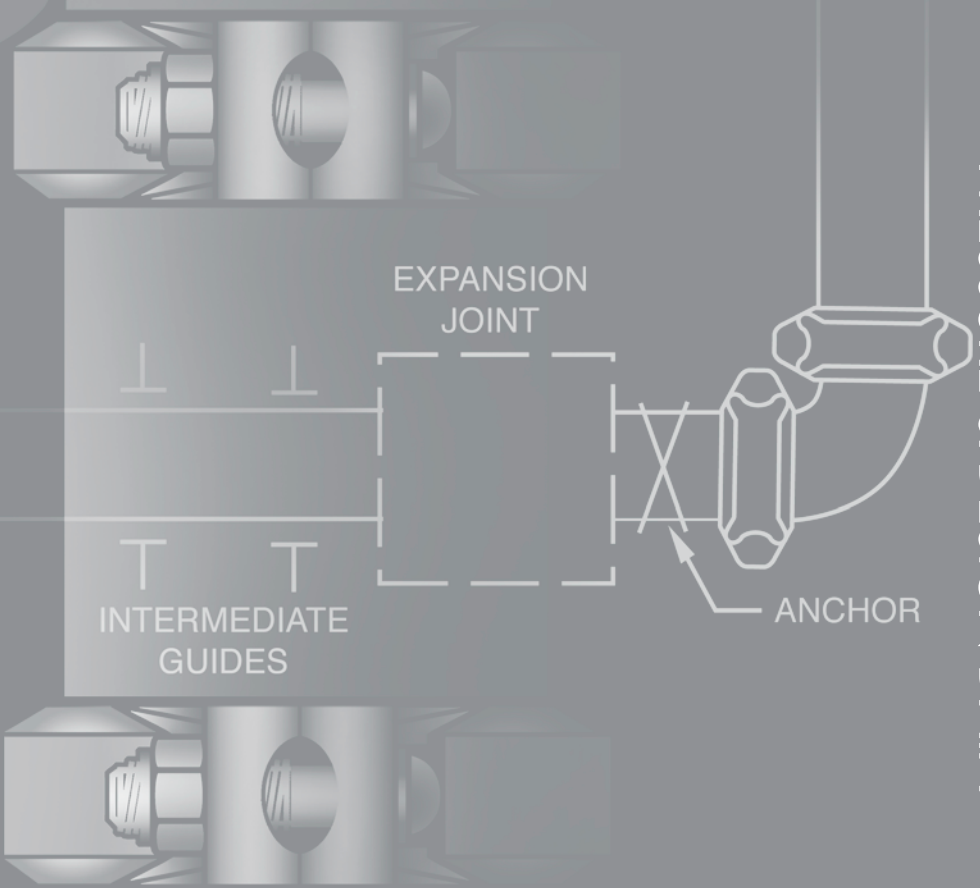

PRESSURE & DESIGN DATA



DESIGN DATA

Tech Data: G820

RIGID JOINTS

Grinnell® Rigid Couplings provide rigid gripping of the pipe. They are designed to bring the pipe ends closely together and the coupling clamps firmly onto the pipe OD and also into the bottom of the grooves. Because Rigid Couplings clamp around the entire pipe surface, they provide resistance to flexural and torsional loads and therefore permit longer spacing to ASME/ANSI B31.1 (Power Piping) and ASME/ANSI B39.1 (Building Services) requirements.



FLEXIBLE JOINTS

Grinnell Flexible Couplings act as an “expansion joint”, allowing linear and angular movement of the pipe. They are designed with the coupling keys engaging the pipe without gripping on the bottom of the grooves, while still providing for a restrained mechanical joint. This is particularly useful to allow for pipe expansion / contraction and piping misalignment.



LINEAR MOVEMENT (Flexible Couplings)

For thermal expansion with flexible couplings, the pipe ends at each joint should be fully gapped to the maximum end gap. This can be accomplished by pressurizing the system and then anchoring the system.

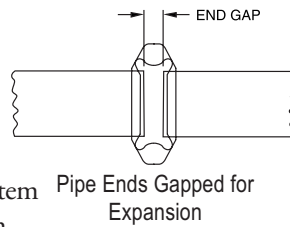

For design purposes, the maximum pipe end gap should be reduced to account for field practices as follows:

End Gap Reduction	
Pipe Size Inches mm	Maximum Pipe End Gap Reduction
1 1/4 - 3 42.4 - 88.9	50%
4 - 24 114.3 - 610.0	25%

For thermal contraction with flexible couplings, the pipe ends at each joint should be fully butted. The system can then be anchored in place to prevent the pipe ends from opening up to the maximum end gap when pressurized.

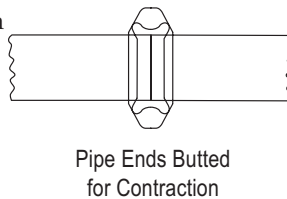

Therefore the following values should be used as available pipe end movements for Grinnell Figure 705, 707 and 716 Flexible Couplings:

Pipe End Movements		
Pipe Size Inches mm	Cut Grooved Inches mm	Roll Grooved* Inches mm
1 1/4 - 3 42.4 - 88.9	0 - 0.063 0 - 1.6	0 - 0.031 0 - 0.8
4 - 24 114.3 - 610.0	0 - 0.188 0 - 2.4	0 - 0.094 0 - 2.4

* Roll grooved joints provide 1/2 the available movement of cut grooved joints.

ANGULAR DEFLECTION

Grinnell® Flexible Couplings are capable of accommodating angular deflection.

The deflection published is a maximum value. For design purposes the maximum deflection should be reduced to account for field practices as shown:

Deflection	
Pipe Size Inches mm	Maximum Pipe Deflection Reduction
1 1/4 - 3 42.4 - 88.9	50%
4 - 24 114.3 - 610.0	25%

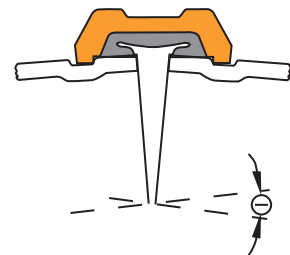

Expansion / Contraction

Grinnell Flexible Couplings are capable of accommodating pipe thermal movements provided they are properly gapped and a sufficient quantity of flexible couplings are used. Note that flexible couplings will not accommodate both full maximum linear movement and the maximum available angular deflection concurrently at the same joint.

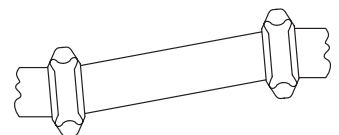

If it is desired to have both deflection and linear movement available, then the system should have sufficient flexible joints to accommodate the requirement.

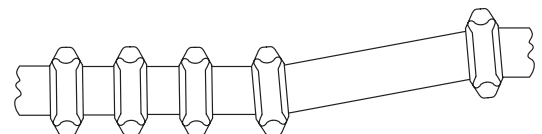

DESIGN DATA

THERMAL MOVEMENT

The following guidelines are similar to any expansion joint:

It is recommended that anchors be installed at changes of direction on the pipe lines to control the pipe movement. The thermal expansion / contraction in the piping system can be accommodated utilizing Grinnell® Flexible Couplings. In designing anchoring systems, it is suggested that the following be taken into consideration as a minimum:

- Pressure thrusts
- Frictional resistance of any guides or supports
- Centrifugal thrust due to velocity at changes of direction
- Activation force required to compress or expand a flexible coupling

Three methods are available as examples to accommodate thermal expansion/contraction:

1) Design the system with rigid couplings and place expansion joints at the proper locations. Expansion joints may be a series of flexible grooved couplings of a sufficient quantity to accommodate the movement.

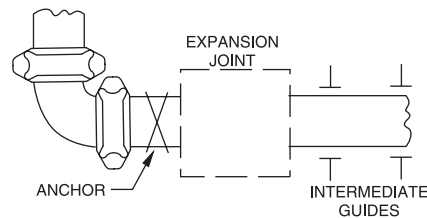

2) Design the system with flexible and/or rigid couplings and allow the pipe to move in directions desired, with the use of anchors and guides if so required. With this method, it is important to ensure that movement at branch connections, changes of direction, equipment hookup, etc., will not cause damage or harmful stresses.

3) Design the system with flexible couplings utilizing the expansion/contraction capabilities of these products.

The following example illustrates this method:

- 6" Schedule 40 Steel Pipe, Roll Grooved, 150' long, anchored at each end.
- Maximum Temperature = 200°F
- Minimum Temperature = 40°F
- Install Temperature = 80°F

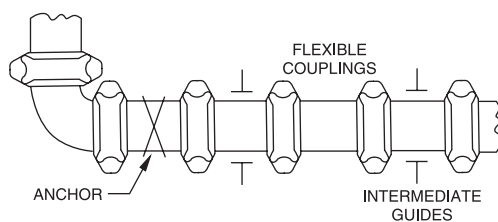

Activation Force	
Pipe Size Inches mm	Activation Force Lbs. N
1¼ 42.4	35 156
1½ 48.3	45 200
2 60.3	70 311
2½ 73.0	100 645
76.1mm	110 489
3 88.9	145 645
4 114.3	240 1068
5 139.7, 141.3	375 1668
165.1mm	500 2224
6 168.3	520 2313
8 219.1	880 3914
10 273.0	1365 6072
12 323.9	1915 8518

DESIGN DATA

THERMAL MOVEMENT

To calculate the number of couplings required in this example to compensate for the Thermal Expansion and Contraction of the pipe:

1) Thermal Contraction

Utilize the Thermal Expansion Table. Allowance for installation temperature to the minimum temperature, in this case 80°F to 40°F is calculated as:

$$80^{\circ}\text{F} = 0.61" \text{ per } 100'$$

$$40^{\circ}\text{F} = 0.30" \text{ per } 100'$$

$$\text{Difference} = 0.31" \text{ per } 100'$$

$$\text{For } 150' \text{ of pipe} = 0.31" \times 1.5 = 0.47" \text{ per } 150'$$

2) Thermal Expansion

Utilize the Thermal Expansion Table. Allowance for installation temperature to the minimum temperature, in this case 80°F to 200°F is calculated as:

$$200^{\circ}\text{F} = 1.52" \text{ per } 100'$$

$$80^{\circ}\text{F} = 0.61" \text{ per } 100'$$

$$\text{Difference} = 0.91" \text{ per } 100'$$

$$\text{For } 150' \text{ of pipe} = 0.91" \times 1.5 = 1.36" \text{ per } 150'$$

Thermal Expansion of Carbon Steel in Inches/100 Feet (Millimeters/30.5Meters) Between 0°F (-18°C) & Indicated Temperature

Temperature F° (C°)	Inches/100 Feet (mm/30.5M)
-40 (-40)	-0.30 (-7.62)
-30 (-34.4)	-0.23 (-5.84)
-20 (-28.9)	-0.15 (-3.81)
-10 (-23.3)	-0.08 (-2.03)
0 (-17.8)	0.00 (0.00)
10 (-12.2)	0.08 (2.03)
20 (-6.7)	0.15 (3.81)
30 (-1.1)	0.23 (5.84)
40 (4.4)	0.30 (7.62)
50 (10.0)	0.38 (9.65)
60 (15.6)	0.46 (11.68)
70 (21.1)	0.53 (13.46)
80 (26.7)	0.61 (15.50)
90 (32.2)	0.68 (17.27)
100 (37.8)	0.76 (19.30)
110 (43.3)	0.84 (21.34)
120 (48.9)	0.91 (23.11)
130 (54.4)	0.99 (25.15)
140 (60.0)	1.06 (26.92)
150 (65.6)	1.14 (28.96)
160 (71.1)	1.22 (30.99)
170 (76.7)	1.29 (32.77)
180 (82.2)	1.37 (34.80)
190 (87.8)	1.44 (36.58)
200 (93.3)	1.52 (38.61)
210 (98.9)	1.60 (40.64)
220 (104.4)	1.67 (42.42)
230 (110.0)	1.75 (44.45)

Mean Coef. of thermal expansion = 0.00000633 in/in/°F
Source: ASME B31.9

3) Couplings Required

Available linear movement for a 6" Figure 707 Flexible Couplings on roll grooved pipe = 0.094" per coupling.

a) Fully Butted Together for Contraction Only
Therefore the number of flexible Figure 707 Couplings required:

- $0.47" / 0.094" \text{ per coupling} = 5.0$
- Use 5 Figure 707 Couplings for pipe contraction

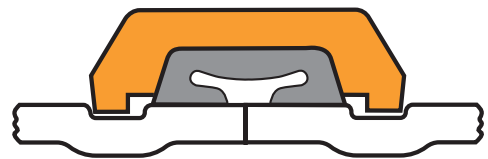

b) Fully Gapped Apart for Expansion Only
Therefore the number of flexible Figure 707 Couplings required:

- $1.36" / 0.094" \text{ per coupling} = 14.47$
- Use 15 Figure 707 Couplings for pipe expansion



DESIGN DATA

MISALIGNMENT AND DEFLECTION

Grinnell® flexible couplings provide for restrained joints and allow for deflection to aid where the pipe or equipments is misaligned.

Note that flexible couplings will not accommodate both full maximum linear movement and the maximum available angular deflection concurrently at the same joint.

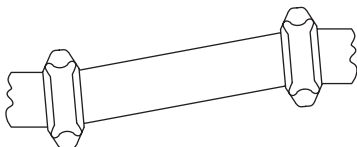

If it is desired to have both deflection and linear movement available, then the system should have sufficient flexible joints to accommodate the requirement.

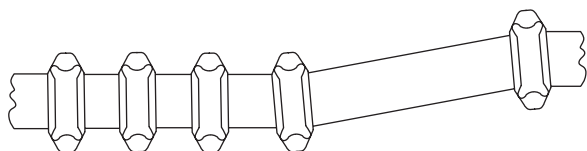

Flexible couplings are also useful in laying out curved piping systems.

$$R = \frac{L}{(2) \left(\sin \frac{\ominus}{2} \right)}$$

$$L = (2) (R) \left(\sin \frac{\ominus}{2} \right)$$

$$N = \frac{T}{\ominus}$$

R = Radius of curve

L = Pipe length

\ominus = Deflection from centerline, in degrees, for each coupling (see table)

N = Number of flexible couplings needed

T = Total deflection, in degrees, required

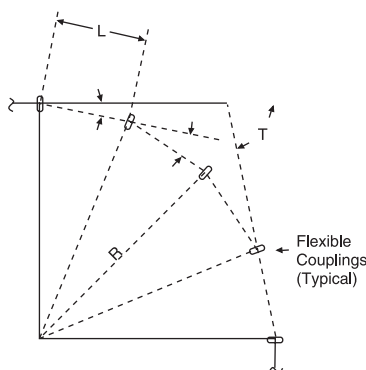

Design Deflection for Roll Grooved Pipe

Deflection \ominus (Roll Grooved Pipe)	
Pipe Size Inches <i>mm</i>	Figures 705 & 707
1 ¹ / ₄ 42.4	1.08°
1 ¹ / ₂ 48.3	0.94°
2 60.3	0.75°
2 ¹ / ₂ 73.0	0.62°
76.1mm	0.60°
3 88.9	0.51°
4 114.3	1.19°
5 139.7, 141.3	0.97°
165.1mm	0.83°
6 168.3	0.81°
8 219.1	0.63°
10 273.0	0.50°
12 323.9	0.42°

Incorporates the recommended safety factor reduction for field practices (50% for sizes 1¹/₄" - 3" and 25% for sizes 4" - 12").

DESIGN DATA

PIPE SUPPORT

All piping systems require that the support system accommodate the weight of the pipe, joint connections, fluid and other system components. In addition, consideration may be necessary in reducing stresses, accommodating thermal expansion or contraction, building settlement, seismic movement, etc. The following tables provide guidelines for grooved steel piping products without concentrated loads between supports.

Flexible Joints

For pipe runs when linear movement is accommodated by the flexible coupling:

Pipe Size Inches <i>mm</i>	Number of Hangers Per Pipe Length							
	Pipe Length in Feet/Meters							
	10 3.3	12 3.7	15 4.6	22 6.7	25 7.6	30 9.1	35 10.7	40 12.2
	Avg. Hangers Per Pipe Length							
1 1/4 - 2 42.4 - 60.3	2	2	2	3	4	4	5	6
2 1/2 - 4 73.0 - 114.3	1	2	2	2	2	3	4	4
5 - 24 139.7 - 609.6	1	1	2	2	2	3	3	3

For pipe runs when linear movement is not required:

Distance Between Supports	
Nominal Size Inches <i>mm</i>	Maximum Distance Between Supports Feet <i>Meters</i>
1 1/4 - 1 1/2 42.4 - 48.3	12 3.7
2 - 8 60.3 - 219.1	15 4.6
10 - 12 273.0 - 323.9	16 4.9
14 - 16 355.6 - 406.4	18 5.5
18 - 24 457.2 - 609.6	20 6.1

Note: The requirements of ANSI, ASME or other code groups may require additional supports.

Rigid Joints

For pipe runs with rigid couplings:

Pipe Size Inches <i>mm</i>	Suggested Maximum Span Between Supports - Meters/Feet			
	Water Service		Air Service	
	I	II	I	II
1 1/4 42.4	7 2.1	11 3.4	9 2.7	11 3.4
1 1/2 48.3	7 2.1	12 3.7	9 2.7	13 4.0
2 60.3	10 3.0	13 4.0	13 4.0	15 4.6
2 1/2 73.0	11 3.4	14 4.3	14 4.3	16 4.9
76.1mm	11 3.4	14 4.3	14 4.3	16 4.9
3 88.9	12 3.7	15 4.6	15 4.6	17 5.2
4 114.3	14 4.3	17 5.2	17 5.2	21 6.4
5 141.3	16 4.9	19 5.8	20 6.1	24 7.3
165.1mm	17 5.2	20 6.1	21 6.4	25 7.6
6 168.3	17 5.2	20 6.1	21 6.4	25 7.6
8 219.1	19 5.8	21 6.4	24 7.3	28 8.5
10 273.0	19 5.8	21 6.4	24 7.3	31 9.4
12 323.9	23 7.0	21 6.4	30 9.1	33 10.1
14 355.6	23 7.0	21 6.4	30 9.1	33 10.1
16 406.4	27 8.2	21 6.4	35 10.7	33 10.1
18 457.2	27 8.2	21 6.4	35 10.7	33 10.1
20 508.0	30 9.1	21 6.4	39 11.9	33 10.1
24 609.6	32 9.8	21 6.4	42 12.8	33 10.1

I - Spacing by ANSI B31.1 Power Piping Code

II - Spacing by ANSI B39.1 Building Piping Code

DESIGN DATA

ROTATIONAL MOVEMENT

Grinnell® flexible couplings are suitable for use in seismic as well as mining applications. The inherent capability of the flexible coupling to allow for linear movement, angular deflection, and rotational movement, make it an excellent choice for reducing stresses in a piping system and to increase pipe life in slurry applications.

For mining applications where the pipe needs to be rotated, the system should be depressurized. The pipe couplings bolts/nuts can be loosened, pipe rotated and the bolts/nuts re-tightened and the system be put back in service.

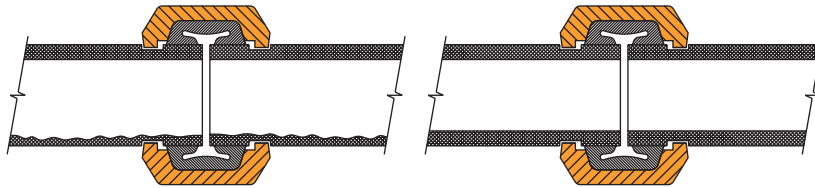

Even distribution of pipe wear can be achieved with this method on the inner service of the pipe.

Note: Precautions are necessary to monitor pipe wall thickness to evaluate pressure capability of the pipe with reduced wall.

LINEAR MOVEMENT

Flexible couplings are designed with the couplings keys engaging the pipe without gripping on the bottom of the groove while still providing for a restrained mechanical joint.



The inherent flexibility of the coupling must be considered when deciding on support arrangements for the piping system as movement can occur in more than one plane (linear movement, angular deflection and rotational movement).

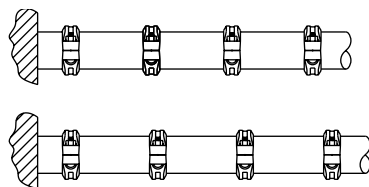

Upon system pressurization, each pipe end within the flexible couplings will expand to the maximum published value. The coupling keys make contact with the face of the groove and restrain the joint. In piping systems, this movement will be accumulative.

DESIGN DATA

ANGULAR MOVEMENT

System movement can be accommodated by providing for sufficient offset lengths. Temperature increases/decreases can further increase this movement.

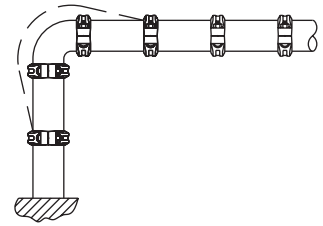

When systems are anchored with partially deflected joints, the system can move to the fully deflected condition upon pressurization resulting in the “snaking” of the piping system. Light weight hangers may not be suitable to prevent the lateral motion.

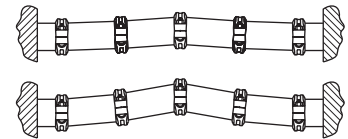

PIPE SUPPORT

Pipe hanger positioning is important when considering pipe “sagging” due to the flexible nature of the piping system. Proper positioning of hangers near the elbow, for example, should be considered.

The use of spring hangers or other methods can be considered to accommodate vibrations. Base supports, pressure thrust anchors and pipe offsets can be used to direct pipe movement.

The use of rigid couplings can be considered to reduce the movement available with flexible couplings. Consideration to other methods of accommodation of pipe movements may be required.

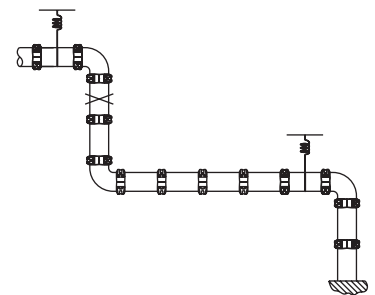
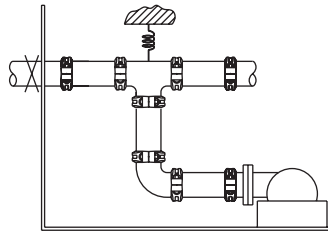
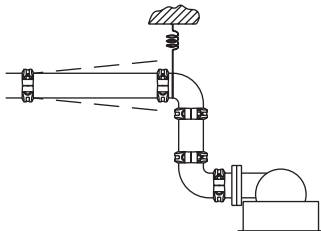
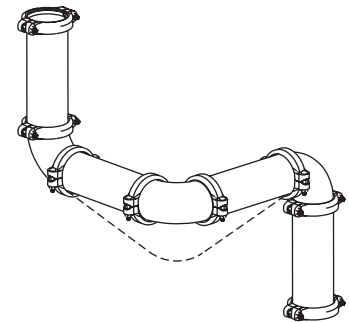

DESIGN DATA

VERTICAL PIPING

Risers comprised of rigid couplings can be considered similar to welded or flanged systems. Where thermal movement exists, expansion joints and/or flexible couplings with offsets may be required.

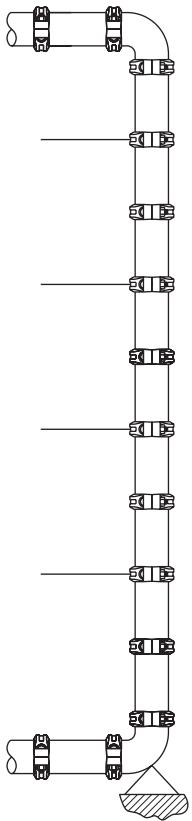
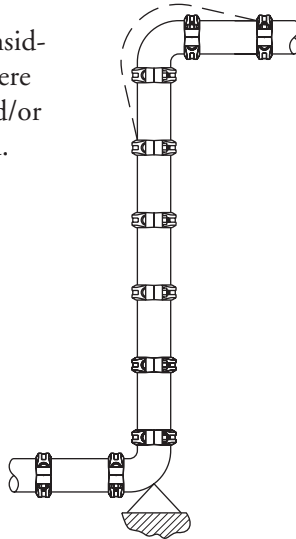

When using flexible couplings, the movement that occurs in long lengths of piping needs to be considered. Each joint can move up to the maximum pipe end separation published. This movement can accumulate and result in the growth of the piping system, for example, at the top. Offsets may be necessary.

Should the riser contain branch connections, the movement which occurs at these locations with flexible couplings, will also need to be considered.

One solution would be to anchor the vertical piping at appropriate locations to prevent movement which can cause stresses at the branches or equipment. The use of rigid couplings can be an advantage.

As always, good piping practice should prevail. It is the Designer's responsibility to select products suitable for the intended service and to ensure that pressure ratings and performance data is not exceeded. Never remove any piping component nor correct or modify any piping deficiencies without first depressurizing and draining the system. Material and gasket selection should be verified to be compatible for the specific application.

TYPICAL GENERAL & GUIDE SPECIFICATIONS

TYPICAL GENERAL SPECIFICATION

(CSI - Div. 15, Section A Info., Methods, & Instructions)

SECTION 1 - GROOVED PIPING METHOD

Grinnell® mechanical pipe couplings, grooved end fittings, grooved end butterfly and check valves, and other system components as manufactured or supplied by Tyco Fire & Building Products shall be used to install piping systems and make mechanical equipment connections in systems within specified operating conditions; and working pressures as shown in the coupling manufacturer's product specification. Grinnell mechanical pipe couplings shall be used for the following systems (subject to applicable local code approval).

PLUMBING

Domestic Hot Water
Domestic Cold Water
Roof Drains/Storm Drains

HEATING / AIR CONDITIONING

Chilled Water	Hot Water
Condenser Water	Heating
Cooling Tower	Dual Temperature
Machinery Room	Utility Water

OTHER

Vacuum	Lubrication
Air	Pneumatic Conveyor
Elevator Hydraulic	Low Temperature

TYPICAL GUIDE SPECIFICATION

Basic Materials & Methods (CSI - Div. 15 Section 15050)

SECTION 1 - MATERIALS - PIPE & PIPE FITTINGS

- 1.1 Pipe** - Pipe shall conform to Grinnell published tolerance specifications. Steel pipe shall be black or galvanized, conforming to ASTM A-135, A-795 or A-53.
- 1.2 Couplings** - Couplings shall be Grinnell Figures 705, 707, 772 and 716 cast in ductile iron as specified in ASTM A-536. Couplings shall have nuts and bolts. Couplings shall be coated with a lead free paint as standard, or hot-dipped galvanized in accordance with ASTM A-153 as an option.

Couplings shall be Grinnell Figures 405 and 472 cast in Stainless Steel as specified in ASTM A-743/A-743M. Couplings shall have nuts and bolts.

- 1.2.1 Gaskets** - Gaskets shall be a pressure responsive design, molded of synthetic elastomer as designated by ASTM D-2000, and shall conform to the coupling housing and pipe outside diameter. Reference shall be made to the latest published Grinnell gasket selection guide for proper gasket selection for the intended service.

- 1.2.1.1 Water Service** - Gasket shall be Grade "E" EPDM with green color code identification, for service temperatures from -30°F (-34°C) to 230°F (110°C). Recommended for hot water not to exceed 230°F (110°C), plus a variety of dilute acids, oil free air and many chemical services.

Not recommended for petroleum services or steam.

- 1.2.1.2 Oil Service** - Gasket shall be grade "T" Nitrile with orange color code identification, for service temperatures from -20°F (-29°C) to 180°F (82°C). Recommended for petroleum products, vegetable oils, mineral oils, and air with oil vapors.

- 1.2.1.3 Other Services** - Refer to the latest published Grinnell gasket selection guide for other service recommendations.

- 1.2.2 Bolts and Nuts** - Shall be heat treated carbon steel, oval-neck track head bolts and heavy hex nuts, conforming to the physical properties of ASTM A-183 with a minimum tensile strength of 110,000 psi. Bolts and nuts shall be zinc electroplated.

- 1.3 Flanges** - Shall be Grinnell Figure 71 Flange, casting in ductile iron in accordance with ASTM A-536. Flange shall conform to ANSI Class 125 and 150 bolt patterns and shall be coated with a lead-free paint as standard, or hot dipped galvanized in accordance to ASTM A-153.
- 1.4 Fittings** - Shall be ASTM A-536 ductile iron or fabricated from steel pipe, 1 1/4" (32mm) - 24" (600mm). All fittings shall be coated with a lead-free paint as standard, or hot-dipped galvanized as an option in accordance to ASTM A-153.
- 1.5 Branch Outlets** - Shall be Grinnell Figure 730 mechanical tees or crosses with integral gasket. Figure 730 shall be coated with a lead-free paint as standard, or hot-dipped galvanized as an option.
- 1.6 Butterfly Valves** - Shall be with grooved ends. Valves shall have encapsulated Grade "E" EPDM or Grade "T" Nitrile disc and rated at 300 psi bubble-tight-shut-off. Reference shall be made to the latest published Grinnell gasket selection guide for proper disc seal selection for the intended service. Valve bodies shall be ductile iron, and upper stems shall be stainless steel.
- 1.7 Check Valves** - Shall be with grooved ends. Valves shall have a resilient elastomer seal Grade "E" EPDM or Grade "T" Nitrile and rated at 300 psi. Reference shall be made to the latest published Grinnell gasket selection guide for proper seal selection for the intended service. Valve bodies shall be ductile iron with a nickel seat. The caps shall be ductile iron with an attached stainless steel clapper assembly for 2" (60.3mm) - 8" (219.1mm) and a ductile iron clapper assembly for 10" (273.0mm) - 12" (323.9mm). All bodies and caps shall be coated with a lead-free paint as standard.

SECTION 2 - MATERIALS - PIPE PREPARATION

Pipe shall be prepared according to Grinnell® published specifications, ANSI/AWWA C-606, or other applicable standards.

- 2.1 Pipe Ends** - Shall be clean and free from indentations, projections, burrs, rust or roll marks in the area from pipe end to groove.
 - 2.1.1 Standard Weight Pipe** - Shall be roll grooved without removing metal, or cut grooved in accordance with Grinnell published standard roll groove or standard cut groove specifications.
 - 2.1.2 Lightwall Pipe** - Shall be roll grooved without metal removal in accordance with Grinnell published standard roll groove specifications.

GUIDE & BUILDING SERVICE SYSTEM SPECIFICATIONS

TYPICAL GUIDE SPECIFICATION

Continued

SECTION 3 - ASSEMBLY

- 3.1 Grinnell couplings, fittings, flanges and valves shall be assembled in accordance with instructions published by Tyco Fire & Building Products.
- 3.1.1 **Pipe** - Ends shall be clean and free from indentations, projections, burrs, roll marks, etc., in the area from pipe end to groove. Pipe ends shall be square cut and prepared in accordance with standard Grinnell specifications.
- 3.1.2 **Gasket** - Shall be of pressure responsive design verified as proper style and grade suitable for the intended service as published in the latest Grinnell gasket recommendation technical literature.
- 3.1.3 **Lubrication** - A thin, uniform coat of Grinnell lubricant shall be applied to the entire exterior of the gasket, including the gasket lips. Complete lubrication is essential to prevent gasket pinching and to ease installation and alignment. Petroleum-free silicon gasket lubricant is recommended when gaskets are subject to low temperature conditions. Petroleum lubricants shall not be used for EPDM gaskets.

SECTION 4 - SUPPORT

- 4.1 **Horizontal Piping:** (contact Tyco Fire & Building Products for support recommendations)
- 4.1.1 **Flexible Connections** - No pipe length shall be left unsupported between any two couplings, nor shall any pipe be left unsupported whenever a change in direction of line flow takes place. Supports shall meet the requirements stated above, but in no case shall the distance between supports exceed the following for systems where linear movement is not required:

Pipe Size Inches mm	Span Feet Meters	Pipe Size Inches mm	Span Feet Meters
1¼ - 1½ 42.4 - 48.3	12 3.7	14 - 16 355.6 - 406.4	18 5.5
2 - 8 60.3 - 219.1	15 4.6	18 - 24 457.2 - 609.6	20 6.1
10 - 12 273.0 - 323.9	16 4.9		

- 4.1.2 **Rigid Connections** - Pipe connections formed with the Figure 772 shall be supported in accordance with applicable ANSI B31.1, Power Piping Code; ANSI B31.9, Building Service Pipe Code.

TYPICAL SPECIFICATIONS

Building Service Systems - Plumbing

Plumbing Specifications (CSI - Div. 15 Section 15-E Plumbing)

SECTION 1 - DOMESTIC WATER SYSTEMS

(CSI - Div. 15, Section 15-E Water Supply Systems)

Grinnell Mechanical Grooved Pipe couplings, fittings and butterfly valves as manufactured or supplied by Tyco Fire & Building Products shall be used for all water supply systems under operating conditions not to exceed 230°F (110°C) temperature. The coupling gasket and encapsulated disc on butterfly valves shall be Grade "E" EPDM.

1.1 **Materials:**

- 1.1.1 **Pipe** - Pipe shall be galvanized steel pipe, conforming to

ASTM A-135, A-795 or A-53. All pipe shall be prepared according to Grinnell published specifications, or to ANSI/AWWA C-606 grooved end pipe. Pipe ends shall be prepared as detailed in Basic Materials and Methods and to the latest Grinnell published specifications.

- 1.1.2 **Couplings** - All Grinnell grooved couplings and fittings shall be painted or galvanized Figure 705, 707, 772 or 716 with Grade "E" EPDM gaskets and zinc plated bolts and nuts.
- 1.1.3 **Branch Connections** - Shall be made with Figure 730 and/or Figure 40-5.
- 1.1.4 **Flange Connections** - Flange connections shall be Grinnell Figure 71 Flanges incorporating Grade "E" EPDM gasket.
- 1.1.5 **Fittings** - Fittings shall be painted or galvanized Grinnell standard ductile iron or segmentally welded steel fittings, with grooved ends.
- 1.1.6 **Butterfly Valves** - Shall be of grooved end design with a Grade "E" EPDM encapsulated disc. Upper stem shall be stainless steel. Valves shall have pressure assisted double seal and be capable of 300 psi, bubble-tight-shut-off. Butterfly valves shall be with gear actuator or hand lever. Operating conditions not to exceed -30°F (-34°C) to 230°F (110°C).
- 1.1.7 **Check Valves** - Shall be of grooved end design with a clapper seal of Grade "E" EPDM. Valves shall be capable of pressures of 300 psi. The valves shall have a spring-loaded clapper to ensure a leak tight seal and a non-sticking operation. The clapper seat in the valve body shall be nickel. Operating conditions not to exceed -30°F (-34°C) to 230°F (110°C).

SECTION 2 - STORM DRAINS / ROOF DRAINS

Grinnell mechanical grooved pipe couplings and fittings as manufactured by Tyco Fire & Building Products shall be used for all storm and roof drainage systems.

2.1 **Materials:**

- 2.1.1 **Pipe** - Pipe shall be galvanized steel pipe, conforming to ASTM A-135, A-795 or A-53. All pipe shall be prepared according to Grinnell published specifications, or to ANSI/AWWA grooved end pipe. Pipe ends shall be prepared as detailed in Basic Materials and Methods and to the latest Grinnell published specifications.
- 2.1.2 **Couplings** - Couplings shall be galvanized Figure 705, 707, 772 or 716 with Grade "E" EPDM gaskets and zinc plated bolts and nuts.
- 2.1.3 **Flange Connections** - Flange connections shall be galvanized Grinnell Figure 71 Flanges incorporating Grade "E" EPDM gasket.
- 2.1.4 **Fittings** - Fittings shall be galvanized Grinnell standard ductile iron or segmentally welded steel fittings, with grooved ends.

2.2 **Plastic Pipe Systems**

- 2.2.1 **Pipe** - Pipe with material and dimensions conforming to ASTM D-1785 Type 1, Grade 1 with rolled or radius cut grooves and joint pressure ratings conforming to grooved manufacturer's specifications or recommendations; or Type 2, Grade 1 with rolled or radius cut grooves and joint ratings conforming to grooved manufacturer's specifications and recommendations.

BUILDING SERVICE SYSTEM SPECIFICATIONS

TYPICAL SPECIFICATIONS

Building Service Systems - Plumbing

SECTION 2 - STORM DRAINS / ROOF DRAINS

Continued

- 2.2.2 Couplings - Flexible type couplings shall be used.
- 2.2.3 Flange Connections - Same as in 2.1.3
- 2.2.4 Fittings - Same as in 2.1.4

SECTION 3 - VENT PIPING

(Same as in Section 2 - Storm Drains / Roof Drains)

Building Service Systems - Cooling

Cooling System Specifications (CSI - Div. 15 Section 15-N Refrigeration Systems)

SECTION 1 - CHILLED WATER - SUPPLY & RETURN

Grinnell® Mechanical Grooved Pipe couplings, fittings and butterfly and check valves as manufactured or supplied by Tyco Fire & Building Products shall be used for cooling system chilled water piping, including risers, mains, equipment connection, branches, supply and return lines under operating conditions not to exceed -30°F (-34°C) - 230°F (110°C) temperature. Calculations shall be made based on coupling manufacturers latest literature to determine expansion/contraction allowance available, enabling elimination of special movement compensators, swing joints, flexible connections and vibration isolators where possible.

1.1 Materials:

- 1.1.1 Pipe - Shall be steel pipe, conforming to ASTM A-135, A-795 or A-53. All pipe shall be prepared according to Grinnell published specifications, or to ANSI/AWWA C-606 grooved end pipe. Pipe ends shall be prepared as detailed in Basic Materials and Methods.
- 1.1.2 Couplings - All flexible couplings shall be Grinnell Figure 705 and 707 with Grade "E" EPDM gaskets and zinc plated bolts and nuts. All rigid couplings shall be Grinnell Figure 772 with Grade "E" EPDM gaskets and zinc plated bolts and nuts.
- 1.1.3 Branch Connections - Branch stub-in connections shall be made with Figure 730 with Grade "E" EPDM gaskets and zinc plated bolts and nuts.
- 1.1.4 Flange Connections - Shall be Grinnell Figure 71 Flange incorporating Grade "E" EPDM gasket.
- 1.1.5 Fittings - Shall be Grinnell ductile iron or segmentally welded steel fittings, with grooved ends.
- 1.1.6 Butterfly Valves - Shall be of grooved end design with EPDM encapsulated disc. Neck design shall readily accommodate insulation. Valves shall have pressure assisted double seal and stainless steel upper stems, and be capable of 300 psi, bubble-tight-shut-off, with an actuator or hand lever.
- 1.1.7 Check Valves - Shall be of grooved end design with a clapper seal of EPDM. The valves shall have a spring-loaded clapper to ensure a leak tight seal and a non-sticking operation. The clapper seat in the valve body shall be nickel. Valves shall be capable of pressures of 300 psi.

SECTION 2 - COOLING TOWER PIPING

Same as Section 1, except pipe, couplings and fittings shall be galvanized.

SECTION 3 - DUAL TEMPERATURE SYSTEMS PIPING

Same as Section 1.

SECTION 4 - CONDENSER WATER PIPING

Same as Section 1.

Building Service Systems - Heating

Heating System Specifications (CSI - Div. 15 Section 15-L Water Piping)

SECTION 1 - HOT WATER HEATING SYSTEMS - SUPPLY & RETURN

Grinnell Mechanical Grooved Pipe couplings, fittings and butterfly and check valves as manufactured or supplied by Tyco Fire & Building Products shall be used for hot water systems, including boiler manifolds, mains, risers, branches, supply and return lines, under operating conditions not to exceed 230°F (110°C). Calculations shall be based on coupling manufacturers latest literature to determine expansion allowance available, enabling elimination of special expansion compensators, swing joints, flexible connections and vibration isolators where possible.

1.1 Materials:

- 1.1.1 Pipe - Shall be steel pipe, conforming to ASTM A-135, A-795 or A-53. All pipe shall be prepared according to Grinnell published specifications, or to ANSI/AWWA C-606 grooved end pipe. Pipe ends shall be prepared as detailed in Basic Materials and Methods.
- 1.1.2 Couplings - All flexible couplings shall be Grinnell Figure 705 and 707 with Grade "E" EPDM gaskets and zinc plated bolts and nuts. All rigid couplings shall be Grinnell Figure 772 with Grade "E" EPDM gaskets and zinc plated bolts and nuts. All reducing couplings shall be Grinnell Figure 716 with Grade "E" EPDM gaskets and zinc plated bolts and nuts.
- 1.1.3 Branch Connections - Branch stub-in connections shall be made with Grinnell Figure 730 with Grade "E" EPDM gaskets and zinc plated bolts and nuts.
- 1.1.4 Flange Connections - Flange connections shall be Grinnell Figure 71 Flange incorporating Grade "E" EPDM gasket.
- 1.1.5 Fittings - Fittings shall be Grinnell ductile iron or segmentally welded steel fittings, with grooved ends.
- 1.1.6 Butterfly Valves - Shall be of grooved end design with EPDM encapsulated disc. Neck design shall readily accommodate insulation. Valves shall have pressure assisted double seal and stainless steel upper stems, and be capable of 300 psi, bubble-tight-shut-off, with an actuator or hand lever.
- 1.1.7 Check Valves - Shall be of grooved end design with a clapper seal of EPDM. The valves shall have a spring-loaded clapper to ensure a leak tight seal and a non-sticking operation. Valves shall be capable of pressures of 300 psi.



Grinnell®

LIMITED WARRANTY

Products manufactured by TFBP are warranted solely to the original Buyer for **ten (10) years** against defects in material and workmanship when paid for and properly installed and maintained under normal use and service. This warranty will expire ten (10) years from date of shipment by TFBP. No warranty is given for products or components manufactured by companies not affiliated by ownership with Tyco Fire & Building Products or for products and components which have been subject to misuse, improper installation, corrosion, or other external sources of damage or which have not been installed, maintained, modified or repaired in accordance with TFBP's installation instructions. Materials found by TFBP to be defective shall be either repaired or replaced, at TFBP's sole option. TFBP neither assumes, nor authorizes any person to assume for it, any other obligation in connection with the sale of products or parts of products. TFBP shall not be responsible for mechanical and/or sprinkler system design errors or inaccurate or incomplete information supplied by Buyer or Buyer's representatives.

IN NO EVENT SHALL TFBP BE LIABLE, IN CONTRACT, TORT, STRICT LIABILITY OR UNDER ANY OTHER LEGAL THEORY, FOR INCIDENTAL, INDIRECT, SPECIAL OR CONSEQUENTIAL DAMAGES, INCLUDING BUT NOT LIMITED TO LABOR CHARGES, REGARDLESS OF WHETHER TFBP WAS INFORMED ABOUT THE POSSIBILITY OF SUCH DAMAGES, AND IN NO EVENT SHALL TFBP'S LIABILITY EXCEED AN AMOUNT EQUAL TO THE SALES PRICE.

The foregoing warranty is made in lieu of any and all other warranties express or implied, including warranties of merchantability and fitness for a particular purpose.

www.grinnell.com



tyco
*Fire & Building
Products*

USA

Customer Service
Oak Creek, WI
Toll Free: 800 558-5236
Fax: 800 877-1295

Technical Services
Tel: 866 500-4768
Fax: 401 781-7317

EUROPE & MIDDLE EAST

**Tyco Building Services
Products**
Kopersteden 1, NL-7547 TJ
Enschede
P.O. Box 198, 7500 AD
Enschede, The Netherlands
Tel: 31-53-428-4444
Fax: 31-53-428-3377

ASIA

**Tyco Fire & Building
Products Asia**
45 Tuas Avenue 9
Singapore 639189
Tel: +65-6861-1655
Fax: +65-6861-1312

AUSTRALIA

Tyco Flow Control - Fixed Fire
567 Somerville Road
Sunshine, Melbourne VIC 3020
Tel: 13-0072-5688
Fax: 03-9933-6204

GRINNELL MECHANICAL PRODUCTS

a vital part of your world

www.grinnell.com