

# MiniRAE 3000 User's Guide



## FCC Information

Contains FCC ID: PI4411B or SU3RM900

The enclosed device complies with part 15 of the FCC rules. Operation is subject to the following conditions: (1) This device may not cause harmful interference, and (2) This device must accept any interference received, including interference that may cause undesired operation.

## Wireless Approval For UAE In Middle East

TRA REGISTERED No: ER36153/14 or ER36153/15  
DEALER No.: HONEYWELL INTERNATIONAL MIDDLE EAST  
– LTD – DUBAI BR

## Wireless Approval For QATAR In Middle East

ictQATAR  
Type Approval Reg. No.: R-4466 or R-4635



# MiniRAE 3000 User's Guide

## Contents

Read Before Operating.....	6
Special Notes.....	7
Warnings .....	8
Standard Contents.....	10
General Information .....	10
Physical Description.....	12
Specifications .....	12
Charging The Battery .....	16
Charging A Spare Rechargeable Battery .....	17
Low Voltage Warning.....	18
Clock Battery .....	18
Data Protection While Power Is Off .....	18
User Interface .....	19
Display .....	21
Operating The Instrument .....	22
Turning The Instrument On.....	22
Turning The Instrument Off.....	23
Operating The Built-In Flashlight .....	23
Pump Status.....	23
Calibration Status .....	24
Operating Modes .....	29
Basic User Level/Hygiene Mode (Default Settings) .....	30
Alarm Signals .....	32
Alarm Signal Summary.....	33
Preset Alarm Limits & Calibration .....	34
Testing The Alarm.....	34
Integrated Sampling Pump .....	34
Backlight .....	35
Datalogging.....	35
Datalogging event.....	35
Datalogging sample .....	35
Auto/Manual/Snapshot Datalogging .....	36
Standard Kit & Accessories .....	37
AC Adapter (Battery Charger).....	37
Alkaline Battery Adapter .....	38
External Filter .....	39

## MiniRAE 3000 User's Guide

Optional Accessories .....	40
Calibration Adapter .....	40
Calibration Regulator .....	40
Organic Vapor Zeroing Kit .....	40
Standard Two-Point Calibration (Zero & Span) .....	41
Entering Calibration .....	42
Zero (Fresh Air) Calibration .....	44
Span Calibration.....	46
Exiting Two-Point Calibration In Basic User Level .....	48
Three-Point Calibration.....	49
Span 2 Calibration .....	50
Exiting Three-Point Calibration.....	53
Bump Test .....	48
Programming Mode.....	53
Entering Programming Mode.....	54
Programming Mode Menus.....	56
Zero Calibration .....	57
Meas. Gas.....	57
High Alarm .....	57
Clear Datalog .....	57
Radio .....	57
Power .....	57
Span Calibration.....	57
Meas. Unit.....	57
Low Alarm .....	57
Interval .....	57
Op Mode .....	57
Bump.....	57
STEL Alarm.....	57
Data Selection .....	57
Site ID .....	57
TWA Alarm .....	57
Datalog Type.....	57
User ID.....	57
Alarm Mode .....	57
User Mode.....	57
Buzzer & Light.....	57
Date .....	57
Time .....	57

## MiniRAE 3000 User's Guide

Pump Duty Cycle .....	57
Pump Speed .....	57
Temperature Unit .....	57
Language .....	57
Real Time Protocol .....	57
Power On Zero .....	57
Unit ID .....	57
LCD Contrast .....	57
Lamp ID .....	57
PAN ID .....	57
Mesh Channel .....	57
Mesh Interval .....	57
Exiting Programming Mode.....	58
Navigating Programming Mode Menus.....	58
Calibration.....	59
Zero Calibration.....	59
Span Calibration .....	59
Bump .....	59
Measurement.....	60
Meas. Gas .....	60
Meas. Unit .....	61
Alarm Setting .....	62
High Alarm .....	63
Low Alarm.....	63
STEL Alarm .....	64
TWA Alarm.....	65
Alarm Type.....	66
Buzzer & Light .....	67
Datalog .....	67
Interval.....	68
Data Selection.....	69
Datalog Type .....	70
Manual Datalog .....	70
Snapshot Datalog.....	71
Monitor Setup .....	72
Radio Power .....	72
Op Mode.....	73
Hygiene .....	73
Search.....	73

## MiniRAE 3000 User's Guide

Site ID.....	73
User ID .....	74
User Mode .....	74
Date.....	75
Time.....	76
Pump Duty Cycle.....	76
Pump Speed .....	77
Temperature Unit.....	77
Language .....	78
Real Time Protocol.....	78
Power On Zero.....	79
Unit ID.....	79
LCD Contrast.....	80
Lamp ID.....	80
PAN ID .....	80
Mesh Channel .....	81
Mesh Interval.....	81
Hygiene Mode .....	82
Advanced User Level (Hygiene Mode Or Search Mode) .....	86
Advanced User Level & Hygiene Mode.....	86
Basic User Level & Search Mode.....	88
Advanced User Level & Search Mode.....	89
Diagnostic Mode.....	90
Entering Diagnostic Mode.....	91
Adjusting The Pump Stall Threshold .....	92
Pump High .....	92
Pump Low.....	92
Exiting Diagnostic Mode.....	93
Transferring Data To & From A Computer .....	94
Downloading The Datalog To A PC.....	94
Connection. ....	94
Uploading Firmware To The instrument From A PC .....	95
Maintenance .....	96
Battery Charging & Replacement .....	96
Replacing The Li-ion Battery .....	97
Replacing The Alkaline Battery Adapter.....	97
PID Sensor & Lamp Cleaning/Replacement.....	99
Sensor Components.....	99
Cleaning The Lamp Housing Or Changing The Lamp.....	100

## MiniRAE 3000 User's Guide

Determining The Lamp Type .....	101
Sampling Pump.....	102
Cleaning The Instrument .....	102
Ordering Replacement Parts .....	102
Special Servicing Note.....	103
Troubleshooting.....	104
Technical Support.....	105
RAE Systems Contacts.....	106
Controlled Part of Manual .....	107
Basic Operation .....	107
Turning The Instrument On .....	107
Turning The Instrument Off.....	107
Alarm Signals .....	108
Alarm Signal Summary.....	108
Preset Alarm Limits & Calibration.....	109
Charging The Battery .....	110
Low Voltage Warning.....	111
Clock Battery .....	111
Replacing Rechargeable Li-Ion or NiMH Battery .....	112
Alkaline Battery Adapter .....	112
Troubleshooting.....	113

# Read Before Operating

This manual must be carefully read by all individuals who have or will have the responsibility of using, maintaining, or servicing this product. The product will perform as designed only if it is used, maintained, and serviced in accordance with the manufacturer's instructions. The user should understand how to set the correct parameters and interpret the obtained results.

### **CAUTION!**

To reduce the risk of electric shock, turn the power off before removing the instrument cover. Disconnect the battery before removing sensor module for service. Never operate the instrument when the cover is removed. Remove instrument cover and sensor module only in an area known to be non-hazardous.



### Special Notes



When the instrument is taken out of the transport case and turned on for the first time, there may be some residual organic or inorganic vapor trapped inside the detector chamber. The initial PID sensor reading may indicate a few ppm. Enter an area known to be free of any organic vapor and turn on the instrument. After running for several minutes, the residual vapor in the detector chamber will be cleared and the reading should return to zero.



The battery of the instrument discharges slowly even if it is turned off. If the instrument has not been charged for 5 to 7 days, the battery voltage will be low. Therefore, it is a good practice to always charge the instrument before using it. It is also recommended to fully charge the instrument for *at least 10 hours* before first use. Refer to this User Guide's section on battery charging for more information on battery charging and replacement.

## WARNINGS

**STATIC HAZARD: Clean only with damp cloth.**

For safety reasons, this equipment must be operated and serviced by qualified personnel only. Read and understand instruction manual completely before operating or servicing.

Use only RAE Systems battery packs, part numbers 059-3051-000, 059-3052-000, and 059-3054-000. This instrument has not been tested in an explosive gas/air atmosphere having an oxygen concentration greater than 21%. Substitution of components may impair intrinsic safety. Recharge batteries only in non-hazardous locations.

Do not mix old and new batteries or batteries from different manufacturers.

The calibration of all newly purchased RAE Systems instruments should be tested by exposing the sensor(s) to known concentration calibration gas before the instrument is put into service.

For maximum safety, the accuracy of the instrument should be checked by exposing it to a known concentration calibration gas before each day's use.

Do not use USB/PC communication in hazardous locations.

## AVERTISSEMENT

**DANGER RISQUE D'ORIGINE ELECTROSTATIQUE: Nettoyer uniquement avec un chiffon humide.**

Pour des raisons de sécurité, cet équipement doit être utilisé, entretenu et réparé uniquement par un personnel qualifié. Étudier le manuel d'instructions en entier avant d'utiliser, d'entretenir ou de réparer l'équipement.

Utiliser seulement l'ensemble de batterie RAE Systems, la référence 059-3051-000 au 059-3052-000 au 059-3054-000. Cet instrument n'a pas été essayé dans une atmosphère de gaz/air explosive ayant une concentration d'oxygène plus élevée que 21%. La substitution de composants peut compromettre la sécurité intrinsèque. Ne charger les batteries que dans emplacements désignés non-dangereuse.

Ne pas mélanger les anciennes et les nouvelles batteries, ou bien encore les batteries de différents fabricants.

La calibration de tous les instruments de RAE Systems doit être testée en exposant l'instrument à une concentration de gaz connue par une procédure de tarage avant de mettre en service l'instrument pour la première fois.

Pour une sécurité maximale, la sensibilité de l'instrument doit être vérifiée en exposant l'instrument à une concentration de gaz connue par une procédure de tarage avant chaque utilisation journalière.

Ne pas utiliser de connexion USB/PC en zone dangereuse.

# Standard Contents

Instrument

Calibration Kit

Charging Cradle

AC/DC Adapter

Alkaline Battery Adapter

Data Cable

CD-ROM With User's Guide, Quick Start Guide, and related materials

## General Information

The compact instrument is designed as a broadband VOC gas monitor and datalogger for work in hazardous environments. It monitors Volatile Organic Compounds (VOC) using a photoionization detector (PID) with a 9.8 eV, 10.6 eV, or 11.7 eV gas-discharge lamp. Features are:

### Lightweight and Compact

- Compact, lightweight, rugged design
- Built-in sample draw pump

### Dependable and Accurate

- Up to 16 hours of continuous monitoring with rechargeable battery pack
- Designed to continuously monitor VOC vapor at parts-per-million (ppm) levels

### User-friendly

- Preset alarm thresholds for STEL, TWA, low- and high-level peak values.
- Audio buzzer and flashing LED display are activated when the limits are exceeded.

### Datalogging Capabilities

- 260,000-point datalogging storage capacity for data download to PC

## **MiniRAE 3000 User's Guide**

The instrument consists of a PID with associated microcomputer and electronic circuit. The unit is housed in a rugged case with a backlit LCD and 3 keys to provide easy user interface. It also has a built-in flashlight for operational ease in dark locations.

### Physical Description

The main components of the portable VOC monitoring instrument include:

- Three keys for user to interact with the instrument: 3 operation/programming keys for normal operation or programming
- LCD display with back light for direct readout and calculated measurements
- Built-in flashlight for illuminating testing points in dark environments
- Buzzer and red LEDs for alarm signaling whenever exposures exceed preset limits
- Charge contacts for plugging directly to its charging station
- Gas entry and exit ports
- USB communication port for PC interface
- Protective rubber cover

### Specifications

<b>Size:</b>	9.25" L x 3.6" W x 2.9" H
<b>Weight:</b>	28 oz with battery pack
<b>Detector:</b>	Photoionization sensor with 9.8, 10.6, or 11.7 eV UV lamp
<b>Battery:</b>	A 3.7V rechargeable Lithium-Ion battery pack (snap in, field replaceable, at non-hazardous location only) Alkaline battery holder (for 4 AA batteries)
<b>Battery Charging:</b>	Less than 8 hours to full charge
<b>Operating Hours:</b>	Up to 16 hours continuous operation
<b>Display:</b>	Large dot matrix screen with backlight

## MiniRAE 3000 User's Guide

### Measurement range & resolution

Lamp	Range	Resolution
10.6 eV	0.1 ppm to 15,000 ppm	0.1 ppm
9.8 eV	0.1 ppm to 5,000 ppm	0.1 ppm
11.7 eV	0.1 ppm to 2,000 ppm	0.1 ppm

**Response time ( $T_{90}$ ):** 2 seconds

**Accuracy (Isobutylene):** 10 to 2000 ppm:  $\pm 3\%$  at calibration point.

**PID Detector:** Easy access to lamp and sensor for cleaning and replacement

**Correction Factors:** Over 200 VOC gases built in (based on RAE Systems Technical Note TN-106)

**Calibration:** Two-point field calibration of zero and standard reference gases

**Calibration Reference:** Store up to 8 sets of calibration data, alarm limits and span values

**Inlet Probe:** Flexible 5" tubing

**Radio module:** Bluetooth (2.4GHz) or RF module (433MHz, 868MHz, 915MHz, or 2.4GHz)

**Keypad:** 1 operation key and 2 programming keys; 1 flashlight switch

**Direct Readout:** Instantaneous, average, STEL, TWA and peak value, and battery voltage

**Intrinsic Safety:** US and Canada: Class I, Division 1, Groups A, B, C, D  
Europe: ATEX (0575 Ex II 2G Ex ia IIC/IIB T4 Gb)  
KEMA 07 ATEX 0127  
Complies with EN60079-0:2009, EN60079-11:2007

## MiniRAE 3000 User's Guide

IECEX CSA 10.0005 Ex ia IIC/IIB T4 Gb  
Complies with IEC 60079-0:2007,  
IEC 60079-11:2006  
(IIC: 059-3051-000 Li-ion bat pack  
or 059-3054-000 NiMH bat pack;  
IIB: 059-3052-000 alkaline bat pack)

<b>EM Interference:</b>	Highly resistant to EMI/RFI. Compliant with EMC R&TTE (RF Modules)
<b>Alarm Setting:</b>	Separate alarm limit settings for Low, High, STEL and TWA alarm
<b>Operating Mode:</b>	Hygiene or Search mode
<b>Alarm:</b>	Buzzer 95dB at 30cm and flashing red LEDs to indicate exceeded preset limits, low battery voltage, or sensor failure
<b>Alarm Type:</b>	Latching or automatic reset
<b>Real-time Clock:</b>	Automatic date and time stamps on datalogged information
<b>Datalogging:</b>	260,000 points with time stamp, serial number, user ID, site ID, etc.
<b>Communication:</b>	Upload data to PC and download instrument setup from PC via USB on charging station.
<b>Sampling Pump:</b>	Internally integrated. Flow rate: 450 to 550 cc/min.
<b>Wireless Network:</b>	Mesh RAE Systems Dedicated Wireless Network (or WiFi network for WiFi-equipped instruments)
<b>Wireless Frequency:</b>	ISM license-free band, 902 to 907.5 MHz and 915 to 928 MHz, FCC Part 15, CE R&TTE, IEEE 802.11 b/g bands (2.4 GHz)
<b>Modulation:</b>	802.15.4 DSSS BPSK
<b>RF Power (Tx):</b>	10dBm
<b>Temperature:</b>	-20° C to 50° C (-4° to 122° F)



## MiniRAE 3000 User's Guide

<b>Humidity:</b>	0% to 95% relative humidity (non-condensing)
<b>Housing (including rubber boot):</b>	Polycarbonate, splashproof and dustproof Battery can be changed without removing rubber boot.

# Charging The Battery

Always fully charge the battery before using the instrument. The instrument's Li-ion battery is charged by placing the instrument in its cradle. (The battery can also be charged by placing the instrument in an AutoRAE 2 Cradle.) Contacts on the bottom of the instrument meet the cradle's contacts, transferring power without other connections.

**Note:** Before setting the instrument into its charging cradle, visually inspect the contacts to make sure they are clean. If they are not, wipe them with a soft cloth. Do not use solvents or cleaners.

Follow this procedure to charge the instrument:

1. Plug the AC/DC adapter's barrel connector into the instrument's cradle.

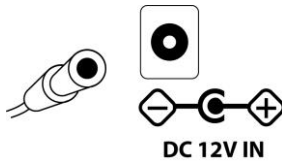

2. Plug the AC/DC adapter into the wall outlet.
3. Place the instrument into the cradle, press down, and lean it back. It locks in place and the LED in the cradle glow

The instrument begins charging automatically. The “Primary” LED in the cradle blinks green to indicate charging. During charging, the diagonal lines in the battery icon on the instrument's display are animated and you see the message “Charging...”

When the instrument's battery is fully charged, the battery icon is no longer animated and shows a full battery. The message “Fully charged!” is shown. The cradle's LED glows continuously green.



**Note:** If you see the “Battery Charging Error” icon (a battery outline with an exclamation mark inside), check that the



## MiniRAE 3000 User's Guide

instrument or rechargeable battery has been set into the cradle properly. If you still receive the message, check the Troubleshooting section of this guide.

**Note:** If the instrument or battery has been in the cradle for more than 10 hours and you see the “Battery Charging Error” icon and a message that says, “Charging Too Long,” this indicates that the battery is not reaching a full charge. Try changing the battery and make sure the contacts between the instrument (or battery) are meeting the cradle. If the message is still shown, consult your distributor or RAE Systems Technical Services.

### Charging A Spare Rechargeable Battery

A rechargeable Li-ion battery can be charged when it is not inside the monitor. The charging cradle is designed to accommodate both types of charging. Contacts on the bottom of the battery meet the contacts on the cradle, transferring power without other connections, and a spring-loaded capture holds the battery in place during charging.

1. Plug the AC/DC adapter into the monitor's cradle.
2. Place the battery into the cradle, with the gold-plated contacts on top of the six matching charging pins.
3. Plug the AC/DC adapter into the wall outlet.

The battery begins charging automatically. During charging, the Secondary LED in the cradle blinks green. When charging is complete, it glows steady green.

Release the battery from the cradle by pulling it back toward the rear of the cradle and tilting it out of its slot.

**Note:** If you need to replace the Li-ion battery pack, replacements are available from RAE Systems. The part number is 059-3051-000.

## MiniRAE 3000 User's Guide

**Note:** An Alkaline Battery Adapter (part number 059-3052-000), which uses four AA alkaline batteries (Duracell MN1500), may be substituted for the Li-Ion battery.

### WARNING!

**To reduce the risk of ignition of hazardous atmospheres, recharge and replace batteries only in areas known to be non-hazardous. Remove and replace batteries only in areas known to be non-hazardous.**

### Low Voltage Warning

When the battery's charge falls below a preset voltage, the instrument warns you by beeping once and flashing once every minute, and the "empty battery" icon blinks on and off once per second. You should turn off the instrument within 10 minutes and either recharge the battery by placing the instrument in its cradle, or replace the battery with a fresh one with a full charge.



### Clock Battery

An internal clock battery is mounted on one of the instrument's printed circuit boards. This long-life battery keeps settings in memory from being lost whenever the Li-ion battery or alkaline batteries are removed. This backup battery should last approximately five years, and must be replaced by an authorized RAE Systems service technician. It is not user-replaceable.

### Data Protection While Power Is Off

When the instrument is turned off, all the current real-time data including last measured values are erased. However, the datalog data is preserved in non-volatile memory. Even if the battery is disconnected, the datalog data will not be lost.

## User Interface

The instrument's user interface consists of the display, LEDs, an alarm transducer, and four keys. The keys are:

- Y/+
- MODE
- N/-
- Flashlight on/off

The LCD display provides visual feedback that includes the reading, time, battery condition, and other functions.

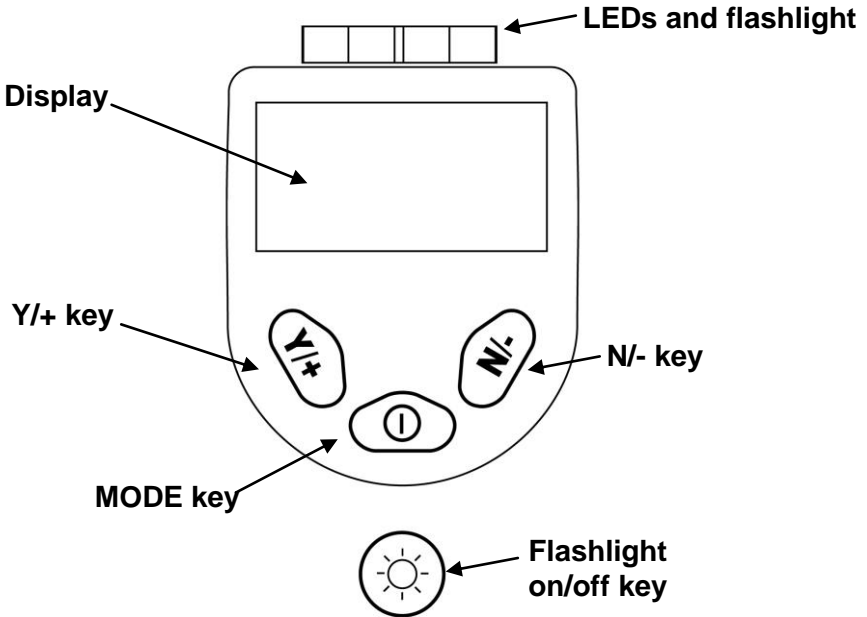

In addition to their labeled functions, the keys labeled Y/+, MODE, and N/- act as “soft keys” that control different parameters and make different selections within the instrument's menus. From menu to menu, each key controls a different parameter or makes a different selection.

# MiniRAE 3000 User's Guide

Three panes along the bottom of the display are “mapped” to the keys. These change as menus change, but at all times the left pane corresponds to the [Y/+] key, the center pane corresponds to the [MODE] key, and the right pane corresponds to the [N/-] key. Here are three examples of different menus with the relationships of the keys clearly shown:

## RELATIONSHIP OF BUTTONS TO CONTROL FUNCTIONS

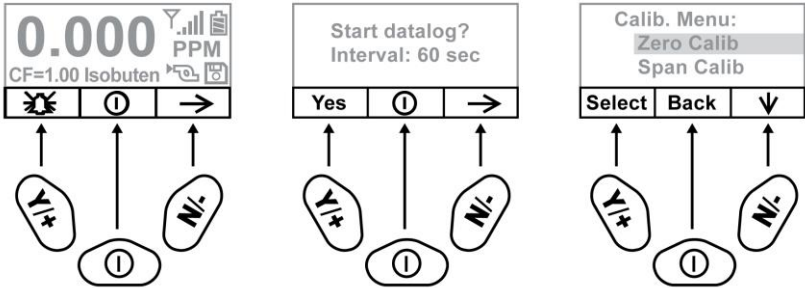

# MiniRAE 3000 User's Guide

## Display

The display shows the following information:

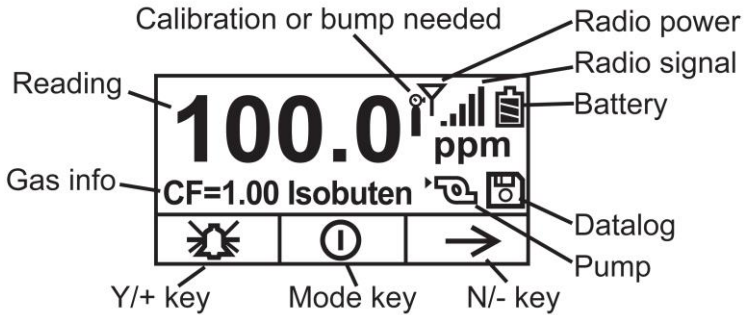

<b>Gas info</b>	Tells the Correction Factor and type of calibration gas
<b>Reading</b>	Concentration of gas as measured by the instrument
<b>Calibration or bump needed</b>	Dark icon indicates that calibration should be performed; light icon indicates bump should be performed
<b>Radio power</b>	Indicates whether radio (Mesh wireless or Bluetooth) connection is on or off
<b>Radio signal</b>	Indicates signal strength in 5-bar bargraph
<b>Battery</b>	Indicates battery level in 3 bars
<b>Pump</b>	Indicates that pump is working
<b>Datalog</b>	Indicates whether datalog is on or off
<b>Y/+</b>	Y/+ key's function for this screen
<b>MODE</b>	MODE key's function for this screen
<b>N/-</b>	N/- key's function for this screen

# Operating The Instrument

The instrument is designed as a broadband VOC gas monitor and datalogger for work in hazardous environments. It gives real-time measurements and activates alarm signals whenever the exposure exceeds preset limits. Prior to factory shipment, the instrument is preset with default alarm limits and the sensor is pre-calibrated with standard calibration gas. However, you should test the instrument and verify the calibration before the first use. After the instrument is fully charged and calibrated, it is ready for immediate operation.

## Turning The Instrument On

1. With the instrument turned off, press and hold [MODE].
2. When the display turns on, release the [MODE] key.

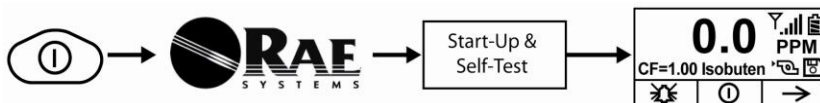

The RAE Systems logo should appear first. (If the logo does not appear, there is likely a problem and you should contact your distributor or RAE Systems Technical Support.) The instrument is now operating and performs self tests. If any tests (including sensor and memory tests fail), refer to the Troubleshooting section of this guide.

Once the startup procedure is complete, the instrument shows a numerical reading screen with icons. This indicates that the instrument is fully functional and ready to use.



### Turning The Instrument Off

1. Press and hold the Mode key for 3 seconds. A 5-second countdown to shutoff begins.
2. Once the countdown stops, the instrument is off. Release the Mode key.
3. When you see “Unit off...” release your finger from the [MODE] key. The instrument is now off.

**Note:** You must hold your finger on the key for the entire shutoff process. If you remove your finger from the key during the countdown, the shutoff operation is canceled and the instrument continues normal operation.

### Operating The Built-In Flashlight

The instrument has a built-in flashlight that helps you point the probe in dark places. Press the flashlight key to turn it on. Press it again to turn it off.

**Note:** Using the flashlight for extended periods shortens the battery's operating time before it needs recharging.

### Pump Status

#### IMPORTANT!

During operation, make sure the probe inlet and the gas outlet are free of obstructions. Obstructions can cause premature wear on the pump, false readings, or pump stalling. During normal operation, the pump icon alternately shows inflow and outflow as shown here:



## MiniRAE 3000 User's Guide

During duty cycling (PID lamp cleaning), the display shows these icons in alternation:



If there is a pump failure or obstruction that disrupts the pump, you will see this icon blinking on and off:



If you see this blinking icon, consult the Troubleshooting section of this guide.

## Calibration Status

The instrument displays this icon if it requires calibration:



Calibration is required (and indicated by this icon) if:

- The lamp type has been changed (for example, from 10.6 eV to 9.8 eV).
- The sensor has been replaced.
- It has been 30 days or more since the instrument was last calibrated.
- If you have changed the calibration gas type without recalibrating the instrument.

## Bump Status

The instrument displays this icon if it requires a bump test:



## MiniRAE 3000 User's Guide

A bump test is required (and indicated by this icon) if:

- The defined period of time between bump tests has been exceeded (bump test overdue).
- The sensor has failed a previous bump test.
- The sensor(s) should be challenged on a periodic basis.

## Policy Enforcement

The MiniRAE 3000 can be configured to enforce a facility/company's requirements that calibration and/or bump testing be performed at specified intervals, and to explicitly prompt the user that calibration/bump testing is required. Depending on how Policy Enforcement features are configured, the user may be required to perform a bump test or calibration prior to being able to use the instrument. That is, it can be set to not allow normal operation of the instrument unless calibration or bump testing is performed.

If the instrument has been bump tested and calibrated in compliance with the policy settings, a check-mark icon is included along the top of the MiniRAE 3000 screen:



If Policy Enforcement is enabled, then after startup the MiniRAE 3000 displays a screen that informs the user that the instrument requires either a bump test or a calibration. If both are required, then they are shown in sequence.

**Note:** Policy enforcement features are disabled by default.

## Setting Policy Enforcement

You must use ProRAE Studio II to make changes to Policy Enforcement settings. You must use an AutoRAE 2 Cradle, a MiniRAE 3000 Travel Charger, or a MiniRAE 3000 Desktop Cradle. Policy violations are captured in the datalog.

## MiniRAE 3000 User's Guide

### Using The Travel Charger, Desktop Charger, or AutoRAE 2 Automatic Test And Calibration System

To program a MiniRAE 3000 via an AutoRAE 2, you need ProRAE Studio II Instrument Configuration and Data Management Software, the AutoRAE 2 connected to a power source, and a USB PC communications cable.

1. Connect a USB cable between a PC with ProRAE Studio II and the AutoRAE 2 Cradle, Travel Charger, or Desktop Cradle.
2. Apply power to the AutoRAE 2 Cradle, Travel Charger, or Desktop Cradle.
3. Turn off the MiniRAE 3000 (or put the MiniRAE 3000 into AutoRAE 2 Mode or Communication Mode) and set it in the cradle.
4. Start ProRAE Studio II software on the PC.
5. Select "Administrator" and input the password (the default is "rae").
6. Click "Detect the instruments automatically" (the magnifying glass icon with the letter "A" in it). After a few seconds, the AutoRAE 2 Cradle is found and it is shown, along with its serial number.
7. Click on the icon to highlight it, and then click "Select."
8. In ProRAE Studio II, the instrument or AutoRAE 2 Cradle is shown, including its Serial Number, under "Online."
9. Expand the view to show the instrument or to show the instrument in the AutoRAE 2 Cradle by clicking the "+" to the left of the image of the AutoRAE 2 Cradle.
10. Double-click on the icon representing the MiniRAE 3000.
11. Click "Setup."
12. In the menu that now appears on the left side, click "Policy Enforcement." It is highlighted, and the Policy Enforcement pane is shown. For "Must Calibrate" and "Must Bump," you have the options of no enforcement or enforcement (including "Can't Bypass," and "Can Bypass").

## MiniRAE 3000 User's Guide

**Must Calibrate.** The user is prompted to calibrate the instrument when calibration is due (as set by the calibration interval). There are two programmable options:

- **Can't Bypass.** Unless calibration is performed, the instrument cannot be used, and the only option is to turn off the instrument.
- **Can Bypass.** If calibration is due but the user does not want to perform a calibration, the instrument can still be used. In this case, the instrument records that the user has bypassed the calibration requirement in a Policy Violation report.

**Must Bump.** The user is prompted to bump test the instrument when a bump test is due (as set by the bump test interval). There are two programmable options:

- **Can't Bypass.** Unless a bump test is performed, the instrument cannot be used, and the only option is to turn off the instrument.
- **Can Bypass.** If a bump test is due but the user does not want to perform one, the instrument can still be used. In this case, the instrument records that the user has bypassed the bump testing requirement in a Policy Violation report.

These are the screens that are shown on a MiniRAE 3000 after startup if "Can Bypass" is selected:

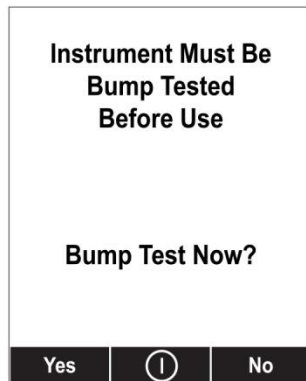
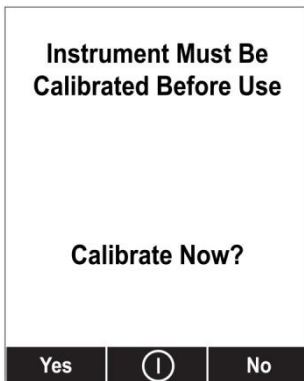

## MiniRAE 3000 User's Guide

If “Can't Bypass” is selected, the display looks like this, and only allows the options of performing the test or shutting down:

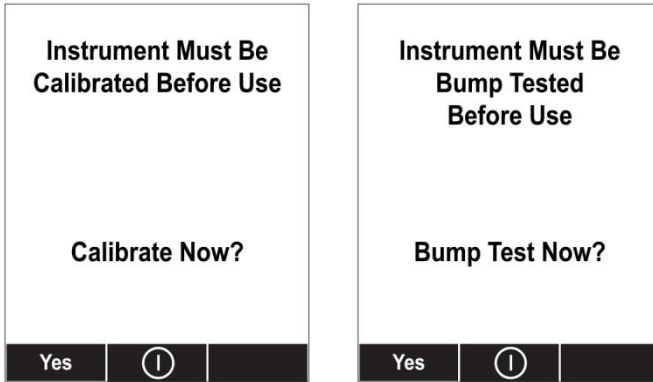

16. Once you have made your selections in ProRAE Studio II, you must upload the changes to the instrument. Click the icon labeled “Upload all settings to the instrument.”
17. A confirmation screen is shown. Click “Yes” to perform the upload, or “No” to abort.  
Uploading takes a few seconds, and a progress bar is shown. You can abort the upload by clicking “Cancel.”
18. Exit ProRAE Studio II.
19. Press [Y/+ ] on the MiniRAE 3000 to exit Communication Mode.

### Operating Modes

Your instrument operates in different modes, depending on the model and its factory default settings. In some cases, you can change modes using a password and using the instrument's navigation. In other cases, you must use ProRAE Studio software.

The default setting for your instrument is:

**User Mode:** Basic  
**Operation Mode:** Hygiene

This is outlined in detail on page 83.

The other options, covered later in this guide, are:

**User Mode:** Advanced (page 86)  
**Operation Mode:** Hygiene

**User Mode:** Advanced (page 90)  
**Operation Mode:** Search

Using ProRAE Studio allows access to other options. In addition, Diagnostic Mode (page 91) is available for service technicians.

# Basic User Level/Hygiene Mode (Default Settings)

The instrument is programmed to operate in Basic User Level/Hygiene Mode as its default. This gives you the most commonly needed features while requiring the fewest parameter adjustments.

Pressing [N/-] steps you from one screen to the next, and eventually return to the main display. If you do not press a key within 60 seconds after entering a display, the instrument reverts to its main display.

**Note:** While viewing any of these screens, you can shut off your instrument by pressing [MODE].



# MiniRAE 3000 User's Guide

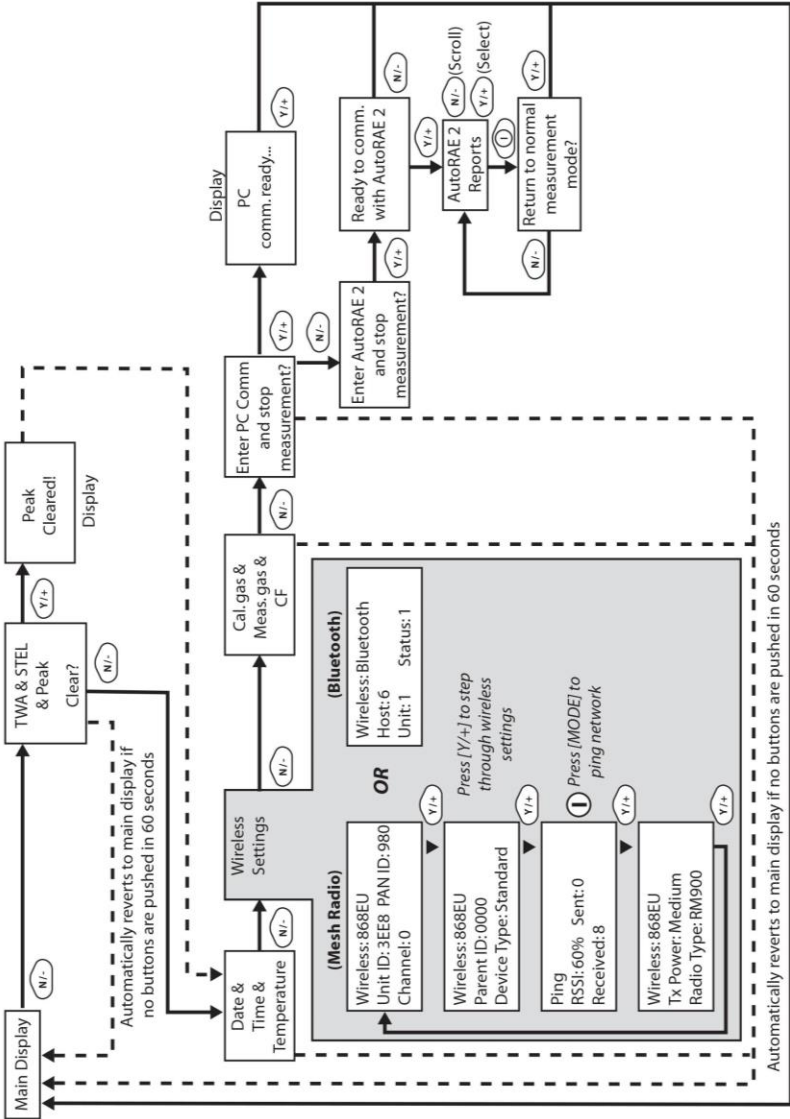

Automatically reverts to main display if no buttons are pushed in 60 seconds

After communications are complete, reverts to main display

**Note:** Dashed line indicates automatic progression.

## MiniRAE 3000 User's Guide

After the instrument is turned on, it runs through the start-up menu. Then the message “**Please apply zero gas...**” is displayed.

At this point, you can perform a zero air (fresh air) calibration. If the ambient air is clean, you can use that. Otherwise, use a cylinder of zero air. Refer to Zero Calibration on page 44 for a more detailed description of zero calibration.

Start zero calibration by pressing Start. You see the message “Zeroing...” followed by a 30-second countdown.

**Note:** You can press [MODE] to quit, bypassing the zero air calibration.

When zero calibration is complete, you see the message:

Zeroing is done!

Reading = 0.0 ppm

The instrument is now sampling and collecting data.

**Note:** At the Average & Peak, Date & Time & Temperature, Calibration Gas & Measurement Gas & Correction Factor, and PC Communications screens, the instrument automatically goes to the main display after 60 seconds if you do not push a key to make a selection.

## Alarm Signals

During each measurement period, the gas concentration is compared with the programmed alarm limits (gas concentration alarm limit settings). If the concentration exceeds any of the preset limits, the loud buzzer and red flashing LED are activated immediately to warn you of the alarm condition.

In addition, the instrument alarms if one of the following conditions occurs: battery voltage falls below a preset voltage level, failure of the UV lamp, or pump stall.

## MiniRAE 3000 User's Guide

### Alarm Signal Summary

Message	Condition	Alarm Signal
HIGH	Gas exceeds "High Alarm" limit	3 beeps/flashes per second*
OVR	Gas exceeds measurement range	3 beeps/flashes per second*
MAX	Gas exceeds electronics' maximum range	3 beeps/flashes per second*
LOW	Gas exceeds "Low Alarm" limit	2 beeps/flashes per second*
TWA	Gas exceeds "TWA" limit	1 Beep/flash per second*
STEL	Gas exceeds "STEL" limit	1 Beep/flash per second*
Pump icon flashes	Pump failure	3 beeps/flashes per second
Lamp	PID lamp failure	3 beeps/flashes per second plus "Lamp" message on display
Battery icon flashes	Low battery	1 flash, 1 beep per minute plus battery icon flashes on display
CAL	Calibration failed, or needs calibration	1 beep/flash per second
NEG	Gas reading measures less than number stored in calibration	1 beep/flash per second

\* Hygiene mode only. In Search mode, the number of beeps per second (1 to 7) depends upon the concentration of the sampled gas. Faster rates indicate higher concentrations.

### Preset Alarm Limits & Calibration

The instrument is factory calibrated with standard calibration gas, and is programmed with default alarm limits.

Cal Gas (Isobutylene)	Cal Span	unit	Low	High	TWA	STEL
MiniRAE 3000	100	ppm	50	100	10	25

### Testing The Alarm

You can test the alarm whenever the main (Reading) display is shown. Press [Y/+], and the audible and visible alarms are tested.

### Integrated Sampling Pump

The instrument includes an integrated sampling pump. This diaphragm-type pump that provides a 450 to 550 cc per minute flow rate.

Connecting a Teflon or metal tubing with 1/8" inside diameter to the gas inlet port of the instrument, this pump can pull in air samples from 100' (30 m) away horizontally or vertically.

**Note:** In Search Mode, the pump turns on when a sample measurement is started, and turns off when the sample is manually stopped.

If liquid or other objects are pulled into the inlet port filter, the instrument detects the obstruction and immediately shuts down the pump. The alarm is activated and a flashing pump icon is displayed.

You should acknowledge the pump shutoff condition by clearing the obstruction and pressing the [Y/+] key while in the main reading display to restart the pump.

### Backlight

The LCD display is equipped with an LED backlight to assist in reading the display under poor lighting conditions.

### Datalogging

During datalogging, the instrument displays a disk icon to indicate that datalogging is enabled. The instrument stores the measured gas concentration at the end of every sample period (when data logging is enabled). In addition, the following information is stored: user ID, site ID, serial number, last calibration date, and alarm limits. All data are retained (even after the unit is turned off) in non-volatile memory so that it can be down-loaded at a later time to a PC.

### Datalogging event

When Datalogging is enabled, measurement readings are being saved. These data are stored in “groups” or “events.” A new event is created and stored each time the instrument is turned on and is set to automatic datalogging, or a configuration parameter is changed, or datalogging is interrupted. The maximum time for one event is 24 hours or 28,800 points. If an event exceeds 24 hours, a new event is automatically created. Information, such as start time, user ID, site ID, gas name, serial number, last calibration date, and alarm limits are recorded.

### Datalogging sample

After an event is recorded, the unit records a shorter form of the data. When transferred to a PC running ProRAE Studio, this data is arranged with a sample number, time, date, gas concentration, and other related information.

## MiniRAE 3000 User's Guide

### Auto/Manual/Snapshot Datalogging

The instrument has three datalog types:

- |                 |   |
|-----------------|---|
| <b>Auto</b>     | Default mode. Collects datalog information when the instrument is sampling.   |
| <b>Manual</b>   | Datalogging occurs only when the instrument's datalogging is manually started (see page 63 for details).              |
| <b>Snapshot</b> | Datalogs only during snapshot (single-event capture, initiated by pressing [MODE]) sampling. See page 65 for details. |

**Note:** You can only choose one datalog type to be active at a time.

### Accessories

The following accessories are included with the instrument:

- An AC Adapter (Battery Charger)
- Alkaline battery adapter
- External Filter
- Organic Vapor Zeroing kit

Hard-case kits also include these accessories:

- Calibration adapter
- Calibration regulator and Flow controller

### Standard Kit & Accessories

#### AC Adapter (Battery Charger)

#### WARNING

**To reduce the risk of ignition of hazardous atmospheres, recharge battery only in area known to be non-hazardous. Remove and replace battery only in area known to be non-hazardous.**

**Ne charger les batteries que dans emplacements designés non-dangereuses.**

A battery charging circuit is built into the instrument cradle. It only needs a regular AC to 12 VDC adapter (wall-mount transformer, part number 500-0114-000) to charge the instrument.

To charge the battery inside the instrument:

1. Power off the instrument.
2. Connect the AC adapter to the DC jack on the instrument's cradle. If the instrument is off, it automatically turns on.
3. While charging, the display message shows "Charging." The Primary LED on the cradle flashes green when charging.
4. When the battery is fully charged, the LED changes to glowing green continuously, and the message "Fully charged" appears on the

## MiniRAE 3000 User's Guide

display. If there is a charging error, the LED glows red continuously.

A completely discharged instrument can be charged to full capacity within 8 hours. Batteries drain slowly even if an instrument is off. Therefore, if the instrument has been in storage or has not been charged for several days or longer, check the charge before using it.

The factory-supplied battery is designed to last for 16 hours of normal operation (no alarm), for a new battery under the optimum circumstances. As the battery becomes older or is subject to adverse conditions (such as cold ambient temperature), its capacity will be significantly reduced.

### Alkaline Battery Adapter

An alkaline battery adapter is supplied with each instrument. The adapter (part number 059-3052-000) accepts four AA alkaline batteries (use only Duracell MN1500) and provides approximately 12 hours of operation. The adapter is intended to be used in emergency situations when there is no time to charge the Li-ion battery pack.

To insert batteries into the adapter:

1. Remove the three Philips-head screws to open the compartment in the adapter.
2. Insert four fresh AA batteries as indicated by the polarity (+/-) markings.
3. Replace the cover. Replace the three screws.

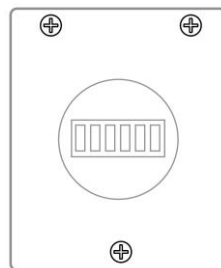

To install the adapter in the instrument:

1. Remove the Li-ion battery pack from the instrument by sliding the tab and tilting out the battery.
2. Replace it with the alkaline battery adapter
3. Slide the tab back into place to secure the battery adapter.

### IMPORTANT!

Alkaline batteries cannot be recharged. The instrument's internal circuit detects alkaline batteries and will not allow recharging. If you place the instrument in its cradle, the alkaline battery will not be recharged. The



## MiniRAE 3000 User's Guide

internal charging circuit is designed to prevent damage to alkaline batteries and the charging circuit when alkaline batteries are installed inside the instrument. If you try to charge an alkaline batteries installed in the instrument, the instrument's display will say, "Alkaline Battery," indicating that it will not charge the alkaline batteries.

**Note:** When replacing alkaline batteries, dispose of old ones properly.

### **WARNING!**

To reduce the risk of ignition of hazardous atmospheres, recharge the battery only in areas known to be non-hazardous. Remove and replace the battery only in areas known to be non-hazardous.

### **External Filter**

The external filter is made of PTFE (Teflon<sup>®</sup>) membrane with a 0.45 micron pore size to prevent dust or other particles from being sucked into the sensor manifold, which would cause extensive damage to the instrument. It prolongs the operating life of the sensor. To install the external filter, simply connect it to the instrument's inlet tube.

### Optional Accessories

#### Calibration Adapter

The calibration adapter for the instrument is a simple 6-inch Tygon tubing with a metal adapter on one end. During calibration, simply insert the metal adapter into the regular gas inlet probe of the instrument and the tubing to the gas regulator on the gas bottle.

#### Calibration Regulator

The Calibration Regulator is used in the calibration process. It regulates the gas flow rate from the Span gas cylinder into the gas inlet of the instrument during calibration process. The maximum flow rate allowed by the flow controller is about 0.5L/min (500 cc per min.).

Alternatively, a demand-flow regulator or a Tedlar gas bag may be used to match the pump flow precisely.

#### Organic Vapor Zeroing Kit

The Organic Vapor Zeroing Kit is used for filtering organic air contaminants that may affect the zero calibration reading. To use the Organic Vapor Zeroing Kit, simply connect the filter to the inlet port of the instrument.

#### AutoRAE 2 Automatic Test & Calibration System

The AutoRAE 2 Automatic Test and Calibration System for RAE Systems portable gas monitors makes compliance with monitor test and calibration requirements as easy as pressing a button. Simply cradle the monitor and the system will take care of all calibration, testing, and recharging.

The AutoRAE 2 is a flexible, modular system that can be configured to meet your calibration requirements effectively and efficiently. An AutoRAE 2 system can be as simple as a single cradle deployed in standalone mode to calibrate one instrument at a time, or as powerful as a networked, controller-based system supporting ten monitors and five distinct calibration gas cylinders.

## **Standard Two-Point Calibration (Zero & Span, Optional Bump)**

The following diagram shows the instrument's calibrations in Basic/Hygiene mode.

# MiniRAE 3000 User's Guide

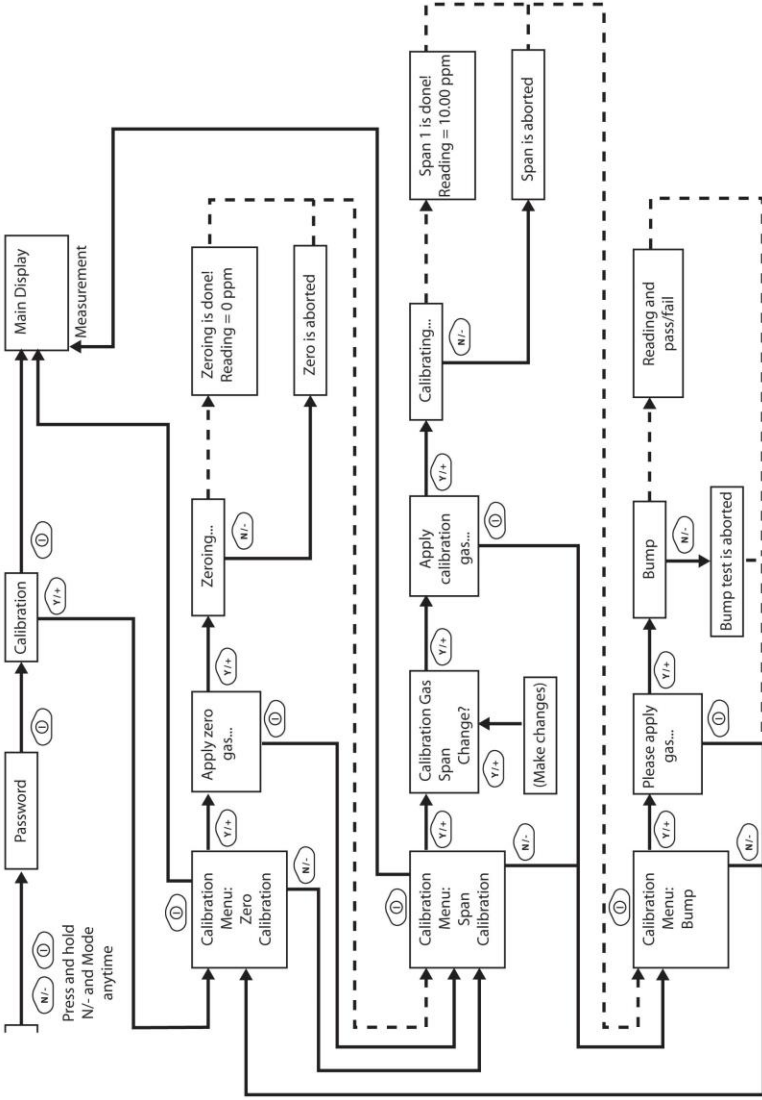

**Note:** Dashed line indicates automatic progression.

## Entering Calibration

1. Press and hold [MODE] and [N/-] until you see the Password screen.

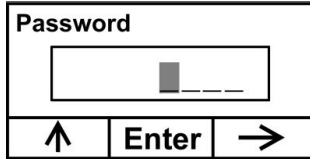

2. In Basic User Level, you do not need a password to perform calibrations. Instead of inputting a password, enter calibration by pressing [MODE].

**Note:** If you inadvertently press [Y/+] and change any of the numbers, simply press [MODE] and you will be directed to the calibration menu.

The Calibration screen is now visible with Zero Calibration highlighted.

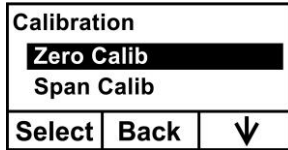

These are your options:

- Press [Y/+] to select the highlighted calibration (Zero Calib or Span Calib).
- Press [MODE] to exit calibration and return to the main display and resume measurement.
- Press [N/-] to toggle the highlighted calibration type.

### Zero (Fresh Air) Calibration

This procedure determines the zero point of the sensor calibration curve. To perform a fresh air calibration, use the calibration adapter to connect the instrument to a “fresh” air source such as from a cylinder or Tedlar bag (optional accessory). The “fresh” air is clean, dry air without organic impurities and an oxygen value of 20.9%. If such an air cylinder is not available, any clean ambient air without detectable contaminants or a charcoal filter can be used.

At the Zero Calibration menu, you can proceed to perform a Zero calibration or bypass Zero calibration and perform a Span calibration. You may also go back to the initial Calibration menu if you want to exit calibration.

- Press [Y/+] to start calibration.
- Press [MODE] to quit and return to the main calibration display.

If you have pressed [Y/+] to enter Zero calibration, then you will see this message:

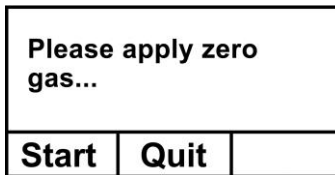

1. Turn on your Zero calibration gas.
2. Press [Y/+] to start calibration.

**Note:** At this point, you may press [MODE] if you decide that you do not want to initiate calibration. This will take you directly to the Calibration menu, highlighted for Span calibration.

## MiniRAE 3000 User's Guide

3. Zero calibration starts a 30-second countdown and displays this message:

Zeroing...

During the zeroing process, the instrument performs the Zero calibration automatically and does not require any action on your part.

**Note:** To abort the zeroing process at any time and proceed to Span calibration, press [N/-] at any time while zeroing is being performed. You will see a confirmation message that says "Zero aborted!" and then the Span calibration menu appears.

When Zero calibration is complete, you see this message:

Zeroing is done!  
Reading = 0.0 ppm

The instrument will then show the Calibration menu on its display, with Span Calib highlighted.

### Span Calibration

This procedure determines the second point of the sensor calibration curve for the sensor. A cylinder of standard reference gas (span gas) fitted with a 500 cc/min. flow-limiting regulator or a flow-matching regulator is the simplest way to perform this procedure. Choose the 500 cc/min. regulator only if the flow rate matches or slightly exceeds the flow rate of the instrument pump. Alternatively, the span gas can first be filled into a Tedlar bag or delivered through a demand-flow regulator. Connect the calibration adapter to the inlet port of the instrument, and connect the tubing to the regulator or Tedlar bag.

Another alternative is to use a regulator with >500 cc/min flow but allow the excess flow to escape through a T or an open tube. In the latter method, the span gas flows out through an open tube slightly wider than the probe, and the probe is inserted into the calibration tube.

At the Span Calibration menu, you perform a Span calibration. You may also go back to the Zero calibration menu or to the initial Calibration menu if you want to exit calibration.

- Press [Y/+] to enter Span calibration.
- Press [N/-] to skip Span calibration and return to Zero calibration.
- Press [MODE] to exit Span calibration and return to the top calibration menu.

If you have pressed [Y/+] to enter Span calibration, then you will see the name of your Span gas (the default is isobutylene) and the span value in parts per million (ppm). You will also see this message that prompts you:

<b>C. Gas = Isobutene</b>		
<b>Span = 100 ppm</b>		
<b>Please apply gas 1...</b>		
<b>Start</b>	<b>Quit</b>	

1. Turn on your span calibration gas.
2. Press [Y/+] to initiate calibration.



## MiniRAE 3000 User's Guide

**Note:** You may press [MODE] if you decide that you do not want to initiate calibration. This will abort the span calibration and take you directly to the Calibration menu for Zero calibration.

3. Span calibration starts and displays this message:

Calibrating...

During the Span calibration process, there is a 30-second countdown and the instrument performs the Span calibration automatically. It requires no actions on your part.

**Note:** If you want to abort the Span calibration process, press [N/-] at any time during the process. You will see a confirmation message that says "Span is aborted!" and then the Zero calibration menu appears. You can then proceed to perform a Zero calibration, perform a Span calibration, or exit to the topmost Calibration menu.

When Span calibration is complete, you see a message similar to this (the value is an example only):

Span 1 is done!  
Reading = 100.0 ppm

The instrument then exits Span calibration and shows the Zero calibration menu on its display.

**Note:** The reading should be very close to the span gas value.

## **Exiting Two-Point Calibration In Basic User Level**

When you are done performing calibrations, press [MODE], which corresponds with “Back” on the display. You will see the following message:

Updating settings...

The instrument updates its settings and then returns to the main display. It begins or resumes monitoring.

### Three-Point Calibration

For enhanced accuracy, it is possible to perform a second Span calibration in addition to the Zero and Span calibrations outlined in the previous section. Your instrument first must be set to allow this third calibration. This requires using ProRAE Studio software and a PC, as well as a higher concentration of calibration gas.

**Note:** Once the third calibration is set, you do not need to use ProRAE Studio to allow future 3-point calibrations. Also, you can only disable 3-point calibration capability by using ProRAE Studio again.

Perform the Zero and Span calibrations. After the first Span calibration (Span 1) is completed, the display a second Span calibration (Span 2) can be performed. The process is identical to the first calibration. As in the Span 1 calibration, you may exit and return to the Zero calibration screen if you choose not to perform this calibration or to abort it.

**Note:** If a bump test is available, it appears after the last calibration in the menu. See “Two-Point Calibration,” page 38, for details. Also, refer to page 53 for details on how to perform a bump test.

# MiniRAE 3000 User's Guide

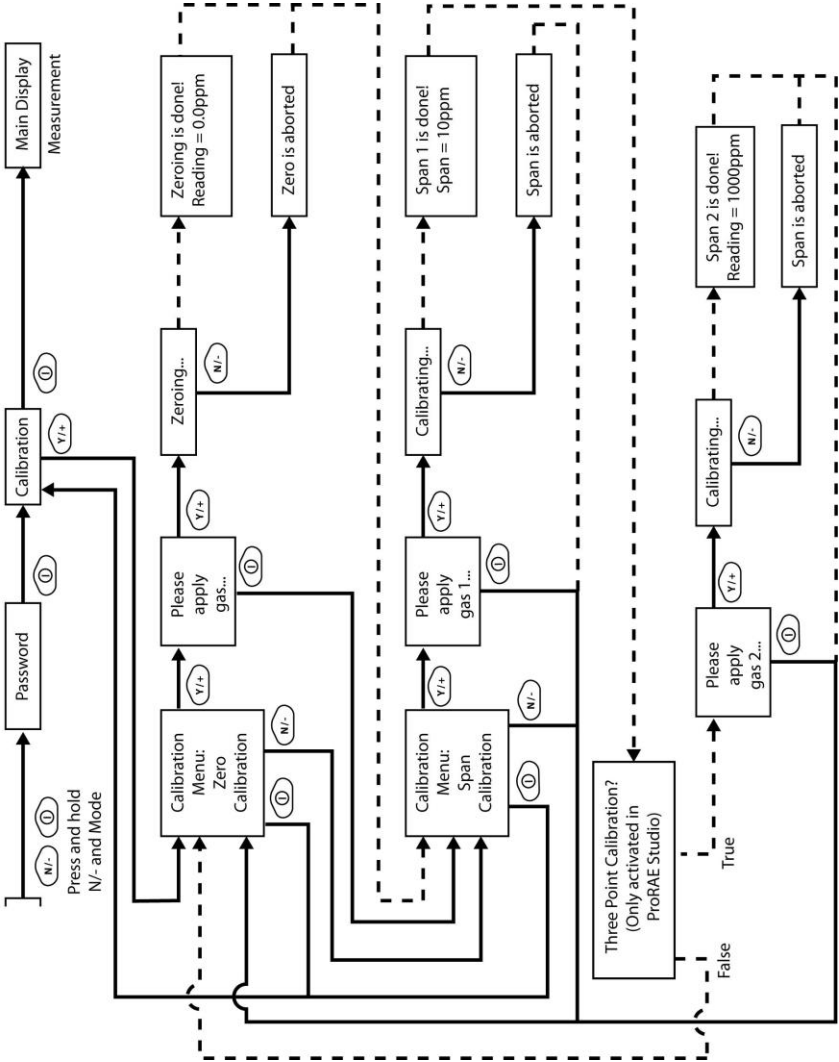

**Note:** Dashed line indicates automatic progression.

## MiniRAE 3000 User's Guide

### Span 2 Calibration

A cylinder of standard reference gas (span gas) fitted with a 500 cc/min. flow-limiting regulator or a flow-matching regulator is the simplest way to perform this procedure.

**Note:** This gas should be of a higher concentration than the gas used for Span 1 calibration.

Choose the 500 cc/min. regulator only if the flow rate matches or slightly exceeds the flow rate of the instrument pump. Alternatively, the span gas can first be filled into a Tedlar bag or delivered through a demand-flow regulator. Connect the calibration adapter to the inlet port of the instrument, and connect the tubing to the regulator or Tedlar bag.

Another alternative is to use a regulator with >500 cc/min flow but allow the excess flow to escape through a T or an open tube. In the latter method, the span gas flows out through an open tube slightly wider than the probe, and the probe is inserted into the calibration tube.

At the Span Calibration menu, you perform a Span calibration. You may also go back to the Zero calibration menu or to the initial Calibration menu if you want to exit calibration.

- Press [Y/+] to enter Span 2 calibration.
- Press [N/-] to skip Span calibration and return to Zero calibration.
- Press [MODE] to exit Span calibration and return to the top calibration menu.

If you have pressed [Y/+] to enter Span calibration, then you will see the name of your Span gas (the default is isobutylene) and the span value in parts per million (ppm). You will also see this message that prompts you:

Please apply gas...

4. Turn on your span calibration gas.
5. Press [Y/+] to initiate calibration.

## MiniRAE 3000 User's Guide

**Note:** You may press [MODE] if you decide that you do not want to initiate calibration. This will take you directly to the Calibration menu for Zero calibration.

6. Span calibration starts a 30-second countdown and displays this message:

Calibrating...

During the Span calibration process, the instrument performs the Span calibration automatically and does not require any action on your part.

**Note:** If you want to abort the Span calibration process, press [N/-] at any time during the process. You will see a confirmation message that says "Span is aborted!" and then the Zero calibration menu will appear. You can then proceed to perform a Zero calibration, perform a Span calibration, or exit to the topmost Calibration menu.

When Span calibration is complete, you will see a message similar to this (the value shown here is for example only):

Span 2 is done!  
Reading = 1000 ppm

The instrument then exits Span calibration and shows the Zero calibration menu on its display.

**Note:** The reading should be very close to the span gas value.

### Exiting Three-Point Calibration

When you are done performing calibrations, press [MODE], which corresponds with “Back” on the display. You will see the following message:

Updating settings...

The instrument updates its settings and then returns to the main display. It begins or resumes monitoring.

### Bump Test

RAE Systems recommends that a bump test be conducted prior to each day's use. The purpose of a bump test is to ensure that the instrument's sensors respond to gas and all the alarms are enabled and functional.

- The MiniRAE 3000 must be calibrated if it does not pass a bump test when a new sensor is installed, after sensor maintenance has been performed, or at least once every 180 days, depending on use and sensor exposure to poisons and contaminants.
- Calibration and bump test intervals and procedures may vary due to national legislation and company policy.

To perform a bump test (functional challenge), follow these steps:

1. Select “Bump.”
2. Install the calibration adapter and connect it to a source of calibration gas.
3. Verify that the displayed calibration value meets the concentration specified on the gas cylinder.
4. Start the flow of calibration gas.
5. Press [Y/+] to start the bump test.
6. You can abort the calibration at any time during the countdown by pressing [N/-].

## MiniRAE 3000 User's Guide

7. If the calibration is not aborted, the display shows reading and then tells you whether the bump test passed or failed. If the bump test failed, then it automatically advances to the Calibration screen.

### Important!

Anytime a bump test fails, you should perform a full calibration of the instrument.

## Programming Mode

Programming Mode can be entered from either Hygiene Mode or Search Mode. If the current user mode is Basic, you must provide a 4-digit password to enter.

### Entering Programming Mode

1. Press and hold [MODE] and [N/-] until you see the Password screen.

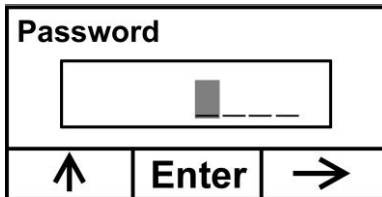

2. Input the 4-digit password:

- Increase the number from 0 through 9 by pressing [Y/+].
- Step from digit to digit using [N/-].
- Press [MODE] when you are done.

If you make a mistake, you can cycle through the digits by pressing [N/-] and then using [Y/+] to change the number in each position.



## MiniRAE 3000 User's Guide

**Note:** The default password is 0000.

When you have successfully entered Programming Mode, you see this screen:

### Calibration

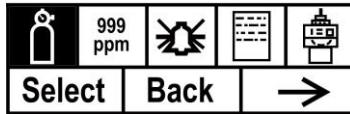

Note: The password can only be changed by connecting the instrument to a PC running ProRAE Studio software. Follow the instructions in ProRAE Studio to change it.

## MiniRAE 3000 User's Guide

The Calibration label is shown and its icon is highlighted, but you can press [N/-] to step from one programming menu to the next, with the name of the menu shown at the top of the display and the corresponding icon highlighted. As you repeatedly press [N/-], the selection moves from left to right, and you see these screens:

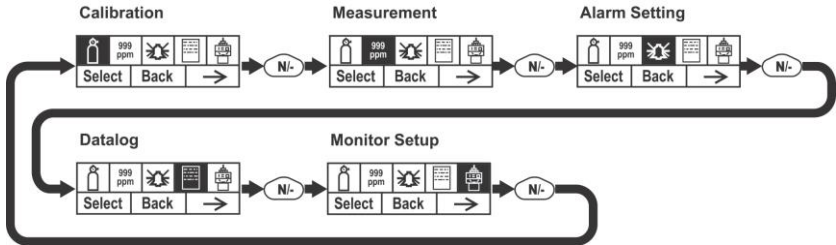

**Note:** When you reach Monitor Setup and press [N/-], the menu cycles back to Calibration.

## Programming Mode Menus

The Programming Mode allows anyone with the password to change the instrument's settings, calibrate the instrument, modify the sensor configuration, enter user information, etc. Programming Mode has five menus. Each menu includes several sub-menus to perform additional programming functions.

This table shows the menus and sub-menus:

## MiniRAE 3000 User's Guide

				
<b>Calibration</b>	<b>Measurement</b>	<b>Alarm Setting</b>	<b>Datalog</b>	<b>Monitor Setup</b>
Zero Calibration	Meas. Gas	High Alarm	Clear Datalog	Radio Power
Span Calibration	Meas. Unit	Low Alarm	Interval	Op Mode
Bump		STEL Alarm	Data Selection	Site ID
		TWA Alarm	Datalog Type	User ID
		Alarm Mode		User Mode
		Buzzer & Light		Date
				Time
				Pump Duty Cycle
				Pump Speed
				Temperature Unit
				Language
				Real Time Protocol
				Power On Zero
				Unit ID
				LCD Contrast
				Lamp ID
				PAN ID
				Mesh Channel
				Mesh Interval

# MiniRAE 3000 User's Guide

Once you enter Programming Mode, the LCD displays the first menu, Calibration. Each subsequent menu is accessed by pressing [N/-] repeatedly until the desired menu is displayed. To enter a sub-menu of a menu, press [Y/+].

## Exiting Programming Mode

To exit Programming Mode and return to normal operation, press [MODE] once at any of the programming menu displays. You will see "Updating Settings..." as changes are registered and the mode changes.

## Navigating Programming Mode Menus

Navigating through the Programming Mode menus is easy and consistent, using a single interface format of "Select," "Back" and "Next" at the top level. The three control buttons correspond to these choices as shown:

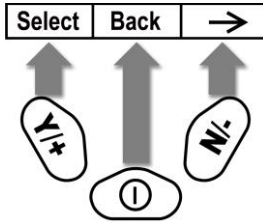

**Note:** Pressing [MODE] in the Programming Mode's top level causes the instrument to exit Programming Mode and return to monitoring.

The three keys perform the following functions in Programming Mode:

Key	Function in Programming Mode
[MODE]:	Exit menu when pressed momentarily or exit data entry mode
[Y/+]:	Increase alphanumeric value for data entry or confirm (yes) for a question
[N/-]:	Provides a "no" response to a question

## Calibration

Two types of calibration are available: Zero (fresh air) and Span.

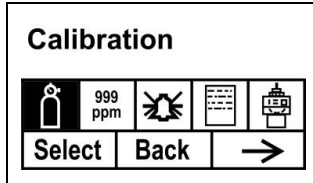

Select Zero or Span Calibration by pressing [N/+]. Once your choice is highlighted, press [Y/+].

### Zero Calibration

The procedure for performing a zero calibration is covered on page 41.

### Span Calibration

The procedure for performing a basic span calibration is covered on page 41.

### Bump

The procedure for performing a bump calibration is covered on page 53.

A bump test can be performed either manually or using the AutoRAE 2 Automatic Test and Calibration System. When a bump test is done manually, the instrument makes a pass/fail decision based on sensor performance, but the user still has the responsibility to make sure all the alarms are enabled and functional.

**Note:** Bump testing and calibration can be performed using an AutoRAE 2 Automatic Test & Calibration System. An AutoRAE 2 bump test takes care of both the sensor and alarm tests. Consult the AutoRAE 2 User's guide for details.

## MiniRAE 3000 User's Guide

### IMPORTANT!

If the instrument does not pass a bump test, perform a full calibration. If calibration also fails, the PID sensor or lamp may require cleaning or replacement. If the instrument repeatedly fails to calibrate, turn it off and refer it for servicing.

## Measurement

The sub-menus for Measurement are Measurement Gas and Measurement Unit.

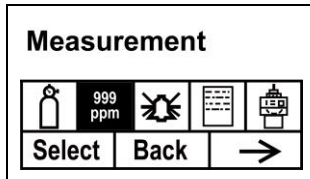

## Meas. Gas

Measurement gases are organized in four lists:

- My List is a customized list of gases that you create. It contains a maximum of 10 gases and can only be built in ProRAE Studio on a PC and transferred to the instrument. **Note:** The first gas in the list is always isobutylene (it cannot be removed from the list).
- Last Ten is a list of the last ten gases used by your instrument. The list is built automatically and is only updated if the gas selected from Custom Gases or Library is not already in the Last Ten. This ensures that there is no repetition.
- Gas Library is a library that consists of all the gases found in RAE Systems' Technical Note TN-106 (available online at [www.raesystems.com](http://www.raesystems.com)).
- Custom Gases are gases with user-modified parameters. Using ProRAE Studio, all parameters defining a gas can be modified,

## MiniRAE 3000 User's Guide

including the name, span value(s), correction factor, and default alarm limits.

1. Scroll through each list by pressing [N/-].
2. Press [Y/+] to select one (My List, Last Ten, Gas Library, or Custom Gases).
3. Once you are in one of the categories, press [N/-] to scroll through its list of options and [Y/+] to select one. (If you press [MODE], you exit to the next submenu.)
4. Press [Y/+] to save your choice or [N/-] to undo your selection.

Leave the sub-menu and return to the Programming Mode menus by pressing [MODE].

### Meas. Unit

Standard available measurement units include:

Abbreviation	Unit	MiniRAE 3000
ppm	parts per million	Yes
ppb	parts per billion	
mg/m <sup>3</sup>	milligrams per cubic meter	Yes
ug/m <sup>3</sup>	micrograms per cubic meter	

- Scroll through the list by pressing [N/-].
- Select by pressing [Y/+] .
- Save your selection by pressing [Y/+] or undo your selection by pressing [N/-].

Leave the sub-menu and return to the Programming Mode menus by pressing [MODE].

## MiniRAE 3000 User's Guide

### Alarm Setting

During each measurement period, the gas concentration is compared with the programmed alarm limits (gas concentration alarm limit settings: Low, High, TWA and STEL). If the concentration exceeds any of the preset limits, the loud buzzer and red flashing LED are activated immediately to warn of the alarm condition.

An alarm signal summary is shown on page 33.

In this menu, you can change the High and Low alarm limits, the STEL limit, and the TWA. Press [Y/+] to enter the Alarm Setting menu.

**Note:** All settings are shown in ppb (parts per billion), or  $\mu\text{g}/\text{m}^3$  (micrograms per cubic meter), depending on your setting.

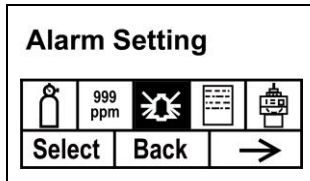

1. Scroll through the Alarm Limit sub-menu using the [N/-] key until the display shows the desired limit to be changed (High Alarm, Low Alarm, STEL Alarm, and TWA Alarm)
  2. Press [Y/+] to select one of the alarm types. The display shows a flashing cursor on the left-most digit of the previously stored alarm limit.
  3. Press [Y/+] to increase each digit's value.
  4. Press [N/-] to advance to the next digit.
  5. Again, use [Y/+] to increase the number.
- Repeat this process until all numbers are entered.

Press [MODE] when you are done.

- Press [Y/+] to save the changes.
  - Press [N/-] to undo the changes and revert to the previous settings.
- When all alarm types have been changed or bypassed, press [MODE] to exit to the Programming Menu.



## MiniRAE 3000 User's Guide

### High Alarm

You can change the High Alarm limit value. The value is typically set by the instrument to match the value for the current calibration gas. It is expressed in parts per billion (ppb). **Note:** The default value depends on the measurement gas.

To change the High Alarm value:

1. Press [Y/+] to increase each digit's value.
2. Press [N/-] to advance to the next digit.
3. Again, use [Y/+] to increase the number.

Repeat this process until all numbers are entered.

When you have completed your selections, press [MODE]. You will see two choices: Save and Undo. You have the opportunity to register the new settings or to change your mind and revert to your previous settings.

Press [Y/+] to save the changes.

Press [N/-] to undo the changes and revert to the previous settings.

### Low Alarm

You can change the Low Alarm limit value. The value is typically set by the instrument to match the value for the current calibration gas. It is expressed in parts per billion (ppb). **Note:** The default value depends on the measurement gas.

To change the Low Alarm value:

1. Press [Y/+] to increase each digit's value.
2. Press [N/-] to advance to the next digit.
3. Again, use [Y/+] to increase the number.

Repeat this process until all numbers are entered.

## MiniRAE 3000 User's Guide

When you have completed your selections, press [MODE]. You will see two choices: Save and Undo. You have the opportunity to register the new settings or to change your mind and revert to your previous settings.

- Press [Y/+] to save the changes.
- Press [N/-] to undo the changes and revert to the previous settings.

### STEL Alarm

You can change the STEL Alarm limit value. The value is typically set by the instrument to match the value for the calibration gas. It is expressed in parts per billion (ppb). **Note:** The default value depends on the measurement gas.

To change the STEL Alarm value:

1. Press [Y/+] to increase each digit's value.
2. Press [N/-] to advance to the next digit.
3. Again, use [Y/+] to increase the number.

Repeat this process until all numbers are entered.

When you have completed your selections, press [MODE]. You will see two choices: Save and Undo. You have the opportunity to register the new settings or to change your mind and revert to your previous settings.

- Press [Y/+] to save the changes.
- Press [N/-] to undo the changes and revert to the previous settings.

## MiniRAE 3000 User's Guide

### TWA Alarm

You can change the TWA (time-weighted average) Alarm limit value. The value is typically set by the instrument to match the value for the calibration gas. It is expressed in parts per billion (ppb). **Note:** The default value depends on the measurement gas.

To change the TWA Alarm value:

1. Press [Y/+] to increase each digit's value.
2. Press [N/-] to advance to the next digit.
3. Again, use [Y/+] to increase the number.

Repeat this process until all numbers are entered.

When you have completed your selections, press [MODE]. You will see two choices:

- Save
- Undo

You have the opportunity to register the new settings or to change your mind and revert to your previous settings.

- Press [Y/+] to save the changes.
- Press [N/-] to undo the changes and revert to the previous settings.

## MiniRAE 3000 User's Guide

### Alarm Mode

There are two selectable alarm modes:

**Auto Reset** When the alarm condition is no longer present, the alarm stops and automatically resets itself.

**Latch** When the alarm is triggered, you can manually stop the alarm.  
The latched setting only controls alarms for High Alarm, Low Alarm, STEL Alarm, and TWA alarm.

**Note:** To clear an alarm when the instrument is set to "Latched," press [Y/+] when the main (Reading) display is shown.

1. Press [N/-] to step from one alarm type to the other.
2. Press [Y/+] to select an alarm type.

When you have completed your selections, press [MODE].

You will see two choices: Save and Undo. You have the opportunity to register the new settings or to change your mind and revert to your previous settings.

- Press [Y/+] to save the changes.
- Press [N/-] to undo the changes and revert to the previous settings.

# MiniRAE 3000 User's Guide

## Buzzer & Light

The buzzer and light alarms can be programmed to be on or off individually or in combination. Your choices are:

- Both on
  - Light only
  - Buzzer only
  - Both off
1. Press [N/-] to step from one option to the next.
  2. Press [Y/+] to make your selection (the dark circle in the “radio button” indicates your selection).
  3. When you have completed your selections, press [MODE].

You will see two choices: Save and Undo. You have the opportunity to register the new settings or to change your mind and revert to your previous settings.

- Press [Y/+] to save the changes.
- Press [N/-] to undo the changes and revert to the previous settings.

## Datalog

The instrument calculates and stores the concentration and ID of each sample taken. In the datalog sub-menu, a user can perform the tasks and functions shown below.

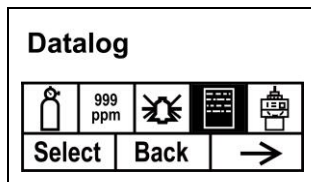

## MiniRAE 3000 User's Guide

1. Scroll through the Datalog sub-menu using the [N/-] key until the display shows the desired parameter to be changed:

Clear Datalog

Interval

Data Selection

Datalog Type

2. Press [Y/+] to make your selection. Exit by pressing [MODE] for Back.

### Clear Datalog

This erases all the data stored in the datalog.

**Note:** Once the datalog is cleared, the data cannot be recovered.

Press [Y/+] to clear the datalog. The display asks, “Are you sure?”

- Press [Y/+] if you want to clear the datalog. When it has been cleared, the display shows “Datalog Cleared!”
- Press [N/-] if you do not want to clear the datalog.

The display changes, and you are taken to the next sub-menu, Interval.

### Interval

Intervals are shown in seconds. The default value is 60 seconds. The maximum interval is 3600 seconds.

1. Press [Y/+] to increase each digit's value.
2. Press [N/-] to advance to the next digit.
3. Again, use [Y/+] to increase the number.

## MiniRAE 3000 User's Guide

Repeat this process until all numbers are entered.

When you have completed your selections, press [MODE].

You will see two choices: Save and Undo. You have the opportunity to register the new settings or to change your mind and revert to your previous settings.

- Press [Y/+] to save the changes.
- Press [N/-] to undo the changes and revert to the previous settings.

### Data Selection

Data Selection allows you to select which types of data are stored and made available when you offload your datalog to a computer via ProRAE Studio software.

You can choose any or all of three types of data (you must choose at least one):

- Average
  - Maximum
  - Minimum
1. Press [N/-] to step from one option to the next. The highlighter indicates your choice.
  2. Press [Y/+] to toggle your selection on or off (the check box indicates “on” with an “X”).
  3. When you have completed your selections, press [MODE].

You will see two choices: Save and Undo. You have the opportunity to register the new settings or to change your mind and revert to your previous settings.

- Press [Y/+] to save the changes.
- Press [N/-] to undo the changes and revert to the previous settings.

## MiniRAE 3000 User's Guide

### Datalog Type

The instrument has three datalog types:

- Auto** Default mode. Collects datalog information when the instrument is sampling.
- Manual** Datalogging occurs only when the instrument's datalogging is manually started (see below for details).
- Snapshot** Datalogs only during single-event capture sampling.
- Note:** You can only choose one datalog type to be active at a time.

1. Press [N/-] to step from one option to the next.
2. Press [Y/+] to make your selection (the dark circle in the "radio button" indicates "on").
3. When you have completed your selection, press [MODE].

You will see two choices: Save and Undo. You have the opportunity to register the new settings or to change your mind and revert to your previous settings.

- Press [Y/+] to save the changes.

Press [N/-] to undo the changes and revert to the previous settings.

### Manual Datalog

When the instrument is set to Manual Datalog, you turn datalogging on and off by stepping through the displays from the Main Display, and then pressing the keys to select datalog on/off functions.

- When you reach the screen that says "Start Datalog?" press [Y/+] to start it. You see "Datalog Started," confirming that datalogging is now on.

When you reach the screen that says "Stop Datalog?" press [Y/+] to stop it. You see "Datalog Stopped," confirming that datalogging is now off.





# MiniRAE 3000 User's Guide

## Snapshot Datalog

When the instrument is in Snapshot datalogging mode, it captures a single “snapshot” of the data at the moment of your choosing. Whenever the instrument is on and it is set to Snapshot, all you have to do is press [MODE] each time you want to capture a snapshot of the data at that instant.

When you send the data to a computer using ProRAE Studio, the data snapshots are uniquely identified by time and other parameters.

## Monitor Setup

Many settings can be accessed in this menu, including setting the date and time and adjusting the pump's on/off duty cycle.

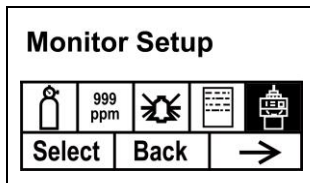

## Radio Power

The radio connection can be turned on or off.

1. Press [N/-] to step from one option to the next (on or off).
2. Press [Y/+] to make your selection (the dark circle in the “radio button” indicates that the option is selected).
3. When you have completed your selection, press [MODE].
  - Press [Y/+] to accept the new radio setting (on or off).
  - Press [N/-] to discard the change and move to the next sub-menu.

## MiniRAE 3000 User's Guide

### Op Mode

Under Monitor Setup is “Op Mode.”

Press [Y/+] to select.

You see two options (one is highlighted):

Hygiene  
Search

The current mode is indicated by a dark circle within the circle in front of either Hygiene or Search.

1. Select Hygiene or Search by pressing [N/-]. The highlighting changes from one to the other each time you press [N/-].
2. Press [Y/+] to select that mode for the instrument.
3. Press [MODE] when you want to register your selection to place the instrument in the selected mode.
4. Press [Y/+] to commit the change and exit to the Monitor Setup screen, or press [N/-] to Undo (exit to the Monitor Setup screen without changing the Mode).

### Site ID

Enter an 8-digit alphanumeric/character Site ID in the programming mode. This Site ID is included in the datalog report.

1. Press [Y/+] and the display shows the current site ID. Example: “RAE00001.” Note that the left-most digit flashes to indicate it is the selected one.
2. Press [Y/+] to step through all 26 letters (A to Z) and 10 numerals (0 to 9).  
**Note:** The last four digits must be numerals.
3. Press [N/-] to advance to the next digit. The next digit to the right flashes.

## MiniRAE 3000 User's Guide

Repeat this process until all eight digits of the new site ID are entered.

Press [MODE] to exit.

If there is any change to the existing site ID, the display shows "Save?" Press [Y/+] to accept the new site ID. Press [N/-] to discard the change and move to the next sub-menu.

### User ID

Enter an 8-digit alphanumeric User ID in the programming mode. This User ID is included in the datalog report.

1. Press [Y/+] and the display shows the current User ID. Example: "RAE00001." Note that the left-most digit flashes to indicate it is the selected one.
2. Press [Y/+] to step through all 26 letters (A to Z) and 10 numerals (0 to 9).
3. Press [N/-] to advance to the next digit. The next digit to the right flashes.

Repeat this process until all eight digits of the new User ID are entered.

Press [MODE] to exit.

If there is any change to the existing User ID, the display shows "Save" Press [Y/+] to accept the new site ID. Press [N/-] to discard (undo) the change and move to the next sub-menu.

### User Mode

The instrument has two user modes:

**Basic** Basic users can only see and use a basic set of functions.

**Advanced** Advanced users can see all screens and perform all available functions.

**Note:** The default value for User Mode is Basic.

## MiniRAE 3000 User's Guide

To change the User Mode:

1. Press [N/-] to step from one option to the next. The highlighting changes each time you press [N/-].
2. Press [Y/+] to make your selection (the dark circle in the “radio button” indicates “on”).
3. When you have completed your selection, press [MODE].
4. Press [Y/+] to accept the new User Mode. Press [N/-] to discard the change and move to the next sub-menu.

### Date

The Date is expressed as Month/Day/Year, with two digits for each.

1. Press [Y/+] and the display shows the current date. Note that the left-most digit flashes to indicate it is selected.
2. Press [Y/+] to step through all 10 numerals (0 to 9).
3. Press [N/-] to advance to the next digit. The next digit to the right flashes.

Repeat this process until all six digits of the new date are entered.

Press [MODE] to exit.

- Press [Y/+] to save the new date.
- Press [N/-] to undo the change and move to the next sub-menu.

## MiniRAE 3000 User's Guide

### Time

The Time is expressed as Hours/Minutes/Seconds, with two digits for each. The time is in 24-hour (military) format.

1. Press [Y/+] and the display shows the current time. Note that the left-most digit flashes to indicate it is selected.
2. Press [Y/+] to step through all 10 numerals (0 to 9).
3. Press [N/-] to advance to the next digit. The next digit to the right flashes.

Repeat this process until all six digits of the new time are entered.

Press [MODE] to exit.

- Press [Y/+] to save the new date.
- Press [N/-] to undo the change and move to the next sub-menu.

### Pump Duty Cycle

The pump's duty cycle is the ratio of its on time to off time. The duty cycle ranges from 50% to 100% (always on), and the period is 10 seconds. Therefore, a duty cycle of 60% means that the pump is on for 6 seconds and off for four seconds. Duty cycling is employed by the instrument to clean the PID. A lower duty cycle has a greater effect on keeping the PID clean than a higher duty cycle.

**Important!** Pump duty cycling is interrupted when the instrument senses a gas. The pump's duty cycle is disabled when the measurement is greater than the 2ppm threshold and is re-enabled when the reading falls below 90% of the threshold (1.8 ppm).

1. Press [Y/+] to increase the value.
2. When you have completed your selection, press [MODE].
  - Press [Y/+] to save the new duty cycle value.
  - Press [N/-] to undo the change and move to the next sub-menu.

## MiniRAE 3000 User's Guide

### Pump Speed

The pump can operate at two speeds, high and low. Running at low speed is quieter and conserves a small amount of power. There is almost no difference in sampling accuracy.

1. Press [N/-] to step from one option to the next.
2. Press [Y/+] to make your selection (the dark circle in the “radio button” indicates “on”).
3. When you have completed your selection, press [MODE].
  - Press [Y/+] to save the new temperature unit.
  - Press [N/-] to undo the change and move to the next sub-menu.

### Temperature Unit

The temperature display can be switched between Fahrenheit and Celsius units.

1. Press [N/-] to step from one option to the next.
2. Press [Y/+] to make your selection (the dark circle in the “radio button” indicates “on”).
3. When you have completed your selection, press [MODE].
  - Press [Y/+] to save the new temperature unit.
  - Press [N/-] to undo the change and move to the next sub-menu.

## MiniRAE 3000 User's Guide

### Language

English is the default language, but other languages can be selected for the instrument.

1. Press [N/-] to step from one option to the next.
2. Press [Y/+] to make your selection (the dark circle in the “radio button” indicates “on”).
3. When you have completed your selection, press [MODE].
  - Press [Y/+] to save your new language choice.
  - Press [N/-] to undo it and return to the previous language selection.

### Real Time Protocol

Real Time Protocol is the setting for data transmission.

The choices are:

- |                       |  |
|-----------------------|--|
| <b>P2M (cable)</b>    | Point to multipoint. Data is transferred from the instrument to multiple locations using a wired connection. Default data rate: 19200 bps. |
| <b>P2P (cable)</b>    | Point to point. Data is transferred only between the instrument and one other location, such as a computer. Default data rate: 9600 bps.   |
| <b>P2M (wireless)</b> | Point to multipoint, wireless. Data is transferred wirelessly and can be received by multiple receivers.                                   |

1. Press [N/-] to step from one option to the next.
2. Press [Y/+] to make your selection (the dark circle in the “radio button” indicates “on”).
3. When you have completed your selection, press [MODE].
  - Press [Y/+] to save the new real-time communications protocol.
  - Press [N/-] to undo the change and move to the next sub-menu.



## MiniRAE 3000 User's Guide

### Power On Zero

When Power On Zero is on, the instrument performs a zero calibration when it is turned on.

1. Press [N/-] to step from one option to the next.
2. Press [Y/+] to make your selection (the dark circle in the “radio button” indicates your selection).
3. When you have completed your selection, press [MODE].
  - Press [Y/+] to save the change.
  - Press [N/-] to discard the change and move to the next sub-menu.

### Unit ID

This three-digit number keeps data separated by instrument when more than one instrument is used in a network. If multiple sensing units are attempting to communicate with the same Host, then the units must all have a different Unit ID.

1. Press [Y/+] to step through all 10 numerals (0 to 9). If you pass the numeral you want, keep pressing [Y/+] until it counts up to 9, it starts counting up from 0 again.
2. Press [N/-] to advance to the next digit. The next digit to the right flashes.

Repeat this process until all three digits of the Unit ID are entered.

3. Press [MODE] when you are done.
  - Press [Y/+] to save the change.
  - Press [N/-] to discard the change and move to the next sub-menu.

## MiniRAE 3000 User's Guide

### LCD Contrast

The display's contrast can be increased or decreased from its default setting. You may not need to ever change the default setting, but sometimes you can optimize the display to suit extreme temperature and ambient brightness/darkness conditions.

- The minimum value is 20.
  - The maximum value is 60.
1. Press [Y/+] to increase the value or [N/-] to decrease the value.
  2. Press [MODE] to save your selection.
    - Press [Y/+] to save your new contrast value.
    - Press [N/-] to undo it and return to the previous value.

### Lamp ID

The instrument must be set to the correct lamp value in order to function correctly. Always match the value that was installed in your instrument from the factory or the value of the PID lamp you are replacing.

1. Press [N/-] to step from one option to the next.
2. Press [Y/+] to make your selection (the dark circle in the "radio button" indicates "on").
3. When you have completed your selection, press [MODE].

### PAN ID

The MiniRAE 3000 and any other devices that you want to interconnect wirelessly must have the same PAN ID. You can set the PAN ID in the instrument or through ProRAE Studio II.

1. Press [N/-] to advance through the digits from left to right.
2. Press [Y/+] to ] to advance through the numbers (1, 2, 3, etc.).
3. Press [MODE] to register your choice when you are done.

## MiniRAE 3000 User's Guide

### Mesh Channel

**Note:** For mesh radio modems operating at 868MHz, only channel 0 is available. For other frequencies, channels 1 through 10 are allowed.

1. Press [Y/+] to increase the number and [N/-] to advance to the next digit.
2. After moving to the last digit and making changes, press [MODE].
  - Press [Y/+] to save the change.
  - Press [N/-] to undo the change.

### Mesh Interval

Set the time interval at which the instrument's mesh radio sends out a signal. This can range from once every 10 seconds to once every four minutes (240 seconds). The transmission frequency is user-adjustable, but a rate of at least once every 30 seconds is recommended. **Note:** Shorter intervals reduce battery life.

1. Press [N/-] to step from one option to the next.
2. Press [Y/+] to make a selection.
3. When you are done, press [MODE].

# Hygiene Mode

The instrument usually operates in Hygiene Mode, which provides basic functionality. However, it is possible to operate it in a second mode called Search Mode. Here are the primary differences:

**Hygiene Mode:** Automatic measurements, continuously running and datalogging, and calculates additional exposure values.

**Search Mode:** Manual start/stop of measurements and display of certain exposure values.

## Basic User Level & Hygiene Mode

The default setting is navigated in the following way:

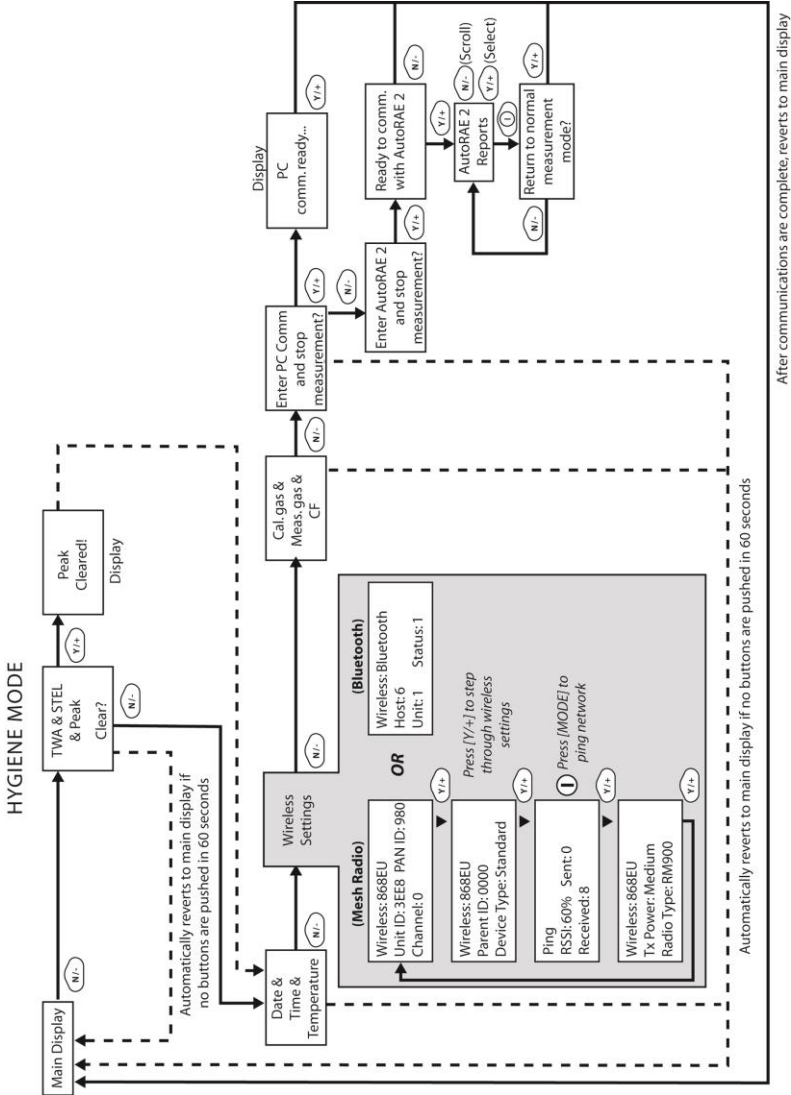

**Note:** Dashed line indicates automatic progression.

## **MiniRAE 3000 User's Guide**

Pressing [N/-] steps you from screen to screen. Options include clearing the Peak value and turning on the instrument's PC Communications for data transfer to a PC.

### Entering Search Mode From Hygiene Mode

In order to change the instrument's operational mode from Hygiene Mode to Search Mode, you must enter the password-protected Programming Mode:

1. Hold [MODE] and [N/-] until you see the password screen.
2. Use [Y/+] to increment to the number you want for the first digit. (If you pass by the desired number, press [Y/+] until it cycles through to 0 again. Then press [Y/+] until you reach the desired number.)
3. Press [N/-] to advance to the next digit.
4. Again press [Y/+] to increment the number.
5. Press [N/-] to advance to the next digit.

Continue the process until all four numbers of the password have been input. Then press [MODE] to proceed.

The screen changes to icons with the label "Calibration."

1. Press [N/-] to advance to "Monitor Setup."
2. Press [Y/+] to select Monitor Setup.

Under Monitor Setup, you will see "Op Mode."

Press [Y/+] to select.

You will see:

Hygiene  
Search

The current mode is indicated by a dark circle within the circle in front of either Hygiene or Search.

1. Select Hygiene or Search by pressing [N/-].
2. Press [Y/+] to place the instrument into the selected mode.

## MiniRAE 3000 User's Guide

3. Press [MODE] when you want to register your selection to place the instrument in the selected mode.
4. Press [Y/+] to commit the change and exit to the Monitor Setup screen, or press [N/-] to Undo (exit to the Monitor Setup screen without changing the Mode).

### Advanced User Level (Hygiene Mode Or Search Mode)

The User Mode called Advanced User Level allows a greater number of parameters to be changed than Basic User Level. It can be used with either of the Operation Modes, Hygiene Mode or Search Mode.

#### Advanced User Level & Hygiene Mode

With the instrument in Operation Mode: Hygiene Mode, enter User Mode: Advanced User Level (refer to the section called Monitor Mode for instructions).

Once you are in Advanced User Level and Hygiene Mode together, you can change the calibration reference and measurement gas, in addition to performing normal monitoring functions.

Pressing [N/-] progresses through the screens, while pressing [Y/+] selects options. Pressing [MODE] makes menu choices when it is shown for “Done” or “Back.” Pressing and holding [Mode] whenever the circle with a vertical line in the middle is shown activates the countdown to shutoff.



# MiniRAE 3000 User's Guide

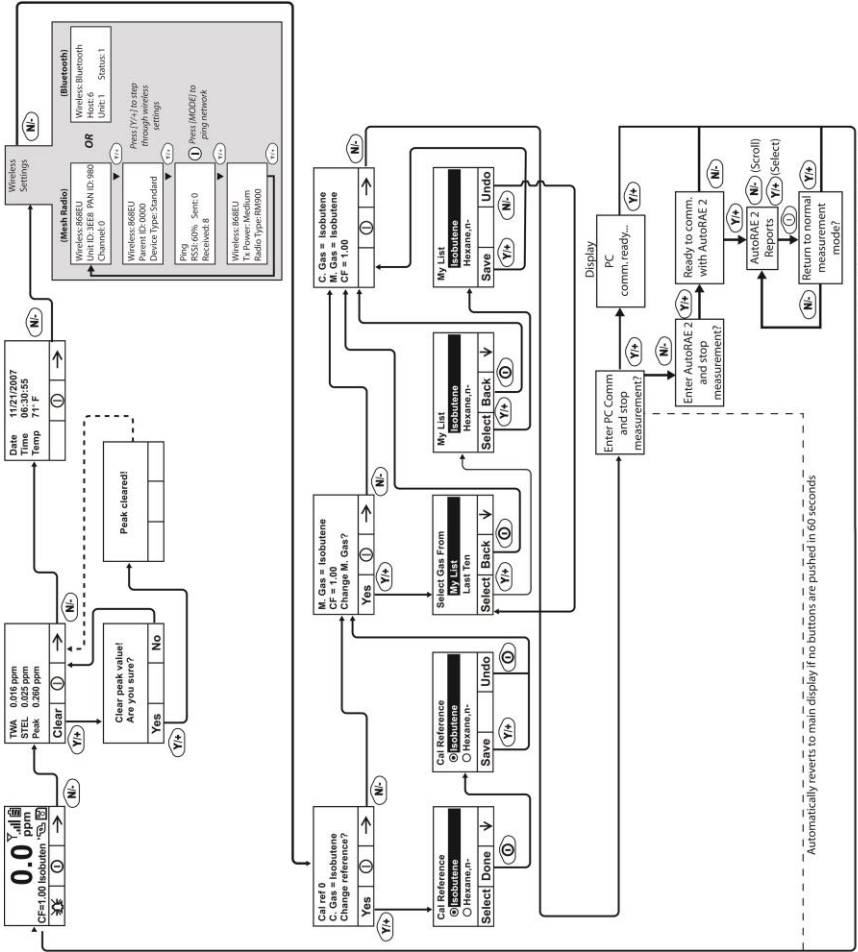

After communications are complete, reverts to main display

**Note:** Dashed line indicates automatic progression.

### Basic User Level & Search Mode

With the instrument in Operation Mode: Search Mode, enter User Mode and select Basic User Level (refer to the section called User Mode for instructions).

When the instrument is in Search Mode, it only samples when you activate sampling. When you see the display that says, "Ready...Start sampling?" press [Y/+] to start. The pump turns on and the instrument begins collecting data. To stop sampling, press [N/-] while the main display is showing. You will see a new screen that says, "Stop sampling?" Press [Y/+] to stop sampling. Press [N/-] if you want sampling to continue.

# MiniRAE 3000 User's Guide

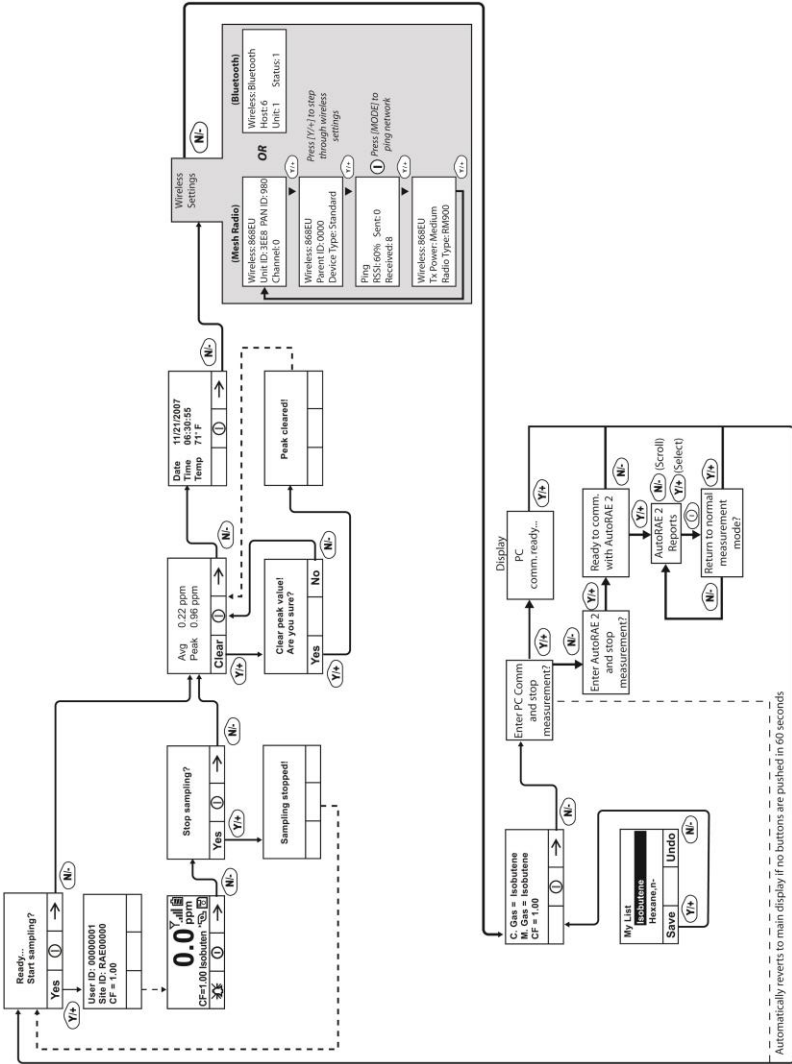

**Note:** Dashed line indicates automatic progression.



### Diagnostic Mode

**IMPORTANT!** Diagnostic Mode is designed for servicing and manufacturing, and therefore is not intended for everyday use, even by advanced users. It provides raw data from sensors and about settings, but only allows adjustment of pump stall parameters, which should only be changed by qualified personnel.

**Note:** If the instrument is turned on in Diagnostic Mode and you switch to User Mode, datalog data remains in raw count form. To change to standard readings, you must restart the instrument.

### Entering Diagnostic Mode

**Note:** To enter Diagnostic Mode, you must begin with the instrument turned off.

Press and hold [Y/+] and [MODE] until the instrument starts.

The instrument goes through a brief startup, and then displays raw data for the PID sensor. These numbers are raw sensor readings without calibration. The instrument is now in Diagnostic Mode.

**Note:** In Diagnostic Mode, the pump and lamp are normally on.

You can enter Programming Mode and calibrate the instrument as usual by pressing both [MODE] and [N/-] for three seconds.

You can enter Monitoring Mode by pressing [MODE] and [Y/+] together for three seconds.

Once the instrument is started up in Diagnostic Mode, you can switch between Diagnostic Mode and Monitoring Mode by pressing and holding [MODE] and [Y/+] simultaneously for two seconds.

In Diagnostic mode, you can step through parameter screens by pressing [MODE].

## MiniRAE 3000 User's Guide

### Adjusting The Pump Stall Threshold

If the gas inlet is blocked but the pump does not shut down, or the pump shuts down too easily with a slight blockage, the pump stall threshold value may be set too high or too low.

Use the following steps to adjust the pump stall threshold:

#### Pump High

In Diagnostic Mode, press the [MODE] key until "Pump High" is displayed. The display shows the maximum, minimum, and stall values for the pump at its high speed. Write down the "Max" reading.

Block the gas inlet and watch the pump current reading (labeled "I") increase. Write down its blocked reading. **Note:** If the pump current reading does not increase significantly (less than 10 counts), then there may be a leak in the gas inlet or the pump is weak or defective.

Add the two readings you wrote down. This is the average of the maximum block count and the maximum idle count. Divide that number by 2. Use the [Y/+] or [N/-] key to increase or decrease the stall value to equal that number.

Press the [MODE] key to exit this display.

#### Pump Low

In Diagnostic Mode, press the [MODE] key until "Pump Low" is displayed. The display shows the maximum, minimum, and stall values for the pump at its low speed. Write down the "Max" reading.

Block the gas inlet and watch the pump current reading (labeled "I") increase. Write down its blocked reading. **Note:** If the pump current reading does not increase significantly (less than 10 counts), then there may be a leak in the gas inlet or the pump is weak or defective.

Add the two readings you wrote down. This is the average of the maximum block count and the maximum idle count. Divide that

## MiniRAE 3000 User's Guide

number by 2. Use the [Y/+] or [N/-] key to increase or decrease the stall value to equal that number.

Press the [MODE] key to exit this display.

### Exiting Diagnostic Mode

You can exit Diagnostic Mode and go directly to Programming Mode or Monitor Mode as outlined above, or you can exit Diagnostic Mode completely.

To exit Diagnostic Mode so that it cannot be re-entered without a restart:

Shut down the instrument. When it is off, restart it by holding the [MODE] key. Diagnostic Mode cannot be entered until the instrument is restarted as outlined in “Entering Diagnostic Mode.”

# Transferring Data To & From A Computer

Once you have connected your instrument cradle to the PC, you can transfer data, including a download of the datalog to the computer and updates of firmware to the instrument (should this ever be necessary).

## Downloading The Datalog To A PC

1. Connect the data cable to the PC and the cradle.
2. Place the instrument into its cradle. The charging LED should be illuminated.
3. Start ProRAE Studio on your PC.
4. From ProRAE Studio, select "Operation" and select Setup Connection.
5. Select the COM port to establish a communication link between the PC and the instrument.
6. To receive the datalog in the PC, select "Downlog Datalog."
7. When you see "Unit Information," click OK.

During the data transfer, the display shows a progress bar.

When the transfer is done, you will see a screen with the datalog information. You can now export this datalog for other use or printing.



### Uploading Firmware To The instrument From A PC

Uploading new firmware to your instrument requires connecting the instrument and PC. Follow these steps to make the connection:

1. Connect the data cable to the PC and the cradle.
2. Place the instrument into its cradle. The charging LED should be illuminated.
3. Start RAEProgrammer 7000 on your PC.
4. From RAEProgrammer 7000, select "Operation" and select Setup Connection.
5. Select the COM port to establish a communication link between the PC and the instrument.
6. Select Operation → Download Firmware.

Once communication is established, follow the instructions that accompany RAEProgrammer 7000 and the firmware to upload the new firmware to your instrument.

**Note:** Check for the latest updates to ProRAEProgrammer 7000 at [www.raesystems.com](http://www.raesystems.com).

### Maintenance

The major maintenance items of the instrument are:

- Battery pack
- Sensor module
- PID lamp
- Sampling pump
- Inlet connectors and filters

**Note: Maintenance should be performed by qualified personnel only.**

**NOTE: The printed circuit board of the instrument is connected to the battery pack even if the power is turned off. Therefore, it is very important to disconnect the battery pack before servicing or replacing any components inside the instrument. Severe damage to the printed circuit board or battery may occur if the battery pack is not disconnected before servicing the unit.**

### Battery Charging & Replacement

When the display shows a flashing empty battery icon, the battery requires recharging. It is recommended to recharge the instrument upon returning from fieldwork. A fully charged battery runs a instrument for 16 hours continuously. The charging time is less than 8 hours for a fully discharged battery. The battery may be replaced in the field (in areas known to be non-hazardous), if required.

#### **WARNING!**

**To reduce the risk of ignition of hazardous atmospheres, recharge battery only in area known to be non-hazardous. Remove and replace battery only in areas known to be non-hazardous.**

## MiniRAE 3000 User's Guide

### Replacing The Li-ion Battery

1. Turn off the instrument.
2. Located on the rear of the instrument is a battery tab. Slide it down to unlock the battery.

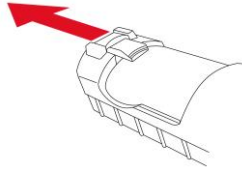

3. Remove the battery pack from the battery compartment by tilting it out.

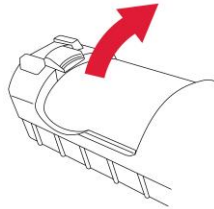

4. Replace a fully charged spare battery pack inside the battery compartment. Make sure the battery pack is oriented properly inside the compartment.
5. Slide the capture tab back up to its locked position.

### Replacing The Alkaline Battery Adapter

An alkaline battery adapter is supplied with each instrument. The adapter (part number 059-3052-000) accepts four AA alkaline batteries (use only Duracell MN1500) and provides approximately 12 hours of operation. The adapter is intended to be used in emergency situations when there is no time to charge the Li-ion battery pack.

To insert batteries into the adapter:

1. Remove the three Philips-head screws to open the compartment.
2. Insert four fresh AA batteries as indicated by the polarity (+/-) markings.
3. Replace the cover. Replace the three screws.

## MiniRAE 3000 User's Guide

To install the adapter in the instrument:

1. Remove the Li-ion battery pack from the battery compartment by sliding the tab and tilting out the battery.
2. Replace it with the alkaline battery adapter
3. Slide the tab back into place to secure the battery adapter.

### **IMPORTANT!**

Alkaline batteries cannot be recharged. The instrument's internal circuit detects alkaline batteries and will not allow recharging. If you place the instrument in its cradle, the alkaline battery will not be recharged. The internal charging circuit is designed to prevent damage to alkaline batteries and the charging circuit when alkaline batteries are installed inside the instrument.

**Note:** When replacing alkaline batteries, dispose of old ones properly.

### **WARNING!**

To reduce the risk of ignition of hazardous atmospheres, recharge the battery only in areas known to be non-hazardous. Remove and replace the battery only in areas known to be non-hazardous.

**Note:** The internal charging circuit is designed to prevent charging to alkaline batteries.

### PID Sensor & Lamp Cleaning/Replacement

The sensor module is made of several components and is attached to the lamp-housing unit as shown below.

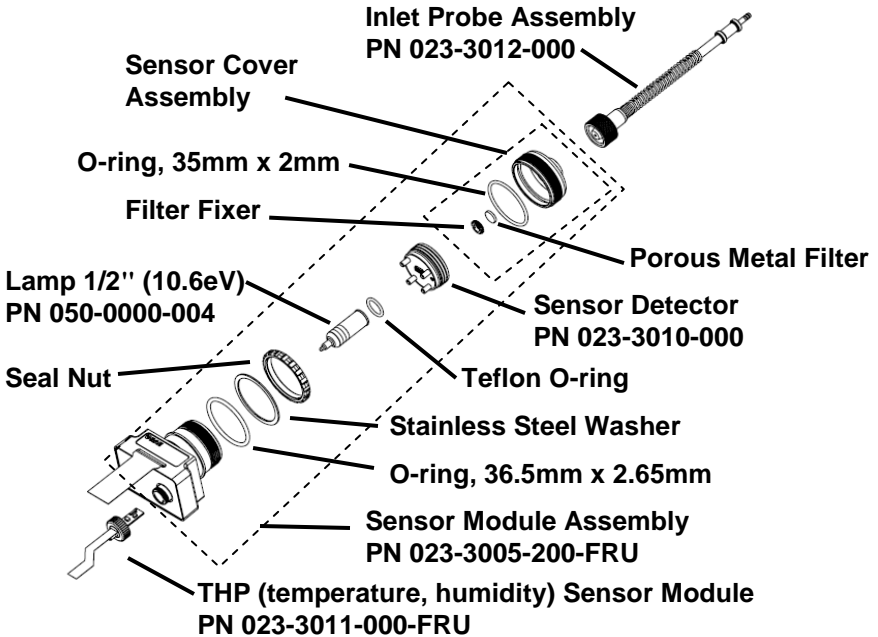

### Sensor Components

**Note:** The cleaning procedure is not normally needed. Clean the PID sensor module, the lamp and the lamp housing only if:

1. The reading is inaccurate even after calibration.
2. The reading is very sensitive to air moisture.
3. A liquid has been sucked into the unit and damaged the unit.

Use of the external filter helps to prevent contamination of the sensor.

To access the sensor components and lamp, gently unscrew the lamp-housing cap, remove the sensor adapter with the gas inlet probe and the metal filter all together. Then hold the PID sensor and pull it straight out. A slight, gentle rocking motion helps release the sensor.

### Cleaning The PID Sensor

Place the entire PID sensor module into GC grade methanol. It is highly recommended that an ultrasound bath to be used to clean the sensor for at least 15 minutes. Then dry the sensor thoroughly. Never touch the electrodes of the sensor by hand.

Also use a methanol-soaked cotton swab to wipe off the lamp housing where it contacts the sensor when the sensor is installed.

Turn over the sensor so that the pins point up and the sensor cavity is visible. Examine the sensor electrodes for any corrosion, damage, or bending out of alignment. The metal sensor electrode “fingers” should be flat and straight. If necessary, carefully bend the sensor fingers to ensure that they do not touch the Teflon portions and that they are parallel to each other. Make sure that the nuts on the sensor pins are snug but not overtight. If the sensor is corroded or otherwise damaged, it should be replaced.

### Cleaning The Lamp Housing Or Changing The Lamp

If the lamp does not turn on, the instrument will display an error message to indicate replacement of the lamp may be required.

1. If the lamp is operational, clean the lamp window surface and the lamp housing by wiping it with GC grade methanol using a cotton swab using moderate pressure. After cleaning, hold the lamp up to the light at an angle to detect any remaining film. Repeat the process until the lamp window is clean. Never use water solutions to clean the lamp. Dry the lamp and the lamp housing thoroughly after cleaning.

**CAUTION: Never touch the window surface with the fingers or anything else that may leave a film. Never use acetone or aqueous solutions.**

2. If the lamp does not turn on, remove the lamp from the lamp housing. Place the lamp O-ring onto the new lamp. Insert the new lamp, avoiding contact with the flat window surface.
3. Reinstall the PID sensor module.
4. Tighten the Lamp Housing Cap.

## MiniRAE 3000 User's Guide

### Determining The Lamp Type

The monitor can accommodate three lamp values: 10.6eV (standard), 9.8eV, and 11.7eV. Always make sure you are using the correct lamp value and that the instrument is set to use that lamp.

Also, when the monitor is running, the lamp type is shown along with the calibration and measurement gas and Correction Factor:

C. Gas = Isobutene		
M. Gas = Isobutene		
CF = 1.00	10.6eV	
	⏴	→

**Note:** This screen can be accessed from the reading screen by pressing [N/-] four times.

You can manually determine the lamp type, too:

1. Turn off the instrument and remove the lamp. Now look at the serial number. The following identify the lamp type:
  - 10.6eV                      SN: 106 2Nxxxxx
  - 9.8eV                        SN: 098 2Nxxxxx
  - 11.7eV                      SN: 117 2Nxxxxx

### Programming The Lamp ID

The correct measurement gas library is used by the instrument when you ensure that the right lamp value is programmed.

To manually select the Lamp ID:

1. Enter the Programming menu.
2. Select Monitor Setup.
3. Scroll down and select the Lamp ID sub-menu.
4. Press [N/-] to scroll down to the desired Lamp ID.
5. Press [Y/+] to select.
6. Press [MODE] to select Done.
7. Select "Save."
8. Return to the main menu.

Recalibrate the instrument before returning it to service.

## MiniRAE 3000 User's Guide

### Sampling Pump

When approaching the end of the specified lifetime of the pump, it will consume higher amount of energy and reduce its sample draw capability significantly. When this occurs, it is necessary to replace or rebuild the pump. When checking the pump flow, make sure that the inlet connector is tight and the inlet tubing is in good condition. Connect a flow meter to the gas inlet probe. The flow rate should be above 450 cc/min when there is no air leakage.

If the pump is not working properly, refer the instrument to qualified service personnel for further testing and, if necessary, pump repair or replacement.

### Cleaning The Instrument

Occasional cleaning with a soft cloth is recommended. Do not use detergents or chemicals.

Visually inspect the contacts at the base of the instrument, on the battery, and on the charging cradle to make sure they are clean. If they are not, wipe them with a soft, dry cloth. Never use solvents or cleaners.

### Ordering Replacement Parts

If you need replacement parts, contact your local RAE Systems distributor. A list is available online:

<http://www.raesystems.com>

In the U.S., you can order sensors, replacement batteries, and other accessories online at:

<http://istore.raesystems.com/>



### Special Servicing Note

If the instrument needs to be serviced, contact either:

1. The RAE Systems distributor from whom the instrument was purchased; they will return the instrument on your behalf.

or

2. The RAE Systems Technical Service Department. Before returning the instrument for service or repair, obtain a Returned Material Authorization (RMA) number for proper tracking of your equipment. This number needs to be on all documentation and posted on the outside of the box in which the instrument is returned for service or upgrade. Packages without RMA Numbers will be refused at the factory.

## Troubleshooting

Problem	Possible Reasons & Solutions
Cannot turn on power after charging the battery	<p><b>Reasons:</b> Discharged battery. Defective battery.</p> <p><b>Solutions:</b> Charge or replace battery.</p>
Lost password	<p><b>Solutions:</b> Call Technical Support at +1 408-752-0723 or toll-free at +1 888-723-4800</p>
Reading abnormally High	<p><b>Reasons:</b> Dirty filter. Dirty sensor module. Excessive moisture and water condensation. Incorrect calibration.</p> <p><b>Solutions:</b> Replace filter. Blow-dry the sensor module. Calibrate the unit.</p>
Reading abnormally Low	<p><b>Reasons:</b> Dirty filter. Dirty sensor module. Weak or dirty lamp. Incorrect calibration.</p> <p><b>Solutions:</b> Replace filter. Remove Calibration Adapter. Calibrate the unit. Check for air leakage.</p>
Buzzer Inoperative	<p><b>Reasons:</b> Bad buzzer.</p> <p><b>Solutions:</b> Check that buzzer is not turned off. Call authorized service center.</p>

## MiniRAE 3000 User's Guide

Inlet flow too low	<p><b>Reasons:</b> Pump diaphragm damaged or has debris. Flow path leaks.</p> <p><b>Solutions:</b> Check flow path for leaks; sensor module O-ring, tube connectors, Teflon tube compression fitting. Call Technical Support at +1 408-752-0723 or toll-free at +1 888-723-4800</p>
“Lamp” message during operation	<p><b>Reasons:</b> Lamp drive circuit. Weak or defective PID lamp, defective.</p> <p><b>Solutions:</b> Turn the unit off and back on. Replace UV lamp</p>

## Technical Support

To contact RAE Systems Technical Support Team:

Monday through Friday, 7:00AM to 5:00PM Pacific (US) Time

Phone (toll-free): +1 888-723-4800

Phone: +1 408-952-8461

Email: [tech@raesystems.com](mailto:tech@raesystems.com)

## **RAE Systems Contacts**

### **RAE Systems by Honeywell World Headquarters**

3775 N. First St.  
San Jose, CA 95134-1708 USA  
Phone: 408.952.8200  
Toll-Free: 888.723.4800  
Fax: 408.952.8480

**E-mail (technical support):** [RAE-tech@honeywell.com](mailto:RAE-tech@honeywell.com)

**Web Site:** [www.raesystems.com](http://www.raesystems.com)

### **WORLDWIDE SALES OFFICES**

**USA/Canada** 1.877.723.2878

**Europe** +800.333.222.44/+41.44.943.4380

**Middle East** +971.4.450.5852

**China** +86.10.5885.8788-3000

**Asia Pacific** +852.2669.0828

# Controlled Part of Manual

### Intrinsic Safety:

US and Canada: Class I, Division 1, Groups A,B,C,D T4

Europe: ATEX (0575 Ex II 2G Ex ia IIC/IIB T4 Gb)

KEMA 07 ATEX 0127

Complies with EN60079-0:2009, EN60079-11:2007

IECEX CSA 10.0005 Ex ia IIC/IIB T4 Gb

Complies with IEC 60079-0:2007, IEC 60079-11:2006

**Temperature:** -20° C to 50° C (-4° to 122° F)

**Humidity:** 0% to 95% relative humidity (non-condensing)

## Basic Operation

### Turning The Instrument On

1. With the instrument turned off, press and hold [MODE].
2. When the display turns on, release the [MODE] key.

The instrument is now operating and performs self tests. Once the self tests are complete, the display shows a graph or numerical gas reading. This indicates that the instrument is fully functional and ready to use.

### Turning The Instrument Off

1. Press and hold the Mode key for 3 seconds. A 5-second countdown to shutoff begins.
2. When you see "Unit off..." release your finger from the [MODE] key. The instrument is now off.

**Note:** You must hold your finger on the key for the entire shutoff process. If you remove your finger from the key during the countdown, the shutoff operation is canceled and the instrument continues normal operation.

### Alarm Signals

During each measurement period, the gas concentration is compared with the programmed alarm limits (gas concentration alarm limit settings). If the concentration exceeds any of the preset limits, the loud buzzer and red flashing LED are activated immediately to warn you of the alarm condition.

In addition, the instrument alarms if one of the following conditions occurs: battery voltage falls below a preset voltage level, failure of the UV lamp, pump stall, or when the datalog memory is full.

### Alarm Signal Summary

Message	Condition	Alarm Signal
HIGH	Gas exceeds "High Alarm" limit	3 beeps/flashes per second*
OVR	Gas exceeds measurement range	3 beeps/flashes per second*
MAX	Gas exceeds electronics' maximum range	3 beeps/flashes per second*
LOW	Gas exceeds "Low Alarm" limit	2 beeps/flashes per second*
TWA	Gas exceeds "TWA" limit	1 Beep/flash per second*
STEL	Gas exceeds "STEL" limit	1 Beep/flash per second*
Pump icon flashes	Pump failure	3 beeps/flashes per second
Lamp	PID lamp failure	3 beeps/flashes per second plus "Lamp" message on display

## MiniRAE 3000 User's Guide

Battery icon flashes	Low battery	1 flash, 1 beep per minute plus battery icon flashes on display
CAL	Calibration failed, or needs calibration	1 beep/flash per second
NEG	Gas reading measures less than number stored in calibration	1 beep/flash per second

## Preset Alarm Limits & Calibration

The instrument is factory calibrated with standard calibration gas, and is programmed with default alarm limits.

Cal Gas (Isobutylene)	Cal Span	unit	Low	High	TWA	STEL
ppbRAE 3000	10	ppm	10	25	10	25
MiniRAE 3000	100	ppm	50	100	10	25
MiniRAE Lite	100	ppm	50	100	10	25
UltraRAE 3000	100	ppm	50	100	10	25

# Charging The Battery

Always fully charge the battery before using the instrument. The instrument's Li-ion/NiMH battery is charged by placing the instrument in its cradle. Contacts on the bottom of the instrument meet the cradle's contacts, transferring power without other connections.

**Note:** Before setting the instrument into its charging cradle, visually inspect the contacts to make sure they are clean. If they are not, wipe them with a soft cloth. Do not use solvents or cleaners.

Follow this procedure to charge the instrument:

1. Plug the AC/DC adapter's barrel connector into the instrument's cradle.

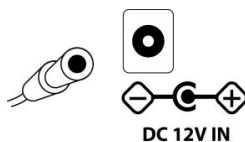

2. Plug the AC/DC adapter into the wall outlet.
3. Place the instrument into the cradle, press down, and lean it back. It locks in place and the LED in the cradle glows.

**Note:** To release the instrument, press down and tilt the top out of the cradle and lift up.

The instrument begins charging automatically. The LED on the front of the cradle marked "Primary" blinks during charging. During charging, the diagonal lines in the battery icon on the instrument's display are animated and you see the message "Charging..."

When the instrument's battery is fully charged, the battery icon is no longer animated and shows a full battery. The message "Fully charged!" is shown and the Primary LED on the cradle glows continuously green.



## MiniRAE 3000 User's Guide

**Note:** A spare Li-ion battery (059-3051-000) or NiMH(059-3054-000) can be charged by placing it directly in the charging port on the back of the cradle. It can be charged at the same time as the instrument. Press the battery in place, sliding it slightly toward the front of the cradle. This locks it in the cradle. To release the battery, slide it forward again and tilt it up.

**Note:** An Alkaline Battery Adapter (part number 059-3052-000), which uses four AA alkaline batteries (Duracell MN1500), may be substituted for the Li-Ion battery.

### **WARNING!**

**To reduce the risk of ignition of hazardous atmospheres, recharge and replace batteries only in areas known to be non-hazardous. Remove and replace batteries only in areas known to be non-hazardous.**

### **Low Voltage Warning**

When the battery's charge falls below a preset voltage, the instrument warns you by beeping once and flashing once every minute, and the battery icon blinks once per second. You should turn off the instrument within 10 minutes and either recharge the battery by placing the instrument in its cradle, or replace the battery with a fresh one with a full charge.

### **Clock Battery**

An internal clock battery is mounted on one of the instrument's printed circuit boards. This long-life battery keeps settings in memory from being lost whenever the Li-ion, NiMH, or alkaline batteries are removed. This backup battery should last approximately five years, and must be replaced by an authorized RAE Systems service technician. It is not user-replaceable.

### **WARNING**

**To reduce the risk of ignition of hazardous atmospheres, recharge battery only in area known to be non-hazardous. Remove and replace battery only in an area known to be non-hazardous.**

## **Replacing Rechargeable Li-Ion or NiMH Battery**

**Caution:** Turn off the instrument before removing or replacing the battery.

### **Alkaline Battery Adapter**

An alkaline battery adapter is supplied with each instrument. The adapter (part number 059-3052-000) accepts four AA alkaline batteries (use only Duracell MN1500).

Do not mix old and new batteries or different type batteries.

# Troubleshooting

Problem	Possible Reasons & Solutions
Cannot turn on power after charging the battery	<p><b>Reasons:</b> Discharged battery. Defective battery.</p> <p><b>Solutions:</b> Charge or replace battery.</p>
Lost password	<p><b>Solutions:</b> Call Technical Support at +1 408-752-0723 or toll-free at +1 888-723-4800</p>
Reading abnormally High	<p><b>Reasons:</b> Dirty filter. Dirty sensor module. Excessive moisture and water condensation. Incorrect calibration.</p> <p><b>Solutions:</b> Replace filter. Blow-dry the sensor module. Calibrate the unit.</p>
Reading abnormally Low	<p><b>Reasons:</b> Dirty filter. Dirty sensor module. Weak or dirty lamp. Incorrect calibration.</p> <p><b>Solutions:</b> Replace filter. Remove Calibration Adapter. Calibrate the unit. Check for air leakage.</p>
Buzzer Inoperative	<p><b>Reasons:</b> Bad buzzer.</p> <p><b>Solutions:</b> Check that buzzer is not turned off. Call authorized service center.</p>

## MiniRAE 3000 User's Guide

Inlet flow too low	<p><b>Reasons:</b> Pump diaphragm damaged or has debris. Flow path leaks.</p> <p><b>Solutions:</b> Check flow path for leaks; sensor module O-ring, tube connectors, Teflon tube compression fitting. Call Technical Support at +1 408-752-0723 or toll-free at +1 888-723-4800</p>
"Lamp" message during operation	<p><b>Reasons:</b> Lamp drive circuit. Weak or defective PID lamp, defective.</p> <p><b>Solutions:</b> Turn the unit off and back on. Replace UV lamp</p>





**RAE Systems by Honeywell**  
**World Headquarters**  
3775 N. First St.  
San Jose, CA 95134-1708 USA  
Phone: 408.952.8200  
Toll-Free: 888.723.4800  
Fax: 408.952.8480

**E-mail (technical support):** [RAE-tech@honeywell.com](mailto:RAE-tech@honeywell.com)  
**Web Site:** [www.raesystems.com](http://www.raesystems.com)

**WORLDWIDE SALES OFFICES**

**USA/Canada** 1.877.723.2878

**Europe** +800.333.222.44/+41.44.943.4380

**Middle East** +971.4.450.5852

**China** +86.10.5885.8788-3000

**Asia Pacific** +852.2669.0828

Rev. F  
February 2016  
P/N 059-4020-000