

A GLOBAL ASSET MANAGEMENT COMPANY
Focused on Property and Infrastructure Assets



DBCT Management - Master Plan 2016

Expansion Opportunities at the Dalrymple Bay Coal Terminal



Document Control					
Rev No	Date	Revision Details	Author	Verifier	Approver
1	31/03/2016	Submission Document	DBCTM	PW	AT
2	07/07/2016	Final	DBCTM	PW	AT
Document Owner			Next revision date		
Jesse Knight			31/03/2017		

Table of Contents

1	EXECUTIVE SUMMARY	6
1.1	DBCT BACKGROUND (CHAPTER 2)	6
1.2	CURRENT OPERATIONS (CHAPTER 3)	6
1.3	FUTURE SUPPLY/DEMAND (CHAPTER 4)	7
1.4	DBCT EXPANSION OPTIONS (CHAPTER 5)	7
1.5	ENVIRONMENT (CHAPTER 6)	7
1.6	STAKEHOLDER CONSULTATION (CHAPTER 7)	8
2	INTRODUCTION & BACKGROUND	9
2.1	BACKGROUND TO DBCT	9
2.2	CURRENT ASSET DESCRIPTION	12
2.2.1	Basic configuration	12
2.2.2	Inloading	14
2.2.3	Stockyard	14
2.2.4	Outloading	17
2.3	WATER MANAGEMENT INFRASTRUCTURE	18
2.4	CONTRACTUAL FRAMEWORK	18
2.4.1	Requirement for a Master Plan	18
2.4.2	Whole of System Master Planning	20
2.4.3	Contractual Position	21
2.4.4	Contractual Position July 2010	21
2.4.5	Contractual Position February 2016	22
2.4.6	Regulatory Regime	22
2.5	GOVERNMENT LEGISLATION	23
2.5.1	Government Legislation	23
2.5.2	Proposals for Land Use and Site Development	24
3	CURRENT OPERATIONS	27
3.1	MODE OF OPERATION	27
3.1.1	DBCT Dedicated Stockpiling Option	28
3.1.2	Hybrid	28
3.1.3	Remnant Management	29
3.2	OPERATIONS	31
3.2.1	DBSCC ordering principles	31
3.2.2	Service Provision	32
3.2.3	Vessel Trends	32
3.2.4	Mine Load Points & Recharge Capability	33
4	SUPPLY/DEMAND BASED PROJECTIONS	34
4.1	THROUGHPUT GROWTH	34
4.2	METALLURGICAL COAL HISTORY	34



4.3	SUPPLY	36
4.3.1	Domestic Indian production growth	36
4.3.2	Chinese Domestic production	37
4.4	DRIVERS OF DEMAND	37
4.4.1	India	40
4.4.2	China	41
4.4.3	South Korea and Japan	41
4.4.4	Europe	42
4.4.5	Thermal coal	42
4.5	MINE DEVELOPMENT EXPANSION TRIGGERS	43
5	DBCT MTPA EXPANSION OPTIONS	45
5.1	DEVELOPMENT OBJECTIVES FOR DBCT	45
5.2	EXPANSION STUDIES	46
5.2.1	Recap of Master Plan 2009	46
5.3	RECOMMENCEMENT OF EXPANSION STUDIES IN 2014	47
5.4	SYSTEM CAPACITY MODELLING	48
5.5	EXPANSION PATHWAY	49
5.5.1	Zone 4	49
5.5.2	8X Project	53
5.6	STACKERS ST1 AND ST2 UPGRADE	55
5.7	STOCKPILE AUGMENTATION PROJECT (SAP)	56
5.8	NEW IL4 AND IL2 UPGRADE	58
5.9	OL2 UPGRADE	59
5.10	INLOADING BUFFER STORAGE	60
5.10.1	Indicative cost of the 8X Project	62
5.10.2	9X Project	62
5.11	RAIL INFRASTRUCTURE	68
6	ENVIRONMENT	69
6.1	OVERVIEW / BACKGROUND	69
6.1.1	Existing Environmental Authorities / Regulatory Processes	70
6.2	PRELIMINARY ENVIRONMENTAL IMPACT ASSESSMENT	70
6.2.1	Air Quality	71
6.2.2	Noise and Vibration	72
6.2.3	Visual Amenity	72
6.2.4	Cultural Heritage	72
6.2.5	Local Maritime Operations	73
6.2.6	Community and Social Impacts	73
6.2.7	Coastal Processes	73
6.2.8	Marine Ecology	74



- 6.2.9 Terrestrial Ecology..... 74
- 6.2.10 Soil and Geology..... 74
- 6.2.11 Surface Water Quality and Hydrology..... 74
- 6.2.12 Transportation and Access..... 74
- 6.2.13 Waste Management..... 74
- 6.2.14 Land Tenure and Other Stakeholder Interests..... 75
- 6.3 POTENTIAL ENVIRONMENTAL AND PLANNING ISSUES..... 76
- 6.4 AIR QUALITY ENVIRONMENT - POST EXPANSION..... 76
 - 6.4.1 Emissions..... 78
 - 6.4.2 Results..... 78
- 6.5 NOISE ENVIRONMENT - POST EXPANSION 81
 - 6.5.1 Licence Conditions 81
 - 6.5.2 Assessment of 8X Pathway (including Zone 4)..... 82
 - 6.5.3 Conclusions 83
- 7 STAKEHOLDER CONSULTATION 84**
 - 7.1 PUBLIC CONSULTATION PROCESS..... 84
 - 7.2 COMMUNITY ENGAGEMENT STRATEGY 84
 - 7.3 KEY STAKEHOLDER RELATIONS PROGRAM..... 85
 - 7.4 MANAGEMENT OF COMPLAINTS & ISSUES..... 86

1 Executive Summary

The Bowen Basin has experienced strong production and demand growth for coal in the last 15 years. In order to accommodate this demand, DBCT Management Pty Limited (“DBCTM”) has responded by undertaking numerous capacity expansions. The DBCT 7X project was the most recent expansion and lifted terminal capacity to 85 million tonnes per annum (Mtpa), underwritten by long term take or pay contracts with the world’s biggest mining companies.

Since commissioning the new capacity in 2009, throughput has slowly increased in line with global demand. Further to contracted demand, DBCTM holds Access Applications seeking additional terminal capacity of up to 99.57 Mtpa. Despite the recent slowing of global demand growth, Access Applications for post 85 Mtpa capacity at DBCT are still in place, with no indications that a material withdrawal will occur.

DBCT Management is obliged by the Port Services Agreement (PSA) and the Access Undertaking (AU) to accommodate the actual and reasonably anticipated future demand for the use of DBCT’s Users and access seekers. Accordingly, DBCTM has continued to plan post 85 Mtpa expansions to take DBCT’s nameplate capacity up to a maximum of 136Mtpa.

While an eventual return to demand growth is widely anticipated, the timing of the recovery has proven difficult to forecast. In the current environment it seems logical that when demand for expansion does return it will return in a more subdued and measured way, leading to a more incremental expansion requirement than anticipated in previous Master Plans. This Master Plan outlines an incremental expansion pathway for DBCT.

This Master Plan (2016) takes into account recent legislative and policy changes at the Commonwealth and State levels regarding development along the Great Barrier Reef World Heritage Area (GBRWHA). The Master Plan reviews the preferred expansion path to meet the requirements of future capacity demand, without trying to predict when those individual expansion options might be activated.

1.1 DBCT Background (Chapter 2)

Chapter 2 reviews DBCTM’s involvement in the terminal and describes the asset relevant to land use and geographical location, including a brief history of the terminal and the progression to DBCT’s current configuration. Various elements of DBCT’s operations are discussed, including a description of the major plant and machinery that allow the terminal to deliver 85 Mtpa of capacity. The region encompassing the terminal, in addition to the land leases that make up the terminal footprint are outlined for ease of reference.

The chapter also deals with the contractual Master Planning process and DBCT Management’s alignment with the Whole of System Master Planning function of the Integrated Logistics Company (ILCO). The regulatory history is outlined in detail in this chapter, as is the contractual history following the purchase from government.

1.2 Current Operations (Chapter 3)

This chapter provides an overview of the current operations of DBCT, including; cargo assembly and hybrid stockpiling, the impact of service provision on terminal capacity, an overview of the remnant zone, and a summary of the independent capacity modelling results.

DBCT has deviated away from a pure cargo assembly operation and introduced some multi-

vessel hybrid stockpiling. Hybrid stockpiling typically occurs where multiple, near-spaced vessel arrivals are chartered to load a single product that can be loaded into one larger stockpile rather than multiple smaller stockpiles, providing better utilisation of the stockyard and better throughput. Use of rows 7 and the half row eight provide the operator with further options for completing vessels and avoiding remnant stockpiles in the cargo assembly zone.

Service provision, including non-common blending ratios, breakdowns, maintenance and smaller vessels can all erode terminal and supply chain capacity.

1.3 Future Supply/Demand (Chapter 4)

This chapter assesses global demand and supply prospects in the context of triggering further expansions at DBCT. Previous forecasts, based on leading industry analysis have been unreliable, due to a range of factors including the global financial crisis and more recently economic conditions in Australia's usual export destinations.

DBCT Management expects stability in growth from the usual supply regions including Japan and South Korea, continued swing purchasing from China, while India and South East Asia drive further growth for coal handled by DBCT.

Competing suppliers do pose a threat to DBCT's demand, particularly Mozambican and Indian domestic coal production, however these regions are not expected to materially impact the long term growth of the Bowen Basin. Continuing demand out of the Bowen Basin is expected to drive demand for expansion capacity at DBCT. While there is no way to reliably predict the timing of the recovery, DBCT Management has developed this Master Plan with the intent of having a clear development pathway ready, such that it can be triggered when the coal market rebounds.

1.4 DBCT Expansion Options (Chapter 5)

This chapter recaps expansion options identified in Master Plan 2009 and considers them in the context of the materially different market conditions that currently exist. The chapter outlines a new approach to satisfying future demand with an incremental development pathway. It concludes that to satisfy the likely and foreseeable demand, 3 projects are appropriate. These projects, referred to as Zone 4, 8X and 9X can be delivered in a measured and incremental way. The Zone 4 project, coupled with the Hybrid Operating mode, alleviates current system operating constraints limiting the system to a capacity slightly below 85 and then delivers an additional 4Mtpa beyond 85 Mtpa to take the System Capacity to 89 Mtpa. The 8X Project would be implemented in 2 phases and would ultimately take the system capacity to 102 Mtpa. 8X expands the current stockyard to its full potential, meaning any capacity requirement beyond 102 Mtpa would necessitate the development of a new stockyard, supported by 4th inloading system and 4th outloading system. This development is referred to as 9X and would also be developed in a series of incremental steps. The development pathway identified in the Master Plan leverages current infrastructure to achieve a cost efficient expansion pathway for Bowen Basin coal producers.

1.5 Environment (Chapter 6)

This chapter outlines the pertinent environmental issues relevant to of each of the expansion pathways, including dust and noise forecasts associated with the Zone 4 and 8X expansions.

It aligns with leading practice guidelines and recent policy settings by the Commonwealth & State Governments by ensuring early consideration of environmental values for development

along the Great Barrier Reef coast.

It demonstrates that the preferred expansion options outlined in Chapter 5 do not significantly compromise the anticipated environmental outcomes for terminal operations including existing Environmental Authorities, however advanced engineering work and re-modelling is recommended. Further, the enhancement of port environmental buffers will be a critical 'port-protection' issue for consideration during formal State Master Planning work (to be undertaken by the State) in 2017-2018.

1.6 Stakeholder Consultation (Chapter 7)

Chapter 7 details how DBCTM has and will interface with stakeholders in terms of current operations and future expansion of the terminal.

2 Introduction & Background

2.1 Background to DBCT

DBCT was established in 1983 by the Queensland Government as a common user coal export facility. In 2001, the Queensland Government, represented by Ports Corporation of Queensland (“PCQ”) and DBCT Holdings P/L, awarded a long-term lease over DBCT (a 50-year term with a 49-year renewal option) to a consortium collectively known as Coal Logistics–North Queensland (CL-NQ). Following a change of ownership in 2009 to Brookfield Infrastructure Partners (BIP), DBCT Management (DBCTM) has held management responsibility for the DBCT assets as the Secondary Lessee. For the purposes of this document, DBCTM collectively stands for the leaseholder and related entities responsible for fulfilling the duties related to the DBCT lease, the obligations contained in the Port Services Agreement (PSA) and any of the head leasing agreements.

The Port of Hay Point is approximately 38kms south of Mackay and consists of two coal terminals - DBCT and Hay Point Services (‘HPS’) (Figure 1).

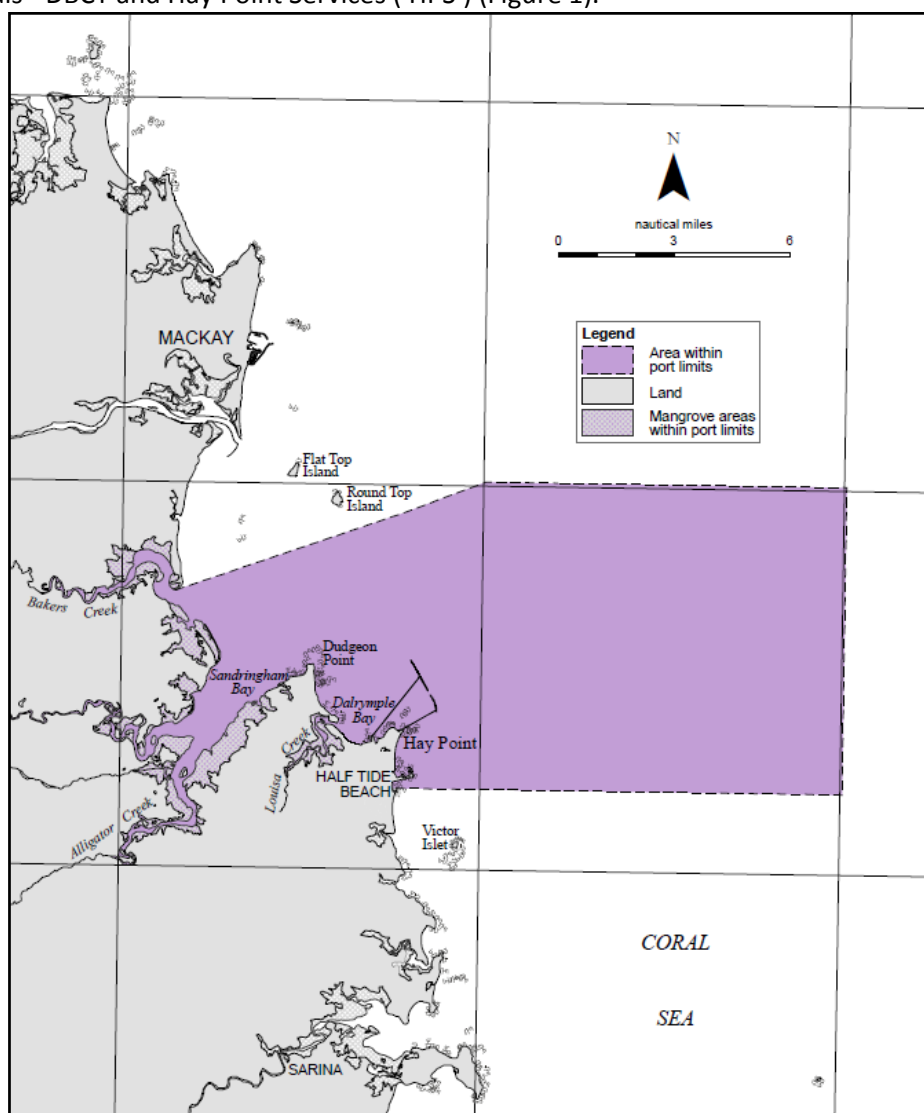

Figure 1: Port of Hay Point Port Limits – (Department Transport and Main Roads, 2013)

DBCT Management Master Plan 2016
Introduction & Background

The port is administered by North Queensland Bulk ports (NQBP, formally known as PCQ) as the statutory Port Authority and strategic port land owner. The terminals are linked to the Bowen Basin coalfields (Figure 2) by the electrified Goonyella rail system operated by Aurizon National Network Services. Figure 3 shows DBCT’s position relative to the port area.

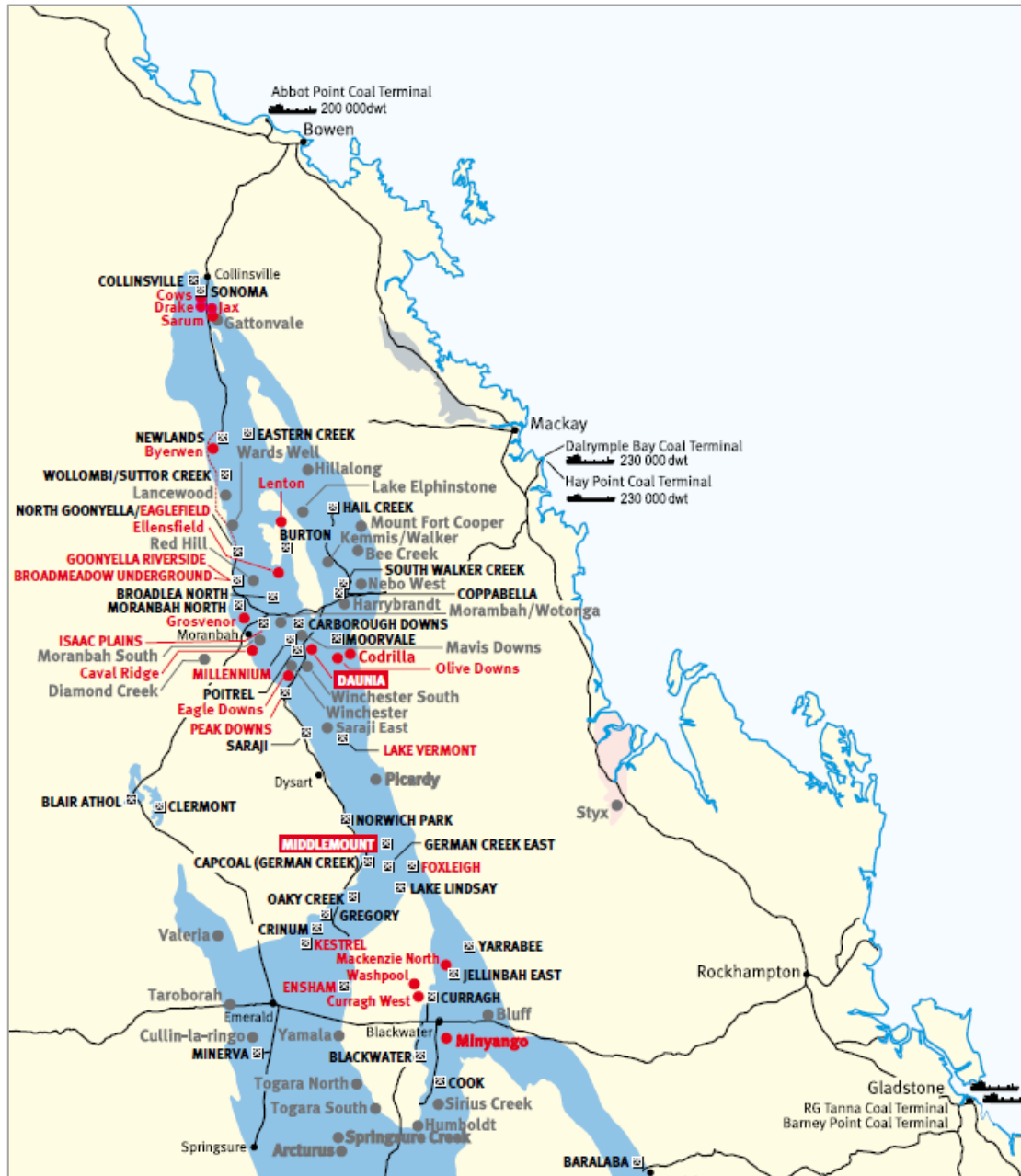

Figure 2: Bowen Basin coalfields – (DEEDI, 2012)



Figure 3: Port of Hay Point (DBCT Management, 2016)

DBCT is a bulk export coal terminal which is owned by the State of Queensland. The daily terminal operations and maintenance activities are undertaken by Dalrymple Bay Coal Terminal Pty Ltd (“DBCT P/L”), a 3rd party service provider owned by 5 of the DBCT Access Holders. Terminal operations and maintenance activities are undertaken by DBCT Pty Ltd under an Operations & Maintenance Contract (“OMC”). Both the DBCT Operator and DBCT ownership are parties to the OMC.

Additional information is available from these websites <http://www.dbctm.com.au> and <http://www.dbct.com.au>

The land use surrounding the port (Figure 3) is a mix of agricultural, rural/residential and urban. The residential communities neighbouring DBCT are the communities of Louisa Creek, Half Tide, Timberlands, the Droughtmaster Drive area and Salonika Beach. Responsible and ongoing interaction with these communities is an important element of DBCT Management’s master planning and development process.



Figure 4: Position of DBCT relative to the local area – (DBCT Management, 2016)

2.2 Current Asset Description

2.2.1 Basic configuration

DBCT's basic configuration can be described as: 3 rail receiving stations; a stockyard; and 4 off-shore wharves; all connected by a series of conveyor systems. DBCT is situated on approximately 214 hectares of strategic port land and 160 hectares of off-shore sea-bed lease, primarily described by the following lots:

- Lot 126 on SP123776
- Lot 130 on SP105841

- Lot 131 on SP136318
- Lot 133 on SP136320
- Lot 134 on SP185573
- Lot 135 on SP185580
- Lot 41/42 on SP136319
- Lot 43 on SP185559

Lot Part of 132 on SP136318 (Lease C on SP185554 and Lease D on SP185555)

The site stretches for more than 2.38 kms from the rail inloading stations to the shore side jetty head, with the wharves a further 3.8kms off-shore. The total rated terminal capacity is 85 Mtpa, making it Queensland's largest standalone coal export terminal. With the expanded capacity of HPS (55 Mtpa) reportedly available since December 2015 (BHP Billiton, 16 December 2015), the Port of Hay Point is one of the largest bulk export coal ports in the world.

DBCT is a common-user facility, handling a wide variety of coal types from seven coal producers. DBCT processes 3 commercial coal categories, including: coking coal, Pulverised Coal Injection (PCI) coal, and thermal coal. Coals can be further blended from the terminal's stockpiles to create many different "blended" products. The majority of DBCT's exports are shipped on a Free on Board (FOB) basis. The customers of DBCT's Producers (i.e. the coal buyers) are responsible for organising and paying for sea transport. Coupled with the available stockyard capacity, the high number of individual and blended products drives a cargo assembly and hybrid operating mode in the terminal.

DBCT makes use of the following plant and equipment to achieve an 85 Mtpa nameplate capacity:

- 3 rail receival stations - 2 x 5,500tph (IL1 & 2); 1 x 8,100tph (IL3);
- 4 stackers - 1 x 5,500tph; 1 x 6,000 tph; 2 x 8,100tph;
- 3 reclaimers – 1 x 4,250 tph; 2 x 5,300 tph
- 5 stacker-reclaimers - various stack rates from 4,250 - 5,500tph and various reclaim rates from 3,700tph – 5,300tph;
- 8 stockpile rows, each approximately 1,100m in length (note that row 8 is a half row). Maximum designed volumetric yard capacity (static – meaning if every pile was full) is approximately 2.3 million tonnes of coal;
- 3 outloading systems (OL1, OL2 and OL3) and 3 shiploaders – 1 x 7,200tph (SL1); 1 x 7,600tph (SL2); and 1 x 8,650tph (SL3)
- 4 berths capable of receiving cape size vessels
- SL1 can serve berths 1 and 2; SL2 can serve berths 1 and 2 and SL3 serves berths 3 and 4
- OL1 serves SL1; OL2 can serve SL1, SL2 and SL3 ; and OL3 can serve SL1, SL2 and SL3

2.2.2 Inloading

DBCT has three inloading stations, feeding three inloading conveyor systems which deliver coal to the DBCT stockyard. The inloading stations can accept a number of different train configurations and wagon types from any one of three above rail haulage operators (Pacific National, Aurizon National and BMA Rail). The coal wagons are bottom dump type, with the coal falling out of the wagons and into the rail receival pits for transfer via inloading conveyor to the stockyard. Any of the inloading stations can feed coal to the stackers or stacker reclaimers in any part of the DBCT stockyard. This configuration gives DBCT’s operator ultimate flexibility when planning the location of stockpiles in the DBCT stockyard.

2.2.3 Stockyard

The stockyard (Figure 5) consists of eight machinery bunds which support twelve yard machines and seven and a half stockpile rows. These rows are each divided into three “cells” containing stockpiles (separated by drainage pits). The twelve yard machines include four stackers, three reclaimers and five stacker/reclaimers laid out as per the following diagram:

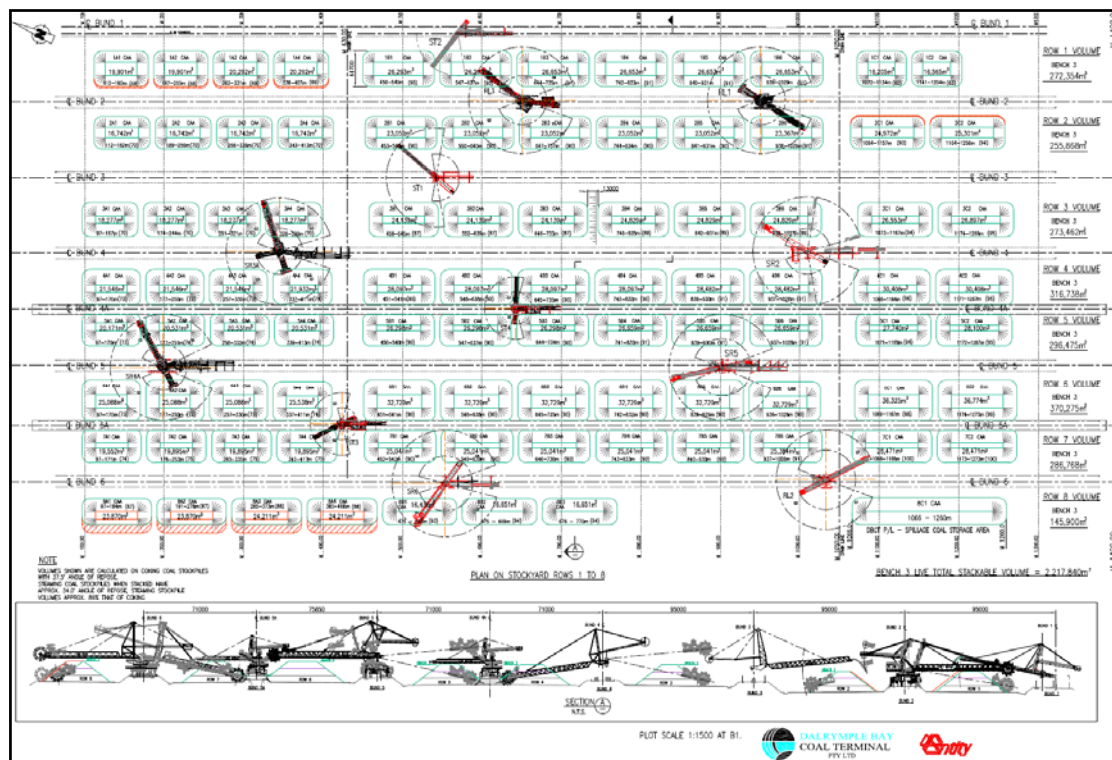

Figure 5: Stockyard layout of DBCT delivering 85 Mtpa – (DBCT Pty Ltd 2016)

The volumetric capacity of each of the stockyard rows is shown in table 1 below. The actual working capacity of the rows at any time will be determined by the number of stockpiles in each row and their sizes:

DBCT Stockyard Capacity									
Stockpile Row	Row 1	Row 2	Row 3	Row 4	Row 5	Row 6	Row 7	Row 8	Total
Capacity (m ³)	272,354	255,868	273,462	316,738	296,475	370,275	286,768	145,900	2,217,840

Table 1: DBCT yard row volumes – (DBCT Pty Ltd, 2016)

The stockyard has delinked inloading and outloading systems, meaning each arriving train can usually be stacked without interrupting or impeding vessel loading activities. The yard configuration and operating strategy maximises outloading performance by making two reclaiming machines available to each outloading system. Under normal operating circumstances, two reclaiming machines dig from two stockpiles simultaneously to complete one loading activity into the vessel. If the product is not a blend, both stockpiles will contain the same product, however if the parcel is a blended product, both stockpiles associated with the reclaiming operation will contain two different products to be reclaimed simultaneously. This feature enables DBCT to blend cargoes from the stockpiles, allowing terminal Producers to create unique coal blends to match end-user requirements. Where supply chain capacity allows, products may also be blended into stockpiles, providing additional blending flexibility and capabilities for terminal users and coal end-users.

Individual yard machine rates are as follows:

	ST1	ST2	ST3	ST4	RL1	RL2	RL3	SR2	SR3A	SR4A	SR5	SR6
Average stack Rate	5,500	6,000	8,100	8,100				4,250	5,500	5,500	5,500	5,500
Average reclaim rate					5,300	5,300	4,250	3,700	5,300	5,300	4,500	4,300
average throughload rate						5,500	4,250	4,250	5,500	5,500	5,500	5,500

Table 2: DBCT yard machine rates – (DBCT Pty Ltd, 2016)

Operationally, the DBCT stockyard is divided into four independent zones, which are usually paired with a single outloading system and generally operate under the following configuration:

- Zone one includes stockyard rows three and four and feeds the first outloading system. Zone one is shown in red in Figure 6.
- Zone two includes stockyard rows one and two, and feeds the second outloading system. Zone two is shown in blue in Figure 6.
- Zone three includes stockyard rows five and six, and feeds the high rate third outloading system. Zone three is shown in green in Figure 6.
- Zone four includes row seven and the half row eight (shown in yellow in Figure 6). This zone contains only remnant stockpiles and can feed any of the outloading systems. The remnant zone and strategy is explained in further detail later in this Master Plan (Chapter 3)



Figure 6: DBCT zonal configuration – (DBCT Management, 2016)

Zones one to three are referred to as the dynamic zone, while zone four is referred to as the static zone. The dynamic zone is shown in Figure 7 in blue, while the static zone is shown in Figure 7 in yellow.



Figure 7: DBCT static and dynamic zones– (DBCT Management, 2016)

2.2.4 Outloading

Each of the outloading conveyor systems is predominantly paired with a rate-matched shiploader. In this configuration, the pair of reclaiming machines, the outloading conveyor system and the shiploader have matched speeds to maximise individual machine utilisation.

From time to time (usually during maintenance outages), the outloading systems can be reconfigured to feed different shiploaders. Generally, the following outloading systems feed the corresponding shiploaders:

- Outloading system one feeds coal to shiploader one
- Outloading system two feeds coal to shiploader two
- The high rate outloading system three feeds coal to the high rate shiploader three.

Each shiploader is generally dedicated to a single berthing area, with shiploader one and two dedicated to berths one and two respectively. The high rate shiploader three

is unique because it loads coal into vessels on both berths three and four. Ideally, shiploader 3 will be subject to the highest utilisation. Shiploader 3 is designed to load vessels sequentially on both berths three and four.

2.3 Water Management Infrastructure

In 2014 and 2015, DBCTM implemented a program of NECAP works to reduce the likelihood of exceedances of the allowable release limits for Total Suspended Solids (TSS) from the Industrial Dam (ID) discharge point into Sand-Fly Creek. This was in response to exceedances that occurred during the 2012/2013 wet season.

The additional major infrastructure developed as part of this program includes:

- Industrial Dam (ID) to Quarry Dam (QD) High Flow Transfer Pumps & Pipeline
- ID pit drying slabs, pit end walls, downstream channel and causeway and split containment ponds
- ID Pump Sump Filter Wall
- ID Spillway Raising
- Modifications to existing Coal Collection Pit 1/A
- New Rail Loop Dam (RLD) (to add approximately 640ML of additional water storage capacity)
- QD wall raising (5m) (to add approximately 180ML of additional water storage capacity)
- Pipeline from QD to RLD (to allow QD overflow to RLD)
- New WM1 tank & pump system (to provide dedicated industrial and fire water storage tank fed from the QD (to allow maximisation of the Industrial Dam buffer capacity)
- Flocculent plant project (to further improve coal fines sedimentation processes)

2.4 Contractual Framework

2.4.1 Requirement for a Master Plan

The Port Services Agreement (PSA) requires DBCT Management (DBCTM) to submit a Master Plan to DBCT Holdings addressing any changes in circumstances, demand, technology or other relevant matters, no later than 31 March each year. Due to the uncertain timing of demand to trigger terminal expansion, there can be long periods where no expansion activity is required. DBCTM has therefore requested an amendment to the PSA to allow it to only submit a master plan, where DBCTM determines that (acting reasonably):

- i. substantive changes are required to be made to the Master Plan; or
- ii. the current Master Plan has been developed to its ultimate extent,

DBCTM has drafted this document to:

- i. ensure that DBCT is developed in accordance with Access Seeker applications for terminal capacity, infrastructure planning best practice, principles of environmental sustainability, applicable laws and the balanced interests of its

- stakeholders;
- ii. ensure the PSA requirement for any expansion to be both economic and reasonable is satisfied;
 - iii. ensure a responsible alignment of supply chain partner infrastructure based on a supply chain “cargo assembly/hybrid” methodology;
 - iv. ensure compliance with contractual commitments and statutory obligations for master planning which meet the requirements of the PSA;
 - v. ensure a continued ‘leading practice’ approach to port/terminal planning within the coastal zone, particularly within the GBRWHA.

DBCTM currently holds 99.57 million tonnes of access requests, in addition to the current contracted capacity. Checks of the access queue have determined that only 57.32 million tonnes of access requests are for projects with a current commissioning date of 2019 or earlier. The balance of the access seekers have indicated that they are waiting for the coal market to improve before making any further progress on their own coal supply projects.

Despite these indications from Access Seekers, 2.7Mtpa of capacity has recently been relinquished by an existing User, with a further 1.6Mtpa expected to be released by the middle of 2016. While DBCTM has offered this capacity to all the Access Seekers in the queue, at the time of finalising this report, there has been no firm indication from any Access Seeker indicating that they intend to contract this available capacity. For this reason, DBCTM considers that its incremental approach to developing new capacity is justified in spite of the apparent presence of a large queue seeking new capacity.

This Master Plan presents three incremental terminal expansions to accommodate differing demand profiles. The common industry practice of using Front End Loading (FEL) engineering to assess the various levels of feasibility has been employed in the engineering studies that underpin this plan. Only the first expansion step outlined in this Master Plan (Zone 4) has been studied to a level of certainty that is commonly referred to as FEL3 or a Feasibility Study level. It is anticipated that the Zone 4 expansion would provide a further 4.1 Mtpa of terminal capacity above the existing 85 Mtpa terminal capacity

FEL1 studies (concept only) have also been undertaken for the other 2 incremental expansions 8X and 9X. Pre-feasibility and Feasibility work will ultimately be required to better understand these expansions but undertaking this work at this point without immediate demand is not considered warranted.

The second stage in the expansion pathway (8X) involves terminal inloading upgrades, yard machine upgrades, stockyard enhancements and outloading upgrades. This expansion is expected to add approximately 12.5 Mtpa above that of Zone 4, taking terminal capacity to 102 Mtpa.

9X is the third stage in the expansion pathway. The 9X expansion would introduce a 2nd stockyard to supplement the existing DBCT stockyard. The new stockyard would likely be located on the western side of the existing terminal, subject to land availability. As the 9X expansion option would add approximately 34 Mtpa above 8X capacity (102 Mtpa), development will be subject to growing industry demand.

By considering these three expansion options, this Master Plan seeks to, within the

boundaries of the current economic and global demand uncertainty:

- meet contractual obligations and stakeholder expectations;
- provide a clear DBCT expansion pathway based on current access requests;
- provide a basis for the integration of the DBCT environmental strategy; and
- enhance customer value by providing an export outlet that meets the requirements of Queensland's *Sustainable Ports Development Act, 2015*.

2.4.2 Whole of System Master Planning

Apart from DBCTM's contractual obligations to DBCT Holdings, a number of Goonyella Master Plans have been developed by the Integrated Logistics Company (ILC) using the ILC's *Fully Integrated Dynamic Simulation Model*. The creation of the ILC and the ILC's *Fully Integrated Simulation Model* was an outcome of the joint Queensland Government and Queensland Resources Council supply chain review conducted by Stephen O'Donnell in 2007. The O'Donnell review made the following recommendation:

"A central coordination role be created to oversee activities across the supply chain."

The ILC's Master Plans (MP) for the Goonyella Coal Chain are integrated, 10 year plans encompassing:

- All Mines in the Goonyella and Newlands System
- The Below rail infrastructure and operating methods and principles.
- Dalrymple Bay Coal Terminal infrastructure and operating methods
- Hay Point Coal Services Terminal infrastructure and operating methods
- Adani Abbott Point Terminal and operating methods
- Port Channel and vessel movement practices.

To prevent misalignment of infrastructure development, the ILC Master Plans seeks to align future supply chain infrastructure expansions across all asset owners and operators by:

- i. the development of a common set of inputs and assumptions for the determination of system capacity;
- ii. the development and maintenance of an integrated full system simulation model, which is used as a tool to assess system capacity and evaluate future capacity requirements; and
- iii. aligning and assessing alternative expansion options.

The development and implementation of the ILC's MPs are part of a longer term solution to the address the underperformance of the Goonyella supply chain.

To ensure planning alignment within the Goonyella Coal Chain, DBCTM uses the ILC System Capacity Model for its capacity planning purposes. DBCTM has engaged the ILC Master Planning group to model the existing system in addition to various expansion scenarios to quantify capacity benefits and production losses during implementation. The modelling results have guided the development of this Master Plan.

Prior to testing the various expansion scenarios, the ILC first established the current pre-expansion capacity of the system. The ILC started with its published MP2013 report and model and what is referred to as the Evidence Based Starting Case (EBSC) within that plan. The ILC then incorporated model input updates that have occurred since the EBSC, prior to implementing the MP2013 findings to get as close as possible to the targeted System Capacity of 85Mtpa. The MP2013 findings that have been achieved and consequently included in the pre-expansion modelling are as follows;

- Removal of light-loaded trains
- Increased average train payload by 3%
- The introduction of the hybrid operating strategy

The ILC’s modelling establishes the pre-expansion system capacity as 83.8Mtpa.

2.4.3 Contractual Position

DBCTM inherited the User Agreements in place between the State and Users when it entered into the long term lease of the terminal in 2001. In 2006, following the QCA’s approval of the initial access undertaking, all Users migrated across to the standard form agreement included as a schedule to the undertaking. These agreements were for a minimum term of 10 years and included evergreen 5 year options in favour of the Users.

Prior to implementing the DBCT 7X expansion, DBCTM entered into access agreements that covered the additional capacity to be delivered by the expansion. Since then, there have been assignments of capacity between existing Users and new Users who have entered the terminal. Further, some access agreements have now rolled in to the option phase. The contractual volumes following the 7X expansion and in February 2016 are shown in Figure 8 and Figure 9.

2.4.4 Contractual Position July 2010

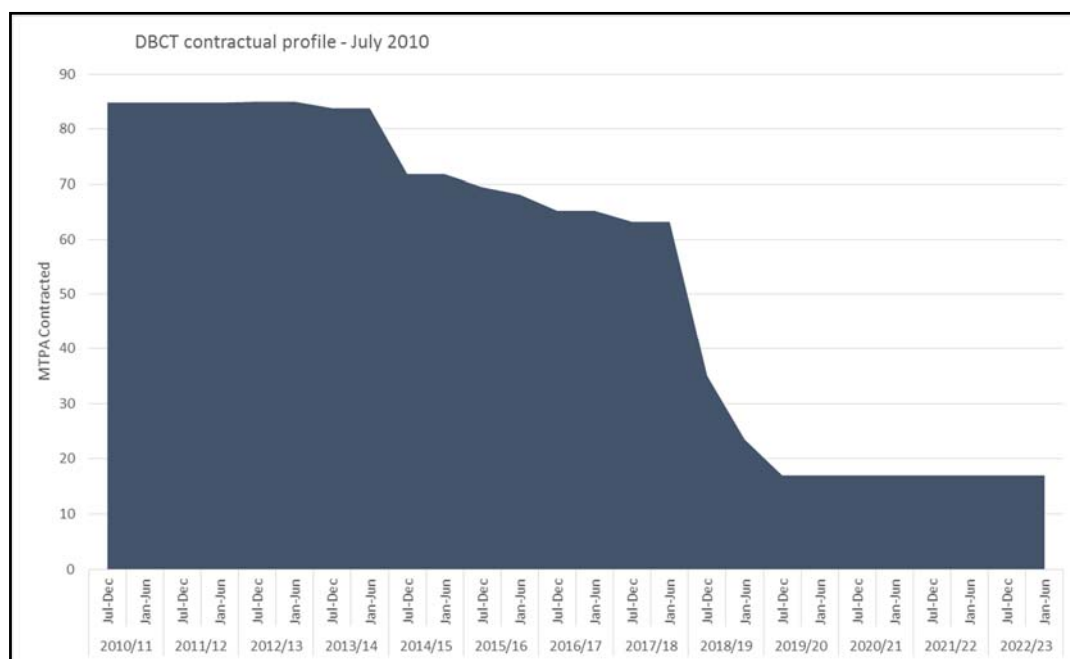

Figure 8: Contractual Position July 2010 (DBCT Management, 2016)

2.4.5 Contractual Position February 2016

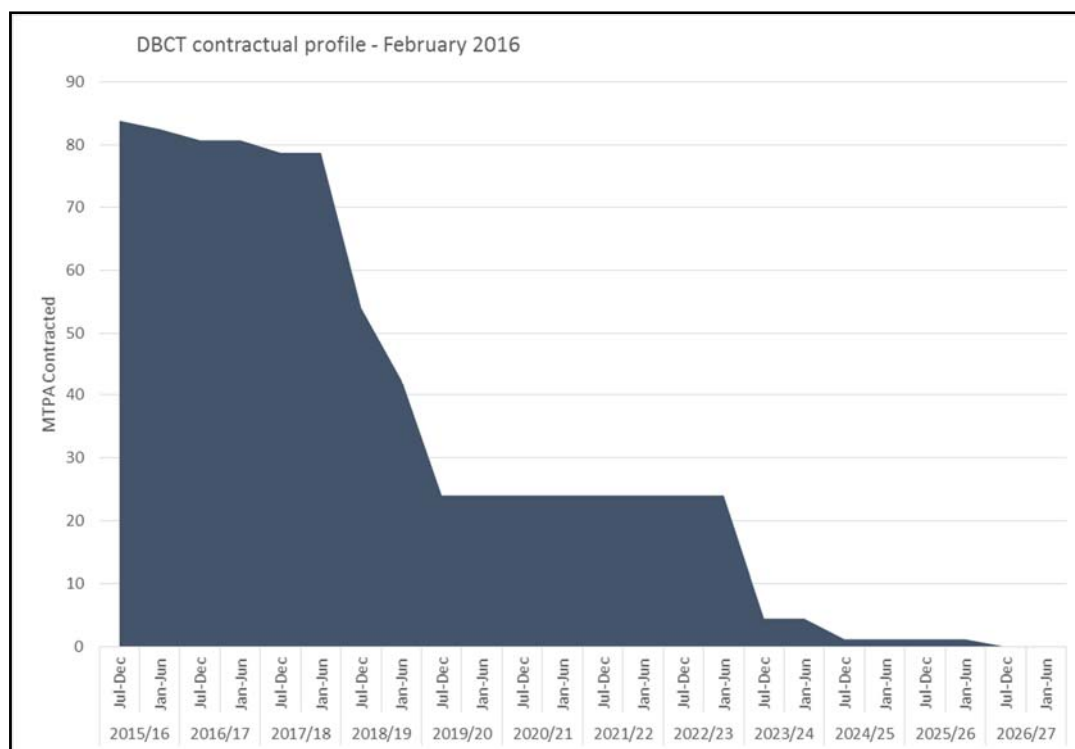

Figure 9: Contractual Position February 2016 (DBCT Management, 2016)

DBCT Management holds a capacity demand queue (DBCT Access queue) amounting to 99.57 Mtpa of additional staggered capacity.

2.4.6 Regulatory Regime

DBCT is declared for third party access under the Queensland Competition Authority Act 1997 (Qld) (QCA Act). Under the terms of the PSA entered into by DBCTM/DBCT Trust with Queensland Government owned entities at the time of entering into the leases, DBCTM was required to submit a draft Access Undertaking (AU) to the QCA for approval. The AU details the terms and conditions (including the tariff that can be charged) under which third parties can access DBCT’s services. The port is also subject to a safety regime established under the Transport Infrastructure Act 1994 (Qld) and the Transport Operations (Marine Safety) Act 1994 (Qld).

The current AU covers the period from 1 January 2011 to 30 June 2016. The next undertaking (2015 DAU) is expected to be approved in early 2017 and backdated to 1 July 2016.

After the approval of the first AU (2006 AU), the existing Terminal User Agreements were replaced with a Standard Access Agreement (SAA). The SAA forms part of and is based on, the terms and conditions set out in the AU. The revenue cap approach and the risk profile proposed in the QCA’s final decision, are reflected in subsequently approved AU’s and SAA’s as follows:

- The 2006 AU (including a new SAA) was approved on 15 June 2006 and backdated to 1 July 2004
- The 2006 AU expired on 31 December 2010, and was replaced with the 2010 AU agreed with stakeholders and approved by the QCA in 2010.

- The 2010 AU expires on 30 June 2016, with the replacement draft AU submitted to the QCA in late 2015.

The 2010 AU provides for efficient use of terminal capacity. In particular, before expanding the terminal capacity, DBCTM will ensure contracted capacity at the terminal is aligned with the available system capacity¹. In support of this principle, the Terminal Master Plan is integrated with the System Master Plan, which is the framework for expansion of the System in the most logical and efficient way, determined collaboratively by all system participants.

2.5 Government Legislation

2.5.1 Government Legislation

In July 2011, the UNESCO World Heritage Committee requested the Australian Government undertake a comprehensive strategic assessment of the Great Barrier Reef World Heritage Area (GBRWHA) and develop a long-term plan for sustainable development that will protect the region's outstanding universal values. This assessment has been completed by the Federal and Queensland Government and resulted in the development of the *Reef 2050 Long Term Sustainability Plan* ('*Reef 2050*').

The Queensland Government has responsibility for protection of the State waters and is therefore committed to a number of *Reef 2050* initiatives relating to port development. The Queensland Government has recently introduced new legislation, the *Sustainable Ports Development Act (2015)* which sets out the new blueprint for port planning and management for certain ports in Queensland. The act aligns with the Commonwealth and State Government commitments under *Reef 2050* developed in response to recommendations of the UNESCO World Heritage Committee.

This legislation outlines a number of new initiatives including:

- identification of the Port of Abbot Point, Port of Gladstone, Ports of Hay Point & Mackay and the Port of Townsville as 'priority ports' which require formal 'Port Master Plans' to regulate development consistent with principles of 'ecologically sustainable development';
- introduction of statutory 'Port Overlays' to implement the master planning objectives;
- protection of greenfield landside and marine areas through the prohibition of certain future development;
- prohibition of certain capital dredging along the Queensland coastline, and;
- prohibition of sea-based disposal of capital dredge material within the GBRWHA.

Formal 'Port Master Plans' will be prepared by the State in consultation with port entities, relevant local governments and other state entities such as State Development and the Department of Environment & Heritage Protection.

¹ System Capacity is the maximum reasonably achievable capacity of the system, being the components of the Goonyella Coal Chain infrastructure relating to transport of coal from mines whose coal is handled by DBCT

DBCTM views this Terminal Master Plan as a critical input into the Long Term Development Plan being prepared by NQBP and subsequently into the formal State ‘Port Master Planning’ process to be undertaken in 2017, as shown below.



Figure 10: Queensland Planning Process

2.5.2 Proposals for Land Use and Site Development

Under the *Transport Infrastructure Act 1994* (TIA), a Port Authority is required to develop and review a Land Use Plan to ensure the appropriate and sustainable development of strategic port land. As the Port Authority for the Port of Hay Point, NQBP has the responsibility of preparing and revising the Land Use Plan and administering all ‘Assessment Manager’ functions pursuant to the *Sustainable Planning Act, 2009* (SPA) for all assessable development on areas classified as ‘Strategic Port Land’ at the port.

The current Port of Hay Point Land Use Plan was approved in July 2010 and provides an overall framework for the appropriate regulation and management of the development of strategic port land. The Land Use Plan was prepared in accordance with the statutory provisions of the (TIA). It sets out NQBP’s planning and development intents for its strategic port land at the Port of Hay Point, while giving careful consideration to core matters relevant to the local and regional area including environmental, economic and social sustainability.

As a point of reference, Figure 11 shows the current off-shore and on-shore areas defined as Strategic Port Land at the Port of Hay Point. Figure 12 shows DBCT more specifically.

It is anticipated that the existing LUP will be amended following (or concurrently with) the preparation of the formal State Port Master Plan under the *Sustainable Ports Development Act, 2015*.

This is expected in 2017-2018.

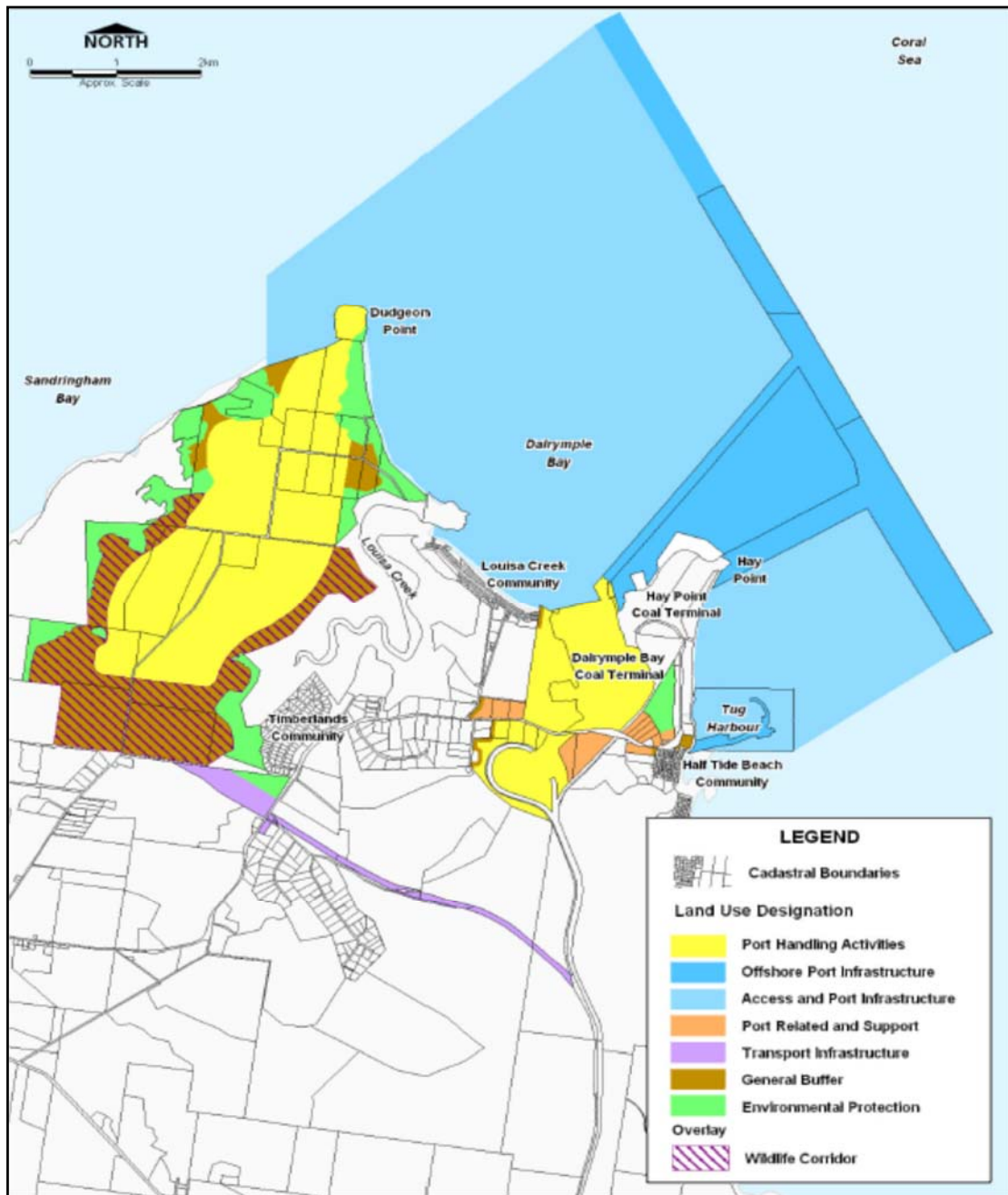

Figure 11: NQBP Strategic Port Land and Offshore Port Infrastructure Hay Point (NQBP, 2010)

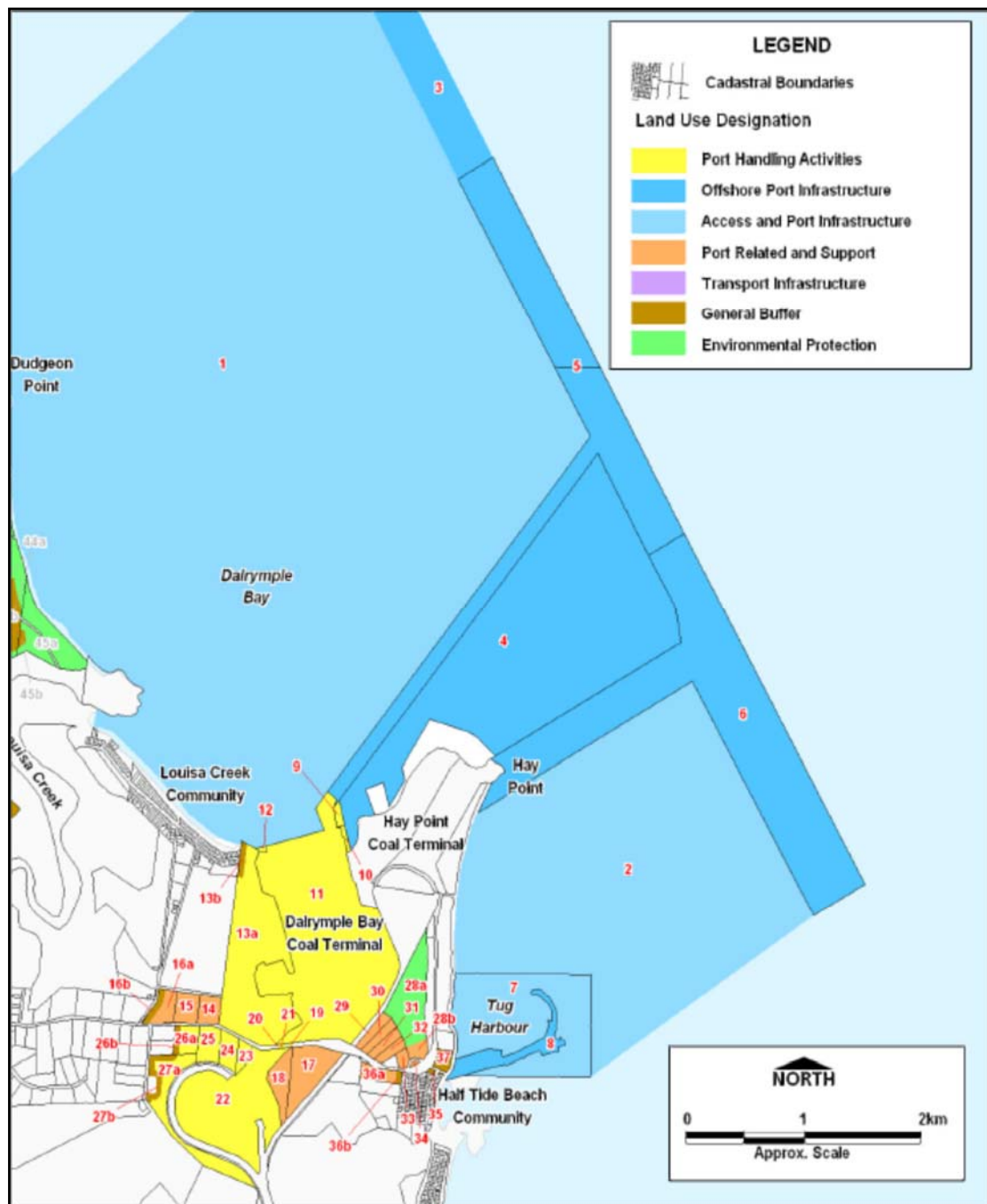

Figure 12: DBCT development on Strategic Port Land (NQBP, 2010)

All future expansions of DBCT will be developed to meet the land use provisions of the 'Port of Hay Point Land Use Plan – Port Handling Activities Area and/or Offshore Port Infrastructure'. The land will be used for the purpose of loading, unloading and transport of commodities (bulk coal) to support the Central Queensland Coal Industry. Aspects of the preferred site development are contained in Chapters 5 and 6 of this Master Plan.

3 Current operations

3.1 Mode of Operation

Bulk supply chains can be operated in a variety of configurations, however Australian coal terminals generally operate under one of three methodologies:

- cargo assembly
- dedicated stockpiling
- Hybrid (a combination of dedicated stockpiling and cargo assembly)

The decision to choose one operating mode over the other will likely result from the number of discrete products which need to be accommodated and the available space for stockpiling the various coal products.

A dedicated stockpile port allows terminal users to stockpile large amounts of product at the port without:

- a vessel necessarily being waiting at the terminal load that product
- a vessel being in transit to the loading terminal

In a dedicated stockpiling export terminal, the miner will typically produce the coal and then rail that coal to the export terminal for loading when the next train is available. This in turn should lead to a predictable railing schedule and greater visibility as to when train services will be required. Track infrastructure in a dedicated stockpile operation is designed to suit the regular and consistent mix of trains required to meet contractual obligations. The receiving vessel arrives at the port to load the coal from a dedicated stockpile, as do subsequent vessels chartered to load the same coal product. The railing system replenishes the stockyard by railing product evenly from the mine to the export terminal.

Because of the irregular demand pattern for an individual product and DBCT's available storage space in the stockyard, it is impossible to maintain dedicated stockpiles for all products handled by DBCT. DBCT has evolved to operate under a cargo assembly logistics methodology. Contrary to a dedicated stockpiling operation, a cargo assembly operation requests railings for products to meet the arrival of the vessel. In the DBCT cargo assembly operation, a vessel typically arrives and once all parcels to be loaded on the vessel are produced and available for railing, the above rail operators bring the coal to the terminal where it is assembled in the available space in the DBCT stockyard. Railings to complete the vessel are subject to the availability of the mine load-out, DBCT stockyard space, above rail assets and below rail pathing

Under cargo assembly, the stockpile for each individual vessel and each parcel on that vessel needs to be separated from the other cargoes in the stockyard. This separation avoids product contamination between distinct parcels and cargoes. The space between individual products is unable to be utilised. To reduce stockpile separation and the resulting unutilised space in the stockyard, particularly when the same product is required for multiple vessels, limited dedicated stockpiling (hybrid) was introduced for high volume products. The hybrid operating methodology is covered later in this chapter.

3.1.1 DBCT Dedicated Stockpiling Option

Dedicated stockpiling in the existing DBCT footprint is not a viable option for the following reasons:

- The additional land required to support dedicated stockpiling would consume all current expansion options for DBCT, yet only provide 85 Mtpa of terminal capacity
- The capital cost of such additional stockyard space would need to include new bunds and additional yard machines
- Current Access Holders would have to bear the full cost of the current operation and the terminal expansion required to create dedicated stockpiles to service 85 Mtpa. A move to dedicated stockpiling without derating the nameplate capacity would cause a material increase to the current Terminal Infrastructure Charge (TIC) for no additional handling capacity.

3.1.2 Hybrid

Recognising the improved stockyard space utilisation of a dedicated stockpiling operation and the storage efficiency of a pure cargo assembly model, the supply chain identified an opportunity to implement a combination of both operating modes to best utilise supply chain assets.

The hybrid operating mode was designed with two objectives in mind,

1. Pre-railing for selected parcel builds where efficiencies can be gained across the various assets of the supply chain
2. Multiple parcel builds using the same stockpile space to improve the efficiency of the terminal stockyard

By better utilising the space required to build cargoes for high volume products with the same coal characteristics, the supply chain can make better use of the available DBCT stockyard space. Pre-railing allows for a more even drawdown of cargo across the supply chain, therefore allowing a more efficient and effective use of all supply chain assets.

This resulted in the implementation of a hybrid operating mode for the DBCT supply chain.

Under the hybrid operating mode, the supply chain planners look at upcoming demand and identify opportunities where the same product is required for multiple near-spaced vessels. Under cargo assembly, the stockyard planners would ordinarily plan to stack the cargoes for two vessels into distinct separated stockpiles. Under the hybrid system, the stockyard planners have the ability to plan for the same product (required for two or more vessels) to be stacked into a single stockpile. This removes:

- the need for the stockpile separation between similar products for multiple vessels
- the amount of time the stockpile footprint is allocated but unutilised while the terminal waits for the rail payload to fill that allocated space.
- the need for a remnant space for that product. If demand continues for long enough to justify the reallocation of the remnant space to the dynamic zone, a remnant may not be required for the hybrid product for as long as shipping

demand can justify the hybrid stockpile.

The hybrid operating mode attempts to address the shortcomings of a pure cargo assembly operation and is intended to be used for at least two vessels, or a long succession of vessels. The supply chain only needs to consider the arrival of vessels requiring the same product soon after one another prior to building the hybrid stockpile. The duration of the existence of the hybrid stockpile is then only limited by the continuing, near-spaced shipping demand for that particular coal type.

Under both cargo assembly and the hybrid operating mode, the terminal operator needs a variety of vessels at its disposal in order to maximise berth utilisation. This may include vessels already anchored in the Port of Hay Point, or vessels which are on their way and soon to arrive. Should a mine be unable to produce coal for the next ship in the queue and where other vessels are available for loading, the terminal operator can promote another vessel. Utilising vessels further down the queue is preferential to foregoing the use of outloading capacity by allowing an unoccupied berth or an idle outloading system.

3.1.3 Remnant Management

To assist in vessel loading requirements, and without impacting the utilisation of the DBCT stockyard, the DBCT stockyard has been segregated into two distinct zones. Row seven and the half row eight are used for the exclusive purpose of managing remnant coal, this area is known as the 'static zone'. Each Access Holder is allocated a portion of the total volume of the static zone in accordance with its share of Aggregate Annual Contract Tonnage. The remaining six rows of the stockyard operate in full cargo assembly or hybrid mode, otherwise known as the 'dynamic zone'.



Figure 13: DBCT 7X zonal yard layout incorporating Remnant Management in rows 7 & 8 – (DBCT Management, 2016)

This vessel assembly strategy sees two cargo assembly or hybrid stockpiles allocated to each parcel in the dynamic stockyard zones (coloured blue, orange and green in figure 14). The dynamic zone will ideally comprise one less than the total number of trains required to complete the parcel or cargo. Any remaining coal from the final train not required to complete the parcel or cargo will be stacked into the Access Holder's remnant stockpile.

If the Access Holder has suitable coal in its allocated remnant area, the amount of coal railed should ideally be less than the required parcel or cargo. The balance of the parcel is 'topped' up from the Access Holder's remnant stockpile. If there is insufficient coal in the remnant area to complete the vessel, the remainder of the coal in the last train used to complete the parcel will be stacked into the Access Holder's remnant area.

Each Access Holder is responsible for managing the quantity and quality of remnant coal in its dedicated area, including separation requirements for different products.

3.2 Operations

3.2.1 DBSCC ordering principles

Following a recommendation by the Integrated Logistics Company, the DBCT supply chain commenced a change in logistics philosophy starting in March 2014, with the final elements introduced in August 2015. A new process was introduced to take the system capacity closer to the 85 Mtpa nameplate capacity, provide rate capacity when needed and execute these in an equitable way.

The Dalrymple Bay Supply Chain Coordinator (DBSCC) received unanimous agreement from all stakeholders to undertake a trial to:

- Align the supply chain to a common velocity, which was calculated on a designed constraint in the system – the DBCT stockyard.
- To enable rail operators a delivery window for assembling the parcels and cargoes in the DBCT stockyard, allowing the rail operators ultimate flexibility to balance and manage rail deliveries within the confines of the commercial agreements
- Allow the rail operators the flexibility to cancel and deviate trains to best suit their operations and contractual requirements
- Introduced fixed, firm and flexible periods which assist the supply chain planners in minimising the impacts of vessel ETA and coal availability date changes on the railing and berthing schedules.

The DBSCC is a deviation away from the previous system where the terminal planners, acting as the rail agent on behalf of the collective terminal users would place weekly and daily rail requests that may not have been achievable within the constraints of the above rail and below rail contractual agreements and as a result were further constraining the terminal stockyard.

The results of the early DBSCC implementation have been promising and due to a number of factors including the DBSCC, producers have been enjoying sustained periods of record low demurrage. This record low demurrage situation occurred while the supply chain was exporting high tonnages prior to the demand drop-off seen at the end of the 2015 calendar year. This trend of lower wait times can be seen in figure 14 below.

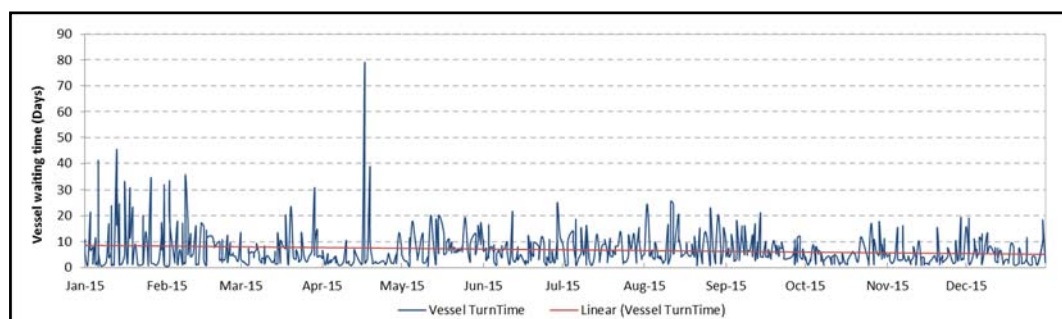

Figure 14: DBCT Vessel waiting times - 1 Jan – 31 December, 2015 (DBCT Management, 2016)

3.2.2 Service Provision

Terminal capacity is calculated considering historical service provision and shipping mix (the capacity model accounts for the impact of differing service requirements). However, if future service requirements evolve beyond the current demands, the rated terminal capacity could be adversely impacted. Any detrimental impact of terminal service demands can also impact the upstream coal chain, causing individual supply chain assets to operate below their rated capacity, in turn compromising the overall system capacity.

Because of product diversification catering for specific coal blends, DBCT is required to meet varying service requirements. Different coal types present different handling characteristics, requiring a variety of handling strategies to ensure the product can be handled by the terminal without compromising the coal quality. Reduction of normal equipment rates to cater for these individual products can impose a performance impact on terminal capacity.

Producers pay a common tariff per tonne of coal shipped, however different handling requirements will impact the terminal’s performance (e.g. sticky coal, blending, dusty coal, wet coal). Some of these coal types and product blends consume more terminal capacity than others. The handling characteristics of individual coal types may also impact performance of the assets upstream of DBCT.

3.2.3 Vessel Trends

DBCT can load coal onto vessels ranging from 40,000 Dwt tonnes in size, up to approximately 220,000 Dwt. DBCT is primarily exposed to four classes of vessels: Large Cape Size (140,000-220,000 Dwt), Capes (100,000-140,000 Dwt), Panamax and Japmax (65,000-100,000 dwt) and Handimax (40,000-65,000 Dwt). Due to limited deballasting capability in small vessels, loading times are not proportionate to the size of the vessel as demonstrated in table 3, which outlines the comparative load rates by vessels loaded at DBCT in the 2015 calendar year. The load rates show a clear bias towards fast loading performance into the larger vessels.

Vessel Type	Avg load rate (tph)	Avg load time (Hours)	% of total vessels	# of vessels
VLC	4,924	30.47	40%	267
Cape	5,025	21.52	6%	39
Japmax	4,828	16.17	33%	223
Panamax	4,202	15.82	16%	107
Handimax	3,303	13.58	5%	31

Table 3: DBCT ship arrivals 1 Jan – 31 December, 2015 (DBCT Management, 2016)

Coupled with supply chain and terminal performance improvement projects, DBCT’s outloading capability has been enhanced by the recent proliferation of larger vessels. Larger, newer vessels offer economies of scale and efficiency advantages to the charterer, while generally offering better deballasting performance for the loading terminal. DBCT vessel loading rates are much higher when loading into larger vessels in comparison to smaller vessels, this is largely due to the differences in vessel deballasting capabilities.

DBCT’s average vessel size surpassed 100,000 tonnes in 2010 and has remained mostly constant in the years following (Figure 15). Despite this consistent trend towards larger vessels, the arriving vessel mix can change from month to month in

response to freight rate volatility. DBCTM must continually assess its terminal capacity assumptions using the latest vessel arrival size distribution data. Despite the month to month variations in freight rates for the various vessel classes, DBCT has consistently loaded vessels for days and weeks at rates well above the 85 Mtpa nameplate capacity.

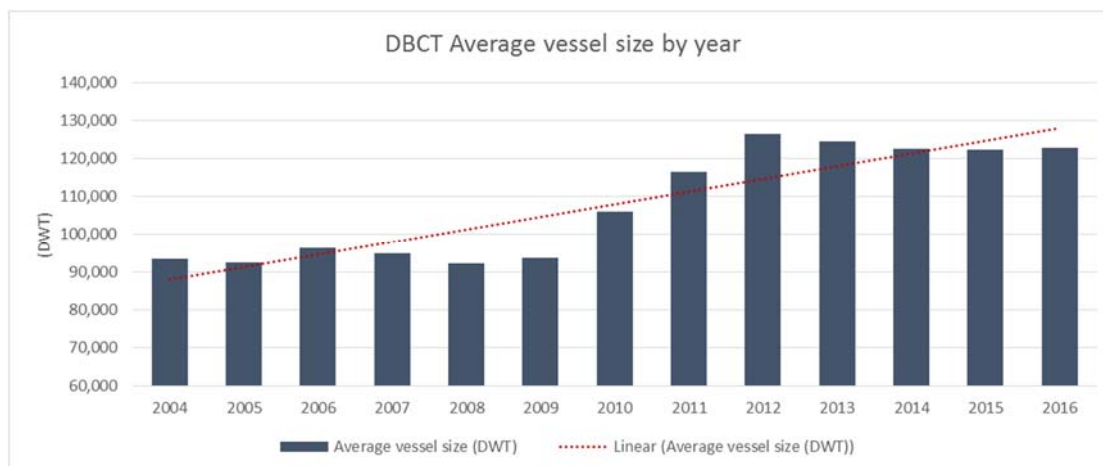

Figure 15: DBCT vessel sizes 2004-2016 (DBCT Management, 2016)

3.2.4 Mine Load Points & Recharge Capability

The performance of individual train loading infrastructure at the various mines also contributes to overall system capacity. The capability of mine load-out infrastructure must be able to support the hybrid and cargo assembly requirements of the downstream supply chain assets. If the individual train load out capabilities do not allow for a hybrid/cargo assembly build rate of 85 Mtpa, the total system capacity is likely to be compromised. This occurs because delays in an under-performing mine load-out impact delivery of coal to the terminal. With trains arriving at the terminal later than scheduled, that same train may be late in arriving at the next mine load-out on the empty run.

None of the supply chain infrastructure stakeholders have been given a remit to set a minimum benchmark performance rate for new mine loadout builds. Coupled with legacy mine loadouts, which were built at a time when there was less of a “system” focus, there is wide variation between the capabilities of individual mine load-outs. Downstream supply chain infrastructure assets and operating strategies have necessarily been built to accommodate this wide variance in train load-out performance.

4 Supply/Demand Based Projections

The Port Services Agreement requires DBCTM to:

- assess the current and future needs of Producers for services and facilities; and
- provide projections for the demand for services at DBCT.

4.1 Throughput Growth

DBCT’s throughput for financial year 2014/15, was a record 71.5 million tonnes. While a gap still exists between DBCT’s best ‘year’ of throughput (71.5 million tonnes) and terminal capacity (85 mtpa), this has been driven by sub-85 Mtpa levels of demand. While it is difficult to assess mine capability, it is assumed that the take or pay nature of the DBCT access agreements have incentivised DBCT Users to contract port capacity sufficient to meet mine production, potentially with some extra capacity contracted to provide logistical flexibility.

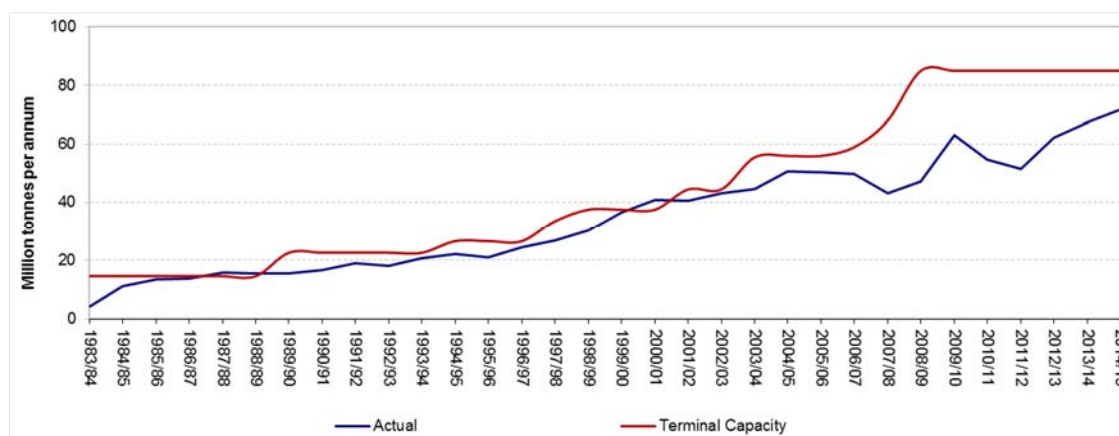

Figure 16: DBCT throughput and capacity growth history (DBCT Management, 2016)

In the current depressed coal markets and with costs clearly under focus, it is assumed that any over-contracted capacity is likely to be assigned away to parties with increasing capacity requirements (expanding miners) over coming years. DBCTM expects the transfer of unutilised terminal capacity to expanding miners to occur over the short to medium term. Once the unutilised capacity has been transferred away to the expanding miners, DBCTM expects new demand for capacity to be satisfied by the incremental expansions outlined in this master plan. Unlike the previous unprecedented mining boom, DBCTM expects the next wave of coal mine development to occur in a much more measured and staggered fashion.

4.2 Metallurgical Coal History

DBCT’s predominant export product is metallurgical coal, which includes PCI and coking coal and accounts for approximately 82-85% of total throughput. DBCTM’s planning is primarily focused on the prospects and projections for metallurgical coal demand and development, as this is the dominant resource within DBCT’s catchment area.

Metallurgical coal is mainly used for steelmaking, with integrated steel mills requiring between 0.7 and 0.9 tonnes of metallurgical coal to produce one tonne of steel. Prices trended down over most of the 1990s but began to rise in 2001 before spiking in 2008. Prices spiked again in 2011 as flooding reduced Queensland export volumes by approximately 13%. Spot prices have since fallen to about \$81.50/mt FOB Queensland (Platts CTI, 29/03/2016). This pricing history is shown in Figure 17 below.

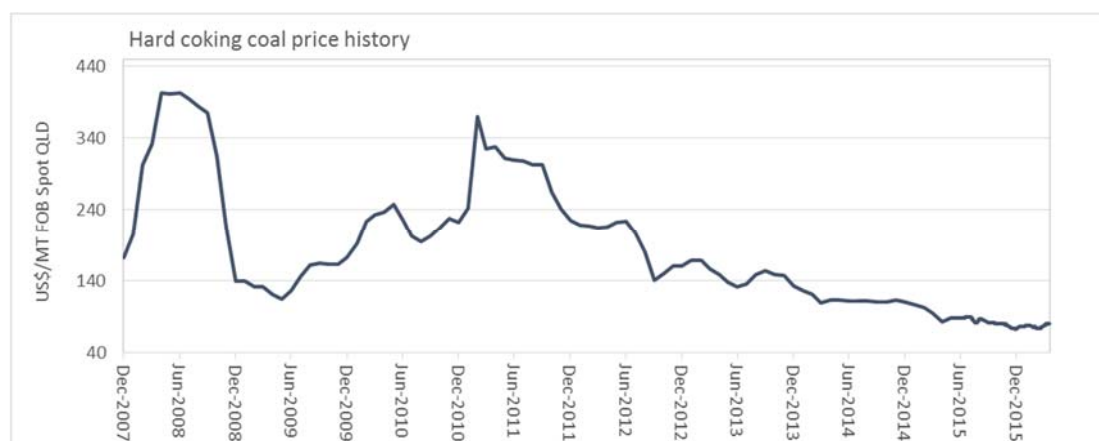

Figure 17: Spot FOB Newcastle Thermal and QLD met coal price history (Platts CTI, 2007-2015)

China is the world's largest producer and consumer of metallurgical coal (62% and 67% of the total, respectively). Australia and the US are the world's other major producers, while Japan and Europe are other major coal consumers. Global metallurgical coal production is estimated at about 1,000 million tonnes per annum (World Coal, 2014). Seaborne metallurgical coal trade was approximately 299 Mt in 2015 (Australian Government, December 2015) as the vast majority of coking coal required for steel production is produced domestically.

Australia is the dominant metallurgical coal exporter, holding 60% of the market, followed by the US which holds approximately 20%. About 80% of Australia's exports go to Asian markets, although Australian producers do ship significant volumes to Europe. Half of US coal exports are taken by Europe and the balance is divided between Asia and the Americas. Imports are much less concentrated, however the Far East (combined) takes just more than half of global volumes, with China alone accounting for about 20% of the global seaborne market.

China's investment-led growth strategy saw its economy boom during the 2000s, driving up consumption of many raw commodities (particularly metallurgical coal and iron ore) and steel. From 2000 to 2013, the urban population in China grew by an average 20 million people per annum. This urbanisation process required massive volumes of steel to meet demand from infrastructure and building projects. Over the same period, Chinese steel production grew by an average of 50 Million tonnes annually, increasing from 129 Mt to 823 Mt, (This represented 7 times the steelmaking capacity of the U.S.) and more than 90% of this was met by integrated steel making (Brookfield Research, July 2015).

As demand boomed, China's domestic metallurgical coal industry's output increased from 100 Mtpa in 2000 to 600 Mtpa in 2014. This was the equivalent of adding 6 times U.S. metallurgical coal production within just 14 years. Ultimately, demand grew faster than domestic supply and China needed to enter the import markets. In 2015, China needed to import only 53 million tonnes to supplement domestic supply (Australian Government, December 2015). This accounted for 85% of the demand growth in the seaborne market from 2008 to 2014 and currently represents 18% of total seaborne demand (approximately 299 Mt) (Australian Government, December 2016). In response to surging demand, prices were pulled higher to draw the supply from greater distances to the demand centres in China. North American producers increased exports from 56 Mt in 2009 to 94 Mt by 2012, 12 Mt of which went directly to China (most of the rest went to Japan, South Korea and India) (World Coal, various years). With the rising seaborne price, the cash costs of miners increased quickly. Miners were motivated to produce and export the tonnes at any cost, given the cost was likely to be lower than the sale price of the coal.

From 2009 to 2013, China dominated the seaborne market, taking the bulk of the incremental demand followed by India in distant second. Over this period, China added 10-30 Mt of incremental demand per year, with 2011 the only exception as imports dropped by 3 Mt, while India's incremental demand was an additional 2-6 Mtpa. The strong incremental seaborne demand from China declined in 2014 when imports fell by 13 Mt from the previous year.

4.3 Supply

The supply of metallurgical coal into the seaborne market is currently dominated by four suppliers. Australia has a 63% share, US based producers hold 18%, Canada holds 8% and Russia holds 7% (Australian Government, December 2015). Queensland and Australian coal producers have a natural geographical advantage over many other metallurgical coal producers, who are generally located further away from DBCT's typical Asian buying regions.

As metallurgical coal demand grew, spot prices climbed from US\$60/mt in 2003 to over US\$400/mt in 2008. In 2011, helped by the temporary supply reduction from Queensland due to flooding, the spot price of hard coking coal surpassed US\$330/mt FOB (Platts CTI, February 2011). These higher coal prices incentivized miners to invest in new coal production capacity. Since 2009, Australia has increased its exports by 50 Mt and the U.S. by 20 Mt.

Between 2015 and 2019, Australian miners are expected to add approximately 20 Mtpa of incremental capacity from existing mines, or projects which are either under construction or ramping-up. Similarly, miners in Russia and Mozambique will bring online an additional 10 Mt of production capacity to the seaborne market from existing mines, or projects currently under construction or ramping-up. Those volumes combined with a few projects in other regions will bring close to 35 Mtpa of additional supply to the market at cash costs that are below current prices. Incremental volumes from existing mines could also grow substantially, driven by productivity gains.

DBCTM expects Australian producers to continue driving cost reductions and to continue benefiting from a low Australian dollar. If these factors persist, it will help the Australian miners retain the competitive advantage held over producers located in other regions. Many of the top tier coal producers in the US have already been forced to idle their coal mines, or seek bankruptcy protection under Chapter 11 provisions. Following the sustained downturn in the coal markets, the US has experienced a substantial drop in coal exports from 2014 to 2015 (Australian Government, December 2015).

New projects in Mongolia, Mozambique and Columbia have all been impacted by recent price declines. Mozambican coal production has also faced delays and extra costs to repair, upgrade and build coal transport infrastructure. The most advanced and notable mine and accompanying infrastructure project in Mozambique is owned by Vale. The Moatize mine project and associated Nacala rail upgrade will increase the mine's export capacity from 11Mtpa to 22Mtpa. Given its proximity to India and Europe, Mozambique's coal production has the potential to displace demand for Australian metallurgical coals.

4.3.1 Domestic Indian production growth

Enabled by a pro-development Modi government, Coal India Limited recently announced plans to develop 15 additional Coal wash plants by September 2017 to double domestic metallurgical coal production and take the country further towards resource self-sufficiency. Currently there are 15 coal washplants in the country, producing a combined 38 Mtpa of coal (India Ministry of Coal, February 2016). A doubling of coal washing facilities would represent an ambitious target for a country

that has typically had difficulties in securing land and development approval for mining infrastructure.

While India has abundant coal reserves, the coal reserves generally aren't in areas where the coal is consumed. The coal also tends to be lower quality and with higher impurities than Australian coals. Mine developments have generally been subject to delays while land is acquired and the mining lease awarded. Given the aggressive steel growth forecasts, DBCTM expects that India is likely to need to supplement its domestic coal production with seaborne coal or steel imports. DBCTM expects sustained strong GDP growth and faster growth in BOF steelmaking capacity, which should sustain demand for metallurgical coals (Brookfield research, 2015)

India's mining cash costs are among the lowest in the world. India's seaborne demand will largely depend on the performance of its domestic coal industry. DBCTM is doubtful that the Indian coal industry will keep pace with the Indian steelmaking industry's growing metallurgical coal demands.

4.3.2 Chinese Domestic production

Chinese domestic producers account for 3.9 billion tonnes per annum of coal supply. Many of these producers are reportedly running at losses to supply steel mills which have high levels of unutilised capacity. The Chinese government recently imposed two key policies which were designed to protect Chinese coal producers from competition from imported coals. The first of the key policies involved quality checks for trace elements, the second was a blanket tariff applied to imported coals (Australian Financial Review, October 2014).

More recently, the Chinese government reported it was planning to reduce the number of workers employed by the steel and coal production industries by approximately 15%. The goal of the program was to provide funding to find these workers alternative employment in other areas of the economy and potentially other geographical locations. This reduction in the workforce is expected to ultimately lead to a reduction in production from those two industries (China Human resources and Social Security Ministry, February 2016). This reduction in excess steelmaking capacity and the corresponding reduction in coal production may improve steel production conditions for DBCT's other typical coal export destinations. A commensurate reduction in Chinese domestic coal production may also result in higher import demand for coal from Australia.

4.4 Drivers of demand

Global crude steel production grew from 1,343 million tonnes in 2008 to 1,665 million tonnes in 2014 (3.8% CAGR), although this rate has stagnated recently due to a number of macro-economic factors globally and in China. Global steel production fell in 2015 (YoY - Figure 18) (World Steel Association, 2015, 2016)

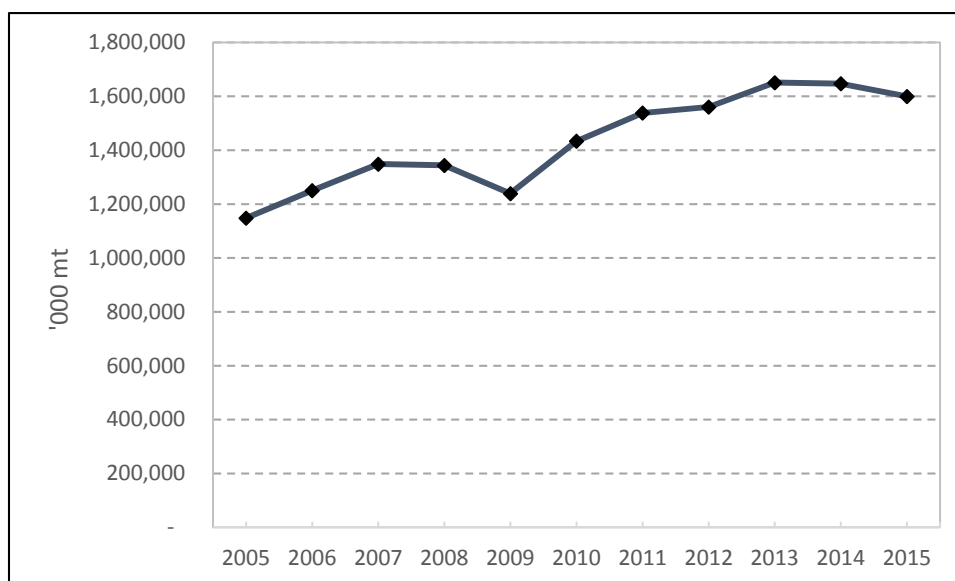

Figure 18: World crude steel production – World Steel Association, 2015

The comparatively mature economies of Japan, South Korea and Europe have well-developed steelmaking capacity, but are generally not endowed with domestic metallurgical coal reserves. These economies experienced growth in their steelmaking industries well before the recent rise of China and India as steelmaking giants. South Korea and Japan experienced similar rapid growth in the early development phases of their economies, but have stabilised at approximately 70 Mtpa and 110 Mtpa of crude steel production respectively. Chinese and Indian steel production and coal demand has grown rapidly and is expected to eventually mature and stabilise like the Japanese and South Korean economies before them. It is uncertain when this stabilisation will occur and at what level of annual production this is likely to occur.

Driven by a rapid infrastructure building program, true steel usage per capita in China is currently equivalent to that of Australia. India’s steel usage per capita still lags behind the rest of the world and offers potential for strong growth as the nation’s economy develops (Figure 19 below). China’s true steel consumption per capita more than doubled from 198.8 kg per person in 2004 to 499.4 kg per person in 2013. In Comparison, Japan’s true steel consumption per capita fell from 437.3 kg per person in 2004 to 378.9 kg per person in 2013.

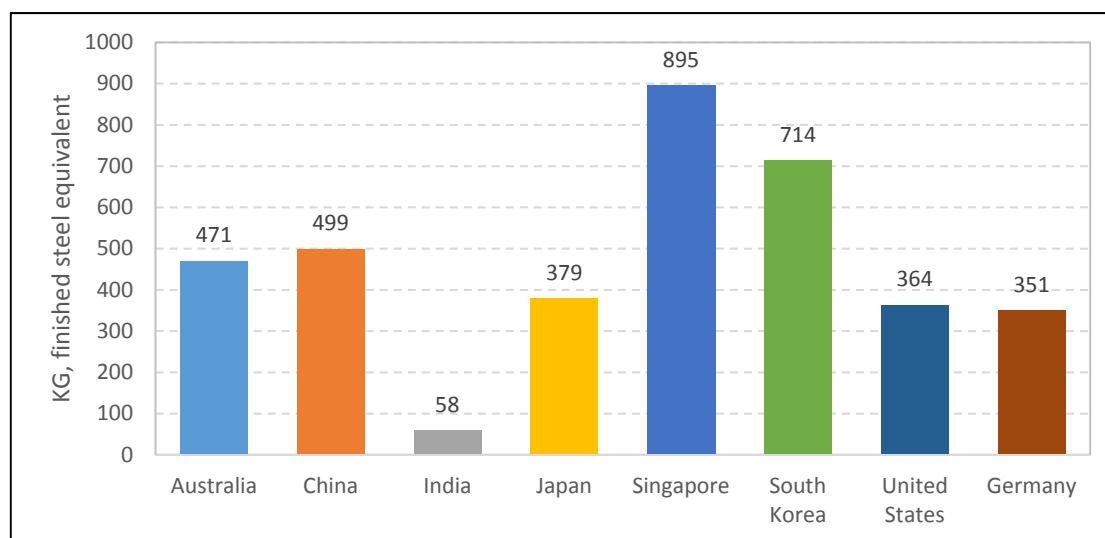

Figure 19: Real Steel use per capita (World Steel Association, 2015)

During the mid to late 2000's, in response to expected continuing high Chinese demand, global metallurgical coal production reached historically high levels through the introduction of new coal mines and capacity expansions at already operating mines. This high supply, coupled with slowing demand is believed to be driving the recent falls in metallurgical coal pricing. In response to low pricing, many global producers took the approach of reducing the unit cost of producing coal by maximising coal production rates. This increased production added extra coal supply to an already oversupplied market.

Coal prices have continued to retreat in the interim, with spot HCC currently trading at US\$81.50/mt FOB Queensland and spot PCI trading at US\$72/mt FOB Queensland (Platts CTI, 29/03/2016). As a result of the poor pricing, most coal expansion projects have been delayed, slowed down, or even cancelled. Deutsche Bank, in a September 2015 Metals and mining report suggested that the global average incentive price for new projects is US\$127/mt. DBCT Management is of the opinion that the coal price will need to at least surpass this incentive price for a sustained period in order to encourage investment in new coal developments or expansions of existing mining operations.

With China's slowing demand growth expected to be a long-term situation, other growing economies are expected to drive demand growth over the medium to long term. The Recent trend of demand volatility can be seen in the performance of DBCT's major coal importing regions in Figure 20. The graph demonstrates recent growing demand from Europe, Japan and India in 2014 and falling demand in 2015 from all regions other than India and Europe.

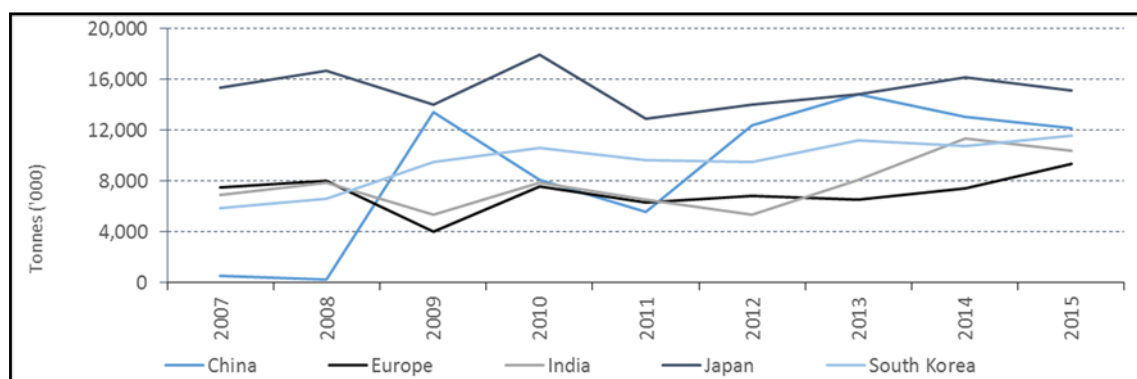

Figure 20: DBCT historical exports to key importing regions (DBCT Management, 2016)

4.4.1 India

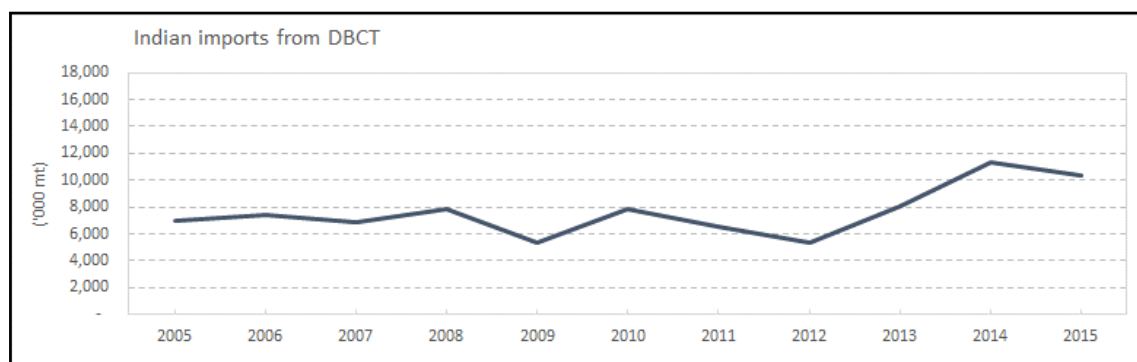

Figure 21: Indian imports from DBCT (DBCT Management, 2016)

DBCTM views India’s ambition to spend approximately \$1 trillion (India Ministry of External Affairs, January 2016) on new infrastructure projects as a likely driver of future metallurgical coal demand growth. India has ambitions to significantly increase the volume of coal it mines and the volume of steel it produces, however India has typically had difficulties meeting such self-imposed production targets. DBCTM expects India to supplement domestically produced coal with imported coal.

With supply channels to India already well established between Queensland coal producers and various Indian customers. DBCT’s exporters are well positioned to capture some of this Indian coal demand growth. DBCT has already seen significant growth to India as an export destination in the past 12-24 months, (Figure 21).

India’s metallurgical coal consumption has been increasing at roughly 3 Mt per year since the early 2000s. India sourced 45 Million tonnes of imports from the seaborne market in 2014, second only to China, which imported 62 Million mt of coal in the same period (World Coal, 2015). Brookfield expects that Indian metallurgical coal consumption growth will rise from 2 Mt to 4 Mt per year. While air pollution is also a major problem in India, there does not appear to be much policy momentum to enforce more strict regulations that could lead to a reduction in steel production. Until now, the key regulatory actions have been focused on cleaning up India’s coal industry (Brookfield Research, 2015).

4.4.2 China

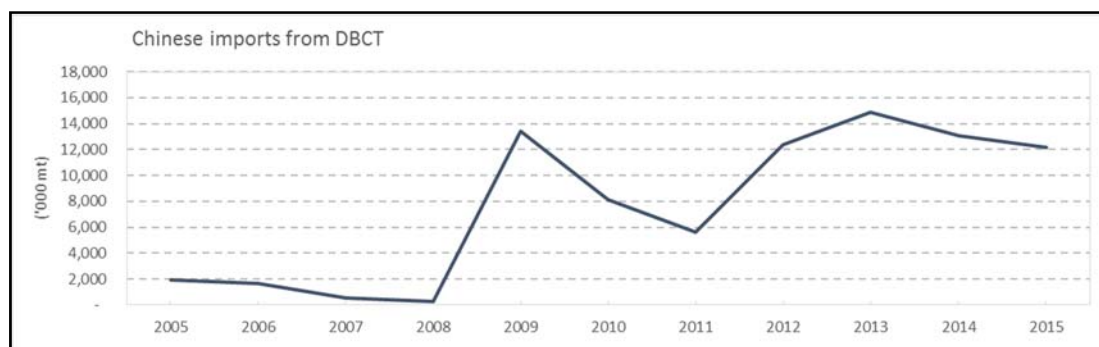

Figure 22: Chinese imports from DBCT (DBCT Management, 2016)

Real GDP growth in China has been slowing and steel production has also slowed, remaining unchanged in 2014 year-over-year at 823 Mt. The China Iron and Steel Association’s forecast that Chinese steel production would fall by ~10 Mt in 2015, suggesting Chinese steel output may have already peaked in 2014. After becoming a relevant player in the seaborne market in 2009, China’s imports grew rapidly. This growth in coal imports reached 75 million tonnes in 2013, before falling to 62 million tonnes in 2014 (Brookfield Research, 2015).

As can be seen in Figure 22, DBCT’s exposure to Chinese imports has grown significantly over the past decade. Chinese buyers have typically only turned to imported coal when the price was lower than domestically delivered coal, meaning China’s demand has been volatile and difficult to forecast. Chinese demand is uncertain, volatile and subject to a number of domestic policies, combined with the general outlook for the Chinese economy. These factors are difficult to project with any accuracy and is not attempted in this master plan.

In response to falling domestic capacity utilisation, Chinese steel producers exported approximately 112 Million tonnes of crude steel to other steel consuming nations in 2015 (Commerzbank, 08 March 2016). Steel producers in these other steel consuming nations have been forced to pursue cases against Chinese steel exporters in an attempt to disrupt perceived Chinese ‘dumping of steel products’. The success, or otherwise of these cases is again difficult to predict, however it may be difficult for the steel margins to improve globally until some of this excess steel capacity is removed from the global market.

4.4.3 South Korea and Japan

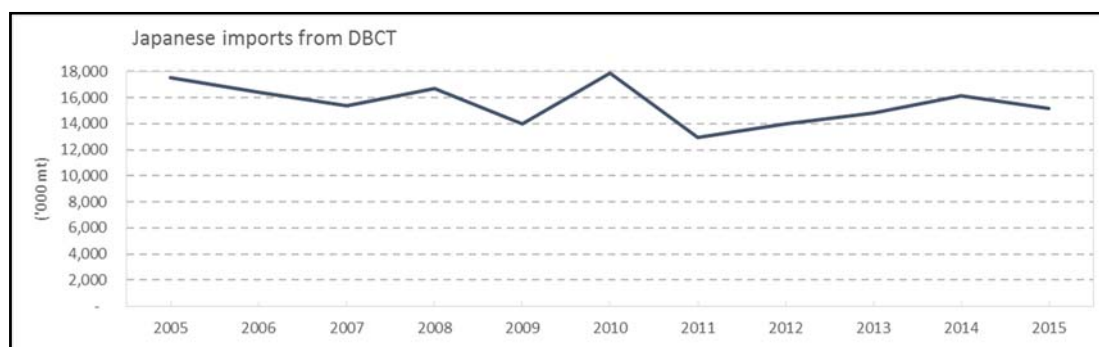

Figure 23: Japanese imports from DBCT (DBCT Management, 2016)

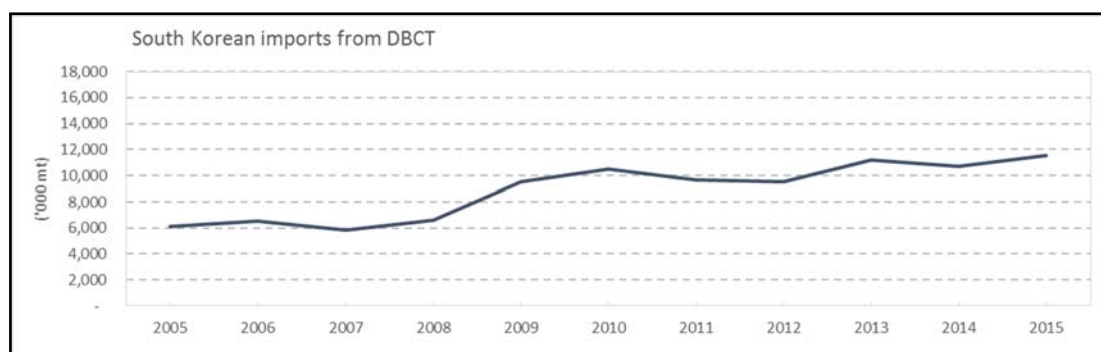

Figure 24: South Korean imports from DBCT (DBCT Management, 2016)

DBCTM views South Korea and Japan as stable destinations for DBCT’s metallurgical coal exports. While these nations are not expected to provide material growth in metallurgical coal demand, these two regions are expected to continue taking a substantial percentage of DBCT’s coal, as has been the case for at least the past ten years. DBCT appears to be an export terminal of choice, due to the quality of the export product and the relationships between the coal end-users and DBCT’s coal producers. Many of the mines that export through DBCT have varying levels of Japanese joint venture ownership, which is expected to continue the long term sourcing of coal by Japanese buyers from these mines.

4.4.4 Europe

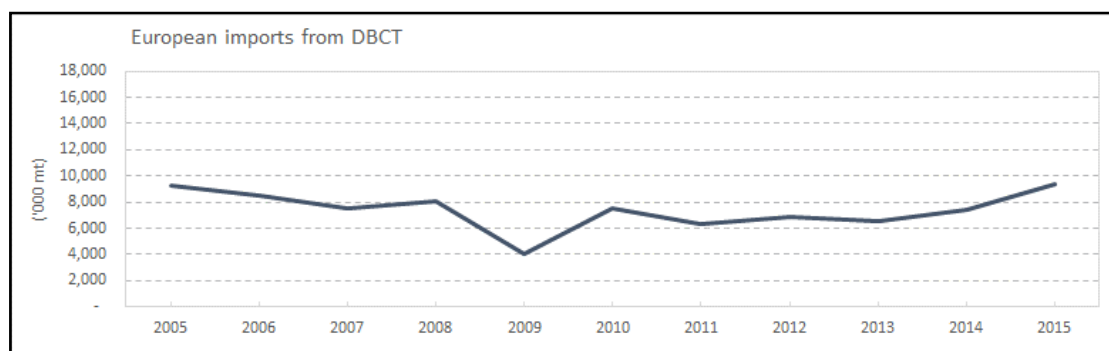

Figure 25: European imports from DBCT (DBCT Management, 2016)

There have been recent closures in some of DBCT’s usual European export destinations, however these closures represent a small percentage of Europe’s overall steelmaking capacity. Europe has been increasing imports of metallurgical coal from DBCT in recent years (Figure 25). Historically low freight rates have likely been a factor in the increasing volumes of exports from DBCT to Europe. DBCTM views Europe’s appetite for DBCT coal to be dependent upon freight rate volatility and the exchange rates of various currencies against the US dollar. Both factors have the potential to impact the ability of DBCT exporters to maintain their recently established foothold in the European markets. It is understood that Australian producers have been able to displace US coal production into Europe. DBCTM is unsure if European buyers would increase imports from the US if the US dollar weakened, or freight rates rose. Both factors would decrease the comparative advantage Australian producers currently enjoy compared to their US counterparts.

4.4.5 Thermal coal

While DBCT’s thermal coal throughput comprises approximately 15% - 18% of total

throughput in any single year, it is necessary to consider thermal coal as an integral element of DBCT's contracted capacity and potential for DBCT's capacity growth. Accordingly, DBCT Management expects demand for thermal coal exports out of Queensland to grow in the medium to long term. Demand for DBCT's thermal coal exports are expected to continue from traditional customers of the DBCT-exporting thermal mines. The growth in thermal coal demand from Queensland and DBCT is expected to increase with continuing economic development in India and the South East Asian regions. In the case of both regions, this is expected to supplement domestic production.

Demand for new expansion capacity could conceivably come from thermal coal developments in the traditional Bowen Basin catchment area. A number of access requests in the DBCT access queue are tied to thermal coal developments in the central Bowen Basin. In the long term, additional thermal coal supply from the currently undeveloped Galilee Basin could trigger an expansion of DBCT. Due to the scale required to justify accompanying rail and port infrastructure developments, thermal coal developments in the Galilee Basin are expected to be larger in scale than those from the Bowen Basin. DBCTM's development pathway caters for both kinds of development, with the Zone 4, 8X and 9X developments providing incremental capacity options between an additional 4 Mtpa and 51 Mtpa.

4.5 Mine Development expansion triggers

DBCTM holds 99.57 Mtpa of access requests. Access requests are a mechanism that provide the access seeker with an option to access DBCT capacity which may become available in the future. When capacity does become available, either due to expansion, an expiring contract, or a terminated contract, DBCTM must offer the capacity to the DBCT Access Queue (access queue). The access queue is formed when available capacity is not sufficient to satisfy the capacity requirements of one or more access seekers.

After the available contracted capacity is offered to the access queue, one or more access seekers may choose to contract the available capacity. In the event that multiple access seekers commit to contracting the capacity, the earlier of the complying access requests will receive the capacity. Unfortunately, the current AU does not place a commitment (legal or financial) on the Access Seeker to remove its access request if the access seeker fails to contract the available capacity. If the access seeker does not choose to contract the available capacity, it may choose to retain its position in the access queue for the full tonnage requested in the access application.

If an access seeker does intend to contract the available capacity, the access seeker is required to sign an SAA. If an access seeker does execute an SAA to contract that capacity, the access seeker's access request will be reduced by the tonnage specified in the schedule of the SAA. The access seeker will retain its position in the access queue, assuming the remaining tonnage under the access application is greater than zero.

DBCTM expects major coal mine developments to recommence once coal prices are sustained above the incentive price. While DBCTM hasn't attempted to determine this incentive price, Deutsche Bank (September 2015) suggested this price globally was approximately US\$127/mt. With the current period of lower pricing, DBCTM has found it difficult to find parties who are willing to convert access applications into take or pay agreements. The most recent example of this is 2.7 Mtpa of capacity which was offered to the DBCT access queue in the middle of January 2016. The capacity is available for use on 1 April 2016. Despite tentative expressions of interest, none of the access seekers have entered into an SAA to contract the available

capacity. DBCTM believes this is due to the current depressed state of the coal market.

The DBCT access queue provides a good representation of the quantum of potential demand for future terminal capacity. Given the lack of obligation or incentive to turn an access application into an access agreement, the access queue is not a good indicator of the timing of coal mine development in a weak coal market. In reality, the access requests continually shift to later dates and are at the mercy of the coal markets of the day.

Considering the volume of access requests in the DBCT capacity queue, DBCTM believes that coal producers and access seekers will be prepared to support their demand requirements through Take or Pay contracts when their mine projects have a realistic chance of proceeding. While DBCT’s current throughput is below terminal capacity, the Bowen Basin contains up to 6.3 billion tonnes of metallurgical hard coking coal reserves which could be developed to take advantage of any demand increase.

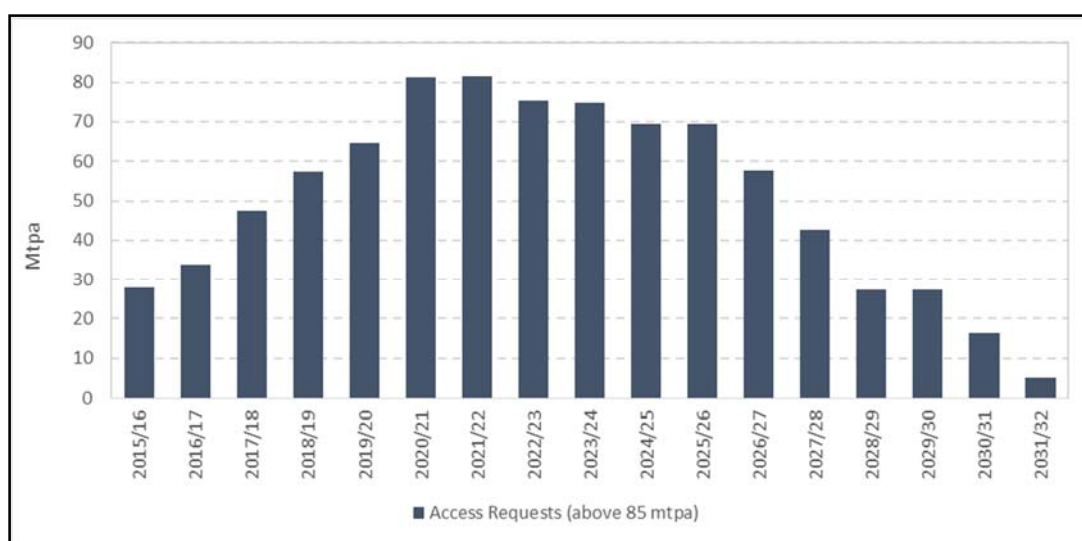

Figure 26 : Aggregated access requests above 85 Mtpa Terminal Capacity (DBCT Management, 2016)

Until there is significant improvement in the coal price to a level that supports new development, it is unlikely that DBCT Management would be required to expand the terminal’s current capacity. DBCT Management expects the Deutsche Bank (2015) incentive price of US\$127/mt for new projects to be surpassed, but not in the short term. Considering the long lead times required for infrastructure development, the difficulty for mine and infrastructure developers will be anticipating when the demand for additional coal production and export capacity is likely to return.

DBCT Management does not believe the trigger point for development can be forecast with any reliability and has avoided doing so in this master plan. DBCT Management instead approaches its master planning obligations with a view to establishing an incremental development pathway that can be activated when real demand is presented and will be underwritten by access agreements. This incremental expansion pathway will be undertaken by DBCT Management if it satisfies the PSA requirement that it is reasonable and economic at the time the demand is converted into an access agreement.

5 DBCT Mtpa Expansion Options

5.1 Development Objectives for DBCT

DBCTM's development objectives for DBCT are to:

- develop Master Plans that define strategies to ensure efficient and secure long-term operation of the DBCT facility to meet the needs of the existing terminal Users and Access Seekers;
- develop an expansion pathway that is consistent with the Sustainable Ports Development Act and Reef 2050 Long Term Sustainability Plan by promoting the incremental development of the existing facility to efficiently satisfy the growth needs of the coal industry;
- continue to build an alliance with all coal chain stakeholders in order to achieve mutually beneficial enhancements for the operation of the coal chain, including an equitable sharing of the costs and benefits of system improvements;
- conduct the core business functions (treasury, financing, customer relations, regulatory relations, contracts management, etc.), while outsourcing technical and operating functions, to ensure that the DBCT facility continues to be managed, operated and maintained at a standard consistent with the obligations set out in the PSA;
- realise additional terminal capacity through improved process efficiency at the terminal and within the Goonyella coal chain;
- support community involvement and engage in ongoing meaningful stakeholder consultation; and
- ensure a continued 'leading practice' approach to port/terminal planning within the coastal zone, particularly within the GBRWHA.

DBCTM uses the following key drivers to guide the ongoing planning for expansions at DBCT:

- system capacity yield
- cost effectiveness
- lowest whole of life costs (maintainability, operational flexibility etc.)
- minimising operational loss of capacity during construction
- minimisation of environmental impacts
- integration with existing infrastructure
- providing an efficient incremental expansion pathway to maximise the potential of existing infrastructure and match the anticipated incremental growth of the coal chain
- realisation of terminal capacity against User contracted requirements and
- future upgrade/optimisation potential.

Any terminal expansion is integrally linked to other supply chain infrastructure which has been illustrated in previous DBCTM Master Plans. DBCTM has been working closely with the ILC to match infrastructure expansions with the other system components to provide for the efficient use of infrastructure and ensure capacity expectations are met and delivered across

the system.

DBCTM has a PSA obligation to accommodate the actual and reasonably anticipated future growth of demand for the use of DBCT by Access Holders and Access Seekers, as well as a regulatory obligation to address and accommodate Access Applications, subject to a reasonableness test. DBCTM has been working to develop expansion options that will address these obligations.

5.2 Expansion Studies

5.2.1 Recap of Master Plan 2009

Master Plan 2009 identified expansion options to take the Terminal to a capacity of 153Mtpa. These options involved major developments and were conceived in response to high levels of demand from existing Users of DBCT. The expansion options that were presented in Master Plan 2009 are summarised in Table 4 below.

Stage	Description	Capacity (Mtpa)
8X	Vertical concrete walls on bunds 1 & 3, reconfiguration and increased stacker ST2 capacity	88
9X Phase A	Additional stockyard south of the existing rail loop, additional inloading system (IL4), additional outloading System (OL4), new shiploader (SL4) on existing berth 4, 2 additional stackers and 3 additional reclaimers	111
9X Phase B	Southern stockyard extension, additional inloading system (IL5), additional outloading system (OL5), additional berths 5 & 6, 2 additional stackers and 1 additional reclaimer	153

Table 4: DBCT Expansion pathway summary - MP 2009

At the time of writing Master Plan 2009, it was DBCTM’s view that the existing terminal footprint could accommodate a maximum capacity of 88Mtpa. With the introduction of the Hybrid operating mode (described in chapter three of this Master Plan) Terminal Capacity Modelling has indicated that the existing footprint can accommodate terminal capacity up to 102 Mtpa. The terminal only requires an additional stockyard development if terminal capacity is to exceed 102 Mtpa.

In 2009, the preferred location for the new stockyard required in the “9X” Stage was south of the existing rail loop in a location described at the time as the Southern Stockpile location. The preference for the Southern stockpile was driven by two factors. The first factor was the need for a substantially sized stockpiling area to accommodate the ultimate indicated demand; and second, the industry’s desire for a significantly higher stockpile storage ratio than currently exists at DBCT. With the adoption of the Hybrid operating methodology, the general industry desire for such a large storage ratio has diminished. It is now widely accepted that a smaller supplementary stockyard can accommodate a higher level of throughput. Without the need for the very large supplementary stockyard, the preferred stockyard location

naturally changes.

The site identified in the 2009 Master Plan as the Louisa Creek site is adequate to support the foreseeable future expansion demand, while also providing significant economic advantages over the other proposed sites:

- the Southern Stockpile
- Dudgeon Point

These economic advantages exist as a result of the proximity of the Louisa Creek site to the existing infrastructure.

5.3 Recommencement of Expansion Studies in 2014

In 2014 the declining price of coal was already impacting the decision making process of the coal industry, resulting in the deferral of several new greenfield mining projects. The deferral of these mining projects caused diminishing interest in major port expansions such as Dudgeon Point, additional terminals at Abbot Point and Wiggins Island Phase 2. At the same time as interest in expansion was waning, volumes were hitting historic highs, causing renewed interest in staged and incremental expansion of existing facilities, including DBCT. DBCTM recognised that once demand for expansion started to recover, it was likely to be measured and incremental, and, at least for the short to medium term, would not support the massive developments previously contemplated.

It was recognised that a number of other external factors favoured the incremental development of DBCT at the time. These included;

- The QLD Ports Strategy (now superseded by new *Sustainable Ports Development Act, 2015*), which was published in November 2013 in response to UNESCO's position on the protection of the Great Barrier Reef. This strategy clearly focused future development of coal export facilities on incremental expansions of existing facilities within the Priority Port Development Areas of Gladstone, Hay Point and Abbot Point
- A further expansion of DBCT is a cost competitive solution for northern and central Bowen Basin mines, notwithstanding the spare capacity reportedly available at Wiggins Island and Abbot Point. DBCT's cost advantage exists due to its proximity and relatively lower total freight cost.
- An incremental expansion of DBCT requires an order of magnitude less dredging than large greenfield projects such as Dudgeon Point. Berth dredging quantities needed to support an expansion of DBCT are small enough to be accommodated within relatively small areas of onshore reclamation adjacent to DBCT.

Against this backdrop, DBCTM sought advice from Access Seekers and asked them to confirm or cancel existing Access Requests in June 2014. Confirmed Access Requests aggregated to more than 99.57 Mtpa above DBCT's already contracted capacity. In November 2014, DBCTM's board approved the commencement of feasibility studies to determine the most cost effective, incremental development pathway for DBCT.

The study has identified a development pathway that involves expansion in three main stages namely Zone 4, 8X and 9X. A greater level of feasibility study has been undertaken for the Zone 4 project than for the 8X and 9X. More detailed studies for these latter projects will be undertaken if demand indicates that expansion beyond Zone 4 is likely to be required.

A Major Development Plan will be prepared detailing the preferred proposal and submitted

to DBCT Holdings for approval in the event that Access Agreements requiring an expansion are received by DBCTM.

The proposed expansion pathway is summarised in Table 5 below;

Stage		Description	Capacity (Mtpa)
Zone 4		Completion of Row 8, additional elevated stacker bund and additional Stacker (Bund 7/ST5), replacement of existing Reclaimer RL2 with new Reclaimer RL4 with extended reach into Row 8.	89
8X	Phase 1	Stockyard Augmentation Project (including vertical concrete walls on existing bunds 1 and 3), Stacker ST2 upgrade, Stacker ST1 upgrade and an upgrade of Conveyors R1 & R2	94
	Phase 2	Rail Reveal Pit 4, Inloading Buffer Storage, Upgrade to Inloading 2 and Outloading 2	102
9X (Implemented over 3 phases)		Additional Stockyard at Louisa Ck, Upgrades to Inloading 1, additional Outloading System 4 and up to 2 berths to the north, including significant land reclamation to accommodate dredge spoil	Up to 136

Table 5: Proposed expansion pathway

5.4 System Capacity Modelling

DBCTM engaged the ILC to model various expansion scenarios before finalising the scope for the Zone 4 project. The ILC first established the pre-expansion capacity of the Goonyella System and then modelled the final configuration of the Zone 4 project. To establish the pre-expansion capacity, the ILC started with the Evidence Based Starting Case (EBSC) in its MP2013. The ILC then incorporated the model input updates and system improvements identified in MP2013 and subsequently implemented. These improvements resulted in a Pre-Zone 4 capacity of 83.8Mtpa (Pre-Z4UP). The modelled system capacity post Zone 4 determined by the ILC model is 89.2Mtpa.

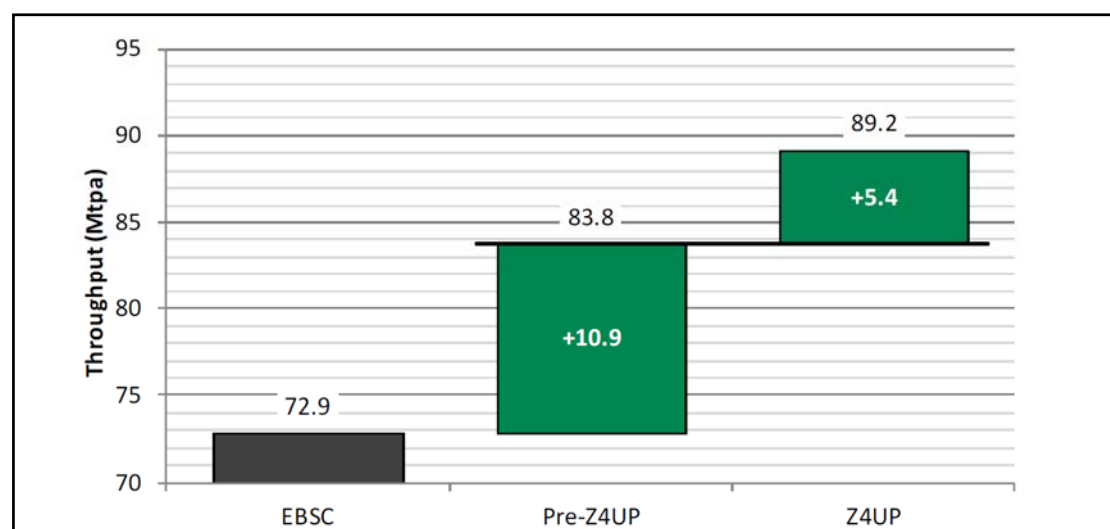

Figure 27: Zone 4 capacity modelling

Given that the sources of expansion tonnes within the Goonyella network are unknown, the model was used to test the sensitivity of the result to various mine locations within the network. Five separate ‘assumed’ mine locations were tested from various locations within the network. In each case, it was assumed that the additional 4Mtpa (from 85 to 89 Mtpa) would be sourced from a location on each of the following branch lines

- North Goonyella branch
- Blair Athol branch
- Dysart branch (northern end)
- Dysart branch (southern end)
- Hail Creek branch

The worst modelled capacity result achieved for any of the scenarios was 89.2Mtpa with some mine locations producing slightly better results.

As a result of manpower limitations within the ILC’s modelling team in early 2015, DBCTM engaged Ausenco in parallel to the work being undertaken by the ILC on the Zone 4 project, to undertake system capacity modelling to assist with scenario testing for 8X and 9X concept development. Ausenco has had a long association with DBCT and modelling DBCT capacity, both in isolation and within the context of the entire coal chain. Ausenco first modelled the existing system, followed by the Zone 4 expansion. After Ausenco’s model was producing modelling results broadly consistent with the ILC’s modelling, Ausenco’s work was extended to include various 8X and 9X scenarios.

The capacity assessments for the 8X and 9X concepts included in this Master Plan have been independently estimated by Aurecon Hatch. Aurecon Hatch initially estimated capacities using static modelling. DBCTM and Aurecon then tested capacities using Ausenco’s dynamic capacity modelling, which were ultimately considered sufficiently robust for concept level studies. Prior to progressing further with 8X and 9X studies, DBCTM intends to engage the ILC to verify the results using the new dynamic system capacity model currently under development.

5.5 Expansion Pathway

5.5.1 Zone 4

The proposed Zone 4 Project involves expansion of the existing stockyard row 8 to enable both rows 7 and 8 to operate together as a 4th operating zone. The 4th zone would be utilised for storage of remnants and selected high-throughput coal types in dedicated stockpiles.

The project includes the following key components:

- Extension of Row 8 and the provision of a vertical walled bund (Bund 7) on the western side of the stockyard.
- Relocation of the hybrid operation (currently in use throughout the yard) with storage of selected high-volume products in dedicated piles in Zone 4 and another in a dedicated pile in Zone 2
- Provision of an independent stacking path to Row 8 via the new Bund 7 and a new Stacker ST5 to improve the availability of the Zone 4 reclaim machines to attend to reclaim tasks

- The replacement of the existing Reclaimer RL2 with a new Reclaimer with different geometry and a longer boom to ensure that it can reach all coal stored in Row 8 after the expansion
- The relocation of the exiting Western Site Access Gate and the Western Access Road.

The above aspects of the Zone 4 Project are illustrated in Figure 28 below.



Figure 28: Extent of Works for Zone 4

The Zone 4 project delivers an increase in stockyard storage capacity and some minor improvements in stacking and reclaiming efficiency. Prior to Zone 4, simulation modelling undertaken by ILCO indicates that the existing Goonyella System capacity is constrained to approximately 83.8 Mtpa, notwithstanding the stand-alone nameplate capacity of DBCT of 85Mtpa. The Zone 4 Project closes the gap between Goonyella system capacity and nameplate DBCT capacity while at the same time increasing overall system capacity to 89Mtpa.

The proposed increase in the DBCT stockyard storage volume is to be achieved by an increase in width and length of row 8. The upgraded row 8 will feature a high retaining wall on the western side to allow greater storage efficiency than has been achieved in any other existing walled row.

The increase in stockyard volume will improve capacity by allowing the coal to be simultaneously assembled from a larger number mines at any point in time. Based on simulation modelling carried out by the ILC, this yields a benefit as it reduces some of the peaking congestion at points in the network by allowing the system to spread the load among more mine load outs.

The increased stockyard volume also facilitates an important change to the efficiency of the hybrid stockyard mode that was first introduced in the ‘Pre-Zone 4’ upgrade project. The introduction of the hybrid mode involves a change in the operation of the 7X stockyard away from the previous 100% cargo assembly strategy. The ‘hybrid’ mode introduces dedicated storage areas which are utilised within the cargo assembly zones for three (3) selected high throughput coal brands.

In the context of the Zone 4 expansion project, the increased volume in Row 8 allows two of these dedicated product stockpiles to be moved out of the cargo assembly zones and into rows 7 and 8, together with the remnant piles. This allows rows 7 and 8 to be treated as a 4th stockyard Zone that will handle the two dedicated high-

throughput coal brands as well as all of the remnants. The products in the Zone 4 dedicated piles are then not required to be handled via any of the other three cargo assembly zones or outloading systems. This throughput can then be proportioned across the 3 outloading systems in a way that allows Zone 4 to act as an extension, at various times, of each of the other three zones.

The effective storage ratio for the cargo assembly portion of throughput is increased and the increase in storage ratio is distributed more evenly across the stockyard zones than can be achieved prior to the Zone 4 project.

Minor improvements in overall stacking and reclaiming performance are also achieved in the Zone 4 project via:

- Replacement of the existing RL2 reclaimer with a longer boom RL4 reclaimer that will achieve higher average reclaim rates due to operating in wider stockpiles.
- Addition of a new high capacity stacker ST5 to facilitate independent stacking into row 8 without disrupting reclaim operations.

These equipment improvements contribute to the overall throughput capacity gain that will be achieved as a result of the Zone 4 project.

The modelling results indicate that the Goonyella System Capacity increases from 83.8 to 89Mtpa as a result of the Zone 4 project. Since the Zone 4 project releases system capacity between the currently modelled system capacity of 83.8Mtpa and the currently contracted 85Mtpa, the project will benefit the existing users contracted to the terminal and also provide Access Seekers with 4Mtpa of new capacity beyond 85Mtpa.

The stockpile areas are proposed to be utilised as shown below (Figure 29).

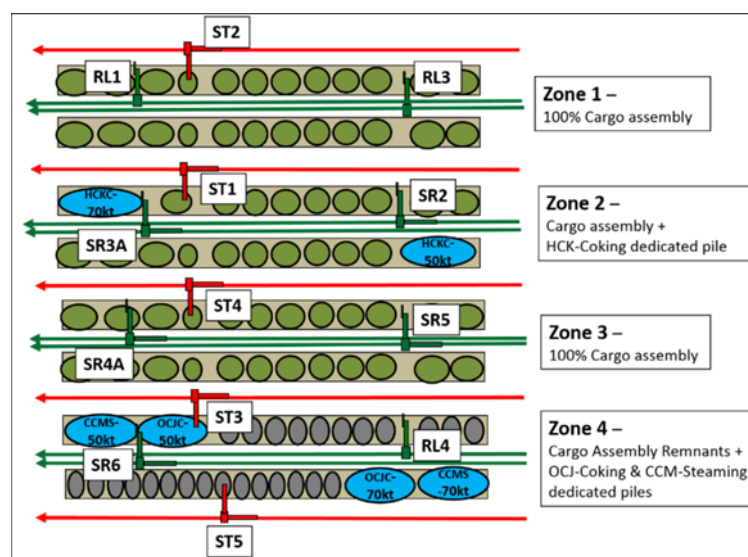

Figure 29: DBCT Stockyard following Zone 4 expansion

Use of the Zones can be described as follows:

- Zone 1 – This zone remains as a cargo assembly zone.
- Zone 2 – This zone remains largely as a cargo assembly zone but will also accommodate two dedicated stockpiles with total 120kt capacity for a high throughput coking coal (shown in blue). This is expected to handle the majority

of the total throughput of this coal type.

- Zone 3 – This Zone remains a cargo assembly zone.
- Zone 4 – This zone, including Rows 7 and 8, was previously used only as a storage area for dedicated remnant stockpiles associated with the cargo assembly operation. With extension of Row 8, this zone will now also accommodate 2 new dedicated stockpiles for each of two high throughput coal types
- The use of the dedicated stockpiles allows cargoes destined for several vessels to be stacked together without separation between piles, meaning that overall these cargoes consume much less stockyard area. This leaves more space for storage of other lower throughput coals that remain in separate cargo assembly stockpiles.

The Row 8 development within the Zone 4 project achieves a higher storage volume potential in Row 8 in comparison to other existing walled rows on the site. This occurs because of the increased height of the wall on the western side of Row 8 in comparison to the wall height on other rows at DBCT. This benefit is able to be utilised by the new large dedicated storage piles where significant length savings are achieved. Savings in stockpile length for the smaller remnant piles are also possible, however the benefit is not as great as for the larger, dedicated piles. Further volume benefits are also achieved in Row 8, because being the western most stockyard row, there is no requirement for cross drains in Row 8 and no lost stockpile space given the absence of these drains.

5.5.1.1 Indicative cost of the Zone 4 project

A Capital Costs estimate has been compiled for Zone 4. Direct and Indirect costs have generally been compiled in detail with Material Take-offs (MTO's) produced by engineering and applied to detailed unit rates. The estimate has been prepared using CCS Candy software - an analytical, resource-based estimating system.

During the study, budget pricing was sought for approximately 75% of the Direct Costs which have been included as the basis for the stacker, reclaimer, civil construction, structural steel supply and fabrication and mechanical supply estimates.

Contingency has been included in the Capital Estimate following a Quantitative Risk Analysis (QRA) at P90 confidence. Estimate accuracy has been evaluated at approximately -15% to +20% at 90% confidence intervals.

Description	AU \$M
Direct Costs:	
Inloading	15.3
Stockyard	101.4
Yard machines	66.1
Site wide facilities	27.8
Indirect Costs	63.3
Contingency P90	82.2
Total AU\$M	356.1

Table 6: Cost breakdown for Zone 4 Expansion

Contingency has been established in the QRA process which ranged components of the estimate at a summarised level. The resulting estimate at a P50 confidence level is \$308.8M with a contingency of \$34.9M. The range around this is between \$268.7 (P10) and \$356.1M (P90).

The estimate base date is June 2015 with no allowance for forward escalation

5.5.1.2 Regulatory Approvals for Pathway

Relevant State approvals have been gained for this pathway, namely:

- DBCTPL as the terminal operator, holding an existing Environmental Authority ('EA') (Permit EPPR00504513), granted on 19 October, 2015 and authorising the undertaking of ERA 50 (Bulk Material Handling up to 89Mtpa which includes the proposed expansion included in the Zone 4 pathway) and ERA 63 (Sewage Treatment (more than 100 but less than 1500 Equivalent Persons design capacity)); and
- DBCTM as terminal owner, hold an existing EA, granted on 27 April 2015, which authorises the undertaking of ERA 16 – Extractive Activities (extracting and screening, other than dredging of more than 100,000t but not more than 1,000,000t in a year) across the DBCT terminal site (Permit EPPR02825115). The EA authorises the undertaking of blasting as part of the extractive activities.

These Environmental Authorities have been issued by the Queensland Department of Environment & Heritage Protection ('DEHP') and cover the full extent of Expansion Pathway 1 (Zone 4) up to the terminal capacity of 89Mtpa.

A formal referral was also made for the Zone 4 project under the *Environment Protection & Biodiversity Conservation Act, 1999* ('EPBC Act') (Ref: 2015/7541). On 12 September 2015, the Commonwealth advised that the Zone 4 project was deemed to be a 'Non-Controlled Action' and no approval under the *EPBC Act* would be required.

On 15 December 2015, NQBP issued a conditional Port Development Approval under the Port of Hay Point Land Use Plan (approved under the *TI Act*), relating to the full extent of Zone 4 works.

5.5.2 8X Project

As previously mentioned, the expansion pathway beyond Zone 4 remains at early concept level only. The 8X and 9X project scopes outlined herein are subject to change as engineering progresses to pre-feasibility and then to feasibility level.

The proposed 8X project is made up of a series of minor upgrades to the existing machines, systems and infrastructure and the effective replacement of one of the existing inloading systems with a higher capacity system. Because of the building block nature of the project it can easily be implemented in phases. Two main phases have been identified as per Table 7.

8X – Phase 1								
Expansion element	Capex	Estimated Inloading capacity		Estimated Outloading capacity		Adjusted Outloading capacity for storage ratio @ 2.2%	Resultant capacity	
		M\$	(tpa)	Cap increment	(tpa)		Cap increment	(tpa)
Zone 4 (baseline)	N/A	89.8	N/A	90.7	N/A	90.8	89.8	N/A
ST1 and ST2 upgrades	50.62	93.0	3.2	90.7	0	90.8	90.7	0.9
Stockpile Augmentation Project (SAP) + R2/RL3 Zone Swap - Zone 1 to OL3, Zone 3 to OL2	135.8	93.0	N/A	93.0	2.3	93.0	93.0	2.3
TOTAL Phase 1	185.6	93	3.2	93	2.3	93	93	3.2

Table 7: 8X Project Phase 1 Summary

8X - Phase 2								
Add IL4 to stackers, Upgrade IL2 and Shut down IL1	253.6	100.6	7.6	93.0	0	93.0	93.0	0
OL2 Upgrade	9.6	100.6	0	93.9	0.9	93.9	93.9	0.9
Inload buffer storage	201.3	101.4	0.8	101.3	7.4	99.9	99.9	6.0
TOTAL Phase 2	473	101.4	8.4	101.3	8.3	99.9	99.9	6.9
TOTAL 8X	650.9	101.4	11.6	101.3	10.6	99.9	99.9	10.1

Table 8: 8x – Phase 2

8X – Alternative Phase 2 (if allow storage ratio to fall to 2.15%)								
Add IL4 to stackers, Upgrade IL2 and Shut down IL1	253.6	100.6	7.6	93.0	0	93.0	93.0	0
OL2 Upgrade	9.6	100.6	0	93.9	0.9	93.9	93.9	0.9
Inload buffer storage	201.3	101.4	0.8	101.3	7.4	101.3	101.3	7.4
TOTAL Phase 2	473	101.4	8.4	101.3	8.3	101.3	101.3	8.3
TOTAL 8X	650.9	101.4	11.6	101.3	10.6	101.3	101.3	11.5

Table 9: 8X Project Phase 2 Summary

5.6 Stackers ST1 and ST2 Upgrade

Inloading system No. 3 has a rate of 8,100 tph but is limited to lower rates of 6,000 tph and 5,500 tph when used to stack via ST2 and ST1 respectively. The upgrade of these stackers and the associated yard conveyors is proposed as a potential 8X project as indicated in Figure 30.

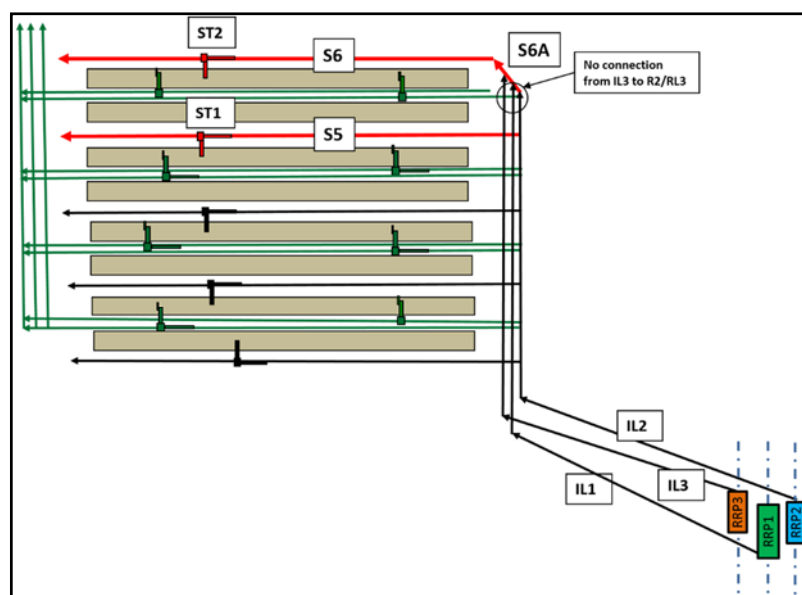

Figure 30- ST1 and ST2 Upgrade – Conveyors S6, S6A and S5 also require upgrade

In the case of ST2, a rate of 8,100 tph capacity can be achieved with only conveyor speed increases for conveyor S6A, S6 and the ST2 boom conveyor. The ST2 stacker upgrade has been separately studied within an earlier 8X study completed by Aurecon Hatch in 2009.

In the case of ST1, a replacement of this machine with new ST1A stacker is possible prior to the commitment of 8X due to the age and condition of the existing ST1 machine. The ST1 stacker replacement options have also been studied separately by Aurecon Hatch as reported in the document H348252-500000-100-066-0004, “Stacker ST1 Replacement Study, Feasibility Report”, March 2015. Replacement with a larger capacity machine is proposed. If the machine is not replaced before 8X is required, ST1 will need to be replaced to achieve the higher stacking rate of 8100tph. The new machine will require a 2000mm boom conveyor.

The associated S5 yard conveyor can be upgraded to 8,100 tph by fitting a 1,800 mm belt to the existing stringers and operating it at 6.6 m/s. Alternatively, a slightly lower capacity of 7,500 tph could be adopted if the current maximum conveyor speed of 6.2 m/s for the site was observed. A parallel 2,000 mm wide yard conveyor could also be constructed to achieve the target 8,100 tph with slower belt speeds.

5.7 Stockpile Augmentation Project (SAP)

The Stockyard Augmentation Project (SAP) is the only potential 8X project that will deliver an increase in stockyard storage volume. It is important to maintain a storage ratio sufficient to allow a larger number of stockpiles to be accommodated. Additional stockpiles allow cargos to be simultaneously drawn from a larger number of mines at any given time. This avoids potential delays in the rail operation that would otherwise occur due to constraints in the rate at which trains can be loaded at the mine loadouts.

The key elements of the SAP project are highlighted in Figure 31 and are summarised as:

- Addition of concrete walls to Bund 1 and Bund 3 to improve storage volume in Rows 1, 2 and 3. The constructed walls allow wider piles to be stacked against the walls, similar to those developed for Bunds 4A and 5A during the 7X Expansion. This will also improve the average reclaim rates on machines RL1, RL3, SR2 and SR3A. Volume

improvements are approximately 20 to 30% greater, depending upon the mix of parcel sizes utilising this space. Larger parcel sizes lead to a larger percentage change.

- Upgrade of R2 conveyor to allow RL3 to be reset at its full reclaim rate potential (from 4200tph to 5300tph).
- A potential 'Zone swap' involving an alternative allocation of stockyard zones to outloading systems to better align the high volume, highest reclaim rate Zone 1 with the highest performing outloading system OL3.

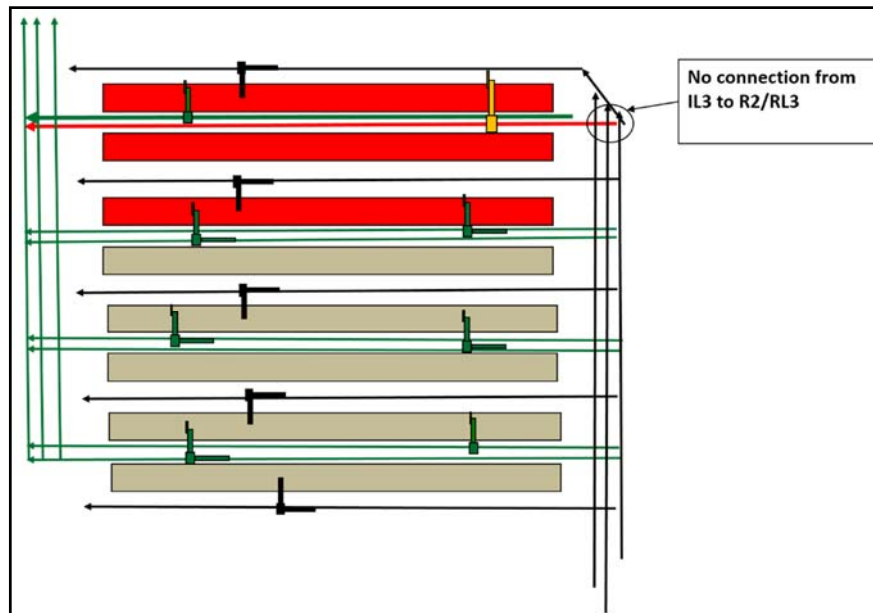

Figure 31: Schematic indicating scope of SAP project including upgrade of the RL3 yard machine and conveyor R2.

The proposed allocation of stockyard zones to outloading systems following the SAP project are shown in Figure 32.

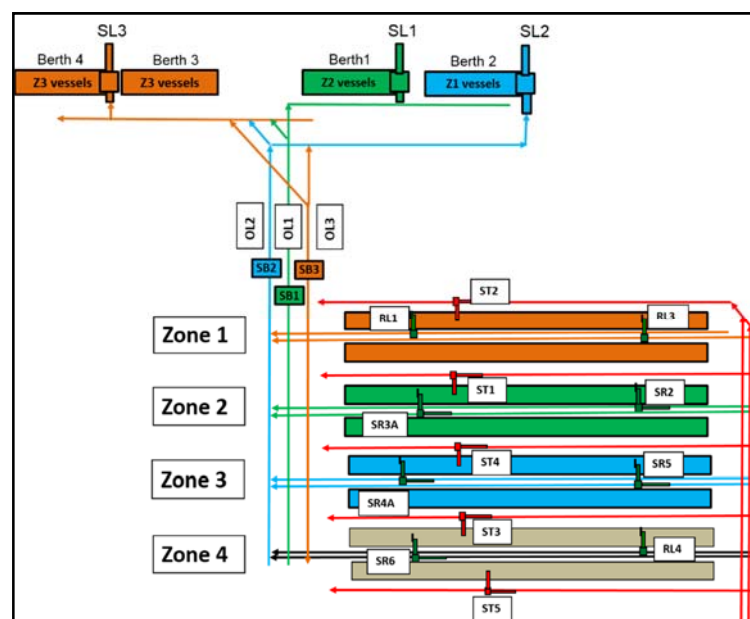

Figure 32: Proposed re-allocation of stockyard zones to OL systems following the SAP project

Given that the SAP project will tend to draw increased capacity towards rows 2 and 3 and

considering ST1 is already heavily utilised, it is likely that the ST1 upgrade would have a larger impact following completion of the SAP project.

5.8 New IL4 and IL2 upgrade

The upgrade of the existing IL1 and IL2 systems from 5,500 tph to 8,100 tph would be expected to achieve a significant boost to inloading capacity. Such an upgrade would require substantial modifications to the two rail receival pits RRP1 and RRP2 and the associated conveyors. These upgrades have been previously investigated by Aurecon Hatch. The findings are documented in the report: H79920CMP03-01, "Dalrymple Bay Coal Terminal, MP03 Concept Study, Upgrade of Inloading Systems 1 and 2", June 2005. The upgrade of the RRP1 pit was separately investigated by DBCTM around the same time.

It is technically feasible to upgrade these systems, however the shutdown durations to complete the works is prohibitive. RRP2 would need to be shut down for approximately 6 months and RRP1 would likely need to be shutdown for considerably longer. The RRP1 pit would require extensive modifications to the receival hoppers and feeder system, as well as the conveyor systems. To complete both upgrades before building a 4th system would reduce the terminal capacity to around 60Mtpa for more than a year.

A new high capacity 4th inloading system (similar to inloading 3 developed in 7X) could be built to replace one of the existing inloading systems to provide a capacity improvement. This option would allow for the existing systems to be upgraded without capacity loss because the capacity is replaced before the losses are incurred. The upgrade of RRP2 is feasible by replacing the existing 1600mm belts with wider 1,800 mm belts operating at a maximum speed of approximately 6.4 m/s to minimise dust lift-off. The IL2 upgrade would only be carried out once the new IL4 was commissioned.

It is envisaged that the IL1 system would not be upgraded in 8X and would be decommissioned after IL2 is returned to service. IL1 would need to be upgraded and returned to service for the 9X project.

The terminal will only have 3 operating inloading systems at the completion of the 8X project, removing the need to develop a 4th rail loop as part of 8X.

Considering the approaches described above, a potential sequence for upgrade of inloading systems during the 8X expansion and progressing to the potential future 9X development is described in Figure 33 and Figure 34.

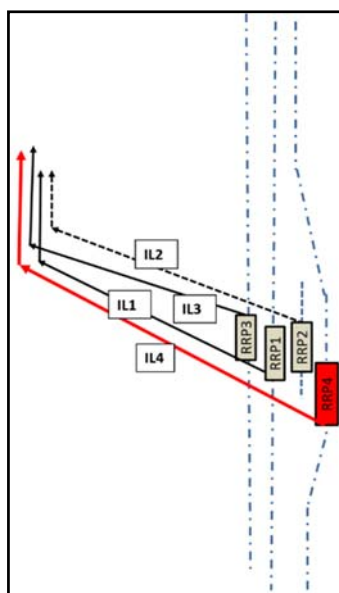

Figure 33: IL system upgrade – Step 1- Establish new IL4 and RRP4, relocate existing RRP2 loop to service the new RRP4 and shut-down RRP2 and IL2 for refurbishment.

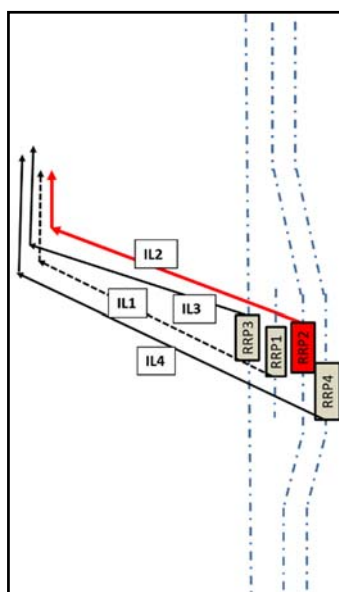

Figure 34: IL system upgrade – Step 2 – Re-commission upgraded RRP2 and IL2, relocate RRP1 loop track to service RRP2, shut down RRP1 and IL1. IL1 would likely remain shut-down until the future 9X expansion phase.

With an objective to avoid the use of S/R's for stacking and to include upgrade options that achieve this end, it is proposed to connect the new IL4 system only to the stacking lines in the yard and not to the reclaim conveyors. It is acknowledged that this strategy will prevent throughloading from the IL4 system.

5.9 OL2 Upgrade

The rate limitations of the outloading conveyor systems and surge bin capacities contribute to “full bin” events during shiploading. “Full bin” events impose delays on yard machines that would normally be avoided by matching outloading rates to surge bin capacities and reclaim rates.

The potential throughput gains that might be obtained from improved conveying rates

downstream of the surge bin were examined in previous studies completed by Aurecon Hatch:

- H79923CM/MP03-06 – “MP03 Concept Study, Upgrade of Outloading Systems 1 and 2” June 2005
- 319999-8043-M-RE-00001(Rev 3) – Additional Investigations into Upgrade of OL1 and OL2 – Stockyard to Surge Bin

These studies resulted in the upgrade of the conveyors between the stockyard and surge bin as a part of the 7X project completed in 2009. The studies also concluded that further capacity gains were available from upgrade of the OL1 and OL2 conveying systems downstream of the surge bins.

Approximately 1.0 Mtpa was estimated to be available from OL2 and only 0.5Mtpa available from OL1 due to the limitations of the smaller surge bin. That conclusion was based on an outloading rate change from 7,200 tph to 8,650 tph for both systems, whereas the outloading rate for OL2 has already been increased to 7,600 tph (except for the thermal coal brand which runs at 7,400 tph). The further gains are expected to be approximately 0.8Mtpa for OL2.

The cost and operational impact to upgrade OL1 is significantly greater than that of OL2. Upgrading OL1 is not considered viable based on the current level of study and is therefore not included in the 8X Scope.

5.10 Inloading Buffer Storage

This expansion element involves the addition of a short term buffer storage facility within the inloading system. The concept allows trains to unload to the buffer store when there is no stacker machine available and then to discharge to the yard once the required stacker becomes available. This is shown schematically in Figure 35.

The proposal requires a conveying path to be provided between the buffer storage and the stockyard that is independent of the inloading systems. Considering the proposals and sequence for upgrading the inloading systems as described above, an opportunity exists to re-utilise a significant portion of the existing IL1 system that would otherwise be decommissioned. This dictates the sequence for this expansion element because it can only be commissioned after IL4 is built and after IL2 is upgraded.

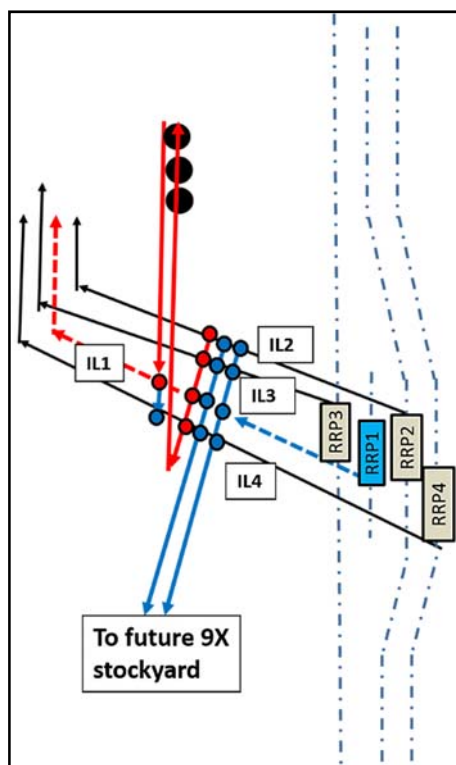

Figure 35: Schematic of inloading buffer system concept. Works required for the buffer storage are shown in red and would follow the RRP2/IL2 upgrade step for the inloading systems upgrade shown in Figure 34. Related works that would be required at the transition to the 9X upgrade when a new stockyard might be established are shown in blue.

Further details of the proposed buffer storage concept are described below:

- The schematic shown in Figure 35 suggests use of silos to provide storage. Silos would likely deliver the highest Capex/lowest Opex solution but other storage means could be used. (e.g. stockyard in shed, bunker etc.).
- Further modelling is required to determine the ideal size and number of the storage modules. The use of 3 X 10,000 t modules to match 10,000 t train size lots has been estimated but a larger number of 5,000 t modules may ultimately be the preferred option.
- The buffer storage should be able to be fed from IL2, IL3 and IL4 through a tripper/diverter chute arrangement.
- The IL1 system between the buffer storage and the yard is proposed to be upgraded to 7,500 tph capability when brought back into operation. It is expected that the ability to discharge a train sized lot back to the yard within the normal train unloading cycle time would be beneficial. Consideration could also be given to retaining the existing IL1 capacity of 5,500 tph.
- Coal brands of different types will be segregated in the buffer storage modules.
- A train would be diverted to the buffer storage whenever there is a conflict for access to stackers that would otherwise have resulted in the use of a Stacker Reclaimer (S/R) for stacking. The SR's should never be used to stack from the rail dump station or the buffer storage except as a last priority, if no other options exist or if the S/R's are not involved in a reclaim task.

- The buffer storage should be emptied back to the yard using stackers only, immediately after the required stacker becomes available and is not being demanded by another train.
- Trains always take priority over the buffer storage for gaining access to stackers. This should be the case even if the buffer storage is part way through a discharge to stackers. An arriving train should interrupt and take the stacker.
- If a train is loading to buffer storage and the stacker becomes available during that time, the remainder of the train should be sent to the stacker. It is recognised that this will drive part use of a given storage cell.

The buffer storage will provide outloading capacity rather than inloading capacity. This capacity is achieved by virtually eliminating the need for the S/R's to prioritise the stacking function over the reclaim function which at completion of Zone 4 limits the capacity of the outloading systems.

5.10.1 Indicative cost of the 8X Project

An indicative capital cost estimate has been prepared for the 8X Project. In summary, the cost estimate for the 2 phases of the project is as follows.

Phase	Capacity (Mtpa)	AU\$M
1. ST1 and ST2 Upgrade, SAP and R2/RL3 Upgrade	4.5	200
2. IL4, OL2 Upgrade, Inloading and Buffer Storage	8.5	500
Total AU\$M	13Mtpa	700

Table 10: 8X indicative cost

This estimate is concept level only and is based on the following:

- Target accuracy in the range -25% to + 35% at 80% confidence intervals.
- The estimate is presented in Australian Dollars with a base date of Jun 2015 with no allowance for forward escalation.

5.10.2 9X Project

The existing footprint at DBCT is limited to the 8X Capacity of 102 Mtpa. Any expansion materially beyond that capacity will require an additional stockyard. Three stockyard locations were identified in Master Plan 2009, and at that time the Southern Stockyard was identified as the preferred location. The preference for the Southern Stockyard at that time was primarily driven by a strong view within the industry that the storage ratio for the existing 85Mtpa was inadequate and needed to be increased before any expansion could be undertaken. The expansion studies undertaken in the lead up to the preparation of Master Plan 2009 assumed a need to provide enough storage in the new stockyard to accommodate the combined tonnage over both stockyards at the higher storage ratio. This effectively meant that a stockyard at Louisa Creek only had the capacity to accommodate the existing 85Mtpa at the higher storage ratio and DBCTM needed a much larger stockyard to accommodate that additional volume, plus the volume required for the expansion tonnes. This meant

that the Louisa Creek Stockyard site was understood to be tonnage constrained.

The work undertaken by the ILC Master Planning group to understand and model the operation of the Goonyella System has revealed that by using the Hybrid Operating mode, DBCT can operate effectively with the existing storage ratio. This new understanding renders the substantial cost involved in expanding the DBCT storage ratio unnecessary. Given the new stockyard only needs to accommodate the expansion tonnes, albeit at a larger storage ratio, the Louisa Creek site is deemed adequate. Given its proximity advantage, the Louisa Creek Site is materially cheaper than the other options.

The 9X development will incorporate the following key elements:

- Reactivation and upgrade of RRP1 dump station that would have been placed into “care and maintenance” mode during the earlier 8X expansions works. The tail section of S1 conveyor will need to be upgraded to operate at 8100tph capacity to deliver the additional train unloading capacity.
- A new fourth (4th) rail loop that would service RRP4 with the existing RRP4 loop re-aligned to RRP2, and RRP2 loop re-aligned to RRP1, as discussed in the 8X development report.
- Provision of link conveyors from the 4 X Rail Receival Pits to feed the new 9X stockyard.
- A stockyard with sufficient storage capacity to match the proposed 35Mtpa capacity expansion, considering the variety of potential operating modes, whilst ensuring that the storage ratio is at least as large as that proposed for the 8X development.
- A new fourth outloading system OL4 including; conveyors, surge bin, sample plant and shiploader SL4 with capacity to match the OL3 system. Suitable link conveyors are also required for connectivity between the new stockyard and the outloading systems.
- Berths 5 and 6 to the north of existing Berth 4 serviced by the new shiploader SL4

At this stage it is not possible to predict how the new stockyard might be utilised within the expanded terminal operations. There are 2 main options for stockyard strategy which require different configurations.

The stockyard could be either:

- Operated as an integrated part of the existing facilities to allow an extension of existing cargo assembly operations. This would suit incremental growth in throughput of the existing coal types combined with the addition of new coal types. All products could be loaded onto vessels in any combination.
- Operated as a stand-alone terminal that would be dedicated to handling a select group of coal types that cannot load onto vessels being loaded from the existing stockyard. This application would tend to be more favourable to higher throughput coals stored in dedicated storage stockpiles.

Considering these two potential operating approaches, a number of configuration options were developed. The options that were found to be viable are summarised on the following page:

5.10.2.1 Configurations for an integrated operation

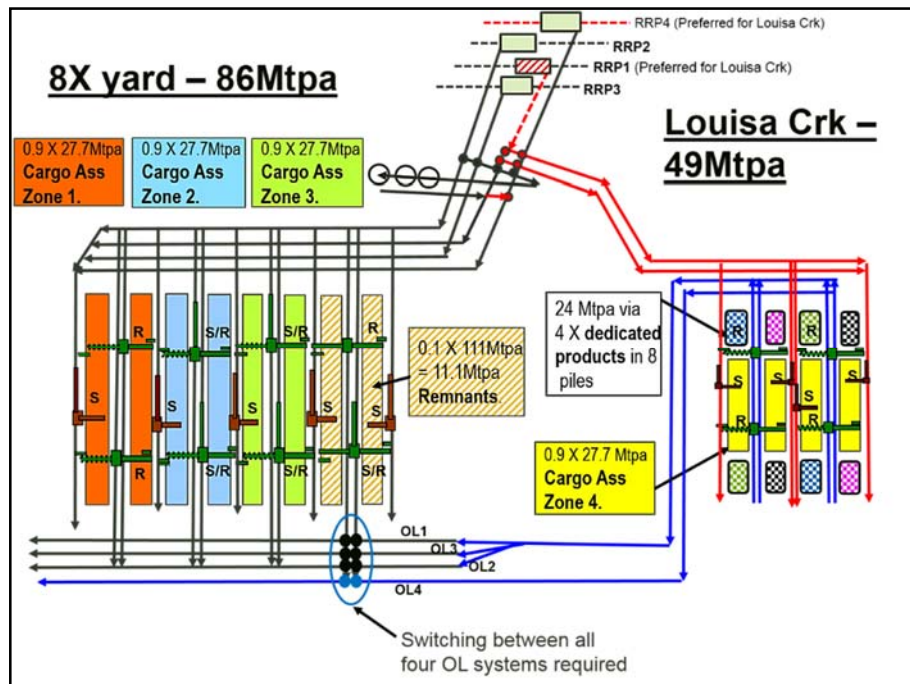

Figure 36: Option 1B – Dedicated product stockpiles moved to Louisa Creek, together with a new cargo assembly zone. Removal of dedicated piles from the existing stockyard results in a capacity loss from the existing yard. Capacity of the Louisa Creek yard is increased to compensate and exports via the OL1, OL2 and OL3 systems as well as OL4

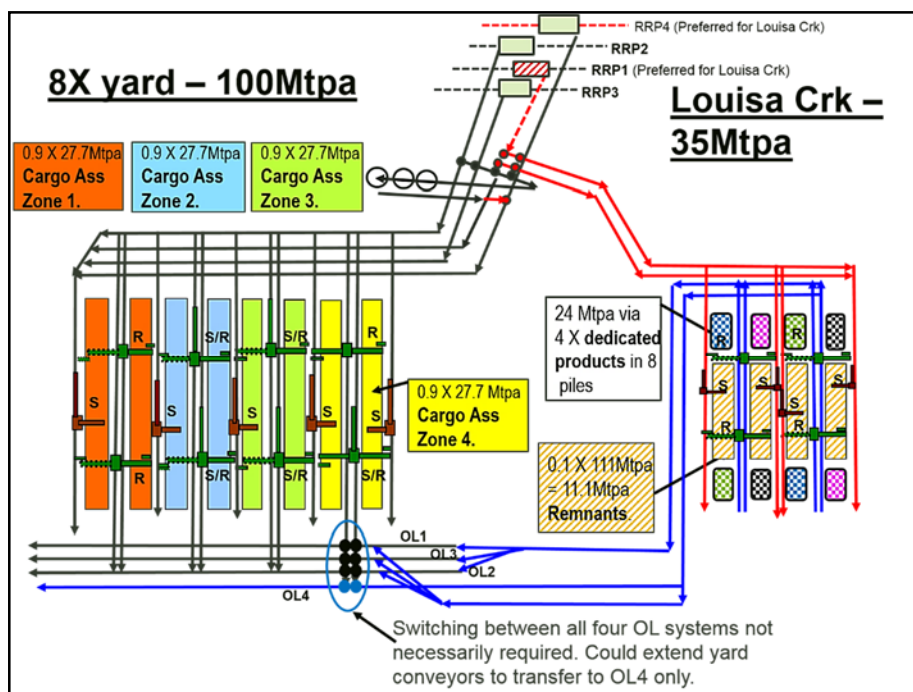

Figure 37: Option 1C – Integrated terminal with dedicated stockpiles and remnants relocated to Louisa Creek. New 4th cargo assembly zone established in Rows 7 and 8.

5.10.2.2 Configuration for stand-alone operation

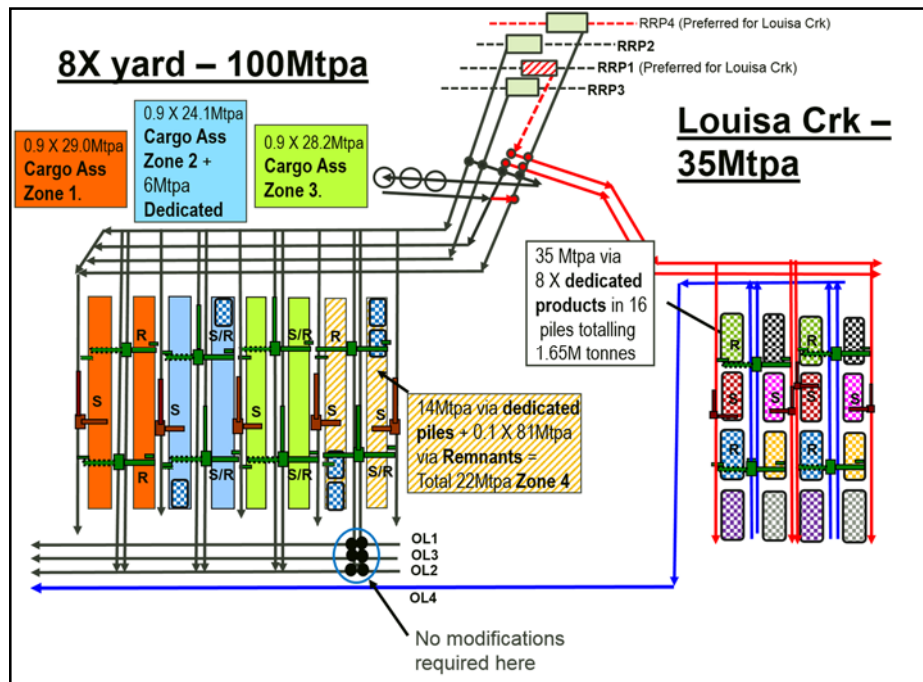

Figure 38: Option 2 – Virtual stand-alone terminal at Louisa Creek for dedicated product stockpiles. Some dedicated stockpiles must be maintained within the 8X yard to retain throughput capacity. Products at Louisa Creek cannot be loaded to vessels with products in the existing yard.

5.10.2.3 Configuration for partially integrated operation

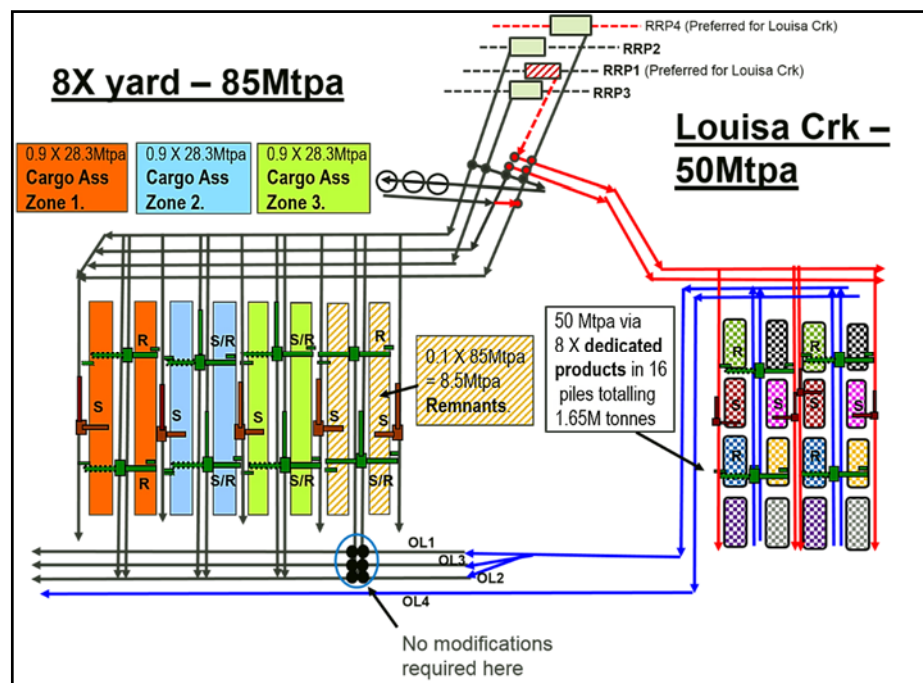

Figure 39: Option 3 – Partially integrated dedicated stockyard at Louisa Creek. This allows dedicated product stockpiles in the 8X yard to be relocated to Louisa Creek and for products stored at Louisa Creek to be loaded to vessels with cargo assembly products stored within the 8X yard (to a limited extent dictated by available capacity in OL1, OL2 & OL3).

5.10.2.4 Offshore configuration

Only one feasible option is envisaged for the 9X expansion of the offshore works which can be developed in 2 stages.

It is proposed that the new OL4 outloading string would load to vessels via a new shiploader SL4 that would operate on new Berths 5 and 6 proposed to be constructed to the north of the existing berths as shown schematically in the figure below:

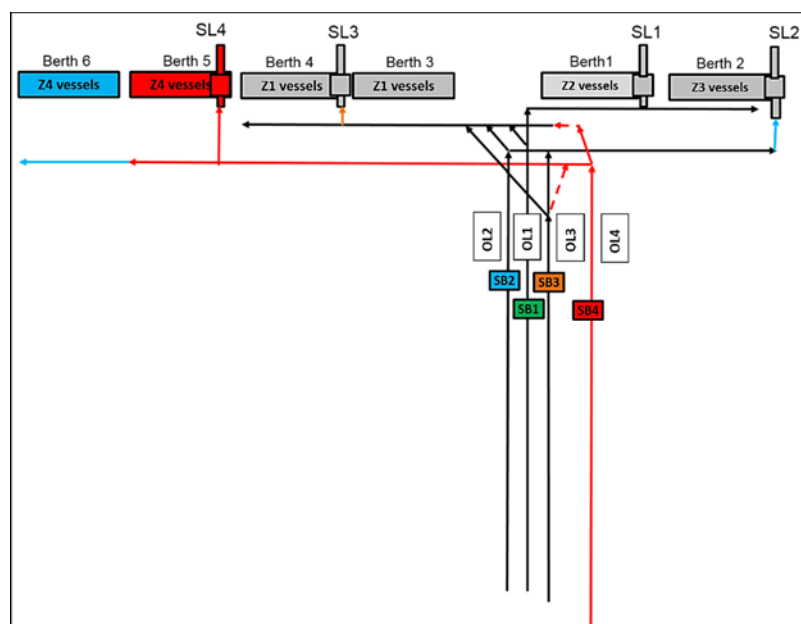

Figure 40: Proposed development of offshore facilities for the 9X project. Berths 5 and 6 and Shiploader 4 are added. The 4th shiploader and outloading system may be dedicated to the new Louisa Creek stockyard or alternatively might be associated with the added 4th cargo assembly zone depending upon the chosen operating mode and chosen stockyard configuration as discussed in the sections above.

5.10.2.5 Physical arrangements for stockyards and conveyors

Stockyard layouts have been prepared to demonstrate how the configuration options could be accommodated within the Louisa Creek site.

Two potential site arrangements have been prepared including a 'short' and 'long' stockyard option as shown in the figures below.

In general, configuration options 1B and 1C (integrated DBCT and Louisa Creek operation) would suit the 'short' stockyard arrangement based on current assumptions regarding throughput associated with dedicated product stockpiles. Options 2 and 3 (standalone terminal operation at Louisa Creek) would suit the 'long' stockyard arrangement.

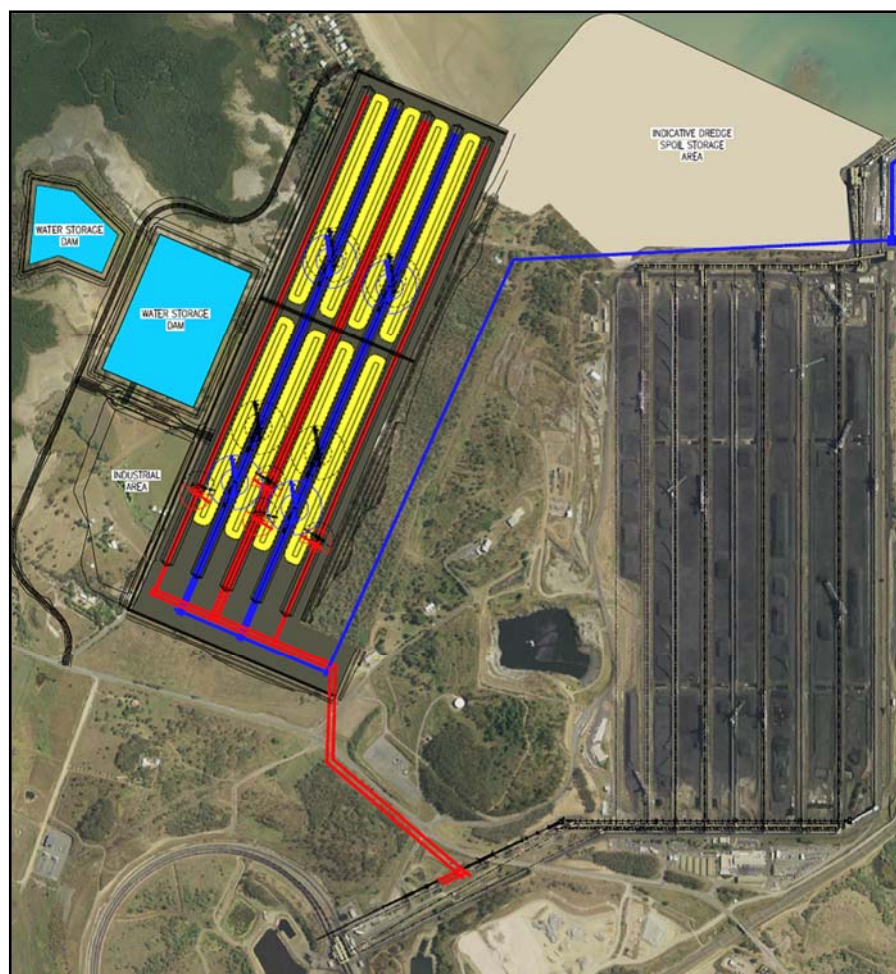

Figure 41: 'Long' stockyard arrangement suited to configuration options 2 and 3.

The arrangements are such that the short stockyard arrangement could be extended in the future to match the long stockyard arrangement if deemed necessary.

As described in the captions to the above figures, the outloading conveyor arrangements need to be varied according to the required level of integration between the Louisa Creek stockyard and the existing DBCT stockyard, and the way in which the Louisa Creek stockyard will be utilised.

In particular, the single outloading conveyor string shown for the 'long' stockyard is suitable only for Option 2 which suits the case of Louisa Creek being developed as a virtual stand-alone terminal, assuming that 8X operations continue unchanged within the existing stockyard. Any other case will require some additional outloading conveyors to be constructed to some extent.

The short stockyard arrangement provides the benefit that the stockyard could be constructed without encroaching upon the Louisa Creek beach and with less impact upon the existing township. It is noted that if a dredge spoil reclamation area is developed in the location shown above, for storage of dredged material associated with the development of Berth 5 or both Berths 5 and 6 together, then the benefits of avoiding encroachment of the beach may be limited.

5.11 Rail Infrastructure

The rail track infrastructure in the vicinity of the terminal does not form part of the asset owned and managed by DBCTM. The current rail track arrangements have are understood to contribute to delays in the process of directing full trains to dump stations. Delays have also been observed in clearing empty trains from the loop after unloading to allow uninterrupted unloading of subsequent trains.

It has been identified that some relatively minor rail track improvements would likely address these issues and provide a throughput gain.

Potential modifications that would be expected to avoid train delays and improve utilisation of the dump stations are depicted schematically in red in Figure 42 below. It is proposed that these improvements would be carried out at the time of establishing the 4th dump station during the 8X phase i.e. when RRP4 is fed from a diverted loop 2 and prior to establishment of the 4th rail loop.

The green lines in Figure 42 indicate the proposed establishment of the fourth rail loop. It would not likely be established until much later to coincide with a later 9X expansion phase as described in Section 5.10.2.

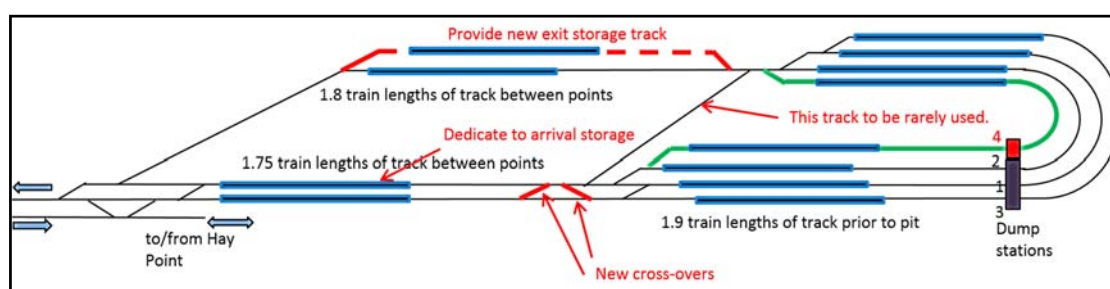

Figure 42: Proposed 8X rail loop modifications shown in red as proposed to be constructed with the IL4 dump station. The fourth rail loop in green would be constructed only at the later 9X stage.

6 Environment

6.1 Overview / Background

As discussed in Section 2.5, the release of the '*Reef 2050 Long Term Sustainability Plan*' (*Reef 2050*) has signified a new era of environmental management and governance within the GBRWHA.

The Queensland Government has responsibility for protection of the State waters and is therefore committed to a number of *Reef 2050* initiatives relating to port development. The recently introduced *Sustainable Ports Development Act (2015)* sets out the blueprint for port planning and management for certain ports in Queensland. The act aligns with the Commonwealth and State Government commitments under *Reef 2050*.

The increased focus on environmental management at Queensland ports, particularly those designated as 'priority ports' reinforces the need for careful and direct attention of those operating at these critical trading nodes.

DBCTM has always taken and discharged its environmental responsibilities carefully and recognises that operating in the GBRWHA requires robust environmental systems.

This attention will continue in forward years under this Master Plan.

Environmental management within the coastal environment, and particularly within the GBRWHA requires two fundamental considerations:

1. Robust consideration of existing environmental values as part of terminal and/or expansion planning – ensuring that environmental values are examined and managed using the well understood mitigation hierarchy of: avoidance, mitigation and offsets; and
2. Ensuring robust Environmental Management Frameworks are in place for the ongoing management of operations consistent with the requirements of Environmental Authorities for terminal operations and/or construction activities.

DBCTM supports the position of the Queensland Government in requiring robust Port Master Plans including greater transparency of Environmental Management Frameworks at Queensland's 'Priority Ports' and a stronger focus on port protection measures including appropriate environmental buffers.

This section of the Master Plan outlines the particular environmental issues and the corresponding management responses at play. It also addresses emissions and impacts likely from expansion pathways 1 and 2: the Zone 4 expansion and that contemplated under the 8X project.

In preparing this chapter of the Master Plan, it was decided that due to the preliminary nature of the 9X expansion pathway, and the lack of certainty regarding various project aspects, undertaking predictive emission modelling was not justified. As it currently stands, the 9X project is of such a scale, that more mature engineering assessments are required before any modelling of any real accuracy could be undertaken. Further, the 9X proposal would most likely trigger full Environmental Impact Statements (EIS) through State and Commonwealth processes in forward years.

6.1.1 Existing Environmental Authorities / Regulatory Processes

It should be noted that existing Environmental Authorities relevant to the terminal site and/or operations include:

- DBCTPL as the terminal operator, hold an existing Environmental Authority ('EA') (Permit EPPR00504513), granted on 19 October, 2015, which authorises the undertaking of ERA 50 (Bulk Material Handling up to 89Mtpa which includes the proposed expansion included in the Zone 4 pathway) and ERA 63 (Sewage Treatment (more than 100 but less than 1500 Equivalent Persons design capacity)); and
- Additionally DBCTM as terminal owner, holds an existing EA, granted on 27 April 2015, which authorises the undertaking of ERA 16 – Extractive Activities (extracting and screening, other than dredging of more than 100,000t but not more than 1,000,000t in a year) across the DBCT terminal site (Permit EPPR02825115). The EA authorises the undertaking of blasting as part of the extractive activities.

These Environmental Authorities have been issued by the Queensland Department of Environment & Heritage Protection ('DEHP') and cover the full extent of Expansion Pathway 1 (Zone 4) up to the terminal capacity of 89Mtpa.

It should also be noted that a formal referral was made for the Zone 4 project under the *Environment Protection & Biodiversity Conservation Act, 1999 ('EPBC Act')* (Ref: 2015/7541). On 12 September 2015, the Commonwealth advised that the Zone 4 project was deemed to be a 'Non-Controlled Action' and as such, no approval under the *EPBC Act* would be required.

On 15 December 2015, NQBP issued a conditional *Port Development Approval* under the Port of Hay Point Land Use Plan (approved under the *TI Act*), relating to the full extent of Zone 4 works.

The balance of this chapter addresses the various environmental / social values relevant to the terminal and its immediate environs and the results of predictive emission modelling relating to the proposed expansion pathways Zone 4 and 8X.

6.2 Preliminary Environmental Impact Assessment

This Master Plan differs from the 2009 Master Plan in that multiple expansion options are not being examined.

The expansion pathways outlined in this Master Plan are staged and incremental – in line with the direction under the new Commonwealth and State regulatory framework regarding coastal development within the GBRWHA.

Pathway options have not simply been examined from an engineering and operational perspective. Because of DBCT's geographical location within the GBRWHA, it has also been important to assess ecological and social values of each of the preferred pathways.

The expansion pathways have examined against various criteria and suitability including:

- Air Quality
- Noise & Vibration
- Visual Amenity
- Cultural Heritage
- Local Maritime Operations
- Community & Social Impacts
- Coastal Processes
- Marine Ecology
- Terrestrial Ecology
- Soil & Geology
- Surface Water Quality & Hydrology
- Transport & Access
- Waste Management
- Land Tenure & Other Stakeholder Interests

Each of the above are described in the following sub-sections

6.2.1 Air Quality

All potential air quality impacts have been examined and considered for the Zone 4 expansion pathway.

The increased volume of coal to be stored at an expanded terminal may increase the likelihood of dust emissions affecting neighbouring rural residential / community areas. As such, ongoing compliance with relevant Environmental Authorities will be critical in the forward management of operations as will ensuring participation in the broader 'port-wide' air quality monitoring programs managed by NQBP as the port authority.

As part of this Master Plan, predictive modelling work has been completed – see Section 6.4 for more detail.

DBCTM are continuously monitoring air emissions at and around the terminal in accordance with normal operational environmental management practices.

Work will continue and in conjunction with the port entity, NQBP, the operator will proactively adjust and adapt management practices as appropriate.

Ensuring appropriate port buffers is also a fundamental and strategic requirement for the Port of Hay Point over the longer term. This will be a critical issue for formal State Port Master Planning scheduled for 2017-2018.

6.2.2 Noise and Vibration

All potential noise and vibration impacts have been examined and considered for the Zone 4 expansion pathway.

At present, DBCT P/L undertakes noise monitoring at four (4) locations around the Port of Hay Point (internally and externally to the terminal) in accordance with the existing EA under the *Environmental Protection Act, 1994* (EP Act).

Noise assessment monitoring is undertaken continuously.

A number of noise control and management measures are incorporated across the DBCT site, and for the 2014-2015 period, noise levels were compliant with the limits under the existing EA.

It is anticipated that there will not be a significant increase in noise and vibration impacts as a result of either the Zone 4 or 8X expansion works (see Section 6.5 for more detail). Intensification of existing terminal operations, largely within existing terminal footprint areas will ensure the minimisation of noise emissions from the site. Further, upgrading operational equipment over time as development continues will also assist in noise and vibration management.

It is considered that the approach to noise / acoustic assessments employed at the terminal is industry best practice – and along the whole terminal process from inloading through to shipment of cargoes.

6.2.3 Visual Amenity

All potential visual amenity impacts have been examined and considered for the Zone 4 expansion pathway.

DBCT is an existing, long established land use, which forms part of the Port of Hay Point. Since operations first began at the port in October 1971, the Port of Hay Point has become Queensland's largest export port with exports in the 2014/2015 financial year reaching approximately 115 Mtpa across both DBCT and the adjoining Hay Point Coal Terminal. The designation of the Port of Hay Point as one of Queensland's 'Priority Ports' (thereby being a 'relevant port' under the *National Ports Strategy, 2012*) acknowledges that the visual amenity of the node is recognised and part of the landscape of this part of the Queensland coastal zone.

The Port of Hay Point is also recognised in local, regional and statewide planning instruments as a major infrastructure node along the Queensland coast.

Expansion of the terminal as proposed under this Master Plan is consistent with the well accepted visual amenity of the local environs.

6.2.4 Cultural Heritage

A search of the Cultural Heritage Database maintained by the Department of Aboriginal and Torres Strait Islander Partnerships (DATSIP) was undertaken as part of Zone 4 regulatory applications that did not identify any recorded indigenous cultural heritage sites within the area of the proposed works.

Any future expansion pathway would be required to proceed in line with relevant State and Commonwealth legislation regarding Cultural Heritage matters to ensure compliance with the Cultural Heritage Duty of Care under the *Aboriginal Cultural Heritage Act 2003*

6.2.5 Local Maritime Operations

Both Zone 4 and 8X expansion pathways do not entail any alteration to local maritime operations. Indeed, no marine development is proposed for either Zone 4 or 8X.

The 9X expansion pathway entails two new offshore berths and reclamation within the World Heritage Area. Development of this kind would need to be closely examined in terms of interactions with local maritime operations such as recreational and commercial fishing activities.

6.2.6 Community and Social Impacts

All potential community and social impacts have been examined and considered for the Zone 4 expansion pathway.

Both Zone 4 and 8X expansion pathways entail development within the existing terminal footprint. As such, it is not expected that any social or community impacts are likely as a result of terminal operations under these scenarios. Management of construction impacts will be required particularly with regard to traffic impacts and general movements around the terminal environs.

6.2.7 Coastal Processes

There are no anticipated coastal process impacts as a result of either the Zone 4 or 8X expansion pathways, as marine works are not included in these phases.

Only the 9X proposal entails development within the coastal zone. Potential impacts associated with this expansion pathway will be fully examined once more detailed engineering assessments have occurred in the course of normal project feasibility work.

Due to recently introduced legislation at both Commonwealth and State government levels, 'at-sea' relocation of capital dredge material is prohibited. The 9X pathway therefore includes a proposal to reclaim land (as detailed in Section 5.10.2) using material from necessary berth dredging consistent with the principles of 'beneficial re-use'.

While the reclaimed area may not immediately be used for port purposes, the area will present the opportunity to help screen coastal industrial operations from the World Heritage Area, thereby reducing potential visual amenity impacts.

Given the preliminary nature of the 9X design, the extent of material for this area and size of area is unable to be confirmed. However this Master Plan commits to design principles being based on a *Working with Nature* ('WwN') philosophy - as advocated by the World Association for Transport Infrastructure known as 'PIANC'.

As PIANC state:

'Working with Nature requires that a fully integrated approach be taken as soon as the project objectives are known – i.e. before the initial design is developed. It encourages consideration of how the project objectives can be achieved given the particular, site-specific characteristics of the ecosystem.'

Working with Nature is about more than avoiding or mitigating the environmental impacts of a pre-defined design. Rather, it sets out to identify ways of achieving the project objectives by working with natural processes to deliver environmental protection, restoration or enhancement outcomes'.

6.2.8 Marine Ecology

There are no anticipated marine ecology impacts as a result of either the Zone 4 or 8X expansion pathways.

Only the 9X proposal entails changes to development within the coastal zone. Potential impacts associated with this expansion pathway will be fully examined once more detailed engineering assessments have occurred in the course of normal project feasibility work.

Increased shipping movements would also need close examination although the increased size of average export parcels per vessel is equating to lower overall vessel movements per export tonne. Using the most recent data from a full financial year (2014/2015) the DBCT managed the export of 71,551,704 tonnes of coal via 694 vessels. This equates to an average payload size of 103,100 per vessel.

Over the last twenty years, the average export parcel size has increased by around 30,000 tonnes per vessel.

6.2.9 Terrestrial Ecology

All potential terrestrial impacts have been examined and considered for the Zone 4 expansion pathway.

Potential impacts associated with the 8X and 9X expansion options will be fully examined once more detailed engineering assessments have occurred in the course of normal project feasibility work. It is clear though that existing terminal environs are highly disturbed in nature.

6.2.10 Soil and Geology

Potential impacts upon soil and geology are to be assessed in greater detail prior to development proceeding. Existing groundwater bores (subject to existing state government licence conditions) will continue to be monitored / reported as part of the terminal Environmental Management System.

It is unlikely that soil and/or geological issues will restrict expansion pathways.

6.2.11 Surface Water Quality and Hydrology

Recent works undertaken as part of the Water Quality Improvement Project (WQIP), (including the construction of the new Rail Loop Dam) have significantly improved water quality management on site through increased water storage capacity across terminal lands.

Future expansion pathways outlined in this Master Plan are likely to benefit from such water quality management improvements.

6.2.12 Transportation and Access

Transportation and access issues are unlikely to change under either Zone 4 or 8X expansion pathways. The 9X expansion pathway would however, trigger changes to terminal access and significant changes to rail and road infrastructure.

6.2.13 Waste Management

Waste management under all expansion pathways is to be captured in relevant

construction and operational environmental management plans as per usual operations.

6.2.14 Land Tenure and Other Stakeholder Interests

Both Zone 4 and 8X expansion pathways use existing DBCTM held lands as they largely involve augmentation of existing terminal areas.

The 9X expansion pathway would require further land acquisitions in the immediate port environments for both terminal area and associated infrastructure corridors (road/rail etc.).

6.3 Potential environmental and planning issues

All regulatory approvals are in place for the Zone 4 expansion. Robust management of the construction phase will be required in accordance with the regulatory approvals already gained by both DBCTM and DBCT P/L including:

- being deemed a ‘non-controlled action’ under the *Environment Protection and Biodiversity Conservation Act, 1999* (Commonwealth), and
- securing all necessary environmental planning approvals under State legislation including Environmental Licenses under the *Environmental Protection Act, 1994* and port development approvals under the *Sustainable Planning Act, 2009*.

The location of the terminal within and adjacent to the GBRWHA, necessitates an absolute focus on: impact avoidance of environmental values as part of planning and design processes, and ensuring robust environmental management systems are in place for ongoing operations. This is especially true for 8X and 9X because of the larger scale of the developments.

For 8X and 9X the following is a list of key issues requiring further investigation in order to provide a more accurate assessment closer to the time of development:

- Cultural Heritage assessments of potential sites outside the existing DBCT footprint;
- Likelihood of impact on marine water quality, including impact on local beaches;
- Potential impacts to coastal processes as a result of reclamation works and any new marine infrastructure (9X);
- Reclamation and construction impacts upon local turtle nesting sites;
- Potential impacts upon seagrasses and other marine plants;
- Impacts to existing mangrove communities and the need for setbacks;
- Impact to tidal flow regime of Louisa Creek during 9X expansion works;
- Traffic assessment study to determine impacts upon Hay Point Road and the local road network;
- Any relevant amendments to *Reef2050* including implementation policies;
- Any relevant amendments to the *Sustainable Port Development Act, 2015*; and
- Quantitative noise and dust assessments based on enhanced engineering design parameters closer to the time of development; and
- Enhanced examination of port buffers around the Hay Point ‘priority port’ precinct.

In order to better understand potential noise and dust emissions, DBCTM commissioned preliminary studies of dust and noise modelling to ensure critical issues are factored into preliminary design and feasibility studies. The results are detailed in the following sections.

6.4 Air Quality Environment - Post Expansion

Due to their past experience with DBCT, Katestone Environmental (“Katestone”) was commissioned to undertake predictive modelling for expansion pathway 1 (Zone 4 project) and 2 (8X project) detailed within this Master Plan.

Particulate matter is the main air pollutant associated with operation of coal terminals. Emissions of other air pollutants will be low and therefore will have a negligible potential for impact compared to particulate matter. Particulate matter was the Primary focus of the Katestone air quality assessment and other air pollutants have not been considered further.

The air quality assessment assumes that the terminal has implemented the 8X Project (i.e. terminal capacity has reached 102 Mtpa). It also assumes that the neighbouring coal terminal is operating at its approved capacity (55Mtpa). The air quality assessment has been based on the following:

- Development of a three-dimensional (3D) meteorological dataset representative of prevailing conditions of the surrounding area;
- Estimation of emissions of particulate matter associated with coal terminal operations based on information used in previous air quality assessments, NPI reporting, other data provided by DBCTM and standard assumptions where information is not available;
- Dispersion modelling incorporating emission characteristics and particulate matter emission rates associated with the operation of the coal terminals. The model also includes site-specific 3D meteorology, terrain, land-use and geographical location of sensitive receptors; and
- Prediction of levels of particulate matter due to the operation of the coal terminals at identified sensitive receptor locations and the surrounding environment. Predicted ground-level concentrations of the key metrics including: TSP, PM₁₀ and PM_{2.5} and dust deposition rates have been assessed against the relevant air quality objectives detailed in the:
 - Environmental Authority Permit Number: EPPR00504513 (Date of Issue 19 October, 2015)
 - Environmental Protection (Air) Policy 2008 (Air EPP)
 - National Environment Protection (Ambient Air Quality) Measure (Air NEPM) (Commonwealth Department of the Environment, February, 2016) Department of Environment and Heritage Protection's (EHP) Guideline, Mining: Model mining conditions (EHP, 2013)
 - Application requirements for activities with impacts to air (EHP, 2015)

The general approach to this assessment is consistent with the methodologies applied in earlier air quality assessments conducted for regulatory approvals. In the late 1990s and early 2000s, Katestone developed a dust modelling system representing the Hay Point area that included DBCT and HPCT for the Stage 6 and 7 expansions of DBCT (Hay Point DispMod v1.0). That modelling system used the USEPA's ISC3 Gaussian dispersion model.

The ISC3 model is no longer supported by the USEPA.

More recently, the modelling system was redeveloped using the CALMET/CALPUFF models and this new modelling system was used for more recent expansion projects, most recently for the EIS for the Dudgeon Point Coal Terminal (Hay Point DispMod v2.0).

The current modelling system (Hay Point DispMod v2.0) incorporates the more sophisticated CALMET meteorological model and the CALPUFF dispersion model, which are accepted for use by regulatory authorities in Australia. Hay Point DispMod v2.0 also incorporates an emissions

model that is configured to represent the spatial and temporal emissions from DBCT at 85 Mtpa and HPCT at its current approved capacity of 55 Mtpa.

6.4.1 Emissions

Activities associated with the most significant emissions of particulate matter from coal terminals are conveyors, stockpiles, transfers and other activities such as bulldozing and excavators.

Dust emission rates from DBCT and HPCT were estimated in earlier studies from limited near source monitoring of TSP concentrations (GHD/Oceanics, 1975). Updated estimates were included in subsequent studies (Dames & Moore, 1996, Katestone Scientific 2000, Katestone Environmental 2005 and WBM 2004). For this air quality assessment, these estimates have been revised based on more recent emission factors reported in literature (e.g. National Pollutant Inventory Handbooks or the USEPA’s AP-42 compilation of emission factors) and site specific data obtained through the NPI reporting period 2014/2015.

For the majority of activities, the emission rate of particulate matter is dependent on the wind speed with little or no emissions occurring for some activities (e.g. stockpiles) below a wind speed threshold. For some activities (such as coal conveyors), wind speed and frequency of utilisation are important determinants of the emission rate. Other factors are also important such as coal type, coal moisture content, coal particle size distribution, rainfall and the mitigation measures that may be employed. A summary of emission rates for DBCT (8X Project) operating at 102 Mtpa is provided in Table 11:

Activity	TSP (g/s)	PM ₁₀ (g/s)	PM _{2.5} (g/s)
Rail receipt	0.17	0.08	0.01
Stacking	0.29	0.14	0.02
Reclaiming	0.57	0.27	0.04
Surge bin	0.17	0.08	0.01
Stockpiles - wind erosion	0.58	0.29	0.04
transfers - inloading	0.45	0.21	0.03
transfers - outloading	1.59	0.75	0.11
Ship loading	0.14	0.07	0.01
Conveyors	0.83	0.30	0.02
Other - bulldozing	1.53	0.50	0.03
Other - excavator	1.47	0.23	0.03
Total	7.8	2.9	0.4

Table 11: Summary of Emissions for DBCT (8X project) at 102 Mtpa

6.4.2 Results

Predicted concentrations are compared with limits specified in Condition B2 of DBCT’s EA (Date of Issue, 19 October 2015), objectives specified in the *Air EPP* and EHP guideline documentation (EHP, 2013 and EHP, 2015). Also included is a comparison with the recently updated *Air NEPM* to assess potential impacts should the State based Air EPP objectives be revised to reflect the Air NEPM standards.

The modelling results, based on preliminary engineering, can be summarised as follows:

- Predicted maximum monthly dust deposition rates comply with Condition B2 of DBCT’s EA at all receptors
- Predicted maximum 24-hour average and annual average concentrations of PM_{2.5} comply with the relevant Air EPP and Air NEPM objectives and standards at all receptors
- Predicted 6th high 24-hour average and annual concentrations of PM₁₀ comply with the relevant Air EPP and Air NEPM standards at all receptors
- Predicted 24-hour average concentrations of TSP comply with Condition B2 of DBCT’s EA at all receptors except at Louisa Creek East (P2)
- Predicted maximum concentrations of PM₁₀ comply with the Air NEPM standard of 50 µg/m³ (no allowable exceedances) at all receptors except at Louisa Creek East (P2)

The following tables reflect the modelling results:

Receptors	TSP 24-hour average (µg/m ³)			TSP Annual average (µg/m ³)	
	DBCT (8X Project) in isolation	DBCT (8X Project) and HPCT	DBCT (8X Project), HPCT and ambient background	DBCT (8X Project) in isolation	DBCT (8X Project), HPCT and ambient background
Louisa Creek West (P1)	19.2	40.7	101	3.3	52.6
Louisa Creek East (P2)	40.5	56.5	116	14.2	64.1
Half Tide (P3)	14.9	18.6	78.5	1.1	50.6
Salonika (P4)	11.4	12.4	72.3	0.7	49.6
Louisa Creek Central	26.4	36.4	96.3	7.8	57.4
Timberlands	6.0	8.1	68	0.3	48.9
Objective / EA Limit	50 µg/m³ (increase above background) (EA)		110 µg/m³ (background + 50 µg/m³)^a	90 µg/m³ (Air EPP)	
Table note: ^a A limit of 110 µg/m ³ was calculated based on background + 50 µg/m ³ as per Condition B2 of DBCT’s EA. A background of 60 µg/m ³ was determined from 75 th percentile, 24-hour average for P4 from 2001 to 2011.					

Table 12: Predicted ground-level concentrations of TS

Receptors	PM ₁₀ Maximum 24-hour average (µg/m ³)		PM ₁₀ 6 th high 24-hour average (µg/m ³)		PM ₁₀ annual average (µg/m ³)	
	DBCT (8X Project) in isolation	DBCT (8X Project), HPCT and ambient background	DBCT (8X Project) in isolation	DBCT (8X Project), HPCT and ambient background	DBCT (8X Project) in isolation	DBCT (8X Project), HPCT and ambient background
Louisa Creek West (P1)	9.7	38.5	7.4	26.0	1.7	15.3
Louisa Creek East (P2)	20.9	55.3	16.7	37.8	6.4	20.4
Half Tide (P3)	6.4	26.0	4.9	23.7	0.5	14.1
Salonika (P4)	5.2	22.5	3.2	21.5	0.3	13.6
Louisa Creek Central	12.4	41.2	10.6	31.9	3.8	17.6
Timberlands	4.6	23.1	2.9	20.3	0.2	13.3
Objective	50 µg/m³ (Air NEPM)		50 µg/m³ (Air EPP)		25 µg/m³ (Air NEPM)	

Table 13: Predicted ground-level concentrations of PM₁₀

Receptors	PM _{2.5} Maximum 24-hour average (µg/m ³)		PM _{2.5} annual average (µg/m ³)	
	DBCT (8X Project) in isolation	DBCT (8X Project), HPCT and ambient background	DBCT (8X Project) in isolation	DBCT (8X Project), HPCT and ambient background
Louisa Creek West (P1)	1.3	6.5	0.25	2.79
Louisa Creek East (P2)	3.2	7.8	0.84	3.41
Half Tide (P3)	0.9	4.1	0.07	2.61
Salonika (P4)	0.7	3.9	0.05	2.57
Louisa Creek Central	2.0	6.2	0.52	3.07
Timberlands	0.7	4.1	0.04	2.55
Objective	25 µg/m³ / 20 µg/m³ (Air EPP) / (Air NEPM goal for 2025)		8 µg/m³ / 7 µg/m³ (Air EPP) / (Air NEPM goal for 2025)	

Table 14: Predicted ground-level concentrations of PM_{2.5}

Receptors	Dust deposition monthly average (mg/m ² /day)		
	DBCT (8X Project) in isolation	DBCT (8X Project) and HPCT	DBCT (8X Project), HPCT and ambient background
Louisa Creek West (P1)	19.6	23.9	38.6
Louisa Creek East (P2)	46.5	47.4	62.0
Half Tide (P3)	5.7	10.0	24.7
Salonika (P4)	4.7	6.3	21.0
Louisa Creek Central	28.4	29.0	43.7
Timberlands	1.0	1.3	16.0
Limit / Guideline	60 mg/m²/day (increase above background) (EA)		74.7 mg/m²/day (background + 60 mg/m²/day)^a / 120 mg/m²/day (EHP model mining conditions)
Table note: ^a A limit of 74.7 mg/m ² /day was calculated based on background + 60 µg/m ³ as per Condition B2 of DBCT's EA. A background of 14.7 µg/m ³ was determined from monitoring data from 2001 to 2011.			

Table 15: Predicted dust deposition rates

Detailed engineering work as part of further developing the 8X concept will need to explore additional ways to mitigate emissions from the proposed development. As preliminary engineering design was used for the purpose of this current modelling, it is believed reductions in emissions may be possible at various terminal elements during advanced engineering.

Additionally, and in line with best practice long-term planning at and around this 'priority port' node, it is recommended that the form and extent of environmental buffers, particularly along the western boundary of the terminal, be examined further in conjunction with NQBP as the port authority.

It is recommended that the examination of enhanced port buffer options be highlighted as a priority issue in the formal State Port Master Planning endeavours (to be managed by the State of Queensland) scheduled to occur in 2017-2018. This is considered critical to ensure the protection of the port node and neighbouring areas into the future and consistent with the planning approach outlined in the *Sustainable Port Development Act, 2015*.

6.5 Noise Environment - Post Expansion

Predictive noise modelling has also been used to ensure expansion pathways are within reasonable limits and statutory guidelines as currently known. Due to their past experience with DBCT, Huson & Associates ("Huson") were again commissioned to model noise levels to determine the change in noise level in the environment surrounding the terminal up to and including the proposed 8X pathway.

The base case operations (permitted by the current environmental authority EPPR00504513 at a throughput of 89 Mtpa) considered in the noise model included Zone 4 works. This case is predicted to meet the target noise levels described in the EA.

6.5.1 Licence Conditions

The current noise conditions differ from earlier licenses in that D1 now refers to

‘environmental nuisance’ compared with earlier licenses that referred to ‘unlawful environmental nuisance’.

In addition, noise sensitive places are expanded in the current license to include commercial and retail activity places.

The noise sensitive places from the *Environmental Protection (Noise) Policy 2008* are:

- dwelling (indoors and outdoors)
- library and educational institution (including a school, college and university) (for indoors)
- childcare centre or kindergarten (for indoors)
- school or playground (for outdoors)
- hospital, surgery or other medical institution (for indoors)
- commercial and retail activity (for indoors)
- protected area, or an area identified under a conservation plan under the *Nature Conservation Act 1992* as a critical habitat or an area of major interest marine park under the *Marine Parks Act 2004*
- park or garden that is open to the public (whether or not on payment of an amount) for use other than for sport or organised entertainment

The licence changes in the latest environmental authority (EPPR00504513) now imply that the nearest sensitive place to DBCT to the south east of the terminal is the retail activity (shops) near to the new location of the P3 noise monitoring station, instead of the nearest dwelling.

Huson assumed that the commercial activities of NQBP (Ports control centre and public viewing area) and the adjoining Hay Point Coal Terminal were not considered to be Noise Sensitive Places.

6.5.2 Assessment of 8X Pathway (including Zone 4)

6.5.2.1 Noise Impact of 8X - Phase 1

The noise contribution from ST1, ST2, RL3 and the R2 conveyor are each more than 10 dB below the total DBCT site noise emissions measured at any of the nearest noise sensitive places.

No significant noise increases will be ensured through engineering associated with the stacker and reclaimer upgrades. A minor increase in noise emission from the R2 conveyor speed increase (approximately 1dB) is predicted but this will have no material effect on the noise levels observed in the surrounding community. No change in overall noise levels for any noise sensitive location surrounding DBCT are predicted at the conclusion of Phase 1 (8X). Importantly, Huson predicts that compliance with the current license conditions will be maintained.

6.5.2.2 Noise Impact of 8X - Phase 2

The opportunity exists to provide additional noise amelioration to the new RRP4 shed compared to that currently available from the existing RRP1 shed. Although a reduction in noise emissions from the new RRP4 shed can be gained, Huson (2016)

conservatively assumed that no net noise reduction has been achieved and that RRP4 simply replaces RRP1 with the same noise emissions.

An upgrade of one of the outloading conveyors may produce a minor noise increase (approximately 1 dB), however, the change to the overall DBCT noise emissions observed at the nearest noise sensitive places will be insignificant.

The most significant increase in noise emissions from the Phase 2 (8X) expansion will be from the new IL4 and buffer storage which will produce a minor noise increase to the south east of the DBCT.

The net change in noise level at P3 (representative of the nearest noise sensitive place to the south east) is from 49.6 dB(A) to 50.3 dB(A), an increase of less than 1 dB and remaining below the 53 dB(A) night time noise limit in the EA.

6.5.3 Conclusions

After completion of the two phases of the 8X expansion Huson (2016) predicted no change in sound levels at noise sensitive places in the region around Louisa Creek to the west of DBCT. A minor noise increase of less than 1 dB(A) was predicted in the noise sensitive places near to the new P3 noise monitoring station in Hay Point to the east and south east of the DBCT. However, the increase in noise level would remain compliant with noise level limits in the current environmental authority.

A minor noise increase of less than 1 dB(A) was also predicted for some of the noise sensitive places around Horsburgh Road that is to the west of the DBCT rail loop.

Importantly though, increased noise level would also comply with noise level limits in the current environmental authority.

7 Stakeholder Consultation

7.1 Public Consultation Process

The Port of Hay Point Community Reference Group (CRG) has been a critical link between DBCT and the community. Membership of the CRG currently includes representatives of DBCTM, DBCT P/L, PCQ and the local communities of Louisa Creek, Mirani, Sarina, Half Tide and the Droughtmaster Drive area. The general public is invited to attend meetings as observers with questions taken from the floor. The CRG publishes minutes of meetings, as well as an official newsletter that is made available to communities.

The Port of Hay Point CRG discusses a wide range of local concerns and is kept abreast of general developments at DBCT to provide an ongoing general public forum that ensures the community is well informed about DBCT issues that affect the whole of port stakeholders. In turn, DBCTM and DBCT P/L are able to consider and gauge general community concerns as part of the ongoing DBCT planning process.

Because the more specific issues associated with the operations of DBCT were sometimes confused with the whole of port group, the DBCT terminal Operator undertook to commence its own Community Working Group (CWG). This group is represented by community members, local government, DBCT P/L, the local State member and DBCTM. The primary goal of the group is facilitating open two-way communications that enhance understanding of issues specifically associated with the terminal and to build trust and potential opportunity between the members.

As environmental performance remains a source of concern for the community, this double strategy ensures community relations are maintained, especially as production increases and environmental risks increase. As part of ongoing efforts to further improve public consultation, DBCTM is investing in other more direct means of engaging with the local community (such as public information sessions and one-on-one briefings for local government).

DBCTM also recognises that expansion projects may create additional community pressures that are not correlated to the terminal operation. Accordingly, DBCTM takes an active role with the community promoting stakeholder knowledge of future expansion.

CRG meetings are held every 3 months and CWG meetings are held every 2 months. Since mid-2014 DBCTM has been updating these forums on the Master Plan development and the feasibility studies being undertaken. These forums have been made aware of the Zone 4 project planning and also the concepts for 8X and 9X. A detailed presentation on the draft Master Plan was given to the CRG in November 2015.

7.2 Community Engagement Strategy

The primary objective of a community engagement strategy is to assist in the provision of a stable social operating environment for the business and to allow DBCT to expand to meet industry demand.

DBCTM's community engagement strategy is based on:

- informing and educating the community regarding the terminal's operating philosophy and activities including values, history, commitment to sustainability, security etc.;
- working to continually improve relations with the immediate community through successful community engagement and relationship building;
- proactively strengthening key stakeholder relationships outside the immediate community;
- effectively and efficiently managing complaints and issues; and
- promoting greater integration/interdependence between the community and the terminal over the long term.

A multi-faceted approach to Community liaison has been adopted, as no single plan, including attendance at the Port of Hay Point Community Relations Group (CRG), can satisfy all of the expectations of various community groups and individuals.

Typical responsibilities of this liaison role include:

- meet and greet activities, including working with local schools and TAFE colleges, managing site tours, visits and handouts. This forms an integral part of the community information and education campaign;
- interaction with the CWG local advisory group;
- production of written material on how the Terminal operates, its values, history, environmental initiatives, etc.;
- development of local employment, primarily through the DBCT expansion projects;
- speaking engagements at local clubs, council, service industries etc.;
- response to community input or issues; and
- maintaining a web site to better inform interested parties of terminal related matters.

7.3 Key Stakeholder Relations Program

While the focus of this strategy is community engagement, external stakeholders also need to be included in terminal information. These external stakeholders include:

- approval agencies, e.g. Environmental Protection Agency and the Queensland Department of Environment and Heritage Protection;
- elected representatives (State, Federal and local Government);
- Ministers relevant to the operation or expansion of the terminal;
- media;
- environmental groups; and
- Local Government officers from such agencies as Department of Natural Resources & Mines and Queensland Health.

As such, community engagement programs have been extended to include communication

with key stakeholders in order to ensure proactive relationships with these parties.

7.4 Management of Complaints & Issues

It is important for any organisation undertaking community engagement to field and manage community input and complaints in an efficient and effective manner. Dedicated channels of communication and protocols have been established to facilitate management of community suggestions and issues which include both the terminal Operator and expansion contractors.

DBCT is only one component of the Goonyella coal supply chain and relies on the performance and alignment of the upstream and downstream stakeholders to operate at maximum efficiency. As a result, DBCTM continues to place a strong emphasis on maintaining a cooperative relationship with its stakeholders.

As with previous Master Plans, this plan (2016) has been prepared by DBCTM in consultation with current stakeholders identified as:

- Local neighbouring communities – via CRG and CWG meetings since mid-2014 with a detailed presentation given to the CRG in November 2015
- Queensland Department of State Development – October 2015 Briefing
- North Queensland Bulk Ports - March 2016
- Queensland Department of Transport & Main Roads (DTMR)
- DBCT Access Holders and Access Seekers. DBCT throughput and capacity forum – 12 December 2014, 28 April 2015, 17 March 2016
- The DBCT terminal Operator (DBCT Pty Ltd) - Ongoing;
- Hay Point Services (HPS) via regular Port Liaison meetings;
- Aurizon Network (rail network provider) - Quarterly;
- Aurizon National and Pacific National DBCT throughput and capacity forum – 12 December 2014, 28 April 2015;
- Queensland Department of Environment and Heritage Protection via regular Port Liaison meetings;
- Commonwealth Environmental Protection Agency through pre-lodgement discussions and EPBC referral for Zone 4 project;