

# PACCAR MX-13

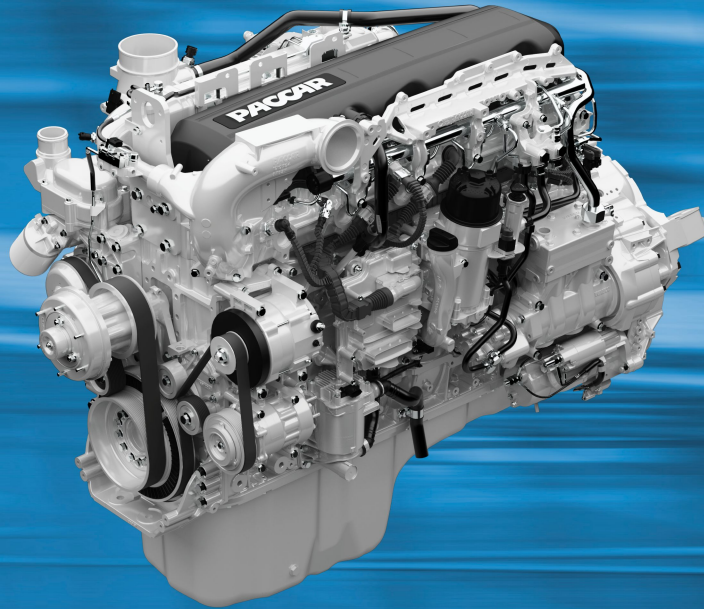

## Operator's Manual



# Contents

---

**Safety**

1

**Emergency**

2

**Controls**

3

**Driving**

4

**Maintenance**

5

**Information**

6

**Index**

7

# Contents

---

## **©2013 Paccar Inc - All Rights Reserved**

This manual illustrates and describes the operation of features or equipment which may be either standard or optional on this vehicle. This manual may also include a description of features and equipment which are no longer available or were not ordered on this vehicle. Please disregard any illustrations or descriptions relating to features or equipment which are not on this vehicle.

PACCAR reserves the right to discontinue, change specifications, or change the design of its vehicles at any time without notice and without incurring any obligation.

The information contained in this manual is proprietary to PACCAR. Reproduction, in whole or in part, by any means is strictly prohibited without prior written authorization from PACCAR Inc.

## Introduction

Safety Alerts . . . . .	1-3
Foreword . . . . .	1-5
Important Reference Number. . . . .	1-6
Illustrations. . . . .	1-7
General Safety Instructions. . . . .	1-7



## Introduction

### Safety Alerts

Please read and follow all of the safety alerts contained in this manual. They are there for your protection and information. These alerts can help you avoid injury to yourself, your passengers, and help prevent costly damage to the vehicle. Safety alerts are highlighted by safety alert symbols and signal words such as "WARNING", "CAUTION", or "NOTE". Please do not ignore any of these alerts.

#### WARNING

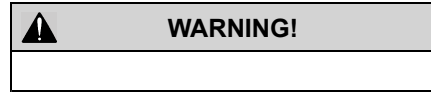

The safety alert following this symbol and signal word provides a warning against operating procedures which could cause death or injury. They could also cause equipment or property damage. The alert will identify the hazard, how to avoid it, and the probable consequence of not avoiding the hazard.

#### Example:

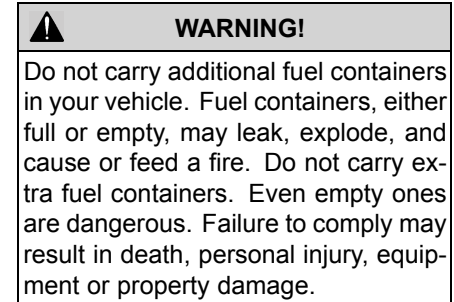

# Introduction

---

1

## CAUTION

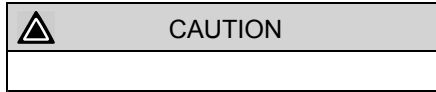

The safety alert following this symbol and signal word provides a caution against operating procedures which could cause equipment or property damage. The alert will identify the hazard, how to avoid it, and the probable consequence of not avoiding the hazard.

### Example:

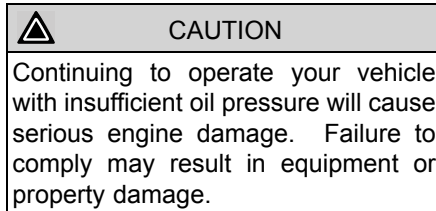

## NOTE

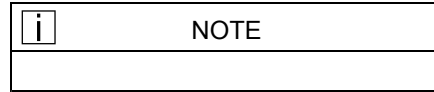

The alert following this symbol and signal word provides important information that is not safety related but should be followed. The alert will highlight things that may not be obvious and is useful to your efficient operation of the vehicle.

### Example:

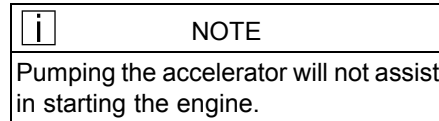



## Foreword

This manual contains information for the correct operation and maintenance of your PACCAR engine. Read and follow all safety instructions. Refer to the WARNING in the “General Safety Instructions” beginning on page 1-7. Keep this manual with the equipment. If the equipment is traded or sold, give the manual to the new owner. The information, specifications, and recommended maintenance guidelines in this manual are based on information in effect at the time of printing. PACCAR reserves the right to make changes at any time without obligation. If you find differences between your engine and the information in this manual, contact your local PACCAR Authorized Repair Location or write to PACCAR c/o PACCAR Engines, PO Box 1518, Bellevue, WA 98009. The latest technology and the highest quality components were used to produce this

engine. When replacement parts are needed, we recommend using only genuine parts from PACCAR.

# Introduction

---

1

## Important Reference Number

Fill in the part name and number in the blank spaces provided below. This will give you a reference whenever service or maintenance is required.

<b>Part Name</b>	<b>Number</b>
Engine Model	
Engine Serial Number (ESN)	
Oil Type (Use API CJ-4 oil only)	
Filter Part Numbers:	
Air Cleaner Element	
Lubricating Oil	
Fuel (Use ultra-low sulfur diesel fuel only)	
Coolant	
Belt Part Numbers:	

## Illustrations

### General Information

Some of the illustrations throughout this manual are generic and will not look exactly like the engine or parts used in your application.

The illustrations are intended to show repair or replacement procedures. The procedure will be the same for all applications, although the illustration can differ.

## General Safety Instructions

### Important Safety Notice

	<b>WARNING!</b>
Improper practices, carelessness, or ignoring any warnings may cause death, personal injury, equipment or property damage.	

Before performing any repair, read and understand all of the safety precautions and warnings. The following is a list of general safety precautions that must be followed to provide personal safety. Failure to follow these instructions may cause death or injury. Special safety precautions are included in the procedures when they apply.

- Use the proper tool for manually rotating the engine. Do not attempt to rotate the crankshaft by pulling or prying on the fan. This practice can cause death, personal injury, equipment damage, or damage to

the fan blades, causing premature fan failure.

- Work areas should be dry, well lit, ventilated, free from clutter, loose tools, parts, ignition sources and hazardous substances.
- Wear protective glasses and protective shoes when working.
- Do not wear loose-fitting or torn clothing. Remove all jewelry when working.
- Before beginning any repair, disconnect the battery (negative [-] cable) and discharge any capacitors.
- Put a "DO NOT OPERATE" tag in the operator's compartment or on the controls.
- Allow the engine to cool before slowly loosening the coolant filler cap to relieve the pressure from the cooling system.

## Introduction

---

1

- Always use blocks or proper stands to support the vehicle or vehicle components before performing any service work. Do not work on anything that is supported only by lifting jacks or a hoist.
- Before removing or disconnecting any lines, fittings, or related items, relieve all pressure in the air, oil, fuel, and cooling systems. Remain alert for possible pressure when disconnecting any device from a system that contains pressure. High pressure oil or fuel can cause death or personal injury.
- Always wear protective clothing when working on any refrigerant lines and make sure that the workplace is in a well ventilated area. Inhalation of fumes can cause death or personal injury. To protect the environment, liquid refrigerant systems must be properly emptied and filled using equipment that prevents the release of refrigerant gas. Federal law requires capturing and recycling refrigerant.
- When moving or lifting any heavy equipment or parts, make sure to use proper techniques and assistance. Ensure all lifting devices such as chains, hooks, or slings are in good condition and are of the correct load capacity. Make sure any lifting devices are positioned correctly.
- Corrosion inhibitors and lubricating oils may contain alkali. Do not get the substance in eyes and avoid prolonged or repeated contact with skin. Do not swallow. In case of contact, immediately wash skin with soap and water. In case of harmful contact, immediately contact a physician. Always keep any chemicals OUT OF REACH OF CHILDREN.
- Naptha and Methyl Ethyl Ketone (MEK) are flammable materials and must be used with caution. Follow the manufacturer's instructions to ensure safety when using these materials. Always keep any chemicals OUT OF REACH OF CHILDREN.
- When working on the vehicle, be alert for hot parts on systems that have just been turned off, exhaust gas flow, and hot fluids in lines, tubes, and compartments. Contact with any hot surface may cause burns.
- Always use tools that are in good condition. Make sure you have the proper understanding of how to use the tools before performing any service work. Use only genuine replacement parts from PACCAR.

- Always use the same fastener part number (or equivalent) when replacing items. Do not use a fastener of lesser quality if replacements are necessary.
- Do not perform any repair when impaired, tired, fatigued or after consuming alcohol or drugs that can impair your functioning.
- Some state and federal agencies in the United States of America have determined that used engine oil can be carcinogenic and can cause reproductive toxicity. Avoid inhalation of vapors, ingestion, and prolonged contact with used engine oil.
- Coolant is toxic. If not reused, dispose of coolant in accordance with local environmental regulations.
- California Proposition 65 Warning - Diesel engine exhaust and some of its constituents are known to the State of California to cause cancer, birth defects, and other reproductive harm.
- The catalyst substrate located in the Diesel Particulate Filter contains Vanadium Pentoxide. Vanadium Pentoxide has been determined by the State of California to cause cancer. Always wear protective clothing and eye protection when handling the catalyst assembly. Dispose of the catalyst in accordance with local regulations. If catalyst material gets into the eyes, immediately flood eyes with water for a minimum of 15 minutes. Avoid prolonged contact with skin. In case of contact, immediately wash skin with soap and water. In case of harmful contact, immediately contact a physician.

	<b>CAUTION</b>
Corrosive chemicals can damage the engine. Do not use corrosive chemicals on the engine. Failure to comply may result in equipment or property damage.	



**WHAT TO DO IF...**

You Need Roadside Assistance . . . . . 2-3  
Stop Engine Lamp Turns On . . . . . 2-3  
Engine Oil Pressure Lamp Turns On. . . . . 2-4  
Check Engine Lamp Turns On . . . . . 2-5  
Engine is Overheating . . . . . 2-5





## WHAT TO DO IF...

### You Need Roadside Assistance

Call toll-FREE to talk to someone at the PACCAR Customer Center:

- Kenworth customers, call 1-800-KW-ASSIST (1-800-592-7747).
- Peterbilt customers, call 1-800-4-PETERBILT (1-800-473-8372).
- Open 24-7-365 days a year.
- They can help you get roadside assistance.
- They have a custom mapping system which locates authorized PACCAR engine dealers and Independent Service Providers (ISPs) near you and lists types

of services offered, hours of operation and contact information.

- They can assist with jump and pull starts, tires, trailers, fines and permits, chains, towing, hazardous clean-up, out of fuel (roadside), mechanical repairs and preventive maintenance services.
- They have multilingual agents and access to a translation service to ensure quality assistance for customers who speak any language.
- They can't answer your warranty questions but can get you in contact with an authorized dealer who can.
- The PACCAR Customer Center service is FREE.

### Stop Engine Lamp Turns On



**Stop Engine Lamp** - If the Stop Engine warning lamp illuminates, it means you have a serious engine system problem.



#### WARNING!

This should be considered an emergency. You should stop the vehicle as safely as possible and turn OFF the ignition. The vehicle must be serviced and the problem corrected before driving again. Failure to do so may result in personal injury, severe engine damage, equipment or property damage.

## WHAT TO DO IF...

### Engine Oil Pressure Lamp Turns On

2



#### Engine Oil Pressure Gauge

- It is important to maintain oil pressure within acceptable limits. If oil pressure drops below the minimum psi a Red Warning Lamp on the oil pressure gauge and the Stop Engine Lamp will come ON.



#### CAUTION

Continuing to operate your vehicle with insufficient oil pressure may cause severe engine damage, equipment or property damage.

- If the oil pressure fails to rise within 10 seconds after the engine starts, stop the engine and determine the cause.
- See Lubricating Oil System on page 5-12, for the correct oil

pressure ranges for your vehicle's engine.

- If the oil pressure suddenly drops, or the audible alarm and engine oil pressure warning light come on while driving, do the following:
  1. Slow down carefully.
  2. Move a safe distance off the road and stop.
  3. Place the transmission in neutral and set the parking brake. (See Parking Brake Valve and OPERATING THE TRANSMISSION in your vehicle Operator's Manual, for transmission shifting and parking brake information.)
  4. Turn OFF the engine.
  5. Turn ON the emergency flasher and use other warning devices to alert other motorists.
  6. Wait a few minutes to allow oil to drain into the engine oil pan, and then check the oil level. (See Inspection of the Engine Oil Level on page 5-4.)
  7. Add oil if necessary. If the problem persists, contact an authorized PACCAR engine dealer as soon as possible.

## Check Engine Lamp Turns On



**Check Engine Lamp** - Turns on when a problem exists, but the vehicle can still be safely driven. Vehicle should be serviced to correct the problem but the situation should not be considered an emergency.

## Engine is Overheating



### CAUTION

The cooling system may overheat if the engine coolant is at the minimum level. A sudden loss of coolant, caused by a split hose or broken hose clamp could also lead to an overheat condition. Always inspect to ensure hoses and clamps are not cracked, worn, or loose. Failure to comply may result in equipment or property damage.



### NOTE

The system may also temporarily overheat during severe operating conditions such as:

- Climbing a hill on a hot day.
- Stopping after high-speed/high-load driving.
- Debris blocking air flow through the cooling module (radiator).

If the engine coolant temperature warning lamp comes on and the audible alarm sounds showing an overheat condition, or if you have any other reason to suspect the engine may be overheating, **DO NOT TURN OFF THE ENGINE** unless a low water warning device indicates a loss of coolant. Follow these steps:

- Reduce engine speed or stop. When stopped, place the transmission in neutral and set the parking brake. See the vehicle operator's manual for instructions on transmission shifting and parking brake information.
- Check to ensure that the oil pressure gauge reads normal.
- Increase the engine speed to 1,100 to 1,200 rpm maximum for 2-3 minutes.

## WHAT TO DO IF...

---

2

- Monitor the engine temperature. After the temperature returns to normal, allow the engine to idle 3–5 minutes before shutting it off. This allows the engine to cool gradually and uniformly.
- If the overheating came from severe operating conditions, the temperature should have cooled by this time.
- Check the coolant level at the cooling module surge tank.

 <b>WARNING!</b>
To reduce the chance of personal injury and/or vehicle damage caused by engine overheating, never leave the engine idling when the vehicle is unattended. If the engine overheats, immediate action is required to correct the condition. Continued unattended operation of the engine, even for a short time, may result in serious engine damage or a fire. Failure to comply may result in death, personal injury, equipment or property damage.

 <b>WARNING!</b>
Removing the fill cap on a hot engine can cause scalding coolant to spray out and burn you badly. If the engine has been in operation within the previous 30 minutes, be very careful in removing the fill cap. Protect face, hands, and arms against escaping fluid and steam by covering the cap with a large, thick rag. Do not try to remove it until the surge tank cools down or if you see any steam or coolant escaping. In any situation, remove the cap very slowly and carefully. Be ready to back off if any steam or coolant begins to escape. See the vehicle operator's manual for instructions on checking and filling the cooling module surge tank.

 CAUTION
<p>Prolonged periods of idling after the engine has reached operating temperatures can decrease engine temperature and could cause engine damage from inadequate lubrication. The normal torsional vibrations generated can also cause transmission wear. An idle shutdown feature, available on PAC-CAR engines, can be programmed to shut the engine down after a period of low idle operation with no driver activity. A flashing warning lamp will inform the driver of an impending shutdown. Failure to comply may result in equipment or property damage.</p>

 CAUTION
<p>If the truck is equipped with PTO equipment, the engine shutdown system can be deactivated when the PTO is operational; however, engine idle periods should not exceed 5 minutes whenever possible. Failure to comply may result in equipment or property damage.</p>



**Operating Instructions**

Engine Warning Lamps . . . . .	3-3
Engine Operating Range . . . . .	3-6
Engine Braking System . . . . .	3-7





## Operating Instructions

### Engine Warning Lamps General Information

The following engine warning lamps cover only the lamps controlled by the engine's Electronic Control Module (ECM). Please refer to the vehicle Operator's and Engine Aftertreatment Systems manual for additional warning lamp information.

#### Check Engine Lamp



The check engine warning lamp will illuminate when a problem exists, but the vehicle can still be safely driven. The vehicle should be serviced to correct the problem, but the situation should not be considered an emergency.

The lamp will also illuminate when a DPF regeneration or addition of Diesel Exhaust Fluid is required. Another function of the check engine lamp is to warn the operator of an impending idle shutdown. When the idle shutdown timer is 30 seconds from expiring, the engine ECM begins flashing the check engine warning lamp once per second. When the timer expires, the ECM will

turn off the warning lamp and shut down the engine.

# Operating Instructions

## Stop Engine Lamp



flash 30 seconds before the engine automatically shuts down. The warning lamp alerts the operator to the impending shutdown.

The lamp will also illuminate when the Diesel Exhaust Fluid (DEF) tank is almost empty or the soot level in the DPF is at full capacity. At this level warning, regeneration cannot be performed and engine power will be derated.

Engine may automatically shut down if the Check Engine light and Stop Engine light are illuminated and the operator does not correct the condition.



i	NOTE
	<p>The Malfunction Indicator Lamp (MIL) will illuminate if the OBD (On-board Diagnostics) system detects a possible emissions system failure.</p> <p>The vehicle should be brought in for service at the next opportunity to ensure the condition is corrected.</p>

3

The stop engine warning lamp will illuminate, and an audible tone will sound, when a major engine problem exists.

 <b>WARNING!</b>
<p>This should be considered an emergency. You should stop the vehicle as safely as possible and turn OFF the ignition. The vehicle must be serviced and the problem corrected before driving again. Failure to comply may result in personal injury, severe engine damage, equipment or property damage.</p>

For engines with the engine protection shutdown feature enabled, the stop engine lamp will begin to

### Diesel Particulate Filter (DPF) Warning Lamp

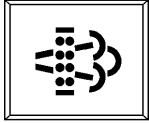

DPF Warning Lamp

Refer to Engine Aftertreatment Systems Operator's Manual for additional information.

### High Exhaust System Temperature (HEST) Warning Lamp



HEST Warning Lamp

Refer to Engine Aftertreatment Systems Operator's Manual for additional information.

### Check Engine Lamp (CEL)



Check Engine Lamp

Refer to Engine Aftertreatment Systems Operator's Manual for additional information.

## Operating Instructions

### Diesel Exhaust Fluid (DEF) Lamp



### Diesel Exhaust Fluid (DEF) Lamp

3

Refer to Engine Aftertreatment Systems Operator's Manual for additional information.

## Engine Operating Range General Information

### CAUTION

Operating the engine at full throttle below peak torque will shorten engine life to overhaul, can cause serious engine damage, and is considered engine abuse. Do not operate the engine at full throttle operation below peak torque rpm for more than 30 seconds. Failure to comply may result in equipment or property damage.

PACCAR engines are designed to operate at full throttle under momentary conditions down to peak torque engine speed. This is consistent with recommended operating practices.

### CAUTION

Operating the engine beyond the maximum engine speed can cause severe engine damage. Use proper operating techniques for the vehicle to prevent engine overspeed. The maximum engine speed specification is listed in the "General Engine Specifications" on page 5-12. Failure to comply may result in equipment or property damage.

### NOTE

For applications with high idle time, to help reduce soot loading in the aftertreatment system, avoid long periods of idling. If idling is required increase idle speed using the cruise control function.

### Engine Braking System

**WARNING!**

Do not operate the engine compression brake when driving/operating your vehicle bobtail or with a loaded or unloaded trailer on road surfaces with poor traction (wet, icy, or snow covered roads) or in heavy traffic. Braking caused by the normal operation of the engine compression brake could cause you to lose control of the vehicle resulting in an injury accident. Failure to comply may result in death, personal injury, equipment or property damage.

**WARNING!**

The service brakes must be used in an emergency. The engine compression brake alone might not stop the vehicle fast enough to prevent an accident. The engine compression brake is NOT intended as the primary brake for the vehicle, nor is it an emergency brake. The engine compression brake only helps the service brakes by using engine backpressure to slow the drivetrain. Use the service brakes for quick stops. You could be seriously injured if you relied only on the engine compression brake to stop the vehicle in an emergency. Failure to comply may result in death, personal injury, equipment or property damage.

**WARNING!**

Do not use the compression brake when operating on road surfaces with poor traction (such as wet, icy, or snow covered roads or gravel). Compression brakes can cause the wheels to skid on a slippery surface. You could lose control of the vehicle and/or jackknife if the wheels begin to skid, resulting in an accident. Failure to comply may result in death, personal injury, equipment or property damage.

**NOTE**

If your vehicle is equipped with anti-lock brakes (ABS), operation of the compression brake (if turned ON) may be interrupted if the ABS system detects wheel slip due to operation on slippery surfaces.

## Operating Instructions

3

An engine compression brake is standard on the PACCAR MX-13 engine. When activated, the engine compression brake creates a braking effect on the drive wheels. This device uses engine power to slow the vehicle down. Because it can help keep your vehicle's brakes from overheating, it can save wear and tear on the service brakes. However, the engine compression brake is not an emergency brake.

Ideally (on normal road surfaces), you should slow your vehicle with the compression brake (where permitted by law) and use the service brakes only for stopping completely. Operating this way will greatly prolong the life of the service brakes.

### Compression Brake

With the compression brake switch ON, the brake automatically creates its braking effect when you remove your foot from the accelerator pedal.

The brake switch is located on the accessory dash panel. It controls whether the brake is ON (ready to slow the vehicle down) or OFF (no braking action).

- Do not use the engine compression brake to slow the vehicle down when you are bobtailing or pulling an empty trailer.
- Make sure the brake is OFF before starting the engine.
- After the engine is started, warmed up, and you are ready to get under way, turn the engine compression brake switch ON for added braking effect.

i	NOTE
If your vehicle is equipped with the Eaton Vorad® system, operation of the compression brake may be automatically activated.	

## Compression Brake Controls

Two (2) switches on the dash panel control the engine compression brake. A master switch turns the system ON or OFF. A second switch, located next to the master switch, controls the braking effect. This switch allows you to choose progressively stronger braking to slow the vehicle down.

Engine compression brake controls include:

- On/Off switch.
- 3-position selector switch.
- Clutch switch.
- Throttle sensor.
- Service brake pressure switch.
- Eaton Vorad® Anti-Lock Braking System.

Engaging conditions for the engine compression brake are:

- Engine speed must be above 1,000 rpm.
- Coolant temperature must be above 59°F (15°C).

Deactivation conditions for the engine compression brake are:

- Accelerator pedal is depressed.
- Clutch pedal is depressed.
- Engine speed falls below 800 rpm.
- ABS control is active.
- Engine ECM recognizes a system problem.



### CAUTION

Operating the engine with a compression brake that will not automatically deactivate (i.e. when the dash switch is off, clutch pedal is depressed or throttle is applied) will cause severe internal engine damage. Do not operate the engine if the compression brake will not deactivate. Failure to comply may result in equipment or property damage.

## Operating Instructions

---

### Engine Compression Brake Level Switch Operation

There are 2 switches that control your vehicle's engine compression brake. One switch turns the system on/off and the second switch controls the braking level. These switches are located on the dash switch panel.

For the 3-position engine compression brake level switch, there will be 100% engine braking when the switch is in the up (HIGH) position. In the middle (MEDIUM) position, there will be 66% engine braking. In the down (LOW) position there will be 33% engine braking.

With the compression brake switch ON, the compression brake will be engaged when the service brake is applied.

If the cruise control is operated in conjunction with the compression

brake, the compression brake will engage to maintain the cruise set speed.



On/Off Switch Symbol

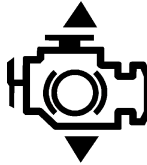

Compression Brake Level Switch Symbol



**Operating Instructions**

General Information . . . . . 4-3  
Normal Starting Procedure . . . . . 4-4  
Cold Weather Starting . . . . . 4-5  
Starting Procedure After Extended Shutdown or Oil  
Change . . . . . 4-5  
Operating the Engine . . . . . 4-6  
Engine Shutdown . . . . . 4-6  
Electromagnetic Interference (EMI) . . . . . 4-6



## Operating Instructions

### General Information

Correct care of your engine will result in longer life, better performance, and more economical operation.

Follow the daily maintenance checks listed in "Maintenance Schedule" on page 5-4.

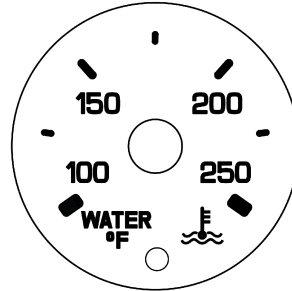
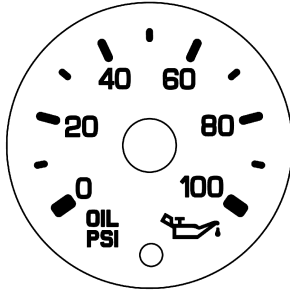

Check the engine oil pressure and engine coolant gauges, warning lights, and other gauges daily to make sure they are operational.

	<b>WARNING!</b>
<p>Combustible vapors near the air intake system could be ingested into the engine, causing the engine to suddenly accelerate and overspeed. This condition could result in operator losing control of the vehicle if an unexpected increase in engine rpm occurs. Combustible vapors could also cause a fire. Do not operate your vehicle in an area where combustible chemicals or vapors may be present. Failure to comply may result in death, personal injury, equipment or property damage.</p>	

**IT IS THE RESPONSIBILITY OF THE OWNER AND OPERATOR TO OPERATE THE VEHICLE IN A SAFE ENVIRONMENT.**

## Operating Instructions

### Normal Starting Procedure Starting

1. Ensure the parking brake is set ON and the transmission shift lever is in neutral. For automatic transmissions that have park position, place the shift lever in park.
2. With the accelerator pedal in the idle position, turn the ignition key to the START position.
3. Release the key after 10 seconds if the engine does not start. Then wait 10 seconds and try again.

4

i	NOTE
If the engine is running, do not increase engine speed (rpm) or operate the vehicle until the low oil pressure warning lamp turns off.	

⚠	CAUTION
Engaging the starter motor for more than 30 seconds in any 5 minute period may cause it to overheat and can damage the starter motor.	
<ul style="list-style-type: none"><li>• If starter is engaged continuously for 30 seconds, you must wait 5 minutes before trying to start the engine to allow the starter motor to cool down.</li></ul>	

If the engine does not start, or runs erratic, follow the procedure under “Starting After the Fuel Tank Has Run Dry”, see on page 5-30.

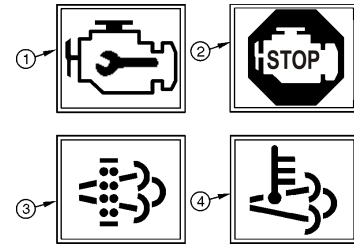

With the key in the ON position, the engine warning lamps will come on momentarily and then go out. The engine warning lamps include:

1. Check engine lamp; yellow in color.
2. STOP engine lamp; red in color.
3. Diesel Particulate Filter (DPF) status indicator; yellow in color.
4. High Exhaust System Temperature (HEST); amber in color.

### Cold Weather Starting

#### General Information

Follow the "Normal Starting Procedure" on page 4-4.

Refer to the vehicle operator's manual instructions for any additional cold weather starting procedures.

If starting a cold engine, slowly increase the engine speed. This provides adequate lubrication to the bearings and gives ample time to allow the oil pressure to stabilize.

The use of cold starting aids are not recommended for ambient temperatures above 0° F (-18° C).

If an engine must idle for an extended period of time, it should be done at a fast idle (1000 rpm maximum) at coolant temperatures below 150° F (70° C).

For coolant temperatures below 150° F (70° C), use a low gear and drive at moderate engine speed until the engine coolant has reached operating temperature. Do not let the engine idle longer than necessary.

	<b>CAUTION</b>
<p>Do not operate the engine at low idle for long periods of time when the coolant temperature is below the normal operating range. This could result in the following:</p> <ul style="list-style-type: none"> <li>• Fuel dilution of the lubricating oil</li> <li>• Carbon buildup in the cylinder</li> <li>• Sticking of the valves in the cylinder head</li> <li>• Reduced performance</li> <li>• Damage to aftertreatment components</li> </ul>	

### Starting Procedure After Extended Shutdown or Oil Change

#### General Information

Follow the "Normal Starting Procedure" on page 4-4.

# Operating Instructions

---

## Operating the Engine

### Normal

Monitor the oil pressure and coolant temperature gauges frequently. Refer to “Lubricating Oil System” and “Cooling System” for recommended operating pressures and temperatures. Shut off the engine if any pressure or temperature does not meet the specifications.

## Engine Shutdown

### Before Stopping the Engine

i	NOTE
Do not shut off the engine immediately. A hot engine stores a great amount of heat and it does not cool down immediately after it is shut off. Always cool the engine down before shutting it off. You will greatly increase its service life.	

Idle the engine at 1,000 rpm for 4 minutes. Then low idle for 30 seconds before shutdown. This will allow circulating coolant and lubricating oil to carry heat away from the cylinder head, valves, pistons, cylinder liners, turbocharger, and bearings. This way you can prevent engine damage that may result from uneven cooling.

## Electromagnetic Interference (EMI)

### General Information

If not installed correctly, some vehicle accessories (CB radios, mobile transmitters, etc.) can generate and use radio frequency energy that may cause electromagnetic interference (EMI) between the accessory and the electronic controlled fuel system. Under these conditions, PACCAR is not liable for any performance problems with either the fuel system or the accessory. EMI is not considered by PACCAR to be an engine failure and therefore is not warrantable.

### System EMI Susceptibility

PACCAR products are designed and tested for minimum sensitivity to incoming electromagnetic energy. The fuel system EMI susceptibility has been designed with a high tolerance against EMI and in most normal circumstances, if not all, electromagnetic energy-emitting devices that meet the Federal Communications Commission legal requirements should cause no interference.

### System EMI Radiation Levels

Electronic components are required to pass various PACCAR and industry EMI specifications. Our testing has shown that when the engine is properly installed and maintained, it will not interfere with properly installed onboard communication equipment.

If any interference condition is noticed, follow these suggestions to reduce the amount of EMI:

1. Locate the accessory receiving antenna further away.
2. Check with the accessory supplier representative in your area to:
  - Accurately calibrate the accessory for proper frequency, power output, and sensitivity.

- Determine the optimum antenna location by obtaining antenna reflective energy data measurements.
- Ensure that the optimum antenna type and mounting arrangement is being used.
- Ensure the accessory equipment is properly constructed for maximum filtering to reject incoming electromagnetic noise.





## Maintenance Guidelines

Overview . . . . .	5-3
Maintenance Schedule . . . . .	5-4

## Maintenance Specifications

General Engine Specifications . . . . .	5-12
Lubricating Oil System. . . . .	5-12
Cooling System. . . . .	5-13
Filter Specifications . . . . .	5-14
Fuel Recommendations . . . . .	5-14
Warranty and the Use of Biodiesel Fuel . . . . .	5-16
Lubricating Oil Recommendations and Specifications	5-17
Coolant Recommendations and Specifications . . . . .	5-18

## Maintenance Procedures

Oil Pan Drain Plug . . . . .	5-21
Inspection of the Engine Oil Level . . . . .	5-21
Topping Up the Engine Oil . . . . .	5-22
Replacing Engine Oil Filters . . . . .	5-23

Replacing Fuel Filter . . . . .	5-27
Replacing Coolant Filter . . . . .	5-31
Emergency Repairs . . . . .	5-35

# Maintenance Guidelines

## Overview

### General Information

PACCAR recommends that the engine be maintained according to the maintenance schedule in this section.

If the engine is operating in ambient temperatures below 0°F (-18°C) or above 100°F (38°C), perform maintenance at shorter intervals. Shorter maintenance intervals are also required if the engine is operated in a dusty environment or if frequent stops are made.

Some of these maintenance procedures require special tools or must be completed by qualified personnel. Contact your local PACCAR authorized repair location for detailed information.

If your engine is equipped with a component or accessory not manufactured by PACCAR Inc, refer to the component manufacturer's maintenance recommendations.

### Oil Drain Intervals

Oil drain interval recommendations are based on vehicle application or engine duty cycle. PACCAR recommends the use of high quality lubricating oil as indicated in the Lubricating Oil Recommendations in the Maintenance Specifications Section.

# Maintenance Guidelines

	Severe Duty Vocational**	Normal Duty Line Haul
<b>Fuel Consumption</b>		
<b>Miles per Gallon</b> Kilometers per Liter	<b>Less than 6 MPG</b> Less than 2.6 km/L	<b>6 MPG or greater</b> 2.6 km/L or greater
<b>Gross Vehicle Weight</b>	More than 80,000 lb More than 36,300 kg	80,000 lb or less 36,300 kg or less
<b>Oil Drain and Filter Interval</b>	<b>25,000 miles</b> /40,000 km 800 hours or 12 months	Less than 20% idle time: <b>60,000 miles</b> /96,000 km 1200 hours or 12 months More than 20% idle time: <b>40,000 miles</b> /64,000 km 1200 hours or 12 months
**Vocational vehicle applications include: Agriculture, Concrete Mixers, Construction, Crane, Dumps, Emergency/Fire, Heavy Equipment, Loggers, Mining, Oil Field, Refuse, Pick-up & Delivery, Snowplows, and Wrecker		

## Maintenance Schedule

### General Information

 NOTE
This maintenance schedule is for a Normal Duty Cycle engine operation. Severe Duty / Vocational applications will need to adjust mileage, kilometer, hour, or time interval based on the Oil Drain Interval Guidelines listed above.

 NOTE
The crankcase ventilation is good for the life of the engine.

5

Perform maintenance at whichever interval occurs first. At each scheduled maintenance interval, perform all previous maintenance checks that are due for scheduled maintenance.

### Daily or Refueling – Maintenance Check

- Engine Lubrication Oil Level - Check/Correct:  
To check engine oil level, park vehicle on level ground and wait 15 minutes after shutting off engine.
  - Remove dipstick and wipe it off with a clean, lint free rag.
  - Reinsert dipstick all the way in and pull it out again to check oil level.
  - Correct oil level is between the low (L) and high (H) marks on the dipstick.
- Engine Fuel Filter / Water Separator – Automatic water drain, no maintenance required
- Chassis Fuel Filter / Water Separator – Drain trapped water (if equipped)
- Air Intake Piping – Inspect:
  - Hose/Pipe condition – deterioration/signs of leaking
  - Hose clamps for tightness
  - Clearance to other components
  - **Check Air Restriction Gauge**
- Aftertreatment Exhaust Piping – Inspect:
  - Cracks
  - Clearance to other components (i.e. electrical harnesses, etc.)
  - Hose/pipe condition – deterioration/signs of leaking
- Cooling Fan – Inspect:
  - Cracks
  - Clearance to other components

## Maintenance Guidelines

---

- Engine Coolant Level – Check/Correct:  
With the engine off and temperature cool:

- Check coolant level. It should be visible through the clear plastic surge tank.
- Add coolant as necessary by removing the pressure cap on the neck of the surge tank or sight glass.
- Replacement or top up coolant should have the same antifreeze concentration and corrosion inhibitor content as the original coolant in the cooling system.
- Always dilute antifreeze to the correct concentration based on freeze protection before adding it to the cooling system. Adding or using 100% antifreeze in a cooling system

may result in cooling system plugging and overheating problems.

- Diesel Exhaust Fluid (DEF) Level – Check/Top Up:

	NOTE
It is recommended to top up DEF when refueling. See Engine Aftertreatment Systems Operator's Manual for DEF information.	

- **Check for any signs of fluid leaks**
- Ensure all access caps/covers are installed and tight.

## Maintenance Schedule

Maintenance Interval	Miles	Kilometers	Hours	Months
<b>Maintenance Schedule – Normal Duty/Line Haul</b>				
A	30,000	48,000	900	6
B	60,000	96,000	1,800	12
C	120,000	190,000	3,600	24
D	180,000	290,000	4,500	24
E	240,000	380,000	5,400	24
F	300,000	480,000	6,750	24
G	480,000	770,000	13,500	48 (4 years)
H	750,000	1,200,000	12,000	48 (4 years)
<b>Maintenance Schedule – Severe Duty/Vocational</b>				
A	12,500	20,000	400	6
B	25,000	40,000	800	12
C	40,000	64,000	1,280	24
D	160,000	256,000	5,120	24
E	200,000	320,000	6,400	24
F	300,000	480,000	9,000	24
G	480,000	770,000	13,500	48 (4 years)
H	750,000	1,200,000	12,000	48 (4 years)

# Maintenance Guidelines

Perform maintenance at whichever interval occurs first. At each scheduled maintenance interval, perform all previous maintenance checks that are due for scheduled maintenance.

## Recommended Preventative Maintenance Interval

Component	Maintenance Task	Recommended Preventative Maintenance Interval							
		A	B	C	D	E	F	G	H
Aftertreatment System	<ul style="list-style-type: none"> <li>Aftertreatment Diesel Particulate Filter (DPF) – Clean using DPF cleaning machine.</li> </ul>								
	<div style="border: 1px solid black; padding: 5px; display: inline-block;"> <b>i</b> </div> <p style="text-align: center;"><b>NOTE</b></p> <p>The aftertreatment DPF clean/replace interval is based on the use of lubricating oils that meet the SAE 10W30 API CJ-4 oil specification.</p>					•			
	<ul style="list-style-type: none"> <li>Aftertreatment Diesel Exhaust Fluid (DEF) Dosing Unit (DEF Module) Filter – Replace</li> </ul>						•		
Air System & Compressor	<ul style="list-style-type: none"> <li>Air Compressor – Check/Correct for carbon buildup</li> </ul>	•							
	<ul style="list-style-type: none"> <li>Air Cleaner – Check/Correct for restriction:                             <ul style="list-style-type: none"> <li>Service filter element when air cleaner restriction gauge (option) locks in the extreme high position.</li> <li>Hose/pipe condition – deterioration/ signs of leaking</li> <li>Hose clamp torque</li> </ul> </li> </ul>	•							



## Maintenance Guidelines

Component	Maintenance Task	Recommended Preventative Maintenance Interval								
		A	B	C	D	E	F	G	H	
Charge Air System	Charge Air Piping – Check/Correct: <ul style="list-style-type: none"> <li>• Hose/pipe condition – deterioration/signs of leaking</li> <li>• Hose clamps for tightness</li> <li>• Clearance to other components</li> </ul>	•								
	Charge Air Cooler – Check/Correct: <ul style="list-style-type: none"> <li>• Cracked tubes or header</li> <li>• Clogged fins/tubes</li> <li>• Hose/pipe condition – deterioration/signs of leaking</li> <li>• Hose clamp torque</li> </ul>	•								
Charging / Cranking System	Electrical Harness/Cables – Check: <ul style="list-style-type: none"> <li>• Inspect for loose connections, corrosion, chafing, and broken retention clips.</li> </ul>	•								
	Batteries, Cables, and Connections – Check: <ul style="list-style-type: none"> <li>• Condition – electrolyte level, cracks, signs of leaking, overcharging</li> <li>• Hold-downs – Tightness</li> <li>• Battery Box Mounting Bolt – Torque</li> </ul>		•							
Cooling System	Antifreeze – Check <ul style="list-style-type: none"> <li>• Coolant composition</li> <li>• Coolant level</li> <li>• Coolant protection</li> </ul>	•								
	Radiator Hoses – Check <ul style="list-style-type: none"> <li>• Hose condition, deterioration/signs of leaking</li> <li>• Hose clamp torque</li> </ul>			•						
	<ul style="list-style-type: none"> <li>• Replace Coolant Filter</li> </ul>				•					
	<ul style="list-style-type: none"> <li>• Change Extended Life Coolant*</li> </ul> See Extended Life Coolant on page 5-18.								•	

# Maintenance Guidelines

Component	Maintenance Task	Recommended Preventative Maintenance Interval							
		A	B	C	D	E	F	G	H
Crankshaft	Vibration Damper – Check: <ul style="list-style-type: none"> <li>Inspect for cracks, nicks, leakage</li> <li>Check fastener torque</li> </ul>			.					
Drive Belts	Belts – Check/Correct: <ul style="list-style-type: none"> <li>Condition, signs of wear/ deterioration</li> <li>Alignment</li> </ul>		.						
	Fan Belt Tensioner – Check/Correct: <ul style="list-style-type: none"> <li>Mounting bolt torque</li> <li>Tensioner maintains proper belt tension</li> </ul>		.						
	Poly-v Belts – Replace							.	
Engine Lubrication – Line Haul	Filters and Oil – Change: <ul style="list-style-type: none"> <li>Oil filters</li> <li>Oil, less than 20% idle time – every 60,000 mi (96,000 km)</li> <li>Oil, greater than 20% idle time – every 40,000 mi (64,000 km)</li> </ul>		.						
Engine Lubrication – Severe Duty	Filters and Oil – Change: <ul style="list-style-type: none"> <li>Oil filters</li> <li>Oil, every 25,000 mi (40,000 km; 800 hours or 12 months)</li> </ul>		.						
Fuel System	• Fuel Filter, Canister and Spin-on Type – Replace		.						
Mounting Bolts	Engine Mounting Bolts – Visual check			.					
Valves – Initial Service	Valve Clearance: <ul style="list-style-type: none"> <li>Inspect and adjust if necessary</li> <li>Valve cover gasket seal – Replace</li> </ul> (Next required service interval: D)		.						
Valves	Valve Clearance: <ul style="list-style-type: none"> <li>Adjust</li> <li>Valve cover gasket seal – Replace</li> </ul>			.					

## Maintenance Guidelines

Component	Maintenance Task	Recommended Preventative Maintenance Interval							
		A	B	C	D	E	F	G	H
<p>* <b>Extended Life Coolant</b> A heavy-duty extended life coolant (ELC) that meets ASTM D 6210 chemical composition specifications must be used. The change interval is 750,000 miles (1,200,000 km) or 12,000 hours on-road use (8 years or 15,000 hours off-highway use) on initial fill with no extender added. The change interval is 1,000,000 miles (1,600,000 km)/20,000 hours/8 years with an extender addition at 500,000 miles (800,000 km)/10,000 hours/4 years. Antifreeze is essential for freeze, overheat, and corrosion protection. The use of supplemental coolant additives (SCAs) is not recommended.</p>									
<p><b>i</b> NOTE</p>									
<p>Follow the manufacturers' recommended maintenance procedures for the starter, alternator, batteries, electrical components, radiator, air compressor, air cleaner, refrigerant compressor, and fan clutch.</p>									

## Maintenance Specifications

---

### Maintenance Specifications

#### General Engine Specifications

Horsepower	See EPA label on top of the valve cover or on the mixer manifold. See EPA label on page 6-5.
Firing Order	1, 5, 3, 6, 2, 4
Crankshaft Rotation (viewed from front of engine)	Clockwise
Displacement	784 CID (12.9 liters)
Bore and Stroke	5.12 in. (130 mm) × 6.38 in. (162 mm)
Dry Weight (excludes Flywheel and Air Compressor)	2,600 lb. (1,179 kg.)
Idle Speed	Approximately 650 rpm
Maximum Loaded Engine Speed	1,900 rpm
Maximum Governed No-Load Engine Speed	2,200 rpm
Maximum Engine Compression Brake Speed	2,100 rpm

5

#### Lubricating Oil System

Oil Pressure	At Low Idle (minimum allowable)	27 psi (187 kPa) at 191°F (88°C) oil temperature
	At Road Speed 900-1,900 rpm (minimum allowable)	40 psi (276 kPa) at 215°F (102°C) oil temperature
Regulated Oil Pressure		72 psi (496 kPa) at 223°F (106°C) oil temperature
Total System Capacity (Oil Pan and New Oil Filters)		42 qt (40.0 liters)

## Cooling System

Coolant Capacity	Approximately 14 to 15 gallons (53 to 57 liters) depending on chassis model and cab/ sleeper heater options
Minimum Recommended Pressure Cap	15 psi (103 kPa)
Maximum Top Tank Coolant Temperature	111°F (44°C) above outside temperature

 <b>WARNING!</b>
<p>Coolant is toxic. Do not get the fluid in eyes. If contact with the eyes occurs, flood eyes with large amounts of water for 15 minutes. Avoid prolonged or repeated contact with skin. In case of contact, immediately wash skin with soap and water. Do not take internally. If swallowed, seek immediate medical attention. Do not induce vomiting. Failure to comply may result in death, personal injury, equipment or property damage.</p>

 <b>NOTE</b>
<p>Coolant is harmful to the environment. Unused coolant must be stored as a toxic hazardous material in leakproof containers. Used coolant must be processed as industrial chemical waste. Please follow HAZMAT guidelines with both used and unused coolants.</p>

# Maintenance Specifications

## Filter Specifications

### General Information

PACCAR is not responsible for problems caused by non-genuine filters that do not meet PACCAR performance or durability requirements.

Contact your local PACCAR authorized repair location for specific part numbers.

 <b>CAUTION</b>
Use of non-genuine oil filters can cause severe engine damage.

## Fuel Recommendations

 <b>WARNING!</b>
The use of diesel fuel that has been mixed with other fuels may cause an explosion. Do not mix gasoline, alcohol, or gasohol with diesel fuel. Make sure you know your fuel source and use the recommended diesel fuel as indicated in this section of the manual. Failure to comply may result in death, personal injury, equipment or property damage.

 <b>CAUTION</b>
Dirt or water in the fuel system can cause severe damage to both the fuel pump and the fuel injectors. Due to the precise tolerances of diesel injection systems, it is extremely important that the fuel be kept clean and free of dirt or water. Know your fuel source and make sure all steps are taken for dispensing or using clean fuel in your vehicle. Failure to comply may result in equipment or property damage.

 <b>CAUTION</b>
Lighter fuel can reduce economy or possibly damage fuel system components. Lighter fuels typically do not have enough lubricity elements in the fuel to properly lubricate the fuel injection system. Be sure you follow the fuel recommendations as indicated in this section of the manual. Failure to comply may result in equipment or property damage.



### CAUTION

Using diesel fuels blended with lubricants may cause damage to your exhaust aftertreatment system. Service intervals for aftertreatment systems will be reduced. Do not use diesel fuel blended with lubricating oil in engines equipped with an aftertreatment system. Failure to comply may result in equipment or property damage.



### CAUTION

Do not use high-sulfur diesel fuel as it will damage the exhaust aftertreatment system. Also, the engine will not meet emission regulations. Use only ultra-low-sulfur diesel (ULSD) fuel. Failure to comply may result in equipment or property damage.



### CAUTION

If ultra-low-sulfur diesel fuel is not used, the engine may not meet emission regulations, and damage may occur to the exhaust aftertreatment system. The use of high-sulfur diesel fuel will damage the exhaust aftertreatment system and impact the engine emission. Ultra-low-sulfur diesel fuel is required for correct operation of the aftertreatment system. The engine has been optimized for use with an aftertreatment system to meet the 2013 U.S. Environmental Protection Agency regulations. Failure to comply may result in equipment or property damage.



### NOTE

PACCAR recommends that the cetane number of diesel fuel be a minimum of 45 for engines that are expected to operate at temperatures below 32°F (0°C) and a minimum of 42 for engines that are operated at temperatures above 32°F (0°C).

Using diesel fuel with a lower-than-recommended cetane number can cause hard starting, instability, and excessive white smoke. To maintain satisfactory operation at low ambient temperatures, it is important to specify diesel fuel of the correct cetane number.

PACCAR requires all permissible fuels to have adequate fuel lubricity. Lubricity can be determined by ASTM, specification D6079, ISO 12156, High Frequency Reciprocating Rig (HFRR) in which the fuel must have a wear scar diameter of 0.02 in. (0.5 mm) or less.

The use of Ultra-Low-Sulfur diesel fuel is required for this engine in order to meet emission regulations and to prevent damage to the engine and exhaust system. The use of other grades of diesel fuels other than Ultra-Low-Sulfur diesel fuel will be considered a use of incorrect fuel for the engine. PACCAR is not responsible for failures caused by the use of incorrect fuel, oil or catalytic reagent or by water, dirt or other contaminants in the fuel or catalytic reagent.

### Warranty and the Use of Biodiesel Fuel

PACCAR Inc approves the use of biodiesel fuel blends up to 5% by volume in diesel fuel that meets all of the following three conditions:

- The biodiesel used in the blend meets ASTM Standard D 6751 or EN 14214 specifications.
- The biodiesel used in the blend is sourced from a BQ-9000 Accredited Producer.
- The finished blend meets the fuel properties of ASTM Standard D 975 or EN 590 specifications.

The use of approved biodiesel fuel does not affect the PACCAR engine warranty. Failures caused by the use of nonapproved biodiesel fuels or other fuel additives that are of unacceptable quality or do not meet specified industry standards are not considered

as defects of parts or workmanship by PACCAR and therefore will not be covered by the PACCAR engine warranty.



## Lubricating Oil Recommendations and Specifications

### General Information

 CAUTION
Extending the oil and filter change interval beyond the recommendations will decrease the engine life due to factors such as corrosion, deposits, and wear. Engine oil filters capture dirt and remove deposits from the oil to prolong the life of internal moving components. Follow the oil and filter change intervals as recommended in this section of the manual. Failure to comply may result in equipment or property damage.

A major factor in maintaining engine performance and durability is the proper use of quality engine lubricating oils used in conjunction with the appropriate oil drain and filter change intervals. Attempting to extend the oil

and filter change interval beyond the manufacturers recommendations may decrease engine life.

 NOTE
It is the operator's responsibility to abide by these recommendations to ensure that the engine warranty does not get affected.

PACCAR recommends the use of high-quality SAE 10W30 API CJ-4 heavy-duty engine oil.

The primary PACCAR recommendation is for the use of 10W30 multigrade lubricating oil for normal operation at ambient temperatures above 5°F (-15°C). For ambient temperatures below 5°F (-15°C) SAE 5W30 may be used, provided it meets API CJ-4 oil specifications and biodiesel or biodiesel blended fuel is not used as fuel for the engine. Using a multigrade

oil helps improve engine cranking in low-temperature conditions, reduces deposit formation and increases engine durability.

### New Engine Break-In Oils

PACCAR does not approve the use of special "break-in" engine lubricating oils for new or rebuilt PACCAR engines. It is recommended to use the same lubricating oil for engine break-in that will be used during normal operation.

### Aftermarket Oil Additive Usage

PACCAR does not recommend the use of aftermarket oil additives. Today's high-quality engine lubricating oils are very sophisticated. Most oils already contain precise amounts of additives blended into the lubricating oil to meet stringent performance requirements.

These oils meet performance characteristics that conform to the lubricant industry standards and are sufficient protection when used according to the recommendations. Aftermarket lubricating oil additives are not necessary to enhance engine oil performance and may in some cases reduce the oil's capability to protect the engine.

### Coolant Recommendations and Specifications

The cooling system in your vehicle was factory filled with Extended Life Coolant (ELC) that meets or exceeds all ASTM D 6210 requirements. PACCAR recommends only using a 50/50 mixture of distilled water and ELC when cooling system service is required. A 50/50 mixture of ELC and distilled water will provide freeze protection down to -34°F (-36.7°C), which is adequate for most locations in North America. For extremely cold operating conditions, a 60/40 mixture (coolant/water ratio) can be used to provide freeze protection down to -62°F (-52.2°C).

Your engine is also equipped with a Coolant Filter designed to capture and remove harmful deposits from the cooling system to help prolong system life.



#### CAUTION

Use of non-genuine coolant filters can cause severe engine damage.

## Checking Coolant Condition

To ensure the Extended Life Coolant (ELC) in your vehicle always provides maximum freeze protection, perform the following tests:

1. Check the coolant color at every maintenance interval. It should be a bright red with no signs of debris or any oil.
2. Test the freeze point at least two times a year. A refractometer or test strips can be used to measure the protection level.
3. Keep the cooling system at full levels by topping-up using ELC pre-diluted to 50/50 blend.

## Recommended Extended Life Coolant Suppliers

Brand Name	Supplier
TRP® 	Authorized PACCAR Engine Dealer

## Cooling System Sealing Additives

 CAUTION
<p>The use of sealing additives in the cooling system can cause damage to the engine. Sealing additives can plug various areas of the radiator, EGR system and oil cooler. The plugging of the cooling system can hamper heat transfer, causing internal engine damage. Do not use sealing additives in the cooling system. The use of sealing additives can:</p> <ul style="list-style-type: none"> <li>• Build up in coolant low-flow areas.</li> <li>• Plug the radiator and oil cooler.</li> <li>• Damage the water pump seal.</li> </ul> <p>Failure to comply may result in equipment or property damage.</p>

## Maintenance Specifications

---

### Cooling System Soluble Oils



#### CAUTION

The use of soluble oils in the cooling system can cause damage to the engine. Soluble oils in the cooling system can:

- Damage heat transfer surfaces.
- Damage seals and hoses.

Failure to comply may result in equipment or property damage.

### Maintenance Procedures

#### Oil Pan Drain Plug

After draining the oil, discard the washer and replace with a new copper sealing washer, torque the bolt to 44 lb-ft (60 Nm).

#### Inspection of the Engine Oil Level

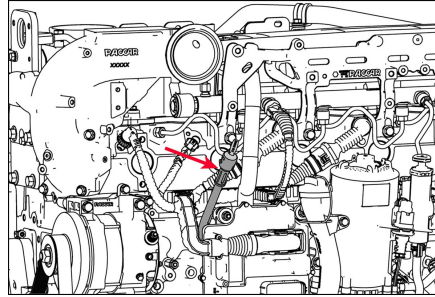

<b>i</b>	<b>NOTE</b>
It takes approximately 15 minutes for all the oil to run into the sump when the engine is 'warm.' If the level is checked immediately after switching off the engine, the dipstick will show a low oil level.	

1. Make sure that the vehicle frame rail is standing on a flat and level surface.
2. Make sure that the vehicle is horizontal, both lengthwise and crosswise. Check this carefully on a vehicle with air suspension. Note that the engine may be inclined up to 4° depending on the vehicle model and wheelbase.
3. Twist the dipstick handle to unlock it, then pull the dipstick out of the holder.
4. Wipe the dipstick clean with a lint-free cloth.
5. Place the dipstick back into the holder.
6. Pull the dipstick out again and check the oil level. The oil level should always be between the 2 marks on the dipstick.

# Maintenance Procedures

7. Reinstall the dipstick and twist to lock it in place.

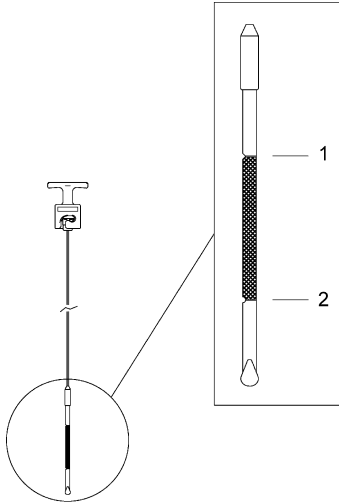

1. Engine Oil High Level
2. Engine Oil Low Level

## Topping Up the Engine Oil

1. Top up with oil, if necessary, via the filler opening. Use the correct grade in the correct quantity.
2. After topping up, wait 1 minute and check the oil level again.
3. Reinstall the oil fill cap and twist to lock it in place.

**i** **NOTE**  
PACCAR recommends the use of high-quality SAE 10W30 API CJ-4 heavy-duty engine oil.

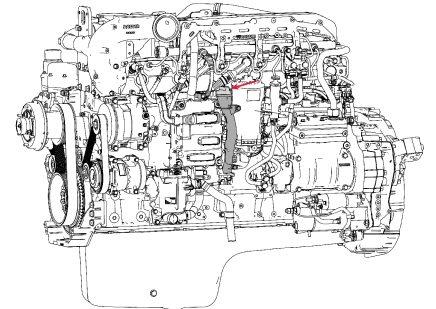
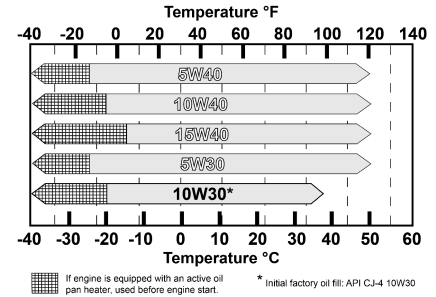

### Replacing Engine Oil Filters

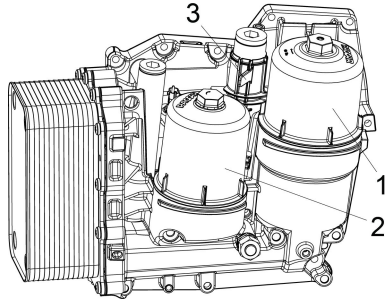

1. Full-Flow Oil Filter
2. Centrifugal Bypass Oil Filter
3. Oil Filter Cap Lock

Your engine is equipped with a full-flow oil filter and centrifugal bypass oil filter. Both filters are designed to capture contaminants and remove deposits from the oil to prolong the life of internal moving components. Always use quality engine lubricating oils in conjunction with the appropriate oil drain and filter change intervals. Refer to “Maintenance Schedule” beginning,

on page 5-4, for the recommended oil and filter change service interval.



#### CAUTION

Use of non-genuine oil filters can cause severe engine damage.

### Oil Filter Removal Preparation

1. Disconnect the chassis battery cable at the negative battery terminal.



#### CAUTION

Before beginning to remove and/or disconnect any components, wait at least 5 minutes after the key switch is turned OFF for the aftertreatment Diesel Exhaust Fluid (DEF) dosing system to purge the DEF from the system. The DEF system purges to prevent damage from freezing. Failure to comply may result in equipment or property damage.



### WARNING!

Electrical shock hazard: Never disconnect the battery clamp when the engine is running. Disconnecting the battery clamps while the engine is running may result in death, personal injury or equipment damage from electrical arcing or damage to electrical components.



### WARNING!

Turn off the engine and place the ignition switch in the OFF position before disconnecting the battery clamps. Do not place any tools or other materials on top of or close to the batteries. This can cause a dangerous high current short circuit and, in the worst case, a battery explosion. Keep all objects away from the battery terminals. Always break the contact between the battery clamp and the negative terminal before working on the vehicle. Working on a vehicle while the battery is connected may result in electrical injury or damage. Always disconnect the battery at the negative terminal when performing service procedures. Failure to comply may result in death, personal injury or equipment damage.

2. Place an oil collection pan directly under the oil filter.

### Centrifugal Bypass Oil Filter Removal

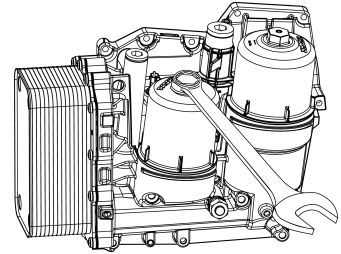

1. Remove the cap of the centrifugal oil filter. Use a hexagonal socket to avoid damaging the oil filter cap.
2. Remove the centrifugal filter.
3. Remove the O-ring from the screw cap.





### WARNING!

Lubricating oil can cause skin irritation or skin injury. To prevent skin injury, avoid unnecessary contact with the lubricating oil. Wear protective clothing, eye wear and gloves when handling lubricating oil. Failure to comply may result in personal injury.

### Centrifugal Bypass Oil Filter Installation

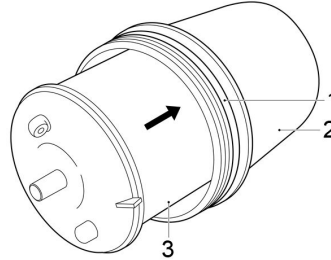

1. Lightly lubricate the O-ring (1) with engine oil.
2. Fit the new O-ring (1) onto the cap (2).
3. Mount the centrifugal filter (3) with its top side in the bearing of the screw cap (2).
4. Check to ensure the centrifugal filter (3) can rotate freely.
5. Position the screw cap carefully onto the oil module.
6. Tighten the screw cap by hand until it reaches the end position.
7. Tighten the screw cap to 354 lb-in (40 Nm). Use a hexagonal socket to avoid damaging the oil filter cap.

## Maintenance Procedures

### Full-flow Oil Filter Removal

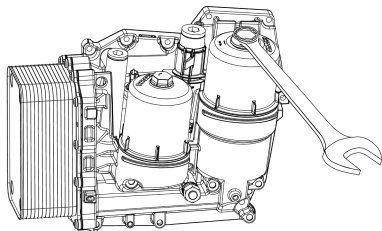

1. Unscrew the cap a few turns and drain the filter housing. Use a hexagonal socket to avoid damaging the oil filter cap.
2. Remove the cap, with the oil filter cartridge, from the filter housing. Then remove the oil filter cartridge from the screw cap.
3. Remove the O-ring from the screw cap.

	<b>WARNING!</b>
Lubricating oil can cause skin irritation or skin injury. To prevent skin injury, avoid unnecessary contact with the lubricating oil. Wear protective clothing, eye wear and gloves when handling lubricating oil. Failure to comply may result in personal injury.	

### Full-flow Oil Filter Installation

1. Lightly oil the new O-ring.
2. Install a new O-ring onto the screw cap.
3. Install the screw cap, with the oil filter cartridge, onto the filter housing. Tighten the screw cap to 354 lb-in (40 Nm). Use a hexagonal socket to avoid damaging the oil filter cap.

### After Replacing Oil Filter(s)

1. Reconnect the chassis battery cable at the negative battery terminal. See Warnings at Centrifugal oil filter removal preparation.
2. Add approved engine oil SAE 10W30 API CJ-4 to the maximum level marked on the dipstick.
3. Start and run the engine for five to ten minutes and check for any oil leaks.
4. Remove oil collection pan and dispose of any spillage properly.
5. Check engine oil level and top up as necessary.
  - chassis must be on level surface
  - wait at least five minutes if the engine has been hot

- pull the dipstick and wipe with a clean, lint free cloth
- reinsert the dipstick, then remove and check the oil level
- add approved engine oil SAE 10W30 API CJ-4 to the maximum level marked on the dipstick

### Replacing Fuel Filter



#### WARNING!

When removing the fuel filter, a quantity of fuel will escape. Do not smoke or allow an open flame in close proximity. Failure to do so could ignite a fire or cause an explosion which could result in serious injury to you and/or bystanders. Failure to comply may result in death, personal injury, equipment or property damage.



#### NOTE

The fuel filter and the hand pump are located on the left-hand side of the engine.

# Maintenance Procedures

## Description

The fuel filter / water separator module provides fine particle filtration, water separation, water in fuel sensing, automatic water draining, lifetime purification of drained water with a charcoal filter, 12v preheating and system manual priming in a singular easy to service module.

	<b>NOTE</b>
<p>The engine and fuel module should be operated in cold climates with acceptable cold climate fuel blends which noticeably reduces wax gelling of the fuel filter cartridge. The fuel module includes a 12 - volt preheater to support preheat of the fuel for initial start-up in mild climates. Failure to operate with acceptable cold climate fuel may result in insufficient fuel flow to the fuel injection system.</p>	

## Removal

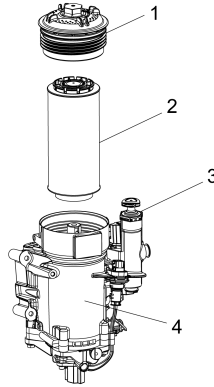

1. Fuel Filter Cap
2. Fuel Filter
3. Manual Priming Pump
4. Fuel Filter Housing

1. Loosen the fuel tank cap to relieve any pressure in the fuel tank.
2. Clean the fuel filter cap and surrounding area to ensure dirt does not fall in to the fuel module.



## CAUTION

Dirt in the fuel system can lead to significant damage to the fuel system. Failure to comply may result in equipment or property damage.

3. Remove the fuel filter cap by rotating it counter-clockwise with a wrench, automatic draining of fuel will be initiated, wait 5 minutes for complete fuel draining to prevent fuel from leaking or dripping on the starter motor



## NOTE

The fuel filter cartridge is a disposable filter and may not be cleaned and reused. Dispose of the filter as chemical waste.

4. Remove the fuel filter cartridge.

### Installation

1. Verify the sealing o-ring that is supplied with the filter kit is installed on the fuel filter cap and lightly coat the o-ring with fuel.
2. Install the new fuel filter cartridge to the cap, then insert in to the fuel module.
3. Tighten the fuel filter cap by rotating it clockwise until the filter cap o-ring makes contact with the fuel module. Then tighten the filter cap to 29 ft-lbs (40 Nm) as specified on the filter cap.

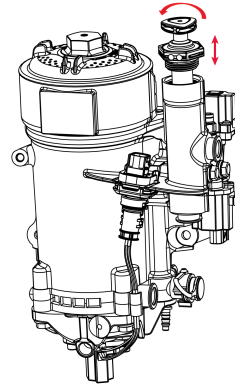

4. Loosen the fuel priming pump knob by rotating it counter-clockwise.
5. Operate the priming pump by moving the knob in and out until pumping resistance increases noticeably, may require up to 90 strokes. Then tighten the knob by rotating it clockwise.



#### CAUTION

Operate priming pump at a maximum rate of 30 strokes per minute to prevent damage to pump.

6. Check for leakage at the fuel filter cap. Tighten if necessary.



#### WARNING!

Check the fuel filter for signs of leakage. Do not smoke or allow an open flame in close proximity. Failure to do so could ignite a fire or cause an explosion which could result in serious injury to you and/or bystanders. Failure to comply may result in death, personal injury, equipment or property damage.

7. Start the engine and run it at idle speed for several minutes. This will allow any air in the system to escape. Check the system for leakage while idling. Then turn the engine off and check the system again for leakage.

## Maintenance Procedures

- If the engine does not start, or runs erratic, follow the procedure under “Starting After the Fuel Tank Has Run Dry”.

### Starting After the Fuel Tank Has Run Dry

 **CAUTION**

The following instructions should only be used in emergency situations when the fuel tank has run dry. Failure to follow the starting instructions below may damage the starter motor.

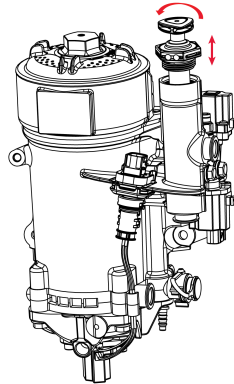

1. Loosen the fuel primer pump knob by rotating it counter-clockwise.

2. Operate the primer pump by moving the knob in and out until pumping resistance increases noticeably. Then tighten the knob by rotating it clockwise.
3. Operate the starter motor until the engine starts.

 **NOTE**

The maximum time the starter motor can be switched on at any given time is 30 seconds.

 **CAUTION**

Engaging the starter motor for more than 30 seconds in any 5 minute period may cause it to overheat and can damage the starter motor.

- If starter is engaged continuously for 30 seconds, you must wait 5 minutes before trying to start the engine to allow the starter motor to cool down.

4. If the engine does not start within this time, allow the starter motor to cool down for at least 5 minutes before repeating the procedure.

 <b>WARNING!</b>
Do not loosen any fuel line fittings in order to bleed the fuel system of air. The system is under high pressure which, when relieved, could cause death, personal injury, equipment or property damage.

## Replacing Coolant Filter

Your engine may be equipped with a Coolant Filter designed to capture and remove harmful deposits from the cooling system to help prolong system life. Refer to the “Maintenance Schedule” beginning for the recommended coolant filter change service interval.

 <b>WARNING!</b>
Do not remove the radiator cap on a hot engine. It can cause scalding coolant to spray out and you could be burned. If the engine has been operated within the last 30 minutes, be very careful in removing the radiator cap. Failure to comply may result in death, personal injury, equipment or property damage.
<ul style="list-style-type: none"><li>• Protect face, hands, and arms against escaping fluid and steam by covering the cap with a large, thick rag.</li></ul>

 <b>WARNING!</b>
Handle coolant and antifreeze carefully. Ethylene glycol antifreeze is poisonous. Store in original fluid container only, and always keep out of the reach of children. Failure to comply may result in death, personal injury, equipment or property damage.
<ul style="list-style-type: none"><li>• Also, never remove the cap on the surge tank while the engine is still hot. Wait until the coolant temperature is below 120°F (50°C). Scalding steam and fluid under pressure may escape and cause serious personal injuries.</li></ul>

# Maintenance Procedures

## Removal

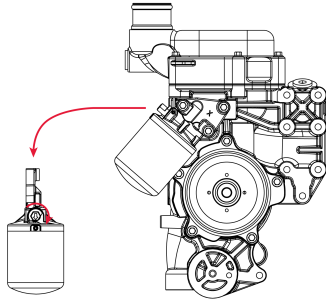

1. Slowly loosen the radiator cap to relieve any pressure in the cooling system.
2. Close the coolant filter shutoff valve by rotating the hex key clockwise and away from the “O” position.
3. Clean the coolant filter and surrounding area.

4. Remove the coolant filter by rotating it counter-clockwise. Use a filter wrench to remove.
  - A small amount of coolant could leak out when the filter is loosened. Use a suitable container to catch any drips.

	<b>NOTE</b>
The coolant filter cartridge is a disposable filter and may not be cleaned and reused. Dispose of the filter as chemical waste.	

5. Remove the O-ring from the coolant filter housing, if it has not been removed already.

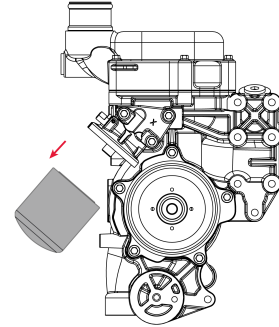



## Installation

1. Apply a small amount of coolant to the sealing ring of the new coolant filter.
2. Install the filter, rotating it clockwise until the sealing ring makes contact with the filter housing. Then tighten by hand  $\frac{1}{2}$  -  $\frac{3}{4}$  of a revolution.
3. Turn the shutoff valve to the Open position.
4. Reinstall the radiator cap.
5. Start the engine and run at idle speed for several minutes. Check for leaks.

## Radiator Fill Procedure

	<b>CAUTION</b>
Follow the procedure below to fill coolant. Failure to follow this procedure and maintain proper coolant level can cause engine damage.	

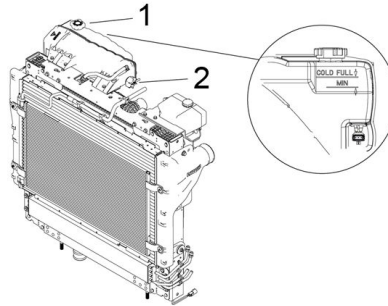

1. Remove the surge tank fill cap (1). Do not remove the surge tank pressure cap (2).

2. Fill the system with premixed coolant through the surge tank fill neck.
3. Start the engine and idle at low RPM for 2 minutes.
4. Top-off surge tank to base of filler neck while idling.
5. Run engine at higher idle until engine fan turns on and allow thermostat to open.
6. Reduce idle to low RPM and top off surge tank to base of filler neck.
7. Run engine a higher idle for 10 minutes.
8. Reduce idle to allow RPM and top off surge tank to base of filler neck.
9. Allow engine to cool and top off surge tank to base of filler neck if necessary.
10. Replace the surge tank fill cap.

## Maintenance Procedures

---

i	NOTE
If the coolant frequently needs topping up or there are any signs of coolant leakage, consult a PACCAR Service dealer.	

## Emergency Repairs

### Replacing Belts

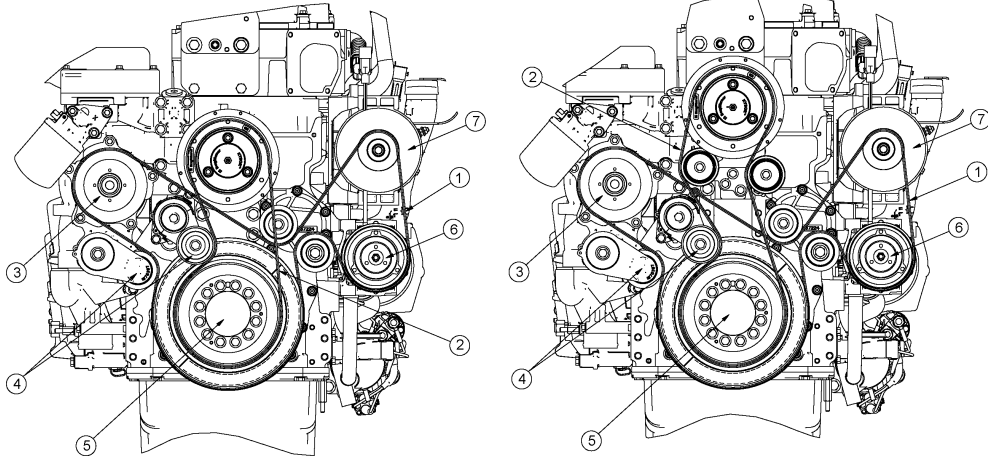

- 1. Accessory Belt
- 2. Fan Belt
- 3. Water Pump

- 4. Tensioners
- 5. Engine Dampener
- 6. A/C Compressor

- 7. Alternator

	<b>NOTE</b>
<b>Always fit the same type of belts as the ones replaced.</b>	

# Maintenance Procedures

## Poly V-belt and Fan Drive Removal

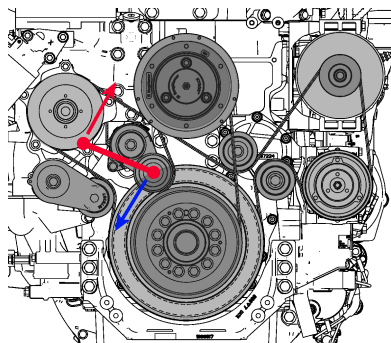

5

1. Disconnect the electrical ground wire from the battery.
2. Reach between the fan blades and remove the fan blade mounting bolts using a 9/16" socket to remove the mounting nuts.
3. Place a flex-bar with a 15-mm socket on the automatic belt tensioner roller fastener as shown.

Rotate the flex-bar as shown in the diagram to relieve belt tension.

4. With the belt tensioner pressure relieved, remove the poly V-belt from the pulleys.
  - The tensioner can be temporarily blocked with a 0.16-0.2 inch (4-5 mm) thick pin (bore). This facilitates removal and installation of the poly V-belt.
5. After removing the belt, carefully allow the belt tensioner to spring back to the stop (if it had not been temporarily blocked).
6. Inspect the pulleys for damage, rust, and grease deposits. Clean or replace as necessary.

### Installation

1. Place the new poly V-belt over the pulleys, making certain the belt falls into all the belt pulley grooves.

i	NOTE
When installing the belts do not wrap belt around the tensioner until after the belt has been wrapped around all other pulleys and idlers.	

2. After installing the belt, carefully allow the belt tensioner to spring back to its normal position. If the tensioner had been temporarily blocked, relieve tensioner pressure enough to remove the locking pin, then allow the tensioner to spring back to its normal position.

i	NOTE
Do not reuse nylon patch lock nuts. Replace with new lock nuts when re-installing parts.	

3. Reinstall fan blade using fan blade bolts and new 9/16" nylon patch lock nuts.

4. Reconnect the electrical ground wire to the battery.

### **Poly V-belt, Alternator, Air-Conditioning Compressor Drive and Coolant Pump Drive Removal**

1. Remove the poly V-belt from the fan and coolant pump drive as described in “Poly V-belt and Fan Drive” “Removal”.

	<b>NOTE</b>
Removing the fan blade is not necessary if only the accessory belt is removed. After removing the fan drive belt from its pulleys the accessory belt can be removed over the fan blade.	

2. Next, place a flex-bar with a 15 mm socket on the alternator and air conditioning compressor drive belt tensioner roller fastener as shown. Move the bar in the direction shown to relieve pressure on the belt tensioner.

3. With the belt tensioner pressure relieved, remove the poly V-belt from the pulleys.
  - The tensioner can be temporarily blocked with a 0.16-0.2 inch (4-5 mm) thick pin (bore). This facilitates removal and installation of the poly V-belt.
4. After removing the belt, carefully allow the belt tensioner to spring back to the stop (if it had not been temporarily blocked).
5. Inspect the pulleys for damage, rust and grease deposits. Clean or replace as necessary.

## Maintenance Procedures

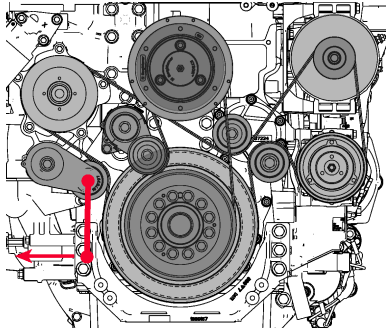

### Installation

1. Place the new poly V-belt over the pulleys, positioning the new belt so that it falls into all the belt pulley grooves.

2. After installing the belt, carefully allow the belt tensioner to spring back to its normal position. If the tensioner had been temporarily blocked, relieve tensioner pressure enough to remove the locking pin, then allow the tensioner to spring back to its normal position.
3. Reinstall the fan drive poly V-belt as previously described in "Poly V-belt and Fan Drive" "Installation".
4. Reconnect the electrical ground wire to the battery.

### Cleaning the Engine

When cleaning the engine, follow the instructions from the vehicle manufacturer Operator's Manual and observe all environmental protection regulations.



### CAUTION

Do not direct water onto electrical components, plug connectors, seals or flexible hoses on the engine. Water may enter the part causing electrical damage or contaminating oil. To prevent damage to engine components, keep the water moving at all times while cleaning the engine. Failure to comply may result in equipment damage.

	<b>NOTE</b>
When installing the belts do not wrap belt around the tensioner until after the belt has been wrapped around all other pulleys and idlers.	

**Engine Identification**

Engine Component Locations . . . . . 6-3  
EPA Label . . . . . 6-5

**Warranty**

United States and Canada PACCAR MX-13 Engine  
Coverage . . . . . 6-6  
United States and Canada Fire Apparatus Truck  
Applications Coverage . . . . . 6-11  
Emission Warranty . . . . . 6-15  
California Emission Control System Warranty,  
On-Highway . . . . . 6-18





## Engine Identification

### Engine Component Locations

1. Coolant Filter
2. Full-flow Oil Filter
3. Centrifugal Bypass Oil Filter
4. Oil Cooler
5. Turbocharger

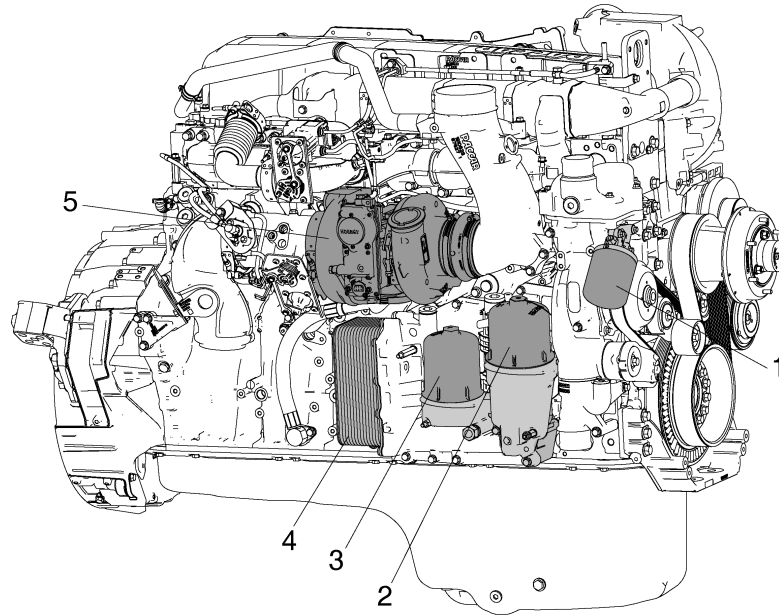

Right Side of Engine

# Engine Identification

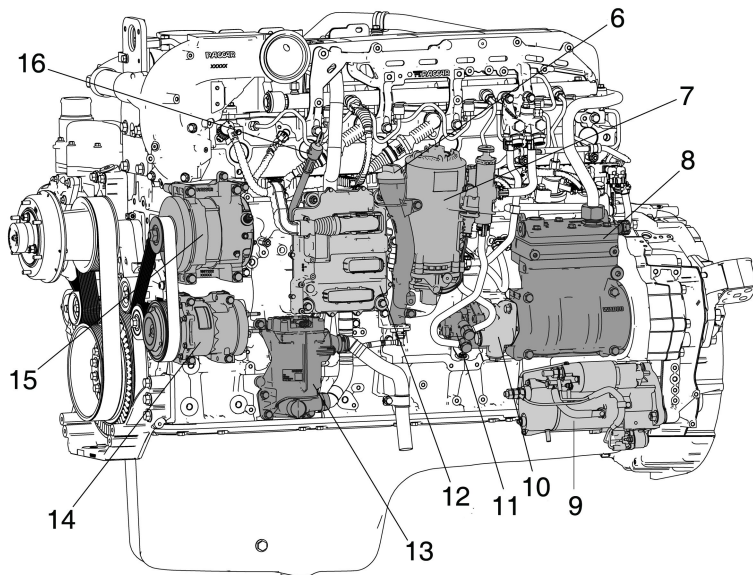

## 6

### Left Side of Engine

- |                   |                                     |                    |
|-------------------|-------------------------------------|--------------------|
| 6. Oil Fill       | 10. Power Steering Pump             | 14. A/C Compressor |
| 7. Fuel Filter    | 11. Low Pressure Fuel Pump          | 15. Alternator     |
| 8. Air Compressor | 12. Electronic Control Module (ECM) | 16. Dipstick       |
| 9. Starter        | 13. Crankcase Vent                  |                    |

## EPA Label

The EPA label provides important facts about the engine. The EPA label is located on top of the engine valve cover or on the mixer manifold. The engine EPA label must not be changed unless approved by PACCAR.

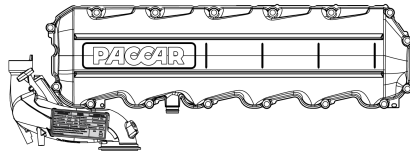

The EPA label provides many details regarding the engine. Some facts that are found on the EPA label include the following:

- Fuel rate
- Idle speed
- Maximum rated speed
- Valve lash
- Maximum power rating
- Date of manufacture
- Engine displacement

## EPA Label Location

IMPORTANT ENGINE INFORMATION		Engine No.		PACCAR MX-13 MANUFACTURED BY PACCAR	
Fuel Rate at Adv. HP	XXX.X mm <sup>3</sup> /stroke	Idle Speed	XXX - XXX	RPM	
Max. Rated Speed	XXXX RPM	Valve Lash (mm)	X.XX int.	X.XX exh.	
Max. Advert. kW/hp	XXXXXX kW/hp	Max. Initial Timing	Electronic		
Family	EPCR112.9M01	Date of Mfg.	Displacement 12.9 L.		
This engine conforms to U.S. EPA regulations and is applicable to 2014 Model Year New Heavy-Duty Engines. This Engine has a primary intended service application as a heavy heavy-duty engine. This engine is certified to operate on ultra-low sulfur diesel fuel only. Exhaust Emission Control System: DDI, TC, CAC, ECM, EGR-C, OC, SCR-U, PTOX.				STD	EPA
				NOx	X.XX
				PM	X.XX
				1952313	

### Warranty

#### **United States and Canada PACCAR MX-13 Engine Coverage Products Warranted**

This warranty applies to new PACCAR MX-13 Engines sold and used in the United States or Canada and operated in on-highway applications with one exception – there is different warranty coverage for engines used in the fire apparatus truck applications.

The PACCAR MX-13 Engine is warranted directly to the first purchaser or first lessee by PACCAR.

#### **Base Engine Warranty**

This warranty covers any failures of the Engine which result, under normal use and service, from a defect in material or factory workmanship (Warrantable Failure). This coverage begins on the date of delivery and ends two years or 250,000 miles (400,000 kilometers) or 6,250 hours, whichever occurs first, after the date of delivery of the Engine to the first purchaser or first lessee.

Additional coverage is outlined in the Emission Warranty section.

#### **Major Engine Components Warranty**

There is an Engine Warranty period of 60 months, 500,000 miles (800,000 kilometers) or 12,500 hours, whichever occurs first, after the date of delivery of the Engine to the first purchaser or first lessee for the following Engine parts:

- Cylinder Block Casting
- Main Bearing Bolts
- Cylinder Head Casting
- Cylinder Head Bolts
- Crankshaft
- Camshaft
- Cam Follower Assemblies
- Connecting Rod Assemblies
- Crankshaft Gear
- Camshaft Gear
- Camshaft Idler Gear

- Lube Pump Gear
- Flywheel Housing
- Water Pump Housing
- Thermostat Housing

## **PACCAR Responsibilities**

PACCAR will pay for all parts and labor needed to repair the damage to the Engine resulting from a Warrantable Failure.

PACCAR will pay for the lubricating oil, antifreeze, filter elements, belts, hoses, and other maintenance items that are not reusable due to the Warrantable Failure. PACCAR will pay for reasonable labor costs for Engine removal and reinstallation when necessary to repair a Warrantable Failure.

PACCAR will pay during the base engine warranty period of two years or 250,000 miles (400,000 kilometers) or 6,250 hours, whichever occurs first. Reasonable costs for towing a vehicle disabled by a Warrantable Failure to the nearest authorized repair station. In lieu of the towing expense and in its sole discretion, PACCAR may

pay reasonable costs for a mechanic to travel to and from the location of the vehicle when an engine repair is performed at the site of the failure.

# Warranty

---

## Owner Responsibilities

Owner is responsible for the operation and maintenance of the Engine as specified in the applicable PACCAR Operator's Manual. Owner is also responsible for providing proof that all recommended maintenance has been performed.

Before the expiration of the applicable warranty, Owner must notify a PACCAR authorized engine dealer of any Warrantable Failure and make the engine available for repair by such facility. The Warrantable Failure must be brought to the attention of a PACCAR authorized engine dealer within 30 days of discovery. Owner must also deliver the Engine to the authorized engine repair facility during the warranty period unless delivery is impossible because the Engine has been disabled by a Warrantable failure.

Owner is responsible for the cost of lubricating oil, antifreeze, filter elements and other maintenance items provided during warranty repairs unless such items are not reusable due to the Warrantable Failure. Owner is responsible for communication expenses, meals, lodging and similar costs incurred as a result of a Warrantable Failure.

Owner is responsible for non-Engine repairs and for "downtime" expenses, cargo damage, fines, all applicable taxes, all business costs and other losses resulting from a Warrantable Failure.

## Limitations

Your sole and exclusive remedy against PACCAR and the Selling Dealer arising from your purchase and use of this Engine is limited to the repair or replacement of "warrantable failures" at authorized United States and Canadian PACCAR Engine Dealers, or an authorized PACCAR Engine facility where applicable, subject to PACCAR's time, mileage, and hour limitations of the engine warranty. The maximum time, mileage and hour limitations of the engine warranty begin running on the Date of Delivery to the first purchaser or first lessee. The accrued time, mileage, or hours is calculated when the engine is brought into an Authorized Dealer for correction of warrantable failures.

PACCAR is not responsible for failures or damage resulting from what PACCAR determines to be abuse or neglect, including, but not

limited to: damage due to accident; operation without adequate coolants or lubricants; overfueling; overspeeding; lack of maintenance of lubricating, cooling or intake systems; improper storage, starting, warm-up, run-in or shutdown practices; unauthorized modifications of the Engine. PACCAR is also not responsible for failures caused by incorrect oil or fuel or diesel exhaust fluid or by water, dirt or other contaminants in the fuel, oil, or diesel exhaust fluid. Failure of replacement parts used in repairs due to the above non-warrantable conditions is not warrantable.

This warranty does not apply to accessories supplied by the vehicle OEM which are covered by the OEM vehicle warranty.

Failures resulting in excessive oil consumption are covered for the duration of the coverage or 250,000 miles (400,000 kilometers) or 6,250

hours from the date of delivery of the Engine to the first purchaser or first lessee, whichever occurs first. Before a claim for excessive oil consumption will be considered, Owner must submit adequate documentation to show that consumption exceeds PACCAR published standards.

Failures of belts and hoses supplied by PACCAR are covered for the first year from the date of delivery of the Engine to the first purchaser or first lessee.

PACCAR does not warrant antifreeze, lubricants, filters, filter elements, or any other part which is considered a maintenance item.

Parts used to repair a Warrantable Failure may be new parts, approved rebuilt parts, or repaired parts. PACCAR is not responsible for failures resulting from the use of parts not approved by PACCAR. A new approved or rebuilt part used to repair

a Warrantable Failure assumes the identity of the part it replaced and is entitled to the remaining coverage hereunder.

PACCAR is not responsible for damage or loss resulting from Engine horsepower/torque upgrades.

PACCAR reserves the right to interrogate Electronic Control Module (ECM) data for purposes of failure analysis.

**PACCAR DOES NOT COVER WEAR OR WEAROUT OF COVERED PARTS.**

**THIS WARRANTY AND THE EMISSION WARRANTY SET FORTH HEREINAFTER ARE THE SOLE WARRANTIES MADE BY PACCAR IN REGARD TO THESE ENGINES.**

**THIS LIMITED WARRANTY IS THE SOLE WARRANTY MADE**

## Warranty

---

**BY PACCAR AND THE SELLING DEALER. EXCEPT FOR THE ABOVE LIMITED WARRANTY, PACCAR AND THE SELLING DEALER MAKE NO OTHER WARRANTIES, EXPRESS OR IMPLIED. PACCAR AND THE SELLING DEALER EXPRESSLY DISCLAIM ANY WARRANTY OF MERCHANTABILITY OR WARRANTY OF FITNESS FOR A PARTICULAR PURPOSE.**

**PACCAR AND THE SELLING DEALER SHALL NOT BE LIABLE FOR INCIDENTAL OR CONSEQUENTIAL DAMAGES INCLUDING, BUT NOT LIMITED TO: LOSS OF INCOME OR LOST PROFITS; ENGINE OR VEHICLE DOWNTIME; THIRD PARTY DAMAGE, INCLUDING DAMAGE OR LOSS TO OTHER ENGINES, VEHICLES OR PROPERTY, ATTACHMENTS, TRAILERS AND CARGO; LOSS OR DAMAGE TO PERSONAL CONTENTS;**

**COMMUNICATION EXPENSES; LODGING AND/OR MEAL EXPENSES; FINES; APPLICABLE TAXES OR BUSINESS COSTS OR LOSSES; ATTORNEYS' FEES; AND ANY LIABILITY YOU MAY HAVE IN RESPECT TO ANY OTHER PERSON OR ENTITY.**

This warranty gives you specific legal rights, and you may also have other rights which vary from state to state.



### **United States and Canada Fire Apparatus Truck Applications Coverage Products Warranted**

This warranty applies to new PACCAR MX-13 Engines sold and used in the United States or Canada and operated in fire apparatus truck applications.

#### **Base Engine Warranty**

The Base Engine Warranty covers any failures of the Engine which result, under normal use and service, from a defect in material or factory workmanship (Warrantable Failure). This coverage begins on the date of delivery to the first purchaser or first lessee and ends after five years or 100,000 miles (160,000 kilometers), whichever occurs first.

Additional coverage is outlined in the Emission Warranty section.

#### **PACCAR Responsibilities**

PACCAR will pay for all parts and labor needed to repair the damage to the Engine resulting from a Warrantable Failure.

PACCAR will pay for the lubricating oil, antifreeze, filter elements, belts, hoses and other maintenance items that are not reusable due to the Warrantable Failure. PACCAR will pay for reasonable labor costs for Engine removal and reinstallation when necessary to repair a Warrantable Failure.

PACCAR will pay reasonable costs for towing a vehicle disabled by a Warrantable Failure to the nearest authorized repair location. In lieu of the towing expense and at its sole discretion, PACCAR will pay reasonable costs for a mechanic to travel to and from the location of

## Warranty

---

the vehicle when its engine repair is performed at the site of the failure.

### **Owner Responsibilities**

Owner is responsible for the operation and maintenance of the Engine as specified in PACCAR Operator's Manual. Owner is also responsible for providing proof that all recommended maintenance has been performed.

Before the expiration of the applicable warranty, Owner must notify a PACCAR authorized engine dealer of any Warrantable Failure and make the engine available for repair by such facility. The Warrantable Failure must be brought to the attention of a PACCAR authorized engine dealer within 30 days of discovery. Except for Engines disabled by a Warrantable Failure, Owner must also deliver the Engine to the repair facility.

Owner is responsible for the cost of lubricating oil, antifreeze, filter elements and other maintenance items provided during warranty repairs

unless such items are not reusable due to the Warrantable Failure.

Owner is responsible for communication expenses, meals, lodging and similar costs incurred as a result of a Warrantable Failure.

Owner is responsible for non-Engine repairs and for downtime expenses, cargo damage, fines, all applicable taxes, all business costs and other losses resulting from a Warrantable Failure.

Owner is responsible for a \$100 (U.S. Dollars) deductible per each service visit under this plan in the 3rd, 4th, and 5th years of base engine warranty. The deductible will not be charged during the first two years of the base engine warranty.

## Limitations

Your sole and exclusive remedy against PACCAR and the Selling Dealer arising from your purchase and use of this Engine is limited to the repair or replacement of “warrantable failures” at authorized United States and Canadian PACCAR Engine Dealers, or an authorized PACCAR Engine facility where applicable, subject to PACCAR’s time, mileage, and hour limitations of the engine warranty. The maximum time, mileage and hour limitations of the engine warranty begin running on the Date of Delivery to the first purchaser or first lessee. The accrued time, mileage, or hours is calculated when the engine is brought into an Authorized Dealer for correction of warrantable failures.

PACCAR is not responsible for failures or damage resulting from what PACCAR determines to be abuse or neglect, including but not

limited to: damage due to accident; operation without adequate coolants or lubricants; overfueling; overspeeding; lack of maintenance of lubricating, cooling or intake systems; improper storage, starting, warm-up, run-in or shutdown practices; unauthorized modifications of the Engine. PACCAR is also not responsible for failures caused by incorrect oil, fuel or diesel exhaust fluid or by water, dirt or other contaminants in the fuel, oil or diesel exhaust fluid. Failure of replacement parts used in repairs due to the above non-warrantable conditions is not warrantable.

This warranty does not apply to accessories supplied by PACCAR which are covered by the OEM vehicle warranty.

Failures resulting in excessive oil consumption are not covered beyond the duration of the coverage or 100,000 miles (160,000 kilometers) or 6,250

hours from the date of delivery of the Engine to the first purchaser or first lessee, whichever occurs first. Before a claim for excessive oil consumption will be considered, Owner must submit adequate documentation to show that consumption exceeds PACCAR published standards.

Failures of belts and hoses supplied by PACCAR are not covered beyond the first year from the date of delivery of the Engine to the first purchaser or first lessee.

PACCAR does not warrant antifreeze, lubricants, filters, filter elements, or any other part which is considered a maintenance item.

Parts used to repair a Warrantable Failure may be new parts, approved rebuilt parts, or repaired parts. PACCAR is not responsible for failures resulting from the use of parts not approved by PACCAR. A new or

## Warranty

---

approved rebuilt part used to repair a Warrantable Failure assumes the identity of the part it replaced and is entitled to the remaining coverage hereunder.

PACCAR is not responsible for damage or loss resulting from Engine horsepower/torque upgrades.

PACCAR reserves the right to interrogate Electronic Control Module (ECM) data for purposes of failure analysis.

**PACCAR DOES NOT COVER WEAR OR WEAROUT OF COVERED PARTS.**

**THIS WARRANTY AND THE EMISSION WARRANTY SET FORTH HEREINAFTER ARE THE SOLE WARRANTIES MADE BY PACCAR IN REGARD TO THESE ENGINES.**

**THIS LIMITED WARRANTY IS THE SOLE WARRANTY MADE BY PACCAR AND THE SELLING DEALER. EXCEPT FOR THE ABOVE LIMITED WARRANTY, PACCAR AND THE SELLING DEALER MAKE NO OTHER WARRANTIES, EXPRESS OR IMPLIED. PACCAR AND THE SELLING DEALER EXPRESSLY DISCLAIM ANY WARRANTY OF MERCHANTABILITY OR WARRANTY OF FITNESS FOR A PARTICULAR PURPOSE.**

**PACCAR AND THE SELLING DEALER SHALL NOT BE LIABLE FOR INCIDENTAL OR CONSEQUENTIAL DAMAGES INCLUDING, BUT NOT LIMITED TO: LOSS OF INCOME OR LOST PROFITS; ENGINE OR VEHICLE DOWNTIME; THIRD PARTY DAMAGE, INCLUDING DAMAGE OR LOSS TO OTHER ENGINES, VEHICLES OR PROPERTY,**

**ATTACHMENTS, TRAILERS AND CARGO; LOSS OR DAMAGE TO PERSONAL CONTENTS; COMMUNICATION EXPENSES; LODGING AND/OR MEAL EXPENSES; FINES; APPLICABLE TAXES OR BUSINESS COSTS OR LOSSES; ATTORNEYS' FEES; AND ANY LIABILITY YOU MAY HAVE IN RESPECT TO ANY OTHER PERSON OR ENTITY.**

This warranty gives you specific legal rights, and you may also have other rights which vary from state to state.

## Emission Warranty Products Warranted

This emission warranty applies to new PACCAR Engines marketed by PACCAR that are used in the United States in vehicles designed for transporting persons or property on a street or highway.

## Coverage

PACCAR warrants to the first purchaser or first lessee and each subsequent purchaser that the Engine is designed, built and equipped so as to conform at the time of sale by PACCAR with all U.S. Federal emission regulations applicable at the time of manufacture and that it is free from defects in material or factory workmanship which would cause it not to meet these regulations within the longer of the following periods: (A) Five years or 100,000 miles (160,000 kilometers) of operation, whichever occurs first, as measured from the date of delivery of the Engine to the first purchaser or first lessee or (B) The Base Engine Warranty.

If the vehicle in which the Engine is installed is registered in the state of California, a separate California Emission Warranty also applies.

## Replacement Parts

PACCAR recommends that any service parts used for maintenance, repair or replacement of emission control systems be new or genuine approved rebuilt parts and assemblies, and that the engine be serviced by an authorized PACCAR Engine dealer. Your vehicle contains air, fuel, and electrical components that may affect engine emission controls. The use of non-genuine engine or vehicle replacement parts that are not equivalent to the PACCAR engine or OEM vehicle manufacturer's original part may impair the engine and vehicle emissions control system from working or functioning effectively, and may jeopardize your emissions warranty coverage.

## Warranty

---

### Limitations

Your sole and exclusive remedy against PACCAR and the Selling Dealer arising from your purchase and use of this Engine is limited to the repair or replacement of “warrantable failures” at authorized United States and Canadian PACCAR Engine Dealers, or an authorized PACCAR Engine facility where applicable, subject to PACCAR’s time, mileage, and hour limitations of the engine emission warranty. The maximum time, mileage and hour limitations of the engine emission warranty begin running on the Date of Delivery to the first purchaser or first lessee. The accrued time, mileage, or hours is calculated when the engine is brought into an Authorized Dealer for correction of warrantable failures.

Failures, other than those resulting from defects in material or factory workmanship, are not covered by this

Warranty. PACCAR is not responsible for failures or damage resulting from what PACCAR determines to be abuse or neglect, including, but not limited to: damage due to accident; operation without adequate coolants or lubricants; overfueling; overspeeding; lack of maintenance of lubricating, cooling or intake systems; improper storage, starting, warm-up, run-in or shutdown practices; unauthorized modifications of the Engine. PACCAR is also not responsible for failures caused by incorrect oil, fuel or diesel exhaust fluid or by water, dirt or other contaminants in the fuel, oil or diesel exhaust fluid. Failure of replacement parts used in repairs due to the above non-warrantable conditions is not warrantable.

PACCAR is not responsible for non-Engine repairs, downtime expenses, cargo damage, fines, all applicable taxes, all business costs

or other losses resulting from a Warrantable Failure.

**THIS LIMITED EMISSION WARRANTY IS THE SOLE WARRANTY MADE BY PACCAR RELATING TO THE EMISSION EQUIPMENT. EXCEPT FOR THE ABOVE LIMITED WARRANTY, PACCAR MAKES NO OTHER WARRANTIES, EXPRESS OR IMPLIED. PACCAR EXPRESSLY DISCLAIMS ANY WARRANTY OF MERCHANTABILITY OR WARRANTY OF FITNESS FOR A PARTICULAR PURPOSE.**

**PACCAR AND THE SELLING DEALER SHALL NOT BE LIABLE FOR INCIDENTAL OR CONSEQUENTIAL DAMAGES INCLUDING, BUT NOT LIMITED TO: LOSS OF INCOME OR LOST PROFITS; ENGINE OR VEHICLE DOWNTIME; THIRD PARTY DAMAGE, INCLUDING DAMAGE**

**OR LOSS TO OTHER ENGINES,  
VEHICLES OR PROPERTY,  
ATTACHMENTS, TRAILERS AND  
CARGO; LOSS OR DAMAGE  
TO PERSONAL CONTENTS;  
COMMUNICATION EXPENSES;  
LODGING AND/OR MEAL  
EXPENSES; FINES; APPLICABLE  
TAXES OR BUSINESS COSTS OR  
LOSSES; ATTORNEYS' FEES; AND  
ANY LIABILITY YOU MAY HAVE IN  
RESPECT TO ANY OTHER PERSON  
OR ENTITY.**

## Warranty

---

### **California Emission Control System Warranty, On-Highway Products Warranted**

This Emission Control System Warranty applies to diesel engines (hereafter, engines) certified with the California Air Resources Board beginning with the year 2013, marketed by PACCAR, and registered in California for use in on-highway applications.

### **Your Warranty Rights and Obligations**

The California Air Resources Board and PACCAR are pleased to explain the emission control system warranty on your 2013 and subsequent model year diesel engine. In California, new motor vehicle engines must be designed, built, and equipped to meet the State's stringent anti-smog standards. PACCAR must warrant the emission control system on your diesel engine for the periods of time listed below provided there has been no abuse, neglect or improper maintenance of your diesel engine.

Your emission control system may include parts such as the fuel injection system and engine electronic control module. Also included may be hoses, connectors and other emission related assemblies.

If an emission-related part on your engine is found to have a defect in material or factory the part will be repaired or replaced by PACCAR. This is your emission control system defects warranty.



### Manufacturer's Warranty Coverage

This warranty coverage is provided for five years or 100,000 miles (160,000 km or 3,000 hours of engine operation, whichever first occurs from the date of delivery of the engine to the first purchaser or first lessee. Where a Warrantable Condition exists, PACCAR will repair your engine at no cost to you including diagnosis, parts and labor.

### Owner's Warranty Responsibilities

As the engine owner, you are responsible for the performance of the required maintenance listed in your PACCAR Operator's Manual. You are responsible for presenting your engine to an authorized PACCAR Engine Dealer as soon as a problem exists. The warranty repairs should be completed in a reasonable amount of time, not to exceed 30 days.

PACCAR recommends that you retain all receipts covering maintenance on your engine, but PACCAR cannot deny warranty solely for the lack of receipts or for the failure to ensure the performance of all scheduled maintenance.

As the engine owner, you should also be aware that PACCAR may deny you warranty coverage if your engine or a part has failed due to abuse, neglect,

improper maintenance or unapproved modifications.

If you have any questions regarding your warranty rights and responsibilities, you should contact the vehicle OEM manufacturer at the customer center telephone number provided with your vehicle operating instructions or the California Air Resource Board at 9528 Telstar Avenue, El Monte, CA 91731.

A warranted part which is scheduled for replacement as required maintenance is warranted up to the first scheduled replacement point.

Prior to the expiration of the applicable warranty, Owner must give notice of any warranted emission control failure to an authorized PACCAR Engine dealer and deliver the engine to such facility for repair.

## Warranty

---

Owner is responsible for incidental costs such as: communication expenses, meals, lodging incurred by Owner or employees of Owner as a result of a Warrantable Condition.

Owner is responsible for downtime expenses, cargo damage, fines, all applicable taxes, all business costs, and other losses resulting from a Warrantable Condition.

### **Emissions Components Statement for PACCAR MX-13 Engine (2013) Emissions Engine Coverage**

This list of emission control parts may be covered by the Emission Control System Warranty under certain failure modes.

#### **Aftertreatment System**

- Electronic Control Unit
- Diesel Oxidation Catalyst
- Diesel Particulate Filter (DPF)
- Selective Catalytic Reduction (SCR) Catalyst
- DPF Air / Fuel Manifold Assembly
- DPF Fuel Injector including air, fuel, and coolant lines
- DPF Fuel Pressure Sensor
- DPF Air Supply Pressure Sensor

- Pressure protection valve and plumbing to DPF Fuel Injector
- DPF Temperature Sensors and Signal Conditioner
- DPF Pressure Sensors
- SCR Temperature Sensor
- NOx Sensor
- NH3 Sensor
- Decomposition Pipe and Pipe Elbows
- Exhaust piping from turbocharger to last aftertreatment device

#### **Diesel Exhaust Fluid (DEF) System**

- DEF Tank, Heater, and associated plumbing
- DEF Pump Module and associated plumbing

- DEF Dosing Module with Injection Nozzle and wiring harness
- DEF Level/Temperature Sensor
- DEF Lines and Heating elements
- DEF Line Heater Control Relay
- DEF Tank Heater Coolant Control Valve

## Dash Lamp

- DEF Lamp
- Malfunction Indicator Lamp (MIL)

## Crankcase Ventilation System

- Crankcase Ventilation Separator and associated plumbing

## Intake System

- Air Intake Pipe Mixer
- Pressure/Temperature/Humidity Sensor before Turbocharger

- Charge Air Cooler and associated plumbing
- Turbocharger and associated plumbing

## Electronic Control System

- Engine Control Module
- Coolant Temperature Sensor
- Intake Manifold Pressure and Temperature Sensor
- Turbocharger Speed Sensor
- Exhaust Gas Recirculation (EGR) Temperature Sensor
- Camshaft Speed Sensor
- Crankshaft Speed Sensor
- NOx Sensor
- Ambient Temperature Sensor
- Lambda Sensor

- Exhaust Manifold Pressure Sensor
- Temperature after Turbocharger
- Vehicle Speed Sensor
- Engine Oil Temperature Sensor
- Water Pump Speed Sensor
- Fuel Pressure Sensor
- Fuel Temperature Sensor
- Pressure Sensor after Exhaust Throttle Valve
- Wiring harnesses connected at both ends to emission warranty components

## Exhaust Gas Recirculation System (EGR)

- EGR Valve and associated plumbing
- EGR Cooler and associated plumbing

## Warranty

---

### Engine

- Exhaust Manifold
- Exhaust Throttle Valve and plumbing

### Fueling System

- Injectors
- Fuel Pumps and associated engine plumbing

### Replacement Parts

PACCAR recommends that any service parts used for maintenance, repair or replacement of emission control systems be new or genuine approved rebuilt parts and assemblies, and that the engine be serviced by an authorized PACCAR Engine dealer. Your vehicle contains air, fuel, and electrical components that may affect engine emission controls. The use of non-genuine engine or vehicle replacement parts that are not equivalent to the PACCAR engine or OEM vehicle manufacturer's original part may impair the engine and vehicle emissions control system from working or functioning effectively, and may jeopardize your emissions warranty coverage.

The owner may elect to have maintenance, replacement or repair of the emission control parts performed by a facility other than an authorized

PACCAR Engine dealer and may elect to use parts other than new or genuine approved rebuilt parts and assemblies for such maintenance, replacement or repair; however, the cost of such service or parts and subsequent failures resulting from such service or parts will not be covered under this emission control system warranty, except for Emergency Repairs as described below.

## PACCAR Responsibilities

The warranty coverage begins when the engine is delivered to the first purchaser or first lessee. Repairs and service will be performed by any authorized PACCAR Engine dealer using new or genuine approved rebuilt parts and assemblies. PACCAR will repair any of the emission control parts found by PACCAR to be defective without charge for parts or labor (including diagnosis which results in determination that there has been a failure of a warranted emission control part).

## Emergency Repairs

In the case of an emergency where an authorized PACCAR Engine dealer is not available, repairs may be performed by any available repair location or by any individual using any replacement parts. A part not being available within 30 days or a repair not being complete within 30 days constitutes an emergency. PACCAR will reimburse the Owner for expenses (including diagnosis), not to exceed the manufacturers suggested retail price for all warranted parts replaced and labor charges based on the manufacturers recommended time allowance for the warranty repair and the geographically appropriate hourly labor rate. Replaced parts and paid invoices must be presented at an authorized PACCAR Engine dealer as a condition of reimbursement for emergency repairs not performed by an authorized PACCAR Engine dealer.

## Warranty Limitations

Your sole and exclusive remedy against PACCAR and the Selling Dealer arising from your purchase and use of this Engine is limited to the repair or replacement of “warrantable failures” at authorized United States and Canadian PACCAR Engine Dealers, or an authorized PACCAR Engine facility where applicable, subject to PACCAR’s time, mileage, and hour limitations of the engine emission warranty. The maximum time, mileage and hour limitations of the engine emission warranty begin running on the Date of Delivery to the first purchaser or first lessee. The accrued time, mileage, or hours is calculated when the engine is brought into an Authorized Dealer for correction of warrantable failures.

PACCAR is not responsible for failures or damage resulting from what PACCAR determines to be

## Warranty

---

abuse or neglect, including, but not limited to: damage due to accident; operation without adequate coolants or lubricants; overfueling; overspeeding; lack of maintenance of cooling, lubricating or intake systems; improper storage, starting, warm-up, run-in or shutdown practices; unauthorized modifications to the engine. PACCAR is also not responsible for failures caused by incorrect oil, fuel or diesel exhaust fluid or by water, dirt or other contaminants in the fuel, oil or diesel exhaust fluid. Failure of replacement parts used in repairs due to the above non-warrantable conditions is not warrantable.

PACCAR is not responsible for failures resulting from improper repair or the use of parts which are not genuine approved parts.

PACCAR is not responsible for the material and labor costs of emission control parts and assemblies replaced

during Scheduled Maintenance of the engine as specified in PACCAR Operator's Manuals.

**THIS WARRANTY, TOGETHER WITH THE EXPRESS COMMERCIAL WARRANTIES MADE BY PACCAR IN REGARD TO THESE ENGINES.**

**THIS LIMITED EMISSIONS WARRANTY IS THE SOLE WARRANTY MADE BY PACCAR AND THE SELLING DEALER. EXCEPT FOR THE ABOVE LIMITED WARRANTY, PACCAR AND THE SELLING DEALER MAKE NO OTHER WARRANTIES, EXPRESS OR IMPLIED. PACCAR AND THE SELLING DEALER EXPRESSLY DISCLAIM ANY WARRANTY OF MERCHANTABILITY OR WARRANTY OF FITNESS FOR A PARTICULAR PURPOSE.**

**PACCAR AND THE SELLING DEALER SHALL NOT BE LIABLE FOR INCIDENTAL OR CONSEQUENTIAL DAMAGES INCLUDING, BUT NOT LIMITED TO: LOSS OF INCOME OR LOST PROFITS; ENGINE OR VEHICLE DOWNTIME; THIRD PARTY DAMAGE, INCLUDING DAMAGE OR LOSS TO OTHER ENGINES, VEHICLES OR PROPERTY, ATTACHMENTS, TRAILERS AND CARGO; LOSS OR DAMAGE TO PERSONAL CONTENTS; COMMUNICATION EXPENSES; LODGING AND/OR MEAL EXPENSES; FINES; APPLICABLE TAXES OR BUSINESS COSTS OR LOSSES; ATTORNEYS' FEES; AND ANY LIABILITY YOU MAY HAVE IN RESPECT TO ANY OTHER PERSON OR ENTITY.**

# Index

- A**
- A/C Compressor ..... 6-4, 5-35
  - Accessory Belt ..... 5-35
  - Aftermarket Oil Additive Usage... 5-18
  - Aftertreatment Diesel Particulate Filter (DPF) ..... 5-8
  - Aftertreatment Exhaust Piping ..... 5-5
  - Aftertreatment System ..... 5-8
  - Air Cleaner ..... 5-8
  - Air Compressor ..... 6-4, 5-8
  - Air Intake Piping ..... 5-5
  - Air System & Compressor ..... 5-8
  - Alternator ..... 6-4, 5-35
  - Antifreeze ..... 5-9
- B**
- Batteries ..... 5-9
  - Belts ..... 5-10
  - Biodiesel Fuel
    - warranty and the use of biodiesel fuel ..... 5-16
  - Bore and Stroke ..... 5-12
  - Braking System, Engine ..... 3-7
  - Break-In Oils ..... 5-17
- C**
- Cables ..... 5-9
  - Centrifugal Bypass Oil Filter ..... 6-3
    - Installation ..... 5-25
    - Removal ..... 5-24
  - Charge Air Cooler ..... 5-9
  - Charge Air Piping ..... 5-9
  - Charge Air System ..... 5-9
  - Charging / Cranking System ..... 5-9
  - Chassis Fuel Filter / Water Separator ..... 5-5
  - Check Engine Lamp ..... 3-3, 2-5
  - Cold Weather Starting ..... 4-5
  - Compression Brake ..... 3-8
  - Coolant Capacity ..... 5-13
  - Coolant Filter ..... 6-3, 5-9, 5-31
  - Coolant Recommendations and Specifications
    - checking coolant condition ..... 5-19
    - cooling system sealing additives ..... 5-19
    - cooling system soluble oils ..... 5-20
    - recommended extended life coolant suppliers ..... 5-19
  - Cooling Fan ..... 5-5
  - Cooling System ..... 5-9, 5-13
  - Cooling System Sealing Additives ..... 5-19
  - Cooling System Soluble Oils ..... 5-20
  - Crankcase Vent ..... 6-4
  - Crankshaft ..... 5-10
  - Crankshaft Rotation ..... 5-12
- D**
- Diesel Exhaust Fluid (DEF) Lamp .. 3-6
  - Diesel Exhaust Fluid (DEF) Level .. 5-6
  - Diesel Particulate Filter (DPF)

## Index

---

engine warning lamps.....3-5  
Diesel Particulate Filter (DPF) Warning  
Lamp.....3-5  
Dipstick ..... 6-4, 5-21  
Displacement..... 5-12  
Drive Belts.....5-10, 5-35  
Dry Weight..... 5-12

## E

Electrical Harness/Cables.....5-9  
Electromagnetic Interference (EMI)  
general information.....4-6  
system EMI radiation levels .....4-7  
system EMI susceptibility .....4-7  
Electronic Control Module (ECM) ..6-4  
Emergency Repairs  
poly v-belt and fan drive ..... 5-36  
poly v-belt, alternator,  
air-conditioning compressor  
drive and coolant pump  
drive ..... 5-37  
replacing belts ..... 5-35  
EMI.....4-6  
Engine Braking System .....3-7  
compression brake.....3-8

compression brake controls .....3-9  
engine compression brake level  
switch operation ..... 3-10  
Engine Component Locations .....6-3  
Engine Compression Brake Level  
Switch..... 3-10  
Engine Coolant Gauge .....4-3  
Engine Coolant Level.....5-6  
Engine Dampener ..... 5-35  
Engine Fuel Filter / Water  
Separator.....5-5  
Engine Identification  
engine component locations .....6-3  
EPA label.....6-5  
Engine is Overheating.....2-5  
Engine Lubrication..... 5-10  
Engine Mounting Bolts ..... 5-10  
Engine Oil Level.....5-21  
Engine Oil Pressure Gauge.....2-4  
Engine Oil Pressure Lamp Turns  
On.....2-4  
Engine Operating Range.....3-6  
general information.....3-6  
Engine Shutdown .....4-6  
before stopping the engine .....4-6  
Engine Warning Lamps ..... 3-3-4-4

check engine lamp ..... 3-3-4-4  
check engine lamp (CEL).....3-5  
diesel exhaust fluid (DEF) lamp..3-6  
diesel particulate filter (DPF) warning  
lamp ..... 4-4-3-5  
general information.....3-3  
high exhaust system temperature  
(HEST) warning lamp.. 4-4-3-5  
stop engine lamp .....4-4  
EPA Label .....6-5

## F

Fan Belt..... 5-35  
Fan Belt Tensioner..... 5-10  
Fast Idle .....4-5  
Filter...6-3-5-5, 6-7-5-14, 5-17-5-18,  
5-23-5-29, 5-31-5-32  
coolant filter.....5-9  
filter part numbers.....1-6  
Filter Specifications..... 5-14  
general information..... 5-14  
Firing Order..... 5-12  
Fuel Consumption .....5-4  
Fuel Filter..... 6-4, 5-10, 5-27  
Fuel Priming..... 5-29



Fuel Recommendations ..... 5-14  
 Fuel System ..... 5-10  
 Full-flow Oil Filter ..... 6-3  
     installation..... 5-26  
     removal..... 5-26

**G**

General Engine Specifications.... 5-12  
 General Safety Instructions ..... 1-7  
 Gross Vehicle Weight..... 5-4

**H**

High Exhaust System Temperature  
 (HEST) Warning Lamp ..... 3-5  
 Horsepower ..... 5-12

**I**

Idle .... 3-3–2-7, 5-10, 5-12, 5-29, 5-33  
 Idle Speed ..... 5-12  
 Important Reference Number..... 1-6  
 Inspection of the Engine Oil Level 5-21

**L**

Lamp  
     check engine..... 3-3, 2-5  
     check engine lamp (CEL)..... 3-5  
     diesel exhaust fluid (DEF) lamp.. 3-6  
     diesel particulate filter..... 3-5  
     high exhaust system temperature  
         (HEST) warning ..... 3-5  
     stop engine ..... 2-3–3-4  
 Low Pressure Fuel Pump ..... 6-4  
 Lubricating Oil Recommendations and  
     Specifications ..... 5-17  
 Lubricating Oil System ..... 5-12

**M**

Maintenance  
     maintenance schedule..... 5-7  
     recommended preventative  
         maintenance interval..... 5-8  
 Maintenance Guidelines..... 5-3  
 Maintenance Procedures  
     inspection of the engine oil level 5-21  
     replacing coolant filter..... 5-31  
     replacing engine oil filters ..... 5-23  
     replacing fuel filter..... 5-27

starting after the fuel tank has run  
     dry ..... 5-30  
     topping up the engine oil ..... 5-22  
 Maintenance Schedule ..... 5-7  
     daily or refueling – maintenance  
         check..... 5-5  
     general information..... 5-4  
     oil drain intervals ..... 5-3  
 Maintenance Specifications  
     coolant recommendations and  
         specifications ..... 5-18  
     cooling system..... 5-13  
     engine specifications..... 5-12  
     filter specifications..... 5-14  
     fuel recommendations and  
         specifications ..... 5-14  
     lubricating oil recommendations and  
         specifications ..... 5-17  
     lubricating oil system..... 5-12  
 Maximum Engine Compression Brake  
     Speed..... 5-12  
 Maximum Governed No-Load Engine  
     Speed..... 5-12  
 Maximum Loaded Engine Speed. 5-12  
 Mounting Bolts ..... 5-10

## Index

---

- N**
- New Engine Break-In Oils..... 5-17
  - Normal Starting Procedure.....4-4
- O**
- Oil Additive ..... 5-18
  - Oil Capacity ..... 5-12
  - Oil Cooler ..... 6-3
  - Oil Drain Intervals.....5-3
  - Oil Fill ..... 6-4, 5-22
  - Oil Filter.....5-10, 5-23
  - Oil Level ..... 5-5
  - Oil Pan Drain Plug ..... 5-21
  - Oil Pressure ..... 2-4, 5-12
  - Oil Pressure Gauge..... 4-3–2-4
  - Operating Instructions
    - cold weather starting ..... 4-5
    - general information.....4-3
    - normal starting procedure ..... 4-4
    - operating the engine ..... 4-6
    - starting procedure after extended shutdown or oil change..... 4-5
  - Operating Range.....3-6
  - Operating the Engine.....4-6
  - Overheating .....2-5
- P**
- Poly V-belt and Fan Drive ..... 5-36
  - Power Steering Pump .....6-4
  - Pulleys ..... 5-36
- R**
- Radiator Hoses.....5-9
  - Recommended Extended Life Coolant Suppliers ..... 5-19
  - Recommended Preventative Maintenance Interval ..... 5-8
  - Replacing Belts ..... 5-35
  - Replacing Engine Oil Filters ..... 5-23
- S**
- Safety
    - general safety instructions..... 1-7
    - illustrations ..... 1-7
    - safety alerts ..... 1-3
  - Starter.....6-4
  - Starting After the Fuel Tank Has Run Dry ..... 5-30
  - Starting Procedure After Extended Shutdown or Oil Change.....4-5
- T**
- Stop Engine Lamp ..... 2-3–3-4
  - System EMI Radiation Levels ..... 4-7
  - System EMI Susceptibility ..... 4-7
- T**
- Tensioners ..... 5-35
  - Topping Up the Engine Oil ..... 5-22
  - Turbocharger ..... 6-3
- V**
- Valve Clearance..... 5-10
  - Valves ..... 5-10
  - Vibration Damper ..... 5-10
- W**
- Warranty
    - California emission control system warranty - on-highway ..... 6-18
    - emission warranty..... 6-15
    - PACCAR MX-13 engine - United States and Canada coverage ..... 6-6

United States and Canada fire  
apparatus truck applications  
coverage ..... 6-11

Water Pump ..... 5-35

What to do if.....2-3

    check engine lamp turns on .....2-5

    engine is overheating .....2-5

    engine oil pressure lamp turns  
    on.....2-4

    stop engine lamp turns on .....2-3

    you need roadside assistance ...2-3





**PACCAR**<sup>Inc</sup>

**Engines**

P.O. Box 1518

Bellevue, WA 98009

Y53-1181-1B1