

Discount Codes

046	PVC Schedule 40 Molded Reinforced Fittings	
049	PVC Hot-Tap Saddles	
050	CPVC Hot-Tap Saddles	
086	PVC Schedule 80 Molded Reinforced Fittings	
096	CPVC Schedule 80 Molded Reinforced Fittings	

PVC & CPVC Hot-Tap Saddles and Clamp Saddles



Visit our web site:
www.spearsmfg.com

See Spears® On-line Catalog for most current pricing, updated daily.

PRICE SCHEDULE SDL-1-0308A

Effective March 26, 2008

Supersedes: SDL-1-0308



Quality Systems Certificate No. 293
 Corporate Facilities, Sylmar, CA
 Assessed to ISO 9001: 2000

2008 EDITION



PVC/CPVC Clamp-On & Hot-Tap Saddles

HOW TO USE THIS CATALOG

Spears® PVC & CPVC Hot-Tap Saddles and Clamp Saddles catalog has been arranged for easy use in selection of desired products according to part number, size, packaging and pricing information. A complete listing of content is located at the end of this catalog. Additional information on individual product dimensions can be found in Spears® publications 80-4, PVC Schedule 80 Fittings, Unions, Class 150 Flanges, Tank Adapters, Expansion Joints & Saddles Weights & Dimensions and select data sheets for special products.

COLUMN HEADER INFORMATION

Each product column header label identifies the following product particulars:

Part Number	The number used to order the part.
Size	Nominal diameter of pipe with which the fitting is to be used. NOTE: Fittings may be same size (only one size designation) or reducing (multiple sizes designated).
Hole Saw Dia.	Standard hole saw designation to cut required hole in pipe.
Standard Pack (Std Pk)	The quantity of parts packaged in an individual box or bag.
Master Carton (Mstr Ctn)	The total quantity of parts contained in individual boxes or bags which are packaged together.
Discount Code (Disc Code)	Identification code for applicable discount to the list price of the product. NOTE: This is a Product Group code and is not a calculation of discount. Discount codes are not the same for all products contained in this price schedule.
Price Each	The designated list price of the product.

PRODUCT CONFIGURATION

Each group of saddle configuration types is headed by the product's name, an abbreviated configuration description of the fitting outlet connections, followed by O-ring elastomer and hardware material designations. Configuration descriptions are defined at the end of this catalog. Line drawing illustrations are general representations of the saddles in the group, but may not be an exact depiction of all configurations listed. The size designation always indicates size of pipe for mounting saddle x saddle branch outlet.

CONFIGURATION DESCRIPTIONS & PART INFORMATION

Definitions of abbreviated configuration descriptions and letters contained in part numbers that denote special information are indicated below:

Soc	Solvent Weld Socket (IPS)
Spig	Spigot End (IPS Pipe O.D)
SR	Special Reinforced Plastic Female Iron Pipe Thread
Soc (Spigot)	Dual connection functions as indicated socket size and spigot size in parenthesis ()
IPS	Iron Pipe Size
C	CPVC
E	EPDM O-ring
V	Viton® O-ring
S	Stainless Steel Hardware
W	PVC White

PVC/CPVC Clamp-On & Hot-Tap Saddles



Spears® Two-Piece Clamp-On Saddle Design Clamps onto Pipe for Quick and Easy Installation

O-ring seal provides positive, trouble-free sealing to pipe.

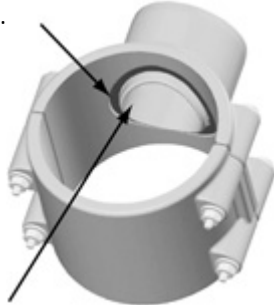

Special pilot engages with hole in pipe to prevent saddle dislocation.

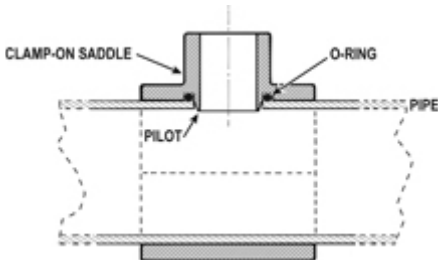

Clamp-On Saddle Installation Instructions

1. Using a standard industrial grade hole-saw, cut specified hole in desired position on pipe according to recommended hole saw size engraved on the saddle. Note: Care must be taken to deburr hole and remove all residue from hole area to assure tight fit and avoid leakage.
2. Fully seat O-ring in groove on underside of saddle outlet component. Position over hole and fully seat saddle onto pipe. Note: Certain saddle outlets are piloted. Be sure pilot lip fully engages with hole in pipe.

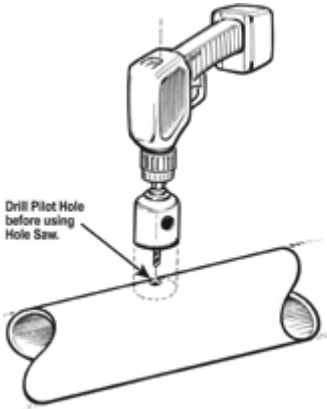

3. Place strap component opposite outlet and secure with bolts (4), nuts (4) and washers (8). Important: Washers MUST be placed under each bolt head (1) and under each nut (1) to avoid damage to saddle.
4. Tighten bolts to specified torque.

Saddle Size	2	3	4	6 & up
Recommended Bolt-Torque - ft/lb	8	8	8	10

For Double Outlet Saddle Installation — Determine second outlet hole position as shown.

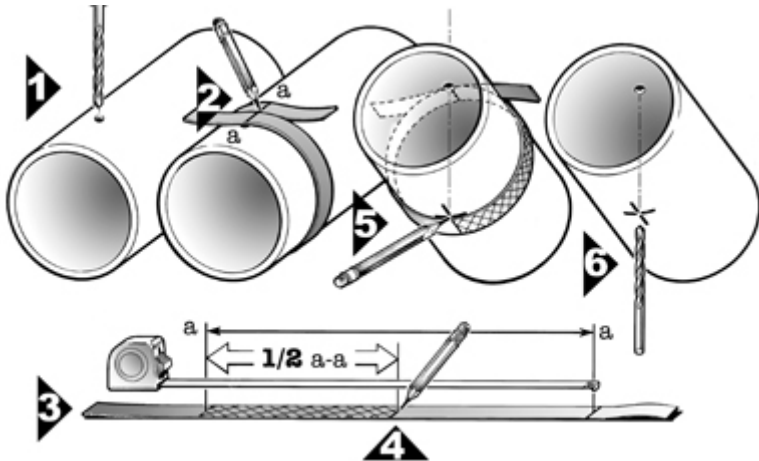

Spears® Hot-Tap Saddles Designed for Adding Branch Connections to Piping Systems Under Live ("Hot") Pressure

Hot-Tap Saddle branch outlets are either 3/4" socket (with 1" Spigot O.D.) or 1-1/2" socket (with 2" Spigot O.D.) in saddle sizes 2" through 6" to fit IPS pipe using a built-in O-ring seal. Internal cutter is operated using conventional ratchet and drive extension and permanently retains coupon cut from pipe. Maximum operating pressure at 73°F (23°C) is 235 psi for saddle sizes 2" - 4", 200 psi for 6" saddles and 150 psi for 8" saddles. See packaged Installation Instructions for details.



PVC/CPVC Clamp-On & Hot-Tap Saddles

Part Number	Size	Hole Saw Dia	Std Pk	Mstr Ctn	Disc Code	Price Each
-------------	------	--------------	--------	----------	-----------	------------

PVC White Clamp-On Saddle x Soc Single Outlet with Buna-N O-ring Seal & Zinc-Plated Hardware

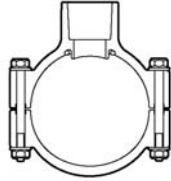

2"-4" 235, 6" 200, 8"-12" 150 psi @ 73°F (23°C)

466-247	2X1/2	3/4	1	10	046	23.87
466-248	2X3/4	7/8	1	10	046	23.87
466-249	2X1	1-1/8	1	10	046	23.87
466-250	2X1-1/4	1-1/2	1	10	046	23.87
466-251	2X1-1/2	1-1/2	1	10	046	23.87
466-291	2-1/2X1-1/2	1-3/4	1	10	046	32.37
466-333	3X1/2	7/8	1	10	046	32.37
466-334	3X3/4	7/8	1	10	046	32.37
466-335	3X1	1-1/8	1	10	046	32.37
466-336	3X1-1/4	2-1/4	1	10	046	32.37
466-337	3X1-1/2	2-1/4	1	10	046	32.37
466-338	3X2	2-1/4	1	10	046	32.37
466-415	4X1/2	1-1/8	1	10	046	41.48
466-416	4X3/4	1-1/8	1	10	046	41.48
466-417	4X1	1-1/8	1	8	046	41.48
466-418	4X1-1/4	1-3/4	1	8	046	41.48
466-419	4X1-1/2	1-3/4	1	8	046	41.48
466-420	4X2	2-1/4	1	8	046	41.48
466-421	4X2-1/2	3	1	4	046	46.93
466-422	4X3	3	1	4	046	51.56
466-523	6X1/2	1-1/8	1	4	046	71.37
466-524	6X3/4	1-1/8	1	4	046	71.37
466-525	6X1	1-1/8	1	4	046	71.37
466-526	6X1-1/4	2-1/4	1	4	046	71.37
466-527	6X1-1/2	2-1/4	1	4	046	71.37
466-528	6X2	2-1/4	1	4	046	71.37
466-529	6X2-1/2	3	1	4	046	78.47
466-530	6X3	3	1	4	046	81.76
466-532	6X4	4	1	4	046	86.08
466-573	8X1/2	4	1	0	046	110.97
466-574	8X3/4	4	1	0	046	110.97
466-575	8X1	4	1	1	046	110.97
466-576	8X1-1/4	4	1	0	046	110.97
466-577	8X1-1/2	4	1	0	046	110.97
466-578	8 X 2	4	1	1	046	110.97
466-579	8X2-1/2	4	1	0	046	122.01
466-580	8X3	4	1	0	046	129.38
466-582	8X4	4	1	1	046	137.02
466-585	8X6	6	1	1	046	152.18
466-620	10X1-1/2	4	1	0	046	181.07
466-624	10X4	4	1	1	046	181.07
466-626	10X6	6	1	1	046	208.21
466-660	12X1-1/2	4	1	1	046	226.99
466-664	12X4	4	1	1	046	226.99
466-666	12X6	6	1	1	046	263.23

¹Outlet-sized with Bushing

Part Number	Size	Hole Saw Dia	Std Pk	Mstr Ctn	Disc Code	Price Each
-------------	------	--------------	--------	----------	-----------	------------

PVC White Clamp-On Saddle x Soc Single Outlet with Buna-N O-ring Seal & SS Hardware

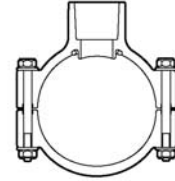

2"-4" 235, 6" 200, 8"-12" 150 psi @ 73°F (23°C)

466S-247	2X1/2	3/4	1	10	046	39.24
466S-248	2X3/4	7/8	1	10	046	39.24
466S-249	2X1	1-1/8	1	10	046	39.24
466S-250	2X1-1/4	1-1/2	1	10	046	39.24
466S-251	2X1-1/2	1-1/2	1	10	046	39.24
466S-291	2-1/2 X1-1/2	1-3/4	1	10	046	52.79
466S-333	3X1/2	7/8	1	10	046	52.79
466S-334	3X3/4	7/8	1	10	046	52.79
466S-335	3X1	1-1/8	1	10	046	52.79
466S-336	3X1-1/4	2-1/4	1	10	046	52.79
466S-337	3X1-1/2	2-1/4	1	10	046	52.79
466S-338	3X2	2-1/4	1	10	046	52.79
466S-415	4X1/2	1-1/8	1	10	046	66.41
466S-416	4X3/4	1-1/8	1	10	046	66.41
466S-417	4X1	1-1/8	1	10	046	66.41
466S-418	4X1-1/4	1-3/4	1	8	046	66.41
466S-419	4X1-1/2	1-3/4	1	8	046	66.41
466S-420	4X2	2-1/4	1	8	046	66.41
466S-421	4X2-1/2	3	1	4	046	72.57
466S-422	4X3	3	1	4	046	75.48
466S-523	6X1/2	1-1/8	1	4	046	108.78
466S-524	6X3/4	1-1/8	1	4	046	108.78
466S-525	6X1	1-1/8	1	4	046	108.78
466S-526	6X1-1/4	2-1/4	1	4	046	108.78
466S-527	6X1-1/2	2-1/4	1	4	046	108.78
466S-528	6X2	2-1/4	1	4	046	108.78
466S-529	6X2-1/2	3	1	4	046	112.36
466S-530	6X3	3	1	4	046	114.67
466S-532	6X4	4	1	4	046	119.78
466S-573	8X1/2	4	1	0	046	158.82
466S-574	8X3/4	4	1	0	046	158.82
466S-575	8X1	4	1	0	046	158.82
466S-576	8X1-1/4	4	1	0	046	158.82
466S-577	8X1-1/2	4	1	0	046	158.82
466S-578	8 X 2	4	1	0	046	158.82
466S-579	8X2-1/2	4	1	0	046	174.71
466S-580	8X3	4	1	0	046	183.46
466S-582	8X4	4	1	1	046	194.51
466S-585	8X6	6	1	1	046	215.87
466S-620	10X1-1/2	4	1	0	046	256.88
466S-624	10X4	4	1	1	046	256.88
466S-626	10X6	6	1	1	046	295.42
466S-664	12X4	4	1	1	046	322.00
466S-666	12X6	6	1	1	046	373.54

¹Outlet-sized with Bushing

PVC/CPVC Clamp-On & Hot-Tap Saddles



Part Number	Size	Hole Saw Dia	Std Pk	Mstr Ctn	Disc Code	Price Each
-------------	------	--------------	--------	----------	-----------	------------

PVC White Clamp-On Saddle x Soc Single Outlet with EPDM O-ring Seal & Zinc-Plated Hardware

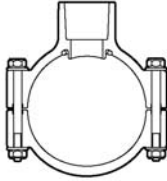

2"-4" 235, 6" 200, 8"-12" 150 psi @ 73°F (23°C)

466E-247	2X1/2	3/4	1	10	046	25.71
466E-248	2X3/4	7/8	1	10	046	25.71
466E-249	2X1	1-1/8	1	10	046	25.71
466E-250	2X1-1/4	1-1/2	1	10	046	25.71
466E-251	2X1-1/2	1-1/2	1	10	046	25.71
466E-291	2-1/2X1-1/2	1-3/4	1	10	046	33.22
466E-333	3X1/2	7/8	1	10	046	33.22
466E-334	3X3/4	7/8	1	10	046	33.22
466E-335	3X1	1-1/8	1	10	046	33.22
466E-336	3X1-1/4	2-1/4	1	10	046	33.22
466E-337	3X1-1/2	2-1/4	1	10	046	33.22
466E-338	3X2	2-1/4	1	10	046	33.22
466E-415	4X1/2	1-1/8	1	10	046	42.54
466E-416	4X3/4	1-1/8	1	10	046	42.54
466E-417	4X1	1-1/8	1	8	046	42.54
466E-418	4X1-1/4	1-3/4	1	8	046	42.54
466E-419	4X1-1/2	1-3/4	1	8	046	42.54
466E-420	4X2	2-1/4	1	8	046	42.54
466E-421	4X2-1/2	3	1	4	046	51.77
466E-422	4X3	3	1	4	046	57.91
466E-523	6X1/2	1-1/8	1	4	046	76.33
466E-524	6X3/4	1-1/8	1	4	046	76.33
466E-525	6X1	1-1/8	1	4	046	76.33
466E-526	6X1-1/4	2-1/4	1	4	046	76.33
466E-527	6X1-1/2	1-1/8	1	4	046	76.33
466E-528	6X2	2-1/4	1	4	046	76.33
466E-529	6X2-1/2	3	1	4	046	84.88
466E-530	6X3	3	1	4	046	89.67
466E-532	6X4	4	1	4	046	94.48
466E-573	8X1/2	4	1	0	046	117.32
466E-574	8X3/4	4	1	0	046	117.32
466E-575	8X1	4	1	1	046	117.32
466E-576	8X1-1/4	4	1	0	046	117.32
466E-577	8X1-1/2	4	1	0	046	117.32
466E-578	8 X 2	4	1	1	046	117.32
466E-579	8X2-1/2	4	1	0	046	129.09
466E-580	8X3	4	1	0	046	135.44
466E-582	8X4	4	1	1	046	143.68
466E-585	8X6	6	1	1	046	159.42
466E-624	10X4	4	1	1	046	189.73
466E-626	10X6	6	1	1	046	218.19
466E-664	12X4	4	1	1	046	237.81
466E-666	12X6	6	1	1	046	280.99

¹Outlet-sized with Bushing

Part Number	Size	Hole Saw Dia	Std Pk	Mstr Ctn	Disc Code	Price Each
-------------	------	--------------	--------	----------	-----------	------------

PVC White Clamp-On Saddle x Soc Single Outlet with EPDM O-ring & Seal & SS Hardware

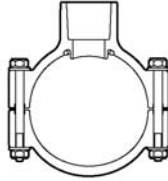

2"-4" 235, 6" 200, 8"-12" 150 psi @ 73°F (23°C)

466SE-247	2X1/2	3/4	1	10	046	40.47
466SE-248	2X3/4	7/8	1	10	046	40.47
466SE-249	2X1	1-1/8	1	10	046	40.47
466SE-250	2X1-1/4	1-1/2	1	10	046	40.47
466SE-251	2X1-1/2	1-1/2	1	10	046	40.47
466SE-291	2-1/2X1-1/2	1-3/4	1	10	046	54.43
466SE-333	3X1/2	7/8	1	10	046	54.43
466SE-334	3X3/4	7/8	1	10	046	54.43
466SE-335	3X1	1-1/8	1	10	046	54.43
466SE-336	3X1-1/4	2-1/4	1	10	046	54.43
466SE-337	3X1-1/2	2-1/4	1	10	046	54.43
466SE-338	3X2	2-1/4	1	10	046	54.43
466SE-415	4X1/2	1-1/8	1	10	046	67.20
466SE-416	4X3/4	1-1/8	1	10	046	67.20
466SE-417	4X1	1-1/8	1	8	046	67.20
466SE-418	4X1-1/4	1-3/4	1	8	046	67.20
466SE-419	4X1-1/2	1-3/4	1	8	046	67.20
466SE-420	4X2	2-1/4	1	8	046	67.20
466SE-421	4X2-1/2	3	1	4	046	72.66
466SE-422	4X3	3	1	4	046	80.49
466SE-523	6X1/2	1-1/8	1	4	046	114.33
466SE-524	6X3/4	1-1/8	1	4	046	114.33
466SE-525	6X1	1-1/8	1	4	046	114.33
466SE-526	6X1-1/4	2-1/4	1	4	046	114.33
466SE-527	6X1-1/2	1-1/8	1	4	046	114.33
466SE-528	6X2	2-1/4	1	4	046	114.33
466SE-529	6X2-1/2	3	1	4	046	120.09
466SE-530	6X3	3	1	4	046	123.86
466SE-532	6X4	4	1	4	046	129.91
466SE-573	8X1/2	4	1	0	046	166.07
466SE-574	8X3/4	4	1	0	046	166.07
466SE-575	8X1	4	1	0	046	166.07
466SE-576	8X1-1/4	4	1	0	046	166.07
466SE-577	8X1-1/2	4	1	1	046	166.07
466SE-578	8X2	4	1	0	046	166.07
466SE-579	8X2-1/2	4	1	0	046	182.67
466SE-580	8X3	4	1	0	046	191.77
466SE-582	8X4	4	1	0	046	203.23
466SE-585	8X6	6	1	0	046	225.62
466SE-624	10X4	4	1	1	046	268.43
466SE-626	10X6	6	1	1	046	308.71
466SE-664	12X4	4	1	1	046	336.44
466SE-666	12X6	4	1	1	046	390.30

¹Outlet-sized with Bushing



PVC/CPVC Clamp-On & Hot-Tap Saddles

Part Number	Size	Hole Saw Dia	Std PK	Mstr Ctn	Disc Code	Price Each
-------------	------	--------------	--------	----------	-----------	------------

PVC White Clamp-On Saddle x SR Thread Single Outlet with Buna-N O-ring Seal & Zinc-Plated Hardware

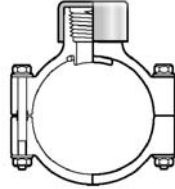

2"-4" 235, 6" 200, 8"-12" 150 psi @ 73°F (23°C)

467-247SR	2X1/2	3/4	1	10	046	26.67
467-248SR	2X3/4	7/8	1	10	046	26.67
467-249SR	2X1	1-1/8	1	10	046	26.67
467-250SR	2X1-1/4	1-1/2	1	10	046	26.67
467-251SR	2X1-1/2	1-1/2	1	10	046	26.67
467-291SR	2-1/2X1-1/2	1-3/4	1	10	046	36.47
467-333SR	3X1/2	7/8	1	10	046	36.47
467-334SR	3X3/4	7/8	1	10	046	36.47
467-335SR	3X1	1-1/8	1	10	046	36.47
467-336SR	3X1-1/4	2-1/4	1	10	046	36.47
467-337SR	3X1-1/2	2-1/4	1	10	046	36.47
467-338SR	3X2	2-1/4	1	10	046	36.47
467-415SR	4X1/2	1-1/8	1	10	046	45.92
467-416SR	4X3/4	1-1/8	1	10	046	45.92
467-417SR	4X1	1-1/8	1	8	046	45.92
467-418SR	4X1-1/4	1-3/4	1	8	046	45.92
467-419SR	4X1-1/2	1-3/4	1	8	046	45.92
467-420SR	4X2	2-1/4	1	8	046	45.92
467-421SR	4X2-1/2	3	1	4	046	49.68
467-422SR	4X3	3	1	4	046	54.16
467-523SR	6X1/2	1-1/8	1	4	046	80.19
467-524SR	6X3/4	1-1/8	1	4	046	80.19
467-525SR	6X1	1-1/8	1	4	046	80.19
467-526SR	6X1-1/4	2-1/4	1	4	046	80.19
467-527SR	6X1-1/2	2-1/4	1	4	046	80.19
467-528SR	6X2	2-1/4	1	4	046	80.19
467-529SR	6X2-1/2	3	1	4	046	94.63
467-530SR	6X3	3	1	4	046	100.68
467-532SR	6X4	4	1	4	046	104.82
467-573SR	8X1/2	4	1	0	046	122.23
467-574SR	8X3/4	4	1	0	046	122.23
467-575SR	8X1	4	1	0	046	122.23
467-576SR	8X1-1/4	4	1	0	046	122.23
467-577SR	8X1-1/2	4	1	0	046	122.23
467-578SR	8X2	4	1	0	046	122.23
467-579SR	8X2-1/2	4	1	0	046	134.42
467-580SR	8X3	4	1	0	046	141.22
467-582SR	8X4	4	1	1	046	149.67
467-585SR	8X6	6	1	0	046	164.62
467-624SR	10X4	4	1	1	046	195.96
467-626SR	10X6	6	1	1	046	225.24
467-664SR	12X4	4	1	1	046	245.47
467-666SR	12X6	6	1	1	046	284.74

¹ Outlet-sized with Bushing

Part Number	Size	Hole Saw Dia	Std PK	Mstr Ctn	Disc Code	Price Each
-------------	------	--------------	--------	----------	-----------	------------

PVC White Clamp-On Saddle x SR Thread Single Outlet with Buna-N O-ring Seal & SS Hardware

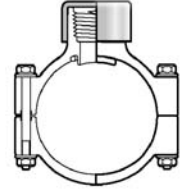

2"-4" 235, 6" 200, 8"-12" 150 psi @ 73°F (23°C)

467S-247SR	2X1/2	3/4	1	10	046	43.62
467S-248SR	2X3/4	7/8	1	10	046	43.62
467S-249SR	2X1	1-1/8	1	10	046	43.62
467S-250SR	2X1-1/4	1-1/2	1	10	046	43.62
467S-251SR	2X1-1/2	1-1/2	1	10	046	43.62
467S-291SR	2-1/2X1-1/2	1-3/4	1	10	046	58.66
467S-333SR	3X1/2	7/8	1	10	046	58.66
467S-334SR	3X3/4	7/8	1	10	046	58.66
467S-335SR	3X1	1-1/8	1	10	046	58.66
467S-336SR	3X1-1/4	2-1/4	1	10	046	58.66
467S-337SR	3X1-1/2	2-1/4	1	10	046	58.66
467S-338SR	3X2	2-1/4	1	10	046	58.66
467S-415SR	4X1/2	1-1/8	1	10	046	73.79
467S-416SR	4X3/4	1-1/8	1	10	046	73.79
467S-417SR	4X1	1-1/8	1	8	046	73.79
467S-418SR	4X1-1/4	1-3/4	1	8	046	73.79
467S-419SR	4X1-1/2	1-3/4	1	8	046	73.79
467S-420SR	4X2	2-1/4	1	8	046	73.79
467S-421SR	4X2-1/2	3	1	4	046	78.47
467S-422SR	4X3	3	1	4	046	82.87
467S-523SR	6X1/2	1-1/8	1	4	046	122.97
467S-524SR	6X3/4	1-1/8	1	4	046	122.97
467S-525SR	6X1	1-1/8	1	4	046	122.97
467S-526SR	6X1-1/4	2-1/4	1	4	046	122.97
467S-527SR	6X1-1/2	2-1/4	1	4	046	122.97
467S-528SR	6X2	2-1/4	1	4	046	122.97
467S-529SR	6X2-1/2	3	1	4	046	132.33
467S-530SR	6X3	3	1	4	046	136.21
467S-532SR	6X4	4	1	4	046	141.48
467S-573SR	8X1/2	4	1	0	046	177.10
467S-574SR	8X3/4	4	1	0	046	177.10
467S-575SR	8X1	4	1	0	046	177.10
467S-576SR	8X1-1/4	4	1	0	046	177.10
467S-577SR	8X1-1/2	4	1	0	046	177.10
467S-578SR	8X2	4	1	0	046	177.10
467S-579SR	8X2-1/2	4	1	0	046	192.33
467S-580SR	8X3	4	1	0	046	201.93
467S-582SR	8X4	4	1	1	046	214.07
467S-585SR	8X6	6	1	0	046	235.36
467S-624SR	10X4	4	1	1	046	280.13
467S-626SR	10X6	6	1	1	046	322.14
467S-664SR	12X4	4	1	1	046	351.16
467S-666SR	12X6	6	1	1	046	407.19

¹Outlet-sized with Bushing

PVC/CPVC Clamp-On & Hot-Tap Saddles



Part Number	Size	Hole Saw Dia	Std Pk	Mstr Ctn	Disc Code	Price Each
-------------	------	--------------	--------	----------	-----------	------------

PVC White Clamp-On Saddle x SR Thread Single Outlet with EPDM O-ring Seal & Zinc-Plated Hardware

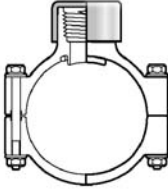

2"-4" 235, 6" 200, 8"-12" 150 psi @ 73°F (23°C)

467E-247SR	2X1/2	3/4	1	10	046	28.70
467E-248SR	2X3/4	7/8	1	10	046	28.70
467E-249SR	2X1	1-1/8	1	10	046	28.70
467E-250SR	2X1-1/4	1-1/2	1	10	046	28.70
467E-251SR	2X1-1/2	1-1/2	1	10	046	28.70
467E-291SR	2-1/2X1-1/2	1-3/4	1	10	046	40.02
467E-333SR	3X1/2	7/8	1	10	046	40.02
467E-334SR	3X3/4	7/8	1	10	046	40.02
467E-335SR	3X1	1-1/8	1	10	046	40.02
467E-336SR	3X1-1/4	2-1/4	1	10	046	40.02
467E-337SR	3X1-1/2	2-1/4	1	10	046	40.02
467E-338SR	3X2	2-1/4	1	10	046	40.02
467E-415SR	4X1/2	1-1/8	1	10	046	50.03
467E-416SR	4X3/4	1-1/8	1	10	046	50.03
467E-417SR	4X1	1-1/8	1	8	046	50.03
467E-418SR	4X1-1/4	1-3/4	1	8	046	50.03
467E-419SR	4X1-1/2	1-3/4	1	8	046	50.03
467E-420SR	4X2	2-1/4	1	8	046	50.03
467E-421SR	4X2-1/2	3	1	4	046	53.62
467E-422SR	4X3	3	1	4	046	57.48
467E-523SR	6X1/2	1-1/8	1	4	046	83.48
467E-524SR	6X3/4	1-1/8	1	4	046	83.48
467E-525SR	6X1	1-1/8	1	4	046	83.48
467E-526SR	6X1-1/4	2-1/4	1	4	046	83.48
467E-527SR	6X1-1/2	2-1/4	1	4	046	83.48
467E-528SR	6X2	2-1/4	1	4	046	83.48
467E-529SR	6X2-1/2	3	1	4	046	103.41
467E-530SR	6X3	3	1	4	046	108.79
467E-532SR	6X4	4	1	4	046	114.27
467E-573SR	8X1/2	4	1	0	046	126.48
467E-574SR	8X3/4	4	1	0	046	126.48
467E-575SR	8X1	4	1	0	046	126.48
467E-576SR	8X1-1/4	4	1	0	046	126.48
467E-577SR	8X1-1/2	4	1	0	046	126.48
467E-578SR	8X2	4	1	0	046	126.48
467E-579SR	8X2-1/2	4	1	0	046	139.12
467E-580SR	8X3	4	1	0	046	146.12
467E-582SR	8X4	4	1	1	046	154.87
467E-585SR	8X6	6	1	0	046	171.82
467E-624SR	10X4	4	1	1	046	204.46
467E-626SR	10X6	6	1	1	046	235.08
467E-664SR	12X4	4	1	1	046	256.30
467E-666SR	12X6	6	1	1	046	297.31

¹Outlet-sized with Bushing

Part Number	Size	Hole Saw Dia	Std Pk	Mstr Ctn	Disc Code	Price Each
-------------	------	--------------	--------	----------	-----------	------------

PVC White Clamp-On Saddle x SR Thread Single Outlet with EPDM O-ring Seal & SS Hardware

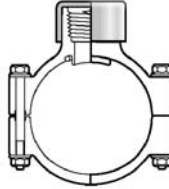

2"-4" 235, 6" 200, 8"-12" 150 psi @ 73°F (23°C)

467SE-247SR	2X1/2	3/4	1	10	046	44.92
467SE-248SR	2X3/4	7/8	1	10	046	44.92
467SE-249SR	2X1	1-1/8	1	10	046	44.92
467SE-250SR	2X1-1/4	1-1/2	1	10	046	44.92
467SE-251SR	2X1-1/2	1-1/2	1	10	046	44.92
467SE-291SR	2-1/2X1-1/2	1-3/4	1	10	046	60.29
467SE-333SR	3X1/2	7/8	1	10	046	60.29
467SE-334SR	3X3/4	7/8	1	10	046	60.29
467SE-335SR	3X1	1-1/8	1	10	046	60.29
467SE-336SR	3X1-1/4	2-1/4	1	10	046	60.29
467SE-337SR	3X1-1/2	2-1/4	1	10	046	60.29
467SE-338SR	3X2	2-1/4	1	10	046	60.29
467SE-415SR	4X1/2	1-1/8	1	10	046	75.64
467SE-416SR	4X3/4	1-1/8	1	10	046	75.64
467SE-417SR	4X1	1-1/8	1	8	046	75.64
467SE-418SR	4X1-1/4	1-3/4	1	8	046	75.64
467SE-419SR	4X1-1/2	1-3/4	1	8	046	75.64
467SE-420SR	4X2	2-1/4	1	8	046	75.64
467SE-421SR	4X2-1/2	3	1	4	046	78.87
467SE-422SR	4X3	3	1	4	046	83.26
467SE-523SR	6X1/2	1-1/8	1	4	046	127.12
467SE-524SR	6X3/4	1-1/8	1	4	046	127.12
467SE-525SR	6X1	1-1/8	1	4	046	127.12
467SE-526SR	6X1-1/4	2-1/4	1	4	046	127.12
467SE-527SR	6X1-1/2	2-1/4	1	4	046	127.12
467SE-528SR	6X2	2-1/4	1	4	046	127.12
467SE-529SR	6X2-1/2	3	1	4	046	137.97
467SE-530SR	6X3	3	1	4	046	143.12
467SE-532SR	6X4	4	1	4	046	145.71
467SE-573SR	8X1/2	4	1	0	046	182.37
467SE-574SR	8X3/4	4	1	0	046	182.37
467SE-575SR	8X1	4	1	0	046	182.37
467SE-576SR	8X1-1/4	4	1	0	046	182.37
467SE-577SR	8X1-1/2	4	1	0	046	182.37
467SE-578SR	8X2	4	1	0	046	182.37
467SE-579SR	8X2-1/2	4	1	0	046	200.70
467SE-580SR	8X3	4	1	0	046	210.67
467SE-582SR	8X4	4	1	1	046	223.38
467SE-585SR	8X6	6	1	0	046	245.69
467SE-624SR	10X4	4	1	1	046	292.26
467SE-626SR	10X6	6	1	1	046	336.30
467SE-666SR	12X6	6	1	1	046	425.10

¹Outlet-sized with Bushing



PVC/CPVC Clamp-On & Hot-Tap Saddles

Part Number	Size	Hole Saw Dia	Std Pk	Mstr Ctn	Disc Code	Price Each
-------------	------	--------------	--------	----------	-----------	------------

PVC White Clamp-On Saddle x Soc Double Outlet with Buna-N O-ring Seal & Zinc-Plated Hardware

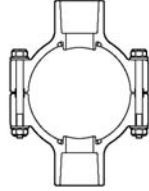

2"-4" 235, 6" 200, 8"-12" 150 psi @ 73°F (23°C)

468-247	2X1/2	3/4	1	10	046	28.82
468-248	2X3/4	7/8	1	10	046	28.82
468-249	2X1	1-1/8	1	10	046	28.82
468-250	2X1-1/4	1-1/2	1	10	046	28.82
468-251	2X1-1/2	1-1/2	1	10	046	28.82
468-291	2-1/2X1-1/2	1-3/4	1	10	046	38.48
468-333	3X1/2	7/8	1	10	046	38.48
468-334	3X3/4	7/8	1	10	046	38.48
468-335	3X1	1-1/8	1	10	046	38.48
468-336	3X1-1/4	2-1/4	1	10	046	38.48
468-337	3X1-1/2	2-1/4	1	10	046	38.48
468-338	3X2	2-1/4	1	10	046	38.48
468-415	4X1/2	1-1/8	1	10	046	48.76
468-416	4X3/4	1-1/8	1	10	046	48.76
468-417	4X1	1-1/8	1	8	046	48.76
468-418	4X1-1/4	1-3/4	1	8	046	48.76
468-419	4X1-1/2	1-3/4	1	8	046	48.76
468-420	4X2	2-1/4	1	8	046	48.76
468-421	4X2-1/2	3	1	4	046	51.03
468-422	4X3	3	1	4	046	57.62
468-523	6X1/2	1-1/8	1	4	046	80.29
468-524	6X3/4	1-1/8	1	4	046	80.29
468-525	6X1	1-1/8	1	4	046	80.29
468-526	6X1-1/4	2-1/4	1	4	046	80.29
468-527	6X1-1/2	2-1/4	1	4	046	80.29
468-528	6X2	2-1/4	1	4	046	80.29
468-529	6X2-1/2	3	1	4	046	91.38
468-530	6X3	3	1	4	046	95.52
468-532	6X4	4	1	4	046	102.69
468-573	8X1/2	4	1	0	046	115.23
468-574	8X3/4	4	1	0	046	115.23
468-575	8X1	4	1	1	046	115.23
468-576	8X1-1/4	4	1	0	046	115.23
468-577	8X1-1/2	4	1	0	046	115.23
468-578	8X2	4	1	0	046	115.23
468-579	8X2-1/2	4	1	0	046	126.70
468-580	8X3	4	1	0	046	133.07
468-582	8X4	4	1	1	046	141.08
468-585	8X6	6	1	1	046	156.52
468-624	10X4	4	1	1	046	186.26
468-626	10X6	6	1	1	046	214.13
468-664	12X4	4	1	0	046	233.49
468-666	12X6	6	1	1	046	270.88

¹Outlet-sized with Bushing

Part Number	Size	Hole Saw Dia	Std Pk	Mstr Ctn	Disc Code	Price Each
-------------	------	--------------	--------	----------	-----------	------------

PVC White Clamp-On Saddle x Soc Double Outlet with Buna-N O-ring Seal & SS Hardware

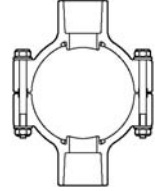

2"-4" 235, 6" 200, 8"-12" 150 psi @ 73°F (23°C)

468S-247	2X1/2	3/4	1	10	046	46.26
468S-248	2X3/4	7/8	1	10	046	46.26
468S-249	2X1	1-1/8	1	10	046	46.26
468S-250	2X1-1/4	1-1/2	1	10	046	46.26
468S-251	2X1-1/2	1-1/2	1	10	046	46.26
468S-291	2-1/2X1-1/2	1-3/4	1	10	046	61.76
468S-333	3X1/2	7/8	1	10	046	61.76
468S-334	3X3/4	7/8	1	10	046	61.76
468S-335	3X1	1-1/8	1	10	046	61.76
468S-336	3X1-1/4	2-1/4	1	10	046	61.76
468S-337	3X1-1/2	2-1/4	1	10	046	61.76
468S-338	3X2	2-1/4	1	10	046	61.76
468S-415	4X1/2	1-1/8	1	10	046	77.08
468S-416	4X3/4	1-1/8	1	10	046	77.08
468S-417	4X1	1-1/8	1	8	046	77.08
468S-418	4X1-1/4	1-3/4	1	8	046	77.08
468S-419	4X1-1/2	1-3/4	1	8	046	77.08
468S-420	4X2	2-1/4	1	8	046	77.08
468S-421	4X2-1/2	3	1	4	046	81.00
468S-422	4X3	3	1	4	046	88.88
468S-523	6X1/2	1-1/8	1	4	046	127.31
468S-524	6X3/4	1-1/8	1	4	046	127.31
468S-525	6X1	1-1/8	1	4	046	127.31
468S-526	6X1-1/4	2-1/4	1	4	046	127.31
468S-527	6X1-1/2	2-1/4	1	4	046	127.31
468S-528	6X2	2-1/4	1	4	046	127.31
468S-529	6X2-1/2	3	1	4	046	133.03
468S-530	6X3	3	1	4	046	135.31
468S-532	6X4	4	1	4	046	139.70
468S-573	8X1/2	4	1	0	046	171.26
468S-574	8X3/4	4	1	0	046	171.26
468S-575	8X1	4	1	1	046	171.26
468S-576	8X1-1/4	4	1	0	046	171.26
468S-577	8X1-1/2	4	1	0	046	171.26
468S-578	8X2	4	1	0	046	171.26
468S-579	8X2-1/2	4	1	0	046	188.36
468S-580	8X3	4	1	0	046	197.89
468S-582	8X4	4	1	1	046	209.66
468S-585	8X6	6	1	1	046	230.59
468S-624	10X4	4	1	1	046	274.34
468S-626	10X6	6	1	1	046	315.57
468S-664	12X4	4	1	0	046	343.96
468S-666	12X6	6	1	1	046	398.97

¹Outlet-sized with Bushing.

PVC/CPVC Clamp-On & Hot-Tap Saddles



Part Number	Size	Hole Saw Dia	Std Pk	Mstr Ctn	Disc Code	Price Each
-------------	------	--------------	--------	----------	-----------	------------

PVC White Clamp-On Saddle x Soc Double Outlet with EPDM O-ring Seal & Zinc-Plated Hardware

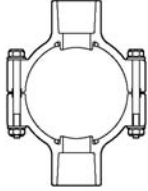

2"-4" 235, 6" 200, 8"-12" 150 psi @ 73°F (23°C)

468E-247	2X1/2	3/4	1	10	046	30.31
468E-248	2X3/4	7/8	1	10	046	30.31
468E-249	2X1	1-1/8	1	10	046	30.31
468E-250	2X1-1/4	1-1/2	1	10	046	30.31
468E-251	2X1-1/2	1-1/2	1	10	046	30.31
468E-291	2-1/2X1-1/2	1-3/4	1	10	046	41.87
468E-333	3X1/2	7/8	1	10	046	41.87
468E-334	3X3/4	7/8	1	10	046	41.87
468E-335	3X1	1-1/8	1	10	046	41.87
468E-336	3X1-1/4	2-1/4	1	10	046	41.87
468E-337	3X1-1/2	2-1/4	1	10	046	41.87
468E-338	3X2	2-1/4	1	10	046	41.87
468E-415	4X1/2	1-1/8	1	10	046	50.90
468E-416	4X3/4	1-1/8	1	10	046	50.90
468E-417	4X1	1-1/8	1	8	046	50.90
468E-418	4X1-1/4	1-3/4	1	8	046	50.90
468E-419	4X1-1/2	1-3/4	1	8	046	50.90
468E-420	4X2	2-1/4	1	8	046	50.90
468E-421	4X2-1/2	3	1	4	046	54.59
468E-422	4X3	3	4	0	046	60.84
468E-523	6X1/2	1-1/8	1	4	046	85.46
468E-524	6X3/4	1-1/8	1	4	046	85.46
468E-525	6X1	1-1/8	1	4	046	85.46
468E-526	6X1-1/4	2-1/4	1	4	046	85.46
468E-527	6X1-1/2	2-1/4	1	4	046	85.46
468E-528	6X2	2-1/4	1	4	046	85.46
468E-529	6X2-1/2	3	1	4	046	95.57
468E-530	6X3	3	1	4	046	102.82
468E-532	6X4	4	1	4	046	108.33
468E-573	8X1/2	4	1	0	046	128.93
468E-574	8X3/4	4	1	0	046	128.93
468E-575	8X1	4	1	1	046	128.93
468E-576	8X1-1/4	4	1	0	046	128.93
468E-577	8X1-1/2	4	1	0	046	128.93
468E-578	8X2	4	1	0	046	128.93
468E-579	8X2-1/2	4	1	0	046	141.88
468E-580	8X3	4	1	0	046	149.02
468E-582	8X4	4	1	1	046	157.98
468E-585	8X6	6	1	1	046	173.71
468E-624	10X4	4	1	1	046	206.77
468E-626	10X6	6	1	1	046	237.68
468E-664	12X4	4	1	0	046	259.19
468E-666	12X6	6	1	1	046	300.56

¹Outlet-sized with Bushing

Part Number	Size	Hole Saw Dia	Std Pk	Mstr Ctn	Disc Code	Price Each
-------------	------	--------------	--------	----------	-----------	------------

PVC White Clamp-On Saddle x Soc Double Outlet with EPDM O-ring Seal & SS Hardware

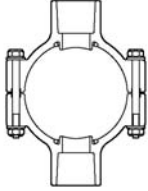

2"-4" 235, 6" 200, 8"-12" 150 psi @ 73°F (23°C)

468SE-247	2X1/2	3/4	1	10	046	49.46
468SE-248	2X3/4	7/8	1	10	046	49.46
468SE-249	2X1	1-1/8	1	10	046	49.46
468SE-250	2X1-1/4	1-1/2	1	10	046	49.46
468SE-251	2X1-1/2	1-1/2	1	10	046	49.46
468SE-291	2-1/2X1-1/2	1-3/4	1	10	046	65.41
468SE-333	3X1/2	7/8	1	10	046	65.41
468SE-334	3X3/4	7/8	1	10	046	65.41
468SE-335	3X1	1-1/8	1	10	046	65.41
468SE-336	3X1-1/4	2-1/4	1	10	046	65.41
468SE-337	3X1-1/2	2-1/4	1	10	046	65.41
468SE-338	3X2	2-1/4	1	10	046	65.41
468SE-415	4X1/2	1-1/8	1	10	046	81.66
468SE-416	4X3/4	1-1/8	1	10	046	81.66
468SE-417	4X1	1-1/8	1	8	046	81.66
468SE-418	4X1-1/4	1-3/4	1	8	046	81.66
468SE-419	4X1-1/2	1-3/4	1	8	046	81.66
468SE-420	4X2	2-1/4	1	8	046	81.66
468SE-421	4X2-1/2	3	1	4	046	89.13
468SE-422	4X3	3	4	0	046	95.01
468SE-523	6X1/2	1-1/8	1	4	046	136.11
468SE-524	6X3/4	1-1/8	1	4	046	136.11
468SE-525	6X1	1-1/8	1	4	046	136.11
468SE-526	6X1-1/4	2-1/4	1	4	046	136.11
468SE-527	6X1-1/2	2-1/4	1	4	046	136.11
468SE-528	6X2	2-1/4	1	4	046	136.11
468SE-529	6X2-1/2	3	1	4	046	139.79
468SE-530	6X3	3	1	4	046	144.64
468SE-532	6X4	4	1	4	046	152.98
468SE-573	8X1/2	4	1	0	046	193.91
468SE-574	8X3/4	4	1	0	046	193.91
468SE-575	8X1	4	1	1	046	193.91
468SE-576	8X1-1/4	4	1	0	046	193.91
468SE-577	8X1-1/2	4	1	0	046	193.91
468SE-578	8X2	4	1	0	046	193.91
468SE-579	8X2-1/2	4	1	0	046	213.34
468SE-580	8X3	4	1	0	046	220.64
468SE-582	8X4	4	1	1	046	237.74
468SE-585	8X6	6	1	1	046	263.52
468SE-624	10X4	4	1	1	046	313.56
468SE-626	10X6	6	1	1	046	360.54
468SE-664	12X4	4	1	1	046	393.19
468SE-666	12X6	6	1	1	046	456.00

¹Outlet-sized with Bushing



PVC/CPVC Clamp-On & Hot-Tap Saddles

Part Number	Size	Hole Saw Dia	Std Pk	Mstr Ctn	Disc Code	Price Each
-------------	------	--------------	--------	----------	-----------	------------

PVC White Clamp-On Saddle x SR Thread Double Outlet with Buna-N O-ring Seal & Zinc-Plated Hardware

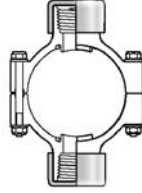

2"-4" 235, 6" 200, 8"-12" 150 psi @ 73°F (23°C)

469-247SR	2X1/2	3/4	1	10	046	32.59
469-248SR	2X3/4	7/8	1	10	046	32.59
469-249SR	2X1	1-1/8	1	10	046	32.59
469-250SR	2X1-1/4	1-1/2	1	10	046	32.59
469-251SR	2X1-1/2	1-1/2	1	10	046	32.59
469-291SR	2-1/2X1-1/2	1-3/4	1	10	046	43.27
469-333SR	3X1/2	7/8	1	10	046	43.27
469-334SR	3X3/4	7/8	1	10	046	43.27
469-335SR	3X1	1-1/8	1	10	046	43.27
469-336SR	3X1-1/4	2-1/4	1	10	046	43.27
469-337SR	3X1-1/2	2-1/4	1	10	046	43.27
469-338SR	3X2	2-1/4	1	10	046	43.27
469-415SR	4X1/2	1-1/8	1	10	046	64.96
469-416SR	4X3/4	1-1/8	1	10	046	64.96
469-417SR	4X1	1-1/8	1	8	046	64.96
469-418SR	4X1-1/4	1-3/4	1	8	046	64.96
469-419SR	4X1-1/2	1-3/4	1	8	046	64.96
469-420SR	4X2	2-1/4	1	8	046	64.96
469-421SR	4X2-1/2	3	1	4	046	69.79
469-422SR	4X3	3	1	4	046	166.49
469-523SR	6X1/2	1-1/8	1	4	046	105.90
469-524SR	6X3/4	1-1/8	1	4	046	105.90
469-525SR	6X1	1-1/8	1	4	046	105.90
469-526SR	6X1-1/4	2-1/4	1	4	046	105.90
469-527SR	6X1-1/2	2-1/4	1	4	046	105.90
469-528SR	6X2	2-1/4	1	4	046	105.90
469-529SR	6X2-1/2	3	1	4	046	127.01
469-530SR	6X3	3	1	4	046	133.34
469-532SR	6X4	4	1	4	046	139.62
469-573SR	8X1/2	4	1	0	046	155.22
469-574SR	8X3/4	4	1	0	046	155.22
469-575SR	8X1	4	1	0	046	155.22
469-576SR	8X1-1/4	4	1	0	046	155.22
469-577SR	8X1-1/2	4	1	0	046	155.22
469-578SR	8X2	4	1	0	046	155.22
469-579SR	8X2-1/2	4	1	0	046	171.82
469-580SR	8X3	4	1	0	046	180.13
469-582SR	8X4	4	1	1	046	191.03
469-585SR	8X6	6	1	0	046	210.10
469-624SR	10X4	4	1	1	046	250.02
469-626SR	10X6	6	1	1	046	287.34
469-666SR	12X6	6	1	1	046	363.51

¹Outlet-sized with Bushing

Part Number	Size	Hole Saw Dia	Std Pk	Mstr Ctn	Disc Code	Price Each
-------------	------	--------------	--------	----------	-----------	------------

PVC White Clamp-On Saddle x SR Thread Double Outlet with Buna-N O-ring Seal & SS Hardware

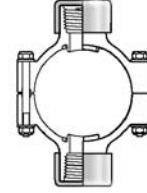

2"-4" 235, 6" 200, 8"-12" 150 psi @ 73°F (23°C)

469S-247SR	2X1/2	3/4	1	10	046	51.42
469S-248SR	2X3/4	7/8	1	10	046	51.42
469S-249SR	2X1	1-1/8	1	10	046	51.42
469S-250SR	2X1-1/4	1-1/2	1	10	046	51.42
469S-251SR	2X1-1/2	1-1/2	1	10	046	51.42
469S-291SR	2-1/2X1-1/2	1-3/4	1	10	046	68.60
469S-333SR	3X1/2	7/8	1	10	046	68.60
469S-334SR	3X3/4	7/8	1	10	046	68.60
469S-335SR	3X1	1-1/8	1	10	046	68.60
469S-336SR	3X1-1/4	2-1/4	1	10	046	68.60
469S-337SR	3X1-1/2	2-1/4	1	10	046	68.60
469S-338SR	3X2	2-1/4	1	10	046	68.60
469S-415SR	4X1/2	1-1/8	1	10	046	87.18
469S-416SR	4X3/4	1-1/8	1	10	046	87.18
469S-417SR	4X1	1-1/8	1	8	046	87.18
469S-418SR	4X1-1/4	1-3/4	1	8	046	87.18
469S-419SR	4X1-1/2	1-3/4	1	8	046	87.18
469S-420SR	4X2	2-1/4	1	8	046	87.18
469S-421SR	4X2-1/2	3	1	4	046	91.96
469S-422SR	4X3	3	1	4	046	100.68
469S-523SR	6X1/2	1-1/8	1	4	046	143.22
469S-524SR	6X3/4	1-1/8	1	4	046	143.22
469S-525SR	6X1	1-1/8	1	4	046	143.22
469S-526SR	6X1-1/4	2-1/4	1	4	046	143.22
469S-527SR	6X1-1/2	2-1/4	1	4	046	143.22
469S-528SR	6X2	2-1/4	1	4	046	143.22
469S-529SR	6X2-1/2	3	1	4	046	149.92
469S-530SR	6X3	3	1	4	046	158.58
469S-532SR	6X4	4	1	4	046	165.60
469S-573SR	8X1/2	4	1	0	046	203.10
469S-574SR	8X3/4	4	1	0	046	203.10
469S-575SR	8X1	4	1	0	046	203.10
469S-576SR	8X1-1/4	4	1	0	046	203.10
469S-577SR	8X1-1/2	4	1	0	046	203.10
469S-578SR	8X2	4	1	0	046	203.10
469S-579SR	8X2-1/2	4	1	0	046	223.38
469S-580SR	8X3	4	1	0	046	234.49
469S-582SR	8X4	4	1	1	046	248.36
469S-585SR	8X6	6	1	0	046	275.79
469S-624SR	10X4	4	1	1	046	328.21
469S-626SR	10X6	6	1	1	046	377.44
469S-664SR	12X4	4	1	1	046	411.38
469S-666SR	12X6	6	1	1	046	477.08

¹Outlet-sized with Bushing

PVC/CPVC Clamp-On & Hot-Tap Saddles



Part Number	Size	Hole Saw Dia	Std Pk	Mstr Ctn	Disc Code	Price Each
-------------	------	--------------	--------	----------	-----------	------------

PVC White Clamp-On Saddle x SR Thread Double Outlet with EPDM O-ring Seal & Zinc-Plated Hardware

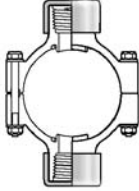

2"-4" 235, 6" 200, 8"-12" 150 psi @ 73°F (23°C)

469E-247SR	2X1/2	3/4	1	10	046	35.82
469E-248SR	2X3/4	7/8	1	10	046	35.82
469E-249SR	2X1	1-1/8	1	10	046	35.82
469E-250SR	2X1-1/4	1-1/2	1	10	046	35.82
469E-251SR	2X1-1/2	1-1/2	1	10	046	35.82
469E-291SR	2-1/2X1-1/2	1-3/4	1	10	046	48.57
469E-333SR	3X1/2	7/8	1	10	046	48.57
469E-334SR	3X3/4	7/8	1	10	046	48.57
469E-335SR	3X1	1-1/8	1	10	046	48.57
469E-336SR	3X1-1/4	2-1/4	1	10	046	48.57
469E-337SR	3X1-1/2	2-1/4	1	10	046	48.57
469E-338SR	3X2	2-1/4	1	16	046	48.57
469E-415SR	4X1/2	1-1/8	1	10	046	75.71
469E-416SR	4X3/4	1-1/8	1	10	046	75.71
469E-417SR	4X1	1-1/8	1	8	046	75.71
469E-418SR	4X1-1/4	1-3/4	1	8	046	75.71
469E-419SR	4X1-1/2	1-3/4	1	8	046	75.71
469E-420SR	4X2	2-1/4	1	8	046	75.71
469E-421SR	4X2-1/2	3	1	4	046	77.01
469E-422SR	4X3	3	4	0	046	168.61
469E-523SR	6X1/2	1-1/8	1	4	046	116.09
469E-524SR	6X3/4	1-1/8	1	4	046	116.09
469E-525SR	6X1	1-1/8	1	4	046	116.09
469E-526SR	6X1-1/4	2-1/4	1	4	046	116.09
469E-527SR	6X1-1/2	2-1/4	1	4	046	116.09
469E-528SR	6X2	2-1/4	1	4	046	116.09
469E-529SR	6X2-1/2	3	1	4	046	129.93
469E-530SR	6X3	3	1	4	046	140.53
469E-532SR	6X4	4	1	4	046	149.43
469E-573SR	8X1/2	4	1	0	046	168.21
469E-574SR	8X3/4	4	1	0	046	168.21
469E-575SR	8X1	4	1	0	046	168.21
469E-576SR	8X1-1/4	4	1	0	046	168.21
469E-577SR	8X1-1/2	4	1	0	046	168.21
469E-578SR	8X2	4	1	0	046	168.21
469E-579SR	8X2-1/2	4	1	0	046	185.11
469E-580SR	8X3	4	1	0	046	194.36
469E-582SR	8X4	4	1	1	046	206.07
469E-585SR	8X6	6	1	0	046	228.71
469E-624SR	10X4	4	1	1	046	272.18
469E-626SR	10X6	6	1	1	046	312.90
469E-666SR	12X6	6	1	1	046	395.79

¹Outlet-sized with Bushing

Part Number	Size	Hole Saw Dia	Std Pk	Mstr Ctn	Disc Code	Price Each
-------------	------	--------------	--------	----------	-----------	------------

PVC White Clamp-On Saddle x SR Thread Double Outlet with EPDM O-ring Seal & SS Hardware

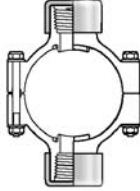

2"-4" 235, 6" 200, 8"-12" 150 psi @ 73°F (23°C)

469SE-247SR	2X1/2	3/4	1	10	046	54.71
469SE-248SR	2X3/4	7/8	1	10	046	54.71
469SE-249SR	2X1	1-1/8	1	10	046	54.71
469SE-250SR	2X1-1/4	1-1/2	1	10	046	54.71
469SE-251SR	2X1-1/2	1-1/2	1	10	046	54.71
469SE-291SR	2-1/2X1-1/2	1-3/4	1	10	046	72.86
469SE-333SR	3X1/2	7/8	1	10	046	72.86
469SE-334SR	3X3/4	7/8	1	10	046	72.86
469SE-335SR	3X1	1-1/8	1	10	046	72.86
469SE-336SR	3X1-1/4	2-1/4	1	10	046	72.86
469SE-337SR	3X1-1/2	2-1/4	1	10	046	72.86
469SE-338SR	3X2	2-1/4	1	10	046	72.86
469SE-415SR	4X1/2	1-1/8	1	10	046	94.00
469SE-416SR	4X3/4	1-1/8	1	10	046	94.00
469SE-417SR	4X1	1-1/8	1	8	046	94.00
469SE-418SR	4X1-1/4	1-3/4	1	8	046	94.00
469SE-419SR	4X1-1/2	1-3/4	1	8	046	94.00
469SE-420SR	4X2	2-1/4	1	8	046	94.00
469SE-421SR	4X2-1/2	3	1	4	046	97.51
469SE-422SR	4X3	3	4	0	046	106.70
469SE-523SR	6X1/2	1-1/8	1	4	046	146.89
469SE-524SR	6X3/4	1-1/8	1	4	046	146.89
469SE-525SR	6X1	1-1/8	1	4	046	146.89
469SE-526SR	6X1-1/4	2-1/4	1	4	046	146.89
469SE-527SR	6X1-1/2	2-1/4	1	4	046	146.89
469SE-528SR	6X2	2-1/4	1	4	046	146.89
469SE-529SR	6X2-1/2	3	1	4	046	157.12
469SE-530SR	6X3	3	1	4	046	165.90
469SE-532SR	6X4	4	1	4	046	175.74
469SE-573SR	8X1/2	4	1	0	046	207.79
469SE-574SR	8X3/4	4	1	0	046	207.79
469SE-575SR	8X1	4	1	0	046	207.79
469SE-576SR	8X1-1/4	4	1	0	046	207.79
469SE-577SR	8X1-1/2	4	1	0	046	207.79
469SE-578SR	8X2	4	1	0	046	207.79
469SE-579SR	8X2-1/2	4	1	0	046	228.58
469SE-580SR	8X3	4	1	0	046	239.99
469SE-582SR	8X4	4	1	1	046	250.09
469SE-585SR	8X6	6	1	0	046	282.29
469SE-624SR	10X4	4	1	1	046	335.86
469SE-626SR	10X6	6	1	1	046	386.24
469SE-664SR	12X4	4	1	1	046	420.19
469SE-666SR	12X6	6	1	1	046	488.07

¹Outlet-sized with Bushing



PVC/CPVC Clamp-On & Hot-Tap Saddles

Part Number	Size	Hole Saw Dia	Std PK	Mstr Ctn	Disc Code	Price Each
-------------	------	--------------	--------	----------	-----------	------------

PVC Gray Clamp-On Saddle x Soc Single Outlet
with Viton® O-ring Seal & Zinc-Plated Hardware

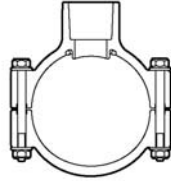

2"-4" 235, 6" 200, 8"-12" 150 psi @ 73°F (23°C)

866V-247	2X1/2	3/4	1	10	086	28.54
866V-248	2X3/4	7/8	1	10	086	28.54
866V-249	2X1	1-1/8	1	10	086	28.54
866V-250	2X1-1/4	1-1/2	1	10	086	28.54
866V-251	2X1-1/2	1-1/2	1	10	086	28.54
866V-291	2-1/2X1-1/2	1-3/4	1	10	086	39.53
866V-333	3X1/2	7/8	1	10	086	39.53
866V-334	3X3/4	7/8	1	10	086	39.53
866V-335	3X1	1-1/8	1	10	086	39.53
866V-336	3X1-1/4	2-1/4	1	10	086	39.53
866V-337	3X1-1/2	2-1/4	1	10	086	39.53
866V-338	3X2	2-1/4	1	10	086	39.53
866V-415	4X1/2	1-1/8	1	10	086	47.38
866V-416	4X3/4	1-1/8	1	10	086	47.38
866V-417	4X1	1-1/8	1	8	086	47.38
866V-418	4X1-1/4	1-3/4	1	8	086	47.38
866V-419	4X1-1/2	1-3/4	1	8	086	47.38
866V-420	4X2	2-1/4	1	8	086	47.38
866V-421	4X2-1/2	3	1	4	086	51.67
866V-422	4X3	3	1	4	086	56.23
866V-523	6X1/2	1-1/8	1	4	086	78.93
866V-524	6X3/4	1-1/8	1	4	086	78.93
866V-525	6X1	1-1/8	1	4	086	78.93
866V-526	6X1-1/4	2-1/4	1	4	086	78.93
866V-527	6X1-1/2	2-1/4	1	4	086	78.93
866V-528	6X2	2-1/4	1	4	086	78.93
866V-529	6X2-1/2	3	1	4	086	99.31
866V-530	6X3	3	1	4	086	103.40
866V-532	6X4	4	1	4	086	108.90
866V-573	8X1/2	4	1	0	086	169.16
866V-574	8X3/4	4	1	0	086	169.16
866V-575	8X1	4	1	1	086	169.16
866V-576	8X1-1/4	4	1	0	086	169.16
866V-577	8X1-1/2	4	1	0	086	169.16
866V-578	8 X 2	4	1	1	086	169.16
866V-579	8X2-1/2	4	1	0	086	177.47
866V-580	8X3	4	1	0	086	186.41
866V-582	8X4	4	1	1	086	197.60
866V-585	8X6	6	1	0	086	219.33
866V-624	10X4	4	1	1	086	260.92
866V-626	10X6	6	1	1	086	300.04
866V-664	12X4	4	1	1	086	327.20
866V-666	12X6	6	1	1	086	379.47

¹Outlet-sized with Bushing

Part Number	Size	Hole Saw Dia	Std PK	Mstr Ctn	Disc Code	Price Each
-------------	------	--------------	--------	----------	-----------	------------

PVC Gray Clamp-On Saddle x Soc Single Outlet
with Viton® O-ring Seal & SS Hardware

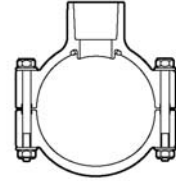

2"-4" 235, 6" 200, 8"-12" 150 psi @ 73°F (23°C)

866SV-247	2X1/2	3/4	1	10	086	48.64
866SV-248	2X3/4	7/8	1	10	086	48.64
866SV-249	2X1	1-1/8	1	10	086	48.64
866SV-250	2X1-1/4	1-1/2	1	10	086	48.64
866SV-251	2X1-1/2	1-1/2	1	10	086	48.64
866SV-291	2-1/2X1-1/2	1-3/4	1	10	086	65.19
866SV-333	3X1/2	7/8	1	10	086	65.19
866SV-334	3X3/4	7/8	1	10	086	65.19
866SV-335	3X1	1-1/8	1	10	086	65.19
866SV-336	3X1-1/4	2-1/4	1	10	086	65.19
866SV-337	3X1-1/2	2-1/4	1	10	086	65.19
866SV-338	3X2	2-1/4	1	10	086	65.19
866SV-415	4X1/2	1-1/8	1	10	086	83.88
866SV-416	4X3/4	1-1/8	1	10	086	83.88
866SV-417	4X1	1-1/8	1	8	086	83.88
866SV-418	4X1-1/4	1-3/4	1	8	086	83.88
866SV-419	4X1-1/2	1-3/4	1	8	086	83.88
866SV-420	4X2	2-1/4	1	8	086	83.88
866SV-421	4X2-1/2	3	1	4	086	87.21
866SV-422	4X3	3	1	4	086	91.71
866SV-523	6X1/2	1-1/8	1	4	086	124.31
866SV-524	6X3/4	1-1/8	1	4	086	124.31
866SV-525	6X1	1-1/8	1	4	086	124.31
866SV-526	6X1-1/4	2-1/4	1	4	086	124.31
866SV-527	6X1-1/2	2-1/4	1	4	086	124.31
866SV-528	6X2	2-1/4	1	4	086	124.31
866SV-529	6X2-1/2	3	1	4	086	129.13
866SV-530	6X3	3	1	4	086	133.48
866SV-532	6X4	4	1	4	086	138.03
866SV-573	8X1/2	4	1	0	086	226.99
866SV-574	8X3/4	4	1	0	086	226.99
866SV-575	8 X 1	4	1	1	086	226.99
866SV-576	8X1-1/4	4	1	0	086	226.99
866SV-577	8X1-1/2	4	1	0	086	226.99
866SV-578	8 X 2	4	1	1	086	226.99
866SV-579	8X2-1/2	4	1	0	086	249.66
866SV-580	8X3	4	1	0	086	262.14
866SV-582	8X4	4	1	1	086	277.88
866SV-585	8X6	6	1	1	086	308.42
866SV-624	10X4	4	1	1	086	367.12
866SV-626	10X6	6	1	1	086	422.07
866SV-664	12X4	4	1	1	086	460.03
866SV-666	12X6	6	1	1	086	533.68

¹Outlet-sized with Bushing

PVC/CPVC Clamp-On & Hot-Tap Saddles



Part Number	Size	Hole Saw Dia	Std Pk	Mstr Ctn	Disc Code	Price Each
-------------	------	--------------	--------	----------	-----------	------------

PVC Gray Clamp-On Saddle x Soc Single Outlet with EPDM O-ring Seal & Zinc-Plated Hardware

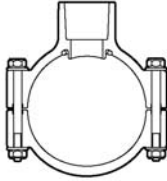

2"-4" 235, 6" 200, 8"-12" 150 psi @ 73°F (23°C)

866-247	2X1/2	3/4	1	10	086	27.19
866-248	2X3/4	7/8	1	10	086	27.19
866-249	2X1	1-1/8	1	10	086	27.19
866-250	2X1-1/4	1-1/2	1	10	086	27.19
866-251	2X1-1/2	1-1/2	1	10	086	27.19
866-291	2-1/2X1-1/2	1-3/4	1	10	086	36.31
866-333	3X1/2	7/8	1	10	086	36.31
866-334	3X3/4	7/8	1	10	086	36.31
866-335	3X1	1-1/8	1	10	086	36.31
866-336	3X1-1/4	2-1/4	1	10	086	36.31
866-337	3X1-1/2	2-1/4	1	10	086	36.31
866-338	3X2	2-1/4	1	10	086	36.31
866-415	4X1/2	1-1/8	1	10	086	44.13
866-416	4X3/4	1-1/8	1	10	086	44.13
866-417	4X1	1-1/8	1	8	086	44.13
866-418	4X1-1/4	1-3/4	1	8	086	44.13
866-419	4X1-1/2	1-3/4	1	8	086	44.13
866-420	4X2	2-1/4	1	8	086	44.13
866-421	4X2-1/2	3	1	4	086	48.22
866-422	4X3	3	1	4	086	52.77
866-523	6X1/2	1-1/8	1	4	086	73.56
866-524	6X3/4	1-1/8	1	4	086	73.56
866-525	6X1	1-1/8	1	4	086	73.56
866-526	6X1-1/4	2-1/4	1	4	086	73.56
866-527	6X1-1/2	2-1/4	1	4	086	73.56
866-528	6X2	2-1/4	1	4	086	73.56
866-529	6X2-1/2	3	1	4	086	80.30
866-530	6X3	3	1	4	086	88.29
866-532	6X4	4	1	4	086	92.03
866-573	8X1/2	4	1	0	086	141.51
866-574	8X3/4	4	1	0	086	141.51
866-575	8X1	4	1	0	086	141.51
866-576	8X1-1/4	4	1	0	086	141.51
866-577	8X1-1/2	4	1	0	086	141.51
866-578	8 X 2	4	1	1	086	141.51
866-579	8X2-1/2	4	1	0	086	155.66
866-580	8 X 3	4	1	0	086	163.46
866-582	8X4	4	1	1	086	173.12
866-585	8X6	6	1	1	086	192.33
866-621	10X2	4	1	0	086	246.64
866-624	10X4	4	1	1	086	229.30
866-626	10X6	6	1	1	086	262.37
866-664	12X4	4	1	1	086	286.77
866-666	12X6	6	1	1	086	331.67

¹Outlet-sized with Bushing

Part Number	Size	Hole Saw Dia	Std Pk	Mstr Ctn	Disc Code	Price Each
-------------	------	--------------	--------	----------	-----------	------------

PVC Gray Clamp-On Saddle x Soc Single Outlet with EPDM O-ring Seal & SS Hardware

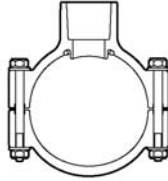

2"-4" 235, 6" 200, 8"-12" 150 psi @ 73°F (23°C)

866S-247	2X1/2	3/4	1	10	086	43.57
866S-248	2X3/4	7/8	1	10	086	43.57
866S-249	2X1	1-1/8	1	10	086	43.57
866S-250	2X1-1/4	1-1/2	1	10	086	43.57
866S-251	2X1-1/2	1-1/2	1	10	086	43.57
866S-291	2-1/2X1-1/2	1-3/4	1	10	086	58.57
866S-333	3X1/2	7/8	1	10	086	58.57
866S-334	3X3/4	7/8	1	10	086	58.57
866S-335	3X1	1-1/8	1	10	086	58.57
866S-336	3X1-1/4	2-1/4	1	10	086	58.57
866S-337	3X1-1/2	2-1/4	1	10	086	58.57
866S-338	3X2	2-1/4	1	10	086	58.57
866S-415	4X1/2	1-1/8	1	10	086	75.41
866S-416	4X3/4	1-1/8	1	10	086	75.41
866S-417	4X1	1-1/8	1	8	086	75.41
866S-418	4X1-1/4	1-3/4	1	8	086	75.41
866S-419	4X1-1/2	1-3/4	1	8	086	75.41
866S-420	4X2	2-1/4	1	8	086	75.41
866S-421	4X2-1/2	3	1	4	086	78.07
866S-422	4X3	3	1	4	086	82.68
866S-523	6X1/2	1-1/8	1	4	086	113.48
866S-524	6X3/4	1-1/8	1	4	086	113.48
866S-525	6X1	1-1/8	1	4	086	113.48
866S-526	6X1-1/4	2-1/4	1	4	086	113.48
866S-527	6X1-1/2	2-1/4	1	4	086	113.48
866S-528	6X2	2-1/4	1	4	086	113.48
866S-529	6X2-1/2	3	1	4	086	118.87
866S-530	6X3	3	1	4	086	122.92
866S-532	6X4	4	1	4	086	127.52
866S-573	8X1/2	4	1	0	086	213.27
866S-574	8X3/4	4	1	0	086	213.27
866S-575	8X1	4	1	1	086	213.27
866S-576	8X1-1/4	4	1	0	086	213.27
866S-577	8X1-1/2	4	1	0	086	213.27
866S-578	8 X 2	4	1	1	086	213.27
866S-579	8X2-1/2	4	1	0	086	234.64
866S-580	8X3	4	1	0	086	246.41
866S-582	8X4	4	1	1	086	260.04
866S-585	8X6	6	1	1	086	289.93
866S-624	10X4	4	1	1	086	345.11
866S-626	10X6	6	1	1	086	396.79
866S-664	12X4	4	1	1	086	432.60
866S-666	12X6	6	1	1	086	501.77

¹Outlet-sized with Bushing



PVC/CPVC Clamp-On & Hot-Tap Saddles

Part Number	Size	Hole Saw Dia	Std Pk	Mstr Ctn	Disc Code	Price Each
-------------	------	--------------	--------	----------	-----------	------------

PVC Gray Clamp-On Saddle x SR Thread Single Outlet with Viton® O-ring Seal & Zinc-Plated Hardware

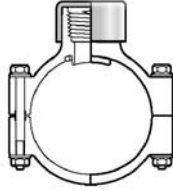

2"-4" 235, 6" 200, 8"-12" 150 psi @ 73°F (23°C)

867V-247SR	2X1/2	3/4	1	10	086	31.91
867V-248SR	2X3/4	7/8	1	10	086	31.91
867V-249SR	2X1	1-1/8	1	10	086	31.91
867V-250SR	2X1-1/4	1-1/2	1	10	086	31.91
867V-251SR	2X1-1/2	1-1/2	1	10	086	31.91
867V-291SR	2-1/2X1-1/2	1-3/4	1	10	086	44.47
867V-333SR	3X1/2	7/8	1	10	086	44.47
867V-334SR	3X3/4	7/8	1	10	086	44.47
867V-335SR	3X1	1-1/8	1	10	086	44.47
867V-336SR	3X1-1/4	2-1/4	1	10	086	44.47
867V-337SR	3X1-1/2	2-1/4	1	10	086	44.47
867V-338SR	3X2	2-1/4	1	10	086	44.47
867V-415SR	4X1/2	1-1/8	1	10	086	55.58
867V-416SR	4X3/4	1-1/8	1	10	086	55.58
867V-417SR	4X1	1-1/8	1	8	086	55.58
867V-418SR	4X1-1/4	1-3/4	1	8	086	55.58
867V-419SR	4X1-1/2	1-3/4	1	8	086	55.58
867V-420SR	4X2	2-1/4	1	8	086	55.58
867V-421SR	4X2-1/2	3	1	4	086	59.86
867V-422SR	4X3	3	1	4	086	63.37
867V-523SR	6X1/2	1-1/8	1	4	086	92.63
867V-524SR	6X3/4	1-1/8	1	4	086	92.63
867V-525SR	6X1	1-1/8	1	4	086	92.63
867V-526SR	6X1-1/4	2-1/4	1	4	086	92.63
867V-527SR	6X1-1/2	2-1/4	1	4	086	92.63
867V-528SR	6X2	2-1/4	1	4	086	92.63
867V-529SR	6X2-1/2	3	1	4	086	118.77
867V-530SR	6X3	3	1	4	086	123.42
867V-532SR	6X4	4	1	4	086	128.76
867V-573SR	8X1/2	4	1	0	086	186.70
867V-574SR	8X3/4	4	1	0	086	186.70
867V-575SR	8X1	4	1	0	086	186.70
867V-576SR	8X1-1/4	4	1	0	086	186.70
867V-577SR	8X1-1/2	4	1	0	086	186.70
867V-578SR	8X2	4	1	0	086	186.70
867V-579SR	8X2-1/2	4	1	0	086	205.33
867V-580SR	8X3	4	1	0	086	215.64
867V-582SR	8X4	4	1	1	086	228.58
867V-585SR	8X6		1	0	086	254.42
867V-624SR	10X4	4	1	1	086	272.03
867V-626SR	10X6	6	1	1	086	312.77
867V-664SR	12X4	4	1	1	086	340.99
867V-666SR	12X6	6	1	1	086	395.49

¹Outlet-sized with Bushing

Part Number	Size	Hole Saw Dia	Std Pk	Mstr Ctn	Disc Code	Price Each
-------------	------	--------------	--------	----------	-----------	------------

PVC Gray Clamp-On Saddle x SR Thread Single Outlet with Viton® O-ring Seal & SS Hardware

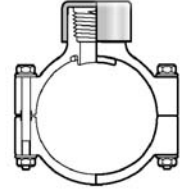

2"-4" 235, 6" 200, 8"-12" 150 psi @ 73°F (23°C)

867SV-245SR	2X1/4	1-1/8	1	10	086	59.09
867SV-247SR	2X1/2	3/4	1	10	086	54.27
867SV-248SR	2X3/4	7/8	1	10	086	54.27
867SV-249SR	2X1	1-1/8	1	10	086	54.27
867SV-250SR	2X1-1/4	1-1/2	1	10	086	54.27
867SV-251SR	2X1-1/2	1-1/2	1	10	086	54.27
867SV-291SR	2-1/2X1-1/2	1-3/4	1	10	086	72.54
867SV-331SR	3X1/4	1-1/8	1	10	086	74.78
867SV-333SR	3X1/2	7/8	1	10	086	72.54
867SV-334SR	3X3/4	7/8	1	10	086	72.54
867SV-335SR	3X1	1-1/8	1	10	086	72.54
867SV-336SR	3X1-1/4	2-1/4	1	10	086	72.54
867SV-337SR	3X1-1/2	2-1/4	1	10	086	72.54
867SV-338SR	3X2	2-1/4	1	10	086	72.54
867SV-413SR	4X1/4	1-1/8	1	8	086	92.56
867SV-415SR	4X1/2	1-1/8	1	10	086	91.59
867SV-416SR	4X3/4	1-1/8	1	10	086	91.59
867SV-417SR	4X1	1-1/8	1	8	086	91.59
867SV-418SR	4X1-1/4	1-3/4	1	8	086	91.59
867SV-419SR	4X1-1/2	1-3/4	1	8	086	91.59
867SV-420SR	4X2	2-1/4	1	8	086	91.59
867SV-421SR	4X2-1/2	3	1	4	086	94.63
867SV-422SR	4X3	3	1	4	086	99.47
867SV-521SR	6X1/4	1-1/8	1	8	086	137.47
867SV-523SR	6X1/2	1-1/8	1	4	086	134.53
867SV-524SR	6X3/4	1-1/8	1	4	086	134.53
867SV-525SR	6X1	1-1/8	1	4	086	134.53
867SV-526SR	6X1-1/4	2-1/4	1	4	086	134.53
867SV-527SR	6X1-1/2	2-1/4	1	4	086	134.53
867SV-528SR	6X2	2-1/4	1	4	086	134.53
867SV-529SR	6X2-1/2	3	1	4	086	145.76
867SV-530SR	6X3	3	1	4	086	152.49
867SV-532SR	6X4	4	1	4	086	157.86
867SV-571SR	8X1/4	4	1	0	086	250.09
867SV-573SR	8X1/2	4	1	0	086	240.42
867SV-574SR	8X3/4	4	1	0	086	240.42
867SV-575SR	8X1	4	1	0	086	240.42
867SV-576SR	8X1-1/4	4	1	0	086	240.42
867SV-577SR	8X1-1/2	4	1	0	086	240.42
867SV-578SR	8X2	4	1	0	086	240.42
867SV-579SR	8X2-1/2	4	1	0	086	264.46
867SV-580SR	8X3	4	1	0	086	277.68
867SV-582SR	8X4	4	1	1	086	294.34
867SV-585SR	8X6	6	1	0	086	322.57
867SV-624SR	10X4	4	1	1	086	350.14
867SV-626SR	10X6	6	1	1	086	402.87

PVC/CPVC Clamp-On & Hot-Tap Saddles



Part Number	Size	Hole Saw Dia	Std Pk	Mstr Ctn	Disc Code	Price Each
-------------	------	--------------	--------	----------	-----------	------------

PVC Gray Clamp-On Saddle x SR Thread Single Outlet (continued)
with Viton® O-ring Seal & SS Hardware

867SV-664SR	12X4	4	1	1	086	439.10
867SV-666SR	12X6	6	1	1	086	509.29

¹Outlet-sized with Bushing

PVC Gray Clamp-On Saddle x SR Thread Single Outlet
with EPDM O-ring Seal & Zinc-Plated Hardware

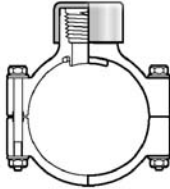

2"-4" 235, 6" 200, 8"-12" 150 psi @ 73°F (23°C)

867-247SR	2X1/2	3/4	1	10	086	28.38
867-248SR	2X3/4	7/8	1	10	086	28.38
867-249SR	2X1	1-1/8	1	10	086	28.38
867-250SR	2X1-1/4	1-1/2	1	10	086	28.38
867-251SR	2X1-1/2	1-1/2	1	10	086	28.38
867-291SR	2-1/2X1-1/2	1-3/4	1	10	086	38.78
867-333SR	3X1/2	7/8	1	10	086	38.78
867-334SR	3X3/4	7/8	1	10	086	38.78
867-335SR	3X1	1-1/8	1	10	086	38.78
867-336SR	3X1-1/4	2-1/4	1	10	086	38.78
867-337SR	3X1-1/2	2-1/4	1	10	086	38.78
867-338SR	3X2	2-1/4	1	10	086	38.78
867-415SR	4X1/2	1-1/8	1	10	086	48.86
867-416SR	4X3/4	1-1/8	1	10	086	48.86
867-417SR	4X1	1-1/8	1	8	086	48.86
867-418SR	4X1-1/4	1-3/4	1	8	086	48.86
867-419SR	4X1-1/2	1-3/4	1	8	086	48.86
867-420SR	4X2	2-1/4	1	8	086	48.86
867-421SR	4X2-1/2	3	1	4	086	50.01
867-422SR	4X3	3	1	4	086	57.32
867-523SR	6X1/2	1-1/8	1	4	086	81.41
867-524SR	6X3/4	1-1/8	1	4	086	81.41
867-525SR	6X1	1-1/8	1	4	086	81.41
867-526SR	6X1-1/4	2-1/4	1	4	086	81.41
867-527SR	6X1-1/2	2-1/4	1	4	086	81.41
867-528SR	6X2	2-1/4	1	4	086	81.41
867-529SR	6X2-1/2	3	1	4	086	101.13
867-530SR	6X3	3	1	4	086	108.88
867-532SR	6X4	4	1	4	086	114.01
867-573SR	8X1/2	4	1	0	086	172.33
867-574SR	8X3/4	4	1	0	086	172.33
867-575SR	8X1	4	1	0	086	172.33
867-576SR	8X1-1/4	4	1	0	086	172.33
867-577SR	8X1-1/2	4	1	0	086	172.33
867-578SR	8X2	4	1	0	086	172.33
867-579SR	8X2-1/2	4	1	0	086	189.59
867-580SR	8X3	4	1	0	086	198.98
867-582SR	8X4	4	1	1	086	210.96
867-585SR	8X6	6	1	0	086	242.97

Part Number	Size	Hole Saw Dia	Std Pk	Mstr Ctn	Disc Code	Price Each
-------------	------	--------------	--------	----------	-----------	------------

PVC Gray Clamp-On Saddle x SR Thread Single Outlet (continued)
with EPDM O-ring Seal & Zinc-Plated Hardware

867-624SR	10X4	4	1	1	086	250.96
867-626SR	10X6	4	1	1	086	288.64
867-664SR	12X4	4	1	1	086	314.49
867-666SR	12X6	6	1	1	086	365.02

¹Outlet-sized with Bushing

PVC Gray Clamp-On Saddle x SR Thread Single Outlet
with EPDM O-ring Seal & SS Hardware

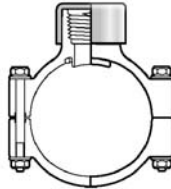

2"-4" 235, 6" 200, 8"-12" 150 psi @ 73°F (23°C)

867S-245SR	2X1/4	1-1/8	1	10	086	54.27
867S-247SR	2X1/2	3/4	1	10	086	48.49
867S-248SR	2X3/4	7/8	1	10	086	48.49
867S-249SR	2X1	1-1/8	1	10	086	48.49
867S-250SR	2X1-1/4	1-1/2	1	10	086	48.49
867S-251SR	2X1-1/2	1-1/2	1	10	086	48.49
867S-291SR	2-1/2X1-1/2	1-3/4	1	10	086	65.20
867S-331SR	3X1/4	1-1/8	1	10	086	72.12
867S-333SR	3X1/2	7/8	1	10	086	65.20
867S-334SR	3X3/4	7/8	1	10	086	65.20
867S-335SR	3X1	1-1/8	1	10	086	65.20
867S-336SR	3X1-1/4	2-1/4	1	10	086	65.20
867S-337SR	3X1-1/2	2-1/4	1	10	086	65.20
867S-338SR	3X2	2-1/4	1	10	086	65.20
867S-413SR	4X1/4		1	8	086	84.86
867S-415SR	4X1/2	1-1/8	1	10	086	82.09
867S-416SR	4X3/4	1-1/8	1	10	086	82.09
867S-417SR	4X1	1-1/8	1	8	086	82.09
867S-418SR	4X1-1/4	1-3/4	1	8	086	82.09
867S-419SR	4X1-1/2	1-3/4	1	8	086	82.09
867S-420SR	4X2	2-1/4	1	8	086	82.09
867S-421SR	4X2-1/2	3	1	4	086	85.92
867S-422SR	4X3	3	1	4	086	92.60
867S-521SR	6X1/4	1-1/8	1	8	086	130.21
867S-523SR	6X1/2	1-1/8	1	4	086	118.67
867S-524SR	6X3/4	1-1/8	1	4	086	118.67
867S-525SR	6X1	1-1/8	1	4	086	118.67
867S-526SR	6X1-1/4	2-1/4	1	4	086	118.67
867S-527SR	6X1-1/2	2-1/4	1	4	086	118.67
867S-528SR	6X2	2-1/4	1	4	086	118.67
867S-529SR	6X2-1/2	3	1	4	086	135.46
867S-530SR	6X3	3	1	4	086	139.86
867S-532SR	6X4	4	1	4	086	145.68
867S-571SR	8X1/4	4	1	0	086	257.10
867S-573SR	8X1/2	4	1	1	086	220.04
867S-574SR	8X3/4	4	1	1	086	220.04
867S-575SR	8X1	4	1	0	086	220.04



PVC/CPVC Clamp-On & Hot-Tap Saddles

Part Number	Size	Hole Saw Dia	Std Pk	Mstr Ctn	Disc Code	Price Each
-------------	------	--------------	--------	----------	-----------	------------

PVC Gray Clamp-On Saddle x SR Thread Single Outlet (continued) with EPDM O-ring Seal & SS Hardware

867S-576SR	8X1-1/4	4	1	0	086	220.04
867S-577SR	8X1-1/2	4	1	0	086	220.04
867S-578SR	8X2	4	1	0	086	220.04
867S-579SR	8X2-1/2	4	1	0	086	245.47
867S-580SR	8X3	4	1	0	086	259.41
867S-582SR	8X4	4	1	1	086	274.07
867S-585SR	8X6	6	1	0	086	287.71
867S-624SR	10X4	4	1	1	086	309.00
867S-626SR	10X6	6	1	1	086	355.21
867S-664SR	12X4	4	1	1	086	387.26
867S-666SR	12X6	6	1	1	086	449.21

¹Outlet-sized with Bushing

PVC Gray Clamp-On Saddle x Soc Double Outlet with Viton® O-ring Seal & Zinc-Plated Hardware

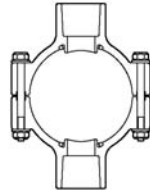

2"-4" 235, 6" 200, 8"-12" 150 psi @ 73°F (23°C)

868V-247	2X1/2	3/4	1	10	086	35.36
868V-248	2X3/4	7/8	1	10	086	35.36
868V-249	2X1	1-1/8	1	10	086	35.36
868V-250	2X1-1/4	1-1/2	1	10	086	35.36
868V-251	2X1-1/2	1-1/2	1	10	086	35.36
868V-291	2-1/2X1-1/2	1-3/4	1	10	086	45.30
868V-333	3X1/2	7/8	1	10	086	45.30
868V-334	3X3/4	7/8	1	10	086	45.30
868V-335	3X1	1-1/8	1	10	086	45.30
868V-336	3X1-1/4	2-1/4	1	10	086	45.30
868V-337	3X1-1/2	2-1/4	1	10	086	45.30
868V-338	3X2	2-1/4	1	10	086	45.30
868V-415	4X1/2	1-1/8	1	10	086	60.48
868V-416	4X3/4	1-1/8	1	10	086	60.48
868V-417	4X1	1-1/8	1	8	086	60.48
868V-418	4X1-1/4	1-3/4	1	8	086	60.48
868V-419	4X1-1/2	1-3/4	1	8	086	60.48
868V-420	4X2	2-1/4	1	8	086	60.48
868V-421	4X2-1/2	3	1	4	086	65.74
868V-422	4X3	3	1	4	086	70.88
868V-523	6X1/2	1-1/8	1	4	086	99.30
868V-524	6X3/4	1-1/8	1	4	086	99.30
868V-525	6X1	1-1/8	1	4	086	99.30
868V-526	6X1-1/4	2-1/4	1	4	086	99.30
868V-527	6X1-1/2	2-1/4	1	4	086	99.30
868V-528	6X2	2-1/4	1	4	086	99.30
868V-529	6X2-1/2	3	1	4	086	103.10
868V-530	6X3	3	1	4	086	108.74
868V-532	6X4	4	1	4	086	116.22
868V-573	8X1/2	4	1	0	086	208.80

Part Number	Size	Hole Saw Dia	Std Pk	Mstr Ctn	Disc Code	Price Each
-------------	------	--------------	--------	----------	-----------	------------

PVC Gray Clamp-On Saddle x Soc Double Outlet (continued) with Viton® O-ring Seal & Zinc-Plated Hardware

868V-574	8X3/4	4	1	0	086	208.80
868V-575	8X1	4	1	1	086	208.80
868V-576	8X1-1/4	4	1	0	086	208.80
868V-577	8X1-1/2	4	1	0	086	208.80
868V-578	8X2	4	1	0	086	208.80
868V-579	8X2-1/2	4	1	0	086	219.04
868V-580	8X3	4	1	0	086	230.16
868V-582	8X4	4	1	1	086	243.89
868V-585	8X6	6	1	1	086	270.73
868V-624	10X4	4	1	1	086	322.21
868V-626	10X6	6	1	1	086	300.04
868V-664	12X4	4	1	0	086	403.88
868V-666	12X6	6	1	1	086	468.41

¹Outlet-sized with Bushing

PVC Gray Clamp-On Saddle x Soc Double Outlet with Viton® O-ring Seal & SS Hardware

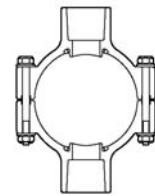

2"-4" 235, 6" 200, 8"-12" 150 psi @ 73°F (23°C)

868SV-247	2X1/2	3/4	1	10	086	56.88
868SV-248	2X3/4	7/8	1	10	086	56.88
868SV-249	2X1	1-1/8	1	10	086	56.88
868SV-250	2X1-1/4	1-1/2	1	10	086	56.88
868SV-251	2X1-1/2	1-1/2	1	10	086	56.88
868SV-291	2-1/2X1-1/2	1-3/4	1	10	086	75.59
868SV-333	3X1/2	7/8	1	10	086	75.59
868SV-334	3X3/4	7/8	1	10	086	75.59
868SV-335	3X1	1-1/8	1	10	086	75.59
868SV-336	3X1-1/4	2-1/4	1	10	086	75.59
868SV-337	3X1-1/2	2-1/4	1	10	086	75.59
868SV-338	3X2	2-1/4	1	10	086	75.59
868SV-415	4X1/2	1-1/8	1	10	086	96.78
868SV-416	4X3/4	1-1/8	1	10	086	96.78
868SV-417	4X1	1-1/8	1	8	086	96.78
868SV-418	4X1-1/4	1-3/4	1	8	086	96.78
868SV-419	4X1-1/2	1-3/4	1	8	086	96.78
868SV-420	4X2	2-1/4	1	16	086	96.78
868SV-421	4X2-1/2	3	1	4	086	103.92
868SV-422	4X3	3	1	4	086	108.23
868SV-523	6X1/2	1-1/8	1	4	086	149.92
868SV-524	6X3/4	1-1/8	1	4	086	149.92
868SV-525	6X1	1-1/8	1	4	086	149.92
868SV-526	6X1-1/4	2-1/4	1	4	086	149.92
868SV-527	6X1-1/2	2-1/4	1	4	086	149.92
868SV-528	6X2	2-1/4	1	4	086	149.92
868SV-529	6X2-1/2	3	1	4	086	158.91
868SV-530	6X3	3	1	4	086	163.32

PVC/CPVC Clamp-On & Hot-Tap Saddles



Part Number	Size	Hole Saw Dia	Std Pk	Mstr Ctn	Disc Code	Price Each
-------------	------	--------------	--------	----------	-----------	------------

PVC Gray Clamp-On Saddle x Soc Double Outlet (continued)
with Viton® O-ring Seal & SS Hardware

868SV-532	6X4	4	1	4	086	168.07
868SV-573	8X1/2	4	1	0	086	280.27
868SV-574	8X3/4	4	1	0	086	280.27
868SV-575	8X1	4	1	1	086	280.27
868SV-576	8X1-1/4	4	1	0	086	280.27
868SV-577	8X1-1/2	4	1	0	086	280.27
868SV-578	8X2	4	1	0	086	280.27
868SV-579	8X2-1/2	4	1	0	086	308.29
868SV-580	8X3	4	1	0	086	323.67
868SV-582	8X4	4	1	1	086	325.24
868SV-585	8X6	6	1	1	086	380.77
868SV-624	10X4	4	1	1	086	453.11
868SV-626	10X6	6	1	1	086	521.12
868SV-664	12X4	4	1	0	086	567.98
868SV-666	12X6	6	1	1	086	658.87

¹Outlet-sized with Bushing

PVC Gray Clamp-On Saddle x Soc Double Outlet
with EPDM O-ring Seal & Zinc-Plated Hardware

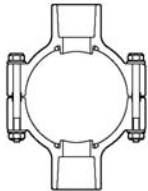

2"-4" 235, 6" 200, 8"-12" 150 psi @ 73°F (23°C)

868-247	2X1/2	3/4	1	10	086	32.36
868-248	2X3/4	7/8	1	10	086	32.36
868-249	2X1	1-1/8	1	10	086	32.36
868-250	2X1-1/4	1-1/2	1	10	086	32.36
868-251	2X1-1/2	1-1/2	1	10	086	32.36
868-291	2-1/2X1-1/2	1-3/4	1	10	086	44.48
868-333	3X1/2	7/8	1	10	086	44.48
868-334	3X3/4	7/8	1	10	086	44.48
868-335	3X1	1-1/8	1	10	086	44.48
868-336	3X1-1/4	2-1/4	1	10	086	44.48
868-337	3X1-1/2	2-1/4	1	10	086	44.48
868-338	3X2	2-1/4	1	10	086	44.48
868-415	4X1/2	1-1/8	1	10	086	56.12
868-416	4X3/4	1-1/8	1	10	086	56.12
868-417	4X1	1-1/8	1	8	086	56.12
868-418	4X1-1/4	1-3/4	1	8	086	56.12
868-419	4X1-1/2	1-3/4	1	8	086	56.12
868-420	4X2	2-1/4	1	8	086	56.12
868-421	4X2-1/2	3	1	4	086	60.26
868-422	4X3	3	1	4	086	63.77
868-523	6X1/2	1-1/8	1	4	086	93.74
868-524	6X3/4	1-1/8	1	4	086	93.74
868-525	6X1	1-1/8	1	4	086	93.74
868-526	6X1-1/4	2-1/4	1	4	086	93.74
868-527	6X1-1/2	2-1/4	1	4	086	93.74
868-528	6X2	2-1/4	1	4	086	93.74

Part Number	Size	Hole Saw Dia	Std Pk	Mstr Ctn	Disc Code	Price Each
-------------	------	--------------	--------	----------	-----------	------------

PVC Gray Clamp-On Saddle x Soc Double Outlet (continued)
with EPDM O-ring Seal & Zinc-Plated Hardware

868-529	6X2-1/2	3	1	4	086	99.07
868-530	6X3	3	1	4	086	104.70
868-532	6X4	4	1	4	086	108.89
868-573	8X1/2	4	1	0	086	175.30
868-574	8X3/4	4	1	0	086	175.30
868-575	8X1	4	1	1	086	175.30
868-576	8X1-1/4	4	1	0	086	175.30
868-577	8X1-1/2	4	1	0	086	175.30
868-578	8X2	4	1	1	086	175.30
868-579	8X2-1/2	4	1	0	086	192.19
868-580	8X3	4	1	0	086	201.71
868-582	8X4	4	1	1	086	213.69
868-585	8X6	6	1	0	086	237.38
868-624	10X4	4	1	1	086	282.43
868-626	10X6	6	1	1	086	324.89
868-664	12X4	4	1	0	086	354.04
868-666	12X6	6	1	1	086	410.66

¹Outlet-sized with Bushing

PVC Gray Clamp-On Saddle x Soc Double Outlet
with EPDM O-ring Seal & SS Hardware

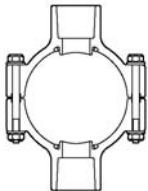

2"-4" 235, 6" 200, 8"-12" 150 psi @ 73°F (23°C)

868S-247	2X1/2	3/4	1	10	086	49.34
868S-248	2X3/4	7/8	1	10	086	49.34
868S-249	2X1	1-1/8	1	10	086	49.34
868S-250	2X1-1/4	1-1/2	1	10	086	49.34
868S-251	2X1-1/2	1-1/2	1	10	086	49.34
868S-291	2-1/2X1-1/2	1-3/4	1	10	086	66.31
868S-333	3X1/2	7/8	1	10	086	66.31
868S-334	3X3/4	7/8	1	10	086	66.31
868S-335	3X1	1-1/8	1	10	086	66.31
868S-336	3X1-1/4	2-1/4	1	10	086	66.31
868S-337	3X1-1/2	2-1/4	1	10	086	66.31
868S-338	3X2	2-1/4	1	10	086	66.31
868S-415	4X1/2	1-1/8	1	10	086	85.38
868S-416	4X3/4	1-1/8	1	10	086	85.38
868S-417	4X1	1-1/8	1	8	086	85.38
868S-418	4X1-1/4	1-3/4	1	8	086	85.38
868S-419	4X1-1/2	1-3/4	1	8	086	85.38
868S-420	4X2	2-1/4	1	8	086	85.38
868S-421	4X2-1/2	3	1	4	086	92.66
868S-422	4X3	3	1	4	086	95.14
868S-523	6X1/2	1-1/8	1	4	086	142.30
868S-524	6X3/4	1-1/8	1	4	086	142.30
868S-525	6X1	1-1/8	1	4	086	142.30
868S-526	6X1-1/4	2-1/4	1	4	086	142.30



PVC/CPVC Clamp-On & Hot-Tap Saddles

Part Number	Size	Hole Saw Dia	Std Pk	Mstr Ctn	Disc Code	Price Each
-------------	------	--------------	--------	----------	-----------	------------

PVC Gray Clamp-On Saddle x Soc Double Outlet (continued) with EPDM O-ring Seal & SS Hardware

868S-527	6X1-1/2	2-1/4	1	4	086	142.30
868S-528	6X2	2-1/4	1	4	086	142.30
868S-529	6X2-1/2	3	1	4	086	147.12
868S-530	6X3	3	1	4	086	153.09
868S-532	6X4	4	1	4	086	159.19
868S-573	8X1/2	4	1	0	086	263.23
868S-574	8X3/4	4	1	0	086	263.23
868S-575	8X1	4	1	1	086	263.23
868S-576	8X1-1/4	4	1	0	086	263.23
868S-577	8X1-1/2	4	1	0	086	263.23
868S-578	8X2	4	1	0	086	263.23
868S-579	8X2-1/2	4	1	0	086	289.66
868S-580	8X3	4	1	0	086	304.23
868S-582	8X4	4	1	1	086	320.99
868S-585	8X6	6	1	1	086	282.88
868S-624	10X4	4	1	1	086	425.97
868S-626	10X6	6	1	1	086	489.86
868S-664	12X4	4	1	1	086	533.98
868S-666	12X6	6	1	1	086	619.31

¹Outlet-sized with Bushing

PVC Gray Clamp-On Saddle x SR Thread Double Outlet with Viton® O-ring Seal & Zinc-Plated Hardware

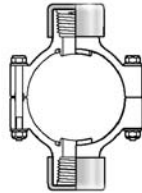

2"-4" 235, 6" 200, 8"-12" 150 psi @ 73°F (23°C)

869V-247SR	2X1/2	3/4	1	10	086	39.36
869V-248SR	2X3/4	7/8	1	10	086	39.36
869V-249SR	2X1	1-1/8	1	10	086	39.36
869V-250SR	2X1-1/4	1-1/2	1	10	086	39.36
869V-251SR	2X1-1/2	1-1/2	1	10	086	39.36
869V-291SR	2-1/2X1-1/2	1-3/4	1	10	086	54.11
869V-333SR	3X1/2	7/8	1	10	086	54.11
869V-334SR	3X3/4	7/8	1	10	086	54.11
869V-335SR	3X1	1-1/8	1	10	086	54.11
869V-336SR	3X1-1/4	2-1/4	1	10	086	54.11
869V-337SR	3X1-1/2	2-1/4	1	10	086	54.11
869V-338SR	3X2	2-1/4	1	10	086	54.11
869V-415SR	4X1/2	1-1/8	1	10	086	67.19
869V-416SR	4X3/4	1-1/8	1	10	086	67.19
869V-417SR	4X1	1-1/8	1	8	086	67.19
869V-418SR	4X1-1/4	1-3/4	1	8	086	67.19
869V-419SR	4X1-1/2	1-3/4	1	8	086	67.19
869V-420SR	4X2	2-1/4	1	8	086	67.19
869V-421SR	4X2-1/2	3	1	4	086	72.23
869V-422SR	4X3	3	1	4	086	76.31
869V-523SR	6X1/2	1-1/8	1	4	086	113.79
869V-524SR	6X3/4	1-1/8	1	4	086	113.79

Part Number	Size	Hole Saw Dia	Std Pk	Mstr Ctn	Disc Code	Price Each
-------------	------	--------------	--------	----------	-----------	------------

PVC Gray Clamp-On Saddle x SR Thread Double Outlet (continued) with Viton® O-ring Seal & Zinc-Plated Hardware

869V-525SR	6X1	1-1/8	1	4	086	113.79
869V-526SR	6X1-1/4	2-1/4	1	4	086	113.79
869V-527SR	6X1-1/2	2-1/4	1	4	086	113.79
869V-528SR	6X2	2-1/4	1	4	086	113.79
869V-529SR	6X2-1/2	3	1	4	086	137.46
869V-530SR	6X3	3	1	4	086	145.27
869V-532SR	6X4	4	1	4	086	152.59
869V-573SR	8X1/2	4	1	0	086	230.44
869V-574SR	8X3/4	4	1	0	086	230.44
869V-575SR	8X1	4	1	0	086	230.44
869V-576SR	8X1-1/4	4	1	0	086	230.44
869V-577SR	8X1-1/2	4	1	0	086	230.44
869V-578SR	8X2	4	1	0	086	230.44
869V-579SR	8X2-1/2	4	1	0	086	253.56
869V-580SR	8X3	4	1	0	086	266.26
869V-582SR	8X4	4	1	1	086	282.29
869V-585SR	8X6	6	1	0	086	328.60
869V-624SR	10X4	4	1	1	086	335.86
869V-626SR	10X6	6	1	1	086	386.24
869V-664SR	12X4	4	1	1	086	421.04
869V-666SR	12X6	6	1	1	086	489.92

¹Outlet-sized with Bushing

PVC Gray Clamp-On Saddle x SR Thread Double Outlet with Viton® O-ring Seal & SS Hardware

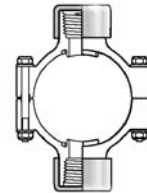

2"-4" 235, 6" 200, 8"-12" 150 psi @ 73°F (23°C)

869SV-247SR	2X1/2	3/4	1	10	086	63.26
869SV-248SR	2X3/4	7/8	1	10	086	63.26
869SV-249SR	2X1	1-1/8	1	10	086	63.26
869SV-250SR	2X1-1/4	1-1/2	1	10	086	63.26
869SV-251SR	2X1-1/2	1-1/2	1	10	086	63.26
869SV-291SR	2-1/2X1-1/2	1-3/4	1	10	086	83.93
869SV-333SR	3X1/2	7/8	1	10	086	83.93
869SV-335SR	3X1	1-1/8	1	10	086	83.93
869SV-334SR	3X3/4	7/8	1	10	086	83.93
869SV-336SR	3X1-1/4	2-1/4	1	10	086	83.93
869SV-337SR	3X1-1/2	2-1/4	1	10	086	83.93
869SV-338SR	3X2	2-1/4	1	10	086	83.93
869SV-415SR	4X1/2	1-1/8	1	10	086	105.52
869SV-416SR	4X3/4	1-1/8	1	10	086	105.52
869SV-417SR	4X1	1-1/8	1	8	086	105.52
869SV-418SR	4X1-1/4	1-3/4	1	8	086	105.52
869SV-419SR	4X1-1/2	1-3/4	1	8	086	105.52
869SV-420SR	4X2	2-1/4	1	8	086	105.52
869SV-421SR	4X2-1/2	3	1	4	086	111.14
869SV-422SR	4X3	3	1	4	086	116.81

PVC/CPVC Clamp-On & Hot-Tap Saddles



Part Number	Size	Hole Saw Dia	Std Pk	Mstr Ctn	Disc Code	Price Each
-------------	------	--------------	--------	----------	-----------	------------

PVC Gray Clamp-On Saddle x SR Thread Double Outlet (continued) with Viton® O-ring Seal & SS Hardware

869SV-523SR	6X1/2	1-1/8	1	4	086	175.82
869SV-524SR	6X3/4	1-1/8	1	4	086	175.82
869SV-525SR	6X1	1-1/8	1	4	086	175.82
869SV-526SR	6X1-1/4	2-1/4	1	4	086	175.82
869SV-527SR	6X1-1/2	2-1/4	1	4	086	175.82
869SV-528SR	6X2	2-1/4	1	4	086	175.82
869SV-529SR	6X2-1/2	3	1	4	086	188.24
869SV-530SR	6X3	3	1	4	086	200.22
869SV-532SR	6X4	4	1	4	086	205.43
869SV-573SR	8X1/2	4	1	0	086	296.87
869SV-574SR	8X3/4	4	1	0	086	296.87
869SV-575SR	8X1	4	1	0	086	296.87
869SV-576SR	8X1-1/4	4	1	0	086	296.87
869SV-577SR	8X1-1/2	4	1	0	086	296.87
869SV-578SR	8X2	4	1	0	086	296.87
869SV-579SR	8X2-1/2	4	1	0	086	326.47
869SV-580SR	8X3	4	1	0	086	342.79
869SV-582SR	8X4	4	1	1	086	363.44
869SV-585SR	8X6	6	1	0	086	396.87
869SV-624SR	10X4	4	1	1	086	432.46
869SV-626SR	10X6	4	1	1	086	497.36
869SV-664SR	12X4	4	1	1	086	542.04
869SV-666SR	12X6	6	1	1	086	628.84

¹Outlet-sized with Bushing

PVC Gray Clamp-On Saddle x SR Thread Double Outlet with EPDM O-ring Seal & Zinc-Plated Hardware

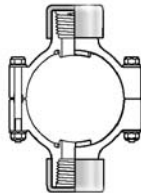

2"-4" 235, 6" 200, 8"-12" 150 psi @ 73°F (23°C)

869-247SR	2X1/2	3/4	1	10	086	35.26
869-248SR	2X3/4	7/8	1	10	086	35.26
869-249SR	2X1	1-1/8	1	10	086	35.26
869-250SR	2X1-1/4	1-1/2	1	10	086	35.26
869-251SR	2X1-1/2	1-1/2	1	10	086	35.26
869-291SR	2-1/2X1-1/2	1-3/4	1	10	086	47.48
869-333SR	3X1/2	7/8	1	10	086	47.48
869-334SR	3X3/4	7/8	1	10	086	47.48
869-335SR	3X1	1-1/8	1	10	086	47.48
869-336SR	3X1-1/4	1-1/8	1	10	086	47.48
869-337SR	3X1-1/2	2-1/4	1	10	086	47.48
869-338SR	3X2	2-1/4	1	10	086	47.48
869-415SR	4X1/2	1-1/8	1	10	086	59.36
869-416SR	4X3/4	1-1/8	1	10	086	59.36
869-417SR	4X1	1-1/8	1	8	086	59.36
869-418SR	4X1-1/4	1-3/4	1	8	086	59.36
869-419SR	4X1-1/2	1-3/4	1	8	086	59.36
869-420SR	4X2	2-1/4	1	8	086	59.36

Made in the U.S.A.

Part Number	Size	Hole Saw Dia	Std Pk	Mstr Ctn	Disc Code	Price Each
-------------	------	--------------	--------	----------	-----------	------------

PVC Gray Clamp-On Saddle x SR Thread Double Outlet (continued) with EPDM O-ring Seal & Zinc-Plated Hardware

869-421SR	4X2-1/2	3	1	4	086	64.92
869-422SR	4X3	3	1	4	086	68.91
869-523SR	6X1/2	1-1/8	1	4	086	98.93
869-524SR	6X3/4	1-1/8	1	4	086	98.93
869-525SR	6X1	1-1/8	1	4	086	98.93
869-526SR	6X1-1/4	2-1/4	1	4	086	98.93
869-527SR	6X1-1/2	2-1/4	1	4	086	98.93
869-528SR	6X2	2-1/4	1	4	086	98.93
869-529SR	6X2-1/2	3	1	4	086	122.69
869-530SR	6X3	3	1	4	086	129.93
869-532SR	6X4	4	1	4	086	144.78
869-573SR	8X1/2	4	1	0	086	212.69
869-574SR	8X3/4	4	1	0	086	212.69
869-575SR	8X1	4	1	0	086	212.69
869-576SR	8X1-1/4	4	1	0	086	212.69
869-577SR	8X1-1/2	4	1	0	086	212.69
869-578SR	8X2	4	1	0	086	212.69
869-579SR	8X2-1/2	4	1	0	086	234.07
869-580SR	8X3	4	1	0	086	245.47
869-582SR	8X4	4	1	1	086	260.33
869-585SR	8X6	6	1	0	086	294.12
869-624SR	10X4	4	1	1	086	309.71
869-626SR	10X6	6	1	1	086	356.22
869-664SR	12X4	4	1	1	086	388.42
869-666SR	12X6	6	1	1	086	450.52

¹Outlet-sized with Bushing

PVC Gray Clamp-On Saddle x SR Thread Double Outlet with EPDM O-ring Seal & SS Hardware

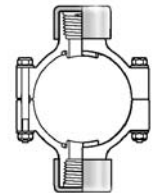

2"-4" 235, 6" 200, 8"-12" 150 psi @ 73°F (23°C)

869S-247SR	2X1/2	3/4	1	10	086	56.74
869S-248SR	2X3/4	7/8	1	10	086	56.74
869S-249SR	2X1	1-1/8	1	10	086	56.74
869S-250SR	2X1-1/4	1-1/2	1	10	086	56.74
869S-251SR	2X1-1/2	1-1/2	1	10	086	56.74
869S-291SR	2-1/2X1-1/2	1-3/4	1	10	086	75.63
869S-333SR	3X1/2	7/8	1	10	086	75.63
869S-334SR	3X3/4	7/8	1	10	086	75.63
869S-335SR	3X1	1-1/8	1	10	086	75.63
869S-336SR	3X1-1/4	2-1/4	1	10	086	75.63
869S-337SR	3X1-1/2	2-1/4	1	10	086	75.63
869S-338SR	3X2	2-1/4	1	10	086	75.63
869S-415SR	4X1/2	1-1/8	1	10	086	94.76
869S-416SR	4X3/4	1-1/8	1	10	086	94.76
869S-417SR	4X1	1-1/8	1	8	086	94.76
869S-418SR	4X1-1/4	1-3/4	1	8	086	94.76



PVC/CPVC Clamp-On & Hot-Tap Saddles

Part Number	Size	Hole Saw Dia	Std Pk	Mstr Ctn	Disc Code	Price Each
-------------	------	--------------	--------	----------	-----------	------------

PVC Gray Clamp-On Saddle x SR Thread Double Outlet (continued) with EPDM O-ring Seal & SS Hardware

869S-419SR	4X1-1/2	1-3/4	1	8	086	94.76
869S-420SR	4X2	2-1/4	1	8	086	94.76
869S-421SR	4X2-1/2	3	1	4	086	101.23
869S-422SR	4X3	3	1	4	086	105.76
869S-523SR	6X1/2	1-1/8	1	4	086	157.86
869S-524SR	6X3/4	1-1/8	1	4	086	157.86
869S-525SR	6X1	1-1/8	1	4	086	157.86
869S-526SR	6X1-1/4	2-1/4	1	4	086	157.86
869S-527SR	6X1-1/2	2-1/4	1	4	086	157.86
869S-528SR	6X2	2-1/4	1	4	086	157.86
869S-529SR	6X2-1/2	3	1	4	086	165.66
869S-530SR	6X3	3	1	4	086	172.46
869S-532SR	6X4	4	1	4	086	177.93
869S-573SR	8X1/2	4	1	0	086	271.68
869S-574SR	8X3/4	4	1	0	086	271.68
869S-575SR	8X1	4	1	0	086	271.68
869S-576SR	8X1-1/4	4	1	0	086	271.68
869S-577SR	8X1-1/2	4	1	0	086	271.68
869S-578SR	8X2	4	1	0	086	271.68
869S-579SR	8X2-1/2	4	1	0	086	285.18
869S-580SR	8X3	4	1	0	086	302.37
869S-582SR	8X4	4	1	1	086	320.56
869S-585SR	8X6	6	1	0	086	351.89
869S-624SR	10X4	4	1	1	086	309.71
869S-626SR	10X6	6	1	1	086	438.68
869S-664SR	12X4	4	1	1	086	478.23
869S-666SR	12X6	6	1	1	086	554.68

¹Outlet-sized with Bushing

CPVC Gray Clamp-On Saddle x Soc Single Outlet with Viton® O-ring Seal & Zinc-Plated Hardware

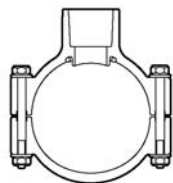

2"-4" 235, 6" 200, 8"-12" 150 psi @ 73°F (23°C)

866V-247C	2X1/2	3/4	1	10	096	47.59
866V-248C	2X3/4	7/8	1	10	096	47.59
866V-249C	2X1	1-1/8	1	10	096	47.59
866V-250C	2X1-1/4	1-1/2	1	10	096	47.59
866V-251C	2X1-1/2	1-1/2	1	10	096	47.59
866V-291C	2-1/2X1-1/2	1-3/4	1	10	096	66.13
866V-333C	3X1/2	7/8	1	10	096	66.13
866V-334C	3X3/4	7/8	1	10	096	66.13
866V-335C	3X1	1-1/8	1	10	096	66.13
866V-336C	3X1-1/4	2-1/4	1	10	096	66.13
866V-337C	3X1-1/2	2-1/4	1	10	096	66.13
866V-338C	3X2	2-1/4	1	10	096	66.13
866V-415C	4X1/2	1-1/8	1	10	096	79.48
866V-416C	4X3/4	1-1/8	1	10	096	79.48

Part Number	Size	Hole Saw Dia	Std Pk	Mstr Ctn	Disc Code	Price Each
-------------	------	--------------	--------	----------	-----------	------------

CPVC Gray Clamp-On Saddle x Soc Single Outlet (continued) with Viton® O-ring Seal & Zinc-Plated Hardware

866V-417C	4X1	1-1/8	1	8	096	79.48
866V-418C	4X1-1/4	1-3/4	1	8	096	79.48
866V-419C	4X1-1/2	1-3/4	1	8	096	79.48
866V-420C	4X2	2-1/4	1	8	096	79.48
866V-421C	4X2-1/2	3	1	4	096	85.33
866V-422C	4X3	3	1	4	096	93.03
866V-523C	6X1/2	1-1/8	1	4	096	132.48
866V-524C	6X3/4	1-1/8	1	4	096	132.48
866V-525C	6X1	1-1/8	1	4	096	132.48
866V-526C	6X1-1/4	2-1/4	1	4	096	132.48
866V-527C	6X1-1/2	2-1/4	1	4	096	132.48
866V-528C	6X2	2-1/4	1	4	096	132.48
866V-529C	6X2-1/2	3	1	4	096	143.38
866V-530C	6X3	3	1	4	096	152.64
866V-532C	6X4	4	1	4	096	162.63
866V-573C	8X1/2	4	1	0	096	282.57
866V-574C	8X3/4	4	1	0	096	282.57
866V-575C	8X1	4	1	1	096	282.57
866V-576C	8X1-1/4	4	1	0	096	282.57
866V-577C	8X1-1/2	4	1	0	096	282.57
866V-578C	8X2	4	1	1	096	282.57
866V-579C	8X2-1/2	4	1	0	096	310.88
866V-580C	8X3	4	1	0	096	326.19
866V-582C	8X4	4	1	1	096	355.21
866V-585C	8X6	6	1	1	096	488.38
866V-624C	10X4	4	1	1	096	456.87
866V-626C	10X6	6	1	1	096	525.30
866V-664C	12X4	4	1	1	096	572.67
866V-666C	12X6	6	1	1	096	607.02

¹Outlet-sized with Bushing

CPVC Gray Clamp-On Saddle x Soc Single Outlet with Viton® O-ring Seal & SS Hardware

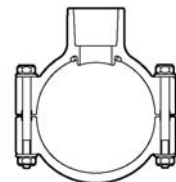

2"-4" 235, 6" 200, 8"-12" 150 psi @ 73°F (23°C)

866SV-247C	2X1/2	3/4	1	10	096	72.63
866SV-248C	2X3/4	7/8	1	10	096	72.63
866SV-249C	2X1	1-1/8	1	10	096	72.63
866SV-250C	2X1-1/4	1-1/2	1	10	096	72.63
866SV-251C	2X1-1/2	1-1/2	1	10	096	72.63
866SV-291C	2-1/2X1-1/2	1-3/4	1	10	096	97.29
866SV-333C	3X1/2	7/8	1	10	096	97.29
866SV-334C	3X3/4	7/8	1	10	096	97.29
866SV-335C	3X1	1-1/8	1	10	096	97.29
866SV-336C	3X1-1/4	2-1/4	1	10	096	97.29
866SV-337C	3X1-1/2	2-1/4	1	10	096	97.29
866SV-338C	3X2	2-1/4	1	10	096	97.29

PVC/CPVC Clamp-On & Hot-Tap Saddles



Part Number	Size	Hole Saw Dia	Std Pk	Mstr Ctn	Disc Code	Price Each
-------------	------	--------------	--------	----------	-----------	------------

CPVC Gray Clamp-On Saddle x Soc Single Outlet (continued) with Viton® O-ring Seal & SS Hardware

866SV-415C	4X1/2	1-1/8	1	10	096	125.68
866SV-416C	4X3/4	1-1/8	1	10	096	125.68
866SV-417C	4X1	1-1/8	1	8	096	125.68
866SV-418C	4X1-1/4	1-3/4	1	8	096	125.68
866SV-419C	4X1-1/2	1-3/4	1	8	096	125.68
866SV-420C	4X2	2-1/4	1	8	096	125.68
866SV-421C	4X2-1/2	3	1	4	096	133.02
866SV-422C	4X3	3	1	4	096	139.79
866SV-523C	6X1/2	1-1/8	1	4	096	200.10
866SV-524C	6X3/4	1-1/8	1	4	096	200.10
866SV-525C	6X1	1-1/8	1	4	096	200.10
866SV-526C	6X1-1/4	2-1/4	1	4	096	200.10
866SV-527C	6X1-1/2	2-1/4	1	4	096	200.10
866SV-528C	6X2	2-1/4	1	4	096	200.10
866SV-529C	6X2-1/2	3	1	4	096	208.04
866SV-530C	6X3	3	1	4	096	215.26
866SV-532C	6X4	4	1	4	096	228.80
866SV-573C	8X1/2	4	1	0	096	369.21
866SV-574C	8X3/4	4	1	0	096	369.21
866SV-575C	8 X 1	4	1	1	096	369.21
866SV-576C	8X1-1/4	4	1	0	096	369.21
866SV-577C	8X1-1/2	4	1	0	096	369.21
866SV-578C	8 X 2	4	1	1	096	369.21
866SV-579C	8X2-1/2	4	1	0	096	390.80
866SV-580C	8X3	4	1	0	096	426.53
866SV-582C	8X4	4	1	1	096	452.10
866SV-585C	8X6	6	1	1	096	501.77
866SV-624C	10X4	4	1	1	096	597.07
866SV-626C	10X6	6	1	1	096	686.73
866SV-664C	12X4	4	1	1	096	748.40
866SV-666C	12X6	6	1	1	096	868.23

¹Outlet-sized with Bushing

CPVC Gray Clamp-On Saddle x Soc Single Outlet with EPDM O-ring Seal & Zinc-Plated Hardware

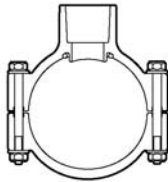

2"-4" 235, 6" 200, 8"-12" 150 psi @ 73°F (23°C)

866-247C	2X1/2	3/4	1	10	096	45.22
866-248C	2X3/4	7/8	1	10	096	45.22
866-249C	2X1	1-1/8	1	10	096	45.22
866-250C	2X1-1/4	1-1/2	1	10	096	45.22
866-251C	2X1-1/2	1-1/2	1	10	096	45.22
866-291C	2-1/2X1-1/2	1-3/4	1	10	096	60.58
866-333C	3X1/2	7/8	1	10	096	60.58
866-334C	3X3/4	7/8	1	10	096	60.58
866-335C	3X1	1-1/8	1	10	096	60.58
866-336C	3X1-1/4	2-1/4	1	10	096	60.58

Made in the U.S.A.

Part Number	Size	Hole Saw Dia	Std Pk	Mstr Ctn	Disc Code	Price Each
-------------	------	--------------	--------	----------	-----------	------------

CPVC Gray Clamp-On Saddle x Soc Single Outlet (continued) with EPDM O-ring Seal & Zinc-Plated Hardware

866-337C	3X1-1/2	2-1/4	1	10	096	60.58
866-338C	3X2	2-1/4	1	10	096	60.58
866-415C	4X1/2	1-1/8	1	10	096	73.66
866-416C	4X3/4	1-1/8	1	10	096	73.66
866-417C	4X1	1-1/8	1	8	096	73.66
866-418C	4X1-1/4	1-3/4	1	8	096	73.66
866-419C	4X1-1/2	1-3/4	1	8	096	73.66
866-420C	4X2	2-1/4	1	8	096	73.66
866-421C	4X2-1/2	3	1	4	096	80.91
866-422C	4X3	3	1	4	096	90.18
866-523C	6X1/2	1-1/8	1	4	096	122.92
866-524C	6X3/4	1-1/8	1	4	096	122.92
866-525C	6X1	1-1/8	1	4	096	122.92
866-526C	6X1-1/4	2-1/4	1	4	096	122.92
866-527C	6X1-1/2	2-1/4	1	4	096	122.92
866-528C	6X2	2-1/4	1	4	096	122.92
866-529C	6X2-1/2	3	1	4	096	133.63
866-530C	6X3	3	1	4	096	143.34
866-532C	6X4	4	1	4	096	153.19
866-573C	8X1/2	4	1	0	096	270.31
866-574C	8X3/4	4	1	0	096	270.31
866-575C	8X1	4	1	1	096	270.31
866-576C	8X1-1/4	4	1	0	096	270.31
866-577C	8X1-1/2	4	1	0	096	270.31
866-578C	8X2	4	1	1	096	270.31
866-579C	8X2-1/2	4	1	0	096	297.31
866-580C	8X3	4	1	0	096	312.26
866-582C	8X4	4	1	1	096	330.96
866-585C	8X6	6	1	1	096	367.34
866-624C	10X4	4	1	1	096	437.08
866-626C	10X6	4	1	1	096	502.70
866-664C	12X4	4	1	1	096	547.98
866-666C	12X6	6	1	1	096	635.62

¹Outlet-sized with Bushing

CPVC Gray Clamp-On Saddle x Soc Single Outlet with EPDM O-ring Seal & SS Hardware

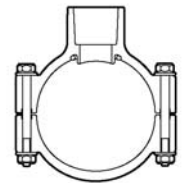

2"-4" 235, 6" 200, 8"-12" 150 psi @ 73°F (23°C)

866S-247C	2X1/2	3/4	1	10	096	70.41
866S-248C	2X3/4	7/8	1	10	096	70.41
866S-249C	2X1	1-1/8	1	10	096	70.41
866S-250C	2X1-1/4	1-1/2	1	10	096	70.41
866S-251C	2X1-1/2	1-1/2	1	10	096	70.41
866S-291C	2-1/2X1-1/2	1-3/4	1	10	096	93.86
866S-333C	3X1/2	7/8	1	10	096	93.86
866S-334C	3X3/4	7/8	1	10	096	93.86



PVC/CPVC Clamp-On & Hot-Tap Saddles

Part Number	Size	Hole Saw Dia	Std Pk	Mstr Ctn	Disc Code	Price Each
-------------	------	--------------	--------	----------	-----------	------------

CPVC Gray Clamp-On Saddle x Soc Single Outlet (continued) with EPDM O-ring Seal & SS Hardware

866S-335C	3X1	1-1/8	1	10	096	93.86
866S-336C	3X1-1/4	2-1/4	1	10	096	93.86
866S-337C	3X1-1/2	2-1/4	1	10	096	93.86
866S-338C	3X2	2-1/4	1	10	096	93.86
866S-415C	4X1/2	1-1/8	1	10	096	120.08
866S-416C	4X3/4	1-1/8	1	10	096	120.08
866S-417C	4X1	1-1/8	1	8	096	120.08
866S-418C	4X1-1/4	1-3/4	1	8	096	120.08
866S-419C	4X1-1/2	1-3/4	1	8	096	120.08
866S-420C	4X2	2-1/4	1	8	096	120.08
866S-421C	4X2-1/2	3	1	4	096	125.13
866S-422C	4X3	3	1	4	096	131.56
866S-523C	6X1/2	1-1/8	1	4	096	189.20
866S-524C	6X3/4	1-1/8	1	4	096	189.20
866S-525C	6X1	1-1/8	1	4	096	189.20
866S-526C	6X1-1/4	2-1/4	1	4	096	189.20
866S-527C	6X1-1/2	2-1/4	1	4	096	189.20
866S-528C	6X2	2-1/4	1	4	096	189.20
866S-529C	6X2-1/2	3	1	4	096	200.27
866S-530C	6X3	3	1	4	096	212.42
866S-532C	6X4	4	1	4	096	222.21
866S-573C	8X1/2	4	1	0	096	355.34
866S-574C	8X3/4	4	1	0	096	355.34
866S-575C	8X1	4	1	1	096	355.34
866S-576C	8X1-1/4	4	1	0	096	355.34
866S-577C	8X1-1/2	4	1	0	096	355.34
866S-578C	8 X 2	4	1	1	096	355.34
866S-579C	8X2-1/2	4	1	0	096	390.80
866S-580C	8X3	4	1	0	096	410.37
866S-582C	8X4	4	1	1	096	434.99
866S-585C	8X6	6	1	1	096	482.70
866S-624C	10X4	4	1	1	096	574.40
866S-626C	10X6	6	1	1	096	660.59
866S-664C	12X4	4	1	1	096	719.96
866S-666C	12X6	6	1	1	096	835.18

¹Outlet-sized with Bushing

CPVC Gray Clamp-On Saddle x SR Thread Single Outlet with Viton® O-ring Seal & Zinc-Plated Hardware

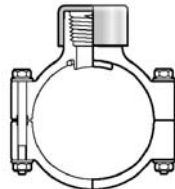

2"-4" 235, 6" 200, 8"-12" 150 psi @ 73°F (23°C)

867V-247CSR	2X1/2	3/4	1	10	096	54.48
867V-248CSR	2X3/4	7/8	1	10	096	54.48
867V-249CSR	2X1	1-1/8	1	10	096	54.48
867V-250CSR	2X1-1/4	1-1/2	1	10	096	54.48
867V-251CSR	2X1-1/2	1-1/2	1	10	096	54.48
867V-291CSR	2-1/2X1-1/2	1-3/4	1	10	096	76.03

Part Number	Size	Hole Saw Dia	Std Pk	Mstr Ctn	Disc Code	Price Each
-------------	------	--------------	--------	----------	-----------	------------

CPVC Gray Clamp-On Saddle x SR Thread Single Outlet (continued) with Viton® O-ring Seal & Zinc-Plated Hardware

867V-333CSR	3X1/2	7/8	1	10	096	76.03
867V-334CSR	3X3/4	7/8	1	10	096	76.03
867V-335CSR	3X1	1-1/8	1	10	096	76.03
867V-336CSR	3X1-1/4	2-1/4	1	10	096	76.03
867V-337CSR	3X1-1/2	2-1/4	1	10	096	76.03
867V-338CSR	3X2	2-1/4	1	10	096	76.03
867V-415CSR	4X1/2	1-1/8	1	10	096	94.81
867V-416CSR	4X3/4	1-1/8	1	10	096	94.81
867V-417CSR	4X1	1-1/8	1	8	096	94.81
867V-418CSR	4X1-1/4	1-3/4	1	8	096	94.81
867V-419CSR	4X1-1/2	1-3/4	1	8	096	94.81
867V-420CSR	4X2	2-1/4	1	8	096	94.81
867V-421CSR	4X2-1/2	3	1	4	096	102.27
867V-422CSR	4X3	3	1	4	096	112.58
867V-523CSR	6X1/2	1-1/8	1	4	096	158.41
867V-524CSR	6X3/4	1-1/8	1	4	096	158.41
867V-525CSR	6X1	1-1/8	1	4	096	158.41
867V-526CSR	6X1-1/4	2-1/4	1	4	096	158.41
867V-527CSR	6X1-1/2	2-1/4	1	4	096	158.41
867V-528CSR	6X2	2-1/4	1	4	096	158.41
867V-529CSR	6X2-1/2	3	1	4	096	169.63
867V-530CSR	6X3	3	1	4	096	175.74
867V-532CSR	6X4	4	1	4	096	188.24
867V-573CSR	8X1/2	4	1	0	096	315.79
867V-574CSR	8X3/4	4	1	0	096	315.79
867V-575CSR	8X1	4	1	0	096	315.79
867V-576CSR	8X1-1/4	4	1	0	096	315.79
867V-577CSR	8X1-1/2	4	1	0	096	315.79
867V-578CSR	8X2	4	1	0	096	315.79
867V-579CSR	8X2-1/2	4	1	0	096	347.34
867V-580CSR	8X3	4	1	0	096	364.74
867V-582CSR	8X4	4	1	1	096	388.07
867V-585CSR	8X6	6	1	0	096	400.14
867V-624CSR	10X4	4	1	1	096	461.70
867V-626CSR	10X6	6	1	1	096	530.93
867V-664CSR	12X4	4	1	1	096	577.57
867V-666CSR	12X6	6	1	1	096	671.43

¹Outlet-sized with Bushing

CPVC Gray Clamp-On Saddle x SR Thread Single Outlet with Viton® O-ring Seal & SS Hardware

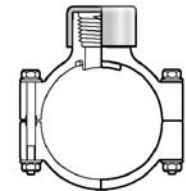

2"-4" 235, 6" 200, 8"-12" 150 psi @ 73°F (23°C)

867SV-245CSR	2X1/4	1-1/8	1	10	096	94.76
867SV-247CSR	2X1/2	3/4	1	10	096	90.42
867SV-248CSR	2X3/4	7/8	1	10	096	90.42
867SV-249CSR	2X1	1-1/8	1	10	096	90.42

PVC/CPVC Clamp-On & Hot-Tap Saddles



Part Number	Size	Hole Saw Dia	Std Pk	Mstr Ctn	Disc Code	Price Each
-------------	------	--------------	--------	----------	-----------	------------

CPVC Gray Clamp-On Saddle x SR Thread Single Outlet (continued) with Viton® O-ring Seal & SS Hardware

867SV-250CSR	2X1-1/4	1-1/2	1	10	096	90.42
867SV-251CSR	2X1-1/2	1-1/2	1	10	096	90.42
867SV-291CSR	2-1/2X1-1/2	1-3/4	1	10	096	121.47
867SV-331CSR	3X1/4	1-1/8	1	10	096	128.41
867SV-333CSR	3X1/2	7/8	1	10	096	121.47
867SV-334CSR	3X3/4	7/8	1	10	096	121.47
867SV-335CSR	3X1	1-1/8	1	10	096	121.47
867SV-336CSR	3X1-1/4	2-1/4	1	10	096	121.47
867SV-337CSR	3X1-1/2	2-1/4	1	10	096	121.47
867SV-338CSR	3X2	2-1/4	1	10	096	121.47
867SV-413CSR	4X1/4	1-1/8	1	8	096	166.97
867SV-415CSR	4X1/2	1-1/8	1	10	096	153.47
867SV-416CSR	4X3/4	1-1/8	1	10	096	153.47
867SV-417CSR	4X1	1-1/8	1	8	096	153.47
867SV-418CSR	4X1-1/4	1-3/4	1	8	096	153.47
867SV-419CSR	4X1-1/2	1-3/4	1	8	096	153.47
867SV-420CSR	4X2	2-1/4	1	8	096	153.47
867SV-421CSR	4X2-1/2	3	1	4	096	159.67
867SV-422CSR	4X3	3	1	4	096	168.32
867SV-521CSR	6X1/4	1-1/8	1	4	096	265.66
867SV-523CSR	6X1/2	1-1/8	1	4	096	255.78
867SV-524CSR	6X3/4	1-1/8	1	4	096	255.78
867SV-525CSR	6X1	1-1/8	1	4	096	255.78
867SV-526CSR	6X1-1/4	2-1/4	1	4	096	255.78
867SV-527CSR	6X1-1/2	2-1/4	1	4	096	255.78
867SV-528CSR	6X2	2-1/4	1	4	096	255.78
867SV-529CSR	6X2-1/2	3	1	4	096	267.97
867SV-530CSR	6X3	3	1	4	096	278.77
867SV-532CSR	6X4	4	1	4	096	298.41
867SV-571CSR	8X1/4	4	1	0	096	451.96
867SV-573CSR	8X1/2	4	1	0	096	440.63
867SV-574CSR	8X3/4	4	1	0	096	440.63
867SV-575CSR	8X1	4	1	0	096	440.63
867SV-576CSR	8X1-1/4	4	1	0	096	440.63
867SV-577CSR	8X1-1/2	4	1	0	096	440.63
867SV-578CSR	8X2	4	1	0	096	440.63
867SV-579CSR	8X2-1/2	4	1	0	096	484.73
867SV-580CSR	8X3	4	1	0	096	508.99
867SV-582CSR	8X4	4	1	1	096	539.59
867SV-585CSR	8X6	6	1	0	096	568.04
867SV-624CSR	10X4	4	1	1	096	642.12
867SV-626CSR	10X6	6	1	1	096	738.43
867SV-664CSR	12X4	4	1	1	096	804.86
867SV-666CSR	12X6	6	1	1	096	933.64

¹Outlet-sized with Bushing

Part Number	Size	Hole Saw Dia	Std PK	Mstr Ctn	Disc Code	Price Each
-------------	------	--------------	--------	----------	-----------	------------

CPVC Gray Clamp-On Saddle x SR Thread Single Outlet with EPDM O-ring Seal & Zinc-Plated Hardware

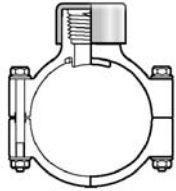

2"-4" 235, 6" 200, 8"-12" 150 psi @ 73°F (23°C)

867-247CSR	2X1/2	3/4	1	10	096	47.30
867-248CSR	2X3/4	7/8	1	10	096	47.30
867-249CSR	2X1	1-1/8	1	10	096	47.30
867-250CSR	2X1-1/4	1-1/2	1	10	096	47.30
867-251CSR	2X1-1/2	1-1/2	1	10	096	47.30
867-291CSR	2-1/2X1-1/2	1-3/4	1	10	096	64.64
867-333CSR	3X1/2	7/8	1	10	096	64.64
867-334CSR	3X3/4	7/8	1	10	096	64.64
867-335CSR	3X1	1-1/8	1	10	096	64.64
867-336CSR	3X1-1/4	2-1/4	1	10	096	64.64
867-337CSR	3X1-1/2	2-1/4	1	10	096	64.64
867-338CSR	3X2	2-1/4	1	10	096	64.64
867-415CSR	4X1/2	1-1/8	1	10	096	81.41
867-416CSR	4X3/4	1-1/8	1	10	096	81.41
867-417CSR	4X1	1-1/8	1	8	096	81.41
867-418CSR	4X1-1/4	1-3/4	1	8	096	81.41
867-419CSR	4X1-1/2	1-3/4	1	8	096	81.41
867-420CSR	4X2	2-1/4	1	8	096	81.41
867-421CSR	4X2-1/2	3	1	4	096	90.34
867-422CSR	4X3	3	1	4	096	97.51
867-523CSR	6X1/2	1-1/8	1	4	096	135.67
867-524CSR	6X3/4	1-1/8	1	4	096	135.67
867-525CSR	6X1	1-1/8	1	4	096	135.67
867-526CSR	6X1-1/4	2-1/4	1	4	096	135.67
867-527CSR	6X1-1/2	2-1/4	1	4	096	135.67
867-528CSR	6X2	2-1/4	1	4	096	135.67
867-529CSR	6X2-1/2	3	1	4	096	143.56
867-530CSR	6X3	3	1	4	096	151.80
867-532CSR	6X4	4	1	4	096	165.08
867-573CSR	8X1/2	4	1	0	096	286.69
867-574CSR	8X3/4	4	1	0	096	286.69
867-575CSR	8X1	4	1	0	096	286.69
867-576CSR	8X1-1/4	4	1	0	096	286.69
867-577CSR	8X1-1/2	4	1	0	096	286.69
867-578CSR	8X2	4	1	0	096	286.69
867-579CSR	8X2-1/2	4	1	0	096	315.36
867-580CSR	8X3	4	1	0	096	334.27
867-582CSR	8X4	4	1	1	096	354.41
867-585CSR	8X6	6	1	0	096	368.49
867-624CSR	10X4	4	1	1	096	421.78
867-626CSR	10X6	6	1	1	096	485.01
867-664CSR	12X4	4	1	1	096	528.69
867-666CSR	12X6	6	1	1	096	613.24

¹Outlet-sized with Bushing



PVC/CPVC Clamp-On & Hot-Tap Saddles

Part Number	Size	Hole Saw Dia	Std PK	Mstr Ctn	Disc Code	Price Each
-------------	------	--------------	--------	----------	-----------	------------

CPVC Gray Clamp-On Saddle x SR Thread Single Outlet with EPDM O-ring Seal & SS Hardware

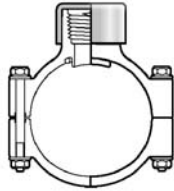

2"-4" 235, 6" 200, 8"-12" 150 psi @ 73°F (23°C)

867S-245CSR	2X1/4	1-1/8	1	10	096	83.41
867S-247CSR	2X1/2	3/4	1	10	096	81.22
867S-248CSR	2X3/4	7/8	1	10	096	81.22
867S-249CSR	2X1	1-1/8	1	10	096	81.22
867S-250CSR	2X1-1/4	1-1/2	1	10	096	81.22
867S-251CSR	2X1-1/2	1-1/2	1	10	096	81.22
867S-291CSR	2-1/2X1-1/2	1-3/4	1	10	096	108.71
867S-331CSR	3X1/4	1-1/8	1	10	096	112.16
867S-333CSR	3X1/2	7/8	1	10	096	108.71
867S-334CSR	3X3/4	7/8	1	10	096	108.71
867S-335CSR	3X1	1-1/8	1	10	096	108.71
867S-336CSR	3X1-1/4	2-1/4	1	10	096	108.71
867S-337CSR	3X1-1/2	2-1/4	1	10	096	108.71
867S-338CSR	3X2	2-1/4	1	10	096	108.71
867S-413CSR	4X1/4	1-1/8	1	8	096	140.99
867S-415CSR	4X1/2	1-1/8	1	10	096	136.82
867S-416CSR	4X3/4	1-1/8	1	10	096	136.82
867S-417CSR	4X1	1-1/8	1	8	096	136.82
867S-418CSR	4X1-1/4	1-3/4	1	8	096	136.82
867S-419CSR	4X1-1/2	1-3/4	1	8	096	136.82
867S-420CSR	4X2	2-1/4	1	8	096	136.82
867S-421CSR	4X2-1/2	3	1	4	096	145.08
867S-422CSR	4X3	3	4	0	096	151.89
867S-521CSR	6X1/4	1-1/8	1	8	096	236.53
867S-523CSR	6X1/2	1-1/8	1	4	096	228.03
867S-524CSR	6X3/4	1-1/8	1	4	096	228.03
867S-525CSR	6X1	1-1/8	1	4	096	228.03
867S-526CSR	6X1-1/4	2-1/4	1	4	096	228.03
867S-527CSR	6X1-1/2	2-1/4	1	4	096	228.03
867S-528CSR	6X2	2-1/4	1	4	096	228.03
867S-529CSR	6X2-1/2	3	1	4	096	237.14
867S-530CSR	6X3	3	1	4	096	245.10
867S-532CSR	6X4	4	1	4	096	255.90
867S-571CSR	8X1/4	4	1	0	096	420.02
867S-573CSR	8X1/2	4	1	0	096	405.10
867S-574CSR	8X3/4	4	1	0	096	405.10
867S-575CSR	8X1	4	1	0	096	405.10
867S-576CSR	8X1-1/4	4	1	0	096	405.10
867S-577CSR	8X1-1/2	4	1	0	096	405.10
867S-578CSR	8X2	4	1	0	096	405.10
867S-579CSR	8X2-1/2	4	1	0	096	445.60
867S-580CSR	8X3	4	1	0	096	467.84
867S-582CSR	8X4	4	1	1	096	495.91
867S-585CSR	8X6	6	1	0	096	520.19
867S-624CSR	10X4	4	1	1	096	590.13
867S-626CSR	10X6	6	0	0	096	678.66

Part Number	Size	Hole Saw Dia	Std PK	Mstr Ctn	Disc Code	Price Each
-------------	------	--------------	--------	----------	-----------	------------

CPVC Gray Clamp-On Saddle x SR Thread Single Outlet (continued) with EPDM O-ring Seal & SS Hardware

867S-664CSR	12X4	4	1	1	096	739.73
867S-666CSR	12X6	6	1	1	096	858.12

¹Outlet-sized with Bushing

CPVC Gray Clamp-On Saddle x Soc Double Outlet with Viton® O-ring Seal & Zinc-Plated Hardware

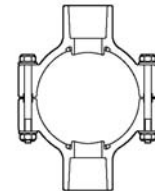

2"-4" 235, 6" 200, 8"-12" 150 psi @ 73°F (23°C)

868V-247C	2X1/2	3/4	1	10	096	64.73
868V-248C	2X3/4	7/8	1	10	096	64.73
868V-249C	2X1	1-1/8	1	10	096	64.73
868V-250C	2X1-1/4	1-1/2	1	10	096	64.73
868V-251C	2X1-1/2	1-1/2	1	10	096	64.73
868V-291C	2-1/2X1-1/2	1-3/4	1	10	096	79.16
868V-333C	3X1/2	7/8	1	10	096	79.16
868V-334C	3X3/4	7/8	1	10	096	79.16
868V-335C	3X1	1-1/8	1	10	096	79.16
868V-336C	3X1-1/4	2-1/4	1	10	096	79.16
868V-337C	3X1-1/2	2-1/4	1	10	096	79.16
868V-338C	3X2	2-1/4	1	10	096	79.16
868V-415C	4X1/2	1-1/8	1	10	096	106.58
868V-416C	4X3/4	1-1/8	1	10	096	106.58
868V-417C	4X1	1-1/8	1	8	096	106.58
868V-418C	4X1-1/4	1-3/4	1	8	096	106.58
868V-419C	4X1-1/2	1-3/4	1	8	096	106.58
868V-420C	4X2	2-1/4	1	8	096	106.58
868V-421C	4X2-1/2	3	1	4	096	111.36
868V-422C	4X3	3	4	0	096	121.53
868V-523C	6X1/2	1-1/8	1	4	096	172.43
868V-524C	6X3/4	1-1/8	1	4	096	172.43
868V-525C	6X1	1-1/8	1	4	096	172.43
868V-526C	6X1-1/4	2-1/4	1	4	096	172.43
868V-527C	6X1-1/2	2-1/4	1	4	096	172.43
868V-528C	6X2	2-1/4	1	4	096	172.43
868V-529C	6X2-1/2	3	1	4	096	199.71
868V-530C	6X3	3	1	4	096	210.57
868V-532C	6X4	4	1	4	096	219.68
868V-573C	8X1/2	4	1	0	096	333.84
868V-574C	8X3/4	4	1	0	096	333.84
868V-575C	8X1	4	1	1	096	333.84
868V-576C	8X1-1/4	4	1	0	096	333.84
868V-577C	8X1-1/2	4	1	0	096	333.84
868V-578C	8X2	4	1	0	096	333.84
868V-579C	8X2-1/2	4	1	0	096	367.20
868V-580C	8X3	4	1	0	096	385.53
868V-582C	8X4	4	1	1	096	408.63
868V-585C	8X6	6	1	1	096	453.62

PVC/CPVC Clamp-On & Hot-Tap Saddles



Part Number	Size	Hole Saw Dia	Std Pk	Mstr Ctn	Disc Code	Price Each
-------------	------	--------------	--------	----------	-----------	------------

CPVC Gray Clamp-On Saddle x Soc Double Outlet (continued)

with Viton® O-ring Seal & Zinc-Plated Hardware

868V-624C	10X4	4	1	1	096	539.74
868V-626C	10X6	6	1	1	096	620.90
868V-664C	12X4	4	1	0	096	676.63
868V-666C	12X6	6	1	1	096	784.78

¹Outlet-sized with Bushing

CPVC Gray Clamp-On Saddle x Soc Double Outlet with Viton® O-ring Seal & SS Hardware

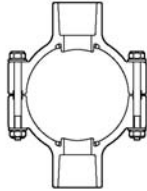

2"-4" 235, 6" 200, 8"-12" 150 psi @ 73°F (23°C)

868SV-247C	2X1/2	3/4	1	10	096	98.78
868SV-248C	2X3/4	7/8	1	10	096	98.78
868SV-249C	2X1	1-1/8	1	10	096	98.78
868SV-250C	2X1-1/4	1-1/2	1	10	096	98.78
868SV-251C	2X1-1/2	1-1/2	1	10	096	98.78
868SV-291C	2-1/2X1-1/2	1-3/4	1	10	096	131.42
868SV-333C	3X1/2	7/8	1	10	096	131.42
868SV-334C	3X3/4	7/8	1	10	096	131.42
868SV-335C	3X1	1-1/8	1	10	096	131.42
868SV-336C	3X1-1/4	2-1/4	1	10	096	131.42
868SV-337C	3X1-1/2	2-1/4	1	10	096	131.42
868SV-338C	3X2	2-1/4	1	10	096	131.42
868SV-415C	4X1/2	1-1/8	1	10	096	167.01
868SV-416C	4X3/4	1-1/8	1	10	096	167.01
868SV-417C	4X1	1-1/8	1	8	096	167.01
868SV-418C	4X1-1/4	1-3/4	1	8	096	167.01
868SV-419C	4X1-1/2	1-3/4	1	8	096	167.01
868SV-420C	4X2	2-1/4	1	8	096	167.01
868SV-421C	4X2-1/2	3	1	4	096	173.77
868SV-422C	4X3	3	4	0	096	185.11
868SV-523C	6X1/2	1-1/8	1	4	096	277.80
868SV-524C	6X3/4	1-1/8	1	4	096	277.80
868SV-525C	6X1	1-1/8	1	4	096	277.80
868SV-526C	6X1-1/4	2-1/4	1	4	096	277.80
868SV-527C	6X1-1/2	2-1/4	1	4	096	277.80
868SV-528C	6X2	2-1/4	1	4	096	277.80
868SV-529C	6X2-1/2	3	1	4	096	286.34
868SV-530C	6X3	3	1	4	096	299.57
868SV-532C	6X4	4	1	4	096	306.68
868SV-573C	8X1/2	4	1	0	096	468.91
868SV-574C	8X3/4	4	1	0	096	468.91
868SV-575C	8X1	4	1	1	096	468.91
868SV-576C	8X1-1/4	4	1	0	096	468.91
868SV-577C	8X1-1/2	4	1	0	096	468.91
868SV-578C	8X2	4	1	0	096	468.91
868SV-579C	8X2-1/2	4	1	0	096	515.63
868SV-580C	8X3	4	1	0	096	541.54

Part Number	Size	Hole Saw Dia	Std Pk	Mstr Ctn	Disc Code	Price Each
-------------	------	--------------	--------	----------	-----------	------------

CPVC Gray Clamp-On Saddle x Soc Double Outlet (continued)

with Viton® O-ring Seal & SS Hardware

868SV-582C	8X4	4	1	1	096	573.98
868SV-585C	8X6	6	1	1	096	637.21
868SV-624C	10X4	4	1	1	096	758.29
868SV-626C	10X6	6	1	1	096	872.13
868SV-664C	12X4	4	1	1	096	950.40
868SV-666C	12X6	6	1	1	096	1102.58

¹Outlet-sized with Bushing

CPVC Gray Clamp-On Saddle x Soc Double Outlet with EPDM O-ring Seal & Zinc-Plated Hardware

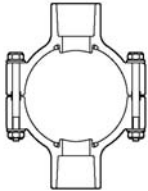

2"-4" 235, 6" 200, 8"-12" 150 psi @ 73°F (23°C)

868-247C	2X1/2	3/4	1	10	096	54.30
868-248C	2X3/4	7/8	1	10	096	54.30
868-249C	2X1	1-1/8	1	10	096	54.30
868-250C	2X1-1/4	1-1/2	1	10	096	54.30
868-251C	2X1-1/2	1-1/2	1	10	096	54.30
868-291C	2-1/2X1-1/2	1-3/4	1	10	096	74.56
868-333C	3X1/2	7/8	1	10	096	74.56
868-334C	3X3/4	7/8	1	10	096	74.56
868-335C	3X1	1-1/8	1	10	096	74.56
868-336C	3X1-1/4	2-1/4	1	10	096	74.56
868-337C	3X1-1/2	2-1/4	1	10	096	74.56
868-338C	3X2	2-1/4	1	10	096	74.56
868-415C	4X1/2	1-1/8	1	10	096	93.58
868-416C	4X3/4	1-1/8	1	10	096	93.58
868-417C	4X1	1-1/8	1	8	096	93.58
868-418C	4X1-1/4	1-3/4	1	8	096	93.58
868-419C	4X1-1/2	1-3/4	1	8	096	93.58
868-420C	4X2	2-1/4	1	8	096	93.58
868-421C	4X2-1/2	3	1	4	096	98.53
868-422C	4X3	3	1	4	096	107.10
868-523C	6X1/2	1-1/8	1	4	096	156.22
868-524C	6X3/4	1-1/8	1	4	096	156.22
868-525C	6X1	1-1/8	1	4	096	156.22
868-526C	6X1-1/4	2-1/4	1	4	096	156.22
868-527C	6X1-1/2	2-1/4	1	4	096	156.22
868-528C	6X2	2-1/4	1	4	096	156.22
868-529C	6X2-1/2	3	1	4	096	166.08
868-530C	6X3	3	1	4	096	175.57
868-532C	6X4	4	1	4	096	181.23
868-573C	8X1/2	4	1	0	096	313.04
868-574C	8X3/4	4	1	0	096	313.04
868-575C	8X1	4	1	1	096	313.04
868-576C	8X1-1/4	4	1	0	096	313.04
868-577C	8X1-1/2	4	1	0	096	313.04
868-578C	8X2	4	1	0	096	313.04



PVC/CPVC Clamp-On & Hot-Tap Saddles

Part Number	Size	Hole Saw Dia	Std Pk	Mstr Ctn	Disc Code	Price Each
-------------	------	--------------	--------	----------	-----------	------------

CPVC Gray Clamp-On Saddle x Soc Double Outlet (continued) with EPDM O-ring Seal & Zinc-Plated Hardware

868-579C	8X2-1/2	4	1	0	096	344.30
868-580C	8X3	4	1	0	096	361.56
868-582C	8X4	4	1	1	096	383.22
868-585C	8X6	6	1	1	096	425.38
868-624C	10X4	4	1	1	096	506.24
868-626C	10X6	6	1	1	096	582.12
868-664C	12X4	4	1	1	096	634.47
868-666C	12X6	6	1	1	096	736.11

¹Outlet-sized with Bushing

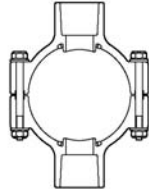

CPVC Gray Clamp-On Saddle x Soc Double Outlet with EPDM O-ring Seal & SS Hardware

2"-4" 235, 6" 200, 8"-12" 150 psi @ 73°F (23°C)

868S-247C	2X1/2	3/4	1	10	096	85.88
868S-248C	2X3/4	7/8	1	10	096	85.88
868S-249C	2X1	1-1/8	1	10	096	85.88
868S-250C	2X1-1/4	1-1/2	1	10	096	85.88
868S-251C	2X1-1/2	1-1/2	1	10	096	85.88
868S-291C	2-1/2X1-1/2	1-3/4	1	10	096	114.22
868S-333C	3X1/2	7/8	1	10	096	114.22
868S-334C	3X3/4	7/8	1	10	096	114.22
868S-335C	3X1	1-1/8	1	10	096	114.22
868S-336C	3X1-1/4	2-1/4	1	10	096	114.22
868S-337C	3X1-1/2	2-1/4	1	10	096	114.22
868S-338C	3X2	2-1/4	1	10	096	114.22
868S-415C	4X1/2	1-1/8	1	10	096	146.37
868S-416C	4X3/4	1-1/8	1	10	096	146.37
868S-417C	4X1	1-1/8	1	8	096	146.37
868S-418C	4X1-1/4	1-3/4	1	8	096	146.37
868S-419C	4X1-1/2	1-3/4	1	8	096	146.37
868S-420C	4X2	2-1/4	1	8	096	146.37
868S-421C	4X2-1/2	3	1	4	096	153.19
868S-422C	4X3	3	4	0	096	160.20
868S-523C	6X1/2	1-1/8	1	4	096	244.44
868S-524C	6X3/4	1-1/8	1	4	096	244.44
868S-525C	6X1	1-1/8	1	4	096	244.44
868S-526C	6X1-1/4	2-1/4	1	4	096	244.44
868S-527C	6X1-1/2	2-1/4	1	4	096	244.44
868S-528C	6X2	2-1/4	1	4	096	244.44
868S-529C	6X2-1/2	3	1	4	096	256.56
868S-530C	6X3	3	1	4	096	262.76
868S-532C	6X4	4	1	4	096	272.33
868S-573C	8X1/2	4	1	0	096	426.11
868S-574C	8X3/4	4	1	0	096	426.11
868S-575C	8X1	4	1	1	096	426.11
868S-576C	8X1-1/4	4	1	0	096	426.11

Part Number	Size	Hole Saw Dia	Std Pk	Mstr Ctn	Disc Code	Price Each
-------------	------	--------------	--------	----------	-----------	------------

CPVC Gray Clamp-On Saddle x Soc Double Outlet (continued) with EPDM O-ring Seal & SS Hardware

868S-577C	8X1-1/2	4	1	0	096	426.11
868S-578C	8X2	4	1	0	096	426.11
868S-579C	8X2-1/2	4	1	0	096	468.70
868S-580C	8X3	4	1	0	096	492.16
868S-582C	8X4	4	1	1	096	521.69
868S-585C	8X6	6	1	1	096	579.18
868S-624C	10X4	4	1	1	096	689.19
868S-626C	10X6	6	1	1	096	792.58
868S-664C	12X4	4	1	1	096	863.91
868S-666C	12X6	6	1	1	096	1002.09

¹Outlet-sized with Bushing

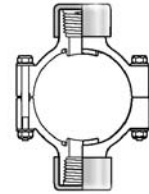

CPVC Gray Clamp-On Saddle x SR Thread Double Outlet with Viton® O-ring Seal & Zinc-Plated Hardware

2"-4" 235, 6" 200, 8"-12" 150 psi @ 73°F (23°C)

869V-247CSR	2X1/2	3/4	1	10	096	72.42
869V-248CSR	2X3/4	7/8	1	10	096	72.42
869V-249CSR	2X1	1-1/8	1	10	096	72.42
869V-250CSR	2X1-1/4	1-1/2	1	10	096	72.42
869V-251CSR	2X1-1/2	1-1/2	1	10	096	72.42
869V-291CSR	2-1/2X1-1/2	1-3/4	1	10	096	99.30
869V-333CSR	3X1/2	7/8	1	10	096	99.30
869V-334CSR	3X3/4	7/8	1	10	096	99.30
869V-335CSR	3X1	1-1/8	1	10	096	99.30
869V-336CSR	3X1-1/4	2-1/4	1	10	096	99.30
869V-337CSR	3X1-1/2	2-1/4	1	10	096	99.30
869V-338CSR	3X2	2-1/4	1	10	096	99.30
869V-415CSR	4X1/2	4-1/2	1	10	096	121.52
869V-416CSR	4X3/4	1-1/8	1	10	096	121.52
869V-417CSR	4X1	1-1/8	1	8	096	121.52
869V-418CSR	4X1-1/4	1-3/4	1	8	096	121.52
869V-419CSR	4X1-1/2	1-3/4	1	8	096	121.52
869V-420CSR	4X2	2-1/4	1	8	086	121.52
869V-421CSR	4X2-1/2	3	1	4	096	130.52
869V-422CSR	4X3	3	4	0	096	137.46
869V-523CSR	6X1/2	1-1/8	1	4	096	201.51
869V-524CSR	6X3/4	1-1/8	1	4	096	201.51
869V-525CSR	6X1	1-1/8	1	4	096	201.51
869V-526CSR	6X1-1/4	2-1/4	1	4	096	201.51
869V-527CSR	6X1-1/2	2-1/4	1	4	096	201.51
869V-528CSR	6X2	2-1/4	1	4	096	201.51
869V-529CSR	6X2-1/2	3	1	4	096	211.64
869V-530CSR	6X3	3	1	4	096	220.38
869V-532CSR	6X4	4	1	4	096	233.44
869V-573CSR	8X1/2	4	1	0	096	371.10
869V-574CSR	8X3/4	4	1	0	096	371.10

PVC/CPVC Clamp-On & Hot-Tap Saddles



Part Number	Size	Hole Saw Dia	Std Pk	Mstr Ctn	Disc Code	Price Each
-------------	------	--------------	--------	----------	-----------	------------

CPVC Gray Clamp-On Saddle x SR Thread Double Outlet (continued)
with Viton® O-ring Seal & Zinc-Plated Hardware

869V-575CSR	8X1	4	1	0	096	371.10
869V-576CSR	8X1-1/4	4	1	0	096	371.10
869V-577CSR	8X1-1/2	4	1	0	096	371.10
869V-578CSR	8X2	4	1	0	096	371.10
869V-579CSR	8X2-1/2	4	1	0	096	408.20
869V-580CSR	8X3	4	1	0	096	428.57
869V-582CSR	8X4	4	1	1	096	454.27
869V-585CSR	8X6	6	1	0	096	502.48
869V-624CSR	10X4	4	1	1	096	540.47
869V-626CSR	10X6	6	1	1	096	621.62
869V-664CSR	12X4	4	1	1	096	677.63
869V-666CSR	12X6	6	1	1	096	785.93

¹Outlet-sized with Bushing

CPVC Gray Clamp-On Saddle x SR Thread Double Outlet
with Viton® O-ring Seal & SS Hardware

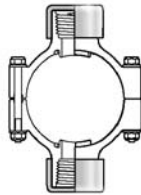

2"-4" 235, 6" 200, 8"-12" 150 psi @ 73°F (23°C)

869SV-247CSR	2X1/2	3/4	1	10	096	106.58
869SV-248CSR	2X3/4	7/8	1	10	096	106.58
869SV-249CSR	2X1	1-1/8	1	10	096	106.58
869SV-250CSR	2X1-1/4	1-1/2	1	10	096	106.58
869SV-251CSR	2X1-1/2	1-1/2	1	10	096	106.58
869SV-291CSR	2-1/2X1-1/2	1-1/2	1	10	096	135.07
869SV-333CSR	3X1/2	7/8	1	10	096	135.07
869SV-334CSR	3X3/4	7/8	1	10	096	135.07
869SV-335CSR	3X1	1-1/8	1	10	096	135.07
869SV-336CSR	3X1-1/4	2-1/4	1	10	096	135.07
869SV-337CSR	3X1-1/2	2-1/4	1	10	096	135.07
869SV-338CSR	3X2	2-1/4	1	10	096	135.07
869SV-415CSR	4X1/2	1-1/8	1	10	096	177.37
869SV-416CSR	4X3/4	1-1/8	1	10	096	177.37
869SV-417CSR	4X1	1-1/8	1	8	096	177.37
869SV-418CSR	4X1-1/4	1-3/4	1	8	096	177.37
869SV-419CSR	4X1-1/2	1-3/4	1	8	096	177.37
869SV-420CSR	4X2	2-1/4	1	8	096	177.37
869SV-421CSR	4X2-1/2	3	1	4	096	186.21
869SV-422CSR	4X3	3	4	0	096	199.49
869SV-523CSR	6X1/2	1-1/8	1	4	096	316.92
869SV-524CSR	6X3/4	1-1/8	1	4	096	316.92
869SV-525CSR	6X1	1-1/8	1	4	096	316.92
869SV-526CSR	6X1-1/4	2-1/4	1	4	096	316.92
869SV-527CSR	6X1-1/2	2-1/4	1	4	096	316.92
869SV-528CSR	6X2	2-1/4	1	4	096	316.92
869SV-529CSR	6X2-1/2	3	1	4	096	329.10
869SV-530CSR	6X3	3	1	4	096	339.54
869SV-532CSR	6X4	4	1	4	096	347.32

Part Number	Size	Hole Saw Dia	Std Pk	Mstr Ctn	Disc Code	Price Each
-------------	------	--------------	--------	----------	-----------	------------

CPVC Gray Clamp-On Saddle x SR Thread Double Outlet (continued)
with Viton® O-ring Seal & SS Hardware

869SV-573CSR	8X1/2	4	1	0	096	519.09
869SV-574CSR	8X3/4	4	1	0	096	519.09
869SV-575CSR	8X1	4	1	0	096	519.09
869SV-576CSR	8X1-1/4	4	1	0	096	519.09
869SV-577CSR	8X1-1/2	4	1	0	096	519.09
869SV-578CSR	8X2	4	1	0	096	519.09
869SV-579CSR	8X2-1/2	4	1	0	096	570.92
869SV-580CSR	8X3	4	1	0	096	508.99
869SV-582CSR	8X4	4	1	1	096	635.48
869SV-585CSR	8X6	6	1	0	096	678.93
869SV-624CSR	10X4	4	1	1	096	756.20
869SV-626CSR	10X6	6	1	1	096	869.68
869SV-664CSR	12X4	4	1	1	096	947.93
869SV-666CSR	12X6	6	1	1	096	1099.70

¹Outlet-sized with Bushing

CPVC Gray Clamp-On Saddle x SR Thread Double Outlet
with EPDM O-ring Seal & Zinc-Plated Hardware

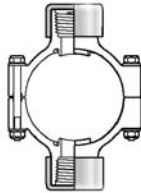

2"-4" 235, 6" 200, 8"-12" 150 psi @ 73°F (23°C)

869-247CSR	2X1/2	3/4	1	10	096	62.92
869-248CSR	2X3/4	7/8	1	10	096	62.92
869-249CSR	2X1	1-1/8	1	10	096	62.92
869-250CSR	2X1-1/4	1-1/2	1	10	096	62.92
869-251CSR	2X1-1/2	1-1/2	1	10	096	62.92
869-291CSR	2-1/2X1-1/2	1-3/4	1	10	096	84.97
869-333CSR	3X1/2	7/8	1	10	096	84.97
869-334CSR	3X3/4	7/8	1	10	096	84.97
869-335CSR	3X1	1-1/8	1	10	096	84.97
869-336CSR	3X1-1/4	1-1/8	1	10	096	84.97
869-337CSR	3X1-1/2	2-1/4	1	10	096	84.97
869-338CSR	3X2	2-1/4	1	10	096	84.97
869-415CSR	4X1/2	1-1/8	1	10	096	105.48
869-416CSR	4X3/4	1-1/8	1	10	096	105.48
869-417CSR	4X1	1-1/8	1	8	096	105.48
869-418CSR	4X1-1/4	1-3/4	1	8	096	105.48
869-419CSR	4X1-1/2	1-3/4	1	8	096	105.48
869-420CSR	4X2	2-1/4	1	8	096	105.48
869-421CSR	4X2-1/2	3	1	4	096	116.64
869-422CSR	4X3	3	1	4	096	126.23
869-523CSR	6X1/2	1-1/8	1	4	096	172.29
869-524CSR	6X3/4	1-1/8	1	4	096	172.29
869-525CSR	6X1	1-1/8	1	4	096	172.29
869-526CSR	6X1-1/4	2-1/4	1	4	096	172.29
869-527CSR	6X1-1/2	2-1/4	1	4	096	172.29
869-528CSR	6X2	2-1/4	1	4	096	172.29
869-529CSR	6X2-1/2	3	1	4	096	184.42



PVC/CPVC Clamp-On & Hot-Tap Saddles

Part Number	Size	Hole Saw Dia	Std Pk	Mstr Ctn	Disc Code	Price Each
-------------	------	--------------	--------	----------	-----------	------------

CPVC Gray Clamp-On Saddle x SR Thread Double Outlet (continued)
with EPDM O-ring Seal & Zinc-Plated Hardware

869-530CSR	6X3	3	1	4	096	199.52
869-532CSR	6X4	4	1	4	096	211.59
869-573CSR	8X1/2	4	1	0	096	333.56
869-574CSR	8X3/4	4	1	0	096	333.56
869-575CSR	8X1	4	1	0	096	333.56
869-576CSR	8X1-1/4	4	1	0	096	333.56
869-577CSR	8X1-1/2	4	1	0	096	333.56
869-578CSR	8X2	4	1	0	096	333.56
869-579CSR	8X2-1/2	4	1	0	096	366.98
869-580CSR	8X3	4	1	0	096	385.40
869-582CSR	8X4	4	1	1	096	408.48
869-585CSR	8X6	6	1	0	096	641.38
869-624CSR	10X4	4	1	1	096	486.02
869-626CSR	10X6	6	1	1	096	559.02
869-664CSR	12X4	4	1	1	096	609.34
869-666CSR	12X6	6	1	1	096	706.81

¹Outlet-sized with Bushing

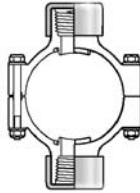

CPVC Gray Clamp-On Saddle x SR Thread Double Outlet
with EPDM O-ring Seal & SS Hardware

2"-4" 235, 6" 200, 8"-12" 150 psi @ 73°F (23°C)

869S-247CSR	2X1/2	3/4	1	10	096	101.13
869S-248CSR	2X3/4	7/8	1	10	096	101.13
869S-249CSR	2X1	1-1/8	1	10	096	101.13
869S-250CSR	2X1-1/4	1-1/2	1	10	096	101.13
869S-251CSR	2X1-1/2	1-1/2	1	10	096	101.13
869S-291CSR	2-1/2X1-1/2	1-3/4	1	10	096	133.38
869S-333CSR	3X1/2	7/8	1	10	096	133.38
869S-334CSR	3X3/4	7/8	1	10	096	133.38
869S-335CSR	3X1	1-1/8	1	10	096	133.38
869S-336CSR	3X1-1/4	2-1/4	1	10	096	133.38
869S-337CSR	3X1-1/2	2-1/4	1	10	096	133.38
869S-338CSR	3X2	2-1/4	1	10	096	133.38
869S-415CSR	4X1/2	1-1/8	1	10	096	167.00
869S-416CSR	4X3/4	1-1/8	1	10	096	167.00
869S-417CSR	4X1	1-1/8	1	8	096	167.00
869S-418CSR	4X1-1/4	1-3/4	1	8	096	167.00
869S-419CSR	4X1-1/2	1-3/4	1	8	096	167.00
869S-420CSR	4X2	2-1/4	1	8	096	167.00
869S-421CSR	4X2-1/2	3	1	4	096	179.40
869S-422CSR	4X3	3	4	0	096	192.30
869S-523CSR	6X1/2	1-1/8	1	4	096	281.27
869S-524CSR	6X3/4	1-1/8	1	4	096	281.27
869S-525CSR	6X1	1-1/8	1	4	096	281.27
869S-526CSR	6X1-1/4	2-1/4	1	4	096	281.27
869S-527CSR	6X1-1/2	2-1/4	1	4	096	281.27

Part Number	Size	Hole Saw Dia	Std Pk	Mstr Ctn	Disc Code	Price Each
-------------	------	--------------	--------	----------	-----------	------------

CPVC Gray Clamp-On Saddle x SR Thread Double Outlet (continued)
with EPDM O-ring Seal & SS Hardware

869S-528CSR	6X2	2-1/4	1	4	096	281.27
869S-529CSR	6X2-1/2	3	1	4	096	287.58
869S-530CSR	6X3	3	1	4	096	300.29
869S-532CSR	6X4	4	1	4	096	308.68
869S-573CSR	8X1/2	4	1	0	096	473.40
869S-574CSR	8X3/4	4	1	0	096	473.40
869S-575CSR	8X1	4	1	0	096	473.40
869S-576CSR	8X1-1/4	4	1	0	096	343.44
869S-577CSR	8X1-1/2	4	1	0	096	473.40
869S-578CSR	8X2	4	1	0	096	473.40
869S-579CSR	8X2-1/2	4	1	0	096	520.69
869S-580CSR	8X3	4	1	0	096	546.68
869S-582CSR	8X4	4	1	1	096	579.52
869S-585CSR	8X6	6	1	0	096	608.58
869S-624CSR	10X4	4	1	1	096	689.63
869S-626CSR	10X6	6	1	1	096	793.01
869S-664CSR	12X4	4	1	1	096	864.48
869S-666CSR	12X6	6	1	1	096	1002.68

¹Outlet-sized with Bushing

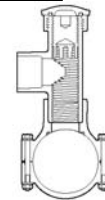

PVC White Hot-Tap Saddle EPDM Saddle x Soc (Spigot) Zinc Plated Bolts

2"-4" 235, 6" 200, 8" 150 psi @ 73°F (23°C)

HT2-248W	2X3/4 (1)	1	5	049	42.97
HT2-251W	2X1-1/2 (2)	1	5	049	88.77
HT2-288W	2-1/2X3/4 (1)	1	5	049	45.92
HT2-291W	2-1/2x1-1/2 (2)	1	5	049	91.73
HT2-334W	3X3/4 (1)	1	5	049	52.59
HT2-337W	3X1-1/2 (2)	1	5	049	101.11
HT2-416W	4X3/4 (1)	1	0	049	60.74
HT2-419W	4X1-1/2 (2)	1	0	049	106.91
HT2-524W	6X3/4 (1)	1	0	049	68.27
HT2-527W	6X1-1/2 (2)	1	0	049	113.82
HT2-574W	8X3/4 (1)	1	0	049	75.56
HT2-577W	8X1-1/2 (2)	1	0	049	121.36

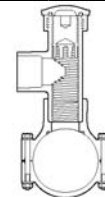

PVC White Hot-Tap Saddles EPDM Saddle x Soc (Spigot) SS316 Bolts

2"-4" 235, 6" 200, 8" 150 psi @ 73°F (23°C)

HT2S-248W	2X3/4 (1)	1	5	049	66.91
HT2S-251W	2X1-1/2 (2)	1	5	049	138.14
HT2S-288W	2-1/2X3/4 (1)	1	5	049	71.48

PVC/CPVC Clamp-On & Hot-Tap Saddles



Part Number	Size	Std Pk	Mstr Ctn	Disc Code	Price Each
-------------	------	--------	----------	-----------	------------

PVC White Hot-Tap Saddles (continued)

EPDM Saddle x Soc (Spigot) SS316 Bolts

HT2S-291W	2-1/2X1-1/2 (2)	1	5	049	142.71
HT2S-334W	3X3/4 (1)	1	5	049	81.86
HT2S-337W	3X1-1/2 (2)	1	5	049	157.41
HT2S-416W	4X3/4 (1)	1	5	049	94.57
HT2S-419W	4X1-1/2 (2)	1	1	049	166.42
HT2S-524W	6X3/4 (1)	1	5	049	106.18
HT2S-527W	6X1-1/2 (2)	1	1	049	177.03
HT2S-574W	8X3/4 (1)	1	0	049	117.03
HT2S-577W	8X1-1/2 (2)	1	0	049	188.14

**PVC Gray Hot-Tap Saddle
EPDM Saddle x Soc (Spigot) Zinc
Plated Bolts**

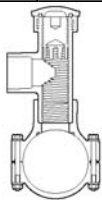

2"-4" 235, 6" 200, 8" 150 psi @ 73°F (23°C)

HT2-248	2X3/4 (1)	1	5	049	42.97
HT2-251	2X1-1/2 (2)	1	5	049	88.77
HT2-288	2-1/2X3/4 (1)	1	5	049	45.92
HT2-291	2-1/2X1-1/2 (2)	1	5	049	91.73
HT2-334	3X3/4 (1)	1	5	049	52.59
HT2-337	3X1-1/2 (2)	1	5	049	101.11
HT2-416	4X3/4 (1)	1	5	049	60.74
HT2-419	4X1-1/2 (2)	1	0	049	106.91
HT2-524	6X3/4 (1)	1	5	049	68.27
HT2-527	6X1-1/2 (2)	1	0	049	113.82
HT2-574	8X3/4 (1)	1	0	049	75.56
HT2-577	8X1-1/2 (2)	1	0	049	121.36

**PVC Gray Hot-Tap Saddle
EPDM Saddle x Soc (Spigot) SS316
Bolts**

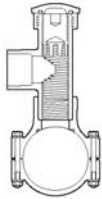

2"-4" 235, 6" 200, 8" 150 psi @ 73°F (23°C)

HT2S-248	2X3/4 (1)	1	5	049	66.91
HT2S-251	2X1-1/2 (2)	1	5	049	138.14
HT2S-288	2-1/2X3/4 (1)	1	5	049	71.48
HT2S-291	2-1/2X1-1/2 (2)	1	5	049	142.71
HT2S-334	3X3/4 (1)	1	5	049	81.86
HT2S-337	3X1-1/2 (2)	1	5	049	157.41
HT2S-416	4X3/4 (1)	1	5	049	94.57
HT2S-419	4X1-1/2 (2)	1	0	049	166.42
HT2S-524	6X3/4 (1)	1	5	049	106.18
HT2S-527	6X1-1/2 (2)	1	0	049	177.03
HT2S-574	8X3/4 (1)	1	0	049	117.03
HT2S-577	8X1-1/2 (2)	1	0	049	188.14

Part Number	Size	Std Pk	Mstr Ctn	Disc Code	Price Each
-------------	------	--------	----------	-----------	------------

**PVC Gray Hot-Tap Saddle
Viton® Saddle x Soc (Spigot) Zinc
Plated Bolts**

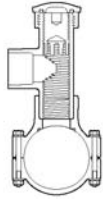

2"-4" 235, 6" 200, 8" 150 psi @ 73°F (23°C)

HT3-248	2X3/4 (1)	1	5	049	46.67
HT3-251	2X1-1/2 (2)	1	5	049	96.30
HT3-288	2-1/2X3/4 (1)	1	5	049	49.88
HT3-291	2-1/2X1-1/2 (2)	1	5	049	99.51
HT3-334	3X3/4 (1)	1	5	049	57.03
HT3-337	3X1-1/2 (2)	1	5	049	109.88
HT3-416	4X3/4 (1)	1	5	049	65.92
HT3-419	4X1-1/2 (2)	1	0	049	65.92
HT3-524	6X3/4 (1)	1	5	049	74.08
HT3-527	6X1-1/2 (2)	1	0	049	123.21
HT3-574	8X3/4 (1)	1	0	049	82.34
HT3-577	8X1-1/2 (2)	1	0	049	145.92

**PVC Gray Hot-Tap Saddle
Viton® Saddle x Soc (Spigot) SS316
Bolts**

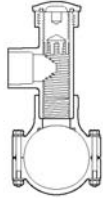

2"-4" 235, 6" 200, 8" 150 psi @ 73°F (23°C)

HT3S-248	2X3/4 (1)	1	5	049	72.59
HT3S-251	2X1-1/2 (2)	1	5	049	149.88
HT3S-288	2-1/2X3/4 (1)	1	5	049	77.78
HT3S-291	2-1/2X1-1/2 (2)	1	5	049	154.93
HT3S-334	3X3/4 (1)	1	5	049	88.77
HT3S-337	3X1-1/2 (2)	1	5	049	170.99
HT3S-416	4X3/4 (1)	1	5	049	102.47
HT3S-419	4X1-1/2 (2)	1	0	049	180.62
HT3S-524	6X3/4 (1)	1	5	049	115.31
HT3S-527	6X1-1/2 (2)	1	0	049	191.86
HT3S-574	8X3/4 (1)	1	0	049	127.53
HT3S-577	8X1-1/2 (2)	1	0	049	203.36

**PVC Gray Hot-Tap Saddle
EPDM with Stainless Steel Cutter &
Bolts**

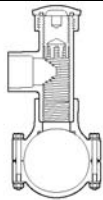

2"-4" 235, 6" 200, 8" 150 psi @ 73°F (23°C)

HTS2S-248	2X3/4 (1)	1	5	049	320.54
HTS2S-251	2X1-1/2 (2)	1	5	049	483.09
HTS2S-288	2-1/2X3/4 (1)	1	5	049	342.98
HTS2S-291	2-1/2X1-1/2 (2)	1	5	049	484.86
HTS2S-334	3X3/4 (1)	1	5	049	324.63
HTS2S-337	3X1-1/2 (2)	1	5	049	492.42
HTS2S-416	4X3/4 (1)	1	5	049	351.63



PVC/CPVC Clamp-On & Hot-Tap Saddles

Part Number	Size	Std Pk	Mstr Ctn	Disc Code	Price Each
-------------	------	--------	----------	-----------	------------

**PVC Gray Hot-Tap Saddle (continued)
EPDM with Stainless Steel Cutter & Bolts**

HTS2S-419	4X1-1/2 (2)	1	0	049	506.57
HTS2S-524	6X3/4 (1))	1	5	049	388.46
HTS2S-527	6X1-1/2 (2)	1	0	049	557.04
HTS2S-574	8X3/4 (1)	1	0	049	554.19
HTS2S-577	8X1-1/2 (2)	1	0	049	658.10

**PVC Gray Hot-Tap Saddle
Viton® with Stainless Steel Cutter & Bolts**

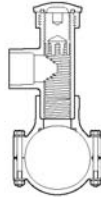

2"-4" 235, 6" 200, 8" 150 psi @ 73°F (23°C)

HTS3S-248	2X3/4 (1)	1	5	049	325.62
HTS3S-251	2X1-1/2 (2)	1	5	049	492.08
HTS3S-288	2-1/2X3/4 (1)	1	5	049	348.44
HTS3S-291	2-1/2X1-1/2 (2)	1	5	049	493.79
HTS3S-334	3X3/4 (1)	1	5	049	328.59
HTS3S-337	3X1-1/2 (2)	1	5	049	503.87
HTS3S-416	4X3/4 (1)	1	5	049	358.63
HTS3S-419	4X1-1/2 (2)	1	0	049	520.57
HTS3S-524	6X3/4 (1)	1	5	049	395.44
HTS3S-527	6X1-1/2 (2)	1	0	049	570.44
HTS3S-574	8X3/4 (1)	1	0	049	559.81
HTS3S-577	8X1-1/2(20)	1	0	049	670.52

**CPVC Gray Hot-Tap Saddle
EPDM Saddle x Soc (Spigot) Zinc
Plated Bolts**

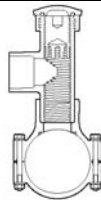

2"-4" 235, 6" 200, 8" 150 psi @ 73°F (23°C)

HT2-248C	2X3/4 (1)	1	5	050	71.48
HT2-251C	2X1-1/2 (2)	1	5	050	147.53
HT2-288C	2-1/2X3/4 (1)	1	5	050	76.30
HT2-291C	2-1/2X1-1/2 (2)	1	5	050	152.47
HT2-334C	3X3/4 (1)	1	5	050	87.41
HT2-337C	3X1-1/2 (2)	1	5	050	168.14
HT2-416C	4X3/4 (1)	1	5	050	100.99
HT2-419C	4X1-1/2 (2)	1	0	050	177.78
HT2-524C	6X3/4 (1)	1	5	050	113.58
HT2-527C	6X1-1/2 (2)	1	0	050	189.26
HT2-574C	8X3/4 (1)	1	5	050	494.01
HT2-577C	8X1-1/2 (2)	1	0	050	195.43

Part Number	Size	Std Pk	Mstr Ctn	Disc Code	Price Each
-------------	------	--------	----------	-----------	------------

**CPVC Gray Hot-Tap Saddle
EPDM Saddle x Soc (Spigot) SS316
Bolts**

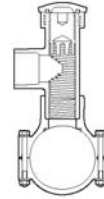

2"-4" 235, 6" 200, 8" 150 psi @ 73°F (23°C)

HT2S-248C	2X3/4 (1)	1	5	050	111.11
HT2S-251C	2X1-1/2 (2)	1	5	050	229.63
HT2S-288C	2-1/2X3/4 (1)	1	5	050	118.77
HT2S-291C	2-1/2X1-1/2 (2)	1	5	050	237.41
HT2S-334C	3X3/4 (1)	1	5	050	136.18
HT2S-337C	3X-1/2 (2)	1	5	050	261.73
HT2S-416C	4X3/4 (1)	1	5	050	157.29
HT2S-419C	4X1-1/2 (2)	1	0	050	276.79
HT2S-524C	6X3/4 (1)	1	5	050	176.54
HT2S-527C	6X1-1/2 (2)	1	0	050	294.57
HT2S-574C	8X3/4 (1)	1	0	050	190.87
HT2S-577C	8X1-1/2 (2)	1	0	050	318.52

**CPVC Gray Hot-Tap Saddle
Viton® Saddle x Soc (Spigot) Zinc
Plated Bolts**

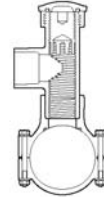

2"-4" 235, 6" 200, 8" 150 psi @ 73°F (23°C)

HT3-248C	2X3/4 (1)	1	5	050	77.66
HT3-251C	2X1-1/2 (2)	1	5	050	160.12
HT3-288C	2-1/2X3/4 (1)	1	5	050	82.97
HT3-291C	2-1/2X1-1/2 (2)	1	5	050	165.43
HT3-334C	3X3/4 (1)	1	5	050	94.81
HT3-337C	3X1-1/2 (2)	1	5	050	182.71
HT3-416C	4X3/4 (1)	1	5	050	170.62
HT3-419C	4X1-1/2 (2)	1	0	050	193.09
HT3-524C	6X3/4 (1)	1	5	050	123.33
HT3-527C	6X1-1/2 (2)	1	0	050	204.93
HT3-574C	8X3/4 (1)	1	0	050	133.33
HT3-577C	8X1-1/2 (2)	1	0	050	248.40

**CPVC Gray Hot-Tap Saddle
Viton® Saddle x Soc (Spigot) SS316
Bolts**

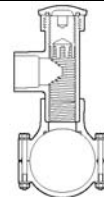

2"-4" 235, 6" 200, 8" 150 psi @ 73°F (23°C)

HT3S-248C	2X3/4 (1)	1	5	050	120.99
HT3S-251C	2X-1-1/2 (2)	1	5	050	249.38
HT3S-288C	2-1/2X3/4 (1)	1	5	050	129.13
HT3S-291C	2-1/2X1-1/2 (2)	1	5	050	257.41
HT3S-334C	3X3/4 (1)	1	5	050	147.41
HT3S-337C	3X1-1/2 (2)	1	5	050	289.63
HT3S-416C	4X3/4 (1)	1	5	050	170.62

PVC/CPVC Clamp-On & Hot-Tap Saddles



Part Number	Size	Std Pk	Mstr Ctn	Disc Code	Price Each
-------------	------	--------	----------	-----------	------------

CPVC Gray Hot-Tap Saddle (continued)

Viton® Saddle x Soc (Spigot) SS316 Bolts

HT3S-419C	4X1-1/2 (2)	1	0	050	300.62
HT3S-524C	6X3/4 (1)	1	5	050	191.98
HT3S-527C	6X1-1/2 (2)	1	0	050	319.01
HT3S-574C	8X3/4 (1)	1	0	050	207.53
HT3S-577C	8X1-1/2 (2)	1	5	050	344.88

CPVC Gray Hot-Tap Saddle
EPDM with Stainless Steel Cutter & Bolts

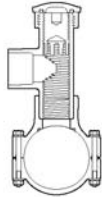

2"-4" 235, 6" 200, 8" 150 psi @ 73°F (23°C)

HTS2S-248C	2X3/4 (1)	1	5	050	341.86
HTS2S-251C	2X1-1/2 (2)	1	5	050	506.63
HTS2S-288C	2-1/2X3/4 (1)	1	5	050	365.78
HTS2S-291C	2-1/2X1-1/2 (2)	1	5	050	507.44
HTS2S-334C	3X3/4 (1)	1	5	050	348.88
HTS2S-337C	3X1-1/2 (2)	1	5	050	521.60
HTS2S-416C	4X3/4 (1)	1	5	050	371.48
HTS2S-419C	4X1-1/2 (2)	1	0	050	534.57
HTS2S-524C	6X3/4 (1)	1	5	050	433.02
HTS2S-527C	6X1-1/2 (2)	1	0	050	604.29
HTS2S-574C	8X3/4 (1)	1	0	050	600.69
HTS2S-577C	8X1-1/2 (2)	1	0	050	715.46

CPVC Gray Hot-Tap Saddle
Viton® with Stainless Steel Cutter & Bolts

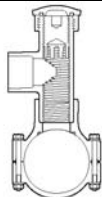

2"-4" 235, 6" 200, 8" 150 psi @ 73°F (23°C)

HTS3S-248C	2X3/4 (1)	1	5	050	347.21
HTS3S-251C	2X1-1/2 (2)	1	5	050	514.34
HTS3S-288C	2-1/2X3/4 (1)	1	5	050	371.60
HTS3S-291C	2-1/2X1-1/2 (2)	1	5	050	516.37
HTS3S-334C	3X3/4 (1)	1	5	050	319.52
HTS3S-337C	3X1-1/2 (2)	1	5	050	530.66
HTS3S-416C	4X3/4 (1)	1	5	050	378.48
HTS3S-419C	4X1-1/2 (2)	1	0	050	547.98
HTS3S-524C	6X3/4 (1)	1	5	050	439.79
HTS3S-527C	6X1-1/2 (2)	1	1	050	617.68
HTS3S-574C	8X3/4 (1)	1	0	050	613.98
HTS3S-577C	8X1-1/2 (2)	1	0	050	721.86



PVC/CPVC Clamp-On & Hot-Tap Saddles

SPEARS® QUALITY POLICY

It is the policy and objective of Spears® Manufacturing Company to produce a superior quality product suitable for its intended use, with regard to functionality, structural integrity, and conformance to established industry standards and practices. It is the commitment of this Company to do so in a manner which provides consistency of product quality, optimum availability, and superior customer service, while maintaining efficiency of operations and profitability necessary to perpetuate product improvement and customer satisfaction. Furthermore, it is recognized that the attainment of these objectives is the responsibility of all Company operations and personnel according to their respective functions.

LIMITED WARRANTY

Except as otherwise mandated by law, Spears® Manufacturing Company warrants that the goods which have been directly manufactured by them shall be free from defects in material and workmanship for a period of one (1) year, from the date of shipment. CUSTOMER AGREES THAT THIS WARRANTY SHALL BE EFFECTIVE SO LONG AS THE GOODS ARE USED SOLELY FOR THE NORMAL PURPOSES FOR WHICH THEY ARE INTENDED AND IN CONFORMANCE WITH INDUSTRY ESTABLISHED ENGINEERING, INSTALLATION, OPERATING, AND MAINTENANCE SPECIFICATIONS, RECOMMENDATIONS AND INSTRUCTIONS. VIOLATION THEREOF SHALL VOID THIS WARRANTY AND RELIEVE COMPANY FROM ANY OBLIGATION UNDER THIS WARRANTY. COMPANY CANNOT AND DOES NOT ASSUME RESPONSIBILITY, AND EXPRESSLY DISCLAIMS ANY LIABILITY, DUE TO CUSTOMER'S, ANY INSTALLER'S OR END USER'S FAILURE TO COMPLY WITH SUCH SPECIFICATIONS, RECOMMENDATIONS AND INSTRUCTIONS, INCLUDING, BUT NOT LIMITED TO, DAMAGE DUE TO: IMPROPER CONTROL OF SYSTEM HYDRAULICS, IMPROPER WINTERIZATION PROCEDURES, IMPROPER VOLTAGE SUPPLY, CONTACT WITH INCOMPATIBLE MATERIALS OR CHEMICALS, EXCAVATION/DIGGING, EXCESSIVE WEIGHT, AND VANDALISM. COMPANY SHALL NOT BE LIABLE FOR DAMAGES DUE TO ANY ACTS OF NATURE INCLUDING, BUT NOT LIMITED TO, LIGHTNING, EARTHQUAKES, GROUND MOVEMENT, FROST HEAVE, OR FLOODS.

If Customer receives any goods that appear to be defective, upon receipt of a Return Authorization (RA#) issued by Spears® Customer Services Department, Customer may return such questionable goods. The material must be returned prepaid to Company at 15853 Olden Street, Sylmar, California 91342 along with completed Return Authorization documentation. After examination if the goods are determined to be defective in materials or workmanship directly provided by Company, Company, at its sole option, may either repair or replace the defective goods, or reimburse Customer for the cost of such goods. This shall be Customer's only remedy. All costs of shipping such questionable goods and any replacements thereof to and from Company's facility shall be borne by Customer. Customer agrees that Company will not be responsible for other parts or labor in connection with repairing, replacing, or returning such goods while goods are in possession of Company for analysis, nor for any delays beyond Company's reasonable control (including, with limitation, delays due to unavailability of materials, equipment, other supplies or labor, strikes, governmental regulation or other acts of God), provided that any delay shall toll the warranty period for the same amount of time as the delay itself.

COMPANY EXTENDS ONLY THIS WARRANTY AND EXPLICITLY WAIVES ALL OTHER WARRANTIES, EXPRESSED OR IMPLIED, ORAL OR STATUTORY (INCLUDING ANY IMPLIED WARRANTIES OR AFFIRMATION, SUITABILITY, MERCHANTABILITY OR FITNESS FOR A PARTICULAR PURPOSE) APPLICABLE TO THE GOODS. NO AFFIRMATION BY COMPANY OR ANY OF ITS REPRESENTATIVES, BY WORDS OR CONDUCT, SHALL CONSTITUTE A WARRANTY. THIS WARRANTY MAY NOT BE EXTENDED, ALTERED OR OTHERWISE MODIFIED EXCEPT BY WRITTEN AGREEMENT SIGNED BY COMPANY.

BY ITS ACCEPTANCE OF THE GOODS, CUSTOMER HEREBY SPECIFICALLY AND EXPRESSLY WAIVES ALL OTHER LIABILITY OR OBLIGATION OF ANY KIND OR CHARACTER OF COMPANY, INCLUDING WITHOUT LIMITATION LIABILITY PREDICATED UPON STRICT LIABILITY OR TORT, AND ALL DAMAGES AND LOSSES AS A RESULT THEREOF, INCLUDING BUT NOT LIMITED TO ALL KNOWN, UNKNOWN, FORESEEABLE, UNFORESEEABLE, ABSOLUTE, CONTINGENT, LIQUIDATED, NON-LIQUIDATED, COMPENSATORY, GENERAL, SPECIAL, CONSEQUENTIAL, INCIDENTAL, OR PUNITIVE DAMAGES, AND WITH RESPECT TO THE GOODS, THEIR RETURN, REPAIR, RESTORATION AND REPLACEMENT. WITH RESPECT TO SUCH WAIVER, CUSTOMER HEREBY EXPLICITLY WAIVES CALIFORNIA CIVIL CODE §1542 WHICH STATES "A GENERAL RELEASE DOES NOT EXTEND TO CLAIMS WHICH THE CREDITOR DOES NOT KNOW OR SUSPECT TO EXIST IN HIS FAVOR AT THE TIME OF EXECUTING THIS RELEASE, WHICH IF KNOWN BY HIM MUST HAVE MATERIALLY ADVERSELY AFFECTED HIS SETTLEMENT WITH DEBTOR" AND ALL OTHER SIMILAR STATUTORY, COMMON AND CASE LAW RIGHTS, DEFENSES AND LIMITATIONS.

Having independently inspected a sample of the goods as fully as desired or having refused to make such examination upon acceptance of delivery of the goods, and except as otherwise herein provided, Customer hereby accepts the goods in its "AS IS" condition "WITH ALL FAULTS" without any other warranty, expressed or implied, and hereby accepts and assumes the entire risk and cost of all necessary servicing, repairs and remedy thereof.

PVC/CPVC Clamp-On & Hot-Tap Saddles



STANDARDS & SPECIFICATIONS

Standards provide greater assurance of product performance and consistency, and are available to assist design engineers in system specification. The most frequently referenced industry standards for plastic piping systems are ASTM Standard Specifications and Practices. Along with ASTM Standards, additional product specifications and certifications form the basis of product conformance to which Spears® products are manufactured.

ASTM D 1784

Rigid Poly (Vinyl Chloride) (PVC) Compounds and Chlorinated Poly (Vinyl Chloride) (PVC) Compounds.



National Sanitation Foundation (NSF) Standard 61 and/or 14 Plastic Fittings for Potable Water.

Material

Spears® Clamp-on and Hot-Tap Saddles are produced from PVC Type I, Cell Classification 12454; and from CPVC Type IV, Cell Classification 23447.

Standard hardware (mounting bolts, nuts, washers) is zinc plated steel with optional Stainless Steel as indicated.

Prices subject to change without notice. Possession of this price schedule shall not be construed as an offer to sell the products listed. Product drawings and/or photographs are representative and may not fully reflect product configurations.

RECOMMENDATIONS FOR INSTALLERS & USERS

Plastic piping systems should be ENGINEERED, INSTALLED, and OPERATED in accordance with ESTABLISHED DESIGN AND ENGINEERING STANDARDS AND PROCEDURES for plastic piping systems. Suitability for the intended service application should be determined by the installer and/or user prior to installation of a plastic piping system. PRIOR TO ASSEMBLY, all piping system components should be inspected for damage or irregularities. Mating components should be checked to assure that tolerances and engagements are compatible. Do not use any components that appear irregular or do not fit properly. Contact the appropriate manufacturer of the component product in question to determine usability. Consult all applicable codes and regulations for compliance prior to installation.

SOLVENT WELD CONNECTIONS - Use a quality grade of primer and solvent cement formulated for the type of connection, with the CORRECT SIZE APPLICATOR. Read and follow all of the solvent cement MANUFACTURER'S APPLICATION AND CURE TIME INSTRUCTIONS THOROUGHLY.

BEFORE APPLYING PRIMER AND CEMENT, appropriate safety precautions should be taken. Primer and Cement should be stored in the shade between 40°F and 110°F. Eliminate all ignition sources. Avoid breathing of vapors. Use only with adequate ventilation; explosion-proof general mechanical ventilation or local exhaust is recommended to maintain vapor concentrations below recommended exposure limits. In confined or partially enclosed areas, a NIOSH-approved organic vapor cartridge respirator with full face-piece is recommended. Containers should be kept tightly closed when not in use, and covered as much as possible when in use. Avoid frequent contact with skin; wearing PVA coated protective gloves and impervious apron are recommended. Avoid any contact with eyes; splash-proof chemical goggles are recommended.

THREADED CONNECTIONS - Use a quality grade thread sealant. WARNING: SOME PIPE JOINT COMPOUNDS OR TEFLON® PASTES MAY CONTAIN SUBSTANCES THAT COULD CAUSE STRESS CRACKING TO PLASTIC. Spears® Manufacturing Company recommends the use of Spears® **BLUE 75™** Thread Sealant which has been tested for compatibility with Spears® products. Please follow the sealant manufacturers' application/ installation instructions. Choice of an appropriate thread sealant other than those listed above is at the discretion of the installer. 1 to 2 turns beyond FINGER TIGHT is generally all that is required to make a sound plastic threaded connection. Unnecessary OVER TIGHTENING will cause DAMAGE TO BOTH PIPE AND FITTING.



PVC/CPVC Clamp-On & Hot-Tap Saddles

IMPORTANT

WATER HAMMER - Spears® Manufacturing Company, Inc., recommends that all PVC and CPVC plastic piping systems be designed and constructed to AVOID EXCESSIVE WATER HAMMER. Water hammer can cause damage, and failure to pipe, valves, and fittings within the piping system.

PLEASE NOTE - When temperatures rise above 73°F, the tensile strength of thermoplastics decreases, thereby derating the pipe or fitting Maximum Internal Pressure. When temperatures fall below 73°F, the tensile strength of thermoplastics increases, however, the impact strength decreases. Maximum operating temperatures for PVC piping systems should not exceed 140°F. Maximum operating temperatures for CPVC piping systems should not exceed 200°F.

CAUTION - Spears® Manufacturing Company DOES NOT RECOMMEND the use of thermoplastic piping products for systems to transport or store compressed air or gases, or the testing of thermoplastic piping systems with compressed air or gases in above and below ground locations. The use of Spears® products in compressed air or gas systems automatically voids Spears® warranty for such products, and their use against our recommendation is entirely the responsibility and liability of the installer. Spears® Manufacturing Company will not accept responsibility for damage or impairment of its products, or other consequential or incidental damages caused by misapplication, incorrect assembly, and/or exposure to harmful substances or conditions.

NOT FOR USE WITH COMPRESSED AIR OR GASES

WARNING: DO NOT USE COMPRESSED AIR OR GAS TO TEST ANY PVC OR CPVC THERMOPLASTIC PIPING PRODUCT OR SYSTEM, AND DO NOT USE DEVICES PROPELLED BY COMPRESSED AIR OR GAS TO CLEAR SYSTEMS. THESE PRACTICES MAY RESULT IN EXPLOSIVE FRAGMENTATION OF SYSTEM PIPING AND COMPONENTS CAUSING SERIOUS OR FATAL BODILY INJURY.



CONTENT

CATALOG INFORMATION

HOW TO USE THIS CATALOG	1
COLUMN HEADER INFORMATION	1
PRODUCT CONFIGURATION	1
CONFIGURATION DESCRIPTIONS & PART INFORMATION	1

PRODUCTS

PVC White Clamp-On Saddle x Soc Single Outlet with Buna-N O-ring Seal & Zinc-Plated Hardware	3
PVC White Clamp-On Saddle x Soc Single Outlet with Buna-N O-ring Seal & SS Hardware	3
PVC White Clamp-On Saddle x Soc Single Outlet with EPDM O-ring Seal & Zinc-Plated Hardware	4
PVC White Clamp-On Saddle x Soc Single Outlet with EPDM O-ring & Seal & SS Hardware	4
PVC White Clamp-On Saddle x SR Thread Single Outlet with Buna-N O-ring Seal & Zinc-Plated Hardware	5
PVC White Clamp-On Saddle x SR Thread Single Outlet with Buna-N O-ring Seal & SS Hardware	5
PVC White Clamp-On Saddle x SR Thread Single Outlet with EPDM O-ring Seal & Zinc-Plated Hardware	6
PVC White Clamp-On Saddle x SR Thread Single Outlet with EPDM O-ring Seal & SS Hardware	6
PVC White Clamp-On Saddle x Soc Double Outlet with Buna-N O-ring Seal & Zinc-Plated Hardware	7
PVC White Clamp-On Saddle x Soc Double Outlet with Buna-N O-ring Seal & SS Hardware	7
PVC White Clamp-On Saddle x Soc Double Outlet with EPDM O-ring Seal & Zinc-Plated Hardware	8
PVC White Clamp-On Saddle x Soc Double Outlet with EPDM O-ring Seal & SS Hardware	8
PVC White Clamp-On Saddle x SR Thread Double Outlet with Buna-N O-ring Seal & Zinc-Plated Hardware	9
PVC White Clamp-On Saddle x SR Thread Double Outlet with Buna-N O-ring Seal & SS Hardware	9
PVC White Clamp-On Saddle x SR Thread Double Outlet with EPDM O-ring Seal & Zinc-Plated Hardware	10
PVC White Clamp-On Saddle x SR Thread Double Outlet with EPDM O-ring Seal & SS Hardware	10
PVC Gray Clamp-On Saddle x Soc Single Outlet with Viton® O-ring Seal & Zinc-Plated Hardware	11
PVC Gray Clamp-On Saddle x Soc Single Outlet with Viton® O-ring Seal & SS Hardware	11
PVC Gray Clamp-On Saddle x Soc Single Outlet with EPDM O-ring Seal & Zinc-Plated Hardware	12
PVC Gray Clamp-On Saddle x Soc Single Outlet with EPDM O-ring Seal & SS Hardware	12
PVC Gray Clamp-On Saddle x SR Thread Single Outlet with Viton® O-ring Seal & Zinc-Plated Hardware	13
PVC Gray Clamp-On Saddle x SR Thread Single Outlet with Viton® O-ring Seal & SS Hardware	13
PVC Gray Clamp-On Saddle x SR Thread Single Outlet with EPDM O-ring Seal & Zinc-Plated Hardware	14
PVC Gray Clamp-On Saddle x SR Thread Single Outlet with EPDM O-ring Seal & SS Hardware	14
PVC Gray Clamp-On Saddle x Soc Double Outlet with Viton® O-ring Seal & Zinc-Plated Hardware	15
PVC Gray Clamp-On Saddle x Soc Double Outlet with Viton® O-ring Seal & SS Hardware	15
PVC Gray Clamp-On Saddle x Soc Double Outlet with EPDM O-ring Seal & Zinc-Plated Hardware	16



PVC/CPVC Clamp-On & Hot-Tap Saddles

CONTENT

PVC Gray Clamp-On Saddle x Soc Double Outlet with EPDM O-ring Seal & SS Hardware	16
PVC Gray Clamp-On Saddle x SR Thread Double Outlet with Viton® O-ring Seal & Zinc-Plated Hardware	17
PVC Gray Clamp-On Saddle x SR Thread Double Outlet with Viton® O-ring Seal & SS Hardware	17
PVC Gray Clamp-On Saddle x SR Thread Double Outlet with EPDM O-ring Seal & Zinc-Plated Hardware	18
PVC Gray Clamp-On Saddle x SR Thread Double Outlet with EPDM O-ring Seal & SS Hardware	18
CPVC Gray Clamp-On Saddle x Soc Single Outlet with Viton® O-ring Seal & Zinc-Plated Hardware	19
CPVC Gray Clamp-On Saddle x Soc Single Outlet with Viton® O-ring Seal & SS Hardware	19
CPVC Gray Clamp-On Saddle x Soc Single Outlet with EPDM O-ring Seal & Zinc-Plated Hardware	20
CPVC Gray Clamp-On Saddle x Soc Single Outlet with EPDM O-ring Seal & SS Hardware	20
CPVC Gray Clamp-On Saddle x SR Thread Single Outlet with Viton® O-ring Seal & Zinc-Plated Hardware	21
CPVC Gray Clamp-On Saddle x SR Thread Single Outlet with Viton® O-ring Seal & SS Hardware	21
CPVC Gray Clamp-On Saddle x SR Thread Single Outlet with EPDM O-ring Seal & Zinc-Plated Hardware	22
CPVC Gray Clamp-On Saddle x SR Thread Single Outlet with EPDM O-ring Seal & SS Hardware	23
CPVC Gray Clamp-On Saddle x Soc Double Outlet with Viton® O-ring Seal & Zinc-Plated Hardware	23
CPVC Gray Clamp-On Saddle x Soc Double Outlet with Viton® O-ring Seal & SS Hardware	24
CPVC Gray Clamp-On Saddle x Soc Double Outlet with EPDM O-ring Seal & Zinc-Plated Hardware	24
CPVC Gray Clamp-On Saddle x Soc Double Outlet with EPDM O-ring Seal & SS Hardware	25
CPVC Gray Clamp-On Saddle x SR Thread Double Outlet with Viton® O-ring Seal & Zinc-Plated Hardware	25
CPVC Gray Clamp-On Saddle x SR Thread Double Outlet with Viton® O-ring Seal & SS Hardware	26
CPVC Gray Clamp-On Saddle x SR Thread Double Outlet with EPDM O-ring Seal & Zinc-Plated Hardware	26
CPVC Gray Clamp-On Saddle x SR Thread Double Outlet with EPDM O-ring Seal & SS Hardware	27
PVC White Hot-Tap Saddle EPDM Saddle x Soc (Spigot) Zinc Plated Bolts	27
PVC White Hot-Tap Saddles EPDM Saddle x Soc (Spigot) SS316 Bolts	27
PVC Gray Hot-Tap Saddle EPDM Saddle x Soc (Spigot) Zinc Plated Bolts	28
PVC Gray Hot-Tap Saddle EPDM Saddle x Soc (Spigot) SS316 Bolts	28
PVC Gray Hot-Tap Saddle Viton® Saddle x Soc (Spigot) Zinc Plated Bolts	28
PVC Gray Hot-Tap Saddle Viton® Saddle x Soc (Spigot) SS316 Bolts	28
PVC Gray Hot-Tap Saddle EPDM with Stainless Steel Cutter & Bolts	28
PVC Gray Hot-Tap Saddle Viton® with Stainless Steel Cutter & Bolts	29
CPVC Gray Hot-Tap Saddle EPDM Saddle x Soc (Spigot) Zinc Plated Bolts	29
CPVC Gray Hot-Tap Saddle EPDM Saddle x Soc (Spigot) SS316 Bolts	29
CPVC Gray Hot-Tap Saddle Viton® Saddle x Soc (Spigot) Zinc Plated Bolts	29
CPVC Gray Hot-Tap Saddle Viton® Saddle x Soc (Spigot) SS316 Bolts	29
CPVC Gray Hot-Tap Saddle EPDM with Stainless Steel Cutter & Bolts	30

PVC/CPVC Clamp-On & Hot-Tap Saddles



CONTENT

CPVC Gray Hot-Tap Saddle Viton® with Stainless Steel Cutter & Bolts	30
COMPANY INFORMATION	
SPEARS® QUALITY POLICY	31
LIMITED WARRANTY	31
STANDARDS & SPECIFICATIONS	32
INSTALLATION INFORMATION	
RECOMMENDATIONS FOR INSTALLERS & USERS	32

NOTES

NOTES

Watch for New Product Announcements from Spears® Innovation and Technology



SPEARS® MANUFACTURING COMPANY



CORPORATE OFFICE

15853 Olden Street, Sylmar, CA 91342
PO Box 9203, Sylmar, CA 91392
(818) 364-1611 • www.spearsmfg.com

PACIFIC SOUTHWEST

15860 Olden Street
Sylmar (Los Angeles), CA 91342
P.O. Box 9203, Sylmar, CA 91392
(818) 364-1611
(800) 862-1499
Fax (818) 367-3014

NORTHWEST

4103 C St. NE Suite 200
Auburn (Seattle), WA
98002
(253) 939-4433
(800) 347-7327
Fax (253) 939-7557

ROCKY MOUNTAIN

4880 Florence Street
Denver, CO
80238
(303) 371-9430
(800) 777-4154
Fax (303) 375-9546

SOUTH CENTRAL

4250 Patriot Drive, Suite 300
Grapevine (Dallas), TX
76051-2317
(972) 691-4003
(800) 441-1437
Fax (972) 691-4404

UTAH

5395 West 1520 South
Salt Lake City, UT
84104
(303) 371-9430
(800) 777-4154
Fax (303) 375-9546

NORTHEAST

590 Industrial Drive, Suite 100
Lewisberry (Harrisburg), PA
17339-9532
(717) 938-8844
(800) 233-0275
Fax (717) 938-6547

SOUTHEAST

4205 Newpoint Place, Suite 100
Lawrenceville (Atlanta), GA
30043
(678) 985-1263
(800) 662-6326
Fax (678) 985-5642

FLORIDA

9563 Parksouth Court
Orlando, FL
32837
(407) 843-1960
(800) 327-6390
Fax (407) 425-3563

MIDWEST

1 Gateway Court, Suite A
Bolingbrook (Chicago), IL
60440
(630) 759-7529
(800) 662-6330
Fax (630) 759-7515

INTERNATIONAL SALES

15853 Olden Street
Sylmar (Los Angeles), CA
91342
(818) 364-1611
Fax (818) 898-3774

AUTHORIZED DISTRIBUTOR