

*The Project for
Capacity Development of Road and Bridge Technology
in the Republic of the Union of Myanmar (2016-2019)*



QUALITY CONTROL MANUAL FOR CONCRETE STRUCTURE

(1st Edition)



April 2019

Ministry of Construction, the Republic of the Union of Myanmar

Japan International Cooperation Agency

PREFACE

In the exercise of its primary mandate as the construction arm of the government, the Ministry of Construction endeavors to keep abreast with systematic quality control and the latest construction techniques, with the ultimate objective of being at par with the more advanced countries in ASEAN.

This quintessential goal cannot be achieved without having to adopt clear-cut, uniform, systematic and definitive procedures on Construction Supervision on Quality/Safety Control in the first place. It is a given prerequisite that Quality Infrastructure must be a direct result of good management and project implementation.

This manual, which was jointly prepared by the MOC Engineering Staff and the Experts assigned for the Project for Capacity Development of Road and Bridge Technology in the Republic of the Union of Myanmar (2016-2019) under the Japan International Cooperation Agency (JICA), serves an effective reference material to field engineers of road and bridge construction, instrumental in our pursuit of the aforementioned ambitious objective.

With this manual, the field engineers should become familiar with and knowledgeable of the overall process in Quality Control and Safety Control, thus making them more competent in constructing government projects that are in accordance with and in strict compliance to the specification/contract requirements of the project.

April 2019



U Han Zaw
Union Minister
Ministry of Construction,
the Republic of the Union of Myanmar

INTRODUCTION

BACKGROUND

The bridge construction technology has maintained in certain technological level since “Bridge Engineering Training Center (BETC) Project (1979-1985: JICA), however, new technology has not been transferred and bridge types that can be constructed in Myanmar are still limited. Besides, insufficient training for national engineers has hampered sustainable transfer of technology in bridge engineering. In this context, the Government of Myanmar requested “the Project for Capacity Development of Road and Bridge Technology” (hereinafter referred to as “the Project”) to the Government of Japan. Through series of discussion, Ministry of Construction (MOC) and JICA concluded the Record of Discussion (R/D) in January 2016 to implement the Project focusing on capacity development on construction supervision of bridges and concrete structures.

The Project was implemented for 3 years since 2016 in corroboration with MOC staff officer and JICA Experts aiming at improvement of quality as well as safety in construction of bridges and concrete structures. As the achievement of the Project, the Manuals on Quality and Safety Control for Bridge and Concrete Structure were developed in 2019 after several workshop and discussion.

REFERENCES

Following technical documents were referred as references.

- 1) Specification for Highway Bridges (2012, Japan Road Association, Japan)
- 2) Standard Specifications for Concrete Structures (2012, Japan Society of Civil Engineering)
- 3) Manual for Construction of Bridge Foundation (2015, Japan Road Association)
- 4) AASHTO LRFD Bridge Construction Specifications (3rd Edition, 2010)
- 5) The Guidance for the Management of Safety for Construction Works in Japanese ODA Projects (2014, JICA)
- 6) Manual for Construction Supervision of Concrete Works. (2016, NEXCO)
- 7) Manual for Construction Supervision of Road and Bridge Structures. (2016, NEXCO)
- 8) Construction Contract MDB Harmonized Edition (Version 3, 2010 Harmonized Red Book)

FLOWCHART OF QUALITY CONTROL FOR CONCRETE STRUCTURE

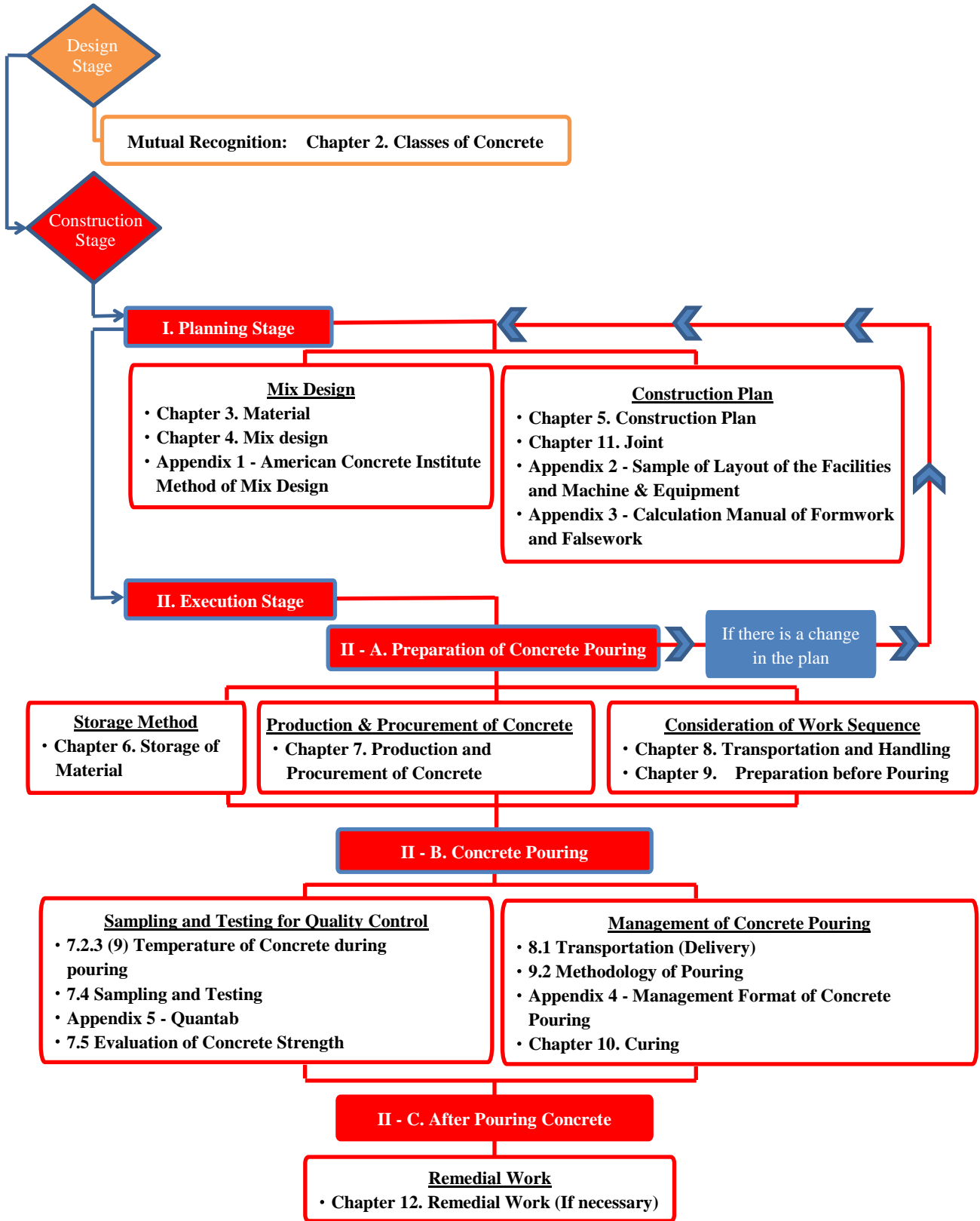

QUALITY CONTROL MANUAL FOR CONCRETE STRUCTURE

TABLE OF CONTENT

CHAPTER 1.	GENERAL.....	1
CHAPTER 2.	CLASSES OF CONCRETE	1
CHAPTER 3.	MATERIALS.....	3
CHAPTER 4.	MIX DESIGN	7
CHAPTER 5.	CONSTRUCTION PLAN	10
CHAPTER 6.	STORAGE OF MATERIAL	22
CHAPTER 7.	PRODUCTION AND PROCUREMENT OF CONCRETE	27
CHAPTER 8.	TRANSPORTATION AND HANDLING	36
CHAPTER 9.	PREPARATION BEFORE POURING AND METHODOLOGY OF POURING	41
CHAPTER 10.	CURING CONCRETE	51
CHAPTER 11.	JOINT	55
CHAPTER 12.	REMEDIAL WORK.....	62
Appendices	65
Appendix 1	_ American Concrete Institute Method of Mix Design (ACI-211.1)	67
Appendix 2	_ Sample of Fixing Layout of the Facilities and Machine & Equipment.....	75
Appendix 3	- Calculation Manual of Formwork and Falsework	76
Appendix 4	- Management Format of Concrete Pouring.....	93
Appendix 5	- Quantab	95
Appendix 6	- Checklists.....	98

ABBREVIATIONS

AASHTO:	American Association of State Highway and Transportation Officials
ASTM:	American Society for Testing and Materials
JIS	Japan Industrial Standard
AE:	Air Entrainment
HPC:	High Performance Concrete
ACI:	American Concrete Institute
PH:	Potential of Hydrogen
CJ:	Construction Joint
EJ:	Expansion Joint
PVC:	Poly Vinyl Chloride

CHAPTER 1. GENERAL

Manual of Quality Control was made up as the purpose for improvement of Concrete Works of Bridge construction in Myanmar. However, this is initial version, so MOC is required to revise, add and improve contents depending the situation of construction conditions.

The contents are mostly referred as ASTM (American Society for Testing and Materials) and equivalent specification JIS (Japan Industrial Standard), but MOC can modify the contents considering the present specification in Myanmar.

CHAPTER 2. CLASSES OF CONCRETE

2.1 Definition of Classes of Concrete in AASHTO

AASHTO instructs that classes of concrete to be used in all part of structures shall be specified in contract documents. If not specified, the engineer shall designate the class of concrete to be used.

2.2 Normal-Weight(-Density) Concrete

In AASHTO, ten classes of normal-weight (-density) concrete are specified as listed in Table 2.2-1, except that for concrete in or over saltwater or exposed to deicing chemicals. the maximum water/cement ratio shall be 45%.

At present, there are no specifications of classes of concrete in Myanmar. The classification of AASHTO shown below is as reference.

For Class B and Class B(AE), two sizes of coarse aggregate shall be required as shown in Table 2.2-1.

Table 2.2-1 Classification of Normal-Weight Concrete

Class of Concrete	Minimum Cement Content	Maximum Water/Cementitious Material Ratio	Air Content Range	Size of Coarse Aggregate Per AASHTO M 43 (ASTM D448)	Size Number ^a	Specified Compressive Strength
	lb/yd ³	lb per lb	%	Nominal Size		ksi at days
A	611	0.49	—	1.0 in.to No.4	57	4.0 at 28
A(AE)	611	0.45	6±1.5	1.0 in.to No.4	57	4.0 at 28
B	517	0.58	—	2.0 in.to 1.0 in. and 1.0 in.to No.4	3 57	2.4 at 28
B(AE)	517	0.55	5±1.5	2.0 in.to 1.0 in. and 1.0 in.to No.4	3 57	2.4 at 2p8
C	658	0.49	—	0.5 in.to No.4	7	4.0 at 28
C(AE)	658	0.45	7±1.5	0.5 in.to No.4	7	4.0 at 28
P	564	0.49	— ^b	1.0 in.to No.4 or 0.75 in. to No.4	7 67	≤6.0at ^b
S	658	0.58	—	1.0 in.to No.4	57	—
P(HPC)	— ^c	0.40	— ^b	≤0.75 in	67	>6.0 at ^b
A(HPC)	— ^c	0.45	— ^b	— ^c	— ^c	≤6.0 at ^b

Notes:

- As noted in AASHTO M 43 (ASTM D448), Table1-Standard Sizes of Processed Aggregate.
- As specified in the contract documents.
- Minimum cementitious materials content and coarse aggregate size to be selected to meet other performance criteria specified in the contract.

Table 2.2-2 Specification of Aggregates

Size No.	Nominal Size, Sieves with Square Openings	Amounts finer than each laboratory sieve, mass percent passing												
		100mm (4 in)	90mm (3½ in)	75mm (3 in)	63mm (2 ½ in)	50mm (2 in)	37.5mm (1 ½ in)	25.0mm (1 in)	19.0mm (¾ in)	12.5mm (½ in)	9.5mm (¾ in)	4.75mm (No. 4)	2.36mm (No. 8)	1.18mm (No.16)
1	90 to 37.5 mm (3 ½ to 1 ½ in)	100	90 to 100	-	25 to 60	-	0 to 15	-	0 to 15	-	-	-	-	-
2	63 to 37.5 mm (2 ½ to 1 ½ in)	-	-	100	90 to 100	35 to 70	0 to 15	-	0 to 5	-	-	-	-	-
3	50 to 25.0 mm (2 to 1 in)	-	-	-	100	90 to 100	35 to 70	0 to 15	-	0 to 5	-	-	-	-
357	50 to 4.75 mm (2 in to No. 4)	-	-	-	100	95 to 100	-	35 to 70	-	10 to 30	-	0 to 5	-	-
4	37.5 to 19.0 mm (1 ½ to ¾ in)	-	-	-	-	100	90 to 100	20 to 55	0 to 15	-	0 to 5	-	-	-
467	37.5 to 4.75 mm (1 ½ in to No.4)	-	-	-	-	100	95 to 100	-	35 to 70	-	10 to 30	0 to 5	-	-
5	25.0 to 12.5 mm (1 to ½ in)	-	-	-	-	-	100	90 to 100	20 to 55	0 to 10	0 to 5	-	-	-
56	25.0 to 9.5 mm (1 to ¾ in)	-	-	-	-	-	100	90 to 100	40 to 85	10 to 40	0 to 15	0 to 5	-	-
57	25.0 to 4.75 mm (1 in. to No.4)	-	-	-	-	-	100	95 to 100	-	25 to 60	-	0 to 10	0 to 5	-
6	19.0 to 9.5 mm (¾ to ¾ in)	-	-	-	-	-	-	100	90 to 100	20 to 55	0 to 15	0 to 5	-	-
67	19.0 to 4.75 mm (¾ in to No. 4)	-	-	-	-	-	-	100	90 to 100	-	25 to 55	0 to 10	0 to 5	-
7	12.5 to 4.75 mm (½ in to No.4)	-	-	-	-	-	-	-	100	90 to 100	40 to 70	0 to 15	0 to 5	-
8	9.5 to 2.36 mm (¾ in to No. 8)	-	-	-	-	-	-	-	-	100	85 to 100	10 to 30	0 to 10	0 to 5

Source: ASTM D448

With high performance concrete, it is desirable that the specifications be performance-based. Class P(HPC) is intended for use in prestressed concrete members with a specified concrete compressive strength more than 6.0 ksi (approx. 41.4 MPa) and should be always used for specified concrete strength more than 10.0 ksi (68.9 MPa). Class A(HPC) is intended for use in cast-in-place constructions which meet specified performance criteria in addition to concrete compressive strength. Other criteria might include shrinkage, chloride permeability, freeze-thaw resistance, deicer scaling resistance, abrasion resistance, or heat of hydration.

For both Class P(HPC) and A(HPC), the minimum cement content of each class is not specified because it should be determined by a producer based on the specified performance criteria. The maximum water-cementitious materials ratio is specified. The value of 0.40 for Class P(HPC) is less than the value of 0.49 for Class P, whereas the value of 0.45 for Class A(HPC) is the same as that for Class A(AE). For, the maximum size of coarse aggregate for Class P(HPC) concrete is specified since this class of concrete with aggregates larger than 0.75 in is difficult to achieve higher concrete compressive strength. The maximum aggregate size for Class A(HPC) concrete should be selected by a producer based on the specified performance criteria. Air content for Class A(HPC) and P(HPC) should be determined with trial tests but it is recommended that a minimum air content is two percent. The 28-day specified compression strength may not be appropriate for strength greater than 6.0 ksi (approx. 41.4 MPa).

CHAPTER 3. MATERIALS

3.1 Cements

Portland cements shall conform to the requirements of AASHTO M 85 (ASTM C150) and blended hydraulic cements shall conform to the requirements of AASHTO M 240 (ASTM C595) or ASTM C1157.

Except for Class P(HPC) and Class A(HPC) or when otherwise specified in the contract documents, only Type I, II, or III Portland cement; Types IA, IIA, or III air entrained Portland cement; or Types IP or IS blended hydraulic cements shall be used. Types IA, IIA, and IIIA cement may be used only in concrete where air entrainment is required.

Low-alkali cements conforming to the requirements of AASHTO M 85 (ASTM C150) shall be used when specified in the contract documents or when ordered by engineers as a condition of use for aggregates of limited alkali-silica reactivity.

Unless otherwise permitted, the product of only one mill of any one brand and type of cement shall be used for like elements of a structure that are exposed to view, except when cements must be blended for reduction of any excessive air entrainment where air-entraining cement is used.

For Class P(HPC) and Class A(HPC), trial batches using all intended constituent materials shall be made prior to concrete placement to ensure that cement and admixtures are compatible. Changes of mills, brands, or types of cement shall not be permitted without additional trial batches.

Nine types of cement categorized in AASHTO M85 shown in Table 3.1-1.

Table 3.1-1 Types of Cement are categorized in AASHTO M85

Type	For use
Type I	For use when the special properties specified for any other type are not required
Type IA	Air-entraining cement for the same uses as Type I, where air entrainment is desired
Type II	For general use, more especially when moderate sulfate resistance is desired
Type IIA	Air-entraining cement for the same uses as Type II, where air entrainment is desired
Type II(MH)	For general use, more especially when moderate heat of hydration and moderate sulfate resistance are desired
Type II(MH)A	Air-entraining cement for the same uses as Type II(MH), where air entrainment is desired
Type III	For use when high early strength is desired; Type IIIA—Air-entraining cement for the same use as Type III, where air entrainment is desired
Type IV	For use when low heat of hydration is desired
Type V	For use when high sulfate resistance is desired

Note 1— Some cement is designated with a combined type classification, such as Type I/II, indicating that the cement meets the requirements of the indicated types and is being offered as suitable for use when either type is desired.

ASTM C 1157 is a performance specification that does not require restrictions on composition or constituents of cement. It can be used to accept cement not conforming to AASHTO M 85 (ASTM C150) and AASHTO M 240 (ASTM C595).

3.2 Water

Water used in mixing and curing of concrete shall be subject to approval and shall be reasonably clean and free of oil, salt, acid, alkali, sugar, vegetable, or other injurious substances. Water shall be tested in accordance with, and shall meet the requirements of AASHTO T26. Water known to have potable quality may be used without tests. Where source of water is relatively shallow, an intake shall be enclosed to exclude silt, mud, grass, or other foreign materials.

Mixing water for concrete in which steel is embedded shall not contain a chloride ion concentration in excess of 1,000 ppm or sulfates in excess as SO_4 of 1,300 ppm. In JIS A 5308, water which is used for concrete other than tap water is specified as shown in Table 3.2-1.

Table 3.2-1 Specified Quality of Water other than Tap Water

Items	Specified Value
Suspended solid	Less than 2 g/l
Chloride ion	Less than 200 ppm
Difference of time of setting for cement	Less than 30minutes for initial setting, less than 60minutes for final setting
Ratio of compressive strength of mortar	More than 90% at age 7days and age 28days

It is better not to use sea water for plain concrete, because sea water will;

- accelerate alkali aggregate reaction,
- decrease Long-term strength growth of concrete, and
- reduce durability

3.3 Fine Aggregate

In Japan, it is defined as Fine aggregate that passes 85% of its mass or more through “5 mm sieve”. Fine aggregate for concrete shall conform to the requirements of AASHTO M6.

3.4 Coarse Aggregate

In Japan, it is defined as Coarse aggregate that leave more than 85% of its mass on “5mm sieve”. Coarse aggregate for concrete shall conform to the requirements of AASHTO M80.

3.5 Statement of Water-containing

Statement of Water-containing of aggregate is shown in Figure 3.5-1. Water-containing state of aggregate must be “surface dry state” before mixing. If wet state aggregates are applied for mixing of concrete, quantity of surface water must be adjusted as the volume of water.

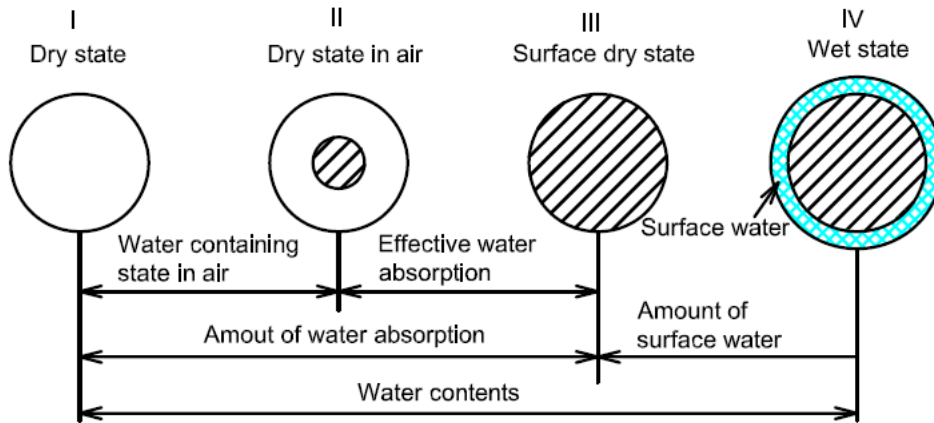

Figure 3.5-1 Water-containing State of Aggregate

Each of the above amounts of water is expressed by the ratio defined as below.

- Water absorption ratio (%) $= \frac{\text{Amount of water absorption}}{\text{The mass of dry state}} \times 100$
- Water contents ratio (%) $= \frac{\text{Water contents}}{\text{The mass of dry state}} \times 100$
- Effective water absorption ratio (%) $= \frac{\text{Effective water absorption}}{\text{The mass of dry state}} \times 100$
- Surface water ratio (%) $= \frac{\text{Amount of surface water}}{\text{The mass of surface dry state}} \times 100$

3.6 Air-Entraining and Chemical Admixtures

Air-entraining admixtures shall conform to the requirements of AASHTO M 154 (ASTM C260).

Chemical admixtures shall conform to the requirements of AASHTO M 194 (ASTM 494/C494M). Unless otherwise specified in the specification, only Type A, Type B, Type D, Type F, or Type G shall be used.

Admixtures containing chloride ion (CL) in excess of one percent by weight (mass) of the admixture shall not be used in reinforced concrete, and in excess of 0.1 percent shall not be used in prestressed concrete.

A Certificate of Compliance signed by the manufacturer of the admixture shall be furnished to the site for each shipment of admixture used in the work. The Certificate shall be based upon laboratory test results from an approved test facility and shall certify that the admixture meets the above specifications.

If more than one admixture is used, documentation demonstrating compatibility of each admixture with all other admixtures and sequence of application to obtain the desired effects shall be prepared at each site.

Air-entraining and chemical admixtures shall be incorporated into concrete mix in a water solution.

Types of chemical admixtures are as follows:

- Type A— Water-reducing
- Type B— Retarding
- Type D— Water-reducing and retarding
- Type F— Water-reducing and high-range
- Type G— Water-reducing, high-range, and retarding

3.7 Mineral Admixtures

Mineral admixtures in concrete shall conform to the following requirements:

- Fly ash pozzolans and calcined natural pozzolans— AASHTO M295 (ASTM C618)
- Ground granulated blast-furnace slag— AASHTO M 302 (ASTM C989)
- Silica fume-AASHTO M307 (ASTM C1240)

Fly ash as produced by plants that utilize the limestone injection process or use compounds of sodium, ammonium, or sulfur, such as soda ash, to control stack emissions shall not be used in concrete.

A Certificate of Compliance, based on test results and signed by a producer of the mineral admixture certifying that the material conforms to the above specifications, shall be furnished for each shipment used in the work.

When special materials other than those identified above are included in a concrete mix design, the properties of those materials shall be determined by methods specified in the contract documents.

Pozzolans (fly ash, silica fume) and slag are used in productions of Class P(HPC) and Class A(HPC) concrete to extend their service life.

Occasionally, it may be appropriate to use other materials; for example, when concretes are modified to obtain very high strength by using special materials, such as:

- Silica fume,
- Cements other than Portland or blended hydraulic cements,
- Proprietary high early strength cements,
- Ground granulated blast-furnace slag, and
- Other types of cementitious and/ or pozzolanic materials.

CHAPTER 4. MIX DESIGN

4.1 Responsibility and Criteria

Site shall design and be responsible for performance of all concrete mixes used in structures. In AASHTO, the selected mix proportions shall produce concrete which has sufficient workability and finish-ability for all intended uses and shall conform to the requirements in Table 2.2-1 and all other requirements of this section.

For normal-weight (-density) concrete, the absolute volume method, such as described in American Concrete Institute Publication 211.1, shall be used to select mix proportions. For Class P (HPC) with fly ash, a method given in American Concrete Institute Publication 211.4 shall be permitted.

Mix designs shall be modified during the course of the work when necessary to ensure compliance with the specified fresh and hardened concrete properties. For Class P(HPC) and Class A(HPC), such modifications shall only be permitted after trial batches to demonstrate that the modified mix design will result in concrete that complies with the specified concrete properties.

Normal-weight (-density) mix design refers to the American Concrete Institute (ACI), Publication 211.1, 1991. Lightweight (low-density) mix design refers to the ACI Publication 211.2, 1998.

For Class P(HPC) with fly ash, the method given in ACI Publication 211.4, 1993, is permitted. In Class P(HPC) and Class A(HPC) concretes, properties other than compressive strength are also important, and the mix design should be based on specified properties rather than only compressive strength.

4.2 Trial Batch (Mix) Tests

Satisfactory performance of the proposed mix design shall be verified by laboratory tests on trial batches (mix). The results of such tests shall be furnished to the responsible engineer by quality control section (DOB) or RRDS, or a manufacturer of precast elements at the time the proposed mix design is submitted.

The average values obtained from trial batches for the specified properties, such as strength, shall exceed design values by a certain amount based on variability. For compressive strength, the required average strength used as a basis for selection of concrete proportions shall be determined in accordance with AASHTO M 241 (ASTM C685/C685M).

4.3 Approval

All mix designs and any modifications thereto shall be approved by the quality control engineer on the site prior to using them. Mix design data provided to the quality control engineer on site for each class of concrete required shall include the name, source, type, and brand of each proposed material and quantity to be used per cubic meter of concrete.

If design mix or material quantities are changed on site, the quality control engineer should carry out re-trial batch (mix) and submit all of data including test result of compressive test to BOD or RRDS.

4.4 Water Content

For calculating the water/cement ratio of mix, the weight (mass) of water shall be that of the total free water in mix which includes mixing water, water in any admixture solutions, and any water in aggregates in excess of that needed to reach a surface-dry condition.

The amount of water used shall not exceed limits listed in Table 2.2-1 as a reference and shall be further reduced as necessary to produce concrete of consistencies listed in Table 4.4-1 at the time of pouring. It is recommended to refer this slump test limits in Myanmar for constructed structures.

Table 4.4-1 Normal-Weight Concrete Slump Test Limits

Type of Work	Nominal Slump, (in)	Maximum Slump, (in)
Formed Elements:		
Sections over 12.0 in. Thick	1-3	5
Sections 12.0 in. Thick or Less	1-4	5
Cast-in-Place Piles and Drilled Shafts Not Vibrated	5-8	9
Concrete Placed under Water	5-8	9
Filling for Riprap	3-7	8

When water-reducing admixtures are used, slump limits in Table 4.4-1 may be exceeded as permitted by responsible engineer.

When consistency of concrete exceeds the nominal slump, the mixture of subsequent batches shall be adjusted to reduce the slump to a value within the nominal range. Batches of concrete with a slump exceeding the specified maximum value shall not be used in the work.

If concrete does not have adequate workability by use of the minimum cement content allowed, the cement and water content shall be increased within the specified water/cement ratio, or an approved admixture shall be used.

4.5 Cement Content

The minimum cement content shall be as listed in Table 2.2-1 or otherwise specified in the specification. For standard classes of concrete, maximum cement or cement plus mineral admixture content shall not exceed 800 lb/yd³ (approx. 474 kg/m³) of concrete. The actual cement content shall be within these limits and shall be sufficient to produce concrete which has the required strength, consistency and performance.

Many high-strength concretes require a cementitious materials content greater than the traditional AASHTO limit of 800 lb/yd³ (approx. 474 kg/m³). However, when cementitious materials contents in excess of 1000.0 lb/yd³ (approx. 592 kg/m³) are required in high-strength concrete, optimization of other constituent materials or alternative constituent materials should be considered.

4.6 Mineral Admixtures

Mineral admixtures shall be used in amounts specified in the specifications. For all classes of concrete, when Types I, II, IV, or V AASHTO M 85 (ASTM C150) cements are used and mineral admixtures are neither specified in the specifications nor prohibited, the responsible engineer will be permitted to replace:

- up to 25 percent of the required Portland cement with fly ash or other pozzolan conforming to AASHTO M295 (ASTM C918),
- up to 50 percent of the required Portland cement with slag conforming to AASHTO M 302 (ASTM C989), or
- up to ten percent of the required Portland cement with silica fume conforming to AASHTO M307 (ASTM C1240).

When any combination of fly ash, slag, and silica fume are used, the responsible engineer will be permitted to replace up to 50 percent of the required Portland cement. However, no more than 25 percent shall be fly ash and no more than ten percent shall be silica fume. The weight (mass) of mineral admixture shall be equal to or greater than the weight (mass) of Portland cement replaced. In calculating water-cementitious materials ratio of mix, the weight (mass) of cementitious materials shall be the sum of the weight (mass) of the Portland cement and the mineral admixtures.

4.7 Air-Entraining and Chemical Admixtures

Air-entraining and chemical admixtures shall be used as specified in the specifications. Otherwise, such admixtures may be used when the quality control engineer permit using them to increase the workability or alter the time of set of the concrete.

CHAPTER 5. CONSTRUCTION PLAN

5.1 Necessity for Construction Plan (Program and Procedure)

In a process of construction of concrete structures, preparation of a construction plan is the first step to be taken for developing construction works.

In setting up a construction plan, it is necessary to stipulate and define procedures, methods, construction period, safety management, economic efficiency as well as environmental effectiveness, etc. based on circumstances and situations of the construction site. The construction plan shall be determined not only by the project manager but also by committed and related engineers and staff. Especially management of concrete works requires to determine at least items of quality control test and, with considerable frequency, plan of purchasing materials, machine & equipment man power, mixing methods, delivery plan, material storage methods, temporary facilities, placement and curing, etc.

The outline of construction plan of entire project is Figure 5.1-1.

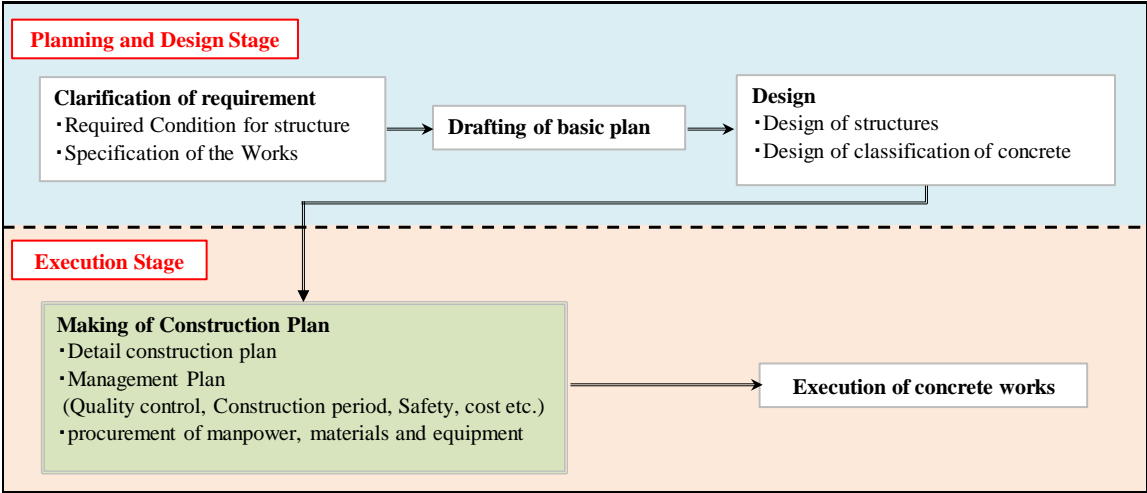

Figure 5.1-1 Outline of Construction Plan in Project

5.2 Determination of Basic Concept

Basic concept of the Project shall be determined based on the result of data collection or through conducting proper survey prior to set-up of the final construction plan. The data for the weather conditions around the site, river water level, geological/topographical conditions, positional relations (rural or residential areas or important facilities nearby) are required to be collected by performing the accurate survey. This is because the above-mentioned information on the construction circumstances will strongly and directly affect cost, period, quality and safety of the construction works. Each of the site situations has its own different features. These data and specific information on the site (if there are) shall be precisely reflected to the fixing job for construction plan. The basic data and information which need to be secured or surveyed are about the items as follows;

Checking the natural and geological/ geographical/ topographical conditions.

Weather Conditions

Monthly or daily temperature, amount of rainfall, wind speed, seasonal water level of river, and other specific natural conditions in the area shall be collected.

Geographical and Topographical Conditions

Geotechnical and topographical features around the site and access to the site for transportation of materials, machine & equipment, etc. shall be fully examined and investigated.

5.2.1. Employment Conditions

Condition of Manpower Arrangement

First of all, the site Engineers shall make a basic plan for manpower schedules such as necessary types of personnel, numbers, time and duration on the basis of work categories, project outline, scale and construction period of the project. In accordance with these judgement items, employment condition of manpower such as ordinary workers or labors and skilled workers shall be confirmed.

If the skilled workers are not available and fall short of requirements around the site, employment arrangement plan for the skilled workers shall be rescheduled and started from scratch.

5.2.2. Condition for Construction Machine & Equipment

Condition of Procurement of Construction Machine & Equipment

The site engineers also need to make a basic plan for supply of construction machines & equipment in the same manner as in the manpower scheduling. Based on results of checking all the matters like availability of appropriate construction machines & equipment and plants around the site, their available numbers, etc. shall be definitely confirmed. If things around the site turn out that necessary machines & equipment cannot be procured eventually, the original procurement arrangement plan shall be reviewed and reconsidered to seek for another alternative and best procurement sources including location.

5.2.3. Condition of Temporary Facilities

Area of temporary yard, location and layout of construction offices and accommodation for staff or workers shall be reviewed and determined. The layout drawing shall be provided accordingly.

Procurement plan for temporary materials for each work such as formwork, timbers, falsework, scaffolding shall be made up. Since detailed information on items such as specifications, types, numbers. depend entirely upon upcoming detailed studies and considerations, the site engineer shall start arrangement soon after the commencement notice of the project in accordance with construction orders.

5.2.4. Others

Environmental Condition

The prevention or mitigation of negative impact to the environmental and social conditions against the nature and the residents such as vibration, noise, pollution of atmosphere, underground water and river water, etc. shall be carefully analyzed so that any possible and sustainable countermeasures can be

created. Appropriate and proper disposal method of construction by-product like surplus soil and debris of concrete shall be demonstrated and determined.

Applicable Laws or Instructions

Construction plan needs to follow the Laws or Instructions to be applicable in Myanmar.

Safety Management

Safety management and organization shall be considered, although this part item is referred to in Safety Control in the Manual. It is recommended that setting out the concrete safety target monthly or annually when the safety management plan is made.

Above mentioned data and information will directly affect the management of entire construction period, quality control, safety and cost effectiveness of the Project.

5.3 Items to be described in Construction Plan

Construction plan for concrete structures shall include at least the following items. The contents described below shall be totally common to all and understood by everybody including other different engineers in the site.

5.3.1. Construction Overview (Outline)

Structure type, shape, dimension, construction place, summary of quantities and time of construction shall be described.

5.3.2. Requirement Condition

Applicable specifications, strength of concrete for each structure, project cost and items against social and environmental conditions, etc. shall be indicated. The tolerance of each concrete structure shall be reviewed and determined.

5.3.3. Construction Period (Schedule)

Entire period of a project, milestones, construction timing for each structure shall be specified. Throughout the scheduling process, all the necessary items such as the procurement conditions, reusing of materials and machinery & equipment, weather conditions, and other influential conditions to the construction schedule shall be fully considered.

It is desirable to stipulate the critical path in the construction period or schedule.

5.3.4. Estimation for Quantities of Concrete Material and Methodology for Procurement of Concrete

Estimated quantities and method showing transportations and suppliers plus location of procurement, brand or type of cement, aggregate, admixture, reinforcement material such as steel and reinforcement bar shall be mentioned. It is highly recommended to keep and record the data for receiving and consuming when procurement method is being planned. It is simply because cement is easy to deteriorate due to absorption of water if storage period stays for a long time.

5.3.5. Construction Equipment and Facility Plan, and Manpower Arrangement Plan

(1) Construction Machine & Equipment and Facility Plan

The type and specification, number, capacity or capability, period of use, and other required arrangements of the construction machine & equipment, plant and facilities which need to satisfy the specified requirements shall be well prescribed. It is expected that the arrangement, setting and installation of machine & equipment and facilities shall be planned in consideration of scale of structures, sequence of construction for each structure and construction period. Furthermore, if concrete placing work is discontinued in the course of pouring, it will adversely affect quality of concrete structures. Therefore, setting two arrangement plans is recommended, and setting out the arrangement of facilities and all numbers of machine & equipment shall be precisely stipulated with full consideration into effectiveness, safe and reliable utilization of a temporary yard. A sample of layout of facilities and machine & equipment is indicated in the Appendix 2.

(2) Manpower Arrangement Plan

Manpower arrangement plan shall be made. It is necessary to take account of the skilled workers, foreman and general workers, who are required to be qualified in the field of specific skills such as piling, scaffolding, pre-stressed, excavation, concrete, girder or cross beam erection, re-bar bending or arrangements. The number of workers scheduled in the original plan shall be employed and shall be uniformly kept the same numbers throughout the working period without any big change in its numbers. If the site employs workers directly, the site staffs need to arrange working places and locations for each worker and keep record every day for appropriate management. If the site sublet to sub-contractor some parts of construction works, management of sub-contractor shall need to hold the meetings periodically (daily, weekly and monthly) to control and supervise the manpower management. In the construction plan, the team organization in charge of implementation of works shall be prepared and provided.

5.4 Construction Plan for Concrete Works

In this Manual, a construction plan for concrete works are divided into two categories. One is for Temporary works plan and the other is for Structure works plan.

5.4.1. Temporary Works Plan

Temporary works are the necessary works for constructing the permanent structures, such as cofferdam, falsework, formwork, erection of girders, construction of access road. Appropriate plans for each temporary work item shall be considered based on the site conditions, availability of machine & equipment, etc. The temporary works plan will directly affect construction period, cost, and safety. and will also cause delay, increasing cost, and the things to impair or disrupt safety.

Adequate discussions shall be done frequently with not only the site engineers but also with other engineers who have many experiences and skills of similar works.

5.4.2. Structure Works Plan

Individual implementation plan for all constructed structures in a project shall be put together in the construction plan. However, common items such as concrete works including formworks and falseworks in each structure are combined into one.

Plan of each structure work is shown in other parts of the Manual to be prepared in this Project.

The construction of concrete structures is basically performed in such sequences as stated in (A) preparation works (including rebar works, form works and false works etc.), (B) manufacture of concrete, (C) transportation, (D) pouring (including consolidation), and (E) curing as described below.

The necessary and appropriate management and inspection are required in each stage to assure and confirm the required qualities, and plans of each procedures, management and inspection methods shall be described in the construction plan. The items to be described are as follows.

(1) Preparation Works

Reinforcement bar (Re-bar) work, formwork and falsework are the main preparation works for the construction of concrete structures. These works will greatly affect quality of concrete structures such as strength, durability and appearance.

Therefore, points to be considered for the reinforcement bar work, formwork and falsework are described below as a supplement to preparation work,

(2) Rebar Works

Plans of storage at the site, cut and bending and fabrication works for Re-bar shall be made.

Cut and Bending of Rebar

- Bending and cutting work of Re-bar shall be carried out by appropriate cutting and bending machines. From viewpoint of re-bar bending work, it is required to preclude re-bent treatment at the positions where are once bent because of harming the material. In case of bending temporarily at the joint construction and re-bending afterward to conform to the original designed position later, it is highly recommended that temporary bending shall be carried out with large radius. After heating there with 900-1000 degree Celsius, and if re-bar is heated with 900-1000 degree Celsius, it is preferable not to cool sharply and extremely that specific position.
- On all occasions rebar welding is not allowed basically because it may impair the materials.

Fabrication of Rebar

- Re-bar shall be cleaned before fabrication. Rusts on surface or things like hardened mortar, or the like with detriment to the inherent adhesion shall be taken out completely by wire brush, and so on.
- Re-bar shall be fabricated accurately in accordance with the drawings and specifications. Deviation of installation positions will affect strength and durability of concrete. Standard inspection items, methods and tolerance for fabrication of re-bar are shown in the Table 5.4-1.

Table 5.4-1 Standard Inspection Items, Method and Tolerance of Fabrication of Re-bar

Arrangement of Fabricated Rebar	Method of Inspection	Time and Frequency	Acceptance Criterion
Location and length of joints and the anchors	Measurement by scale	After fabrication or in case of a long time has passed.	To follow drawings of specifications
Covering			Within 0 ± 25 mm against specified value
Effective height			Tolerance: A small value of $\pm 3\%$ or ± 30 mm of design dimension. However, the minimum covering must be secured.
Center spacing			Tolerance: ± 20 mm

- Re-bar shall be fabricated tightly so as not to move when concrete is poured. If fabrication turns unstable, installation of additional steels for fabrication is recommended. The key point of the re-bar fabrication is to tighten re-bars with iron wires which has a diameter of 0.8 mm or more, or with appropriate clips as shown in Figure 5.4-1.

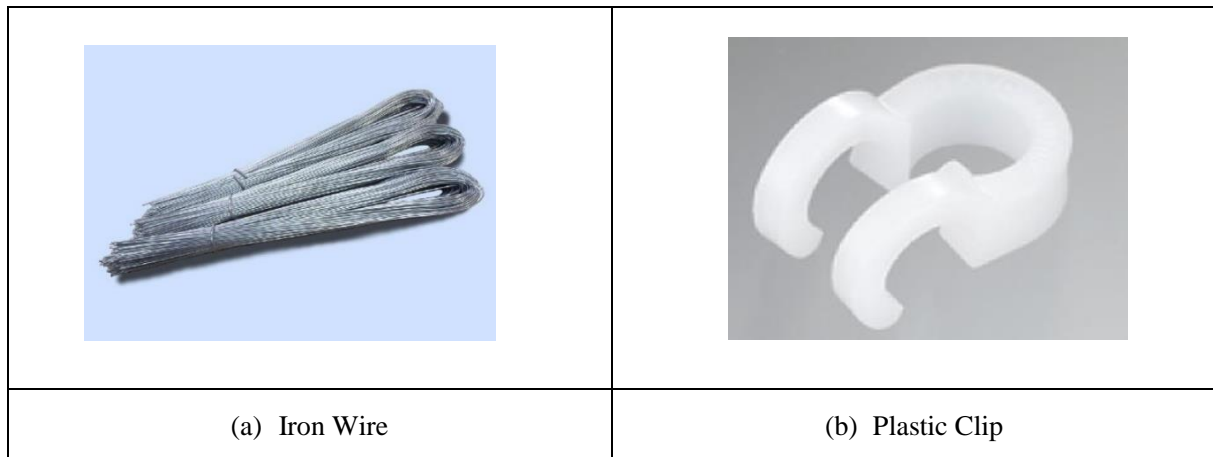

Figure 5.4-1 Iron Wire and Plastic Clip

- The spacers shall be placed in appropriate intervals to keep covering. When selecting and arranging spacers, it is necessary to determine installation points, fixing method of spacers, weights of re-bars, work load, etc. in the course of construction plan for concrete works.
- Commonly used spacers are made of mortar, concrete, steel, plastic, and the like as shown in Figure 5.4-2. It is necessary to select the most suitable spacers based on the site situation.





	
<p>(a) Plastic Spacer for Wall</p>	<p>(b) Plastic Spacer for Soffit</p>
	
<p>(c) Concrete Spacer for Soffit</p>	<p>(d) Mortar Spacer for Soffit</p>

Figure 5.4-2 Common Use of Various Spacers

When using the spacers made of mortar and concrete, it is preferable to use the one with the same quality as in the structural concrete.

With regard to the number of spacers to be installed, the adequate number for beams and slab deck is about 4 pieces per 1m^2 , and for web, wall and column is about 2 to 4 pieces per 1m^2 . For example, if 4 pieces (or 5 pieces) of spacer are installed per 1m^2 , it is advisable to place them alternatively in 50 cm intervals. The image of spacers installation is shown in Figure 5.4-3.

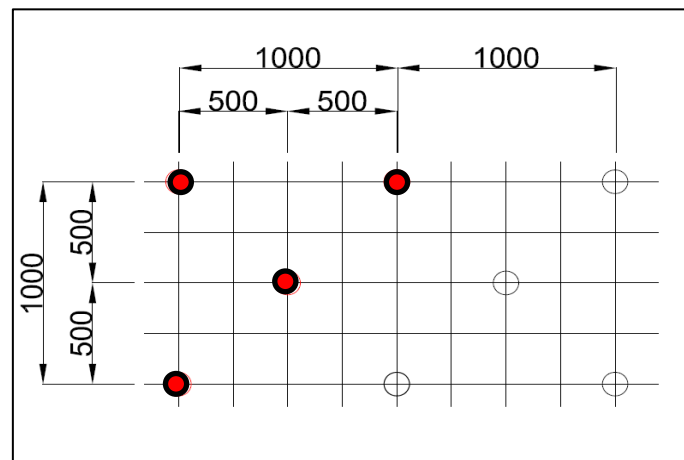

Figure 5.4-3 Image of Spacers Installation

(3) Formwork and Falsework

The formwork and falsework shall be planned and implemented based on shape and dimension of the designed concrete structures. Plan for the formwork and falsework shall be made and stipulated in the construction plan.

Plan and Design

The formwork and falsework shall have adequate strength and rigidity against calculated loads like working load during construction, and shall be designed and planned so that the shape and dimensions of the structure can be kept accurately.

For plan and design of formwork and falsework, the following shall be reviewed and studied.

- Appropriate calculation of operation load (vertical and lateral pressure of concrete and impact load against formwork and working load, etc.)
- Use of the material
- Other points for plan and design (arrangement and calculation method, etc.)

The calculation manual of formwork and falsework is defined in the Appendix 3.

Assembling and Checking

Before assembling forms, setting lines shall be draw on lean concrete or others according to the survey. Additionally, indication of reference lines or offset lines is recommendable for double checking during assembling or upon completion of assembling and during concrete placement.

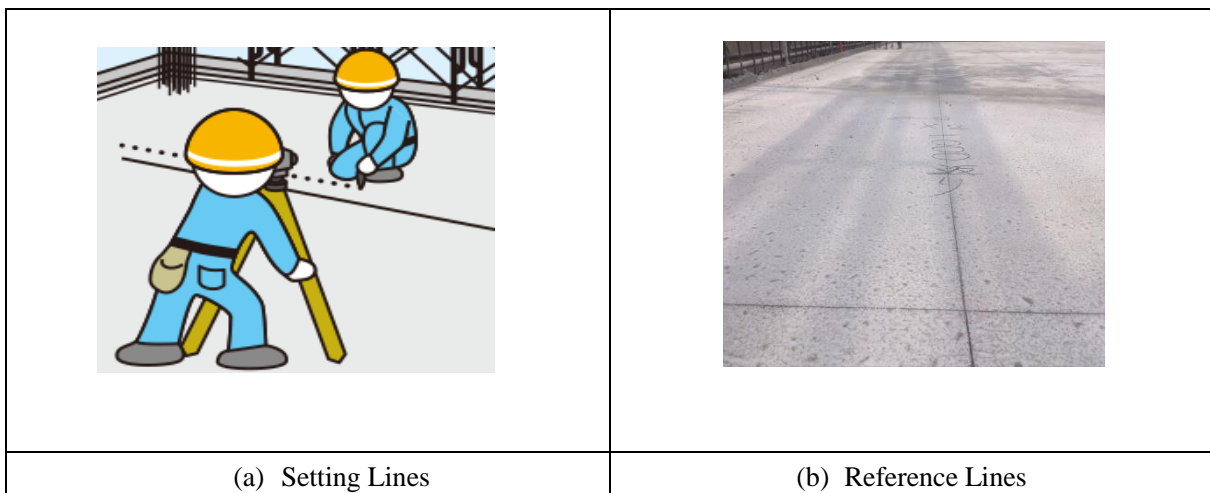

Figure 5.4-4 Reference Lines (Offset Lines) for Assembling and Checking

After completion of assembling, the site engineer shall confirm accuracy of the works, such as horizontal line, vertical alignment, covering to re-bars, fixing conditions, and others.

The assembling of falsework requires vertical accuracy because load operates vertically. It is generally & commonly considered that pipe support (falsework material) strength decreases by 30%, if it is about 3 m height and it wrongly inclines 5 cm horizontally. The final inspection is required for formwork and falsework before pouring concrete as to secure safety during pouring concrete and satisfy the required tolerance of the structures.

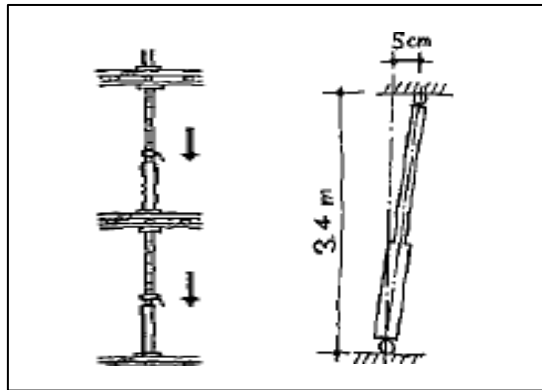

Figure 5.4-5 Vertical accuracy needs to secure safety during concrete placing

(4) Manufacture (Mixing) of Concrete

Manufacturing concrete shall be planned and described. The construction plan shall describe at least the following items.

- Mix design for each strength of constructed concrete
- Brand and types of cement, name and function of admixture, size of coarse aggregate
- Methodology of manufacture of concrete
- Measurement method of each material (cement, aggregates, water, admixture)
- Put the order into the mixer of each material and standard mixing time

In case that fresh concrete is procured from private factories or other construction site, transportation time and their quality control system shall be investigated and checked in advance.

(5) Transporting

Transportation of manufactured concrete shall be planned and described. The construction plan shall describe at least the following items.

- Transportation method
- Route and estimated time for transportation. Transportation time shall be planned to minimize changes in concrete characteristics such as slump, air contents, increasing of temperatures.

(6) Pouring

The items of pouring concrete shall be stated including inspection before pouring. Concrete is required to be planned to pour after completion of inspection of re-bar and formwork and falsework arrangements. The items for pouring concrete to be specified in the construction plan are as follows.

- Items of inspection or checking of the poured portions before pouring
- Arrangement of manpower and equipment
- Area or place is poured by one time
- Sequence of pouring

- Measurement method of fluctuation
- Method of consolidation
- Number, size, capacity of vibrators and consolidation method for vibrators

(7) Curing

Since curing period varies depending on the outside daily average temperature and the types of cement, it is necessary to prepare an appropriate plan for curing.

- Method of curing
- Period of curing for each structure

(8) Quality Control Plan

Quality control is one of the most important management items to ensure the durability of the structure. Quality control plan shall be made for all stages of the construction in order to build economical concrete structures with the required qualities. Moreover, this quality control plan shall be carried out efficiently and systematically. The quality control plan needs to be considered so that concrete material, steel material, equipment, facilities and construction method can be arranged and managed appropriately.

Quality control generally consists of two phases; purchased material control during concrete construction and control after hardening of concrete. It is necessary to carry out both quality control in accordance with the specifications, the contract documents, etc., and to measure with appropriate equipment and by methods such as visual observation and others. Furthermore, since it is assumed that securing the required quality turns out to be not possible, then, it is necessary to prepare in advance other appropriate alternative countermeasures.

However, conducting various tests and taking unnecessary data are not required in the quality control. It is important and preferable to carry out necessary tests with prescribed times. In order to conduct the quality control of concrete, firstly, the required qualities such as strength, durability and water-tightness for the structure shall be classified in advance. In addition, characteristic values that can specifically represent shall be considered. Furthermore, it is important to define the allowable range of the characteristic values and indicate these in the quality control plan. Compressive strength, in particular, is decisive of over-all quality of concrete as well as the basis of structural design. Thus, this is one of the important characteristic values.

(i) Items of Quality Control for Material

- Cement: Density, Degree of weathering
- Mixing water: Chloride contents, Contaminated by organic impurities
- Aggregate: Density, Absorption, Surface moisture, and Grading
- Admixture: Quality Degradation etc.
- Steel material: Rusting

(ii) Items of Quality Control for Manufacturing of Concrete

- Manufacture facilities: Measurement and mixing facilities, etc. (Calibration, etc.)
- Stage of manufacturing: Weight measurement of each material, Mixing method and sequence

(iii) Quality of Concrete

- Fresh concrete: Workability, Slump, Air contents, Temperature, Unit weight
- Water-cement ratio
- Hardening concrete: Compressive strength, Flexural strength, Durability

For products purchased such as steel bars and steel products, it is necessary to confirm and keep the quality certificate. Also checking production in factories or individual tests shall be required.

5.5 Construction Management Plan

Construction management is to ensure whether program, procedures, and methods under construction are being carried out as they are originally planned so that the concrete structure has the required quality and is completed economically in the process. It is recommended to carry out the management plan by using the four steps as illustrated in Figure 5.5-1.

- To clarify quality targets and standardize how to achieve them. (PLAN)
- To implement the work by standardized method. (DO)
- To check if the result is staying within a range of statistical dispersion to organize execution. (CHECK)
- If it is not in the statistical management circumstance, the way to do is to take corrective measures such as changing the method or management plan. (ACTION)

The above four steps management is called PDCA method. It is widely used for construction management works, and is very popular in the quality assurance management.

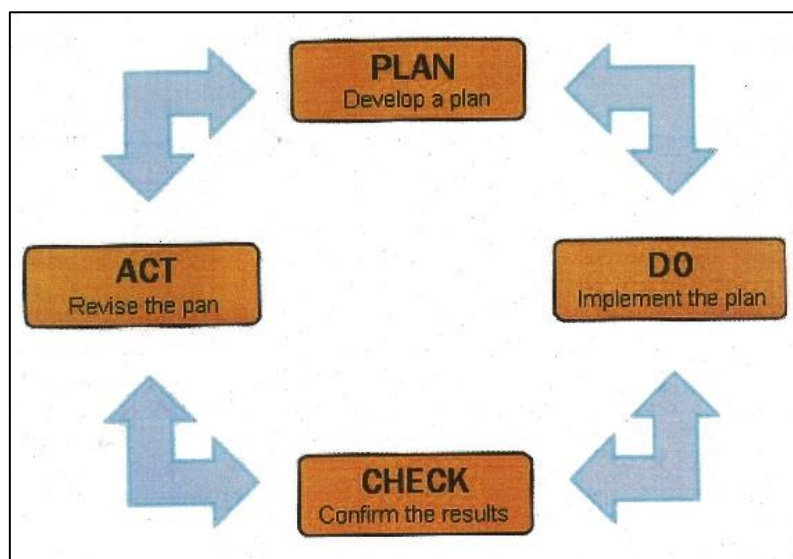

Figure 5.5-1 Cycle of PDCA

In the construction management plan, the management method and organization that can handle the concreting work shall be decided. And also, it is preferable to carry out the management so that the required construction records can be kept and retained.

Management of Concrete works

Items to be reviewed and examined in the concrete management plan for concrete works are as follows.

- Concrete pouring: Pouring method, Consolidation method
- Curing: Temperature, Period, Method
- Removal and dismantle: Timing, Strength of Concrete
- Workmanship: Tolerance for each structure

In the management of concrete works, a management format which can be filled in weather on the day, progress of the work on the day and time, special notes at the time of construction and information on the person in charge of construction and result of quality control tests. This format shall be prepared and recorded by site engineer. If some troubles like cracking and cold joint, etc. occur at the later date, these records will help a lot and be the important data to analyze causes of the troubles. Thus, it is important to prepare the format for recording in detail. This will surely lead to desirable development in having effect of entire construction execution management.

A sample of the management format is shown in the Appendix 4.

5.6 Safety Management Plan

Safety management is also one of the important items in the construction plan.

Safety plan needs to follow laws or relevant restrictions of Myanmar. In the safety management plan, the engineers shall elaborate on safety plan for both the employees at the site and third parties. The safety meeting, tool box meeting, and safety patrol shall be carried out periodically. Dispatching the safety managers on the site is also effective for enhancing safety control, safety development and dynamic safety management scheme.

Since it is assumed that injury accidents may occur at the site, it is also necessary to prearrange how to contact neighboring hospitals and clinics. Contact information shall be available to everyone on the site and shall be shared among all the personnel concerned with the site.

The details of safety management are being referred to the manual to be created in the project.

5.7 Others

In case that the negative impact upon social and environment condition is assessed and assumed, the mitigation counter measurement and monitoring plan shall be established. Special attention shall be paid when concrete works are carried out near rivers and cultivated farm lands or in underground, etc., management of drain is totally required to prevent the water pollution.

At the concrete works in residential or commercial area, it is necessary to mitigate noise, air pollution, congestion of public transportation and others caused by the works.

CHAPTER 6. STORAGE OF MATERIAL

6.1 Storage of Cement

The site shall set up the plan with suitable means for storing and protecting cement against dampness. Cement bags with partial set cement for any reason or with lumps of caked cement shall be rejected. Cement kept in storage over two months if bagged or six months if bulk, and cement which for any reason is damaged and impaired in the opinion of the engineer shall be judged its quality by re-test before using it in the work.

Recommendable Storage House

Storage house shall have adequate floor area to be spacious enough to store the cement quantity for production of concrete in moderate condition with good accessibility and with proper ventilation windows. Preferably the floor shall be made by concrete. If wooden floor is designed, the storage house shall be built at a comfortable and dry location. The floorboards of the house shall be placed without any single gap. Moreover, it is advisable to prepare and leave a space of 20 cm or more between the surface of the ground and the floor level.

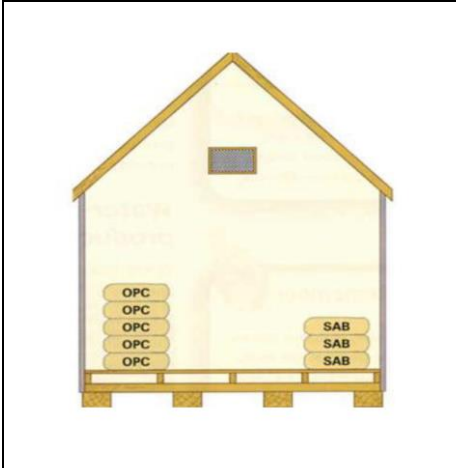

Figure 6.1-1 Recommendable Plan for Cement Storage House

6.1.1. Consideration of Storage

In storage of cement in the house, the whole storage house shall inevitably need to complete achieving the efficient balanced ventilation in accordance with the in-house environment and proper ventilation air volume. The storage house shall totally avoid degradation in a ventilated atmosphere thereof. It is essentially required to manage in a decent manner to preclude excessive ventilation volume so as to prevent over-aeration by way of classifying both by type and by delivery date.

Cement shall not be put on the floor directly. When putting the cement directly on the floor, it is required to raise about 30 cm above the ground that is the adequate height for storage. In the store house, piling up the cement bags is limited to about 10 bags maximum. The cement bags shall



Figure 6.1-2 Recommendable Plan for Storage of Cement Bags

be stored preferably covered by water proof sheet. When they are used for concrete production, it is advisable to use in the order of delivery date. The storage quantity is recommendable to turn out to be more than three times of consuming quantities per day.

6.1.2. Items for Record

Items to be recorded for cement are as follows;

- Delivery date, quantity and name of supplier
- Brand and Type of cement
- Unloading location
- Date of use

Records shall be furnished to the site engineer by the storekeeper. The storekeeper shall keep record every day such details as the site engineer may reasonably require and the quantity used during the day whenever the concrete is placed.

6.2 Storage of Aggregates and Sand

In terms of handling and storage of concrete aggregates and sand, the major concern shall be about how to prevent segregation or contamination with foreign materials. The method to be applied shall be provided with adequate drainage so that the moisture content of the aggregates and sand are uniform enough at the time of batching. Different sizes of aggregate shall be stored in separate stock piles sufficiently removed from each other to prevent the material at the edges of the piles from getting intermixed.

6.2.1. Recommendable Storage Method and Facilities

As mentioned above, sufficient drainage and aggregate storage size by size shall be reviewed and considered.

Following that, the recommendable plan for stock method and facility plan is indicated in the Figure 6.2-1 below. Moreover, when it comes to increase moisture contents of aggregates due to raining, the installation of roof or covering by water proof sheet, etc. is recommended.

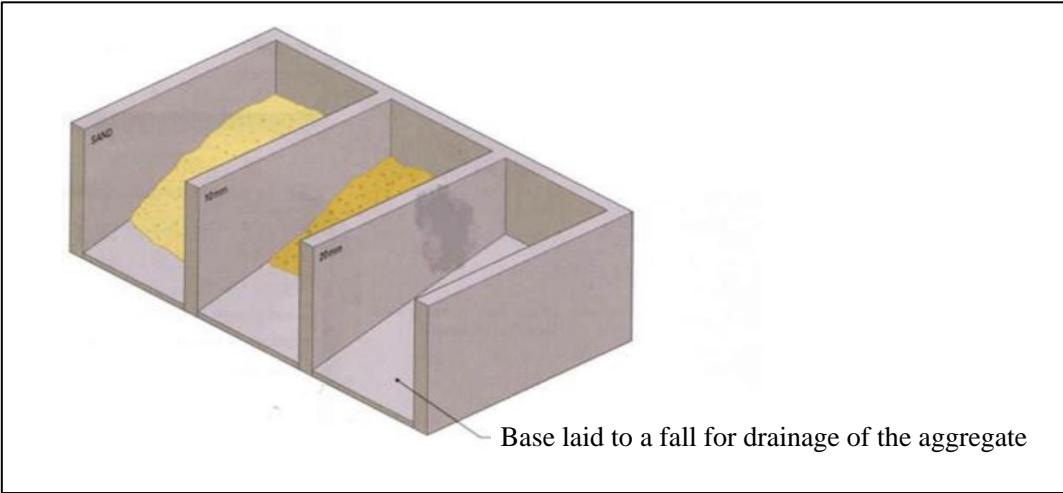

Figure 6.2-1 Recommendable Storage Method and Facilities for Sand and Aggregates

6.2.2. Items for Record

Activities for purchase and delivery shall be recorded to manage and monitor the concrete works. Stock piling quantities shall be reviewed and examined for smooth concreting works.

6.3 Water

Adequate amount of water for concrete production shall be stored in moderate proportion to the volume of daily production every day when concrete is poured.

6.3.1. Recommendable Storage Method and Facilities

Water is procured mostly from river or wells in the construction site in rural area. Normally water is collected and stored in the steel drums, tanks, and so on. The storage method for water shall be examined in view of storage capacity, prevention of mixture of harmful substances that degrade quality, and the like. Especially, it is pointed out that method of water supply shall be stable and sustainable. When the electric pumps are used for supplying water, the additional pumps and tubes shall need to be prepared in case of emergency.

If storage tanks of drum made of steel are planned, using a type with rust prevention treatment is preferable.

6.3.2. Items for Record

Water quality has to be tested when construction plan is set up. However, considering that the quality changes with the lapse of time, it is advisable to confirm the quality on the day before concrete placing. For test items such as chloride contents and PH are recommended to be tested and recorded. When the site plan to use the raw water other than treated or tap water, the required applicable specification is stipulated in the following Table 6.3-1.

Table 6.3-1 Required Quality in case of using the Water other than Treated (Tap) Water

Items	Required Quality
Suspended Solid	Less than 2g/l
Chloride Contents	200 ppm
PH	5.8 ~ 8.6

6.4 Admixture

6.4.1. Recommendable Storage Method

It is desirable to keep indoors. This will bring about no change in quality, no mixing of rain water, and no contamination with foreign materials. It is preferable to make sure to mix thoroughly before using it to prevent the admixture from being precipitated.

6.4.2. Items for Record

The site engineer shall request the supplier to submit the quality certificates and shall keep those certificates to develop storage management.

6.5 Reinforcement Bar (Rebar)

Re-bar is the main material of reinforced concrete and it will greatly affect the strength and durability of concrete. The strength of the reinforced concrete is achieved by full and proper integration of re-bar adhesion with concrete adherent characteristic. Therefore, it shall be prevented from getting mixed with substances that reduce adhesion to the concrete.

6.5.1. Recommendable Storage Method and Facilities

Re-bar shall not be stored on the ground directly and the sleepers shall be placed between ground level and stored re-bar. When placed on the untreated ground, even if the sleepers are put on the ground, the ground may subside and the re-bar may touch the ground. It is, thus, important that existing irregularities on the surface of the ground is leveled out well by crushed stone, and gravel or concrete. Moreover, it is desirable to bind up the sleeper either in one bundle or in a certain quantity of the same size in order to easier and more comfortable handling. It is recommended to cover with a waterproof sheet to preclude the occurrence of rust.

Recommendable storage method is shown in Figure 6.5-1.

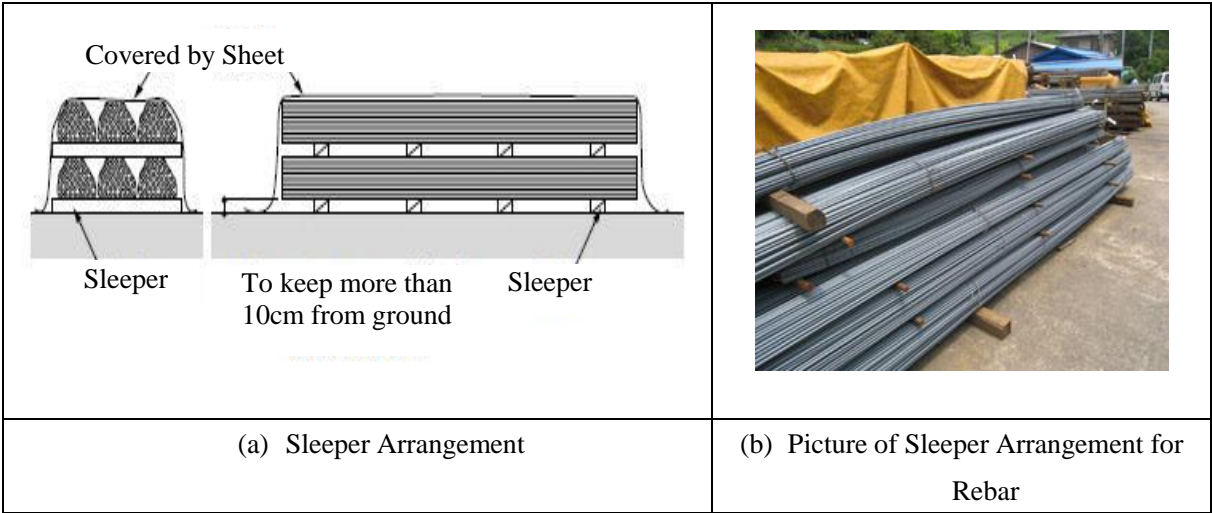

Figure 6.5-1 Recommended Storage Method and Facilities for Rebar

6.5.2. Items for record

The site Engineer shall request the supplier to submit the quality certificates and shall keep those certificates.

6.5.3. Others

It is recommended to conduct the individual and own quality tests for a certain quantity of re-bar such as tensile strength test and bending strength test.

6.6 Formwork Material

Storage of formwork material is for temporary works; however, this will affect finishing of concrete. The formwork material is commonly reused several times, so it is necessary to store appropriately to keep in good conditions. This is as important as cost saving matter.

6.6.1. Recommendable Storage Method and Facilities

Storage method is mostly the same as re-bar storage method. Formwork material shall not be put on the untreated ground directly. The sleepers shall be installed between ground surface and formwork material in the way prescribed on the Figure 6.6-1 as under.

As soon as forms are removed from constructed structures, immediate cleaning, repairing damaged portions and members, and applying form oil shall be carried out. Damaged and deformed formwork materials will influence directly not only on quality of form of concrete but also safety during concrete pouring. Therefore, in principle, formwork materials with damage and deformation that cannot be repaired shall not be reused eventually.



Figure 6.6-1 Recommended Storage Method and Facilities for Formwork Materials

6.6.2. Items for Record

Basically, recording of formwork material is not required. But it is recommended to keep the record of the times of reuse of each formwork material.

CHAPTER 7. PRODUCTION AND PROCUREMENT OF CONCRETE

7.1 Concrete Production Facilities

7.1.1. Production Facility (General)

Most of materials for concrete production is measured in a batching plant. The mass proportions are handled in a batch, and mixing is carried out by a batch mixer.

A batching plant is composed of material storage bin, material measuring facility and mixing facility. Structure of a batching plant is in Figure 7.1-1.

7.1.2. Weighing

The measurement of each material is the most important process and part for production of concrete. Materials shall be measured by weighing, except as otherwise shown in the specification of the design documents or where other methods are specifically authorized. The apparatus and device provided for weighing aggregates and cement shall be suitably designed and constructed for

this purpose. Each size of aggregate and the cement shall be weighed separately. Cement in standard packages need not to be weighed but bulk cement shall be weighed. The accuracy of all weighing devices shall be such that successive quantities can be measured to remain within one percent of the desired and designed amount.

The required tolerance of each material specified in JIS A 5308 is defined in Table 7.1-1.

The size of the batch shall not exceed the mixer capacity guarantee by the manufacturer. The measured materials shall be batched and charged into the mixer by means to avoid loss of any materials due to effect of wind or other factors and causes.

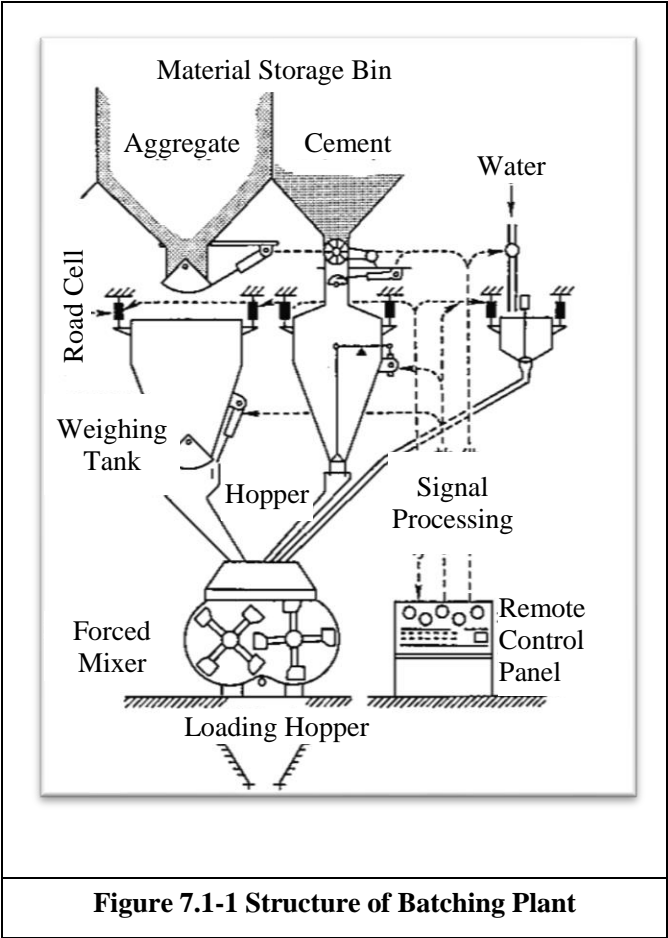

Figure 7.1-1 Structure of Batching Plant

Table 7.1-1 Measurement Tolerance of Quantity in One Batch (%)

Material	Tolerance
Cement	±1
Aggregate	±3
Water	±1
Admixture	±3

7.1.3. Mixing Facility

In most cases of mixing concrete, mixers are commonly used. Batch types of mixers is roughly classified as in Figure 7.1-2.

Structure of tilting type mixer, forced mixing type (pan type) and forced mixing type (Horizontal Two-axial Type) are shown in Figure 7.1-3, Figure 7.1-4, Figure 7.1-5 respectively.

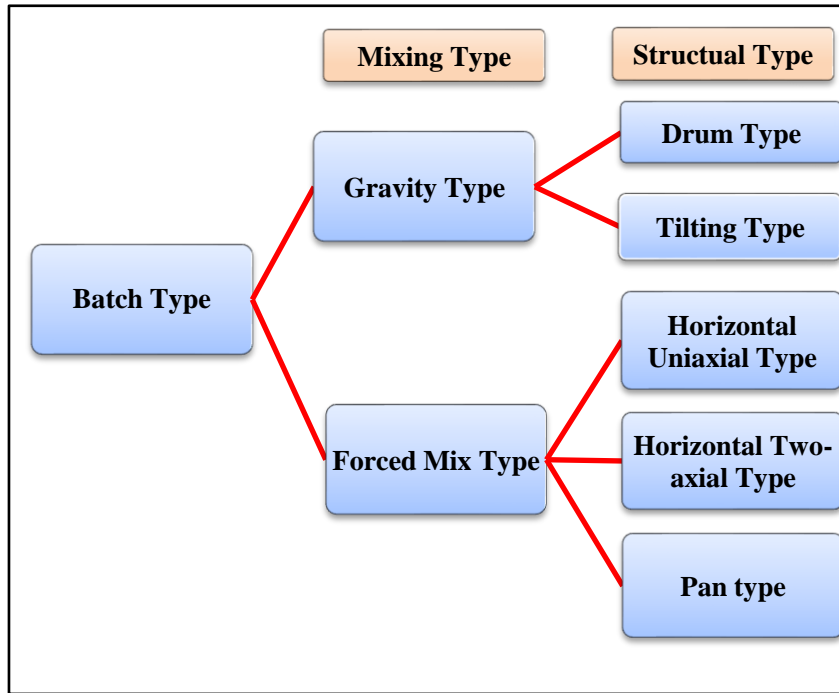

Figure 7.1-2 Typical Batch Type of Mixers

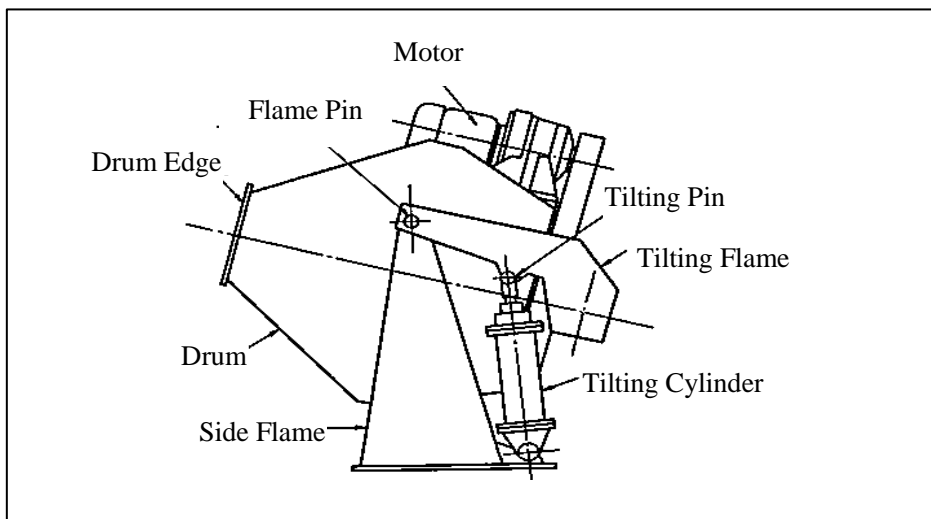

Figure 7.1-3 Structure of Tilting Type Mixer

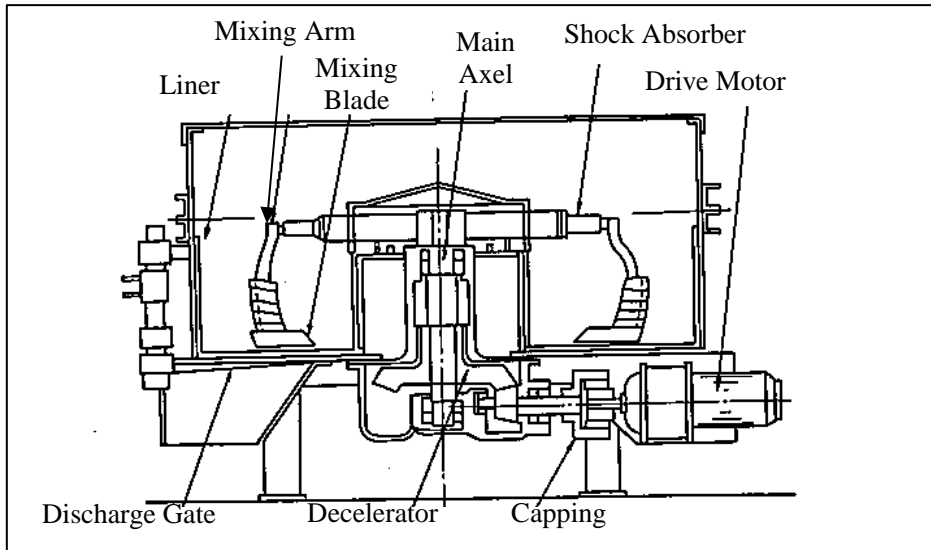

Figure 7.1-4 Structure of Forced Mixing Type (Pan Type)

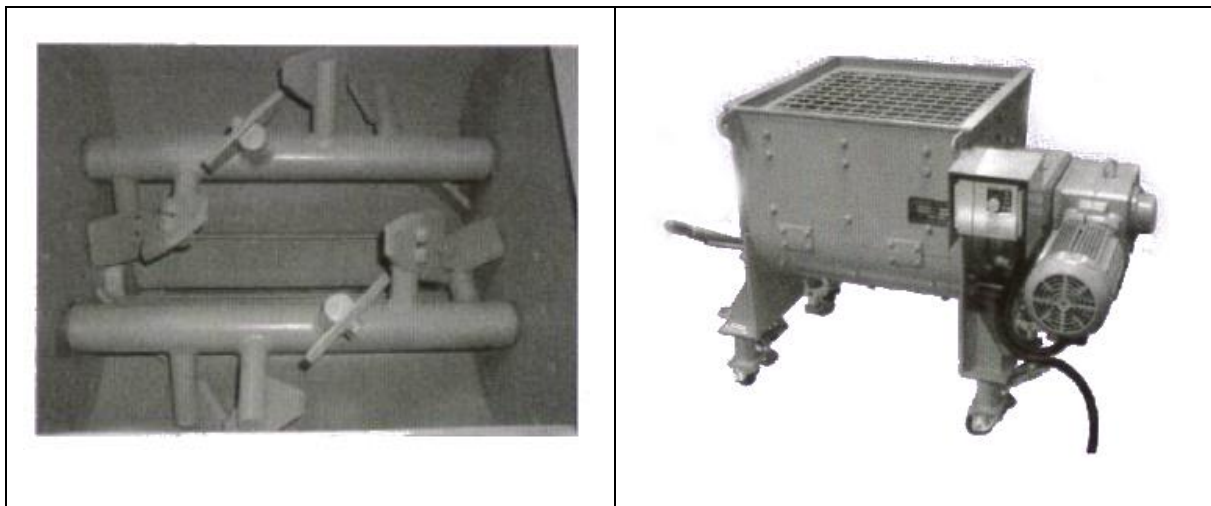

Figure 7.1-5 Structure of Forced Mixing Type (Horizontal Two-Axial Type)

Mixing performance shall be tested and evaluated in accordance with JIS A 1111, “Test method for difference in mortar and aggregate content in mixed concrete with a mixer”.

In Japan concrete quality is regulated to be put to the tests like the compression test, air contents test and slump test that are all prescribed in JIS A 8603, “Concrete mixer”.

Tolerance specified in JIS A 8603 is shown in Table 7.1-2.

Table 7.1-2 Mixing Performance of Batch Type Mixer

Items		Mixing Concrete Quantities	
		In case of Nominal Capacity	In case of 1/2 of Nominal Capacity
Difference unit mass with volumetric of mortar in concrete		Less than 0.8%	Less than 0.8%
Difference unit quantity of aggregates in concrete		Less than 5%	Less than 5%
Difference	Compressive strength	Less than 7.5%	-
	Air contents	Less than 10%	-
	Slump	Less than 15%	-

*Coefficient of deviation calculates by below equation.

$$\frac{((X_1 - X_2))}{((X_1 + X_2))} \times 100\%$$

X₁: Amount of material obtained from sample 1 or sample 2. In case of slump or compressive strength is applied the larger of each value

X₂: Amount of material obtained from sample 1 or sample 2. For slump or compressive strength is applied the smaller of each value

7.2 Management of Production Facilities, Batching and Mixing

7.2.1. Production Facilities

Operating performance of all production facilities shall be checked and calibrated before starting the concrete works. These records also shall be made in advance and kept for appropriate period.

Especially, weight measurement apparatus needs periodical calibration because weight of each concrete material greatly influences to concrete strength. Generally, calibration of these are carried out by using the standard metal weight. The recommendable frequency of calibration for apparatus equipped with batching plant should be once for before or after assembling of batching plant and after that approx. once a year. The calibration of portable scales should be recommended to be carried out before starting concrete works and after that approx. once per 6 months. If fresh concrete is purchased from supplier, those calibration evidence should be confirmed.

7.2.2. Batching

The size of the batch shall not exceed the mixer capacity guaranteed by the manufacturer or as determined in accordance with the standard requirements specified capability of plants or mixers. The measured materials shall be hatched and charged into the mixer by means that will prevent loss of any materials due to effects of wind or other causes.

7.2.3. Mixing

Important points during mixing are as follows.

- 1) Materials of concrete must be thoroughly mixed until the mixed concrete is uniform quality.
- 2) The sequence of materials charging into the mixer should be considered in advance. Generally, 1. certain quantity of water (half or 2/3 of total quantity) is charged into the mixer, 2. other materials are charged into there at the same time, 3. After charging other materials, 4. remaining water should be charged.
- 3) In principal mixing time is decided based on test results on the site. In case the tests are not conducted, standard minimum mixing time for tilting type mixer is 90 seconds and for forced type mixer is 60 seconds as specified in JIS 1119. Also, in this specification, maximum mixing time is not more than 3 times of adapted mixing time on the site.
- 4) In AASHTO, when mixer performance tests as described in AASHTO M157 are not conducted, the required mixing time for stationary mixers shall not be less than 90 seconds and not more than 5 minutes.
- 5) The first batch of concrete materials placed in the mixer shall contain a sufficient excess of cement, sand, and water to coat inside of the drum without reducing the required mortar content of the mix.
- 6) The concrete shall be mixed only in the quantity required for immediate use. Mixing shall be sufficient to thoroughly intermingle all mix ingredients into a uniform mixture. Concrete that has developed an initial set shall not be used. Re-tempering concrete shall not be permitted.
- 7) Materials for next batch shall not be charged into the mixer before discharging last mixing concrete.
- 8) For small quantities of concrete needed in emergencies or for small noncritical elements of the work, concrete may be hand-mixed using methods approved by the Engineer.
- 9) Regarding mixing under Hot Weather Concrete (Average daytime temperature is more than 25°C), following points should be considered in addition to above mentioned 1~ 7).
 - (a) Each material of concrete must be used at low temperature as possible.
 - (b) Generally, temperature of mixed concrete should be managed for lower than 30°C and temperature of concrete during pouring is lower than 35°C. The temperature to be lowered for each material required to lower the concrete temperature by 1°C is shown in Table 7.2-1.

Table 7.2-1 The temperature to be lowered for each material required to lower the concrete temperature by 1°C

Material	Required Temperature
Cement	8°C
Aggregate	2°C
Water	4°C

7.3 Procurement from Private Supplier

7.3.1. Arrangement of Specification of Concrete and Selection of Supplier

In case of fresh concrete must be purchased from private supplier, firstly site engineer should set the specifications mentioned in below. In the selection of suppliers, site engineer must consult with candidate suppliers fully considering availability of requested fresh concrete, transportation routes and transportation time, and the quality control situation of their plants.

- 1) Types of cement
- 2) Quality and size of aggregate
- 3) Carry out test of alkali-silica reaction
- 4) Types of admixture
- 5) Required chloride contents
- 6) Required compressive strength
- 7) Required air contents
- 8) Required maximum concrete temperature at the delivered-on site
- 9) Upper limit of water-cement ratio
- 10) Upper limit of unit water content
- 11) Upper and lower limit of unit cement content
- 12) Other necessary items

7.3.2. Points during Concrete Pouring

Concrete plants are generally quite far from the site. Therefore, to carry out concrete works smoothly, the plant is thoroughly arranged with the construction plan in advance. During concrete pouring, site engineer should communicate and discuss with the plant about the site situation and delivery which is made according to the site situation.

7.4 Sampling and Testing

Compliance with the requirements in this Section shall be determined in accordance with the following standard methods of AASHTO, ASTM or equivalent standard such as JIS.

- (1) Sampling Fresh Concrete, AASHTO T 141(ASTM C172), JIS A5308
- (2) Weight per Cubic Foot, Yield, and Air Content (Gravimetric) of Concrete, AASHTO T 121(ASTM CI38/C138M)
- (3) Slump of Portland Cement Concrete, AASHTO T 119 (ASTM CI43/C143M), JIS A1101, JIS A5308 9.3
- (4) Air Content of Freshly Mixed Concrete by the Pressure Method, AASHTO T 152 (ASTM C231), JIS A1118, JIS A1128, JIS A5308 9.3
- (5) Making and Curing Concrete Test Specimens in the Laboratory, ASTM C192/C192M)

- (6) Making and Curing Concrete Test Specimens in the Field., AASHTO T 23 (ASTM C31/C31 M)
- (7) Compressive Strength of Cylindrical Concrete Specimens, AASHTO T 22 (ASTM C39/C39M)
- (8) Chloride Contents Test, JIS5308 8.6

Frequency and tolerance of tests conducted at the site specified by JIS as the samples are shown in Table 7.4-1.

Table 7.4-1 Frequency and Tolerance of Tests conducted at the Site specified by JIS

Test	Frequency	Tolerance
Slump	As general, once per 150m ³	In case of design slump is <ul style="list-style-type: none"> • Less than 5cm : ± 1.0cm • Exceeding 5cm to less than 8cm : ± 1.5cm • Exceeding 8cm to less than 18cm : ± 2.5cm • Exceeding 18cm : ± 1.5cm
Air contents	Ditto	4.5% ± 1.5% for Portland cement concrete
Chloride Contents	Decided on site	In principal, 0.3kg/m ³ for reinforcement concrete, it is not prescribed in the plain concrete.

First specimen should be taken from first delivered or mixed fresh concrete and slump, air contents and chloride contents tests should be conducted at least with first three delivered or mixed fresh concrete.

For the chloride contents, it is recommended to test by the “Quantab” which can be easily measured. The manual and a sample of recording sheet for this test are attached in Appendix 5.

7.5 Evaluation of Concrete Strength

7.5.1. Tests

The strength test shall consist of the average strength of at least two 6.0×12.0-in, or at least three 4.0×8.0-in. Compressive strength test specimens (cylinders) fabricated from material taken from a single randomly selected batch of concrete, except that, if any specimen should show evidence of improper sampling, molding, or testing, said cylinder shall be discarded and the strength test shall consist of the strength of the remaining specimen(s). A minimum of three cylinders shall be fabricated for each strength test when the specified strength exceeds 5.0 ksi (Approx.35 MPa).

7.5.2. For Controlling Construction Operations

For determining adequacy of cure and protection and for determining when loads or stresses can be applied to concrete structures, test specimens shall be cured at the structure site under conditions that are not more favorable than the most unfavorable conditions for the portions of the structure which they represent as described in AASHTO T23 (ASTM C31/ C31M), Article 9.4. Sufficient test

specimens shall be made and tested at the appropriate ages to determine when operations such as release of falsework, application of pre-stressing forces, or placing the structure in service can occur.

7.5.3. For Acceptance of Concrete

For determining compliance of concrete with a specified strength, test specimens shall be cured under controlled conditions as described in Article 9.3 of AASHTO T23 (ASTM C31/ C31 M) and tested at the specified age. Samples for acceptance tests for each class of concrete shall be taken not less than once a day nor less than once for each 150.0 yd³ (Approx.115m³) (In JIS once for each 150m³) of concrete, or once for each major pouring.

Any concrete represented by a test that indicates a strength that is less than the specified compressive strength at the specified age by more than 0.500 ksi (3.44 MPa) will be rejected and shall be removed and replaced with acceptable concrete.

- The site engineer considers and decides evidence of a type acceptable that the strength and quality of the rejected concrete is acceptable. If such evidence consists of cores taken from the work, the cores shall be obtained and tested in accordance with the standard methods of AASHTO T 24M/T 24 (ASTM C42/C42M).

The concrete age when the specified strength is to be achieved must be shown in the contract documents.

In JIS A 5308, three specimens must be taken for each sampling in spite of design concrete compressive strength. Acceptable compressive strength are as follows;

- 1) Test result of one specimen must be more than 85% of design compressive strength
- 2) Average of compressive strength for three specimens must be design compressive strength

Site engineer should determine the number of specimens and acceptance of test result considering the above mentioned both specifications (ASTM or equivalent one).

Evaluation of Compressive Strength for Cube Type Specimen

Above mentioned specification follows the case that cylinder type specimen are applied.

Compressive strength of cube type specimen is indicated larger than cylinder type specimen. Thus, if you applied cube type specimen, you might adjust value of compressive strength for evaluation.

The convert formula of coefficient from cube type to cylinder type introduced by L'Hermite is mentioned in below as reference.

$$0.76 + 0.2\log(\sigma_{cu} / 19.58)$$

σ_{cu} : Compressive strength of cube type specimen

The case of example applying JIS mentioned in below.

Table 7.5-1 Design Compressive Strength is 24 MPa

Result of Compressive Strength (28days) <Cube Type>	Coefficient Value for Conversion	Estimated Compressive Strength of Cylinder Type	Evaluation
No.1: 32.3 MPa	0.78	25.2 MPa	More than 85% of design Strength: OK
No.2: 31.5 MPa	0.78	24.6 MPa	More than 85% of design Strength: OK
No.3: 28.8 MPa	0.78	22.5 MPa	More than 85% of design Strength: OK
		Average: 24.1 MPa	Average is more than design Strength OK

7.5.4. For Control of Mix Design (Re-trial mix)

Whenever the average of three consecutive tests, which were made to determine acceptability of concrete, falls to less than 0.150 ksi (1.0 MPa) against the specified strength, or any single test falls more than 0.200 ksi (1.4 MPa) below the specified strength, the site shall make corrective changes in the materials, mix proportions, or concrete manufacturing procedures before placing additional concrete of that class. Such changes shall be approved by the qualified engineer. In case of the site plans to procure the fresh concrete from private plant, above mentioned execution should be carried out by supplier at the supplier's expense.

7.5.5. Precast Concrete cured by the Waterproof Cover Method, Steam, or Radiant Heat

When a precast concrete member is cured by the waterproof cover method, steam, or radiant heat, the compressive strength test specimens made for the above purposes shall be cured under conditions similar to the member. Such concrete shall be considered to be acceptable whenever a test indicates that the concrete has reached the specified compressive strength provided such strength is reached no later than the specified age for the compressive strength.

- 1) For concrete with specified design compressive strength less than or equal to 6.0 ksi (approx..41MPa), test specimens shall be stored next to the member and under the same covers to exposed them the same temperature conditions as the member.
- 2) For all specified concrete strengths, test specimens shall be match-cured in chambers in which the temperature of the chamber is correlated with the temperature in the member prior to release of the pre-stressing strands.

CHAPTER 8. TRANSPORTATION AND HANDLING

Immediately after the cement comes in contact with water, hydration reaction starts in fresh concrete, and the reaction rate increases as time passes. In 2 to 3 hours after mixing, the slump decreases as timekeeping change and the fluidity is lost, and the hardening reaction starts from 4 to 5 hours after mixing. Therefore, in order to make the highly durable concrete structure, it is necessary to finish each work such as transporting, pouring, consolidation, finishing etc. in a short time from the start of mixing to before the slump loss becomes outstanding in accordance with proper pouring plan in the construction plan.

8.1 Transportation (Delivery)

The organization supplying concrete shall have sufficient plant capacity and transporting apparatus to ensure continuous delivery at the rate required. The delivery rate of concrete during pouring operations shall be such as to provide for proper handling, placing, and finishing of the concrete. The rate shall be such that the interval between batches shall not exceed 20 min and shall be sufficient to prevent joints within a monolithic pour caused by pouring fresh concrete against concrete in which initial set has occurred. The methods of delivering and handling the concrete shall be determined to facilitate pouring with minimum re-handling and without damage to the structure or the concrete.

Further in JIS 5308, time from starting of mixing to unloading of fresh concrete must be within 1.5 hours.

8.1.1. Selection and Consideration of Transportation Method

Transportation method should be planned based on above mentioned conditions on site.

Transportation is mainly divided into from plant to site and from unloading point to pouring point in site. Site engineer should select appropriate both transportation method according to site situation.

Table 8.1-1 Transportation Method

Transportation Method	Points	
	To Segregation	To Changing of Quality
Agitator Truck	<ul style="list-style-type: none"> ● Agitating with high Speed before unloading ● Confirmation of wearing for stirring blade 	<ul style="list-style-type: none"> ● Mixing of washing water ● Cleaning of residual
Dump Truck	<ul style="list-style-type: none"> ● Consideration of loading and unloading method 	<ul style="list-style-type: none"> ● Protection of rainwater, isolation and wind etc.

8.1.2. Planning of Transportation Route

Site engineer should plan transportation route if fresh concrete is purchased from private supplier or other plants. As stated, that the time from mixing to unloading should be prescribed in this section, the routes that can be transported within the prescribed time should be carefully considered.

Especially, for concrete placement conducted in morning or evening time, it is also necessary to investigate traffic conditions of the candidate routes.

8.1.3. Items for Record

When purchasing fresh concrete from private suppliers or other plants, it is important for quality control to record the shipping time at the plant and unloading time on site.

8.2 Handling

After discharging or unloading fresh concrete should be handled to pouring portion by appropriate method such as concrete bucket, concrete pump and shoot (chute).

8.2.1. Selection and Consideration of Handling Method

The handling method reflecting unloading location in site and the placement position should be planned and selected in advance.

Features of each handling method and points are shown in Table 8.2-1 and Table 8.2-2.

Table 8.2-1 Features of Handling Methods

Handling Method	Direction	Handling Distance	Handling Q'ty (m ³)	Applicable Range
Concrete Bucket	Vertical Horizontal	5 ~ 50m	15 ~ 20/h	General, High Portion
Concrete Pump	Vertical	10 ~ 120m	20 ~ 70/h	General, High Portion, Long Distance
	Horizontal	10 ~ 500m		
Shoot (chute)	Vertical Diagonal	5 ~ 20m	10 ~ 50/h	General
Wheelbarrow	Horizontal	5 ~ 50m	0.05 ~ 0.1/ Number	Small Scale Structures

Table 8.2-2 Points of Handling Methods

Transportation Method	Points	
Concrete Bucket	<ul style="list-style-type: none"> ● Adapting appropriate shape, capacity and discharge slot ● Preventing holding for a long time 	<ul style="list-style-type: none"> ● Pre-cleaning of adhered foreign substances ● Prevention of leaking of mortar
Concrete Pump	<ul style="list-style-type: none"> ● Selection of appropriate specification such as pumping capability ● Making out of Appropriate Plan such as layout of pipes and diameter of pumping 	<ul style="list-style-type: none"> ● Prohibition of charging of additional water ● Prevention of excessive pumping pressure ● Removal of stacking concrete
Shoot (chute)	<ul style="list-style-type: none"> ● Do not apply diagonal shoot (chute) in principle ● Control of falling speed 	—

8.2.2. Each Handling Method

(1) Concrete Bucket

It is a method of carrying concrete in a bucket operated by a crane. Work efficiency is not very good, but segregation during transport is the least and its advantage is easy to handle concrete to the pouring point. The bucket must be designed to open and close easily its discharge portion and there is no leakage of mortar when closed.

(2) Concrete Pump

Concrete pump is mainly divided into two types, one is Piston Type and the other is Squeeze Type. (See Figure 8.2-1 and Figure 8.2-2).

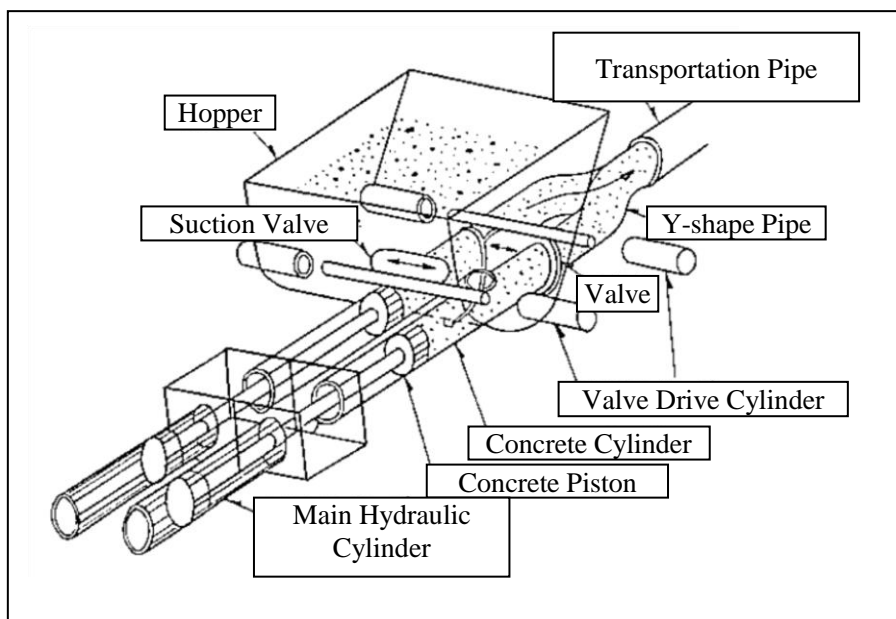

Figure 8.2-1 Piston Type

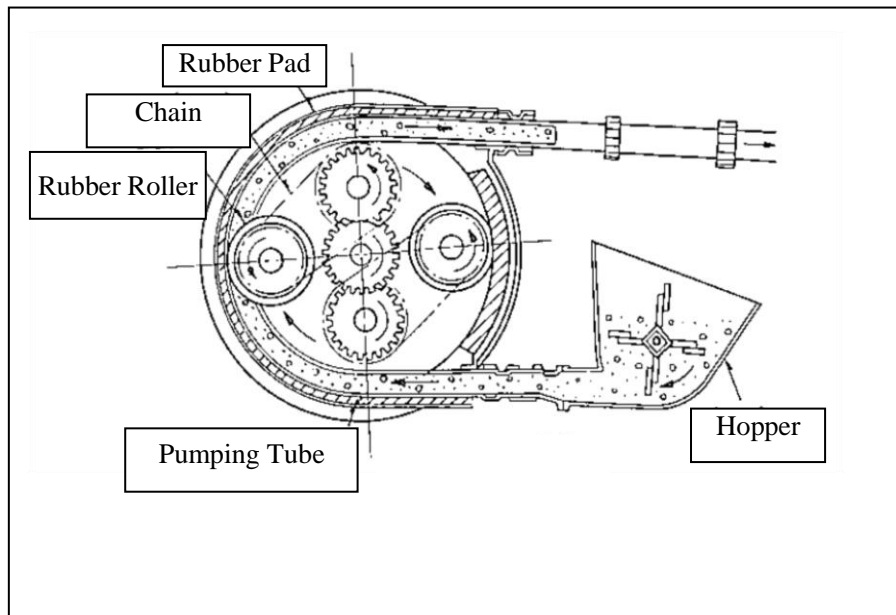

Figure 8.2-2 Squeeze Type

In the piston type, the pistons are alternately pushed and pulled in the two cylinders to pump concrete, which can obtain high discharge power, and it is suitable for high head/ long distance pumping.

In the squeezing type, a rubber hose installed on the inner circumference of a drum case is rotated while squeezing it with a roller to push concrete. This type cannot increase the discharge force but since its structure is simple and small, therefore this type is applied for many cases with the small-scale constructions.

Points of the concrete pump are as follows;

- Slump needs to more than 8 cm, generally approx.12 cm is applied.
- Considering that the slump loss is about 1 cm at pumping of 150 m.
- Cement content is required more than a certain amount. As an example, in the case of 100 m handling, the minimum cement content is 290 kg / m³.
- Before pouring of fresh concrete, mortar which mix design between cement content and sand content is one (cement content) to one (sand content) or one (cement content) to three (sand content) should be charged to inside of transportation pipe. If fresh concrete is charged directly without mortar charging, fresh concrete will be stacked in transportation pipe cause by losing the mortar paste in fresh concrete.

(3) Shoot (Chute)

When pouring concrete from a high place, use a vertical chute or a flexible hose with an appropriate pipe diameter. Since diagonal shoot (chute) is likely to cause segregation of materials, it is not used as much as possible. When it is inevitable to use, the inclination angle is set to about 1 (one) perpendicular to the horizontal 2 (two). Moreover, the tip of the discharge portion does not exceed 1.5 m from the pouring surface and the following baffle plate and funnel shape pipe are provided to prevent the segregation of materials. Recommendable method when the diagonal shoot (chute) is applied is shown in below figure.

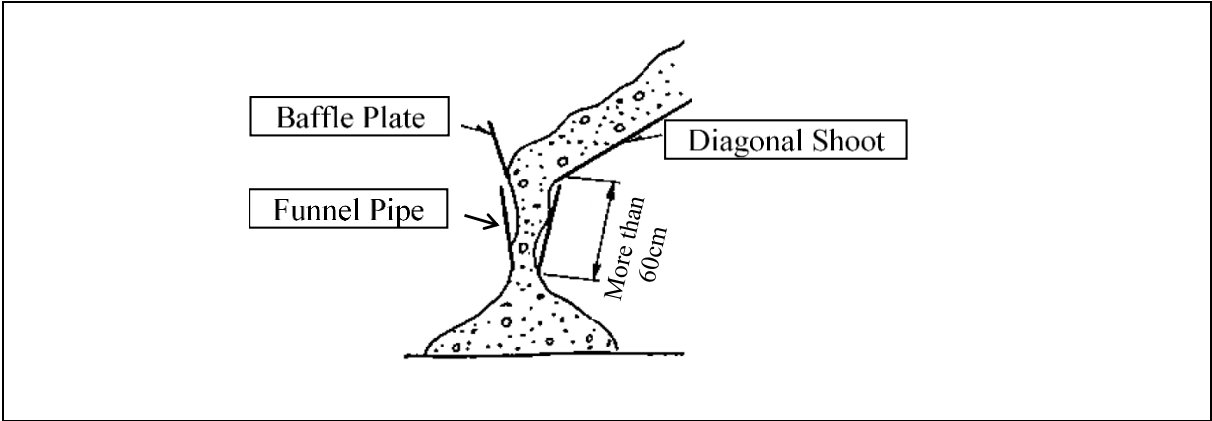

Figure 8.2-3 Recommendable Method for Diagonal Shoot (Chute)

CHAPTER 9. PREPARATION BEFORE POURING AND METHODOLOGY OF POURING

Whenever a concrete pouring plan or schedule is specified or approved, the sequence of pouring shall conform to the plan. Unless otherwise specifically permitted by the contract documents, the requirements of the following paragraphs shall apply.

Even in the case of changing the plan due to a change in circumstances, etc., site engineer must respect the purpose of the plan well and select a construction plan with same policy according to the change of conditions. For that purpose, it is important that all construction personnel including workers have knowledge of pouring concrete and that it is constructed with a consciousness to construct a structure of given quality by appropriate execution.

9.1 Preparation before Pouring

9.1.1. Protection of Concrete from Environmental Conditions

Precautions shall be taken as needed to protect concrete from damage due to weather or other environmental conditions during pouring and curing operations. Concrete that has been frozen or otherwise damaged by weather conditions shall be either repaired to an acceptable condition or removed and replaced.

In AASHTO, the temperature of the concrete mixture immediately before pouring shall be between 50°F (approx. 10°C) and 90°F (approx. 32.2°C), except as otherwise provided herein.

(1) Rain Protection

Under conditions of rain, the pouring of concrete shall not be commenced or shall be stopped unless adequate protection is provided to prevent damage to the surface mortar or damaging flow or wash of the concrete surface.

(2) Hot-weather Protection

When an ambient temperature is above 90°F (approx. 32.2°C), the forms, reinforcement bar, steel beam flanges, and other surfaces which will come in contact with the mix shall be cooled to below 90°F (approx. 32.2°C) by means of a water spray or other approved methods.

The temperature of the concrete at time of placement shall be maintained within the specified temperature range by any combination of the following:

- Shading materials storage areas or production equipment.
- Cooling aggregates by sprinkling with water which conforms to the requirements of water.
- Cooling aggregates or water by refrigeration or replacing a portion or all of the mix water with ice that is flaked or crushed to the extent that the ice will completely melt during mixing of the concrete.
- Injecting liquid nitrogen

9.1.2. Checking of Re-bar Arrangement, Formwork and Falsework

Prior to pouring, site engineer should check arrangement and fixing condition of re-bar, formwork and falsework, whether they are arranged at the specified portion. Also, adequate numbers of workers should be arranged. If a problem is detected, appropriate modification should be carried out immediately.

9.1.3. Checking Equipment

Site engineer should confirm the arrangements and the specifications of all numbers of equipment whether follows the construction plan. If actual construction plan has changed from original one, revised plan should be re-planned and be approved by the responsible engineer.

Checking all numbers of equipment should be finished at least one day before pouring date. If problems occur, appropriate repair, replacement, etc. must be carried out immediately. The spare equipment and material for repairing which are easily to be able to prepare should be arranged.

9.1.4. Points of Cleanings

Site engineer must be carried out the inspection before starting the pouring. Generally, the installation of the reinforcement bars is commenced for construction of the structure on the ground, and the formwork assembly is started when progress to a certain extent progress. After starting of formwork, cleaning of inside for pouring portion becomes difficult, therefore it is recommended to clean up the pouring portion one time before commencement of formwork. After cleaning once, site engineer must be careful not to enter impurities in the structure. Particularly when entering the concrete pouring portion for re-bar arrangement etc., consideration is required to drop mud etc. of shoes before entering.

Muds is very difficult to clean once falling down to soffit even though cleaning by water, therefore the small wholes should be open on the formwork for taking out foreign matters and litters appropriately.



9.1.5. Necessity of Sprinkling Water

Moderate moisture is very important to consolidate of concrete. During poured the fresh concrete is prevented from losing water.

Water in fresh concrete is lost which touches or puts near to formworks during pouring concrete, because in the case of applying wooden formwork in dry condition is high water absorption, and metal formwork in high temperature conditions is very high.

To prevent losing water from conditions above, water must be sprinkled to the form work just before pouring. Besides, Watering also has the effect of lowering the temperature of the fresh concrete.

9.1.6. Items for Record

Checking sheet used before pouring concrete should be prepared and recorded as quality control documents. A sample of checking sheet is attached in Appendix 6.

9.2 Methodology of Pouring

9.2.1. Points of Pouring

In pouring, it is important to prevent segregation of materials and occurrence of cold joints, unfilled parts and honeycomb, etc., to ensure uniformity.

Points of pouring are as follows.

- 1) When pouring, to consider avoiding occurrence of insufficient covering by deviation of reinforcement bar, formwork, falsework and spacers etc.
- 2) For carrying out pouring, to consider time interval and consolidation so that the concrete already poured and the concrete will be united. Allowable time interval of pouring for new layer is 120 - 150 minutes at temperature is less than 25 degree Celsius, 60 - 120 minutes at temperature is more than 25 degree Celsius approximately.
- 3) To consider keeping appropriate pouring speed for consolidation. Thickness of one layer should be less than 40 – 50 cm in principal.
- 4) To consider pouring vertically at interval 1 – 3 m. The sideway following with vibrators is prohibited because segregation of materials is easy to occur.
- 5) To consider the pouring height, it is less than 1.5 m between discharge portion and pouring portion, and pouring should be evenly and horizontally.
- 6) To consider removing bleeding water before pouring new layer.
- 7) To control the pouring time for pouring continuously to high structure such as walls or piers to avoid exceeding lateral pressure against formworks. Generally pouring speed is around 2.0 m to 3.0 m per hour. Pouring speed should be follow “Formwork Calculation” made by site engineer in advance.
- 8) If pouring to structures, such as deck or beam connected to wall or column, cracks may occur on the concrete surface caused by settlement at the lower parts concrete of the deck or beam. Therefore, it is recommended to wait completion of settlement of the concrete of the wall and the pillar, after then pouring the upper parts. Refer to below figure. The approx. ending time of settlement is different depending on the mixing design and temperature, but 1 to 2 hours is common.
- 9) Site engineer should consider the appropriate pouring sequence for construction with good durability. The basic pouring sequence of footing is shown in the figures below.

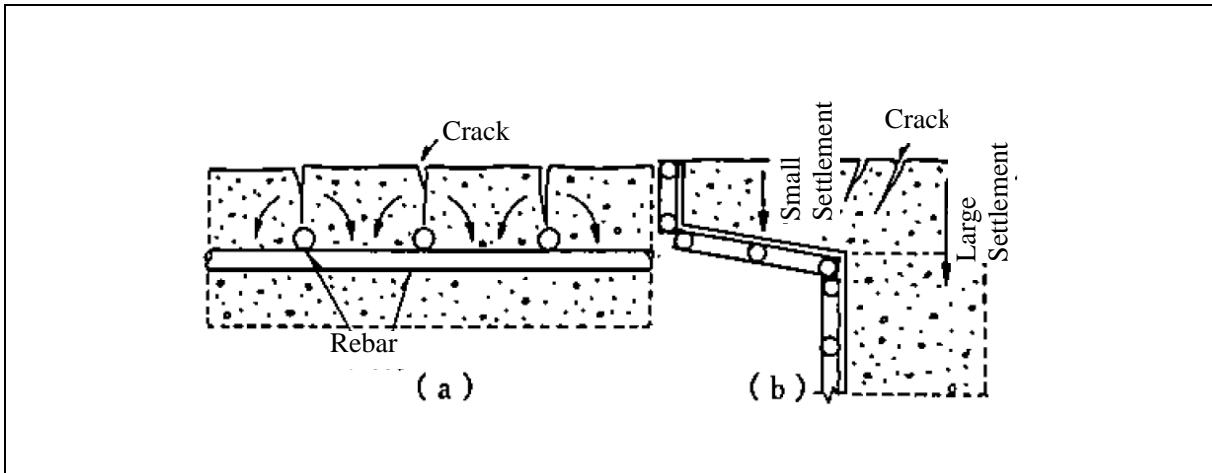

Figure 9.2-1 Image of Occurrence of Cracking

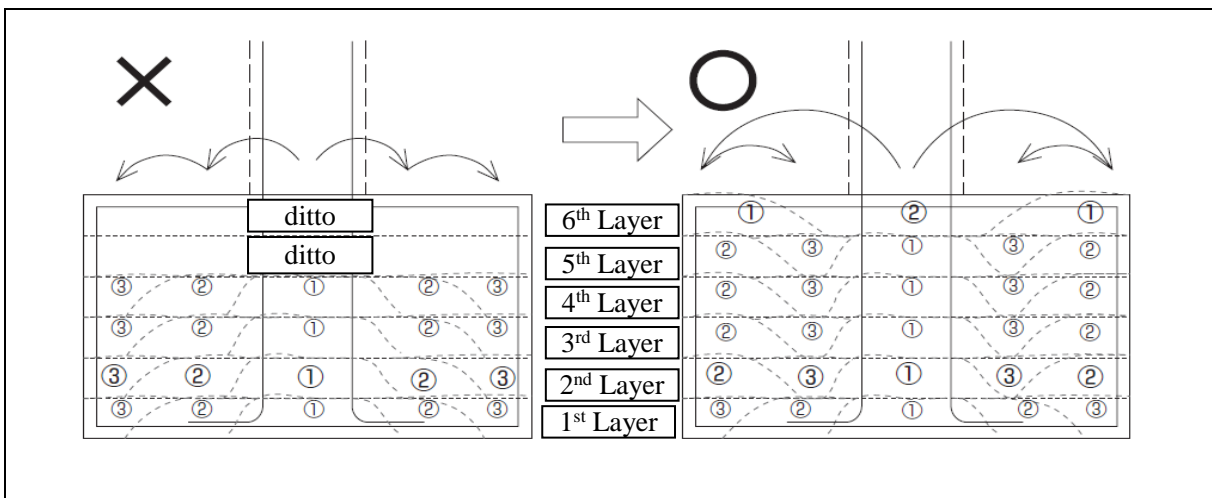

Figure 9.2-2 Appropriate Pouring Sequence for Footing 1/2

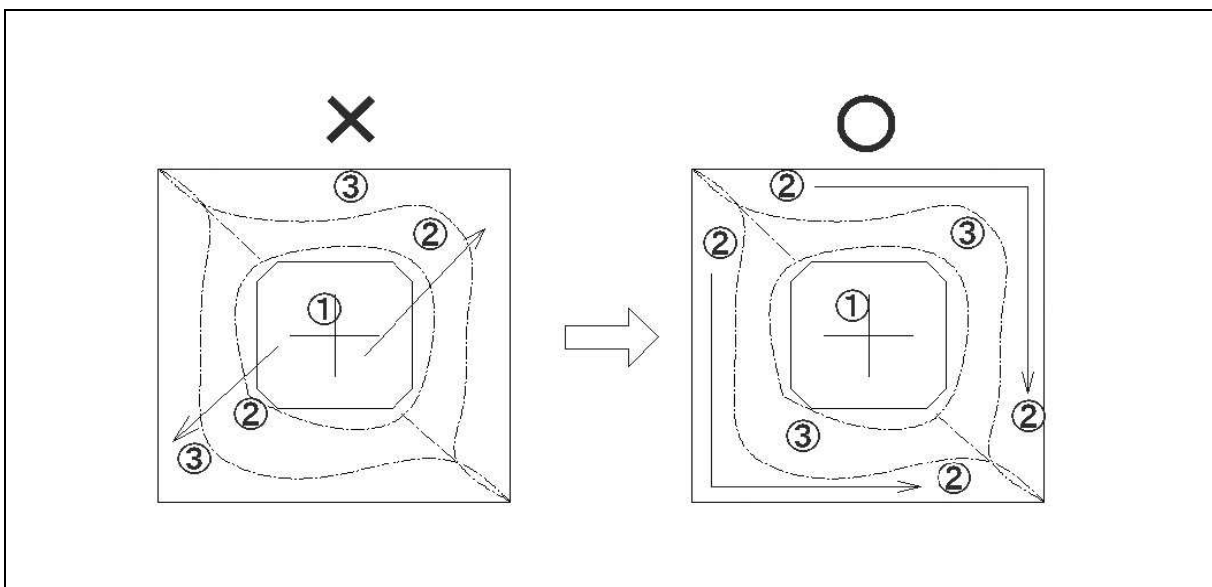

Figure 9.2-3 Appropriate Pouring Sequence for Footing 2/2

9.2.2. Pouring for Vertical Members

Concrete for columns, substructure and culvert walls, and other similar vertical members shall be poured and allowed to set and settle for a period of time before concrete for integral horizontal members, such as caps, slabs, or footings, is poured. Such period shall be adequate to complete settlement due to loss of bleeding water and shall be not less than 12 hours for vertical members over 15.0 ft (approx.4.5 m) in height and not less than 30 minutes for members over 5.0 ft (approx.1.5 m), but not over 15.0 ft (approx.4.5 m) in height. When falsework brackets are mounted on such vertical members and unless otherwise approved, the vertical member shall have been in place at least seven days and shall have attained its specified strength before loads from horizontal members are applied.

9.2.3. Superstructures

Unless otherwise permitted, no concrete shall be poured in the superstructure until substructure formworks have been stripped sufficiently to determine the character of the supporting substructure concrete.

Concrete for T-beam or deck girder spans whose depth is less than 4.0 ft (approx. 1.2 m) may be poured in one continuous operation or may be poured in two separate operations; first, to the top of the girder stems, and second, to completion. For T-beam or deck girder spans whose depth is 4.0 ft (approx.1. 2 m) or more, and unless the falsework is nonyielding, such concrete shall be poured in two operations, and at least five days shall elapse after pouring of stems before the top deck slab is placed. Concrete for box girders may be poured in two or three separate operations consisting of bottom slab, girder stems, and top slab. In either case, the bottom slab shall be poured first and, unless otherwise permitted, the top slab shall not be poured until the girder stems have been in pour for at least five days.

9.2.4. Arches

The concrete in arch rings shall be poured in such a manner as to load the centering uniformly and symmetrically. Arch rings shall be cast in transverse sections of such size that each section can be cast in a continuous operation. The arrangement of the sections and the sequence of placing shall be as approved and shall be such as to avoid producing initial stress in the reinforcement. The sections shall be bonded together by suitable keys or dowels. Unless prohibited by the contract documents, arch barrels for culverts and other arches may be cast in a single continuous operation.

9.2.5. Box Culverts

In general, concrete for base slabs or footings of box culverts shall be poured and allowed to set before the remainder of the culvert is constructed. For culverts whose wall height is 5.0 ft (approx. 1.5m) or less, concrete for sidewalls and top slab may be poured in one continuous operation. For higher culvert walls, the requirements for vertical members shall apply.

9.2.6. Precast Elements

The method of pouring for concrete in precast elements shall be such that sound, well-consolidated concrete that is free of settlement or shrinkage cracks is produced throughout the member.

9.2.7. Consolidation (Compaction)

All concrete, except concrete placed under water and concrete otherwise exempt, shall be consolidated by mechanical vibration immediately after placement.

Except as noted herein, vibration shall be internal. External form vibrators may be used for thin sections when the forms are designed for external vibration.



Figure 9.2-4 Type of Vibrators

Vibrators shall be of approved type and design and of a size appropriate for the work. They shall be capable of transmitting vibration to the concrete.

Site shall prepare sufficient number of vibrators to compact properly each batch of concrete immediately after it is poured in the formworks. At least one spare vibrator shall be also prepared immediately available in case of breakdown. Standard capability of vibrator is shown in table below.

Table 9.2-1 Standard Capability of Vibrators

Diameter of Internal Vibrator	Consolidation Range Diameter	Consolidation Capability
30 Ø	350 mm	12 m ³ /h
40 Ø	450 mm	18 m ³ /h
50 Ø	600 mm	24 m ³ /h
60 Ø	700 mm	30 m ³ /h

Vibrators shall be manipulated so as to thoroughly work the concrete around the reinforcement and forms. Vibration shall be applied at the point of deposit and in the area of freshly deposited concrete. The vibrators shall be inserted and withdrawn out of the concrete slowly. The vibration shall be of sufficient duration and intensity to thoroughly consolidate the concrete but shall not be continued so as to cause segregation. Vibration shall not be continued at any one point to the extent that localized areas of grout are formed. Application of vibrators shall be at points uniformly spaced and no further apart than 1.5 times the radius over which the vibration is visibly effective.

Vibration shall not be applied either directly to, or through the reinforcement to, sections or layers of concrete which have hardened to the degree that the concrete ceases to be plastic under vibration.

Insert each within the effective range, the phenomenon of volume diminution of the concrete stops, and finishes when the mortar paste averages on the surface feathers. When pulling out the vibrator, slowly pull it up so that no holes left there. In addition to the above basic method, the following points should be payed attention. Vibration time is 15 to 30 seconds for slump 10 cm or less and 7 to 10 seconds for slump greater than 10 cm.

- 1) If segregation of aggregates occurs during concrete is poured in, the segregated aggregate must be scooped up quickly and buried in concrete with sufficient mortar and fully vibrating.
- 2) For pouring concrete on the upper part and consolidating, when the lower concrete is beginning to harden, insert the vibrator in the lower part of concrete by about 10 cm and re-vibrate at a narrow interval.
- 3) In case of pouring at the inclined surface, be sure to start pouring from the bottom and start the vibrator from below part as well. The reason is that concrete is consolidated by weight and vibration of the concrete which is poured in later. On the contrary, when it is poured from the top of the inclined surface, it tends to pull the upper concrete. Especially when vibration is applied downside, flow will start.

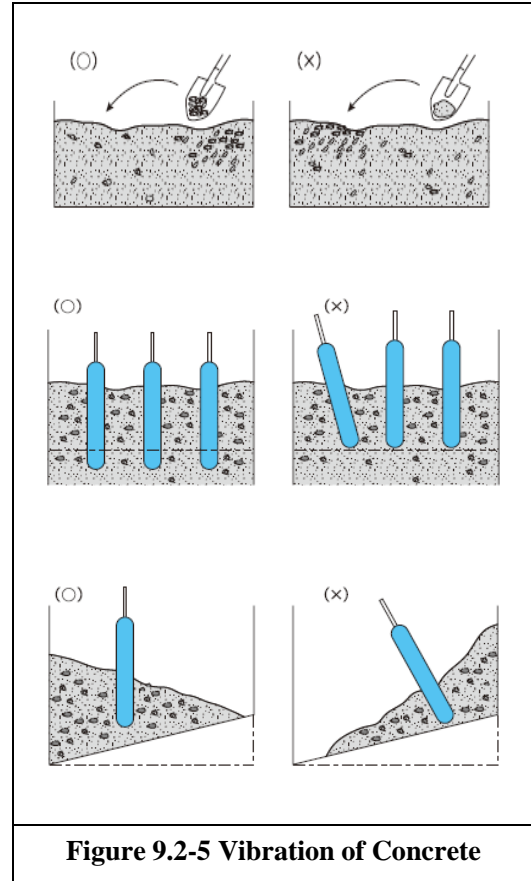

Figure 9.2-5 Vibration of Concrete

9.2.8. Underwater Pouring

Only concrete used in cofferdams to seal out water may be placed under water, unless otherwise specified in the contract documents or specifically approved by engineers. JIS standard specifies that the minimum cement content is 370 kg/m³ and less than 50% for water cement ratio excepting bored pile in order to compensate loss due to wash.

To prevent segregation, concrete pouring under water shall be carefully poured in a compact mass, in its final position, by means of a tremie, concrete pump, or other approved method and shall not be disturbed after being deposited. Still water shall be maintained at the point of deposit and the forms under water shall be watertight. Cofferdams shall be vented during pouring and cure of concrete to equalize the hydrostatic pressure and thus prevent flow of water through the concrete.

Concrete pouring under water shall be conducted continuously from start to finish. The surface of the concrete shall be kept as nearly horizontal as practicable. To ensure thorough bonding, each succeeding layer of seal shall be placed before the preceding layer has taken initial set. For large pours, more than one tremie or pump shall be used to ensure compliance with this requirement.

Underwater inseparable concrete is recommendable to use for poured concrete underwater.

The method of pouring of both case which are applied underwater inseparable concrete and normal concrete are shown in Figure below.

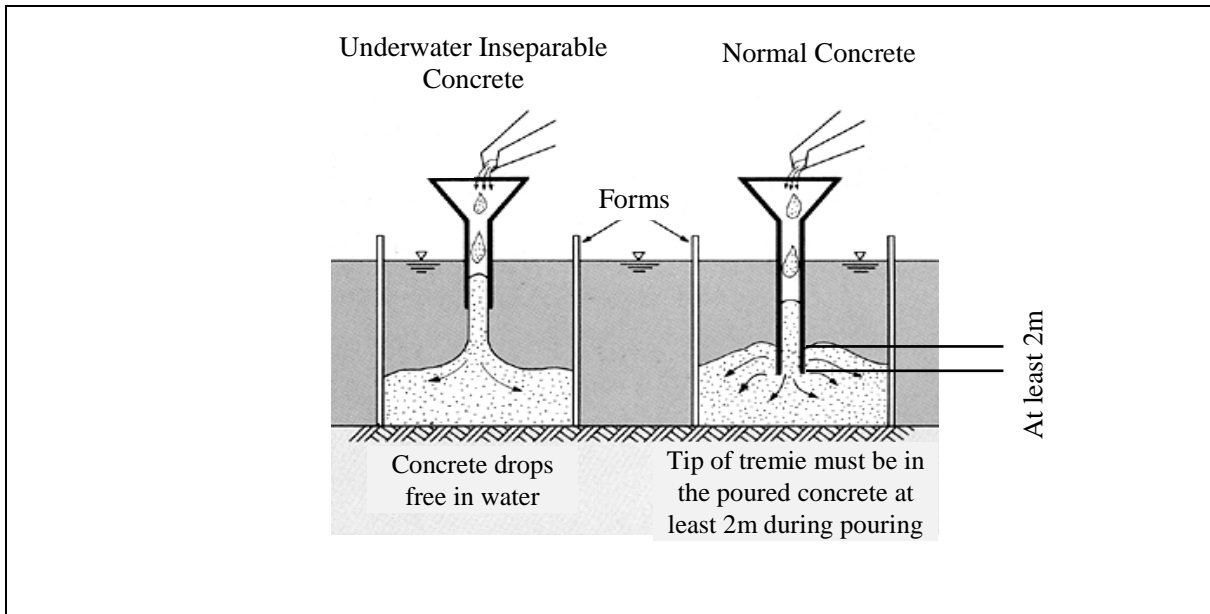

Figure 9.2-6 Pouring Method Underwater by Tremie

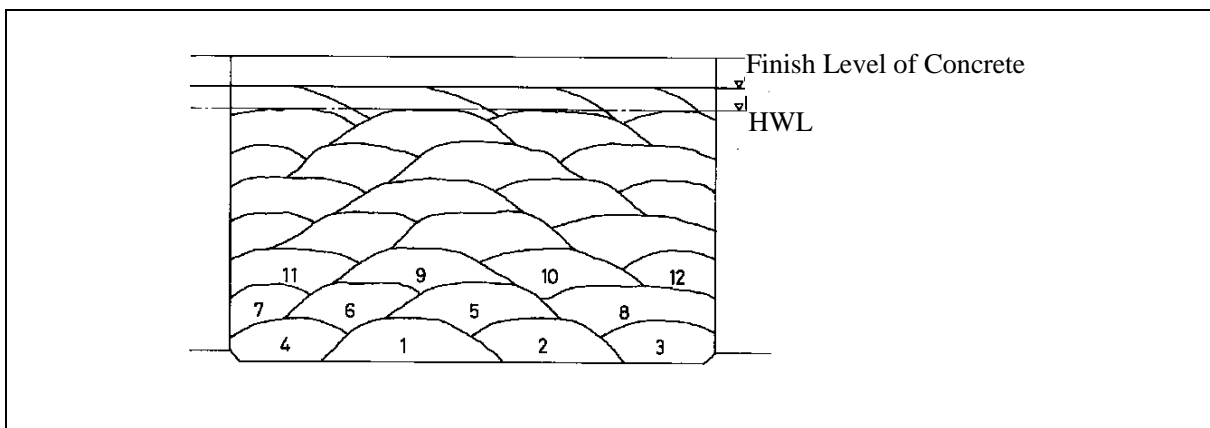

Figure 9.2-7 Example of the Sequence of Pouring

(1) Equipment

A tremie shall have a watertight tube with a diameter of not less than 10.0 in (approx.250 mm). and fitted with a hopper at the top. The tremies shall be supported so as to permit free movement of the discharge end over the entire top surface of the work and so as to permit rapidly lowering when necessary to retard or stop the flow of concrete. The discharge end shall be sealed and closed at the start of work so as to prevent water from entering the tube before the tube is filled with concrete (refer Figure below). After placement has slatted, the tremie tube shall be kept full of concrete to the bottom of the hopper. If water enters the tube after placement is started, the tremie shall be withdrawn,



the discharge end resealed, and the pouring restarted. When a batch is dumped into the hopper, the flow of concrete shall be induced by slightly raising the discharge end, always keeping it in the deposited concrete. The flow shall be continuous until the work is completed. When cofferdam struts prevent lateral movement of tremies, one tremie shall be used in each bay.

Concrete pumps used to pour concrete underwater shall have a device at the end of the discharge tube to seal out water while the tube is first being filled with concrete. Once the flow of concrete is started, the end of the discharge tube shall be kept full of concrete and below the surface of the deposited concrete until placement is completed.

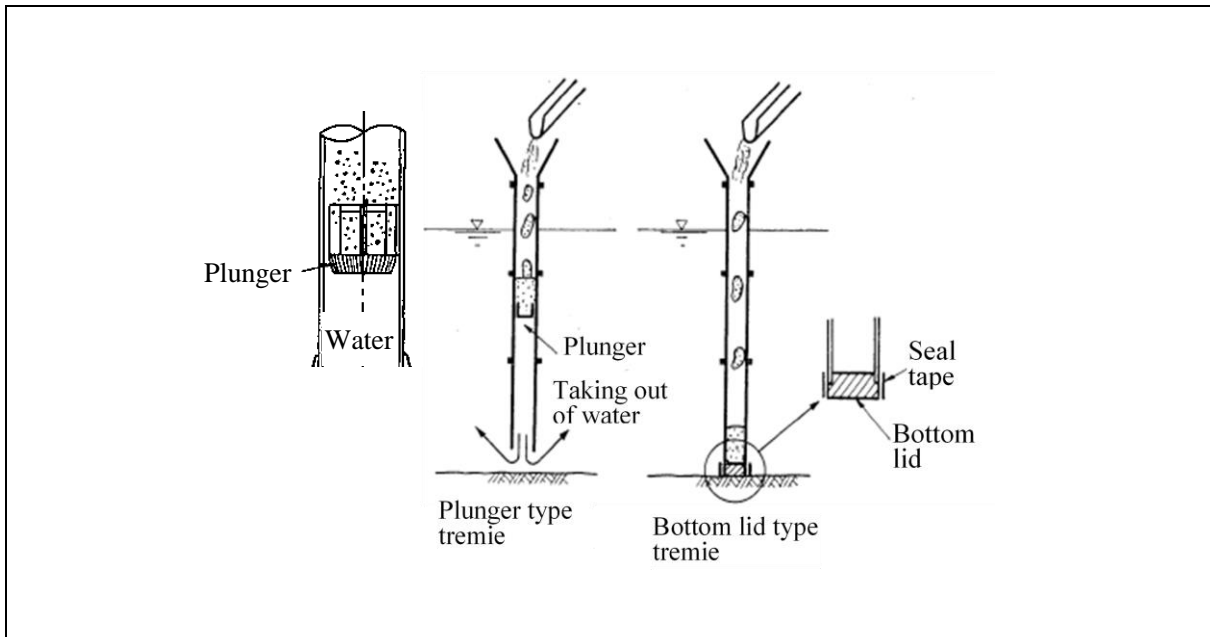

Figure 9.2-8 Method for Fill the Concrete in Tremie

(2) Clean-up

Dewatering may proceed after test specimens cured under similar conditions indicate that the concrete has sufficient strength to resist the expected loads. All laitance or other unsatisfactory materials shall be removed from the exposed surface by scraping, chipping, or other means which will not injure the surface of the concrete before placing foundation concrete.

9.3 Finishing Plastic Concrete

Unless otherwise specified in the documents, after concrete has been consolidated and prior to the application of cure, all surfaces of concrete that are not placed against forms should be carried out finishing immediately. While the concrete is still in a workable condition, all construction and expansion joints shall be carefully tooled with an edger. Joint filler shall be left exposed.

9.3.1. Purpose of Finishing

Concrete surface is easy to penetrate degradation factors such as rainwater and oxygen in the air. Since the formwork surface is held down by the formwork, finishing would not be done. Meanwhile, the surface to be poured is finished with a trowel and strengthened. The surface to be sunk by the rise of bleeding water generated after casting may form subsidence cracks and penetration path of degradation

factors on the surface. Therefore, finishing by trowel is required. The phenomenon of concerning cracks is shown Figure below.

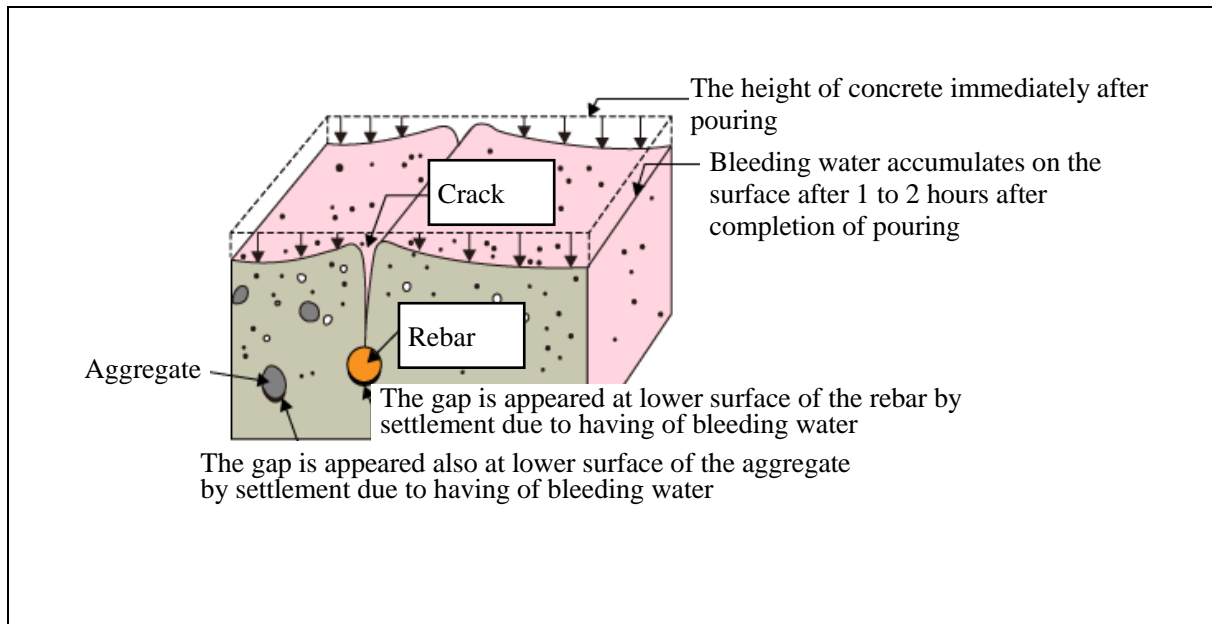

Figure 9.3-1 Phenomenon of Concerning Cracks

9.3.2. Method of Finishing

To finish the concrete, carry out rough finishing with a wooden trowel and finishing it with iron trowel. During finishing operations, excess water, laitance, or foreign materials brought to the surface during the course of the finishing operations shall not be reworked into the slab, but shall be removed immediately upon appearance. The addition of water to the surface of the concrete to assist in finishing operations will not be permitted.

CHAPTER 10. CURING CONCRETE

All newly poured concrete shall be cured so as to prevent loss of water by use of one or more of the methods specified herein. Structural concrete curing shall commence immediately after the free water has left the surface and finishing operations are completed. For structural concrete, water curing shall commence immediately after finishing operations are complete. If the surface of the concrete begins to dry before the selected cure method can be applied, the surface of the concrete shall be kept moist by using a fog spray applied so as not to damage the surface.



Figure 10-1 Water Curing

Curing with other than waterproof cover, steam, or radiant-heat methods with precast concrete shall continue uninterrupted for seven days, if the Portland cement are used in the mix. When such pozzolans are used, the curing period shall be ten days. For other than top slabs of structures serving as finished pavements concrete, the above curing periods may be reduced and curing terminated when test cylinders cured under the same conditions as the structure indicate that concrete strengths of at least 70 percent of that specified have been reached.

When deemed necessary by site engineer during periods of hot weather, water shall be applied to concrete surfaces being cured by the liquid membrane method, until site engineer determines that a cooling effect is no longer required.

10.1 Basic of Curing

The basis of curing is to keep it wet, control temperature, and protect against harmful effects. It is necessary to determine the curing method and duration in consideration of the type of construction, construction conditions, location conditions, environment, etc.

(1) Wet Curing Method

After pouring, the surface dries and the internal moisture is lost at the very early stage, strength of the concrete is lost because the hydration reaction of the cement is not sufficiently performed. Also, when the surface rapidly dries, especially due to direct sunlight, wind etc., it will cause cracking. It is the purpose of wet curing to prevent losing moisture from direct sunlight, wind etc.

The appropriate timing of starting for curing is when the condition of hardening to the extent that

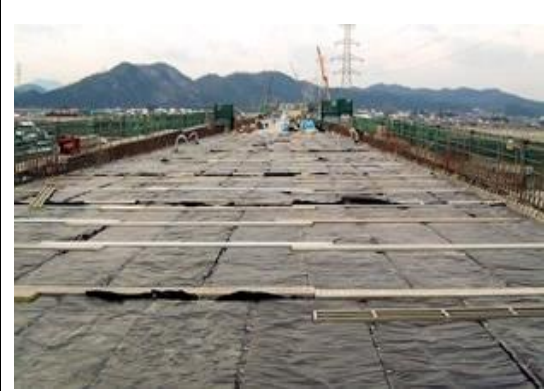

Figure 10.1-1 Wet Curing Sheet

it can work without roughening the surface of concrete. As a wet curing method, the exposed surface of the concrete is a method of covering the curing mat, cloth etc. wetted with it, directly keeping the concrete surface wet by sprinkle, covering water, etc. If the formwork would be drying, the sprinkle should be necessary too.

The period of wet curing varies depends on the daily average temperature and the type of cement. However, JIS specifies the standard curing period as shown in Table 10.1-1.

Table 10.1-1 Minimum Period of Curing

Daily Average Temperature	Standard Portland Cement	Early Strength Cement
More than 15°C	5 days	3 days
10°C to 15°C	7 days	4 days
Less than 10°C	9 days	5 days

(2) Liquid Membrane Curing Method

Liquid membrane curing is aimed at initial curing immediately after completion of pouring, but it is also used when it is difficult to carry out curing by curing mats, water spraying or the like, and in case of preventing water loss over a long period of time. Methods of spraying or applying a curing agent on the surface of concrete to prevent evaporation of moisture. Spraying or applying curing agents shall be start after the bleeding water on the concrete surface disappears.

This method is applied with wet curing as much as possible. Required efficiencies of Curing agent are as follows.

- Having performance that can keep moisture
- Easy to spray or apply and having good workability
- Being harmless to the human body
- Good adhesion to concrete
- Having sufficient durability against meteorological effects such as wind, rain and sunshine



Figure 10.1-2 Liquid Membrane Curing

- The remaining applying membrane does not inhibit adhesion to concrete and the like

(3) Temperature Control Method

The hydration reaction of cement is significantly affected from concrete temperature during curing. Also, it is harmfully affected when the outside temperature is extremely low, high, or suddenly changed. The curing that protects concrete from such a condition is temperature control curing.

When the outside air temperature is low (daily average temperature is 4°C or less), hydration reaction of cement is inhibited, strength development delay and initial frost damage is feared. On the other hand, when outside air temperature is high (daily average air temperature is 25°C. or more), the initial strength is high, but strength

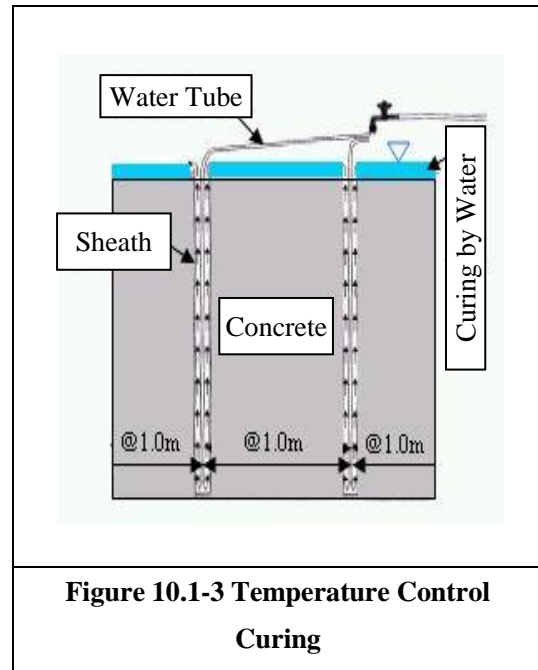

elongation at long term material age is small and the durability may be inferior in some cases. Furthermore, cracks due to temperature stress may occur when the member size is large and temperature rise due to the hydration reaction of the cement becomes large or the temperature difference in the member becomes large. In such a case, it is necessary to control the concrete temperature and the temperature difference by pre-cooling, pipe cooling, keeping the surface warm.

10.2 Materials

10.2.1. Water

Water used in curing of concrete shall be subject to approval and shall be reasonably clean and free of oil, salt, acid, alkali, sugar, vegetable, or other injurious substances. Water shall be tested in accordance with, and shall meet the requirements of AASHTO T26. Water which has potable quality may be used without the tests. Where the source of water is relatively shallow, the intake shall be so enclosed as to exclude silt, mud, grass, or other foreign materials.

10.2.2. Liquid Membranes

Liquid membrane-forming compounds for curing concrete shall conform to the requirements of AASHTO M 148 (ASTM C309).

10.2.3. Waterproof Sheet Materials

Waterproof paper, polyethylene film and white burlap polyethylene sheet shall conform to the requirements of AASHTO M 171 (ASTM C171).

10.3 Check Point of Curing

Check points of curing are as follows. It is recommended that the site engineer manage the curing in accordance with following check points on site.

Table 10.3-1 Check Points for Curing

Stage of Works	Check points	Management Items	Check on Site
1. Plan of curing	(1) Is curing method appropriate? (2) Is the outside temperature low or high? (3) Does not concrete surface dry? (4) Is there no sudden temperature change during curing? (5) Is there no vibration during curing? (6) Do not receive impact during curing?	<ul style="list-style-type: none"> • Curing method and period • Quantity of materials etc. • Outside temperature • Weather • Wet condition of the surface • Curing temperature • Having or not having of vibration • Having or not having of vibration 	<input type="checkbox"/> <input type="checkbox"/> <input type="checkbox"/> <input type="checkbox"/> <input type="checkbox"/> <input type="checkbox"/> <input type="checkbox"/>
2. Wet curing	(1) Is not concrete surface dry? (2) Is the curing period appropriate? (3) Is it appropriate to keep concrete surface wet?	<ul style="list-style-type: none"> • Wet condition of the surface • Curing period • Method of water supply • Strength of initial age 	<input type="checkbox"/> <input type="checkbox"/> <input type="checkbox"/> <input type="checkbox"/>
3. Curing for protection against harmful effects	(1) Is vibration, impact or excessive load acting on uncured concrete? (2) Whether an excessive load is applied to the initial material age	<ul style="list-style-type: none"> • Acting of external force • Acting of external forces at early age 	<input type="checkbox"/> <input type="checkbox"/>
4. Curing method for formwork	(1) Is method appropriate? (2) Is the surface of formwork dry?	<ul style="list-style-type: none"> • Method of curing • Condition of formwork 	<input type="checkbox"/> <input type="checkbox"/>
5. Liquid membrane curing	(1) Whether it is applied in combination with wet curing (2) Is material selection appropriate? (3) Is the time of spraying appropriate? (4) Is the spraying method appropriate?	<ul style="list-style-type: none"> • Combined use with wet curing • Material used • Timing of spraying • Method of spraying 	<input type="checkbox"/> <input type="checkbox"/> <input type="checkbox"/> <input type="checkbox"/>

CHAPTER 11. JOINT

Concrete structures need to be constructed in some lots for structural or constructional reasons. Construction joints tend to be weak points from the standpoint of structural strength, durability, water tightness, etc., because they are difficult to integrate perfectly. Therefore, it is necessary to provide a joint in consideration of such points.

11.1 Types of Joint

Types of joint are shown in Figure 11.1-1.

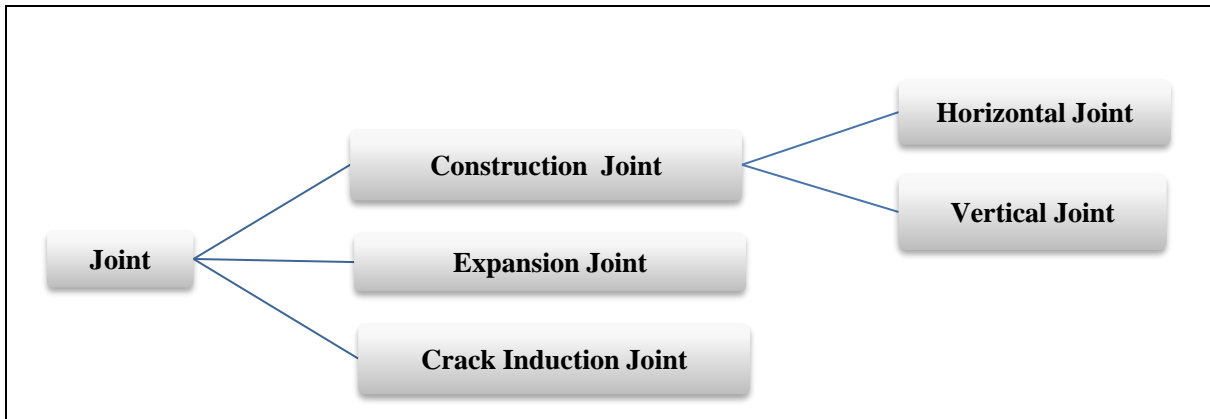

Figure 11.1-1 Types of Joints

11.2 Construction Joint

11.2.1. Position of Construction Joint

The following points need to be taken into account when planning of construction joint.

- Position with small shear force
- A position where jointed surface is perpendicular to the direction of working of the compressive force of the member

Example of position for construction joints are shown in Figure 11.2-1.

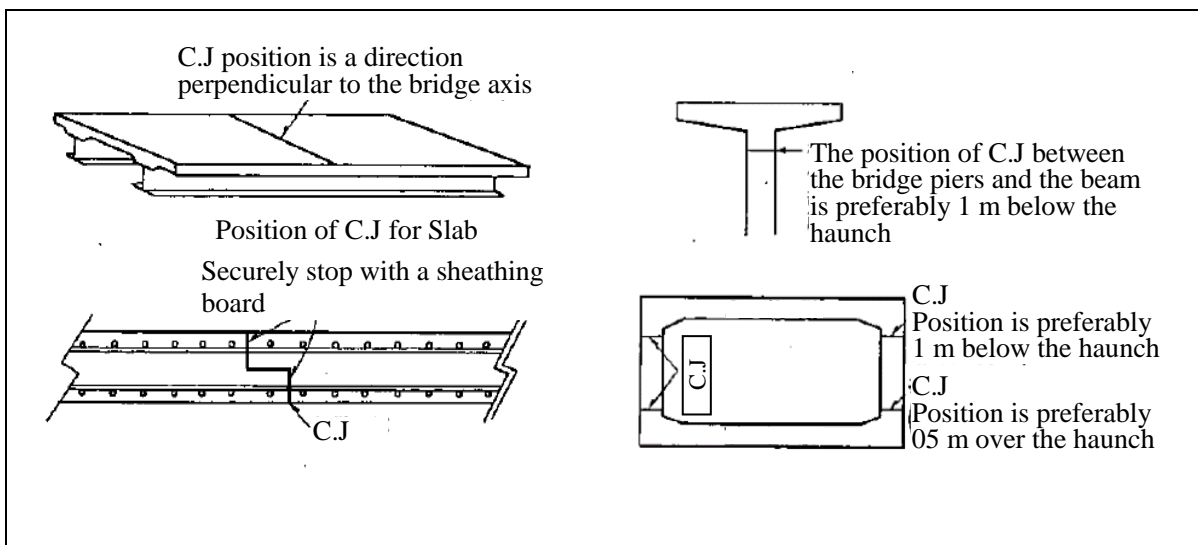

Figure 11.2-1 Example of Position for Construction Joints (C.J.)

11.2.2. In the case where it is provided at a position where the shearing force is large

In the case where the joints are forced to provide at positions with large shear, the following points must be taken into consideration.

- 1) Make "tenon" or "groove" on the joint surface
- 2) Proper steel material is placed and reinforced

11.2.3. In the case where Joints for structure that may be subjected to salt damage

Basically, no joints shall be arranged in structures that may be subjected to salt damage. When it is inevitable to provide joints such structures, it is necessary to avoid arranging joints between the upper 60 cm from the high tide and the lower 60 cm from the low tide.

11.2.4. Horizontal Construction Joint

(1) Treatment of Horizontal Joints Touching Formwork

From the viewpoint of improving aesthetic appearance, keep horizontal attention so that there are no gaps as a horizontal straight line. As a method, it is preferable to set at lower the joint position from the top of the formwork and indication its position on the formwork.

(2) Treatment before Pouring New Concrete

Before pouring new concrete, the laitance, concrete with poor quality, loose aggregate, etc. on the surface of the old concrete must be completely removed and the concrete surface is absorbed water sufficiently. Treatment methods include treating at an early stage after completion of previous poured concrete, processing at a stage where a relatively long time has passed after completion of that, and a combination of both.



**Figure 11.2-2 Treatment of C.J by Wire Brush
(Treating after passing a relatively long time)**



Figure 11.2-3 Completion of Treatment of C.J

Clean cut method is normally carried out by water with high pressure air. Timing to start is approx. one to three days after the concrete is poured, since structural layers are no longer affected to hardening of concrete.

Brushing method is generally carried out by the wire brush. Brushing shall be started at the time when curing progressed, which is approx. 12-24 hours completion of pouring of concrete. Brushing should be continued until top of aggregate is exposed.

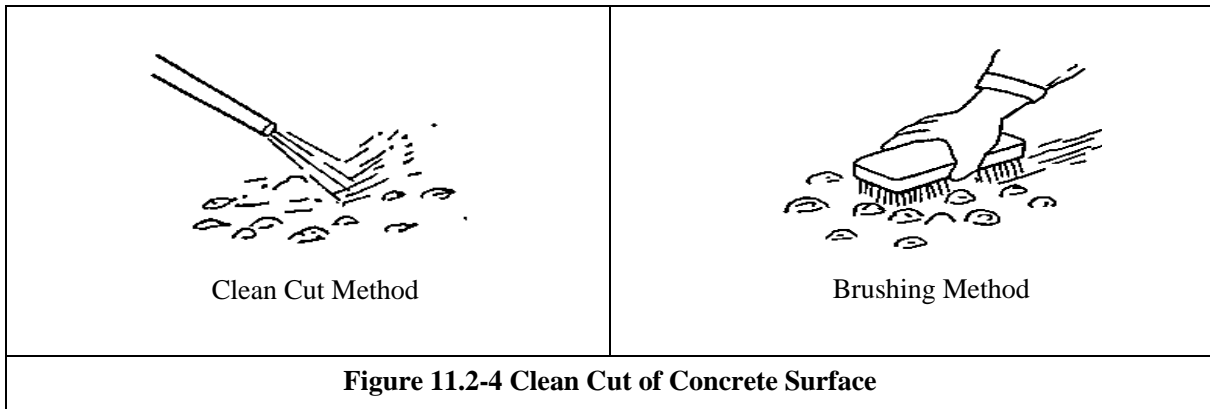

(3) Joint Treatment of Reverse Cast Concrete

As shown in the figure below, construction joint when the upper concrete is poured before the lower concrete (reverse cast concrete) is not integrated due to influence of bleeding water or settlement of newly poured concrete. Therefore, the integration of construction joint should be secured by applying direct method, filling method, injection method, which are mentioned in Figure 11.2-5.

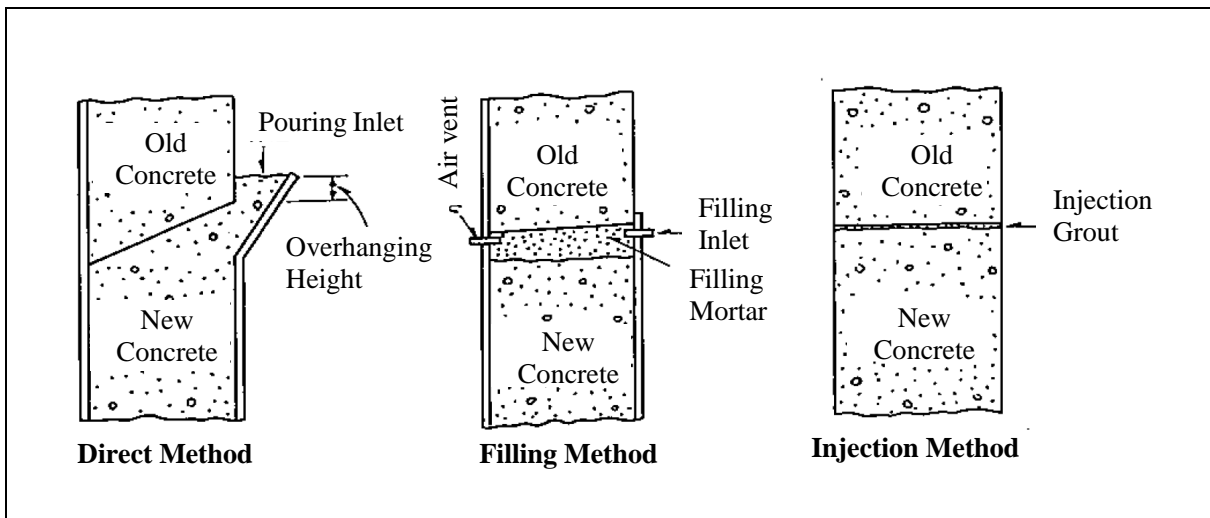

Figure 11.2-5 Treatment Method of Construction Joint for Reverse Cast Concrete

(4) Crack due to Confining of Old Concrete

As shown in the figure below, cracks tend to occur near construction joints due to the shrinkage difference between old concrete and new concrete. In such a case, it is desirable to arrange reinforcement bars to control the cracks near the construction joint.

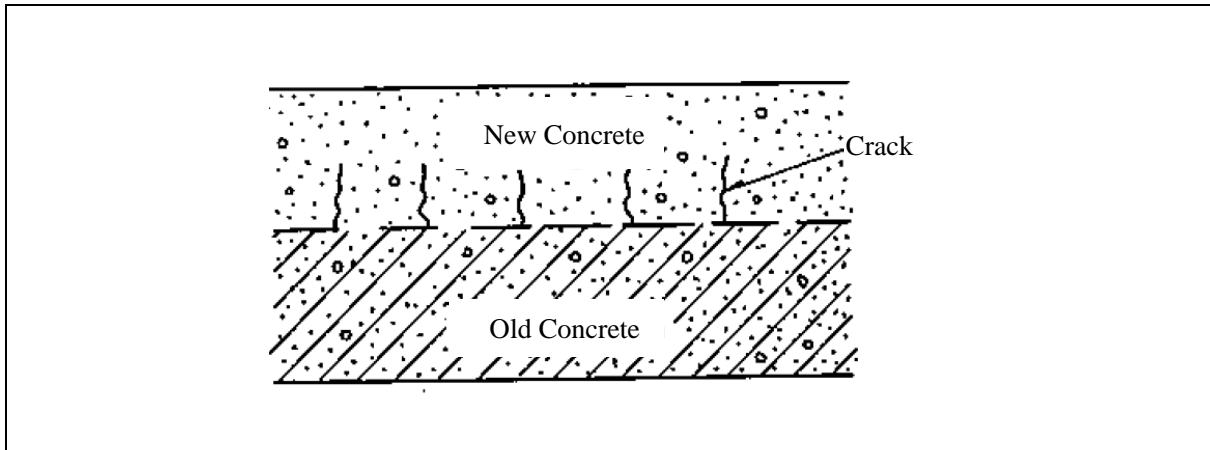

Figure 11.2-6 Example of Occurrence of Cracks due to Confining of Old Concrete

11.2.5. Vertical Joint

Construction of vertical joints is basically the same as that of horizontal joints, but the treatment method is different because the joint is vertical. For the treatment of vertical joints, make the vertical joint surfaces rough by the wire brush, chipping or the like, absorb water sufficiently, and apply cement paste, mortar or epoxy resin for wet surface or the like, and then proceed to pour the new concrete.

11.2.6. Doweling to Existing Structures

When the contract documents specify that new concrete be bonded to existing concrete structures, the existing concrete shall be cleaned and flushed. When the reinforcing dowels grouted into holes drilled in the old concrete at such construction joints, the holes shall be drilled by methods that will not damage the concrete adjacent to the holes. The diameters of the drilled holes shall be approx. 1.0 cm larger than the nominal diameter of the dowels unless shown otherwise in the contract documents. The grout shall be a neat cement paste of Portland cement and water. The water content shall be not more than 35 l/100 kg of cement. Immediately prior to placing the dowels, the holes shall be cleaned of dust and other deleterious materials, shall be thoroughly saturated with water, shall have all free water removed, and the holes shall be dried to a saturated surface-dry condition. Sufficient grout shall be poured in the holes so that no voids remain after the dowels are inserted. Grout shall be cured for a period of at least three days or until dowels are encased in concrete.

When specified in the contract documents or approved by the engineer, epoxy may be used in lieu of Portland cement grout for bonding of dowels in existing concrete. When used, epoxy shall be mixed and applied in accordance with the manufacturer's recommendations.

11.2.7. Prevention of Water Leakage

Water-stop materials should be installed at construction joints for structures related to water or underground to prevent leakage or intrusion of water. Water-stops should be embedded into the old concrete when old concrete is poured. The site engineer should apply appropriate materials and types to stop water unless otherwise indicated in the specifications of the contract document.

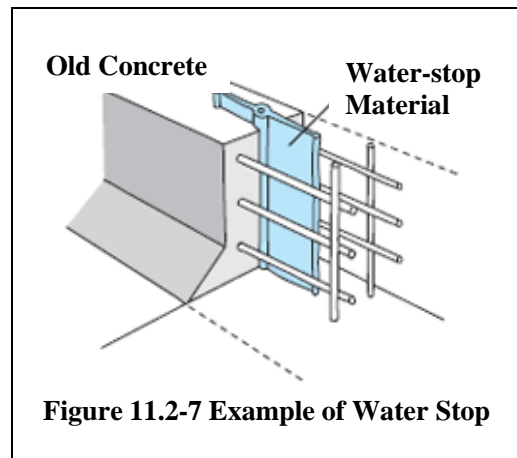

Figure 11.2-7 Example of Water Stop

11.3 Expansion Joint (E.J.)

When subjected to shrinkage or expansion due to drying shrinkage or temperature change, the concrete structure causes internal stress when deformation is confined, and cracks occur. Therefore, in long structures such as retaining walls and road pavements, joints (extensible joints) must be provided at suitable intervals not to cause deformation. Example of expansion joints are shown in below Figure.

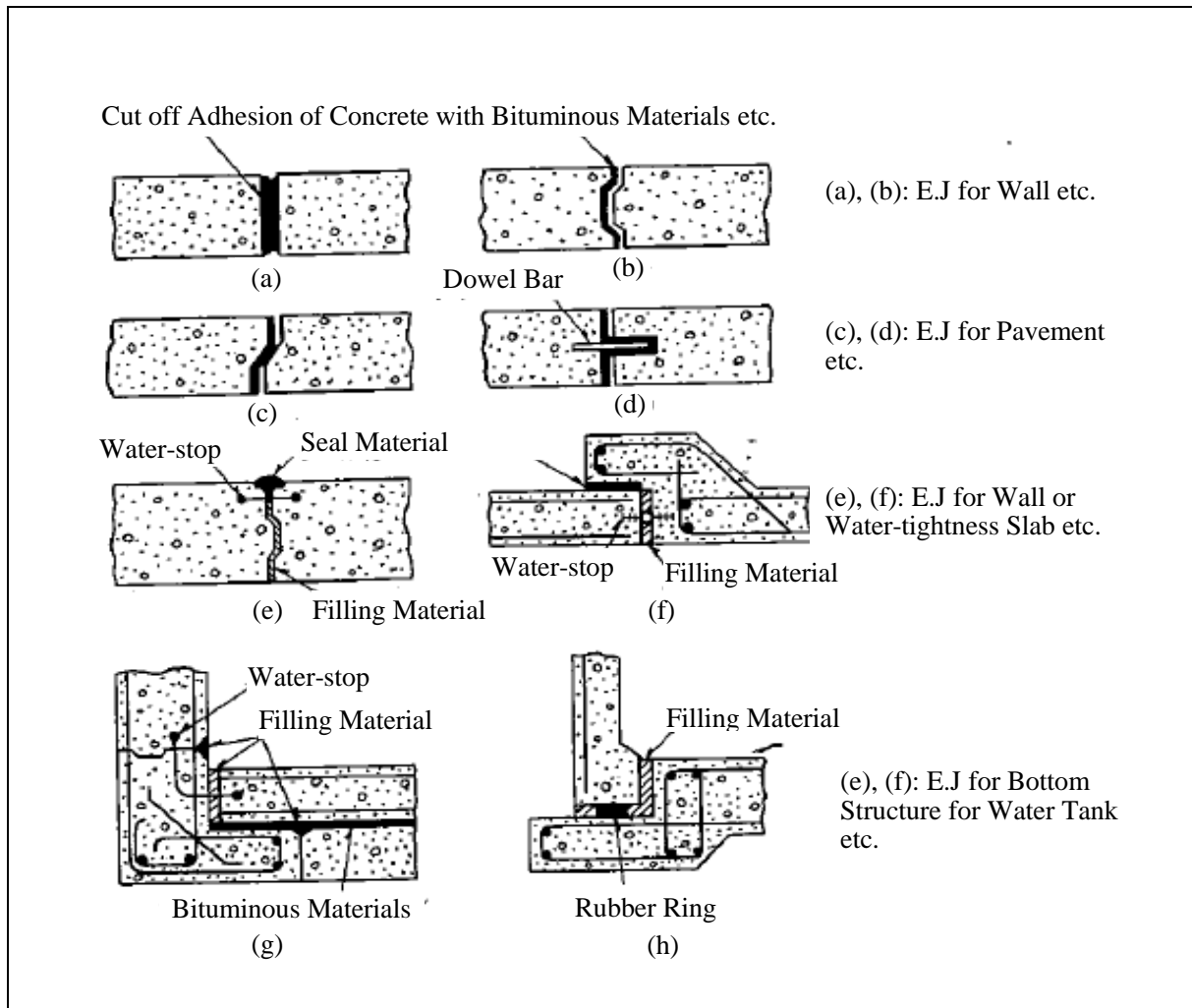

Figure 11.3-1 Types of Expansion Joint

11.4 Crack Induction Joint

The crack induction joint is a joint that is planned and installed in order to generate cracks at predetermined positions. Generally, it is preferable that the joint interval is about 1-2 times the concrete member height and the sectional defect rate is 20% or more. Examples of crack induction joint are shown in Figure 11.4-1.

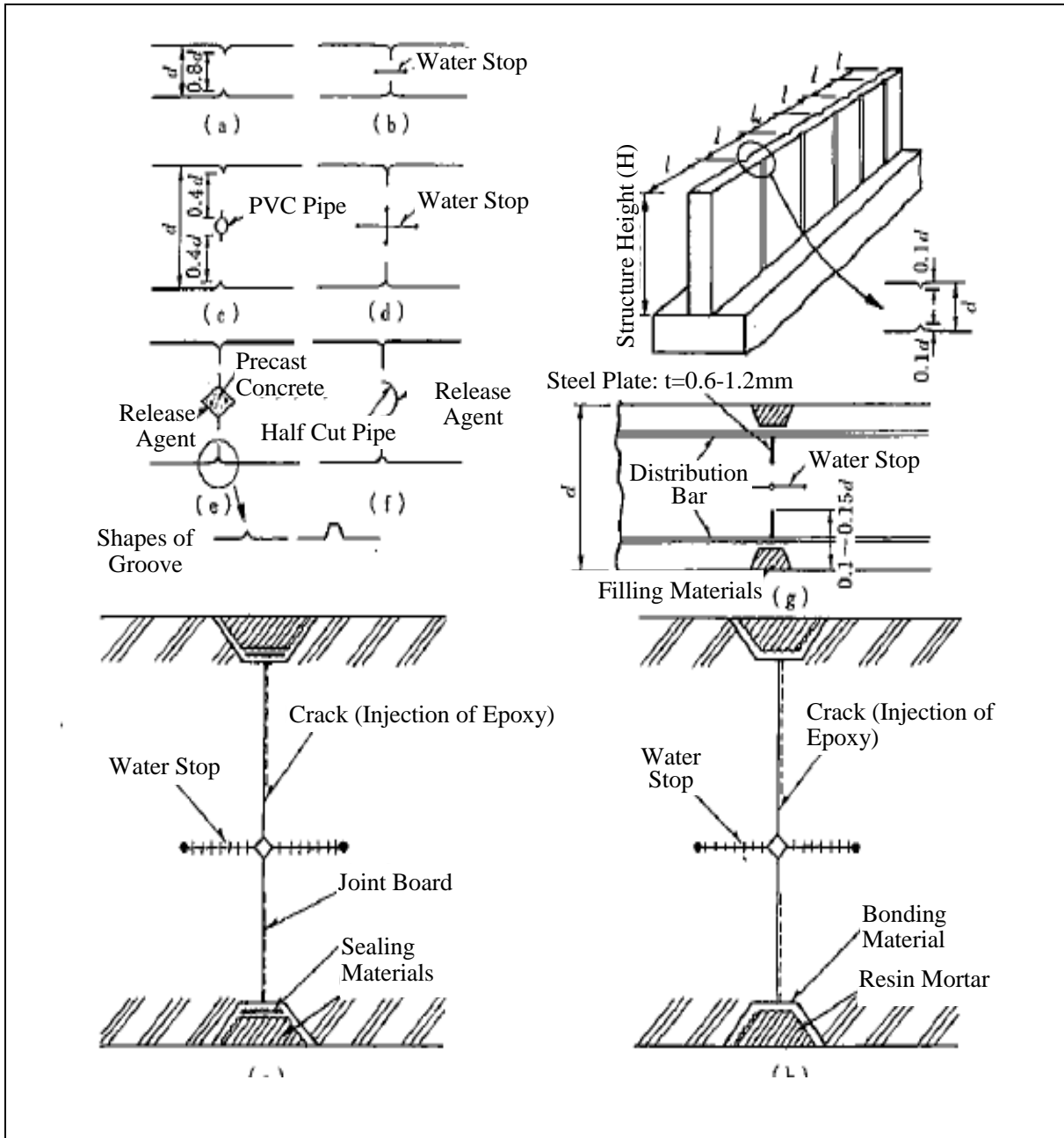





Figure 11.4-1 Examples of Crack Induction Joint

CHAPTER 12. REMEDIAL WORK

12.1 Defects of Concrete Structure

In concrete construction, a shortage of the workability of fresh concrete, poor material, insufficient consolidation, unsustainable pouring etc. may result in insufficient filling, honeycomb and cold joint. Such defects have a significant impact on concrete structures such as poor strength and durability.

If insufficient filling, honeycomb or cold joint is found out after pouring concrete, site engineer should plan and carry out the appropriate remedial work based on the level of the defects as soon as possible. The examples of defects are shown in below.

		
Figure 12.1-1 Insufficient Filling	Figure 12.1-2 Honeycomb	Figure 12.1-3 Insufficient Filling



12.1.1. Defect Levels of Insufficient Filling



Most case of defect of insufficient filling, this will be fatal defect because area is large and depth is deep. Defect level must be considered the equivalent to Level D or E of Level of Honeycomb described in the following part.

12.1.2. Defect Levels of Honeycomb

Japan Concrete Institute stipulates the levels of defect as follows.

Table 12.1-1 Classification of Defect Levels

Defect Level		Image
A	Aggregates don't appear on the surface (Soundness)	None
B	A state in which aggregates are exposed on the concrete surface, but those do not peel off even if aggregates are hit by hammer. (Approx. depth is 1cm to 3cm)	
C	A state in which aggregates are exposed and aggregates peel off when hit by hammer. (Approx. depth is 1 cm to 3 cm)	

Defect Level		Image
D	In a state where rebar is exposed and aggregate is peeled off. (Approx. depth is 3 cm to 10 cm)	
E	In the state the cavity is appeared, and it proceeds in the back when aggregates are hit by hammer. This level is obviously fatal error of pouring concrete.	 Depth is deeper than Level D (more than 10 cm)

12.2 Remedial Method

- Insufficient filling and Honeycomb

As explained in above, defect of insufficient filling is considered equivalent to defect level of D or E in Honeycomb. The recommended remedial method is shown in bellow.

Defect Level / Remedial Method	
B	Take out the defective part such as loose aggregates and unsuitable cement etc., apply polymer cement paste or bonding agent, then fill polymer cement. It is recommended that you use hammer and chisel for taking out the unsuitable materials. If polymer cement is difficult to prepare, non-shrinkage mortar can apply.
C	Take out the defective part such as loose aggregates and unsuitable cement etc., apply the bonding agent, then fill the non-shrinkage mortar. It is recommended that you use hammer and chisel for taking out the unsuitable materials.
D	Take out the defective part such as loose aggregates and unsuitable cement etc., replace the same or higher strength of concrete. If rebar was rusty, cleaning of rebar would be carried out. It is recommended that you use electric chisel for taking out the unsuitable materials.
E	Take out the defective part such as loose aggregates and unsuitable cement etc., replace the same or higher strength of concrete. If rebar was rusty, cleaning of rebar would be carried out. It is recommended that you use electric chisel for taking out the unsuitable materials. In case the unsuitable materials not be taken out properly because defect portion is large area and deep, engineer must consider breaking out the entire defected structure, and re-constructing structure.

Appendices

Appendix 1 _ American Concrete Institute Method of Mix Design (ACI–211.1)

This method of proportioning was first published in 1944 by ACI committee 613.

- In 1954 the method was revised to include, among other modifications, the use of entrained air.
- In 1970, the method of mix design became the responsibility of ACI committee 211.
- ACI committee 211 have further updated the method of 1991.
- Almost all of the major multipurpose concrete dams in India built during 1950 have been designed by using then prevalent ACI Committee method of mix design.

(i) Step 01: Data to be collected

Fineness modulus of selected F.A.

- Unit weight of dry rodded coarse aggregate.
- Sp. gravity of coarse and fine aggregates in SSD condition
- Absorption characteristics of both coarse and fine aggregates.
- Specific gravity of cement.

Example:



- Design a concrete mix for construction of an elevated water tank.
- The specified design strength of concrete is 30 MPa at 28 days measured on standard cylinders.
- The specific gravity of FA and C.A. are 2.65 and 2.7 respectively.
- The dry rodded bulk density of C.A. is 1600 kg/m³, and fineness modulus of FA is 2.80.
- Ordinary Portland cement (Type I) will be used.
- C.A. is found to be absorptive to the extent of 1% and free surface moisture in sand is found to be 2 percent.

(ii) Step 02: Target Mean Strength

Target Mean Strength $f_m = f_{min} + ks$

$$f_m = f_{min} + ks$$

$$f_m = 30 + 1.65 \times 4.2$$

$$f_m = 36.93 \text{ MPa}$$

Placing and Mixing Condition	Degree of Control	Standard Deviation (MPa)
Dried aggregates, completely accurate grading, exact water/ cement ration, controlled temperature curing.	Laboratory Precision	1.3
Weigh-batching of all materials, control of aggregate grading, 3 sizes of aggregate plus sand, control of water added to allow for moisture content of aggregates, allowance for weight of aggregate and sand displaced by water, continual supervision.	Excellent	2.8
Weigh-batching of all materials, strict control of aggregate grading, control of water added to allow for moisture content of aggregates, continual supervision.	High	3.5
Weigh-batching of all materials, control of aggregate grading, control of water added, frequent supervision.	Very Good	4.2
Weighing of all materials, water content controlled by inspection of mix, periodic check of workability, use of two sizes of aggregate (fine & coarse) only, intermittent supervision.	Good	5.7
Volume batching of all aggregates allowing for bulking of sand, weigh batching of cement, water content controlled by inspection of mix, intermittent supervision.	Fair	6.5
Volume batching of all materials, use of all in aggregate, little or no supervision.	Poor Uncontrolled	7.0 8.5

(iii) Step 03: Water/cement ratio

- Find the water/cement ratio from the strength point of view from Table (1).
- Find also the water/ cement ratio from durability point of view from Table (2).
- Adopt lower value out of strength consideration and durability consideration.
- Since OPC is used, from table (1), the estimated w/c ratio is 0.47.
- From exposure condition Table (2), the maximum w/c ratio is 0.50
- Therefore, adopt w/c ratio of 0.47

Table (1) Relation between Water/ Cement Ratio and Average Compressive Strength of Concrete, according to ACI 211.1-91

Average Compressive Strength at (28) days (MPa)	Effective Water/ Cement Ratio (by mass)	
	Non-Air Entrained Concrete	Air-entrained Concrete
45	0.38	-
40	0.43	-
35	0.48	0.40
30	0.55	0.46
25	0.62	0.53
20	0.70	0.61
15	0.80	0.71

Table (2) Requirements of ACI 318-89 for W/C Ratio and Strength for Special Exposure Conditions

Exposure Condition	Maximum W/C Ratio, Normal Density Aggregate Concrete	Minimum Design Strength, Low Density Aggregate Concrete (MPa)
I. Concrete intended to be watertight	0.5	25
a. Exposed to fresh water	0.45	30
b. Exposed to brackish or sea water		
II. Concrete exposed to freezing and thawing in a moist condition:		
a. Kerbs, gutters, guard rails or thin sections	0.45	30
b. Other elements	0.50	25
c. In presence of de-icing chemicals	0.45	30
III. For corrosion protection of reinforced concrete exposed to de-icing salts, brackish water, sea water or spray from those sources	0.4	33

(iv) Step 04: Maximum Size of Aggregate & Workability

- Decide maximum size of aggregate to be used. Generally, for RCC work 20 mm and prestressed concrete 10 mm size are used.
- Decide workability in terms of slump for the type of job in hand. General guidance can be taken from table (3).
- Maximum size of aggregate 20 mm.
- Slump of concrete 50 mm

Table (3) General Guidance

Type of Construction	Range of Slump (mm)
Reinforced foundation walls and footings	20-80
Plain footings, caissons and substructure walls	20-80
Beams and reinforced walls	20-100
Building Columns	20-100
Pavements and slabs	20-80
Mass Concrete	20-80

(v) Step 05: Cement Content

From Table (4), for a slump of 50 mm, 20 mm maximum size of aggregate, for non-air- entrained concrete,

the mixing water content is 185 kg/m³ of concrete. Also, the approximate entrapped air content is 2 percent.

$$\text{Cement Content} = 185 / 0.47$$

$$\text{Cement Content} = 394.0 \text{ kg/m}^3$$

Table (4) Approximate Requirements for Mixing Water and Air Content for Different Workabilities and Nominal Maximum Size of Aggregates according to ACI 211.1-91

Workability or Air Content	Water Content, Kg/ m ³ of Concrete for Indicated Maximum Aggregate Size							
	10 mm	12.5 mm	20 mm	25 mm	40 mm	50 mm	70 mm	150 mm
Non-air-entrained Concrete								
Slump								
30-50 mm	205	200	185	180	160	155	145	125
80-100 mm	225	215	200	195	175	170	160	140
150-180 mm	240	230	210	205	185	180	170	-
Approximate entrapped air content percent	3	2.5	2	1.5	1	0.5	0.3	0.2
Air-entrained Concrete								
Slump								
30-50 mm	180	175	165	160	145	140	135	120
80-100 mm	200	190	180	175	160	155	150	135
150-180 mm	215	205	190	185	170	165	160	-
Recommended average total air content percent								
Mild exposure	4.5	4.0	3.5	3.0	2.5	2.0	1.5	1.0
Moderate exposure	6.0	5.5	5.0	4.5	4.5	4.0	3.5	3.0
Extreme exposure	7.5	7.0	6.0	6.0	5.5	5.0	4.5	4.0

(vi) Step 06: Weight of Coarse Aggregate

- From table (5), the bulk volume of dry rodded coarse aggregate per unit volume of concrete is selected, for the particular maximum size of coarse aggregate and fineness modulus of fine aggregate.
- The weight of C.A. per cubic meter of concrete is calculated by multiplying the bulk volume with bulk density.
- From Table (5), for 20 mm coarse aggregate, for fineness modulus of 2.80, the dry rodded bulk volume of C.A. is 0.62 per unit volume of concrete.
- The weight of C. A.=0.62 x 1600= 992.0 kg/ m³

**Table (5) Dry Bulk Volume of Coarse Aggregate per Unit Volume of Concrete as given by
ACI 211.1-91**

Maximum Size of Aggregate	Bulk Volume of Dry Rodded Coarse Aggregate per Unit Volume of Concrete for Fineness Modulus of Sand of			
F.M.	2.40	2.60	2.80	3.00
10	0.50	0.48	0.46	0.44
12.5	0.59	0.57	0.55	0.53
20	0.66	0.64	0.62	0.60
25	0.71	0.69	0.67	0.65
40	0.75	0.73	0.71	0.69
50	0.78	0.76	0.74	0.72
70	0.82	0.80	0.78	0.76
150	0.87	0.85	0.83	0.81

(vii) Step 07: Weight of Fine Aggregate

- From Table (6), the first estimate of density of fresh concrete for 20 mm maximum size of aggregate and for non-air-entrained concrete = 2355 kg/m³
- The weight of all the known ingredient of concrete
- Weight of water = 185 kg/m³
- Weight of cement = 394 kg/m³
- Weight of C.A. = 992 kg/m³
- Weight of F. A. = 2355 – (185 + 394 + 992) = 784.0kg/ m³

Table (6) First Estimate of Density (Unit Weight) of Fresh Concrete as given by ACI 211.1-91

Maximum Size of Aggregate (mm)	First Estimate of Density (Unit Weight) of Fresh Concrete	
	Non-air-entrained (kg/ m ³)	Air-entrained (kg/ m ³)
10	2285	2190
12.5	2315	2235
20	2355	2280
25	2375	2315
40	2420	2355
50	2445	2375
70	2465	2400
150	2505	2435

- From Table (6), the first estimate of density of fresh concrete for 20 mm maximum size of aggregate and for non-air-entrained concrete = 2355 kg/m³
- Alternatively, the weight of F.A. can also be found out by absolute volume method which is more accurate, as follows.

Tabulate the Absolute Volume of All the known Ingredients

Item No.	Ingredients	Weight (kg/m ³)	Absolute Volume (cm ³)
1	Cement	394	$\frac{394}{3.15} \times 10^3 = 125 \times 10^3$
2	Water	185	$\frac{185}{1} \times 10^3 = 185 \times 10^3$
3	Coarse Aggregate	992	$\frac{992}{2.7} \times 10^3 = 367 \times 10^3$
4	Air		$\frac{2}{100} \times 10^6 = 20 \times 10^3$

Item No.	Ingredients	Weight	Absolute Volume
1	Cement	From Step 5	$\frac{\text{Weight of Cement}}{\text{Sp. gravity of Cement}} \times 10^3 = \quad \times 10^3$
2	Water	From Step 4	$\frac{\text{Weight of Water}}{\text{Sp. gravity of Water}} \times 10^3 = \quad \times 10^3$
3	Coarse Aggregate	From Step 6	$\frac{\text{Weight of C.A.}}{\text{Sp. gravity of C.A.}} \times 10^3 = \quad \times 10^3$
4	Air	---	$\frac{\% \text{ of Air Voids}}{100} \times 10^6 = \quad \times 10^3$
Total Absolute Volume			=

Total absolute volume = $697.0 \times 10^3 \text{ cm}^3$

Therefore, absolute volume of F.A. = $(1000 - 697) \times 10^3$

$$= 303.0 \times 10^3$$

Weight of FA

$$= 303 \times 2.65$$

$$= 803.0 \text{ kg/m}^3$$

(viii) Step 08: Proportions

Ingredients	Cement	Fine Aggregate	Coarse Aggregate	Water	Chemical
Quantity (kg/ m ³)	394.0	803.0	992.0	185.0	NM
Ratio	1.00	2.04	2.52	0.47	NM
1 Bag Cement	50.0	102.0	126.0	23.5	NM

(ix) Step 09: Adjustment for Field Condition

- The proportions are required to be adjusted for the field conditions. Fine Aggregate has surface moisture of 2 %

$$\begin{aligned}\text{Weight of F. A.} &= 803.0 + \frac{2}{100} \times 803.0 \\ &= 819.06 \text{ kg/ m}^3\end{aligned}$$

- Course Aggregate absorbs 1% water

$$\begin{aligned}\text{Weight of C. A} &= 992.0 - \frac{1}{100} \times 992.0 \\ &= 982.0 \text{ kg/ m}^3\end{aligned}$$

(x) Step 10: Final Design Proportions

Ingredients	Cement	Fine Aggregate	Coarse Aggregate	Water	Chemical
Quantity (kg/ m ³)	394.0	819.0	982.0	185.0	NM
Ratio	1.00	2.08	2.49	0.47	NM
1 Bag Cement	50.0	104.0	124.5	23.5	NM

Appendix 2 _ Sample of Fixing Layout of the Facilities and Machine & Equipment

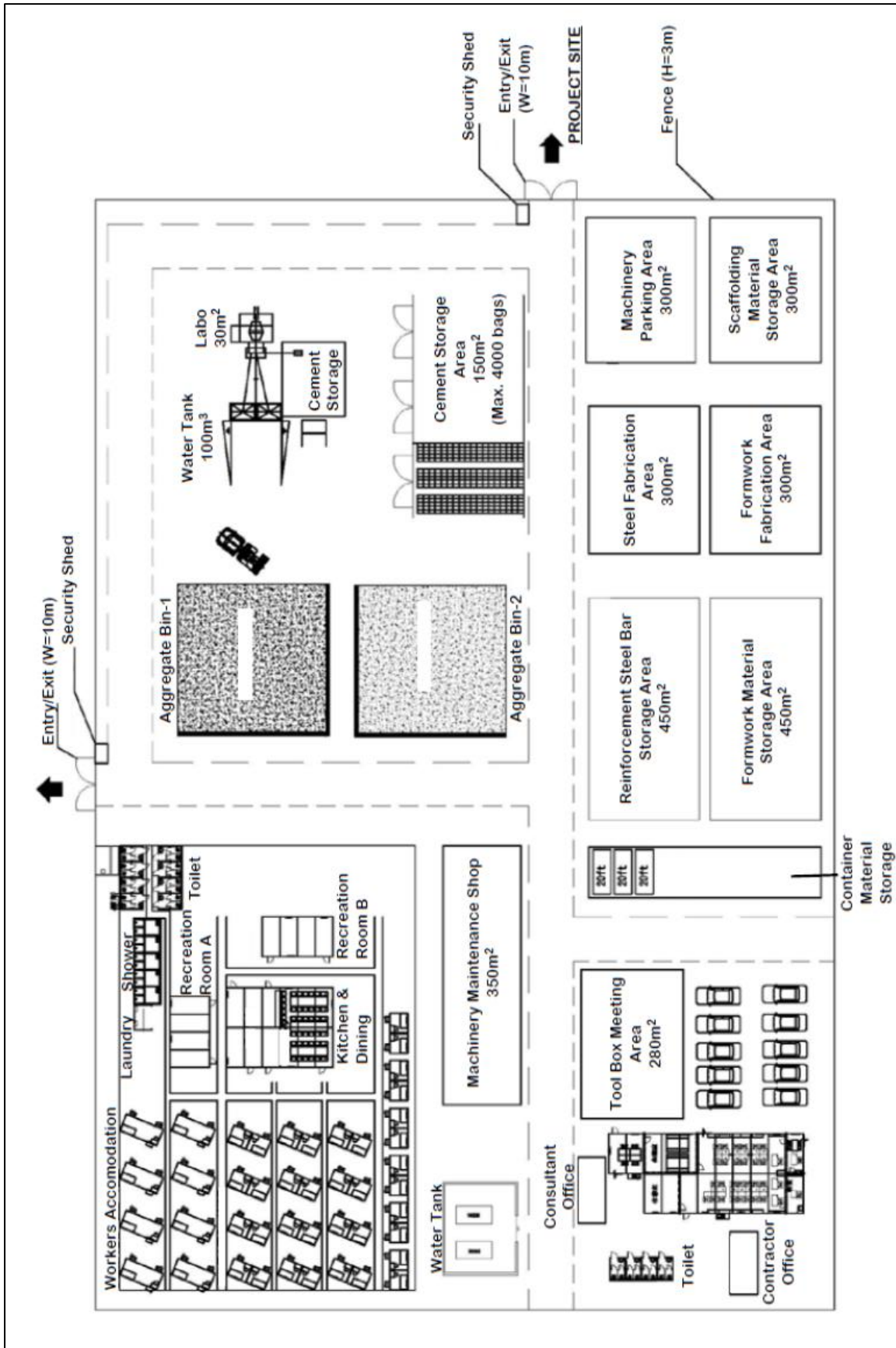

Appendix 3 - Calculation Manual of Formwork and Falsework

Structural Calculation for Formwork and False work

Since Formwork is a temporary structure until concrete reach to the predetermined strength, not only safety but also economic efficiency and workability are required.

Basically, arrangement of Formwork and Falsework used to depend on experiences of engineers or carpenters, but that based on the structural calculations, the Formwork must be planned as to confirm the safety and to be in a balanced and rational arrangement.

1. Formwork for Wall

Point 1-1: Calculation of Formwork for wall proceeds in accordance with sequence bellow.

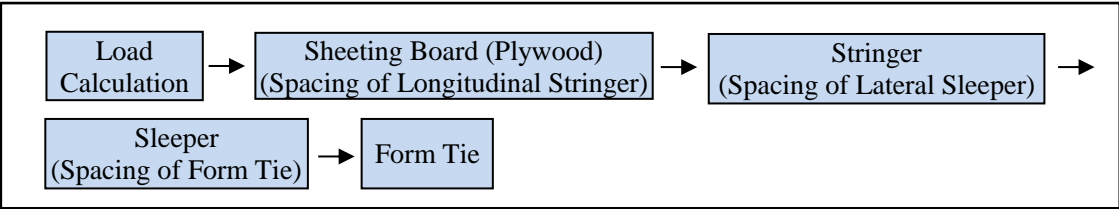

Note:

- Load considers only for lateral pressure by pouring concrete shown in Table (1).
- Allowable deflection of Formwork should be less than basically 0.3 cm (Allowable deflection should be less than 0.1 cm if accurate finishing is required)
- Plywood and Sleeper are calculated by simple span with uniformed load

(1) Members' Name for Formwork

- a: Sheeting board (Plywood)
- b: Stringer
- c: Separator
- d: Sleeper or Lumber Stringer
- e: Form tie

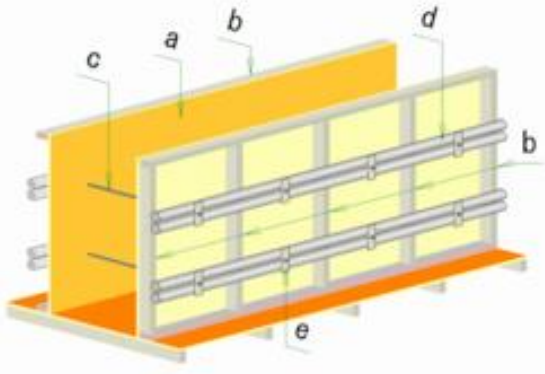

Table (1) Calculation Formula of Load (Lateral Load)

Slump	Slump ≤ 10 cm		Slump > 10 cm	
Wall	R < 2m/h	$\frac{W_o}{3} \left(1 + \frac{100R}{T+20} \right) \leq 100(\text{kN/m}^2)$ (or) $W_o H$	H ≤ 1.5m	W _o H
	R ≥ 2m/h	$\frac{W_o}{3} \left(1 + \frac{150+30R}{T+20} \right) \leq 100(\text{kN/m}^2)$ (or) W _o H	1.5 < H ≤ 4.0m	Length ≤ 3.0 m
				1.5W _o + 0.2 W _o (H - 1.5)
				Length > 3.0 m
				1.5 W _o

W_o (kN/m³) : Concrete Unit Weight (t/m³)

R (m/h) : Speed of Pouring

T (°C) : Temperature of Concrete

H (m) : Finishing Height of Pouring

1-1 The exercises for the calculation of wall Formwork

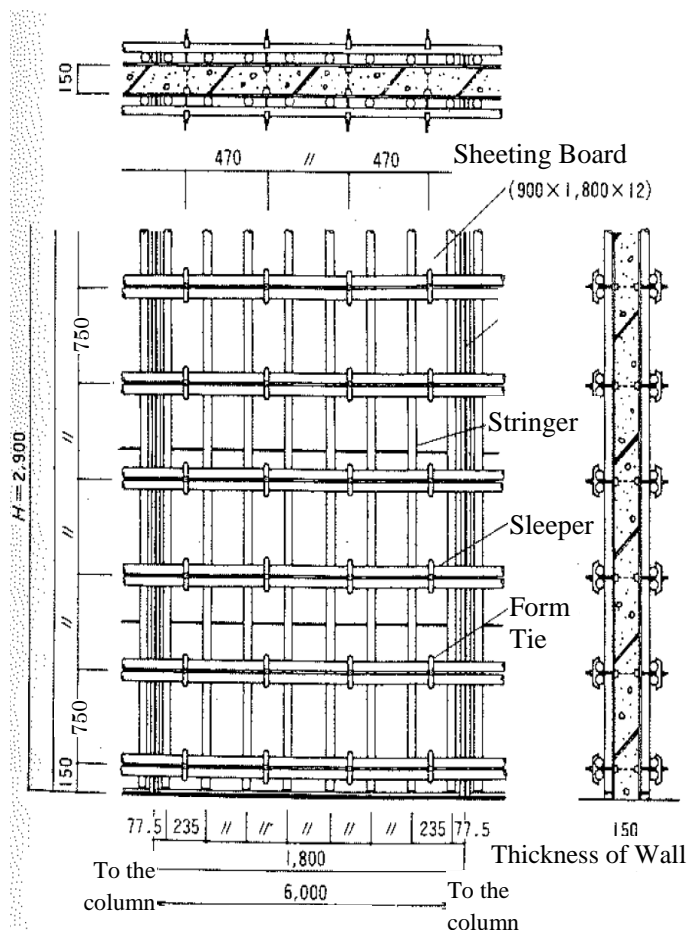

<Design Condition of Sample Model>

- Spacing of the Stringer : 23.5cm
- Spacing of the Sleeper : 50.0cm
- Spacing of Form tie : 47.0cm
- Wall height : 290 cm
- Wall thickness : 15.0cm
- Wall length : 600 cm

(2) Basic Load Calculation

Lateral load is calculated in accordance with Table (1).

1) Pouring Speed

The speed of pouring concrete is determined based on the concrete pouring plan and pouring method. Especially, it is necessary to pay attention that in case of poured by a concrete pump and puncture of the form frequently occurs when the pouring speed is about 10 m to 50 m/h.

As the condition of **concrete pouring speed is 10m/h** in this exercise.

Pouring volume of concrete is calculated to only 9 m³/h for the speed of 10m/h pouring in this exercise, wall length is 6m, thickness is 0.15 m and height is 2.9 m.

2) Finishing Height (Head of Fresh Concrete)

Finishing height (H) is 2.9m to calculate the maximum lateral load in the exercise.

3) Unit Weight of Fresh Concrete

Since applicable concrete for standard civil structure is Portland Cement Concrete basically,

unit weight concrete is applied 24kN/m³.

4) Length of the Wall

Length of the wall is 6m in this exercise.

Since the force factors for determining the maximum lateral pressure P of the concrete operating on the Formwork has been determined, the maximum lateral pressure is obtained from Table (1) .

Force factors for obtaining the maximum lateral pressure P in this exercise;

}	Pouring speed (R) : 10 m/h
	Finishing height (H) : 2.9 m
	Wall length : 6.0 m (Exceeding 3.0 m)

Thus, the formula of maximum lateral load is applied to “**1.5 W_o**”.

Maximum lateral load P = 1.5 x 24 kN/m³ = **36 kN/m²**

(3) Consideration of each members

1) Consideration of Sheeting board (Plywood)

Use the Plywood (t=1.2 cm) for Formwork instead of sheathing board in this exercise, also installation of plywood should be set up fiber direction of wood.

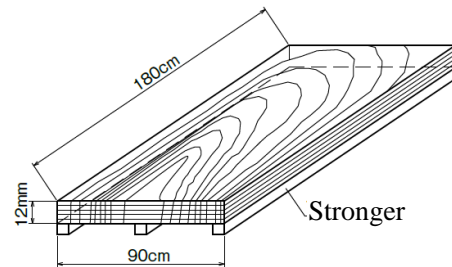
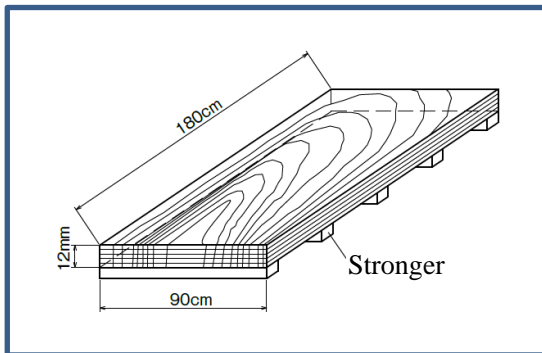

Allowable bending stress : fb = 1.37 kN/cm²
Elastic modulus : 550 kN/cm²

Note: If Plywood installs at right angle “B”, allowable bending stress decreases to about 60% and elastic modulus decreases to about 35%.

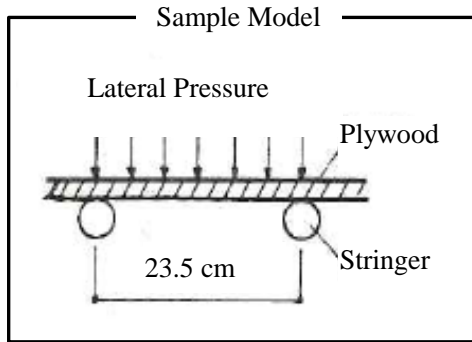

Since the Plywood is supported by the Stringer (longitudinal member), considering the Plywood means to consider whether the interval between the Stringer is appropriateness.

Consideration of operating force against to plywood carried out as a simple beam (width $b = 1.0$ cm, height $h = 1.2$ cm beam) with uniformed load operates.

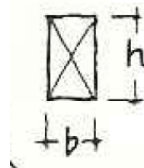
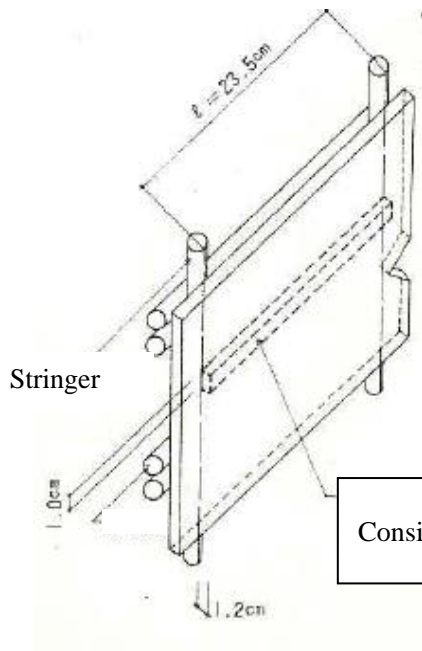

Moment of Inertia of Section : $I = \frac{bh^3}{12}$

Section Modulus : $Z = \frac{bh^2}{6}$

Consider as beam which dimensions are 1.0 cm x 1.2 cm

From above mentioned formula,

the sectional performance when considering the Plywood as a beam is;

$$\left\{ \begin{array}{l} I = \frac{bh^3}{12} = \frac{1.0 \times (1.2)^3}{12} = 0.144 \text{ cm}^4 \\ Z = \frac{bh^2}{6} = \frac{1.0 \times (1.2)^2}{6} = 0.24 \text{ cm}^3 \end{array} \right.$$

A) Calculation of the Load

The maximum lateral load was calculated as 36 kN/m^2 , thus the load (w) which operates to the unit width of Plywood is;

$$W = 36 \text{ kN/m}^2 (0.0036 \text{ kN/cm}^2) \times 1.0 \text{ cm} = 0.0036 \text{ kN/cm}$$

B) Consideration on Bending

The maximum bending moment (M_{max}) is obtained from the following equation.

$$M_{\text{max}} = \frac{1}{8} w l^2 = \frac{1}{8} \times 0.0036 \text{ kN/cm} \times (23.5 \text{ cm})^2$$

$$= \boxed{0.249 \text{ kN} \cdot \text{cm}}$$

From this maximum bending moment, the stress intensity (σ_b) operates to the beam is calculated from the following equation.

$$\sigma_b = \frac{M_{max}}{Z} = \frac{0,249kN \cdot cm}{0.24 cm^3} = \boxed{1.04 \text{ kN/cm}^2}$$

From this bending stress intensity, it is compared with the allowable bending stress intensity (f_b) of the Plywood.

$$\frac{\sigma_b}{f_b} = \frac{1.04 \text{ kN/cm}^2}{1.37kN/cm^2} = \boxed{0.76 \leq 1.0 \text{ OK!}}$$

1) Consideration on Deflection

Although the allowable deflection differs depending on the part of the structure and the type of finishing, since it is generally standardized about 0.3 cm, in this exercise it is calculated as 0.3 cm.

Deflection is calculated as a simple beam on which the uniformed load operates from the following equation.

$$\begin{aligned} \delta_{max} &= \frac{5wl^4}{384EI} \quad E: \text{Elastic Modules} \\ &= \frac{5 \times 0.0036kN/cm \times (23.5cm)^4}{384 \times 550kN/cm^2 \times 0.114 cm^4} \\ &= 0.23 \text{ cm} \leq 0.3 \text{ cm} \quad \text{OK!} \end{aligned}$$

Reference

The reason for considering it as a simple beam rather than a continuous beam is to take into account the number of reuses of the Plywood.

- Comparison of maximum bending moment between simple beam and continuous beam

- Simple beam: $M_{max} = \frac{1}{8} wl^2$

- Continuous beam: $M_{max} = \frac{1}{10} wl^2$

$$M_s / M_c = 1.25$$

- Comparison of maximum deflection between Simple beam and continuous beam

Simple beam: $\delta_{max} = \frac{5wl^4}{384EI}$

Continuous beam: $\delta_{max} = \frac{wl^4}{128EI}$

$$\delta_s / \delta_c = 1.67$$

Since the Formwork is reused several times, it is necessary to consider the damage. Therefore, it should be calculated as a simple beam even though the actual arrangement is a continuous beam for safe side.

(4) Consideration of Stringer

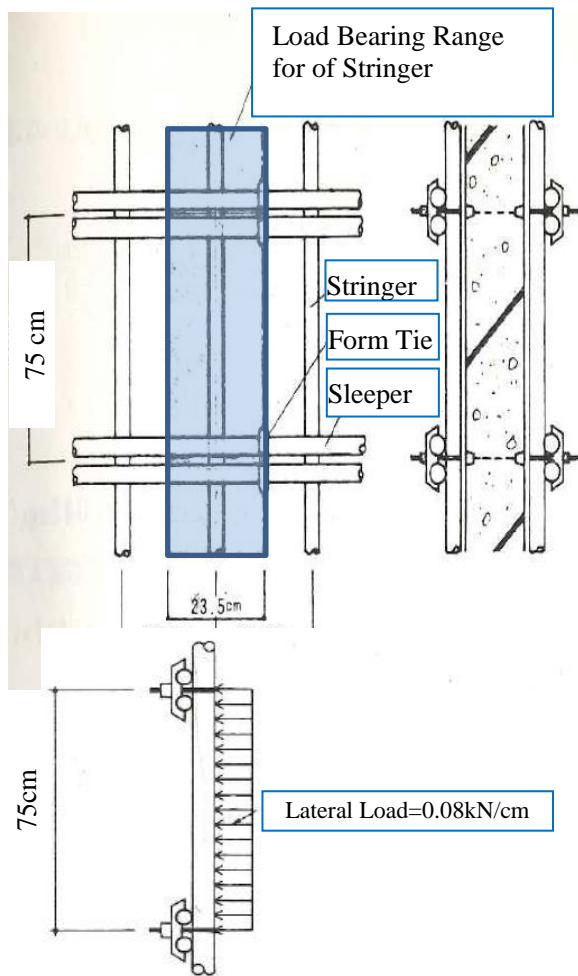

Steel pipe $\varnothing 48.6 \times 2.4$ (Standard pipe for temporary works) is used for Stringer in this exercise.

Moment of inertia of section: I	=	9.32 cm ⁴
Section Modulus: Z	=	3.83 cm ³
Allowable bending stress: fb	=	23.7 kN/cm ²
Elastic Modulus: E	=	2.1x10 ⁴

To confirm the strength of Stringers means to consider the spacing of Sleepers.

It is suggested that the consideration of spacing of Stringers applies to simple beam in the same as the calculation of the Plywood.

Spacing of Sleepers is 75cm in this exercise.

Working load (w) to Stringer is;

$$w = 0.0036 \text{ kN/cm}^2 \times 23.5 \text{ cm} = 0.08 \text{ kN/cm}$$

Lateral Load

Spacing

B) Bending Consideration

The maximum bending moment (M max) is obtained from the following equation.

Bending consideration is carried out by equation of the maximum bending moment as follows

$$M_{\max} = \frac{1}{8} w l^2$$

$$M_{\max} = \frac{1}{8} \times (0.08 \text{ kN/cm} \times (75 \text{ cm})^2) = \boxed{56.25 \text{ kN} \cdot \text{cm}}$$

From this maximum bending moment, the stress intensity (σ_b) operates to the Stringer is calculated

$$\text{from the following equation. } \sigma_b = \frac{M_{\max}}{Z} = \frac{56.25 \text{ kN} \cdot \text{cm}}{3.83 \text{ cm}^3} = \boxed{14.69 \text{ kN/cm}^2}$$

From this bending stress intensity, it is compared with the allowable bending stress intensity (fb) of the steel pipe.

$$\frac{\sigma_b}{f_b} = \frac{14.69 \text{ kN/cm}^2}{23.70 \text{ kN/cm}^2} = \boxed{0.62 \leq 1.0 \text{ OK!}}$$

C) Consideration on Deflection

Allowable deflection differs should be within 0.3cm same as Plywood. Deflection is calculated as a simple beam on which uniformed load operates from the following equation.

$$\delta_{max} = \frac{5wl^4}{384EI}$$

E: Elastic Modulus

$$= \frac{5 \times 0.08\text{kN/cm} \times (75.0\text{cm})^4}{384 \times 2.1 \times (10)^4 \text{ kN/cm}^2 \times 9.32 \text{ cm}^4}$$

$$= \boxed{0.17\text{cm} \leq 0.3\text{cm OK!}}$$

(5) Consideration of Sleeper

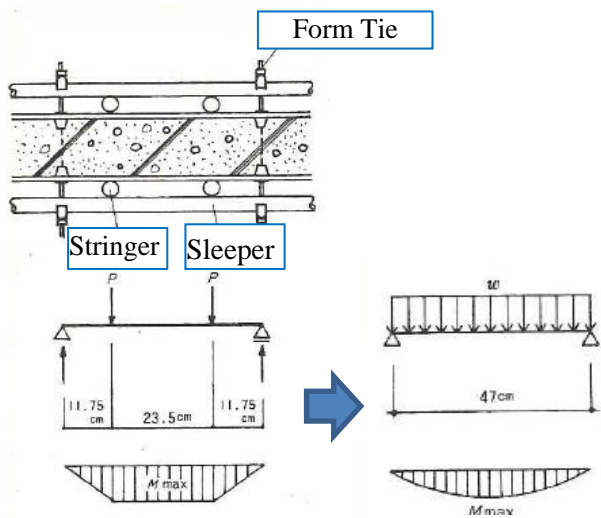

Two numbers of Steel pipe Ø48.6 x 2.4 (Standard pipe for temporary works) are used for Sleeper in this exercise.

Moment of inertia of section:	I = 9.32 cm ⁴
Section Modulus:	Z = 3.83 cm ³
Allowable bending stress:	f _b = 23.7 kN/cm ²
Elastic Modulus:	E = 2.1 × 10 ⁴ kN/cm ²

This case supposes as the simple beam operating the uniform load

The load operates to the Sleeper which is transferred from Stringers. To confirm the strength of Stringers means to consider the spacing of Stringers.

It is suggested that the consideration of spacing of Sleepers applies to simple beam as well. The load

which is shared by Sleepers considers the area defined from spacing of Stringer.

Span for Sleepers means the spacing of form tie, therefore this is 47 cm in this exercise.

The lateral load operates

Bending and deflection of Sleeper are considered in accordance with the given condition by the same method as consideration of Plywood and Stringer.

A) Calculation of Load

Working load (w) to Sleeper is;

$$w = 0.0036 \text{ kN/cm}^2 \times 75.0 \text{ cm} = 0.27 \text{ kN/cm}$$

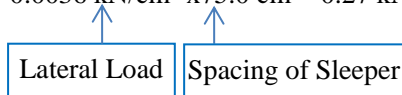

B) Bending Consideration

The maximum bending moment (M max) is obtained from the following equation.

Bending consideration is carried out by equation of the maximum bending moment as follows

$$M_{max} = \frac{1}{8} w l^2$$

$$M_{max} = \frac{1}{8} \times (0.27 \text{ kN/cm} \times (47 \text{ cm})^2)$$

$$= \boxed{69.03 \text{ kN} \cdot \text{cm}}$$

$$\sigma_b = \frac{M_{max}}{Z} = \frac{69.03 \text{ kNcm}}{2 \times 3.83 \text{ cm}^3} = \boxed{9.01 \text{ kN/cm}^2}$$

Numbers of Steel Pipe

$$\frac{\sigma_b}{f_b} = \frac{9.01 \text{ kN/cm}^2}{23.70 \text{ kN/cm}^2} = \boxed{0.38 \leq 1.0 \text{ OK!}}$$

C) Consideration on deflection

$$\delta_{max} = \frac{5 w l^4}{384 E I} = \frac{5 \times 0.27 \text{ kN/cm} \times (47.0 \text{ cm})^4}{384 \times 2.1 \times (10)^6 \text{ kN/cm}^2 \times 9.32 \text{ cm}^4 \times 2}$$

Numbers of Steel Pipe

$$= \boxed{0.002 \text{ cm} \leq 0.3 \text{ cm OK!}}$$

(6) Consideration of Form Tie

Form tie which size is w5/16 in. (7.8mm) plans to apply in this exercise.

Allowable tensile strength: $F_t = 13.7 \text{ kN/pic.}$

Tensile strength operates lateral load of concrete on which area is shown on left figures to a Form tie.

Therefore, tensile strength operates (T) to a Form tie is,

$$A = (23.5 \text{ cm} + 23.5 \text{ cm}) \times (35.0 \text{ cm} + 35.0 \text{ cm}) = 3,290 \text{ cm}^2$$

$$T = 0.0036 \text{ kN/cm}^2 \times 3,290 \text{ cm}^2 = 11.84 \text{ kN}$$

Lateral Load

$$\frac{T}{F_t} = \frac{11.84 \text{ kN}}{13.70 \text{ kN}} = \boxed{0.86 \leq 1.0 \text{ OK!}}$$

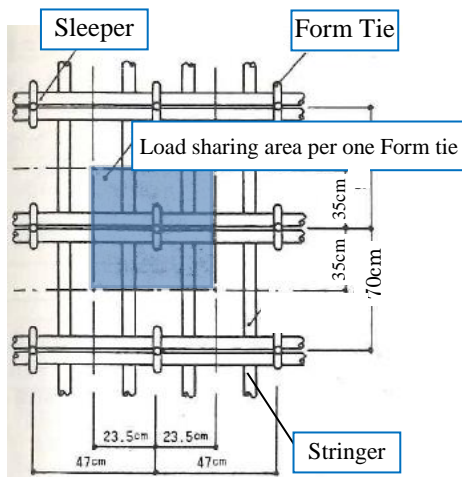

Mechanical performance of Form Tie

Size or Kinds	Effective Area	Tensile broken out Strength	Allowable Tensile Strength
W 5/16	34.0 mm ²	19.6 kN/Nos.	13.7 kN/Nos.
W 3/8	50.3 mm ²	29.4 kN/Nos.	20.6 kN/Nos.
W 1/2	89.4 mm ²	39.2 kg/Nos.	34.3 kN/Nos.

Note: The method of Consideration of Formwork for Columns is carried out as the same sequence of Formworks of Wall.

2. Formwork for Slab and Falsework

Point 2-1: Calculation of Formwork for slab and false work proceeds in accordance with bellow sequence.

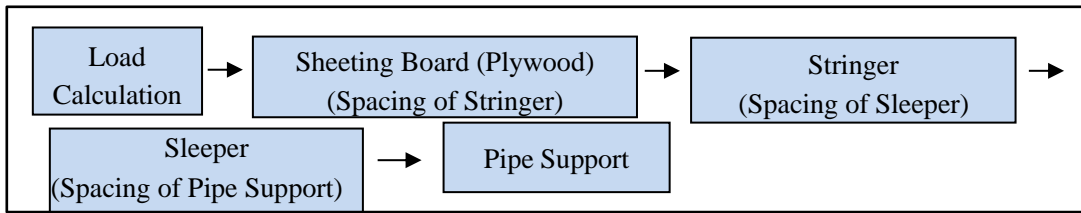

Note:

- Load considers main load (concrete and material of Formwork), impact load and vertical load of Working road (the weight of workers and necessary equipment on the Formwork). The lateral load operate to Falsework considers in the calculation of Falsework.
- Impact load is applied 50% of main load, working load is applied 1.5 kN/m^2 .
- Allowable deflection of Formwork should be less than basically 0.3 cm (Allowable deflection should be less than 0.1 cm if accurate finishing is required)
- Plywood and Sleeper are calculated by the simple span with unformed load

2-1 The exercises for the consideration of Slab Formwork and Falsework

Slab Formwork and Falsework is considered by sample model mentioned in below in this exercise.

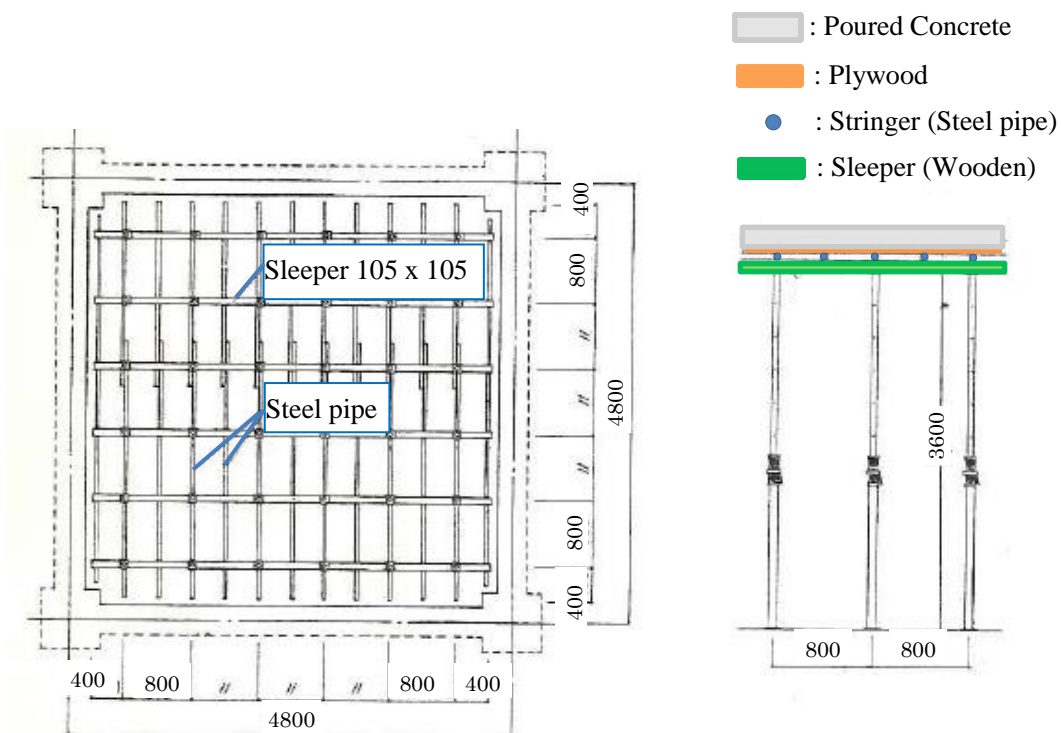

<Design Condition of Sample Model>

Spacing of the Stringer : 40.0 cm Spacing of the Sleeper : 80.0 cm
 Spacing of Pipe support : 80.0 cm Spacing of Column : 4,800 cm
 Height : 3,600 cm Slab thickness : 12.0 cm

(1) Calculation of Design Load operated to Formwork

The design load operated to Formwork should be calculated by below equation.

$$W = \gamma t + 0.5\gamma t + 1.5 \text{ kN/cm}^2$$

Main Load

Impact Load

Working Load

$$= 1.5\gamma t + 1.5 \text{ kN/cm}^2$$

$\left\{ \begin{array}{l} \gamma : \text{Unit weight of reinforcement concrete (24 kN/m}^3) \\ t : \text{Thickness of slab (m)} \end{array} \right.$

Unit weight of reinforcement concrete is 24 kN/m³, thickness of slab is 12 cm in this exercise, so design load is,

$$W = 1.5 \times 24 \text{ kN/m}^3 \times 0.12 \text{ m} + 1.5 \text{ kN/m}^2$$

$$= 5.8 \text{ kN/m}^2$$

(2) Consideration of Each Members

1) Consideration of Plywood

Plywood (t=1.2 cm) is used for Formwork in this exercise.

Section performance of Plywood

Moment of inertia of section: $I = 0.144 \text{ cm}^4$	}	Value is per unit width (1 cm)
Section Modulus: $Z = 0.24 \text{ cm}^3$		
Allowable bending stress: $f_b = 1.37 \text{ kN/cm}^2$		
Elastic Modulus: $E = 550 \text{ kN/cm}^2$		

Sample Model

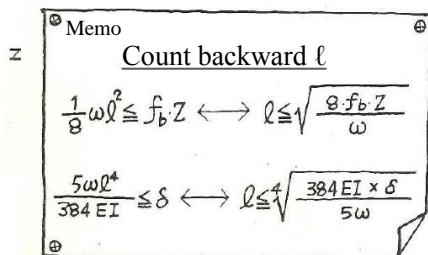

Next step proceeds to consider of bending and deflection for plywood. In case of consideration those in wall Formwork, the spacing of stringer has assumed and considered whether this assumed spacing is appropriateness. However, in this case (slab Formwork), firstly maximum stringer spacing calculates from allowable value, and compares the stringer spacing of sample model.

The load (w) is 5.8 kN/m² so as calculated in above. On the other hand, the consideration width of plywood is 1cm, therefore adapted load (w) is **0.00058 kN/cm²**.

A) Consideration of Bending

The equation of maximum Bending moment of simple beam which operates uniform load is M max. = 1/8wl², so the formula of maximum spacing is,

$$M_{\max} = \frac{1}{8}wl^2 \leq f_b \cdot Z$$

Thus,

$$l = \sqrt{\frac{8 \times f_b \cdot Z}{w}} = l = \sqrt{\frac{8 \times 1.37 \text{ kN/cm}^2 \times 0.24 \text{ cm}^3}{0.00058 \text{ kN/cm}^2}} = \boxed{67.3 \text{ cm} \geq 40.0 \text{ cm OK!}}$$

↑
Assumed Stringer Spacing

B) Consideration of Deflection

Deflection should be within 0.3 cm the same as wall structure.

Stringer spacing with maximum deflection within 0.3m is considered by below formula.

$$\delta_{\max} = \frac{5wl^4}{384EI} \leq 0.3$$

$$l = \sqrt[4]{\frac{384EI \times 0.3 \text{ cm}}{5w}}$$

$$= \sqrt[4]{\frac{384 \times 550 \text{ kN/cm}^2 \times 0.144 \text{ cm}^4 \times 0.3 \text{ cm}}{5 \times 0.00058 \text{ kN/cm}^2}} = \boxed{42.1 \text{ cm} \geq 40.0 \text{ cm OK!}}$$

Point 2-2

As slab is required accurate finishing, deflection should be within 0.1 mm mentioned in “Note” Chapter 2 first paragraph.

If accuracy is required, the maximum spacing of Stringer is calculated as follows;

$$l = \sqrt[4]{\frac{384EI \times 0.1 \text{ cm}}{5w}}$$

$$= \sqrt[4]{\frac{384 \times 550 \text{ kN/cm}^2 \times 0.144 \text{ cm}^4 \times 0.1 \text{ cm}}{5 \times 0.00058 \text{ kN/cm}^2}} = \boxed{32 \text{ cm}}$$

Image of Stringer Spacing
Considering Deflection Value

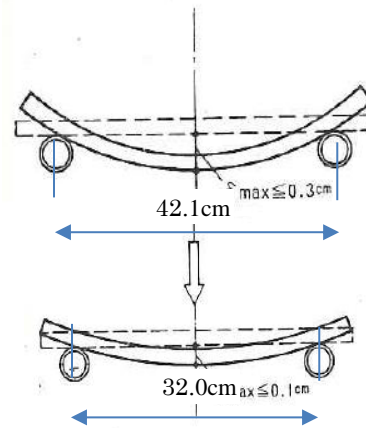

2) Consideration of Stringer

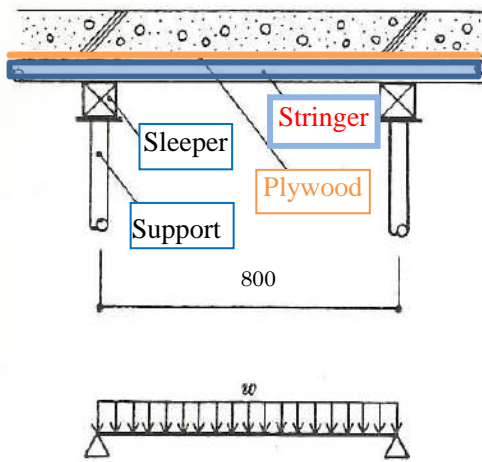

Steel pipe Ø48.6 x 2.4 (Standard pipe for temporary works) is used for Stringer in this exercise.

Moment of inertia of section:	I	$=9.32 \text{ cm}^4$
Section Modulus:	Z	$=3.83 \text{ cm}^3$
Allowable bending stress:	f_b	$=23.7 \text{ kN/cm}^2$
Elastic Modulus:	E	$=2.1 \times 10^4 \text{ kN/cm}^2$

Spacing of Stringer is 40 cm in this exercise, operating load (w) to Stringer is,

$$0.00058 \text{ kN/cm}^2 \times 40 \text{ cm} = \boxed{0.023 \text{ kN/cm}}$$

Stringer

A) Consideration of Bending

The maximum bending moment (M_{max}) is obtained from the following equation.

Bending consideration is carried out by equation of the maximum bending moment as follows

$$M_{max} = \frac{1}{8} w l^2$$

$$M_{max} = \frac{1}{8} \times (0.023 \text{ kN/cm} \times (80 \text{ cm})^2) = \boxed{18.56 \text{ kN}\cdot\text{cm}}$$

From this maximum bending moment, the stress intensity (σ_b) operates to the Stringer is calculated from the following equation.

$$\sigma_b = \frac{M_{max}}{Z} = \frac{18.56 \text{ kN}\cdot\text{cm}}{3.83 \text{ cm}^3} = \boxed{4.85 \text{ kN/cm}^2}$$

From this bending stress intensity, it is compared with the allowable bending stress intensity (f_b) of the steel pipe.

$$\frac{\sigma_b}{f_b} = \frac{4.85 \text{ kN/cm}^2}{23.70 \text{ kN/cm}^2} = \boxed{0.20 \leq 1.0 \text{ OK!}}$$

B) Consideration on Deflection

Allowable deflection differs should be within 0.3 cm same as Plywood.

Deflection is calculated as a simple beam on which uniformed load operates from the following equation.

$$\begin{aligned} \delta_{max} &= \frac{5wl^4}{384EI} \\ &= \frac{5 \times 0.023 \text{ kN/cm} \times (80.0 \text{ cm})^4}{384 \times 2.1 \times 10^4 \text{ kN/cm}^2 \times 9.32 \text{ cm}^4} \\ &= \boxed{0.06 \text{ cm} \leq 0.3 \text{ cm} \text{ OK!}} \end{aligned}$$

3) Consideration of Sleeper

Sectional Area:	A = 110.3 cm ²
Moment of inertia of section:	I = 1,012.9 cm ⁴
Section Modulus:	Z = 192.9 cm ³
Allowable bending stress:	fb = 1.03 kN/cm ²
Allowable shearing stress:	fs = 0.074 kN/cm ²
Elastic Modulus:	E = 700 kN/cm ²

Wooden batten 10.5 cm x 10.5 cm is used for Sleeper in this exercise.

Consideration of Sleeper is carried out adapting the simple beam same as previous consideration method.

In the consideration, spans except both edges are simple beam operating uniformed load and both edges are cantilever operating concentrated load.

A) Consideration of Simple Beam Spans Operating Uniformed Load

➤ Calculation of Load

Load (w) operates to Sleeper is,

$$w = 0.00058 \text{ kN/cm}^2 \times 80 \text{ cm} = \boxed{0.045 \text{ kN/cm}}$$

↑
Sleeper Spacing

➤ Consideration of Bending

$$M_{max} = \frac{1}{8}wl^2 = \frac{1}{8} \times (0.045 \text{ kN/cm} \times (80 \text{ cm})^2)$$

$$= 36.0 \text{ kN} \cdot \text{cm}$$

$$\sigma_b = \frac{M_{max}}{Z} = \frac{36.0 \text{ kN} \cdot \text{cm}}{192.9 \text{ cm}^3} = 0.187 \text{ kN/cm}^2$$

$$\frac{\sigma_b}{f_b} = \frac{0.187 \text{ kN/cm}^2}{1.03 \text{ kN/cm}^2} = 0.18 \leq 1.0 \text{ OK!}$$

➤ **Consideration of Shearing**

$$Q_{\max} = \frac{1}{2} w l$$

$$= \frac{1}{2} \times 0.045 \text{ kN/cm} \times 80 \text{ cm} = 1.80 \text{ kN}$$

$$\tau = \frac{\mathcal{K} Q_{\max}}{A} = \frac{1.5 \times 1.8 \text{ kN}}{110.3 \text{ cm}^2} = \boxed{0.024 \text{ kN/cm}^2}$$

Note: 1.5 is applied for \mathcal{K} , if the shape is rectangular.

$$\frac{\tau}{f_s} = \frac{0.024 \text{ kN/cm}^2}{0.074 \text{ kN/cm}^2} = \boxed{0.33 < 1.0 \text{ OK!}}$$

➤ **Consideration of Deflection**

$$\delta_{\max} = \frac{5 w l^4}{384 E I} = \frac{5 \times 0.045 \text{ kN/cm} \times (80.0 \text{ cm})^4}{384 \times 700 \text{ kN/cm}^2 \times 1,012.9 \text{ cm}^4}$$

$$= \boxed{0.033 \text{ cm} \leq 0.3 \text{ cm} \text{ OK!}}$$

B) Consideration of Cantilever Spans Operating Concentrated Load

Edge of Sleeper should be considered as cantilever with operating concentrated load.

Spacing of Sleepers are 40cm in this exercise.

➤ **Calculation of Load**

Concentrated load (P) operates to one Sleeper.

$$\text{Thus, } P = 0.00058 \text{ kN/cm}^2 \times 40 \text{ cm} \times 80 \text{ cm} = \boxed{1.86 \text{ kN}}$$

Span of Stringer

Sleeper Spacing

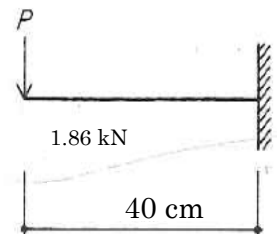

➤ **Consideration of Bending**

$$M_{\max} = P l = 1.86 \text{ kN} \times 40 \text{ cm} = \boxed{74.4 \text{ kN} \cdot \text{cm}}$$

Span of Stringer

$$\frac{\sigma_b}{f_b} = \frac{M_{\max}}{Z} = \frac{74.4 \text{ kN} \cdot \text{cm}}{192.9 \text{ cm}^3} = \boxed{0.386 \text{ kN/cm}^2}$$

$$\frac{\sigma_b}{f_b} = \frac{0.386 \text{ kN/cm}^2}{1.03 \text{ kN/cm}^2} = \boxed{0.37 \leq 1.0 \text{ OK!}}$$

➤ **Consideration of Shearing**

$$Q_{\max} = P = \boxed{1.86 \text{ kN}}$$

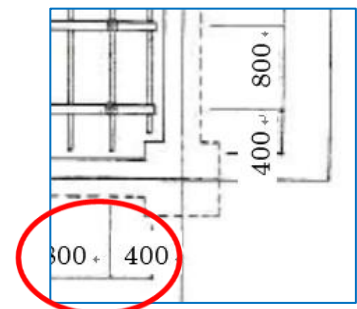

$$\tau = \frac{\mathcal{K} Q \max}{A} = \frac{1.5 \times 1.86 \text{ kN}}{110.3 \text{ cm}^2} = \boxed{0.025 \text{ kN/cm}^2}$$

Note: 1.5 is applied for \mathcal{K} , if the shape is rectangular.

$$\frac{\tau}{f_s} = \frac{0.025 \text{ kN/cm}^2}{0.074 \text{ kN/cm}^2} = \boxed{0.34 < 1.0 \text{ OK!}}$$

➤ **Consideration of Deflection**

$$\delta_{\max} = \frac{Pl^3}{3EI} = \frac{1.86 \text{ kN} \times (40.0 \text{ cm})^3}{3 \times 700 \text{ kN/cm}^2 \times 1,012.9 \text{ cm}^4}$$

$$= 0.056 \text{ cm} \leq 0.3 \text{ cm OK!}$$

4) Consideration of Support

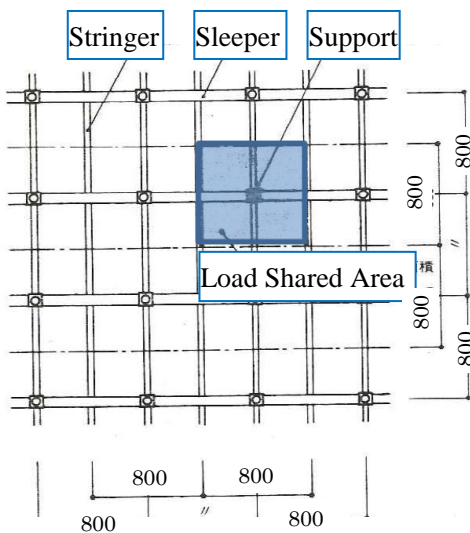

Pipe support is adapted for support in this exercise.

Allowable compressive stress: $F_c = 19.6 \text{ kN/pic.}$

Compressive strength operates to Pipe support by vertical load. Consideration is carried out whether this compressive strength is within allowable compressible stress.

The compressive strength operating on one pipe support is calculated by multiplying the area (A) shared of the vertical load by one pipe.

$$A = 80 \text{ cm} \times 80 \text{ cm} = 6,400 \text{ cm}^2$$

$$N = 0.00058 \text{ kN/cm}^2 \times 6,400 \text{ cm}^2$$

$$= \boxed{3.71 \text{ kN/pic.}}$$

Allowable compressive stress (F_c) of Pipe support is 19.6kN/pic,

Thus,

$$\frac{N}{F_c} = \frac{3.71 \text{ kN/pic.}}{19.6 \text{ kN/pic.}} = \boxed{0.19 \leq 1.0 \text{ OK!}}$$

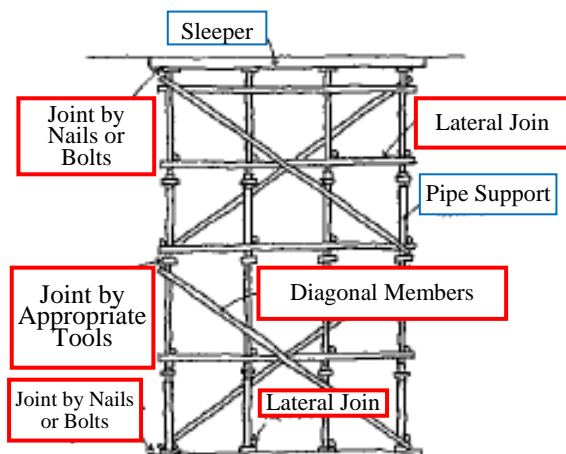











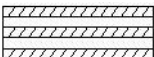







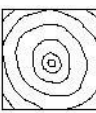

Note:

In case of height of Falsework is exceeded to 2 m, all pipe supports should be joint by steel pipes etc. to avoid buckling and deviation. At the same time, it is more effective to connect pipe support with diagonal members.

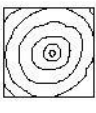
Performance of members for Falsework is shown in the table below as a reference.

Performance of Falsework

Type			Elastic Modulus E (kN/cm ²)	Allowable Bending Stress Intensity fx (kN/cm ²)	Moment of Inertia Area I (cm ⁴)	Section Modulus Z (cm ³)	
Plywood	12mm (5) (Number of layers) 		550	1.37	0.144	0.24	
			200	0.78			
	15 mm (5 or more) 		510	1.37	0.281	0.375	
			200	0.78			
	18 mm (7 or more) 		470	1.37	0.486	0.54	
			200	0.78			
Stringer		48 x 24		900	1.32	22.12	9.22
				250			
		60 x 27		900	1.32	48.6	16.2
				250			
Sleeper		100 x 100		700	1.03	833.3	166.7
				250			
		90 x 90		700	1.03	546.8	121.5
				250			
Steel pipe	○ Ø 48.6 2.3		STK400	2.05 x 10 ⁴	15.7	8.99	3.70
	○ Ø 48.6 2.5		STK500	2.05 x 10 ⁴	23.7	9.65	3.97
Angular pipe	□ — 50 x 50 x 2.3		STKR400	2.05 x 10 ⁴	16.3	15.9	6.34
	□ — 60 x 60 x 2.3					28.3	9.44

Note:  : the same direction of the fiber  : Perpendicular to the fiber direction

3. Removal and Dismantle of Formwork and Falsework

The Formwork and Falsework must not be removed and dismantled until the concrete reaches the necessary strength to keep its own weight and the load applied (working load during construction) in the construction period.

Timing and sequence of removal of Formwork and dismantlement of Falsework as well as reusing these material and facilities are planned by considering the required compressive strength of the concrete, the kind and importance of the structure, size of the structure, the operated load by the members, the temperature, weather, etc.

The recommendable applicable concrete compressive strength when Formwork and Falsework of reinforced concrete structure can be removed and dismantle refer to the below table.

To confirm the compressive strength, it is recommended to take additional specimens.

Recommendable Compressive Strength for Removal of Formwork and Dismantlement of Falsework

Classification of Side of Members	Example	Compressive Strength (N/mm ²)
Side of vertical and top side of leaning for the thick member, and outer side of small arch shape	Side of pile cap	3.5
Side of vertical and soffit of leaning structure that angle is steeper than 45 degrees for the thin member, and inner side of small arch shape	Side of column, wall, beam	5.0
Soffit of Slab, beam and leaning structure that angle is less than 45 degrees	Soffit of slab and beam, and inner side of arch structure	14.0

Appendix 4 - Management Format of Concrete Pouring

CS 01

Management Format for Concrete Placement in Bridge Construction

Name of Project :	Structure No. / Portion / Layers:			Weather	Outdoor Temperature	Name of PD	Name of QC Eng.	Name of Eng. In charge		
Status :										
Plan of concrete placement (Drawing) <div style="text-align: center;"> </div>	Time Schedule for Concrete Placement									
	Plan of Placement and management									
	Date of Placement		Weather		Outdoor Temperature		Name of PD		Name of Eng. In charge	
	Quantities (Plan)		Quantities (Actual)		m ³		Management of Placement Quantities		m ³ /h	
	Numbers of Concrete Agitating Truck		Horizontal Length		m		Interruption time			
	Concreting Plan		Vertical Length		m					
	Number of workers (Upper row : Plan, Lower row : Actual)		Number of workers (Upper row : Plan, Lower row : Actual)		(Upper row : Plan, Lower row : Actual)					
	Operator		Pouring, compaction, finishing and observation etc.							
	Crane		Foreman		Preparation		Vibrator		Finishing	
	AG		Plant		Type		Size		Number	
Helber -										
Curing		Method		Water Spray Curing <input type="checkbox"/>		Apply curing compound <input type="checkbox"/>		Others <input type="checkbox"/>		
<input type="checkbox"/> Necessary <input type="checkbox"/> Not Necessary		(Brand name and material)								
Design Strength		Design Compressive Strength		N/mm ²		Slump		cm		
Design Spec.		Classification of Concrete		Actual		Air Contents		%		
Types of Cement		Size of Coarse Aggregate		Actual		Chloride Contents		kg/m ³		
Inspection Plan		Lot		Compressive Strength (N/mm ²)		Average of Strength (N/mm ²)		Chloride Contents (kg/m ³)		
Number of Lots (Plan)		Temperature of concrete		(□)		Temperature of concrete		(□)		
Manufacture of concrete (Procurement method)		Temperature of concrete		(□)		Temperature of concrete		(□)		
Period of Testing		Temperature of concrete		(□)		Temperature of concrete		(□)		
Production of Specimens		Temperature of concrete		(□)		Temperature of concrete		(□)		
For Compressive Strength		Temperature of concrete		(□)		Temperature of concrete		(□)		
For 3days (Standard Curing)		Temperature of concrete		(□)		Temperature of concrete		(□)		
For 7days (Standard Curing)		Temperature of concrete		(□)		Temperature of concrete		(□)		
For 28 days (Standard Curing)		Temperature of concrete		(□)		Temperature of concrete		(□)		
Concerning point - comment etc.		Temperature of concrete		(□)		Temperature of concrete		(□)		
(Example)		Temperature of concrete		(□)		Temperature of concrete		(□)		
1. Countermeasure for rain		Temperature of concrete		(□)		Temperature of concrete		(□)		
Confirm countermeasures against rain such as preparation of waterproof sheet before starting concrete casting		Temperature of concrete		(□)		Temperature of concrete		(□)		
2. Countermeasures against suspension		Temperature of concrete		(□)		Temperature of concrete		(□)		
• The maximum disruption time is 30 minutes.		Temperature of concrete		(□)		Temperature of concrete		(□)		
3. Time to compact with a vibrator per one time		Temperature of concrete		(□)		Temperature of concrete		(□)		
• Standard time is 10-20 second		Temperature of concrete		(□)		Temperature of concrete		(□)		
4. Apply method of vibrator		Temperature of concrete		(□)		Temperature of concrete		(□)		
• Use at intervals of 30 - 50cm		Temperature of concrete		(□)		Temperature of concrete		(□)		

Management Format for Concrete Placement in Pavement Construction

CS 02

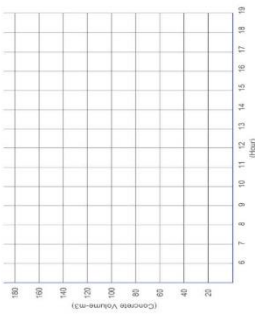
Name of Project : Organization or Company:	Pavement Layer:	Date of Placement	Weather	Project Engineer Sign - _____ Name - _____	QC Engineer Sign - _____ Name - _____	Construction Engineer Sign - _____ Name - _____
Plan of concrete placement (Drawing)		Estimated Concrete Quantity m ³	Production Operator Foreman	In-situ Mixing Rate: m ³ /hr Mixing Time: minute Slump: mm Batch Number:	Joint Spans (per Design) Joint Cutting Time (Actual)	m hr.
		Actual Concrete Quantity m ³	Mobile Mixer Rate: m ³ /hr Mixing Time: minute Slump: mm Batch Number:	W/C Cement Water Course Aggregate Fine Aggregate	Admixture % Type: Name:	
		Interruption Time minute	minute	minute	BS <input type="checkbox"/> ACI <input type="checkbox"/>	
Number of workers (Upper row : Plan, Lower row : Actual) (Upper row : Plan, Lower row : Actual)						
Compaction, Finishing and Observation etc.						
Particular	Foreman	Preparation	Type	Size	Carpenters Number	Robar Workers Number
According to Planning			Internal <input type="checkbox"/>			
Actual Condition			External <input type="checkbox"/>			
Curing Method Water Spray Curing <input type="checkbox"/> Apply curing compound <input type="checkbox"/> (Brand name and material spec.: _____) Others <input type="checkbox"/>						
Design Spec.	Design Classification of Concrete Types of Cement Size of Course Aggregate	Design Actual	Actual	Slump Air Contents Chloride Contents	Slump Air Contents Chloride Contents	cm % kg/m ³
Lot Compressive Strength N/mm ² Slump cm Average of Strength N/mm ² Air Contents % Chloride Contents Kg/m ³ Temperature of concrete <input type="checkbox"/> Outdoor Temperature <input type="checkbox"/>						
Time Record: Inspection Plan Time Schedule for Concrete Placement 						
Production of Specimens For Compressive Strength For 7days (Standard Curing) Nos For 28days (Standard Curing) Nos For 9] days (Standard Curing) Nos For 14days (standard Curing)) Nos						
Concerning point - comment etc.						

Appendix 5 - Quantab

1. Details of Quantab

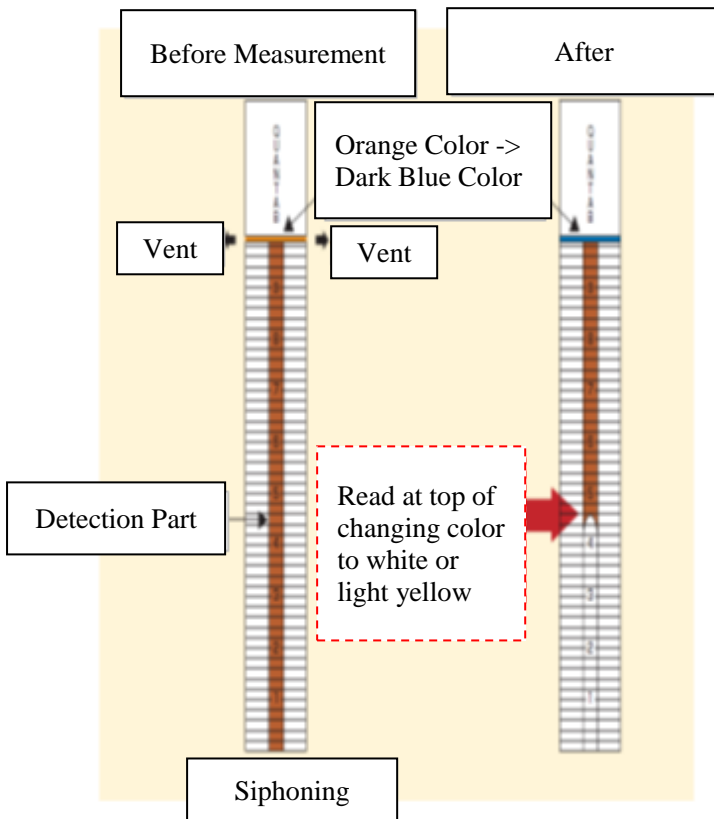

2. Method of Measurement

- 1) Open the package and taking out three Quantabs.
(Package must be opened just before measurement)
- 2) Insert them separately into the ready mixed concrete up to approx. one third of specimens.
(Measurement should be carried out at the sun shade location)
(Vent portion must be dried up all the time)

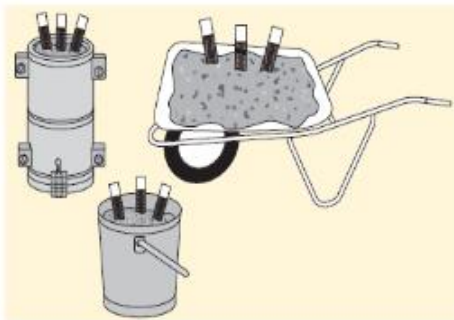

- 3) Keeping it approx. 10 to 15 minutes
- 4) After confirming that the moisture part has changed from orange to dark blue color, take out the specimens and read the top of the changing to about 0.1 digit.
- 5) Chloride contents is calculated by average of measurement of three specimens in accordance with the values of the convert table. Formula is mentioned below.

$$C.C. = \frac{A.S. \times W.C.}{100}$$

C.C. : Chloride contents in the ready mixed concrete (kg/m³)

A.S. : Average of measurement of three specimens in accordance with the values of the convert table

W.C. : Unit weight of water of concrete

6) Before put them to the recoding sheet, water which was siphoned by measurement must be squeezed out adequately.

Water should be squeezed out toward to siphoning portion from top of the changing portion of the color.

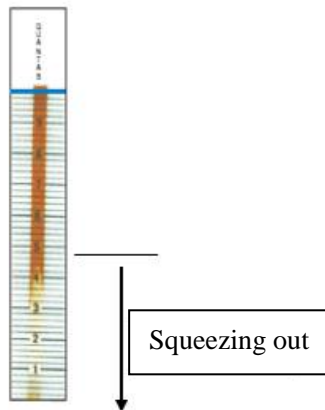

3. Example for calculation (In case of unit weight of water of concrete is 175kg/ m³)

1) Reading value of Quantabs

No.1: 3.9

No.2: 4.1

No.3: 4.1

2) Confirm the value from the convert table

No.1: 3.9 → 0.105

No.2: 4.1 → 0.115

No.3: 4.1 → 0.115

3) Calculate the average of the converted value rounded to 2 digits below the decimal point

$$(0.100+0.115+0.115) / 3 = 0.112 \rightarrow 0.11$$

4) Chloride contents in the ready mixed concrete (kg/m³) will be calculated by above mentioned formula.

$$C.C. = \frac{0.11}{100} \times 175$$

$$= 0.193 \leq 0.30 \text{ kg/ m}^3 \quad (\text{Allowable Value})$$

C.C : Chloride contents in the ready mixed concrete (kg/ m³)

* Source: Taiheiyo Material Co., Ltd.

Recording sheet of Chloride Contents

CS 03

Project Name : _____

Date and Time of Measurement : _____

Weather and Temperature: _____

Name of Measurement : _____

Location and Layers of Structures : _____

Unit Weight of Water : _____

No.1	No.2	No.3
Reading Value :	Reading Value :	Reading Value :
Converted Value :	Converted Value :	Converted Value :
Specimen	Specimen	Specimen
Average :		

$$\frac{\text{_____}}{100} \times \text{_____} = \text{_____} \text{ kg/m}^3$$

<u>Evaluation</u>	Pass	Fail
Allowance Value: Equal or less than 0.30Kg/m ³		

Confirmed by : _____

Appendix 6 - Checklists

Check Points for Classes of Concrete

CS 04-1

Project Name -
 Location -
 Project Manager -
 Date & Time -
 Checked by -

Stage of Work	Check Point	Management Items	Check on Site
1. Class of Concrete	(1) Which class of concrete is used on site?		<input type="checkbox"/>

CS 04-1 _ Check Points for Classes of Concrete

Check Points for Materials

CS 04-2

Project Name -

Location -

Project Manager -

Date & Time -

Checked by -

Stage of Work	Check Point	Management Items	Check on Site
1. Cement	(1) What kind of cement and strength does it use on site?	<ul style="list-style-type: none"> • Portland Cement • Early Strength Cement 	<input type="checkbox"/> <input type="checkbox"/>
	(2) Is manufacturing date on cement bag checked?		<input type="checkbox"/>
	(3) Does supplier submit quality certificate of cement?		<input type="checkbox"/>
	(4) Is quality of cement tested on site?	<ul style="list-style-type: none"> • Frequency: 	<input type="checkbox"/>

CS 04-2 _ Check Points for Materials

Stage of Work	Check Point	Management Items	Check on Site
5. Admixture	<p>(1) Which admixture is used in concrete?</p> <p>(2) Does supplier submit quality certificate?</p> <p>(3) Is expired date suitable or not?</p>	<ul style="list-style-type: none"> • Water Reducing • Retarding • Water Reducing and Retarding • Water Reducing and High Range • Water Reducing, High Range and Retarding 	<input type="checkbox"/> <input type="checkbox"/> <input type="checkbox"/> <input type="checkbox"/> <input type="checkbox"/> <input type="checkbox"/> <input type="checkbox"/>
6. Temperature of Materials	<p>(1) Does QC Engineer measure temperature of cement, CA, FA and water before mixing and keep the records?</p>		<input type="checkbox"/>
7. Rebar	<p>(1) Which country produces rebars that are used on site?</p> <p>(2) Has its quality been tested and have the records of quality test been kept?</p>		<input type="checkbox"/> <input type="checkbox"/>

CS 04-2 _ Check Points for Materials

Stage of Work	Check Point	Management Items	Check on Site
8. Formwork and Falsework	<p>(1) Which type of form is used for formwork and what kind of member is used for falsework?</p> <p>(2) How often is the form reused on site?</p>	<ul style="list-style-type: none"> • Plywood • Wooden • Metal • Pipe Support • Frame 	<input type="checkbox"/> <input type="checkbox"/> <input type="checkbox"/> <input type="checkbox"/> <input type="checkbox"/> <input type="checkbox"/>
9. Spacer	<p>(1) What kind of spacer is used on site?</p> <p>(2) How many pieces of spacer are installed per 1 m² (3.28 ft²)?</p>	<ul style="list-style-type: none"> • Mortar • Concrete • Plastic 	<input type="checkbox"/> <input type="checkbox"/> <input type="checkbox"/> <input type="checkbox"/>

CS 04-2 _ Check Points for Materials

Check Points for Mix Design

CS 04-3

Project Name -
Location -
Project Manager -
Date & Time -
Checked by -

Stage of Work	Check Point	Management Items	Check on Site
1. Mix Design	(1) Who approves all mix design (trial mix) before construction? (2) Does site keep record and report? (3) Does site QC engineer adjust water and cement content to achieve adequate workability?		<input data-bbox="1267 792 1299 837" type="checkbox"/> <input data-bbox="1267 1039 1299 1084" type="checkbox"/> <input data-bbox="1267 1397 1299 1442" type="checkbox"/>

CS 04-3 _ Check Points for Mix Design

Stage of Work	Check Point	Management Items	Check on Site
	(4) What is design strength of concrete?	<ul style="list-style-type: none"> • Bored pile • Footing • Pier • Cross Beam • Girder • Slab 	<input type="checkbox"/> <input type="checkbox"/> <input type="checkbox"/> <input type="checkbox"/> <input type="checkbox"/> <input type="checkbox"/>
	(5) Does the site consider the slump for each structure?		<input type="checkbox"/>
	(6) Is re-trial mix considered, if construction material, weather condition and type of cement are changed?		<input type="checkbox"/>
	(7) If re- trial mix was conducted, was record of re-trial mix reported to Lab?		<input type="checkbox"/>

CS 04-3 _ Check Points for Mix Design

Check Points for Construction Plan

CS 04-4

Project Name -
Location -
Project Manager -
Date & Time -
Checked by -

Stage of Work	Check Point	Management Items	Check on Site
1. Construction Plan	(1) Has construction plan made out? (2) Do the contents of construction plan follow the manual? (3) Does construction plan include construction method in rainy season? (4) Is preliminary survey conducted before construction and its record kept? (5) What kind of detail plan and procedures does project manager prepare before construction?		<input type="checkbox"/> <input type="checkbox"/> <input type="checkbox"/> <input type="checkbox"/> <input type="checkbox"/>

CS 04-4 _ Check Points for Construction Plan

Stage of Work	Check Point	Management Items	Check on Site
2. Preparation Works	(1) Does site engineer prepare bar bending schedules? (2) Which items does steel fixer manage for rebar fabrication and installation? (3) Does site engineer check the spacing, covering, lap length and fixing condition? (4) Does site engineer make structural calculation for formwork and falsework?		<input type="checkbox"/> <input type="checkbox"/> <input type="checkbox"/> <input type="checkbox"/>
3. Assembling and Checking	(1) How often does site engineer check assembling of rebars, formwork and falsework?		<input type="checkbox"/>
4. Others	(1) Has site engineer considered to manage negative impact on social and environment condition?	<ul style="list-style-type: none"> • Social Condition • Environmental Condition 	<input type="checkbox"/> <input type="checkbox"/>

CS 04-4 _ Check Points for Construction Plan

Check Points for Storage of Materials

CS 04-5

Project Name -

Location -

Project Manager -

Date & Time -

Checked by -

Stage of Work	Check Point	Management Items	Check on Site
1. Storage of Cement	(1) Is the storage method appropriate? (2) Is storage quantity adequate? Is the balance with the consumed amount considered? (3) Does store manager manage storage period of cement bags? (4) Does the store manager understand and manage storage location for each delivery date? (To follow "First In, First Out" system)	<ul style="list-style-type: none"> • Facilities • Method of piling • Moisture prevention • Ventilation 	<input type="checkbox"/> <input type="checkbox"/> <input type="checkbox"/> <input type="checkbox"/> <input type="checkbox"/> <input type="checkbox"/> <input type="checkbox"/>

CS 04-5 _ Check Points for Storage of Materials

Stage of Work	Check Point	Management Items	Check on Site
5. Reinforcement Bar (Rebar) and Formwork materials	<p>(1) Does the store manager manage appropriate storage method on site?</p> <p>(2) Does site engineer manage removal of formwork materials?</p> <p>(3) If construction site is in coastal area, does it make protection from salty wind (moisture)?</p>		<input data-bbox="1273 320 1310 360" type="checkbox"/> <input data-bbox="1273 562 1310 602" type="checkbox"/> <input data-bbox="1273 819 1310 860" type="checkbox"/>
6. Records	<p>(1) Does store manager have store record of cement, CA, FA, admixtures, rebars and formwork materials and inform it to site engineer?</p> <p>(2) Does store manager keep the quality control certificate submitted by suppliers?</p>		<input data-bbox="1273 1122 1310 1162" type="checkbox"/> <input data-bbox="1273 1520 1310 1561" type="checkbox"/>

CS 04-5 _ Check Points for Storage of Materials

Check Points for Production and Procurement of Concrete CS 04-6

Project Name -
 Location -
 Project Manager -
 Date & Time -
 Checked by -

Stage of Work	Check Point	Management Items	Check on Site
1. Production Facilities	(1) Which method is used for weighing?		<input type="checkbox"/>
	(2) Is calibration for scales carried out and recorded?	● Frequency:	<input type="checkbox"/>
	(3) Which mixer with capacity is used on site?	● Batching plant: m ³	<input type="checkbox"/>
		● Gravity mixer m ³	<input type="checkbox"/>
		● Others m ³	<input type="checkbox"/>
(4) What kind of management does site engineer make for mixing?	● Mixing time	<input type="checkbox"/>	
	● Charging sequence of material	<input type="checkbox"/>	
	● Tolerance of each material	<input type="checkbox"/>	
(5) What kind of concrete is rejected and modified?	● Others	<input type="checkbox"/>	
			<input type="checkbox"/>

Stage of Work	Check Point	Management Items	Check on Site
	(6) Does site engineer consider mixing under hot weather?		<input type="checkbox"/>
2. Procurement from Private Supplier	(1) Does site engineer manage proper plan to control the quality?		<input type="checkbox"/>
3. Sampling and Testing	(1) What kind of tests are carried out on site and who approves it?	<ul style="list-style-type: none"> ● Slump test ● Chloride contents ● Air contents ● Temperature of concrete 	<input type="checkbox"/> <input type="checkbox"/> <input type="checkbox"/> <input type="checkbox"/>

CS 04-6 _ Check Points for Production and Procurement of Concrete

Check Points for Transportation and Handling

Project Name -
 Location -
 Project Manager -
 Date & Time -
 Checked by -

Stage of Work	Check Point	Management Items	Check on Site
1. Transportation & Handling	(1) Which transportation and handling methods are used on site? (2) Does site engineer prepare sufficient equipment and consider countermeasure plan in advance? (3) Does site engineer manage delivery time?	<u>Transportation</u> <ul style="list-style-type: none"> • Agitator Truck • Dump Truck • Manpower <u>Handling</u> <ul style="list-style-type: none"> • Concrete bucket • Concrete pump • Shoot (chute) • Wheel barrow 	<input type="checkbox"/> <input type="checkbox"/> <input type="checkbox"/> <input type="checkbox"/> <input type="checkbox"/> <input type="checkbox"/> <input type="checkbox"/> <input type="checkbox"/>

Check Points Before Pouring and Methodology of Pouring

CS 04-8

Project Name -
 Location -
 Project Manager -
 Date & Time -
 Checked by -

Stage of Work	Check Point	Management Items	Check on Site
1. Preparation before pouring	(1) Does site engineer make necessary arrangement for rainy and hot weather concreting?	<ul style="list-style-type: none"> • Equipment • Arrangement of sufficient workers • Cleaning condition 	<input type="checkbox"/>
	(2) Which points does site engineer check before pouring?		<input type="checkbox"/> <input type="checkbox"/> <input type="checkbox"/>
	(3) Does site engineer check equipment condition before pouring and consider countermeasure plan?		<input type="checkbox"/>

Stage of Work	Check Point	Management Items	Check on Site
2. Methodology of Pouring	<p>(1) Does site engineer manage proper pouring sequence for construction?</p> <p>(2) What kind of vibrator is used on site and its quantity enough?</p> <p>(3) What kind of management does site engineer make for consolidation (compaction) and finishing?</p>		<p><input type="checkbox"/></p> <p><input type="checkbox"/></p> <p><input type="checkbox"/></p>

CS 04-8 _ Check Points Before Pouring and Methodology of Pouring

Check Points for Curing

CS 04-9

Project Name -

Location -

Project Manager -

Date & Time -

Checked by -

Stage of Work	Check Point	Management Items	Check on Site
1. Plan of curing	(1) Is curing method appropriate?	<ul style="list-style-type: none"> • Curing method and period • Quantity of materials etc. 	<input type="checkbox"/> <input type="checkbox"/>
	(2) Is the outside temperature low or high?	<ul style="list-style-type: none"> • Outside temperature • Weather 	<input type="checkbox"/> <input type="checkbox"/>
	(3) Does not concrete surface dry?	<ul style="list-style-type: none"> • Wet condition of the surface 	<input type="checkbox"/>
	(4) Is there no sudden temperature change during curing?	<ul style="list-style-type: none"> • Curing temperature 	<input type="checkbox"/>

CS 04-9 _ Check Points for Curing

Stage of Work	Check Point	Management Items	Check on Site
1. Plan of Curing	(5) Is there no vibration during curing?	<ul style="list-style-type: none"> • Having or not having of vibration 	<input type="checkbox"/>
	(6) Do not receive impact during curing?	<ul style="list-style-type: none"> • Having or not having of vibration 	<input type="checkbox"/>
	(7) For water curing, Is the quantity of storage water is adequate or not?		<input type="checkbox"/>
2. Wet curing	(1) Is not concrete surface dry?	<ul style="list-style-type: none"> • Wet condition of the surface 	<input type="checkbox"/>
	(2) Is the curing period appropriate?	<ul style="list-style-type: none"> • Curing period 	<input type="checkbox"/>
	(3) Is it appropriate to keep concrete surface wet?	<ul style="list-style-type: none"> • Method of water supply • Strength of initial age 	<input type="checkbox"/> <input type="checkbox"/>
3. Curing for protection against harmful effects	(1) Is vibration, impact or excessive load acting on uncured concrete?	<ul style="list-style-type: none"> • Acting of external force 	<input type="checkbox"/>

CS 04-9 _ Check Points for Curing

Stage of Work	Check Point	Management Items	Check on Site
3. Curing for protection against harmful effects	(2) Whether an excessive load is applied to the initial material age	<ul style="list-style-type: none"> • Acting of external forces at early age 	<input type="checkbox"/>
4. Curing method for formwork	(1) Is method appropriate?	<ul style="list-style-type: none"> • Method of curing 	<input type="checkbox"/>
	(2) Is the surface of formwork dry?	<ul style="list-style-type: none"> • Condition of formwork 	<input type="checkbox"/>
5. Liquid membrane curing	(1) Whether it is applied in combination with wet curing	<ul style="list-style-type: none"> • Combined use with wet curing 	<input type="checkbox"/>
	(2) Is material selection appropriate?	<ul style="list-style-type: none"> • Material used 	<input type="checkbox"/>
	(3) Is the time of spraying appropriate?	<ul style="list-style-type: none"> • Timing of spraying 	<input type="checkbox"/>
	(4) Is the spraying method appropriate?	<ul style="list-style-type: none"> • Method of spraying 	<input type="checkbox"/>

CS 04-9 _ Check Points for Curing

Check Points for Joints

CS 04-10

Project Name -

Location -

Project Manager -

Date & Time -

Checked by -

Stage of Work	Check Point	Management Items	Check on Site
1. Joint	(1) Does the site plan the construction joints?		<input type="checkbox"/>
	(2) What kinds of treatment are used for construction joint?	<ul style="list-style-type: none"> ● Clean cut method ● Brushing method ● Others 	<input type="checkbox"/> <input type="checkbox"/> <input type="checkbox"/>
	(3) Which treatment is used to prevent water leakage?		<input type="checkbox"/>

CS 04-10 _ Check Points for Joints

Check Points for Remedial Work

CS 04-11

Project Name -

Location -

Project Manager -

Date & Time -

Checked by -

Stage of Work	Check Point	Management Items	Check on Site
1. Remedial Work	(1) Aer there some defects of concrete structure?		<input type="checkbox"/>
	(2) Does site engineer check and manage defects of concrete structure?		<input type="checkbox"/>
	(3) Did site engineer find out the cause of defect and consider the countermeasures?		<input type="checkbox"/>
	(4) Does site engineer keep record of defect and report to QC Head office?		<input type="checkbox"/>

CS 04-11 _ Check Points for Remedial Work

Table-② 【Check Sheet for During Each Activity (Concrete Pouring Activity)】 CS 04-12

	Site Office		Project	
	Structure		Structure Parts	
	Design Mix		Checked by:	
	Pour Lift		Time Check	
Item No.	Activity	Check Items	Describe	Check
Preparation	Preparation	1	Are all equipment clean/ no dirt?	
		2	Is the surface of formwork wet?	
		3	Inside formwork, make sure no foreign items such as wood chips and tight wires, etc.	
		4	Make sure no tight wires at rebar's coverage area.	
		5	Take out all laitance on surface of hardened concrete and let it wet.	
		6	Do you have extra pouring men*1 as for stand-by?	
		7	Do you prepare the extra vibrator as a back-up?	
		8	Did you check the generator condition before start of pour?	
		9	Did you explain enough the pour plan to all workers?	
Transport	1	Transport	Is the time, from mixing to finish pouring, appropriate?	
Concrete Pour	Concrete Pour	1	Send mortar through concrete pipes as lubricant before sending fresh concrete.	
		2	Is all formwork and rebars tight and straight?	
		3	Are you pouring fresh concrete straight down/ vertical so that no follow horizontally?	
		4	Are pouring fresh concrete continuously until all concrete poured?	
		5	Are you pouring fresh concrete so that its surface is flat/ horizontal?	
		6	Make sure each layer of fresh concrete pour is less than 50cm.	
		7	When pour in more than 2 layers, keep proper time between layers not to let lower layer start hardening.	
		8	Keep height between outlet of fresh concrete and surface of poured concrete within 1.5m.	
		9	Pour fresh concrete after taking out bleeding water of poured concrete. Do you have a plan of who takes, where to take from and how to take?	

CS 04-12 _ Check Sheet for During Each Activity (Concrete Pouring Activity)

Item No.	Activity	Check Items	Describe	Check	
Concrete Compaction	1	Concrete Compaction	Make sure insert vibrator into poured concrete for about 10 cm.		
	2		Make sure insert vibrator vertically and keep distance less than 50cm between inserting points.		
	3		Keep vibrating period between 5 to 15 seconds.		
	4		During concrete compaction, make sure vibrator does not touch rebars.		
	5		As close to the final surface, re-compaction near surface shall be carefully/ thoroughly vibrated.		
	6		Do not flow horizontally by vibrator.		
	7		Take out vibrator gradually so that does not create holes in fresh concrete.		
Curing	1	Curing	When fresh concrete surface may dry prior to the hardening, provide sheet over the surface to protect surface from sun shine and wind browning.		
	2		Keep fresh concrete wet.		
	3		Keep fresh concrete wet for appropriate period.		
	4		Take out formwork and scaffolding after the concrete earns appropriate strength.		
	Required Items, etc.				

*1: pouring men means workers that excluding not directly working staff such as supervisor, engineers, pump operators, etc. from all staff and worker related for concrete pouring and compaction.

CS 04-12 _ Check Sheet for During Each Activity (Concrete Pouring Activity)