



SIGNING AND MARKING DESIGN GUIDELINES

**Georgia Department of Transportation
935 East Confederate Avenue, Building 24
Atlanta, Georgia 30316**

Edition: 2.1

Document Revision History

DATE	REV.	SECTIONS	DESCRIPTION
11/2008	Edition 2.0	ALL	Revised and Combined Interstate and Limited Access Roadway Signing and Marking Design Guidelines and Non-Interstate Signing and Marking Design Guidelines
1/2011	Edition 2.1	ALL	Revised Figures
		Section 2	Removed section 2.6 Detail Estimate
		Section 3	Added Bicycle Warning and Share the Road Sign Guidance and Revised Figures Specified 36" for Warning Signs on State Routes
		Appendix A	Revised Legend and Figures

**GEORGIA DEPARTMENT OF TRANSPORTATION
SIGNING AND MARKING DESIGN GUIDELINES**

TABLE OF CONTENTS

SECTION 1 INTRODUCTION	1-1
1.1 Definitions	1-1
1.2 Applicable Standards and Specifications	1-2
SECTION 2 GENERAL INFORMATION.....	2-1
2.1 Drafting Standards.....	2-1
2.2 Electronic File Structure.....	2-1
2.3 Signing and Marking Plan Sheets.....	2-1
2.4 General Notes.....	2-2
2.5 Summary of Quantities Sheets	2-2
2.6 Detail Estimate.....	Error! Bookmark not defined.
2.7 Sign Detail Sheets	2-2
2.8 Clearance Diagrams	2-3
SECTION 3 SIGN DESIGN STANDARDS.....	3-1
3.1 General Sign Guidelines	3-1
3.2 Regulatory Signs.....	3-1
3.3 Warning Signs.....	3-2
3.4 Guide Signs	3-3
3.5 School Zone and Pedestrian Crossing Signs	3-5
3.6 Overhead Span Wire Signs.....	3-5
3.7 Sign Posts.....	3-6

SECTION 4	LOCATION AND SEQUENCE OF SIGNS	4-1
4.1	Exit Signing	4-1
4.2	Post-Interchange Sequence Signing.....	4-2
4.3	Milepoint Signs	4-3
4.4	Political Boundary Signs.....	4-3
4.5	Waterway Signs	4-3
4.6	Hospital Signs	4-3
4.7	Bridge Caution Signs.....	4-3
4.8	No Trucks Over 6 Wheels Allowed in Left X Lanes Signs	4-3
4.9	Truck Use I-285	4-4
4.10	Emergency Parking Only Signs	4-4
4.11	Up to \$1,200 Fine for Throwing Trash on Highway Signs	4-4
4.12	Slower Traffic Keep Right Signs.....	4-4
4.13	Keep Off Median Signs	4-4
4.14	Miscellaneous Signs.....	4-4
4.15	Reduced Speed Ahead Signs.....	4-4
SECTION 5	SPECIFIC SIGN SEQUENCING FOR PARTICULAR APPLICATIONS.....	5-1
5.1	Lane Reduction for Interstates	5-1
5.2	Lane Reduction for Conventional Roads.....	5-1
5.3	Lane Drop – Continuous to Exit Lane.....	5-1
5.4	Lane Drop – Auxiliary Lane.....	5-1
5.5	Lane Drop – Drop Option.....	5-1
SECTION 6	STANDARD SIGNS	6-1
6.1	General	6-1

SECTION 7 SIGN LAYOUTS	7-1
7.1 General	7-1
SECTION 8 SPECIAL ROADSIDE SIGNS.....	8-1
8.1 General	8-1
8.2 Placement	8-3
SECTION 9 OVERHEAD HIGHWAY SIGNS	9-1
9.1 General	9-1
9.2 Placement	9-1
SECTION 10 CLEARANCE DIAGRAMS.....	10-1
10.1 General	10-1
10.2 Design Elements.....	10-1
SECTION 11 LOGO SIGNS	11-1
11.1 General	11-1
SECTION 12 PAVEMENT MARKING DESIGN STANDARDS	12-1
12.1 Materials.....	12-1
12.2 Pavement Markings	12-1
12.3 Raised Pavement Markers.....	12-1
 APPENDIX A – SIGN LAYOUT TEMPLATES	
 APPENDIX B – TYPICAL SIGNING AND PAVEMENT MARKING	
 APPENDIX C – BICYCLE SIGNING AND MARKING	
 APPENDIX D – SUMMARY OF QUANTITIES	
 APPENDIX E – GENERAL NOTES	
 APPENDIX F – FIGURES	

SECTION 1 INTRODUCTION

These design guidelines provide standards, guidelines, and specifications that will be used for the design of traffic signing and pavement markings prepared for the Georgia Department of Transportation (GDOT). These design guidelines include a compilation of specific drafting and design standards, plan and specification presentations, and review procedures to ensure that construction documents properly convey the extent and character of work to be performed. Sound traffic engineering judgment shall be exercised in applying these guidelines. Along with the companion document on traffic signal design, these documents contain comprehensive guidelines intended to provide consistency in plans for traffic control devices.

This document replaces previous editions of Non-Interstate Signing and Marking Design Guidelines and Interstate and Limited Access Roadway Signing and Marking Design Guidelines.

1.1 Definitions

MUTCD – Manual on Uniform Traffic Control Devices – Approved by the Federal Highway Administration as the national standard for the placement and standardization of all signs, signals, and markings placed on public facilities.

AASHTO “Green Book” – A Policy on Geometric Design of Highways and Streets as published by the American Association of State Highway and Transportation Officials (AASHTO), latest edition adopted by GDOT. Design standards outlined in this publication shall govern most geometric considerations. This publication provides guidance on the physical design of highways and streets.

Physical gore – The point, as defined in the AASHTO “Green Book,” where the ramp intersects with the mainline facility and the pavement surface changes.

Theoretical gore (“painted gore”) – The point, as defined in the AASHTO “Green Book,” where the ramp separates from the mainline facility.

Entrance ramp end – The point, as defined in the AASHTO “Green Book,” where the full width of the ramp entering a facility becomes less than the full lane width.

Guide signs – Show route designations, destinations, directions, distances, services, points of interest, and other geographical, recreational, or cultural information.

Warning signs – Give notice of a situation that might not be readily apparent.

Regulatory signs – Give notice of traffic laws or regulations.

Special roadside signs – Guide signs that are manufactured using extruded aluminum panels and that are ground-mounted.

Overhead signs – Signs that are manufactured using extruded aluminum panels and are mounted over the roadway facility.

- *Type I, bridge overhead sign structure* – A horizontal structure that spans the roadway and is supported at each end by columns.
- *Type II, cantilever overhead sign structure* – A horizontal structure that is supported at one end by a single column. No new Type II structures shall be installed.
- *Type III, butterfly overhead sign structure* – A horizontal structure that extends in opposite directions from a single column support.
- *Type IV, combination overhead sign structure* – A horizontal structure with two supports, only one of which is at one end of the structure.
- *Type V, cantilever overhead sign structure* – A single, rigid, tube-type horizontal arm that is supported at one end by a single tubular support pole.
- *Type VI, bridge overhead sign structure* – A single, rigid, tube-type horizontal structure that is supported at both ends by single tubular support poles.
- *Type VII, bridge-mounted overhead sign structure* – A structural frame that is attached to a grade-separation structure. Caution is to be used in attaching signs to bridges in accordance with the February 8, 1980 [memorandum](#) from J.T. Kratzer, PE, state bridge engineer, to Archie C. Burnham, PE, state traffic and safety engineer.
- *Type VIII, butterfly overhead sign structure* – Single rigid tube type horizontal arms extending in opposite directions from a single column support.

Interstate – A freeway (divided highway with full control of access) with a series of interchanges.

Non-Interstate – A road without interchanges; a conventional roadway.

1.2 Applicable Standards and Specifications

The following specific documents will govern all work efforts:

[*GDOT Standard Specifications – Construction of Transportation Systems*](#) – Latest edition and supplements thereto. Documents listed below provide more detail concerning specific traffic engineering design elements, but all work must be in accordance with the GDOT Standard Specifications.

[*GDOT Signing and Marking Details*](#)

[*GDOT Standard Detail Sheets*](#)

[GDOT Construction Details](#)

[GDOT Plans Presentation Guide \(PPG\)](#)

[GDOT Electronic Data Guidelines \(EDG\)](#)

MUTCD – Latest edition adopted by GDOT. This document shall govern those aspects of the application of all signs, signals, and pavement markings.

Standard Highway Signs (Federal Highway Administration [FHWA])

[Americans with Disabilities Act](#)

AASHTO “Green Book” – A Policy on Geometric Design of Highways and Streets as published by AASHTO, latest edition adopted by GDOT. Design standards outlined in this publication shall govern most geometric considerations. This publication provides guidance on the physical design of highways and streets.

AASHTO Standard Specifications for Structural Supports for Highway Signs, Luminaries, and Traffic Signals – This document provides criteria for structural design.

[FHWA Work Zone Traffic Control Practices Manual](#)

[Roadside Design Guide](#)

[GDOT Design Guide](#)

**DEPARTMENT OF TRANSPORTATION
STATE OF GEORGIA**

INTERDEPARTMENT CORRESPONDENCE

FILE Bridge General **OFFICE** Atlanta
DATE February 8, 1980

FROM J. T. Kratzer, P. E., State Bridge Engineer

TO Archie C. Burnham, P. E., State Traffic & Safety Engineer

SUBJECT REVISIONS - STANDARD SPECIFICATIONS

Reference is made to your letter of January 24, 1980, concerning development of a pay item to cover mounting signs on highway bridges. Section 638 of the Standard Specifications is now being revised to accommodate this item. We wish to outline when and how this pay item should be used:

1. Signs shall not be mounted to bridges if the angle between the bridge centerline and roadway centerline is less than 70 degrees.
2. Signs shall not be mounted to concrete prestressed beam bridges, concrete pretensioned bridges, or concrete T-Beam bridges.
3. In preparing plans for mounting signs to existing bridges, you should include in your plans details of the bridge overhang and deck plan so the contractor can prepare his plans accordingly.
4. Your plans should specify if the existing bridge beams are unpainted weathering steel.
5. Signs mounted on bridges should comply with section 1.1.3 (D) (1) of the AASHTO Standard Specifications for Structural Supports for Highway Signs, Luminaires, and Traffic Signals.

The above comments should be determined by your office during the plans preparation phase of the project.

If you have any question concerning this matter, please contact this office.

PVL:ml

cc: James L. Pierce
Attn: G. D. Bailey
cc: W. B. Lawing (HWC)

SECTION 2 GENERAL INFORMATION

The following standards apply to the preparation and presentation of signing and marking plans.

2.1 Drafting Standards

Drafting standards shall follow the requirements of the [EDG](#).

2.2 Electronic File Structure

Electronic file structure shall follow the requirements of the [EDG](#).

2.2.1 Cell Libraries

The Office of Traffic Operations has a cell library that contains standard cells for signs and pavement marking items. The signing and marking design cell file (as well as other GDOT design cell files) is available from the [GDOT ROADS web site](#).

2.3 Signing and Marking Plan Sheets

Prepare plan sheets to show all permanent roadway signs and pavement markings as they appear upon completion of the project. Place emphasis on designing clear directional signage, identifying roadway names, and coordinating sign placement with signal or utility poles, roadway features, structures, sight distances, and driver awareness. Signing and marking plan sheets should be the same scale as the construction plans and should use the same match lines. Signing and marking plan sheets shall follow the requirements of the [PPG](#).

2.3.1 Required Information

Pavement markings:

Depict and label all required pavement markings to indicate color, width, and spacing as appropriate on each sheet. While it is not necessary to label each pavement item, at least one note referencing the applicable standard should be included on each sheet.

Raised pavement markers:

Depict and label all required raised pavement markers to indicate color, type, and spacing as appropriate on each sheet. While it is not necessary to label each pavement item, at least one note referencing the applicable standard should be included on each sheet.

Signs:

Show the location of required signs symbolically and give a representation of the sign face. Orient the symbol, sign code, and sign face to correspond to the direction of travel of the motorists for which they are intended. Reference the placement station, sign code, and size of each sign in a uniform manner throughout the plan set.

2.3.2 Sheet Layout

The signing and marking plan sheet layout shall follow the requirements of the [PPG](#).

2.4 General Notes

The general notes for signing and marking shall be included within the plan assembly's general notes section. Refer to the [PPG](#) for sheet sequence.

Signing and marking plans may contain the following general note sheets:

- [Standard Signs General Notes](#)
- [Special Roadway Signs General Notes](#)
- [Overhead Highway Signs General Notes](#)

2.5 Summary of Quantities Sheets

Quantities for pavement markings and signs are presented on separate sheets. Typically, the removal of pavement markings and signs is paid for as part of traffic control lump sum; therefore, it should not be in the summary of quantities unless it is a special circumstance. This is covered in Section 150 of the [GDOT Standard Specifications for Construction of Transportation Systems](#).

The Summary of Quantities for Pavement Markings sheet lists the type and quantity for traffic stripes, raised pavement markers, arrows, words, and symbols.

The Summary of Quantities for Standard Signs sheet presents sign and sign post quantities in a tabular format. Each sign is listed separately by station and sign code. No two separate sign installations shall have the same station number. Offset by 1 foot, if necessary. There are separate columns for Type 1 and Type 2 sign material and Type 3 and Type 9 reflective sheeting material. Sign posts are separated into Type 7, 8, and 9 posts. If there is more than one sign on a post, then the post is listed in the same row as the first sign on the post.

The Summary of Quantities for Signing and Marking shall be included within the plan assembly's summary of quantities section. Refer to the [PPG](#) for sheet sequence.

Signing and marking plans may contain the following summary of quantity sheets:

- [Summary of Quantities – Pavement Markings](#)
- [Summary of Quantities – Standard Signs](#)
- [Summary of Quantities – Special Roadside Signs](#)
- [Summary of Quantities – Remove and Remount Special Roadside Signs](#)
- [Summary of Quantities – Overhead Highway Signs](#)
- [Summary of Quantities – Remove Overhead Highway Signs and Structures](#)
- [Summary of Quantities – Remove and Reset of Logo Signs](#)

2.6 Sign Detail Sheets

Sign detail sheets shall be developed for special signs or signs with unique or non-standard legends. Sign detail sheets shall be located after the signing and marking plan sheets. Sign templates are provided in [Appendix A](#) of this document. An example sign detail sheet is shown in [Figure 2-1](#).

2.7 Clearance Diagrams

Clearance diagrams shall be developed for overhead highway signs. Clearance diagrams shall be located after signing and marking plan sheets.

Additional requirements for [clearance diagrams](#) are included in subsequent sections of this document.

D1-2(60)
STA.110+00

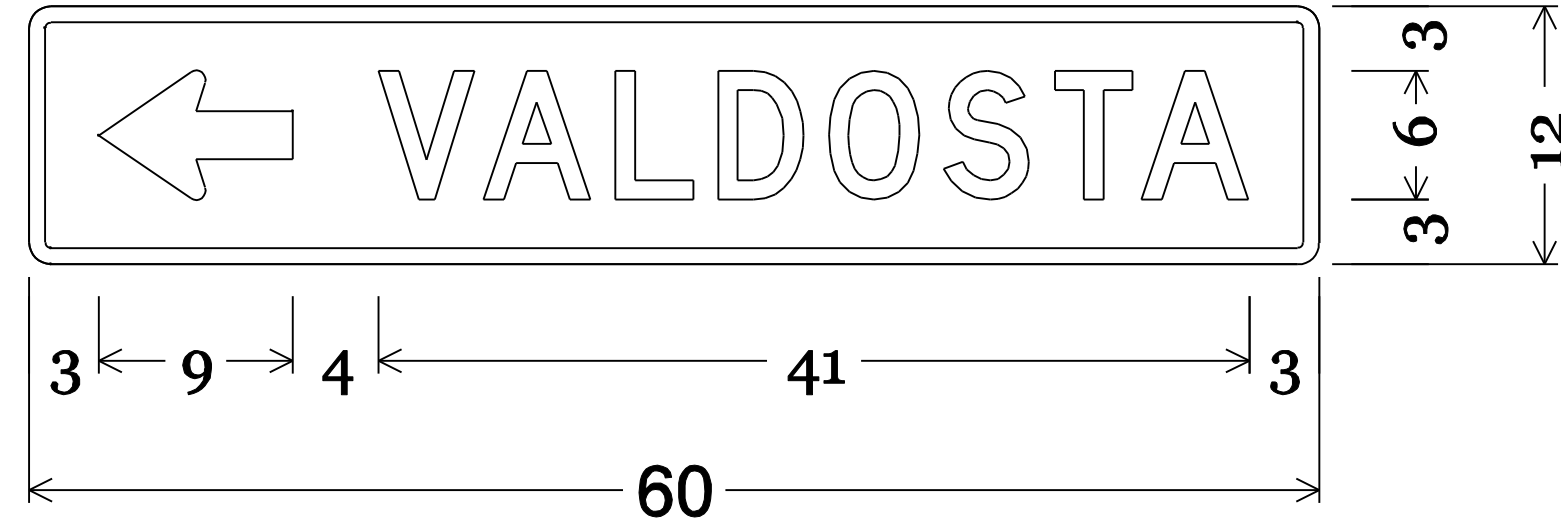

1" Radius, 1" Border, White on Green;
Standard Arrow Custom 9" X 6" 180; °
[VALDOSTA] D;

I-2(48)
STA.120+00

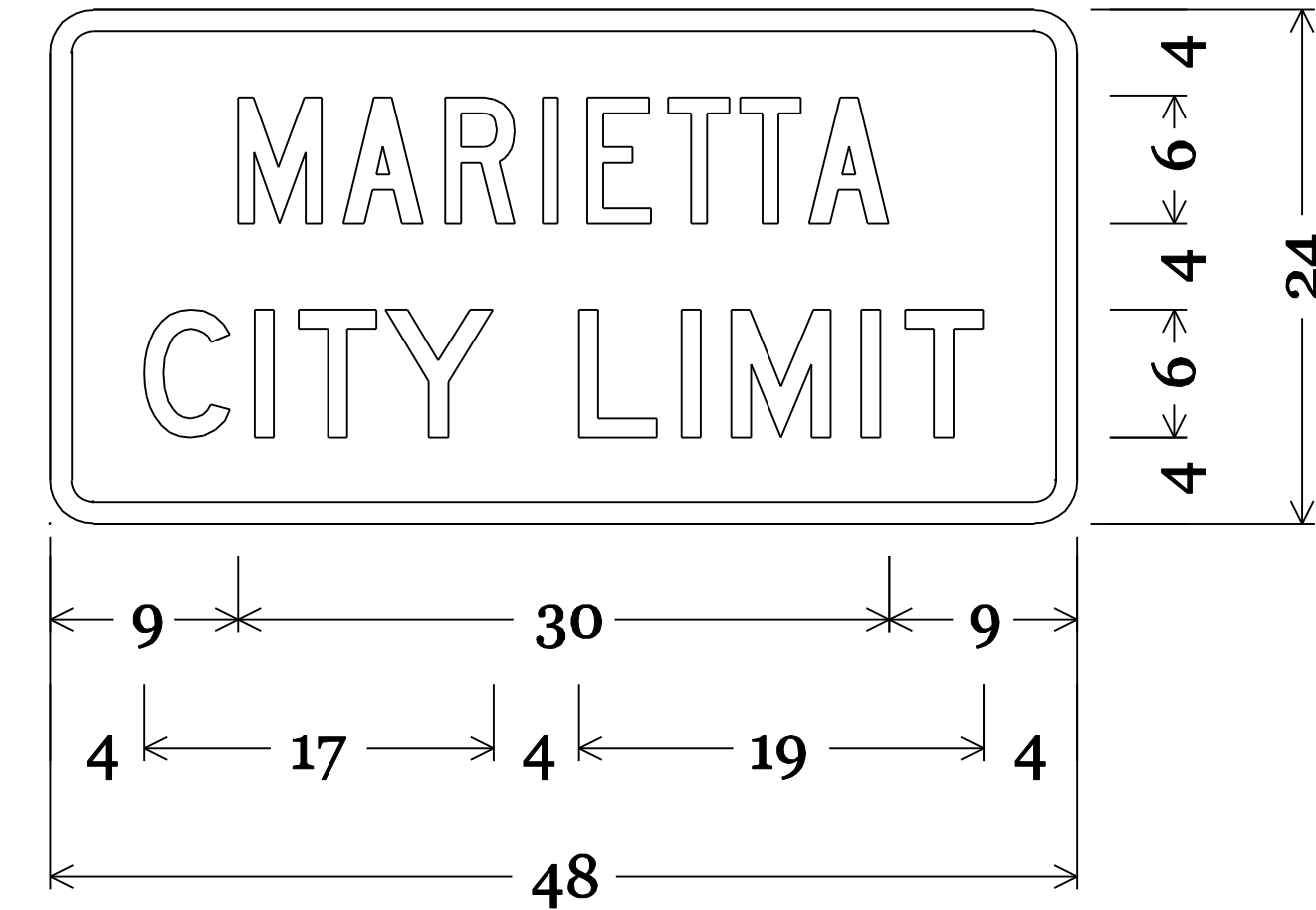

2" Radius, 1" Border, White on Green;
[MARIETTA] C; [CITY] D; [LIMIT] D;

D3-1(48)
STA.100+00

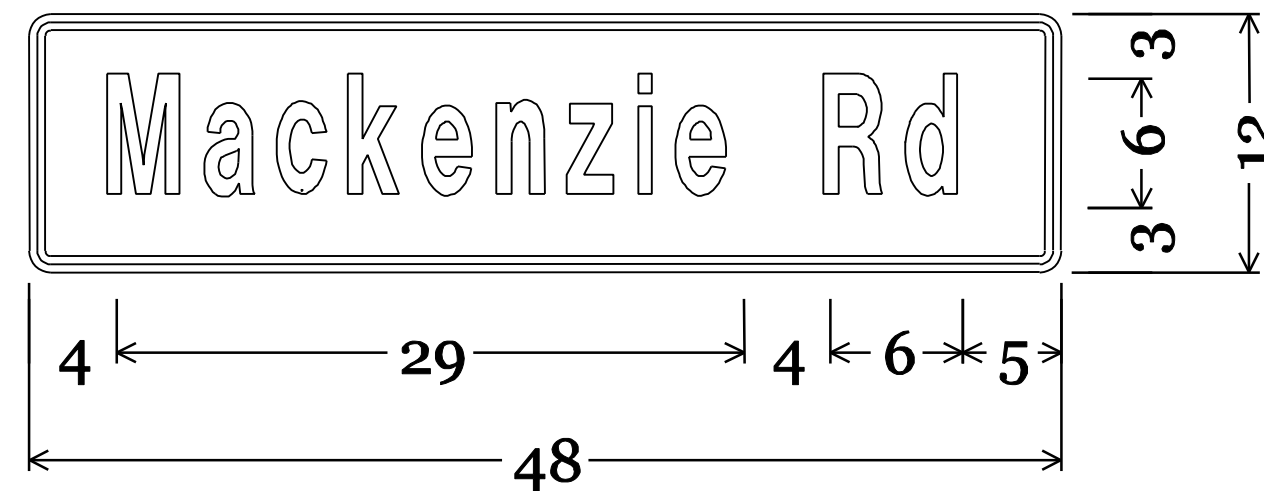

1" Radius, 0" Border, 0" Indent, White on Green;
[Mackenzie] B; [Rd] B;

SPCL#2 (96)
STA.120+00

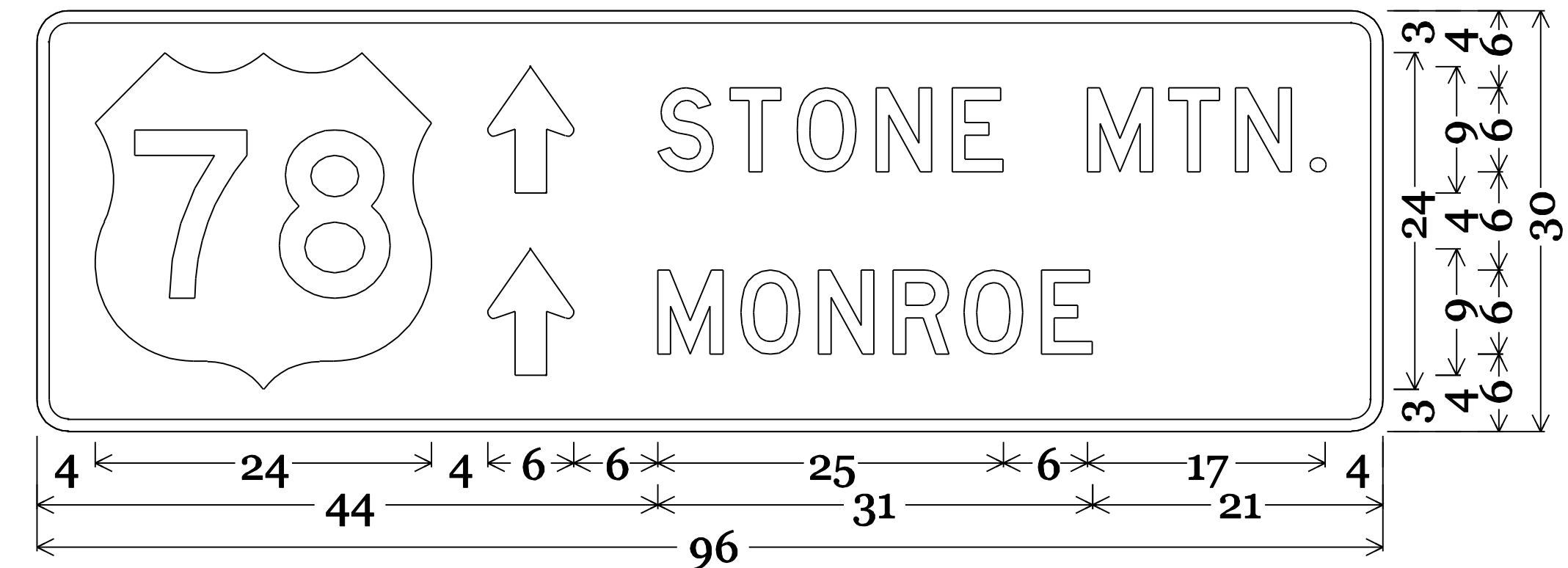

D1-3; 2.3" Radius, 0.9" Border, White on Green;
Standard Arrow Custom 9.0" X 6.1" 90{; [STONE MTN.] D;
Standard Arrow Custom 9.0" X 6.1" 90{;
[MONROE] D 92} spacing;

D3-2(48)
STA.110+00
&
STA.120+00

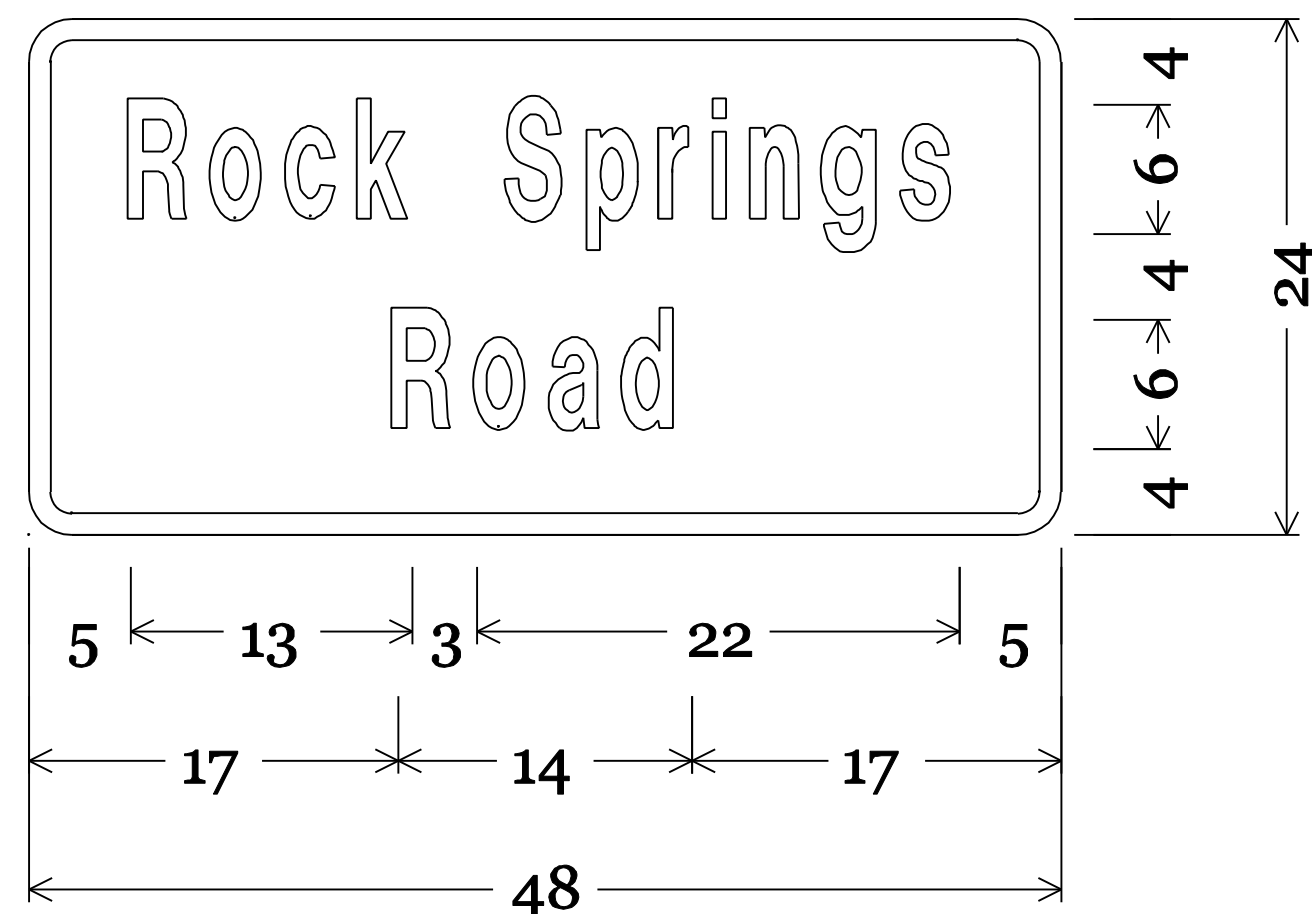

2" Radius, 1" Border, White on Green;
[Rock] B; [Springs] B; [Road] B;

GEORGIA
DEPARTMENT
OF
TRANSPORTATION

- NO SCALE -

REVISION DATES

NO.	DATE	DESCRIPTION

STATE OF GEORGIA
DEPARTMENT OF TRANSPORTATION

OFFICE: SIGN DETAILS

DRAWING No.
26-

SECTION 3 SIGN DESIGN STANDARDS

3.1 General Sign Guidelines

The following are design guidelines regarding the development of signing and pavement marking plans:

1. Sign sizes are determined by the roadway classification. The standard sign size (as defined in the *Standard Highway Signs* booklet and MUTCD Sections 1A-11 and 12) shall be used on two-lane and four-lane roads regardless of speed limit; on four-lane divided roads with speed limits less than 55 miles per hour (mph); and on five-lane roads with speed limits of 45 mph or less. With the exception of route confirmation signing, the expressway sign size is to be used on divided four-lane roads with speed limits of 55 mph or greater and on five-lane roads with speed limits greater than 45 mph. The freeway sign size is to be used on all limited-access roads.
2. Single-plate signs greater than 9 square feet in area or greater than 48 inches in width shall be erected on two posts.
3. Type 1 material is used on signs with areas less than or equal to 9 square feet, while Type 2 material is used on signs greater than 9 square feet in area. Type 1 and Type 2 material refers to the sign blank itself. The difference between Type 1 and Type 2 material is the thickness of the sign blank (.08 inch for Type 1 and .10 inch for Type 2).
4. The second specification in the signing pay items refers to reflective sheeting. Type 3 is an encapsulated, prismatic lens that is commonly referred to as high-intensity. Type 9 is a wide-angle prismatic lens and is also referred to as very high intensity. The use of each type of reflective sheeting is defined in the following subsection.
5. Signs shall not be placed back-to-back on one post unless they are identical in size and shape.

3.2 Regulatory Signs

All red series signs (R1-1, R1-2, R1-3p, R5-1, and R5-1a) shall have Type 9 (very high intensity) reflective sheeting backgrounds. All other regulatory signs shall have Type 3 (encapsulated lens) reflective sheeting backgrounds unless specified otherwise.

3.2.1 Stop Signs (R1-1)

Stop signs on state routes or on roads approaching state routes shall be a minimum of 36 inches in width.

3.2.2 Yield Signs (R1-2)

Yield signs on state routes or on roads approaching state routes shall be a minimum of 36 inches in width on conventional roads and 48 inches in width on expressways.

3.2.3 Speed Limit Signs (R2-1)

Speed limits on non-interstate roads should be confirmed after every junction with a numbered (state or U.S.) route. In rural areas in the absence of junctions with numbered routes, speed limits are to be confirmed at 2-mile intervals and at political boundaries. In more developed or higher vehicular volume areas, this interval should be reduced based on traffic engineering judgment. Speed limit signs are also placed at speed limit changes.

3.2.4 Right Lane Must Turn Right Signs (R3-7)

Right lane must turn right signs should be used when a right turn lane is long enough to contain three or more turn arrows.

3.2.5 Keep Right Signs (R4-7)

R4-7 signs (keep right) should be installed only at the beginning of a physical median (raised or depressed) and on raised medians only when the median width (face-of-curb to face-of-curb distance) is 4 feet or greater. “Keep right” signs are not intended for use at intermediate median openings.

3.2.6 Do Not Enter Signs (R5-1)

R5-1 signs (do not enter) should be placed on the outside shoulder and should not be placed more than 50 feet from the median nose station measured along the roadway.

3.2.7 Wrong Way Signs (R5-1a)

R5-1a signs (wrong way) should be placed 200 feet from R5-1 (do not enter) signs.

3.2.8 Divided Highway Crossing Signs (R6-3)

R6-3 signs (divided highway crossing) should be used under R1-1 signs only on four-lane divided roadways. R6-1 signs (one way) should be used on all divided roadways with medians that are greater than 30 feet wide. Divided roadways with medians less than 30 feet wide should not include R6-1 signs.

3.2.9 State Line Signing

[Figure 3-1](#) provides guidelines for signs to be installed on all non-limited-access routes entering the state.

3.3 Warning Signs

All warning signs on State Routes shall have Type 9 (very high intensity) reflective sheeting backgrounds and shall be a minimum of 36 inches. The setback distance for intersection warning signs shall be as recommended in the MUTCD. This distance shall be measured from either the radius point of the crossroad when there is no deceleration lane or from the beginning of the taper for a deceleration lane. When both conditions exist at the same location, the setback distance shall be measured from the beginning of the taper for the deceleration lane. W3-1 and W3-3 signs may be measured from the intersection stopping point (stop bar). W3-5 signs may be used in conjunction with speed limit reductions and shall be placed in accordance with the MUTCD.

3.3.1 Road Name Signs Used in Conjunction with Warning Signs (W16-8)

These signs are supplemental to warning signs and shall have yellow reflectorized backgrounds with black legends, borders, and symbols.

W16-8 signs (road name signs) shall be used in rural areas when the side road has a local name only. County road numbers shall not be used on W16-8 road name signs. W16-8 signs shall be installed below the “advance intersection warning” sign or the “signal ahead” sign (when used).

Six-inch lettering should be used on all W16-8 signs with the first letter capitalized only.

3.3.2 Bicycle Warning Signs (W11-1)

Bicycle warning signs should be placed on roadways intersecting those that have bicycle facilities, i.e. bike lanes or shoulders as depicted in [Appendix C](#).

3.3.3 Share the Road Signs (W16-1)

Share the road signs should not be used on designated marked or striped bicycling facilities. Roadways where paved shoulders or bicycle lanes are present will not be considered unless a special safety or road courtesy problem exists.

Signs should be considered for installation at locations that meet at least one or more of the following criteria:

- Where there is significant bicycle traffic (where motorists are likely to pass one or more bicyclists at least every three miles during peak traffic hours).
- After a bike lane ends and bicyclists and motorists enter a shared lane situation.
- On stretches of road that are used to connect two sections of a shared use path.
- Roadway sections with a significant history of bicycle crashes.
- Where there is a documented conflict or courtesy problem between motor vehicles.
- Where there are gaps in paved shoulders or where shoulder width is reduced.
- Where curb lane widths are narrower than 12' for multi-lane roadways, or narrower than 14' for 2-lane roadways. Roads and bridges where no reasonable alternate route exists.
- Where motorists and bicyclists have reduced sight distance.

3.4 Guide Signs

3.4.1 Route Markers

Route markers are either 24 inches in width (one- or two-digit numbers) or 30 inches in width (three-digit numbers) on all roads, except on limited-access roads, where they are either 36 inches in width (one- or two-digit numbers) or 45 inches in width (three-digit numbers). Cardinal direction signs are 24 inches in width on all roads, except on limited-access roads, where they are 30 inches in width.

When more than one type of route marker is used within an assembly, the order of preference is interstate, U.S., state (left to right, top to bottom). Within the same classification of route marker, the order of preference is from lowest number to highest number.

3.4.1.1 Placement Guidelines

Routes shall be confirmed after every junction with a numbered (state or U.S.) route. In rural areas in the absence of junctions with numbered routes, the routes are to be confirmed at 2-mile intervals. In more developed or higher vehicular volume areas, this interval should be reduced based on traffic engineering judgment.

[Figure 3-2](#), [Figure 3-3](#), and [Figure 3-4](#) provide typical route signing through different cases of intersecting routes. These figures show four-lane divided roads, but they also apply to two-lane roads. “Overhead span wire” signs should be used on approaches of all multilane state route approaches to other state routes. The use of overhead signs may eliminate the need for some shoulder-mounted signs.

3.4.2 Destination (D1), Distance (D2), and General Information (I) Signs

D1, D2, and I signs shall have green reflectorized backgrounds with white reflectorized legends, borders, and symbols. The borders shall be determined by sign height as shown in Table 3-1 below. The corner radii shall be as shown in the appendix of the Standard Highway Signs booklet.

Table 3-1: Sign Height and Border Width

Sign Height	Border
12”	3/8”
24”	1/2”
36”	5/8”
48”	3/4”

3.4.3 Directional Signs (DBRN) for Recreation and Cultural Interest Areas

Directional signs that are recreationally or culturally oriented shall be designated as DBRN signs. These signs shall have brown reflectorized backgrounds with white reflectorized legends, borders, and symbols. The borders shall be determined by sign height as shown in the table for D1, D2, and I signs. The corner radii shall be as shown in the appendix of the Standard Highway Signs booklet.

3.4.4 Tourist-Oriented Directional Signs (TODS)

Directional signs used for tourist-oriented purposes shall be designated as DB signs. They shall have blue reflectorized backgrounds with white reflectorized legends, borders, and symbols.

The borders for TODS shall be determined by sign height as shown previously in the table for D1, D2, and I signs. The corner radii shall be as shown in the appendix of the Standard Highway Signs booklet.

3.4.5 Lettering Guidelines

For non-interstate signs, there shall no more than a one-series difference between legends within a sign (i.e., use Series D and C, not Series D and B).

Refer to [Figure 3-5](#), [Figure 3-6](#), [Figure 3-7](#), and [Figure 3-8](#) for guidelines for lettering and sign layout for destination signs, road name signs, and political boundary signs.

3.5 School Zone and Pedestrian Crossing Signs

All school zone signs (S1-1, S2-1, S3-1, S4-3, S4-5 and the top portion of S5-1) and pedestrian crossing signs (W11-2) shall have Type 9 (very high intensity) fluorescent yellow-green reflective sheeting backgrounds. In addition, signs within the same assembly as those school zone signs specifically listed above and all regulatory signs placed as part of the school zone signing shall have Type 9 (very high intensity) reflective sheeting backgrounds of the appropriate color.

3.6 Overhead Span Wire Signs

Overhead span wire signs shall be used whenever there are multiple turn lanes in any one direction (dual left-turn lanes or dual right-turn lanes). On state routes, U.S. routes, or interstate ramps, overhead span wire signs should be used on the approaches of multilane state route approaches to other state routes.

Overhead span wire signs may be used in other situations based upon engineering judgment. If overhead span wire signs are used, some shoulder-mounted post signs can be omitted. See Overhead Signing Detail ([Figure 3-9](#)) for proper placement on the span wire.

Typical sign installations on surface streets will be post-mounted in accordance with the MUTCD. Certain special situations may warrant the installation of overhead signing. The following is a list of situations that may warrant the installation of overhead signing instead of a post-mounted sign, but each individual occurrence must be properly studied and concurrence received from the General Office of Traffic Operations before a final determination is made:

- Traffic volumes at or near capacity
- Complex intersection and/or signalization design
- Three or more traffic lanes in each direction
- Restricted sight distance
- Closely spaced intersections
- Interstate exit ramps
- High percentage of truck traffic
- Very high travel speeds
- Insufficient space for ground signs
- Dropping a through lane as a turn-only lane

All overhead span wire signs shall have Type 9 (very high intensity) reflective sheeting. Strain poles for overhead span wire signs shall be shown on construction and utility plan sheets in accordance with the [EDG](#).

It is recommended that the levels for drainage and utilities be turned on temporarily while placing strain poles to minimize conflicts.









3.7 Sign Posts

3.7.1 Description

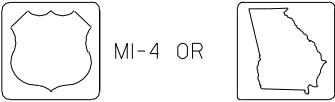
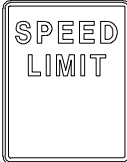
Type 7, 8, and 9 sign posts are square tube posts. Type 8 posts are larger than Type 9 posts. Type 9 posts are larger than Type 7 posts. Only Type 8 posts may be installed on a breakaway sign support. For reference, see Detail T-3A.

3.7.2 Wind Loads

The primary factor in selecting the appropriate type of post is the amount of resistance required to withstand the applied wind load. Use Detail T-3B to select the proper square tube post.

	SPECIAL DESIGN	2 LANE	--" x 48"
		4 LANE, 5 LANE, 4 LANE DIVIDED	--" x 48"
	SPECIAL DESIGN	2 LANE	72" x 48"
		4 LANE, 5 LANE, 4 LANE DIVIDED	72" x 48"
	M3-1, 2, 3, OR 4	SEE MUTCD FOR SIGN DIMENSIONS	
		SEE MUTCD FOR SIGN DIMENSIONS	
	R2-1	SEE MUTCD FOR SIGN DIMENSIONS	
	I550-1	2 LANE, 5 LANE	30" x 36"
		4 LANE, 4 LANE DIVIDED	30" x 36"
	R553-1	2 LANE, 5 LANE	24" x 30"
		4 LANE, 4 LANE DIVIDED	36" x 48"
	R560-1	2 LANE, 5 LANE	30" x 36"
		4 LANE, 4 LANE DIVIDED	30" x 36"
	R554-1	2 LANE, 5 LANE	24" x 30"
		4 LANE, 4 LANE DIVIDED	36" x 48"
	R560-2	2 LANE, 5 LANE	30" x 36"
		4 LANE, 4 LANE DIVIDED	30" x 36"

NOTES:

1. INSTALL SIGNS ON ALL ROUTES ENTERING THE STATE. IF THERE IS INSUFFICIENT SPACE FOR ALL SIGNS, THE ORDER OF PREFERENCE IS FROM TOP TO BOTTOM OF THIS CHART.
2. I550-1 SIGNS ARE INSTALLED ONLY IN COUNTIES THAT HAVE PERMITS TO OPERATE DETECTION DEVICES.

STATE LINE SIGNING SEQUENCE
(NON-LIMITED ACCESS)

FIGURE 3-1

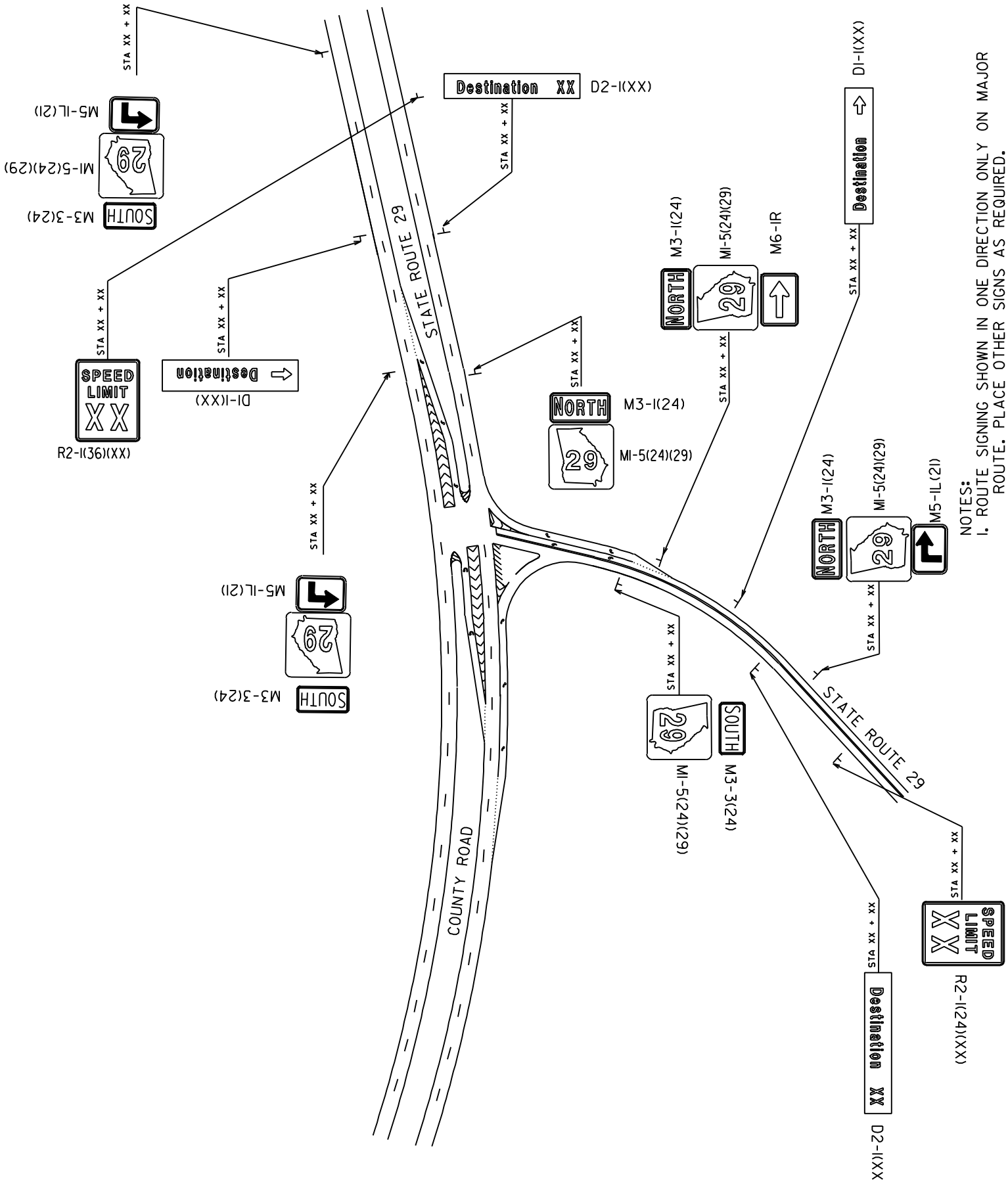

- NOTES:
1. ROUTE SIGNING SHOWN IN ONE DIRECTION ONLY ON MAJOR ROUTE. PLACE OTHER SIGNS AS REQUIRED.
 2. USE DESTINATION AND MILEAGE SIGNS AS NECESSARY.
 3. SEE MUTCD FOR ADDITIONAL GUIDANCE ON SIGN PLACEMENT

NO SCALE

ROUTE SIGNING FOR TURNING ROUTE

FIGURE 3-2

NO SCALE

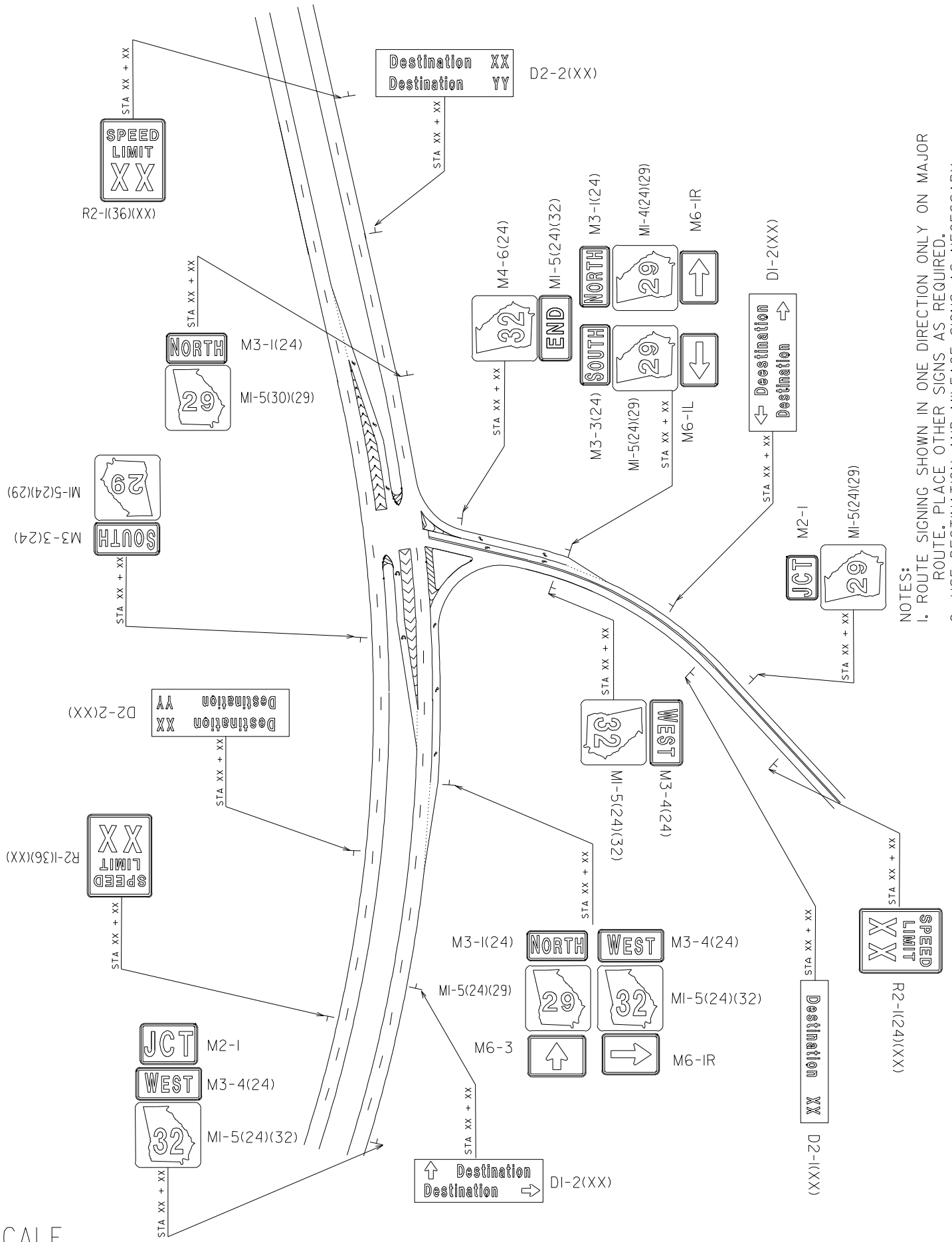

- NOTES:
1. ROUTE SIGNING SHOWN IN ONE DIRECTION ONLY ON MAJOR ROUTE. PLACE OTHER SIGNS AS REQUIRED.
 2. USE DESTINATION AND MILEAGE SIGNS AS NECESSARY.
 3. SEE MUTCD FOR ADDITIONAL GUIDANCE ON SIGN PLACEMENT

ROUTE SIGNING AT A "T" INTERSECTION

FIGURE 3-3

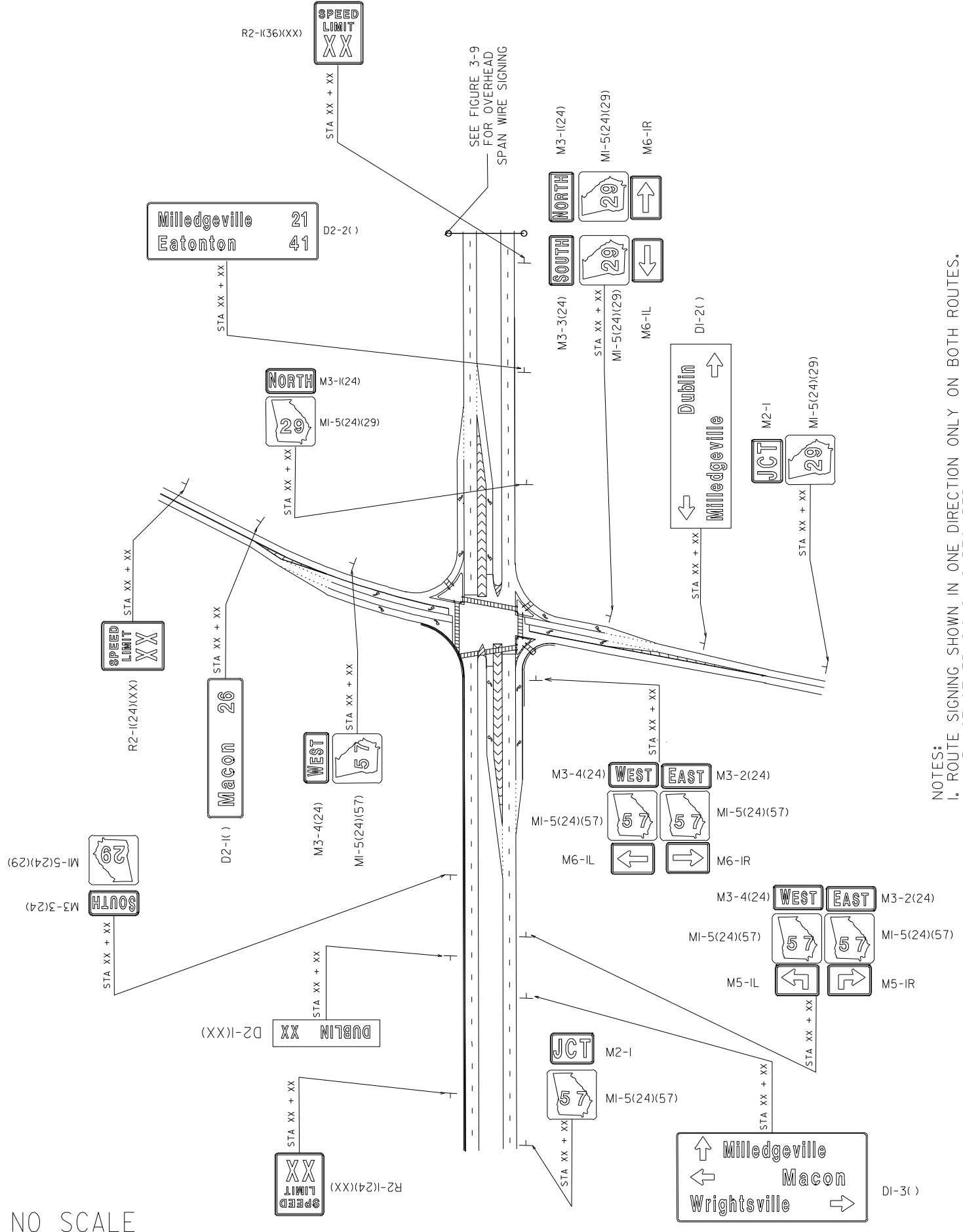

- NOTES:
1. ROUTE SIGNING SHOWN IN ONE DIRECTION ONLY ON BOTH ROUTES. PLACE OTHER SIGNS AS REQUIRED.
 2. USE DESTINATION AND MILEAGE SIGNS AS NECESSARY.
 3. SEE MUTCD FOR ADDITIONAL GUIDANCE ON SIGN PLACEMENT.
 4. THE USE OF OVERHEAD SIGNS MAY ELIMINATE THE NEED FOR SOME SHOULDER MOUNTED SIGNS.

ROUTE SIGNING AT CROSSING ROUTES

FIGURE 3-4

DETAILS OF ROAD NAME SIGNS



6" SER. "B", "C", OR "D"

W16-8 (48 [MAX])



6" SER. "B", "C", OR "D"
9" x 6" ARROW

W16-8a

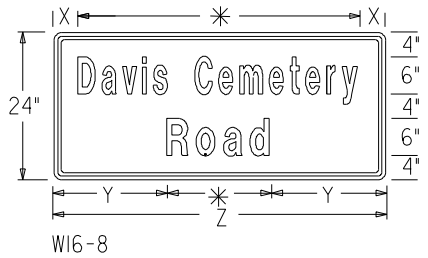

6" SER. "B", "C", OR "D"

6" SER. "B", "C", OR "D"

W16-8

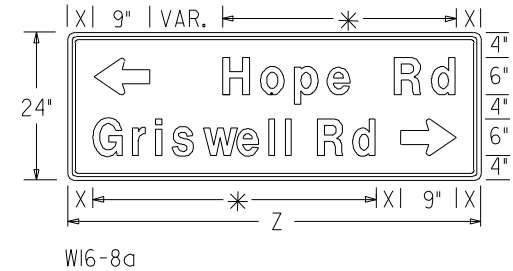

6" SER. "B", "C", OR "D"
9" x 6" ARROW

6" SER. "B", "C", OR "D"
9" x 6" ARROW

W16-8a

LEGEND:

- * DETERMINED BY LENGTH OF DESTINATION NAME
- X VARIABLE, 3" MINIMUM, 6" MAXIMUM
- Y (Z-WIDTH OF WORD) DIVIDED BY 2
- Z VARIABLE, MULTIPLE OF 6" (MAXIMUM OF 48", IF POSSIBLE)

NOTES:

1. IF A ROADNAME WILL NOT FIT WITHIN A 48 INCH WIDE SIGN BLANK, USE A TWO LINE SIGN WITH THE LEGEND "ROAD," "AVENUE," "DRIVE," ETC., SPELLED OUT ON THE BOTTOM LINE. DO NOT PLACE A PORTION OF A MULTI-WORD ROADNAME ON THE BOTTOM LINE.
2. ROADNAME SIGNS OVER 48 INCHES IN WIDTH SHALL REQUIRE TWO POST ERECTION FOR THE ENTIRE SIGN ASSEMBLY.
3. SEE MUTCD FOR ADDITIONAL GUIDANCE ON SIGN DETAIL

FIGURE 3-7

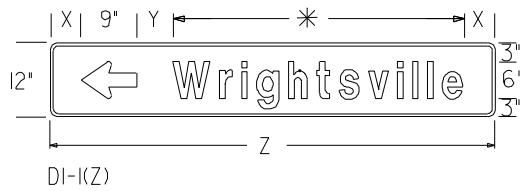

6" SER. "B", "C", OR "D"
9" x 6" ARROW

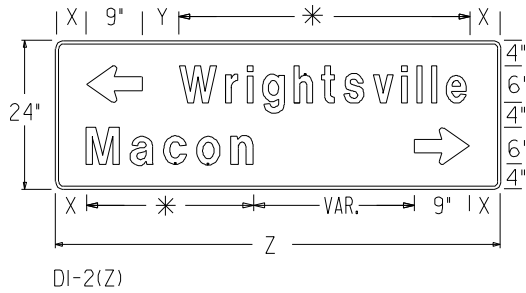

6" SER. "B", "C", OR "D"
9" x 6" ARROW
6" SER. "B", "C", OR "D"
9" x 6" ARROW

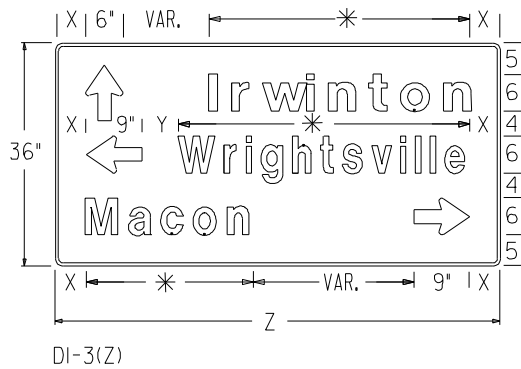

6" SER. "B", "C", OR "D"
6" x 9" ARROW
6" SER. "B", "C", OR "D"
9" x 6" ARROW
6" SER. "B", "C", OR "D"
9" x 6" ARROW

LEGEND:

- * DETERMINED BY LENGTH OF DESTINATION NAME
- X VARIABLE, 3" MINIMUM, 6" MAXIMUM
- Y VARIABLE, 3" MINIMUM, 6" MAXIMUM
- Z VARIABLE, MULTIPLE OF 6"

NOTES:

1. WHEN MORE THAN ONE ARROW ORIENTATION IS USED ON A SIGN, THE ARROW ORDER FROM THE TOP OF THE SIGN TO THE BOTTOM OF THE SIGN IS UP, LEFT, AND RIGHT.
2. SEE MUTCD FOR ADDITIONAL GUIDANCE ON SIGN DETAILS



6" SER. "B", "C", OR "D"



6" SER. "B", "C", OR "D"

6" SER. "B", "C", OR "D"

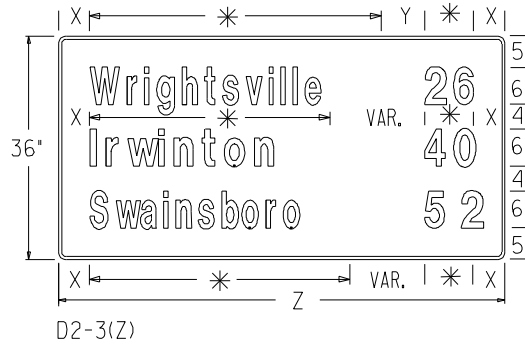

6" SER. "B", "C", OR "D"

6" SER. "B", "C", OR "D"

6" SER. "B", "C", OR "D"

LEGEND:

- * DETERMINED BY LENGTH OF DESTINATION NAME
- X VARIABLE, 3" MINIMUM, 6" MAXIMUM
- Y VARIABLE, 6" MINIMUM
- Z VARIABLE, MULTIPLE OF 6"

NOTE:

I. SEE MUTCD FOR ADDITIONAL GUIDANCE ON SIGN DETAILS

DETAILS OF ROAD NAME SIGNS

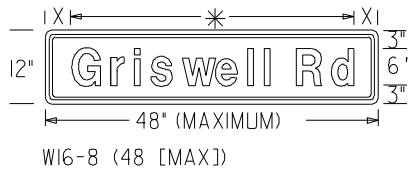

6" SER. "B", "C", OR "D"

W16-8 (48 [MAX])



6" SER. "B", "C", OR "D"
9" x 6" ARROW

W16-8a

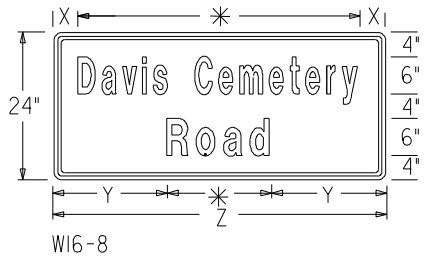

6" SER. "B", "C", OR "D"

6" SER. "B", "C", OR "D"

W16-8

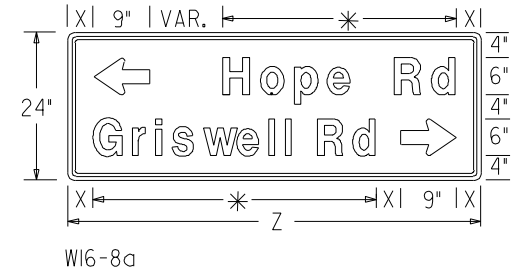

6" SER. "B", "C", OR "D"
9" x 6" ARROW

6" SER. "B", "C", OR "D"
9" x 6" ARROW

W16-8a

LEGEND:

- * DETERMINED BY LENGTH OF DESTINATION NAME
- X VARIABLE, 3" MINIMUM, 6" MAXIMUM
- Y (Z-WIDTH OF WORD) DIVIDED BY 2
- Z VARIABLE, MULTIPLE OF 6" (MAXIMUM OF 48", IF POSSIBLE)

NOTES:

1. IF A ROADNAME WILL NOT FIT WITHIN A 48 INCH WIDE SIGN BLANK, USE A TWO LINE SIGN WITH THE LEGEND "ROAD," "AVENUE," "DRIVE," ETC., SPELLED OUT ON THE BOTTOM LINE. DO NOT PLACE A PORTION OF A MULTI-WORD ROADNAME ON THE BOTTOM LINE.
2. ROADNAME SIGNS OVER 48 INCHES IN WIDTH SHALL REQUIRE TWO POST ERECTION FOR THE ENTIRE SIGN ASSEMBLY.
3. SEE MUTCD FOR ADDITIONAL GUIDANCE ON SIGN DETAIL

FIGURE 3-7

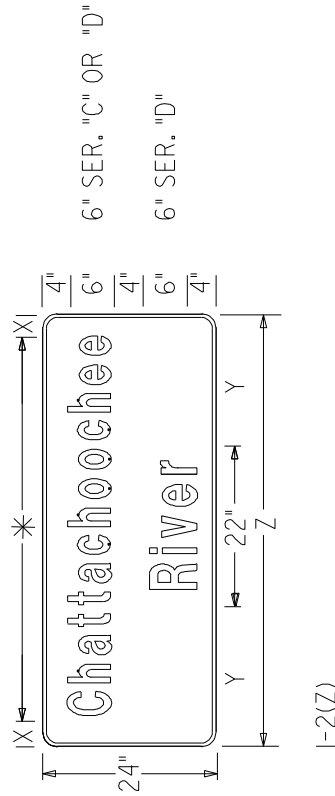
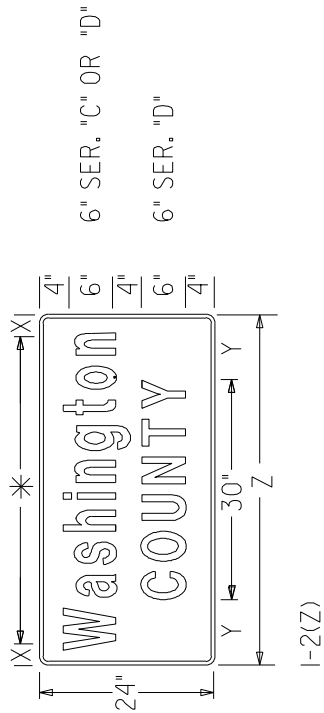
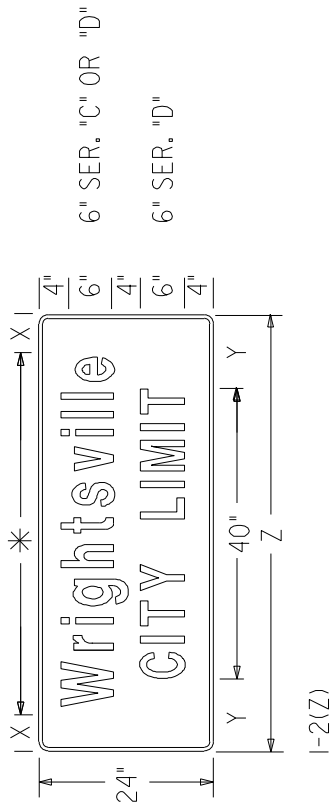

- LEGEND:
- * DETERMINED BY LENGTH OF DESTINATION NAME
 - X VARIABLE, 3" MINIMUM, 6" MAXIMUM
 - Y (Z MINUS WIDTH OF LEGEND) DIVIDED BY 2
 - Z VARIABLE, MULTIPLE OF 6"

SINGLE TURNING LANE



R3-5L

NO NUMBERED ROUTE
(CENTER SIGN OVER LANE)

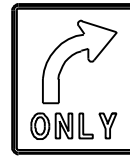

R3-5R



M-SPECIAL #

NUMBERED ROUTE
(CENTER SIGN ASSEMBLY OVER LANE)

DUAL TURNING LANES



R3-5L

NO NUMBERED ROUTE
(CENTER SIGNS OVER EACH LANE)

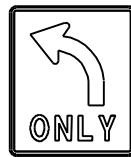

R3-5L

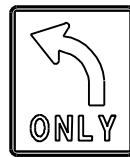

R3-5L



M-SPECIAL #

NUMBERED ROUTE
(CENTER 3-5L OVER EACH TURN LANE)
(CENTER SHIELD(S) OVER LANE LINE)

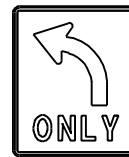

R3-5L

ADVANCE TURN LANE

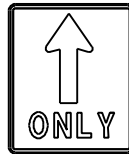

R3-5T

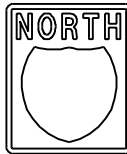

M-SPECIAL #

(CENTER SIGN ASSEMBLY OVER LANE)

CONFIRMATION

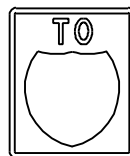

M-SPECIAL #

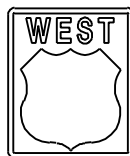

M-SPECIAL #



M-SPECIAL #

(CENTER SIGN ASSEMBLY OVER ALL THROUGH LANES)

NOTES:

- DO NOT USE R3-5T OR R3-5T_a SIGNS IN CONJUNCTION WITH CONFIRMATION SIGNS OR TO DESIGNATE THROUGH LANES UNLESS ROADWAY GEOMETRY IS UNCLEAR.
- ADVANCE TURN LANE SIGNING IS USED WHEN A THROUGH LANE TRANSITIONS TO A TURN LANE AT AN INTERSECTION AND SIGNING IS NEEDED BEFORE AN INTERVENING INTERSECTION OR INTERSTATE RAMP.

SECTION 4 LOCATION AND SEQUENCE OF SIGNS (INTERSTATE/LIMITED ACCESS)

To provide for proper spacing between signs and to provide consistent information to the motoring public, a standard sequence and spacing are desirable when exiting and entering an interstate or other limited-access facility. It is desirable to locate signs 800 feet apart; however, because of physical constraints, this may not be possible. As a minimum, the designer should maintain spacing at 500 feet between signs.

4.1 Exit Signing

The timely display of information provides the road user exiting a limited-access facility with critical information to make a decision without being confused. The MUTCD classifies interchanges as follows:

Major interchanges – Subdivided into two categories: (a) interchanges with other expressways or freeways; or (b) interchanges, other than those named in (a), with high-volume multilane highways, principal urban arterials, and major rural routes where the volume of interchanging traffic is heavy or includes many road users unfamiliar with the area.

Intermediate interchanges – Interchanges with urban or rural routes not in the category of major or minor interchanges as defined herein.

Minor interchanges – Interchanges with local, very light traffic, such as interchanges with land service access roads. Where the sum of exit volumes is estimated to be lower than 100 vehicles per day in the design year, the interchange is classified as minor.

For major interchanges, two advance guide signs shall be used, but three signs are preferred. Placement should be at 2 miles, 1 mile, and 0.5 mile in advance of the theoretical gore of the exit when three signs are used. When only two advance guide signs are used, they shall be placed 1 mile and 0.5 mile in advance of the theoretical gore of the exit. Interstate-to-interstate interchange advance guide signs should be diagrammatic (see the current version of the MUTCD).

For intermediate and minor interchanges, two advance guide signs should be used. Placement should be at 1 mile and 0.5 mile from the theoretical gore of the exit.

All interstates with three or more lanes in each direction require overhead guide signs. All interstates with four or more lanes in each direction require signs to be placed over travel lanes.

All interchanges require an overhead exit guide sign placed at the theoretical gore of the exit ramp. [Figure 4-1](#) indicates the locations of the required exit signs.

Rest areas require only one advanced exit sign placed 1 mile in advance of the theoretical gore of the ramp. An exit gore sign is required at the physical gore of the exit ramp.

To accommodate physical constraints associated with the location of advance exit signs, consideration may be given to moving the location of the advance signs up to 0.5 mile and adjusting the legend in 0.25-mile increments.

All signing should display the same destinations and order on all signs in the same direction. The closest destination should be listed first. If the destinations include a road, the road should be listed first on the signs.

For interchanges where it is desirable to indicate more than three destinations, a supplemental sign may be used. Supplemental guide signs should be located between the 0.5-mile and 1-mile exit signs.

The use of other signs within the exit sign sequence is to be avoided unless the signs are political boundary signs or required regulatory signs, warning signs, or logo signs. When possible, logo signs should be placed before the 1-mile sign ([see Section 11](#)).

The default background color for all guide signs is green. For guide signs that are clearly associated with cultural and recreational destinations, the background shall be brown. Interstate shields and guide signs for evacuation routes shall have a blue background. In addition, information signs concerned with road user services shall have a blue background. These signs include ride share, 511, hospital, rest area, dial 911, and tourist information signing.

4.2 Post-Interchange Sequence Signing

If an interchange is for new traffic that is entering the facility, the sign sequence must identify the route and speed limit. Interchanges associated with traffic that is continuing on the facility (e.g., rest areas, weigh stations) do not require a post-interchange sign sequence. The standard sequence of signs to be provided is described below and is shown in [Figure 4-2](#).

Merge Sign – If the entrance ramp is a non-continuing lane, the merge sign shall be a W4-1X (48), where the X shall be either R (for right) or L (for left) depending on the side of the mainline road on which the ramp is located. The W4-1X (48) sign shall be located 500 feet in advance of the physical gore of the entrance ramp. The W4-5 sign shall be used on entrance ramps when the mainline W4-1 is not visible from the ramp.

Added Lane Sign – If the entrance ramp is a continuing lane, the added lane sign shall be a W4-3X (48), where the X shall be either R (for right) or L (for left) depending on the side of the mainline road on which the ramp is located. The W4-3X(48) sign shall be located as close as possible to the physical gore of the entrance ramp and where the sign may be viewed by both mainline and entrance ramp traffic. The W4-6 sign shall be used on entrance ramps when the mainline W4-3 sign is not visible from the ramp.

Route Confirmation Sign – The route shield(s) and direction(s) should be indicated 500 feet beyond the end of the entrance ramp.

Speed Limit Sign – The speed limit sign should be placed 1,000 feet beyond the route confirmation sign.

Minimum Speed Sign – The minimum speed sign should be placed 1,000 feet beyond the speed limit sign (when used).

Distance Sign – As an option, a distance sign may be used that gives the distance to the next exit and a control city. This sign should be located 1,000 feet beyond the speed limit sign in place of the minimum speed sign. The mileage shall be the distance to the center of the destination. Any destinations listed on the sign other than the control city shall be associated with the next exit.

In locations with closely spaced interchanges, the post-interchange sequence may have to be altered or eliminated because of exit signing for the next interchange.

4.3 Milepoint Signs

D10-4 signs should be placed every 1 mile in rural areas. D10-5 signs should be placed every 0.2 mile in urban areas.

4.4 Political Boundary Signs

Political boundary signs on the interstate are required at the boundary of political entities (county and city). These signs must be placed as close to the actual boundary as possible and shall have a green background. If the political entity has a speed detection permit, then an I550-1 sign (speed checked by detection devices) should be located 500 feet beyond the political boundary sign (see [Figure 4-3](#)).

4.5 Waterway Signs

Signs indicating waterways shall be posted only if the waterway is located on the state map. These signs shall have a green background and shall be placed immediately prior to the waterway crossing.

4.6 Hospital Signs

Hospital signs are supplemental guide signs and shall have a blue background. Placement of these signs shall be in accordance with GDOT's Policy and Procedures (P&P) 6775-1.

4.7 Bridge Caution Signs

W8-13 signs (bridge ices before road) shall be located 500 feet in advance of any bridge structure.

4.8 No Trucks Over 6 Wheels Allowed in Left X Lanes Signs

R554-X signs (no trucks over 6 wheels allowed in left X lanes) are standard regulatory signs that are attached to overhead road bridge structures. The value of X is determined by subtracting 2 from the number of lanes (including a high-occupancy vehicle lane if present).

4.9 Truck Use I-285

The R554-11 sign (all thru trucks over 6 wheels must use I-285) is a standard regulatory sign that is attached to overhead road bridge structures (see [Figure 4-4](#)).

4.10 Emergency Parking Only Signs

R8-4 signs (emergency parking only) are standard regulatory signs that should be posted at 8- to 10-mile intervals.

4.11 Up to \$1,200 Fine for Throwing Trash on Highway Signs

R553-1 signs (up to \$1,200 fine for throwing trash on highway) are standard regulatory signs that should be posted at 8- to 10-mile intervals and at the state boundary (see [Figure 4-6](#)).

4.12 Slower Traffic Keep Right Signs

R4-3 signs (slower traffic keep right) are standard regulatory signs that should be posted at 6- to 8-mile intervals. This sign is to be posted on the left side of the road (in the median).

4.13 Keep Off Median Signs

R11-1 signs (keep off median) are standard regulatory signs that should be posted at 6- to 8-mile intervals in areas where there is a grassed median. This sign is to be posted on the left side of the road (in the median).

4.14 Miscellaneous Signs

R554-1 signs (lights on when raining), R560-1 signs (click it or ticket), R560-2 signs (they kill, don't do it), R570-1 & 570-2 "move over..." signs, and R570-3 & 570-4 "move accidents..." signs are regulatory signs that should be posted at approximately 20-mile intervals and at the state boundary ([Figure 4-5](#) & [Figure 4-6](#)).

4.15 Reduced Speed Ahead Signs

W3-5 signs (reduced speed ahead) are standard warning signs that shall be posted 1,000 feet in advance of all speed limit reductions.

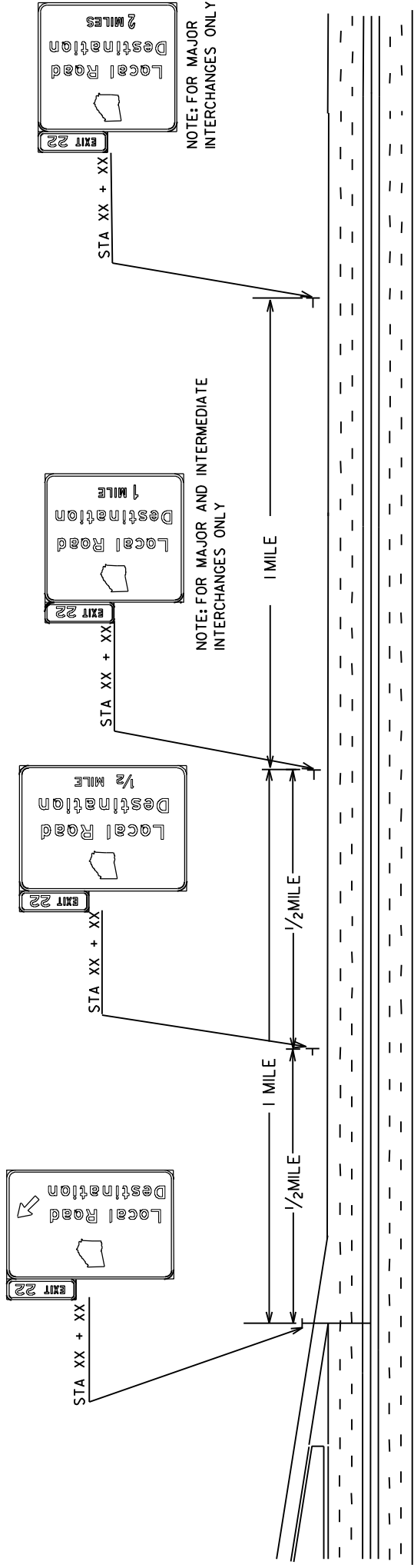

FIGURE 4-1 NORMAL EXIT SIGN SEQUENCE

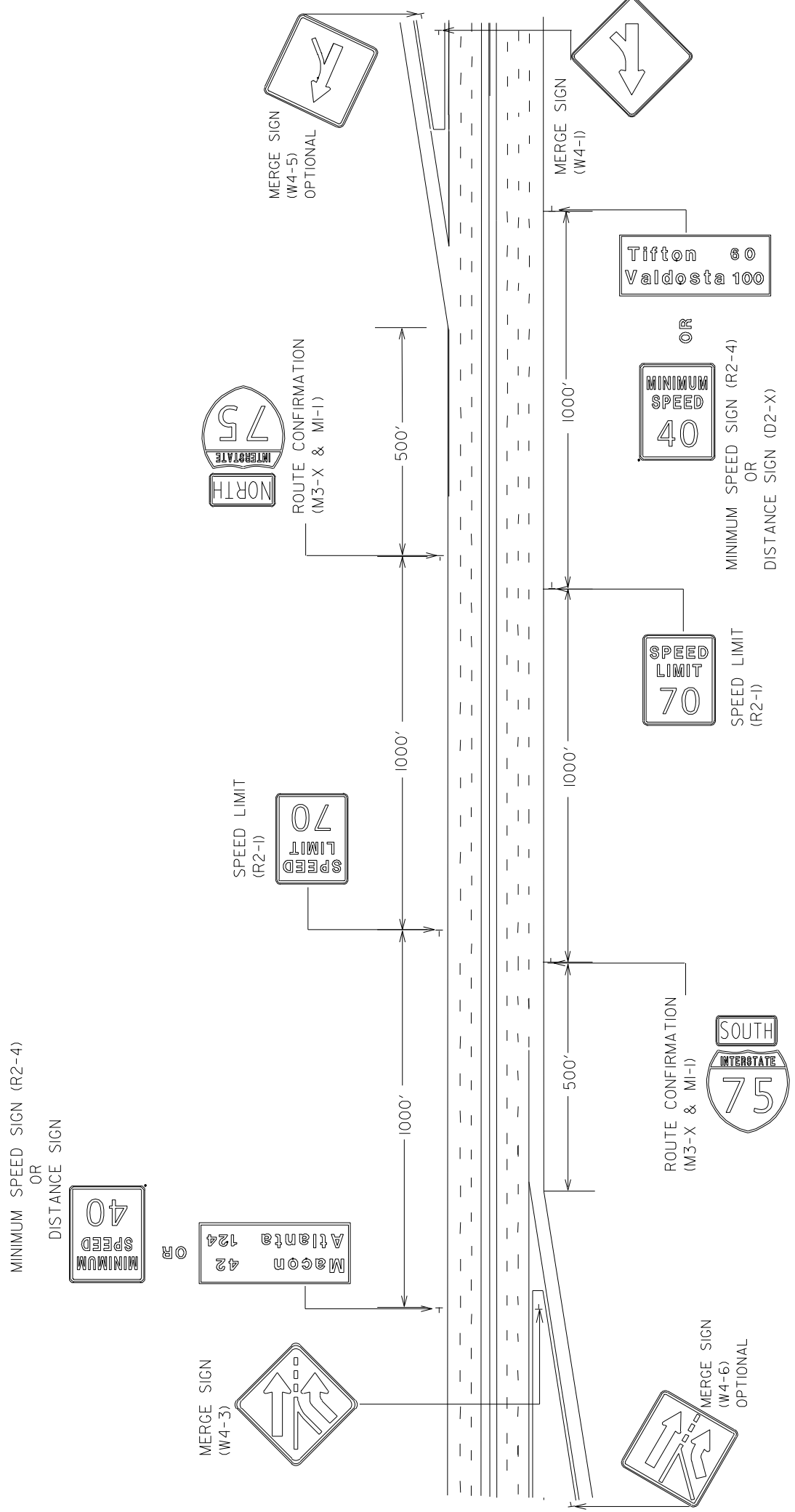
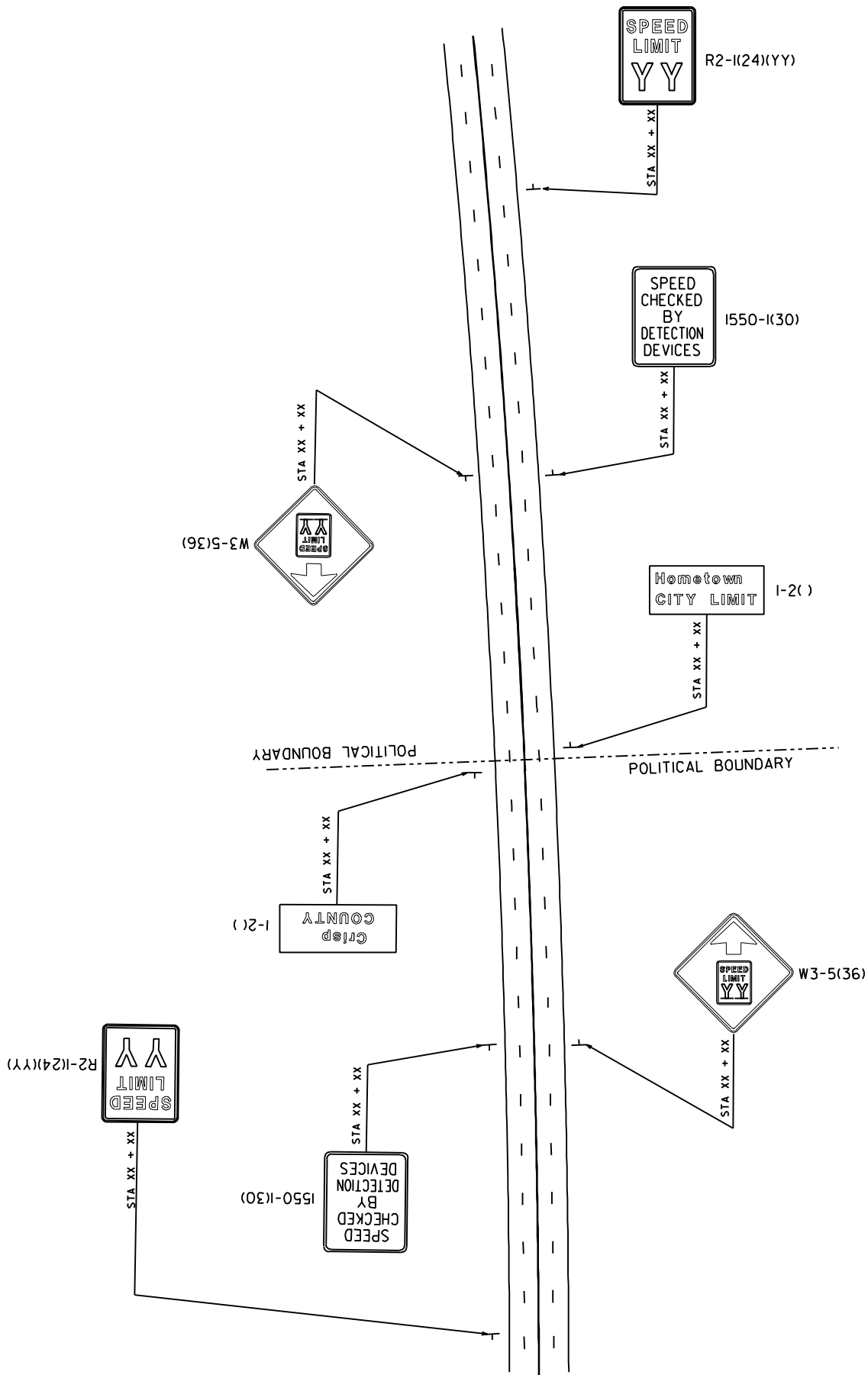

FIGURE 4-2 POST INTERCHANGE SIGN SEQUENCE



- NOTES:
1. SPACING BETWEEN SIGNS IS 500 FEET.
 2. SEE DETAILS OF POLITICAL BOUNDARY SIGNS FOR DESIGN OF THE I-2 SIGN.
 3. SPEED ZONE AHEAD (W3-5) SIGN IS NOT REQUIRED WHEN THE SPEED LIMIT DOES NOT CHANGE AT BOUNDARY.
 4. SPEED CHECKED BY DETECTION DEVICES (I550-I) SIGN IS NOT REQUIRED IN THE ABSENCE OF A SPEED DETECTION PERMIT.

NO SCALE

POLITICAL BOUNDARY SIGNING

FIGURE 4-3

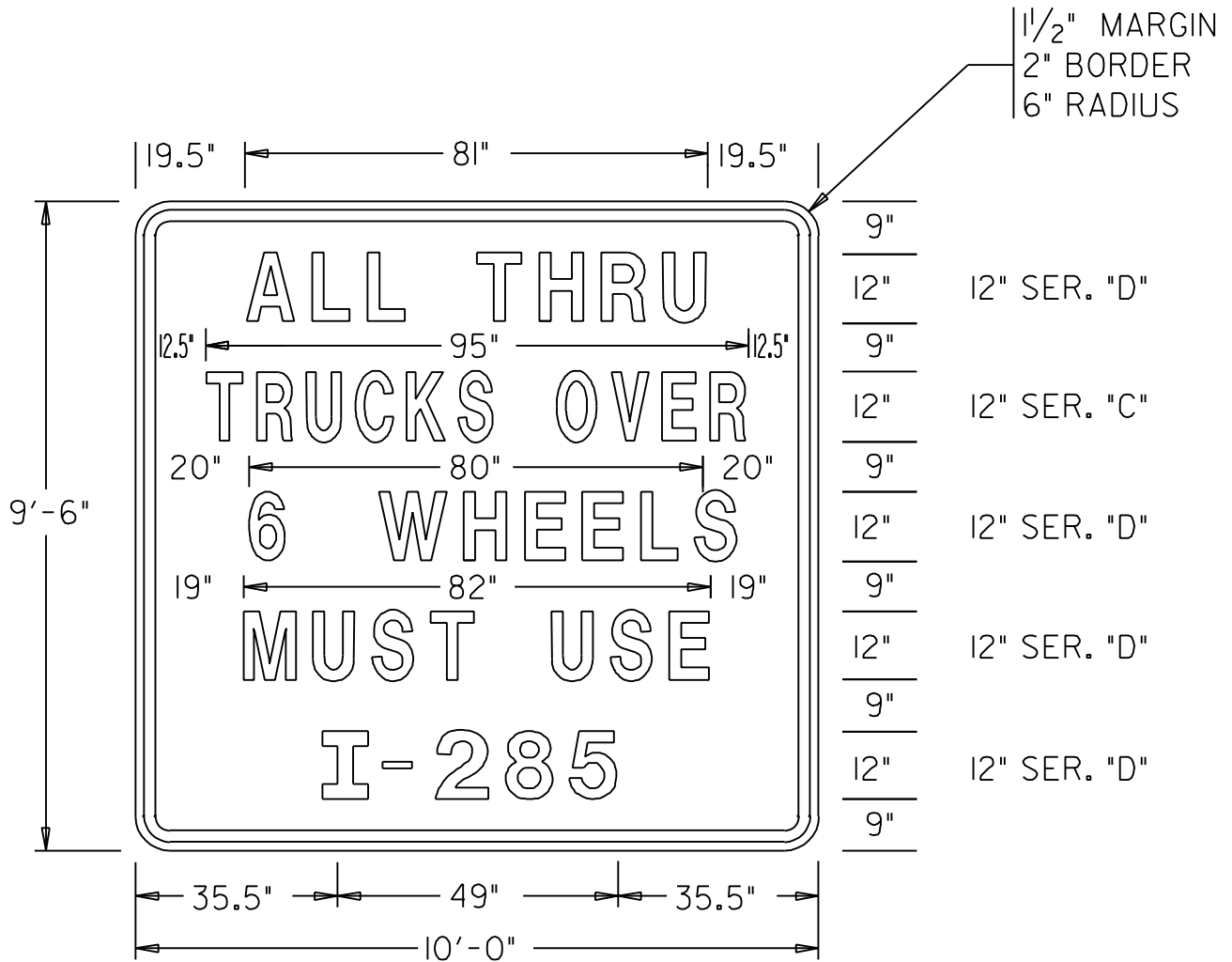

R554-II

SIGN SHALL HAVE WHITE REFLECTORIZED
BACKGROUND WITH BLACK LEGEND AND BORDER.

FIGURE 4-4 ALL THRU TRUCKS SIGN DETAILS

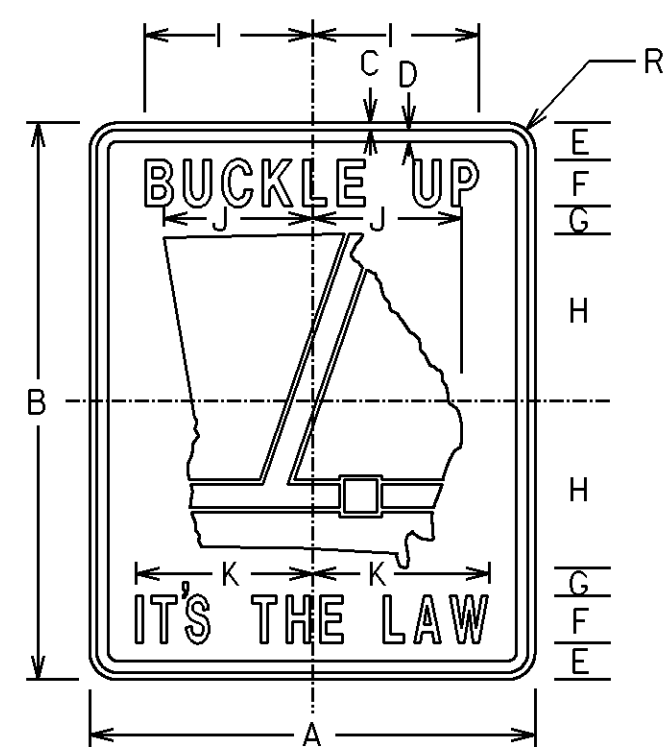

R560-1

SIGN	DIMENSIONS (INCHES)											
	A	B	C	D	E	F	G	H	I	J	K	R
MIN & STD	30	36	1/2	3/4	2 1/2	3C	1 1/2	11	8 1/2	10	11	1 7/8
FWY	48	60	3/4	1 1/4	4	5C	3	18	15 1/2	16	18	3

COLORS

STATE SHIELD & BORDER - RED (REFL)
 LEGEND & BELT - BLACK (NON-REFL)
 BACKGROUND - WHITE (REFL)

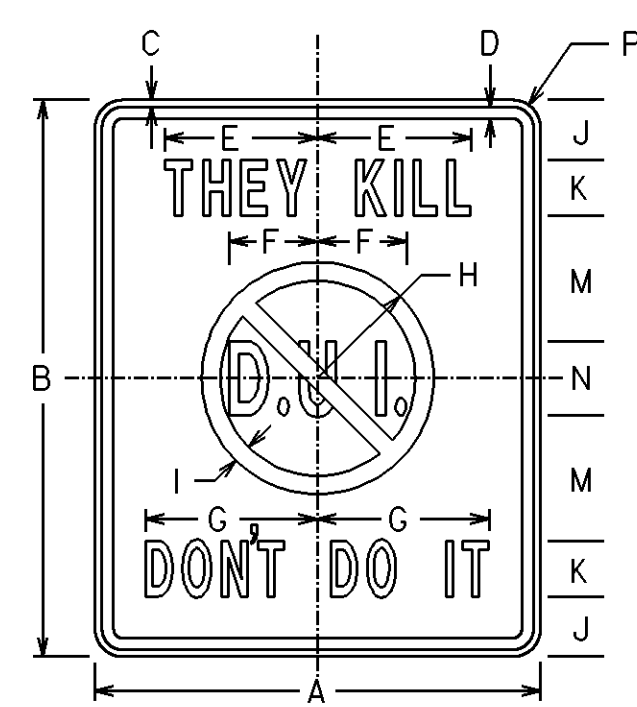
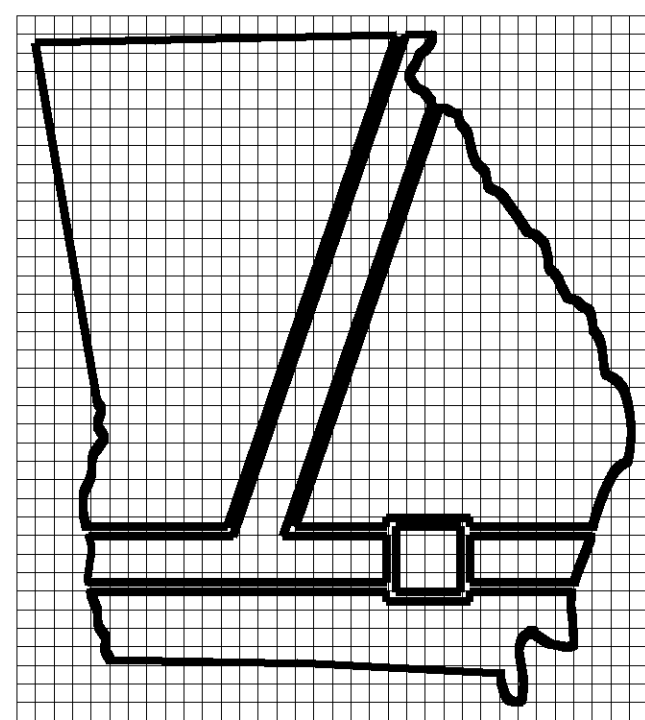

R560-2

SIGN	DIMENSIONS (INCHES)														
	A	B	C	D	E	F	G	H	I	J	K	L	M	N	P
MIN & STD	30	36	1/2	3/4	11	5	12 1/2	7 1/2	1 1/4	4	4C	3	4 1/2	5C	1 7/8
FWY	48	60	3/4	1 1/4	16 1/2	9 1/2	18 1/2	12 1/2	2	6 1/2	6C	5	8 1/2	8C	3

COLORS

CIRCLE & DIAGONAL - BLACK (REFL)
 LEGEND & BORDER - BLACK (NON-REFL)
 BACKGROUND - WHITE (REFL)

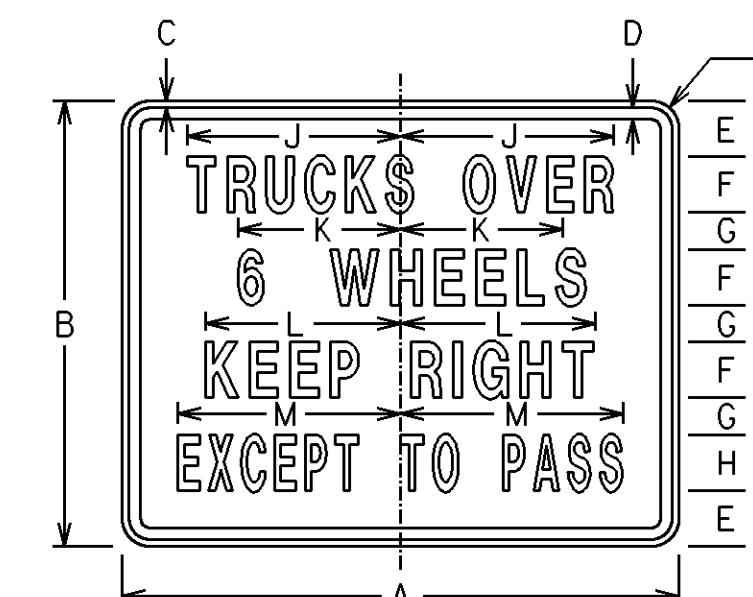

R560-3

SIGN	DIMENSIONS (INCHES)													
	A	B	C	D	E	F	G	H	J	K	L	M	R	
MIN & STD	36	30	1/2	3/4	3 1/2	3 1/2	3	3 1/2	14	10	11 1/2	11 1/2	1 7/8	
FWY	60	48	3/4	1 1/4	6	6C	4	6B	23	17 1/2	21	24	3	

COLORS

LEGEND & BORDER - BLACK (NON-REFL)
 BACKGROUND - WHITE (REFL)

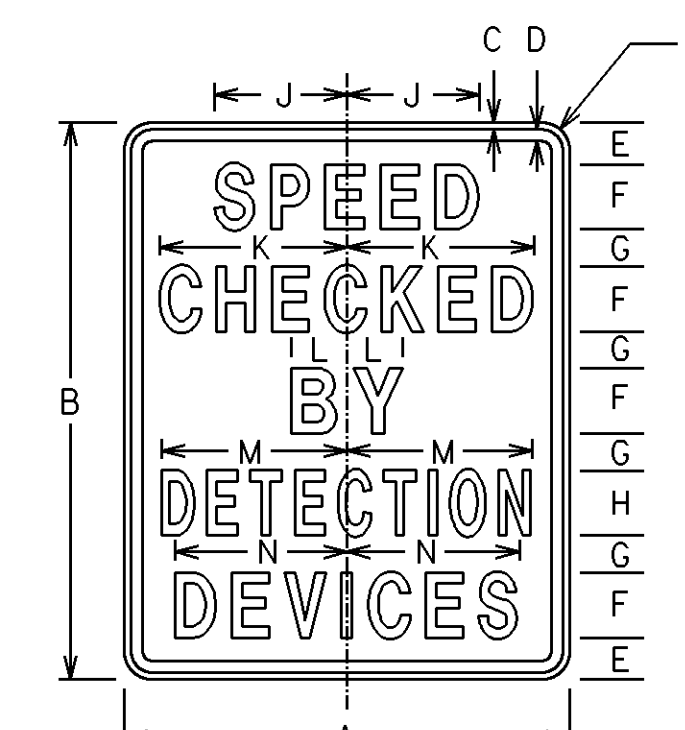

I550-1

SIGN	DIMENSIONS (INCHES)													
	A	B	C	D	E	F	G	H	J	K	L	M	N	R
MIN & STD	30	36	1/2	3/4	4	4D	2	4C	8 3/8	8 3/8	3 3/8	11 3/8	10 3/8	1 1/8
FWY	48	60	3/4	1 1/4	4 1/2	7D	4	7C	14 3/8	20 3/8	6	20	8 3/8	3

COLORS

LEGEND & BORDER - BLACK (NON-REFL)
 BACKGROUND - WHITE (REFL)

THE I550-1 SIGN SHALL BE ERECTED:

- ON EVERY HIGHWAY THAT COMPRISES A PART OF THE STATE HIGHWAY SYSTEM AT THAT POINT ON THE HIGHWAY WHICH INTERSECTS THE STATE LINE,
- AT THE TERMINI OF EVERY HIGHWAY THAT COMPRISES A PART OF THE STATE HIGHWAY SYSTEM WHICH BEGINS OR ENDS WITHIN THE STATE BOUNDARIES,
- ON EVERY HIGHWAY THAT COMPRISES A PART OF THE STATE HIGHWAY SYSTEM AT THAT POINT ON THE HIGHWAY WHERE TRAFFIC FROM OUTSIDE THE COUNTY FIRST ENTERS A COUNTY THAT HAS A PERMIT TO OPERATE SPEED DETECTION DEVICES, AND
- ON EVERY HIGHWAY THAT COMPRISES A PART OF THE STATE HIGHWAY SYSTEM AT THAT POINT ON THE HIGHWAY WHERE TRAFFIC FIRST ENTERS THE CORPORATE LIMITS OF ANY MUNICIPALITY THAT HAS A PERMIT TO OPERATE SPEED DETECTION DEVICES.

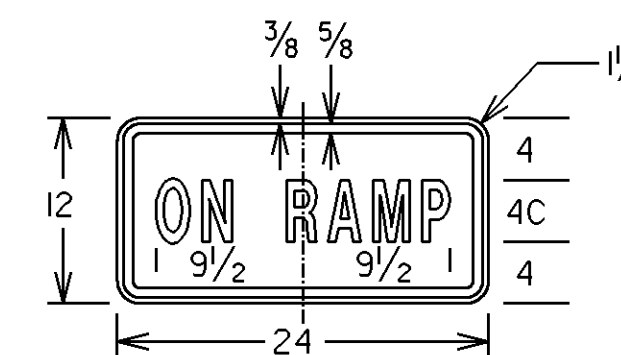

R8-3aP

COLORS

LEGEND & BORDER - RED (REFL)
 BACKGROUND - WHITE (REFL)

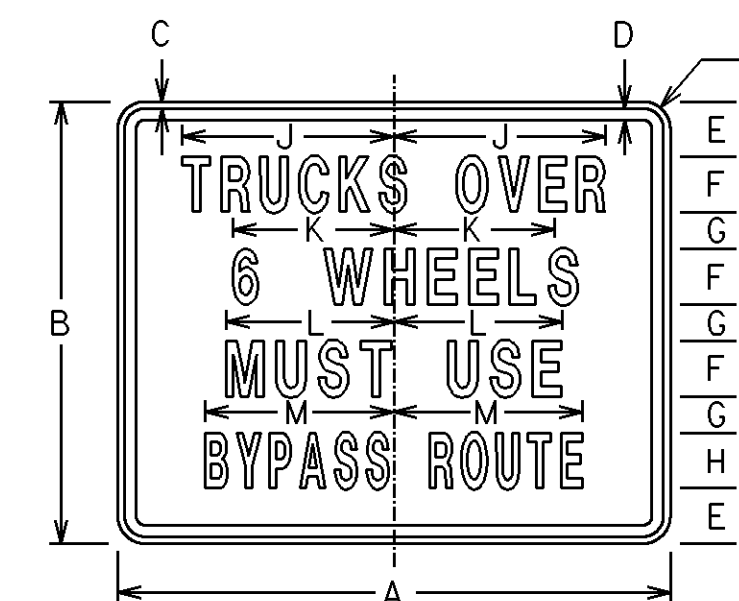

R560-4

SIGN	DIMENSIONS (INCHES)													
	A	B	C	D	E	F	G	H	J	K	L	M	R	
MIN & STD	36	30	1/2	3/4	3 1/2	3 1/2	3	3 1/2	14	10	10	12 1/2	1 7/8	
FWY	60	48	3/4	1 1/4	6	6C	4	6C	23	17 1/2	17 1/2	25 1/2	3	

COLORS

LEGEND & BORDER - BLACK (NON-REFL)
 BACKGROUND - WHITE (REFL)

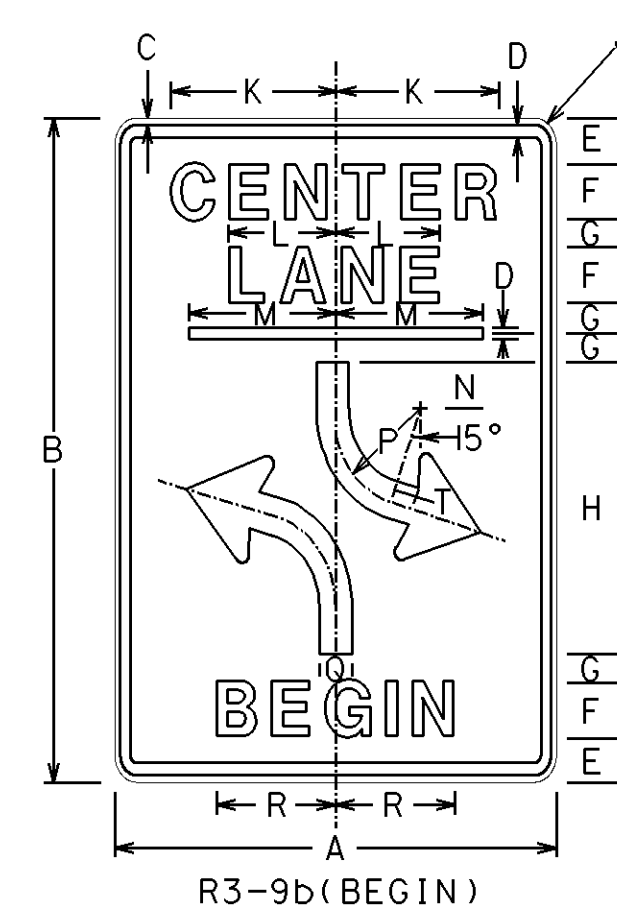

R3-9b(BEGIN)

END

R3-9b(END)

SIGN	DIMENSIONS (INCHES)																		
	A	B	C	D	E	F	G	H	J	K	L	M	N	P	Q	R	S	T	
STD & MIN	24	36	3/8	5/8	2 1/2	3E	1 1/2	16	1 1/2	8 3/8	5 3/4	8	2 1/2	6	2	6 3/8	4 3/8	1 1/2	
SPECIAL	36	48	3/8	5/8	3 1/2	5E	1 1/2	20	2 1/4	11 3/8	9 1/2	12	3	8	3	7 1/8	4 3/8	2	

COLORS

LEGEND & BORDER - BLACK (NON-REFL)
 BACKGROUND - WHITE (REFL)

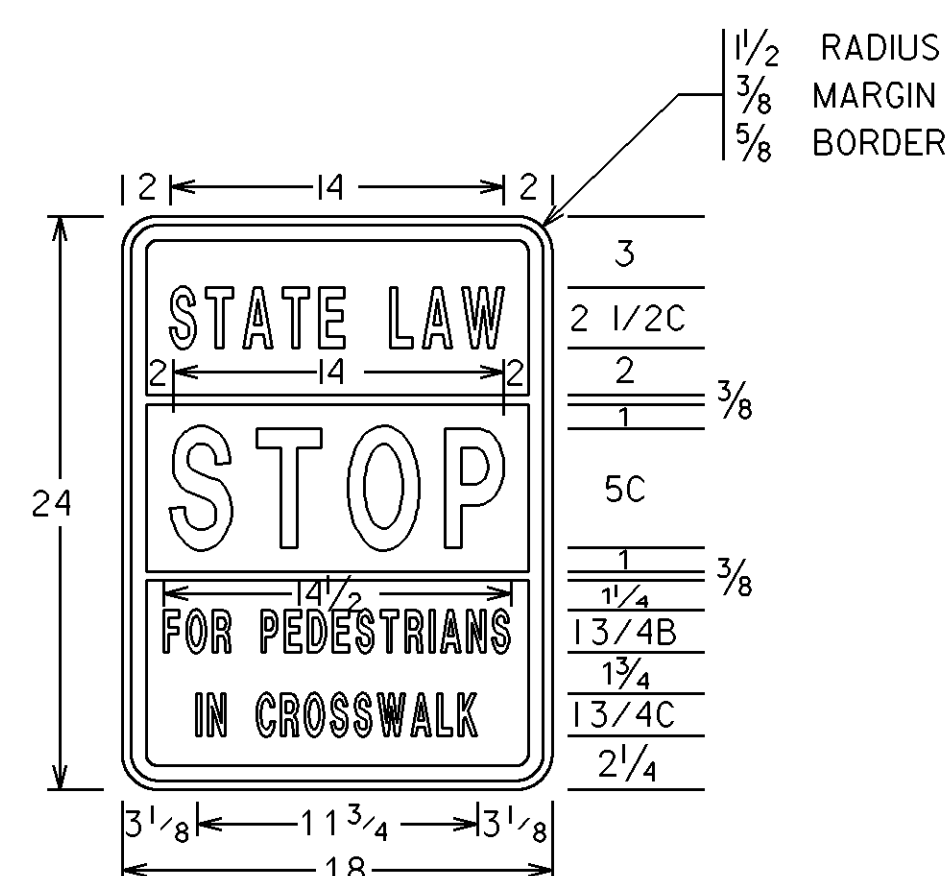

R560-5

COLORS

LEGEND & BORDER - BLACK (NON-REFL)
 WORD "STOP" - RED (REFL)
 BACKGROUND - WHITE (REFL)

FIGURE 4-5

DATE	REVISIONS	GEORGIA DEPARTMENT OF TRANSPORTATION OFFICE OF TRAFFIC SAFETY & DESIGN DETAILS OF REGULATORY SIGNS SHEET 10F 2 NO SCALE JANUARY 2000
5-24-00	ADDED R9-8 DETAIL	
1-21-03	DELETED R1-4 SIGNS	
1-21-03	REV SIGN CODES FOR R3-9 SIGNS	

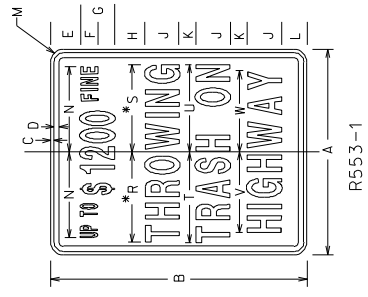
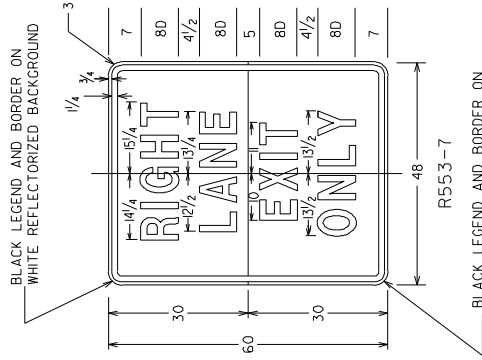

SIGN	DIMENSIONS (INCHES)																		
	A	B	C	D	E	F	G	H	J	K	L	M	N	R	S	T	U	V	W
STD & MM	24	30	3/8	3/8	3/2	2B	4C	3 1/2	4C	2	3 1/2	10	10 1/2	10 1/2	10 1/2	10 1/2	10 1/2	10 1/2	9 1/2
EXPMY	36	48	3/8	3/8	6	3B	6C	6	6C	3	6	2 1/4	15	15 1/2	15 1/2	15 1/2	15 1/2	15 1/2	14 1/4
FWY	48	60	3/4	1/4	7	4B	7C	8	8C	4	6	3	20	21	20 1/2	21 1/2	20 1/4	18 1/4	19

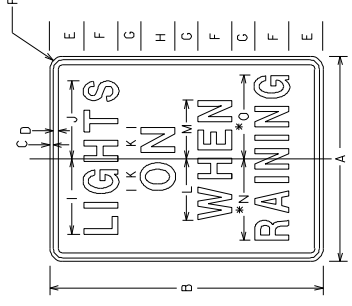

SIGN	DIMENSIONS (INCHES)																		
	A	B	C	D	E	F	G	H	I	J	K	L	M	N	O	P			
STD & MM	24	30	3/8	3/8	3/2	4D	2 1/4	4E	1B 1/2	9 1/4	4	6 3/4	7 1/4	9 1/4	9 1/4	1 1/2			
EXPMY	36	48	3/8	3/8	6	6D	4	6E	1B 1/2	13 1/2	5 1/2	10 1/4	10 1/4	14 1/4	14 1/4	2 1/4			
FWY	48	60	3/4	1/4	7 1/4	7 1/4	8D	4 1/2	8E	17 1/2	11 1/2	14 1/2	13 1/2	18 1/2	19 1/2	3			

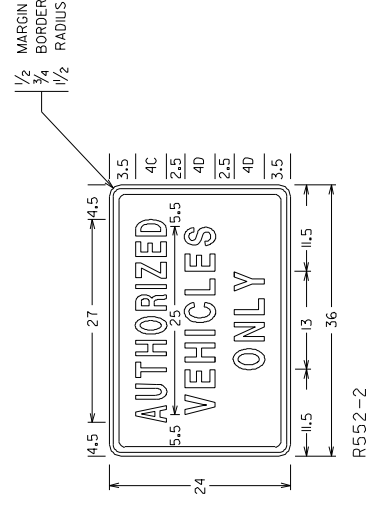
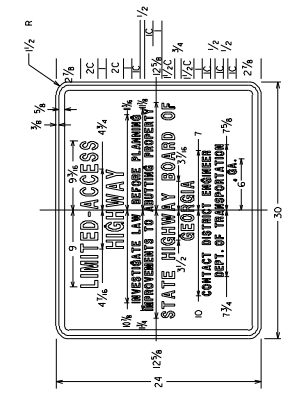

DATE	REVISIONS

GEORGIA DEPARTMENT OF TRANSPORTATION
OFFICE OF TRAFFIC SAFETY & DESIGN

DETAILS OF REGULATORY SIGNS
SHEET 2 OF 2

NO. SCALE: JANUARY 2000

FIGURE 4-6

SECTION 5 SPECIFIC SIGN SEQUENCING FOR PARTICULAR APPLICATIONS

The sequence and spacing of signs for specific applications are defined and should be adhered to using sound engineering judgment. These particular applications are lane reduction, lane drop (continuous lane), and lane drop (auxiliary lane).

5.1 Lane Reduction for Interstates

The lane reduction application is used for ending a lane between interchanges. See [Figure 5-1R](#) for a right-lane drop and [Figure 5-1L](#) for a left-lane drop. These figures indicate the four warning signs, the sign spacing, and the pavement marking spacing required. The signs are:

- W20-5AX (0.5 mile) – Right/left lane ends in 0.5 mile
- W20-5AX (1500 FT) – Right/left lane ends in 1,500 feet
- W9-1X – Right/left lane ends
- W4-2X – Graphical right/left lane ends

5.2 Lane Reduction for Conventional Roads

If there is insufficient room for all three lane width transition signs, omit the W9-2 sign. If there is insufficient room for the remaining two lane width transition signs, use the W4-2 sign only. The lane reduction signing requirements are shown on [Figure B-1](#).

5.3 Lane Drop – Continuous to Exit Lane

The lane drop – continuous to exit lane application is used for ending a lane as part of an exit where the lane has been continuous prior to the exit. [Figure 5-2](#) indicates the specific signs and the sign and pavement marking spacing required. The only sign required other than the exit signing is the “right lane exit only” sign ([R553-7](#)).

5.4 Lane Drop – Auxiliary Lane

The lane drop – auxiliary lane application is used for ending a lane as part of an exit where the lane has not been continuous prior to the exit. [Figure 5-3](#) indicates the specific signs and the sign and pavement marking spacing required. The only sign required other than the exit signing is the “right lane exit only” sign ([R553-7](#)).

5.5 Lane Drop – Drop Option

The lane drop – drop option application is used for ending a lane as part of an exit when a second exit lane has the option of exiting. [Figure 5-4](#) indicates the specific signs required.

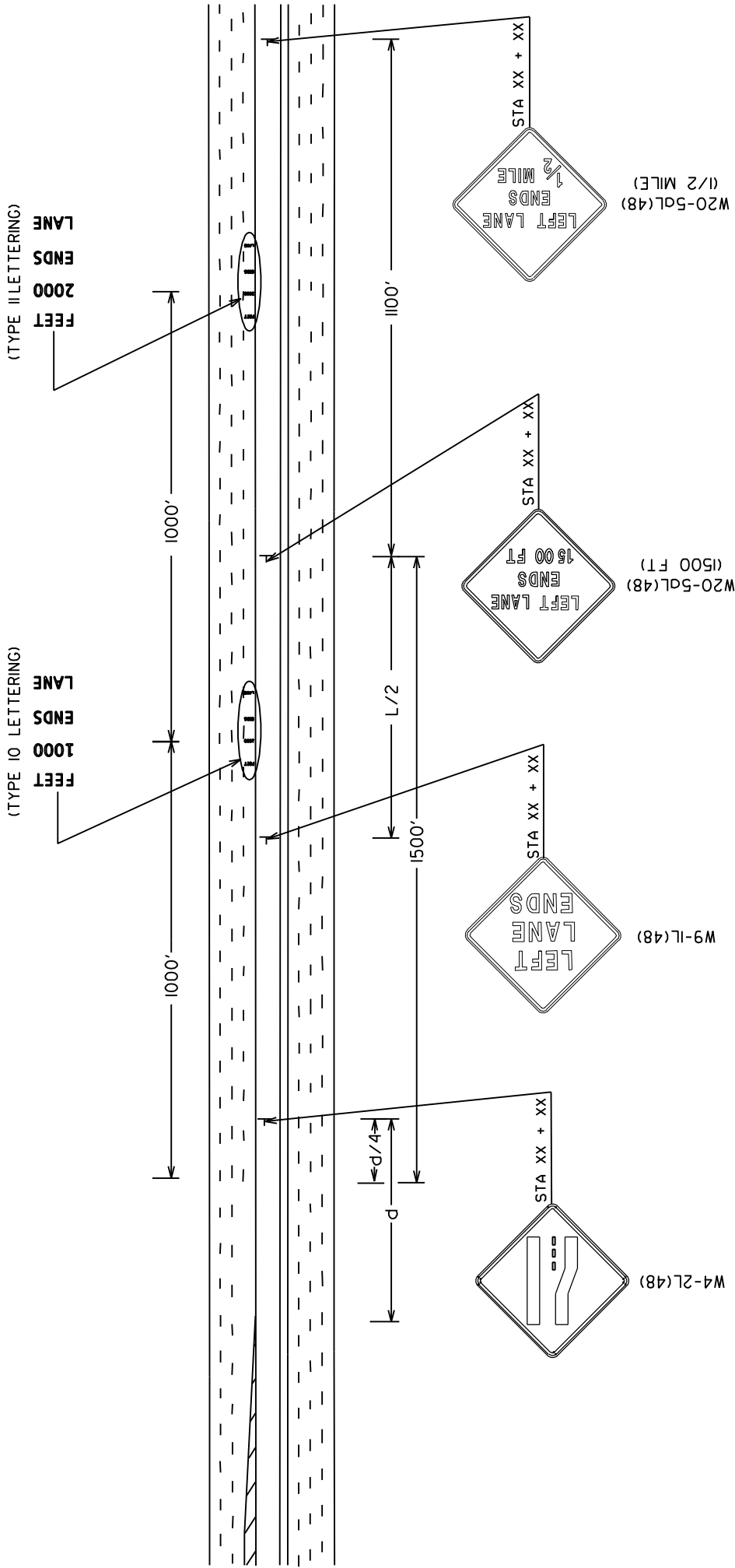

- NOTE:
1. d = ADVANCE WARNING DISTANCE
(SEE MUTCD FOR FURTHER GUIDANCE: TABLE 2C-4)
 2. L = 1500 - $d/4$

FIGURE 5-1L LANE REDUCTION SIGNING

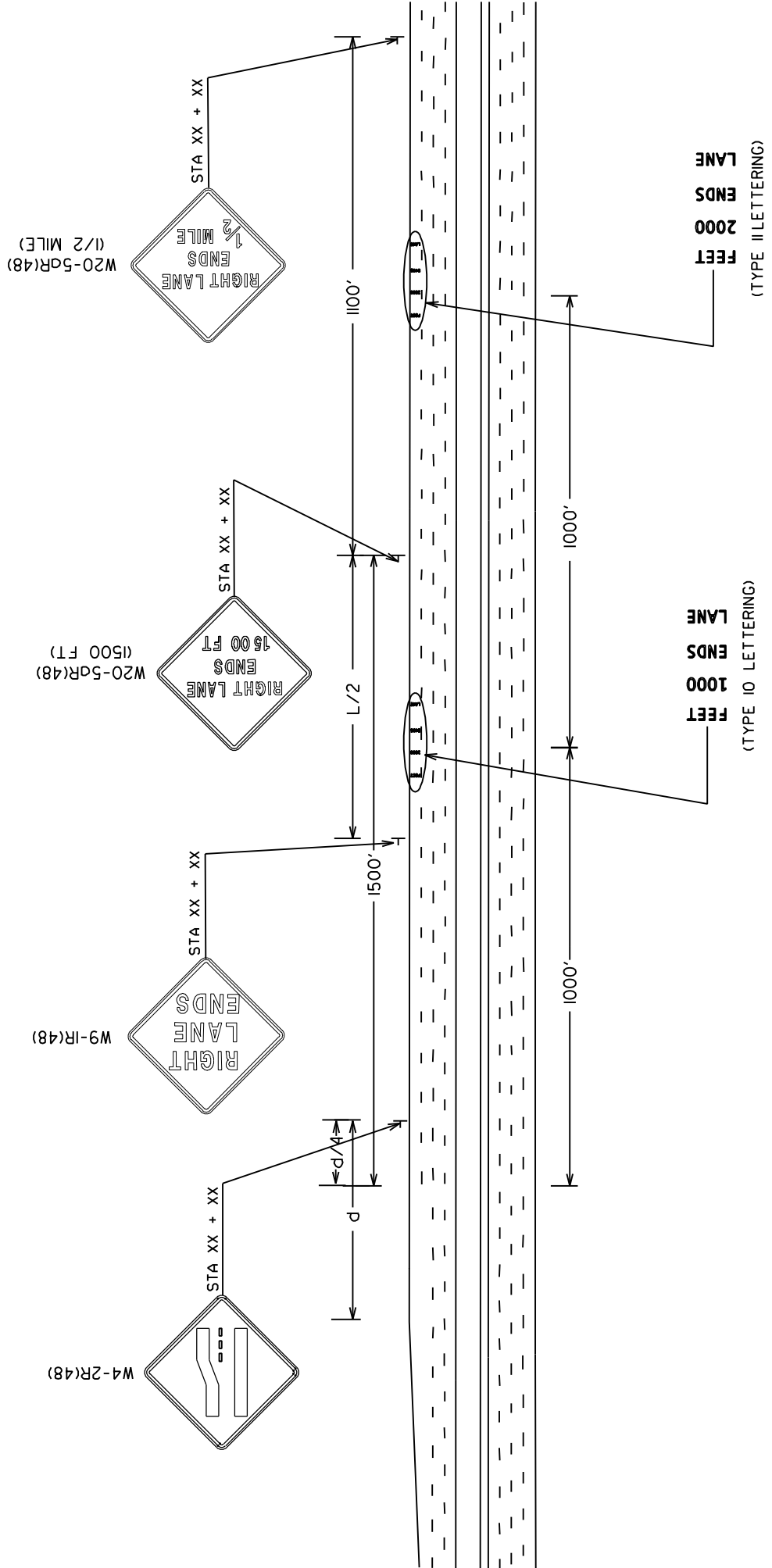

- NOTE:**
1. d = ADVANCE WARNING DISTANCE
(SEE MUTCD FOR FURTHER GUIDANCE: TABLE 2C-4)
 2. L = 1500 - $d/4$

FIGURE 5-1R LANE REDUCTION SIGNING

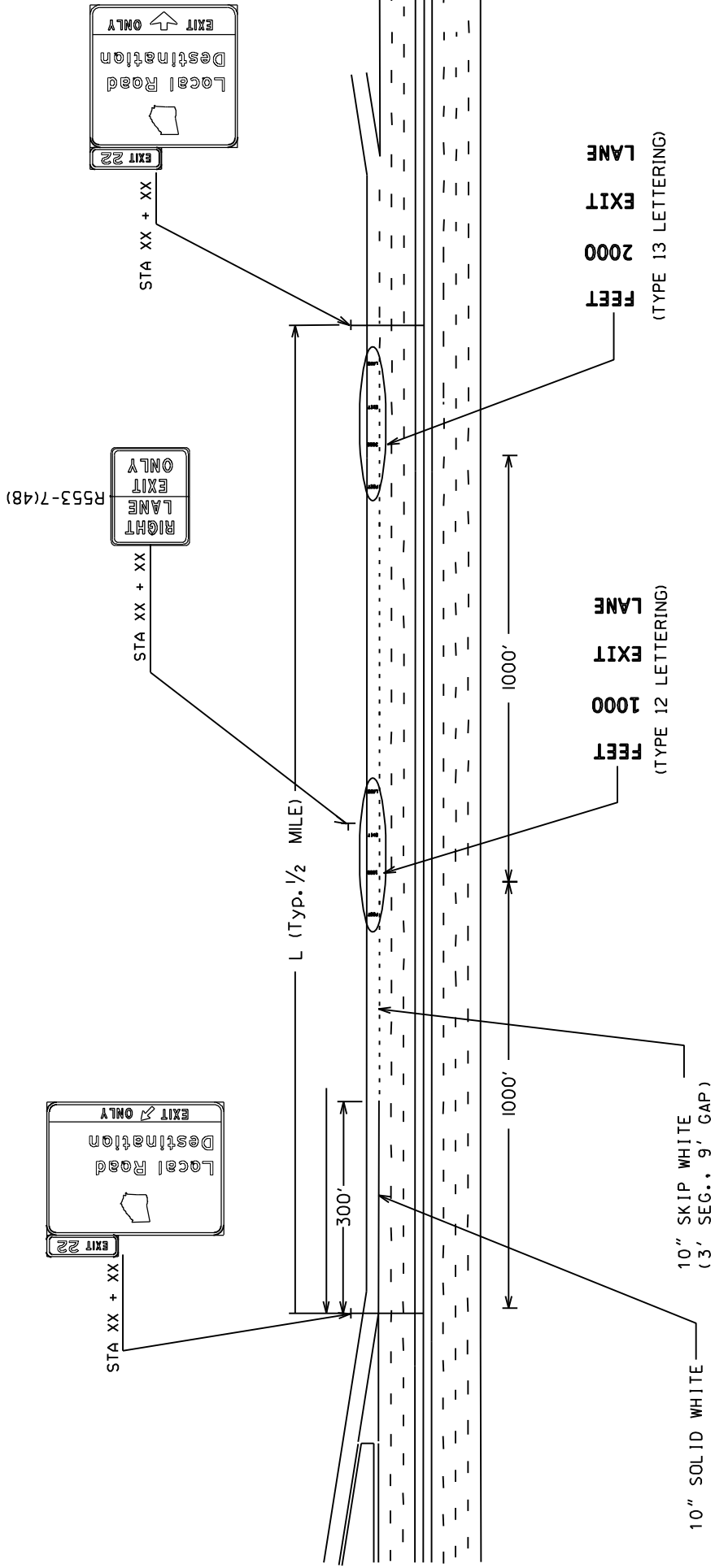

FIGURE 5-3 LANE DROP SIGNING (AUXILIARY LANE)

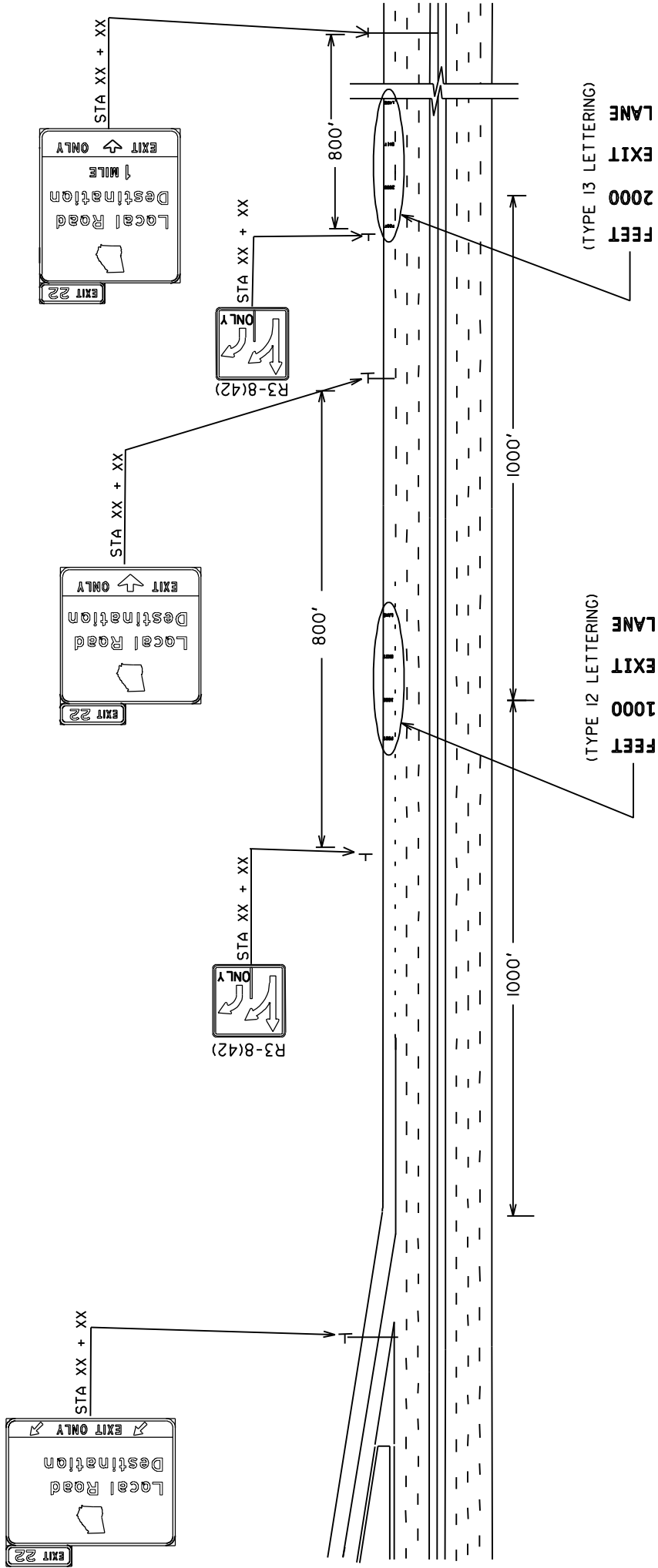

FIGURE 5-4 LANE DROP SIGNING (DROP OPTION)

SECTION 6 STANDARD SIGNS

6.1 General

Standard signs are mounted on square tube sign posts (Type 7, Type 8, or Type 9). [Figure 4-5](#), [Figure 4-6](#), and [Figure 6-1](#) show the details of Georgia-specific signs.

The area (square footage) of the sign determines the type of sign material that is used for each sign. If the area exceeds 9 square feet, Type 2 sign material is required. For any sign with an area less than or equal to 9 square feet, Type 1 sign material may be used.

Design plans must specify the number, type, length, and spacing of sign posts for standard signs. All standard signs greater than 48 inches in width require the use of at least two sign posts. [Figure 6-3](#) provides a chart for the selection of the number and type of sign posts. To use the chart, the width, height, area, and mounting height of the sign must be known. Details for mounting a single sign support are also shown on [Figure 6-2](#). [Figure 6-3](#) shows the details for mounting signs using a breakaway support. [Figure 6-4](#) shows the standard signs and the mounting holes in the sign blanks.

The design plans identify the locations of standard signs to be installed with the station number, sign code, and sign template with no dimensions. No two signs shall have the same station number. The locations of standard signs that shall be removed are indicated by the sign template with no dimensions, the station number, and the note “REMOVE HIGHWAY SIGN, STANDARD X EACH.” Existing standard signs that shall remain are shown with the sign template with no dimensions and the note “RETAIN IN PLACE.”

The removal of signs is normally paid for as part of clearing and grubbing. If a sign is to be retained, the “remove and reset sign” pay item should be used.

Examples of the summary of quantities sheets are provided in [Appendix D](#).

Examples of the general notes sheets are provided in [Appendix E](#).

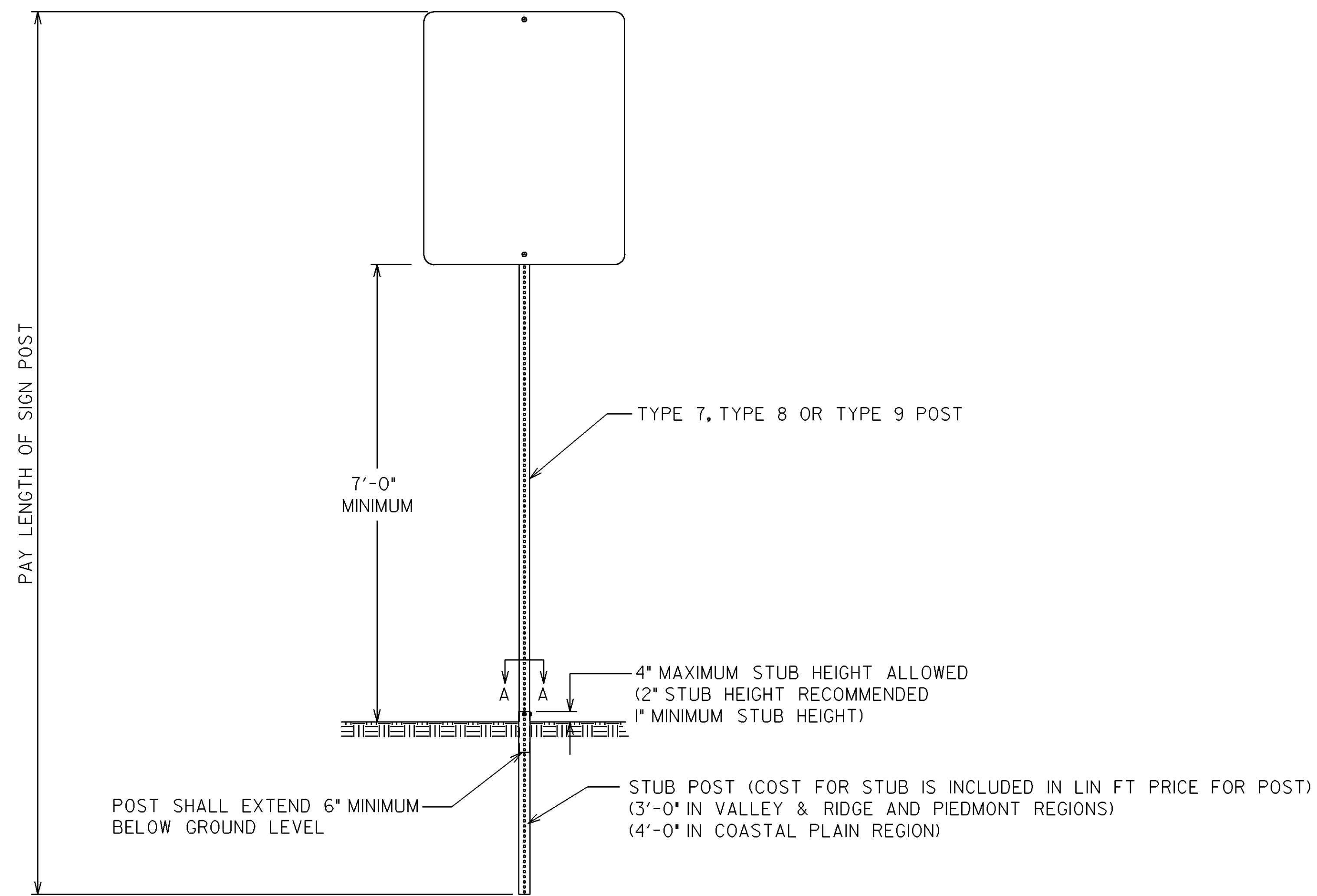

FRONT VIEW

POST	STUB SIZE
TYPE 7	2 1/4" x 2 1/4"
TYPE 8	2 3/4" x 2 3/4"
TYPE 9	2 1/2" x 2 1/2"

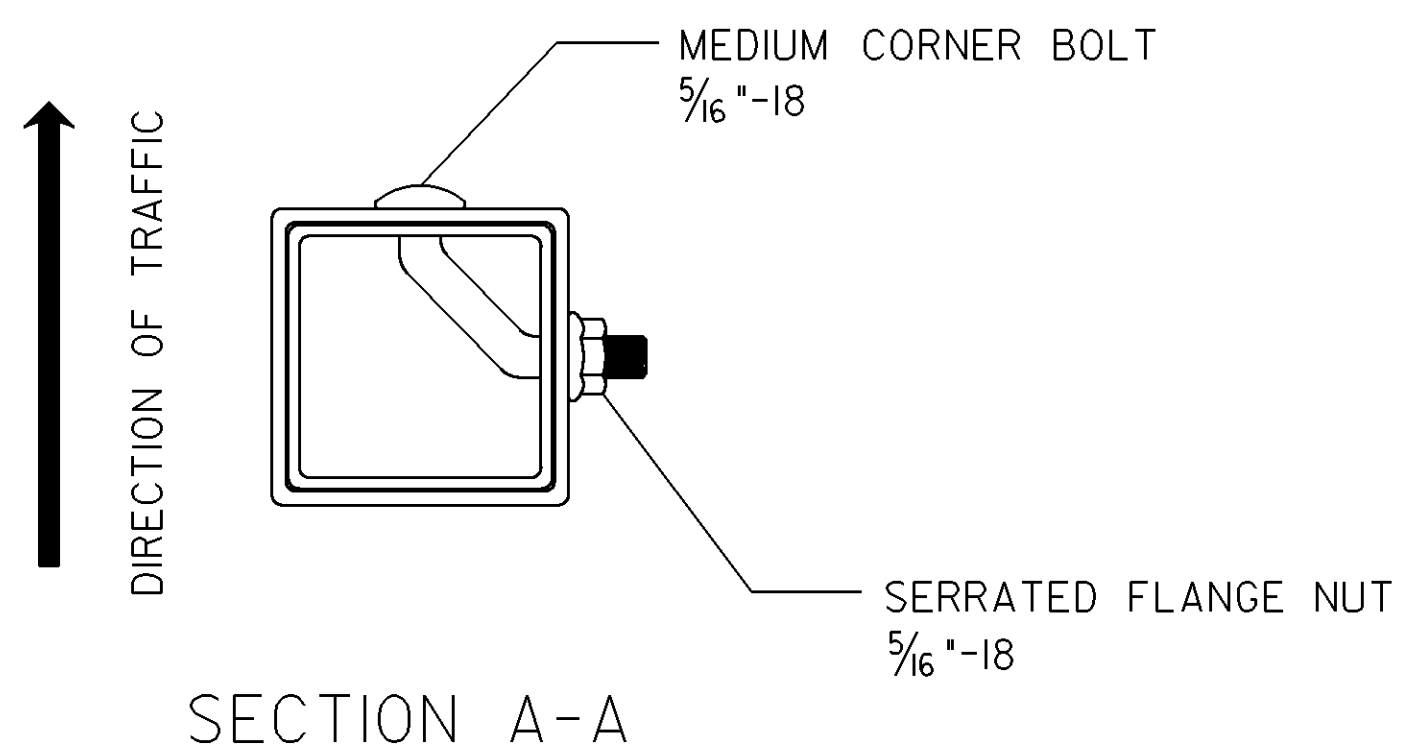

SECTION A-A

FIGURE 6-2

SIGN POST SELECTION CHART

70 MPH Wind Load Chart + 15% Gust Factor

Sign Centroid	SLIP BASE NOT REQUIRED				GROUND MOUNTED BREAKAWAY SIGN SUPPORT REQUIRED				
	TYPE 7 2" 14 ga.		TYPE 9 2 1/4" 14 ga.	TYPE 8 2 1/2" 12 ga.	TYPE 8 2 1/2" 12 ga.		TYPE 8 w / TYPE 9 Insert* 2 1/2" 12 ga. w / 2 1/4" 14 ga.		
	1 Post	2 Post	1 Post	1 Post	2 Post	3 Post	1 Post	2 Post	3 Post
	SQUARE FOOTAGE				SQUARE FOOTAGE				
8'	9.00	20.30	14.45	22.55	45.10	67.65	37.00	74.00	111.00
9'	9.00	18.00	12.85	20.00	40.00	60.00	32.85	65.70	98.55
10'	8.10	16.20	11.50	18.00	36.00	54.00	29.55	59.10	88.65
11'	7.40	14.80	10.50	16.40	32.80	49.20	26.90	53.80	80.70
12'	6.80	13.60	9.65	15.00	30.00	45.00	24.65	49.30	73.95
13'	6.25	12.50	8.90	13.85	27.70	41.55	22.75	45.50	68.25
14'	5.80	11.60	8.25	12.90	25.80	38.70	21.15	42.30	63.45
15'	5.00	10.00	6.45	10.10	20.20	30.30	16.55	33.10	49.65
16'	4.70	9.40	6.05	9.45	18.90	28.35	15.50	31.00	46.50
17'	4.40	8.80	5.70	8.90	17.80	26.70	14.60	29.20	43.80
18'	4.15	8.30	5.40	8.40	16.80	25.20	13.80	27.60	41.40
19'	3.95	7.90	5.10	7.95	15.90	23.85	13.05	26.10	39.15
20'	3.75	7.50	4.85	7.55	15.10	22.65	12.40	24.80	37.20

SIGN CENTROID IS DISTANCE FROM GROUND LEVEL TO BOTTOM OF SIGN PLUS HALF THE HEIGHT OF SIGN.
EXAMPLE: 24" X 48" SIGN THAT IS 7 FEET FROM GROUND TO BOTTOM OF SIGN. ADD HALF OF 48" (24" OR 2 FT) PLUS 7 FT. = 9' CENTROID.

SIGN PLATE SHALL NOT EXCEED 48" IN WIDTH ON A SINGLE POST.

TYPE 9 INSERT SHALL BE A CONTINUOUS POST INSERTED INTO THE TYPE 8 POST WHERE REQUIRED. THE INSERT POST SHALL EXTEND FROM THE BOTTOM OF THE SLIP BASE UPPER ASSEMBLY TO 4" BELOW THE BOTTOM OF THE SIGN. THE INSERT POST SHALL NOT EXTEND ABOVE THE BOTTOM OF THE SIGN. PAYMENT FOR THE INSERT POST SHALL BE PER LINEAR METER OF TYPE 9 POST.

GROUND MOUNTED BREAKAWAY SIGN SUPPORT, SHALL BE MEASURED PER EACH, COMPLETE IN PLACE, AND SHALL BE PAID FOR AT THE UNIT PRICE. MEASUREMENT FOR PAYMENT SHALL INCLUDE THE UPPER AND LOWER ASSEMBLY, STUB POST, CLASS "A" CONCRETE, AND ALL HARDWARE NECESSARY TO COMPLETE THE INSTALLATION.

DATE	REVISIONS	GEORGIA DEPARTMENT OF TRANSPORTATION OFFICE OF TRAFFIC SAFETY & DESIGN
		NO SCALE
		JUL 2002

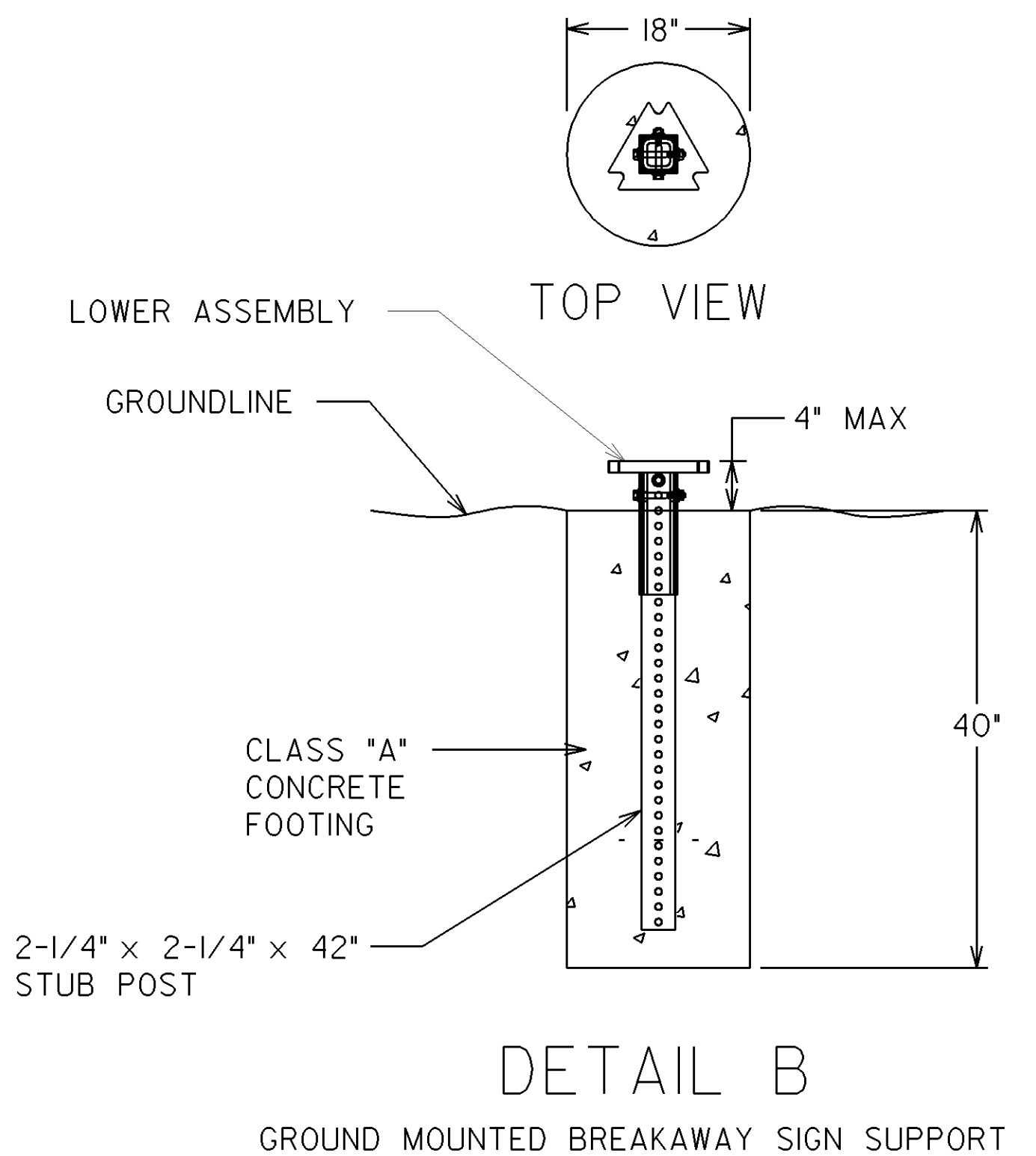
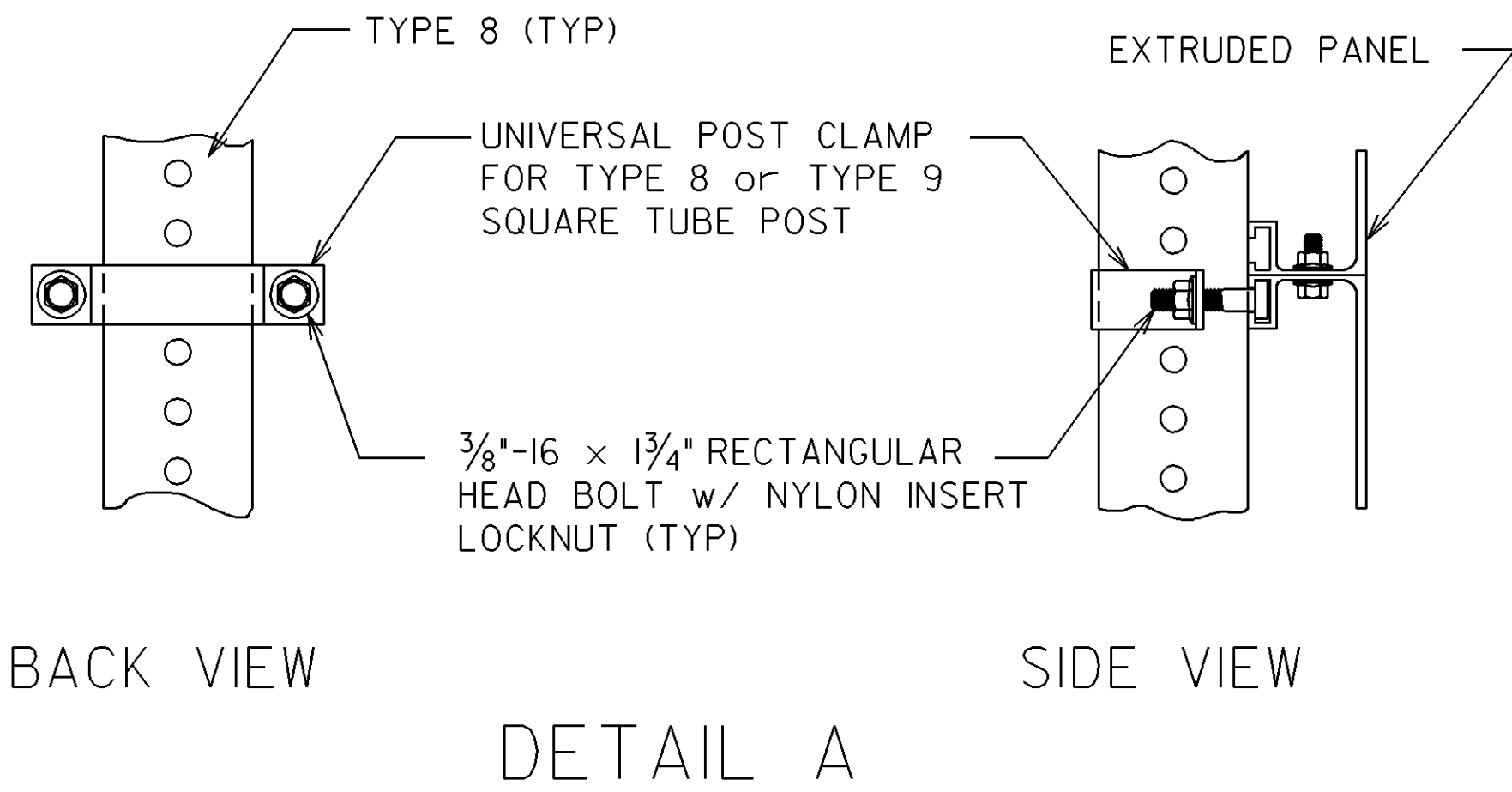
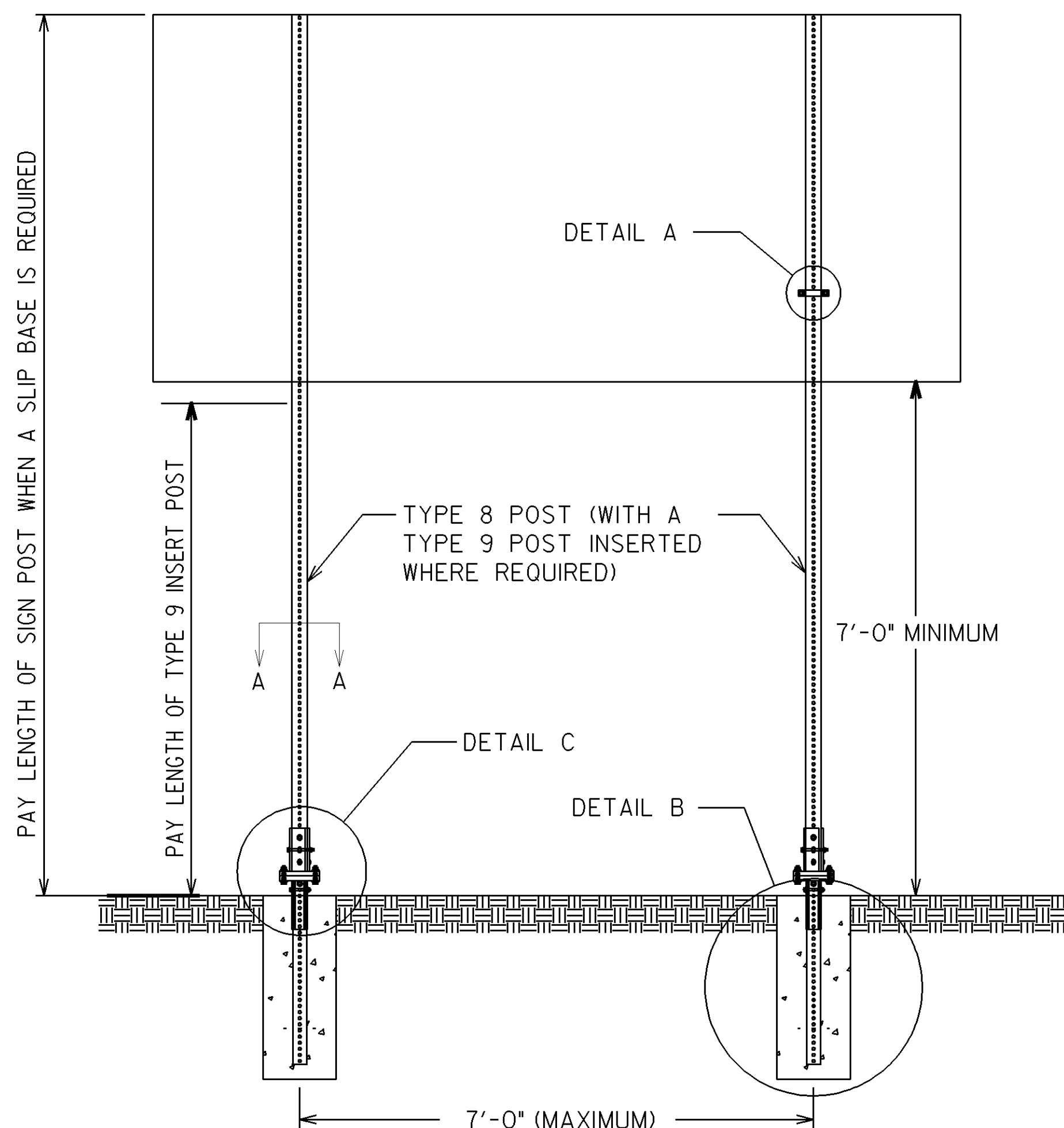

SIGN POST SELECTION CHART

70MPH W ind Load Chart + 15% Gust Factor

Sign Centroid	SLP BASE NOT REQUIRED				GROUND MOUNTED BREAKAWAY SIGN SUPPORT REQUIRED				
	TYPE 7 2\" 14 ga.		TYPE 9 2 1/4\" 14 ga.		TYPE 8 2 1/2\" 12 ga.		TYPE 8 w / TYPE 9 Insert 2 1/2\" 12 ga. w / 2 1/4\" 14 ga.		
	1 Post	2 Post	1 Post	1 Post	2 Post	3 Post	1 Post	2 Post	3 Post
	SQUARE FOOTAGE				SQUARE FOOTAGE				
6'	13.50	27.00	19.25	30.00	60.00	90.00	49.25	84.50	147.75
7'	11.60	23.20	16.50	25.75	51.50	77.25	42.25	74.00	126.75
8'	10.15	20.30	14.45	22.55	45.10	67.65	37.00	65.70	111.00
9'	9.00	18.00	12.85	20.00	40.00	60.00	32.85	59.10	98.55
10'	8.10	16.20	11.50	18.00	36.00	54.00	29.55	53.10	88.65
11'	7.40	14.80	10.50	16.40	32.00	49.20	26.90	49.30	80.70
12'	6.80	13.60	9.65	15.00	30.00	45.00	24.65	43.30	73.95
13'	6.25	12.50	8.90	13.85	27.70	41.55	22.75	40.50	68.25
14'	5.80	11.60	8.25	12.90	25.80	38.70	21.15	38.30	63.45
15'	5.00	10.00	7.45	10.10	20.20	30.30	16.55	31.10	49.65
16'	4.70	9.40	6.85	9.45	18.90	28.35	15.50	29.20	46.50
17'	4.40	8.80	6.30	8.90	17.80	26.70	14.60	27.20	43.80
18'	4.15	8.30	5.90	8.40	16.80	25.20	13.80	25.60	41.40
19'	3.95	7.90	5.10	7.95	15.90	23.85	13.05	24.10	39.15
20'	3.75	7.50	4.85	7.55	15.10	22.65	12.40	22.80	37.20

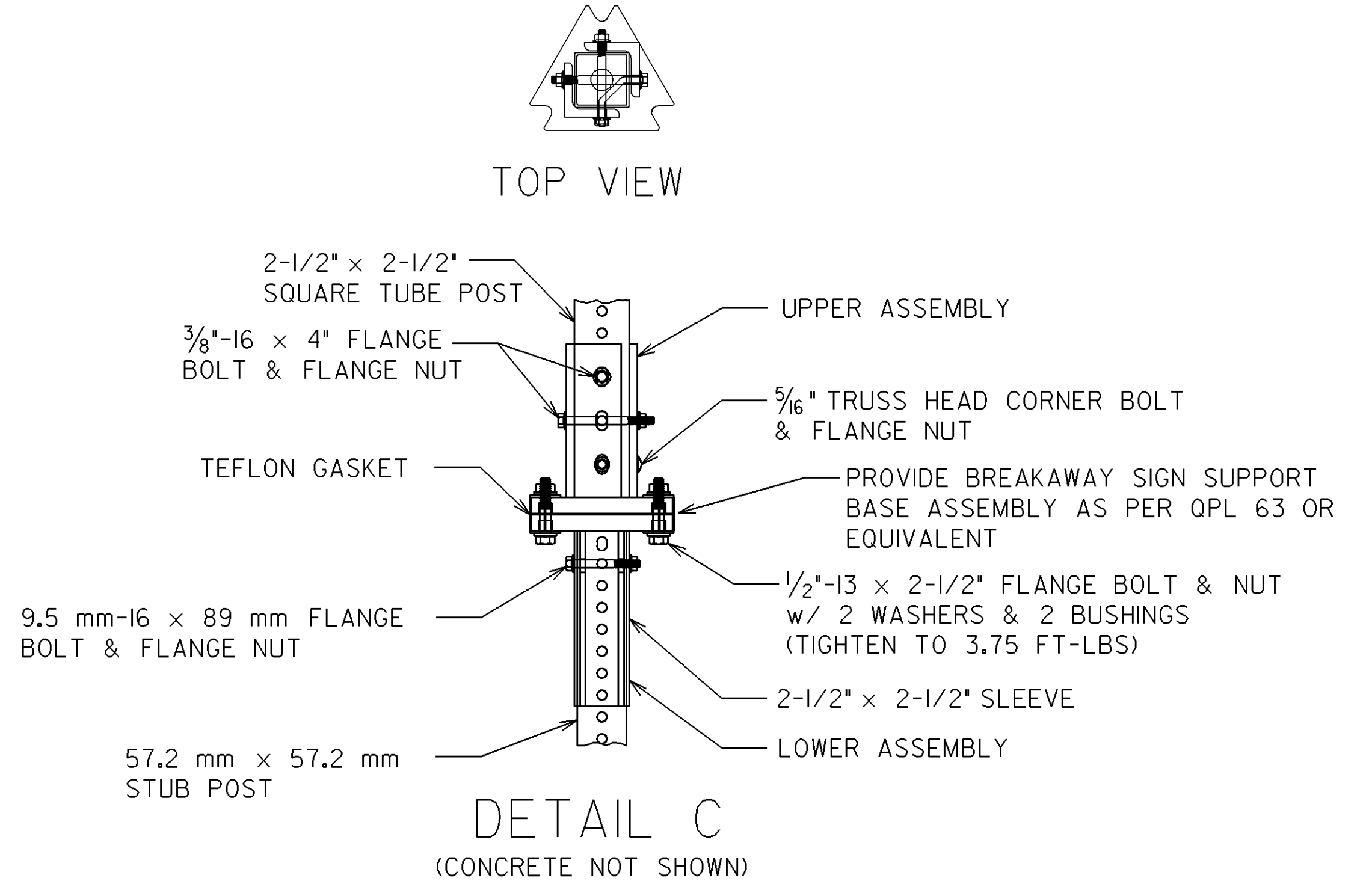
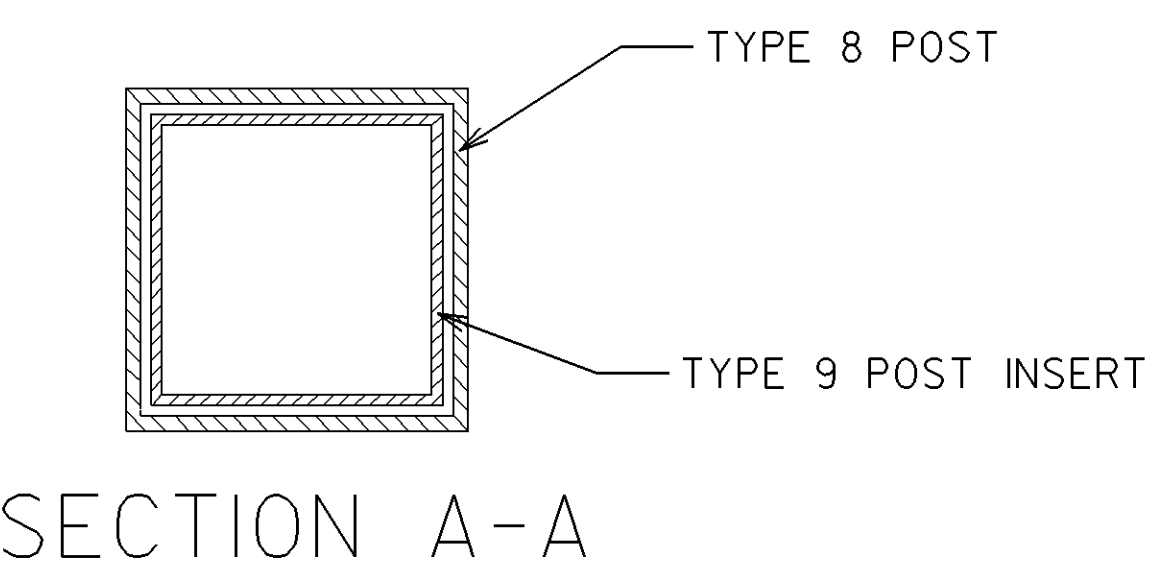

SIGN CENTROID IS DISTANCE FROM GROUND LEVEL TO BOTTOM OF SIGN PLUS HALF THE HEIGHT OF SIGN.
EXAMPLE: 24' X 48' SIGN THAT IS 7 FEET FROM GROUND TO BOTTOM OF SIGN. ADD HALF OF 48' (24' OR 2 FT) PLUS 7 FT. = 9' CENTROID.
 SIGN PLATE SHALL NOT EXCEED 48" IN WIDTH ON A SINGLE POST.

*TYPE 9 INSERT SHALL BE A CONTINUOUS POST INSERTED INTO THE TYPE 8 POST WHERE REQUIRED. THE INSERT POST SHALL EXTEND FROM THE BOTTOM OF THE SLP BASE UPPER ASSEMBLY TO 4' BELOW THE BOTTOM OF THE SIGN. THE INSERT POST SHALL NOT EXTEND ABOVE THE BOTTOM OF THE SIGN. PAYMENT FOR THE INSERT POST SHALL BE PER LINEAR FOOT OF TYPE 9 POST.

GROUND MOUNTED BREAKAWAY SIGN SUPPORT WILL BE MEASURED AND PAID FOR SEPARATELY. THE COST FOR THIS WORK SHALL INCLUDE THE UPPER AND LOWER ASSEMBLY, STUB POST, CLASS "A" CONCRETE, ALL HARDWARE NECESSARY TO COMPLETE THE INSTALLATION, AND BE INCLUDED IN THE BID PRICE SUBMITTED FOR ITEM 636-3010.

DATE	REVISIONS	GEORGIA DEPARTMENT OF TRANSPORTATION OFFICE OF TRAFFIC SAFETY & DESIGN DETAILS OF SQUARE TUBE POST (BREAKAWAY SIGN SUPPORT) NO SCALE	

FIGURE 6-3

STATE	PROJECT NUMBER	SHEET NO.	TOTAL SHEETS
GA.	1234567	12	21

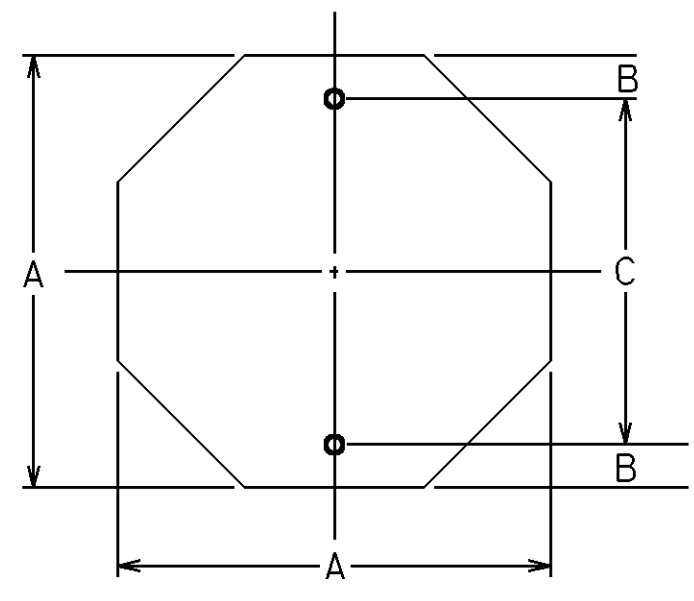

OCTAGON

A	B	C
24	3	18
30	3	24
36	3	30

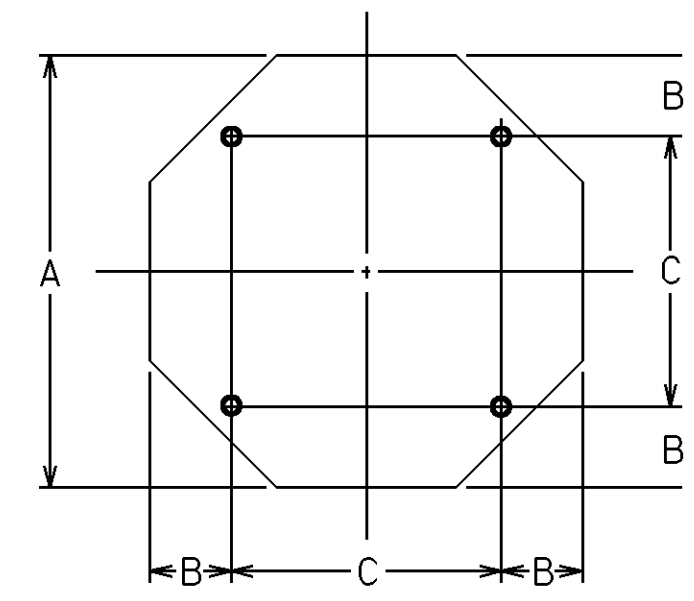

EQUILATERAL TRIANGLE

A	B	C	R
30	3	18	1/2
36	3	21	2
48	3	27	3

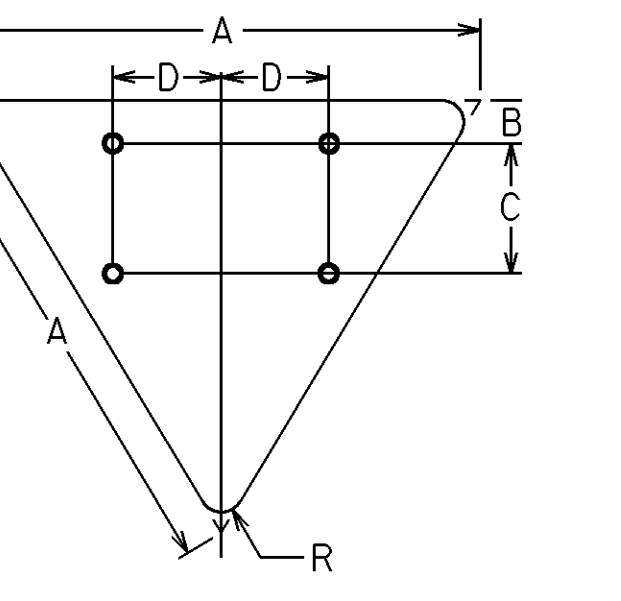

DIAMOND

A	B	R
24	12	1/2
30	15	1/8
36	18	2/4

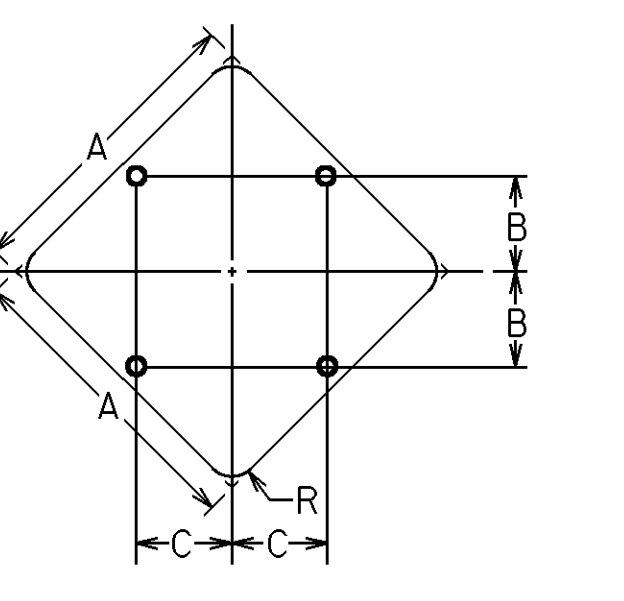

* FOR TWO POST ERECTION

A	B	C	R
36	10	10	2/4
48	15	15	3
60	18	18	3/4

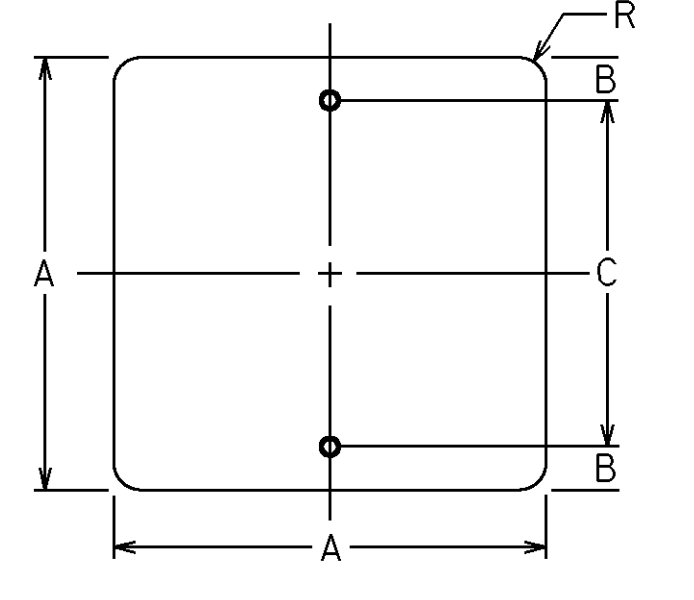

SQUARE

A	B	C	R
18	3	12	1/2
24	3	18	1/2
30	3	24	1/8

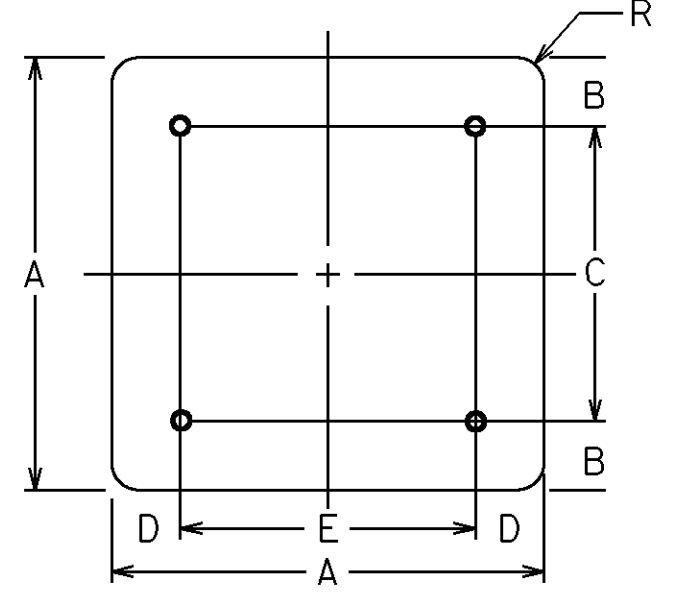

VERTICAL RECTANGLE

A	B	C	D	R
36	6	24	6	2/4
48	6	36	6	3

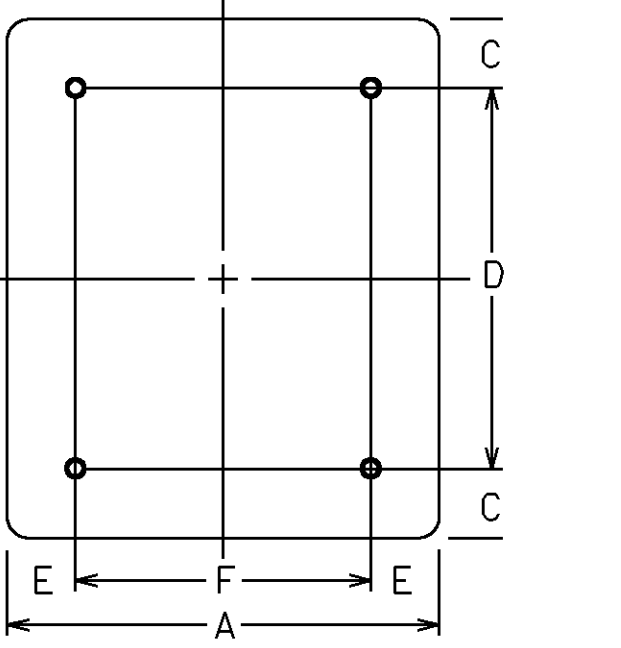

PENTAGON

A	B	C	R
30	21	3	1/8
36	24	3	2/4

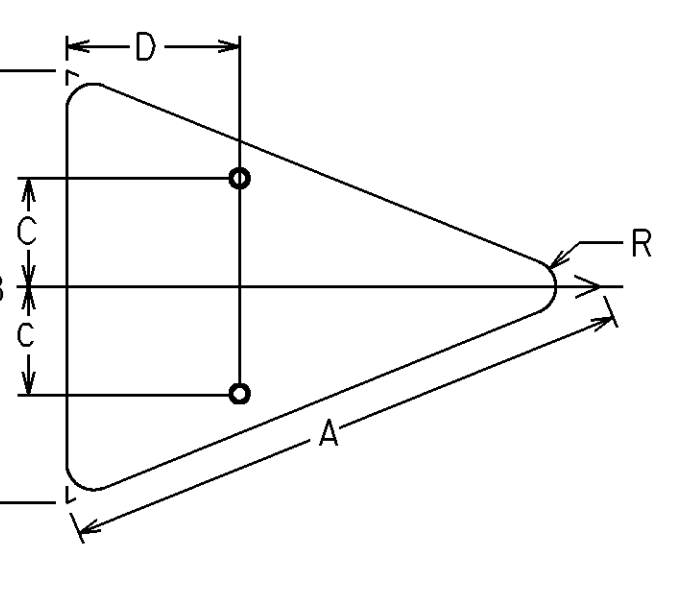

ISOSCELES TRIANGLE

A	B	C	D	R
40	30	7/2	12	1/8
48	36	9	15	2/4

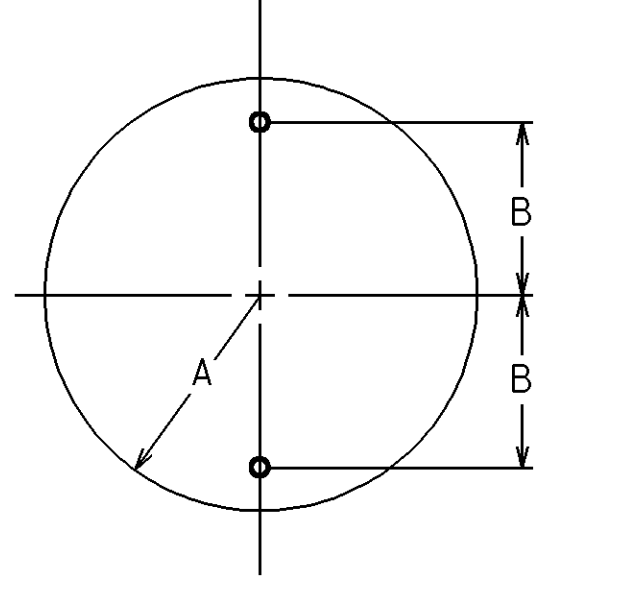

CIRCLE

A	B
15	12
18	15

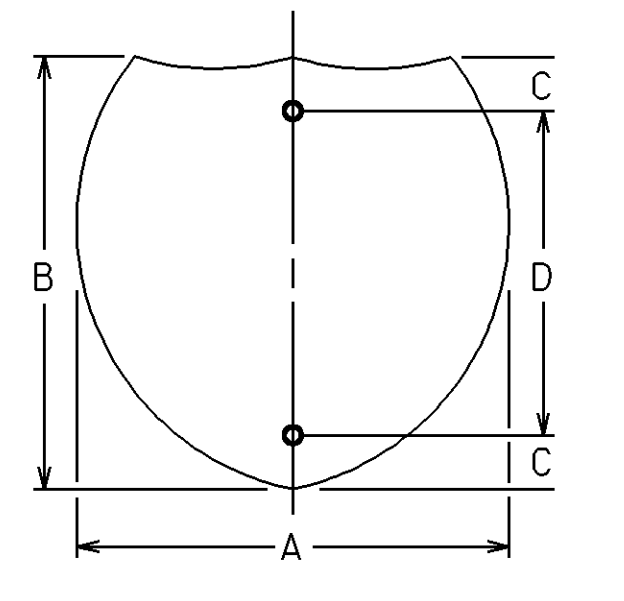

INTERSTATE SHIELD

A	B	C	D
24	24	3	18
30	24	3	18
36	36	6	24
45	36	6	24

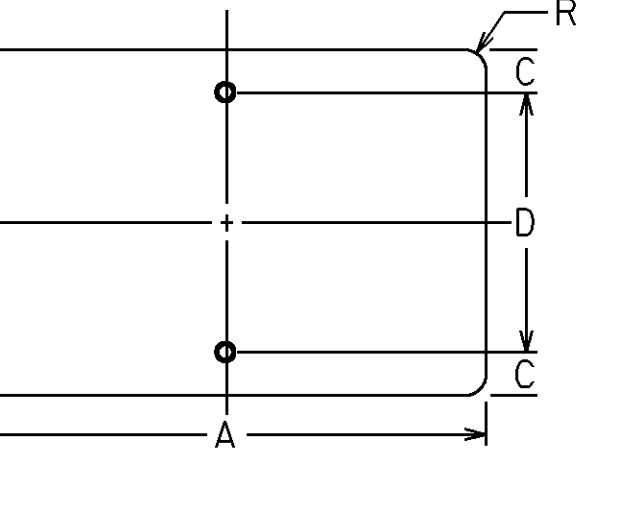

HORIZONTAL RECTANGLE

A	B	C	D	R
21	15	1/2	12	1/2
24	12	1/2	9	1/2
24	18	3	12	1/2
30	15	1/2	12	1/2
30	24	3	18	1/2
36	12	1/2	9	1/2
36	24	3	18	1/2
48	12	1/2	9	1/2
48	24	3	18	1/8

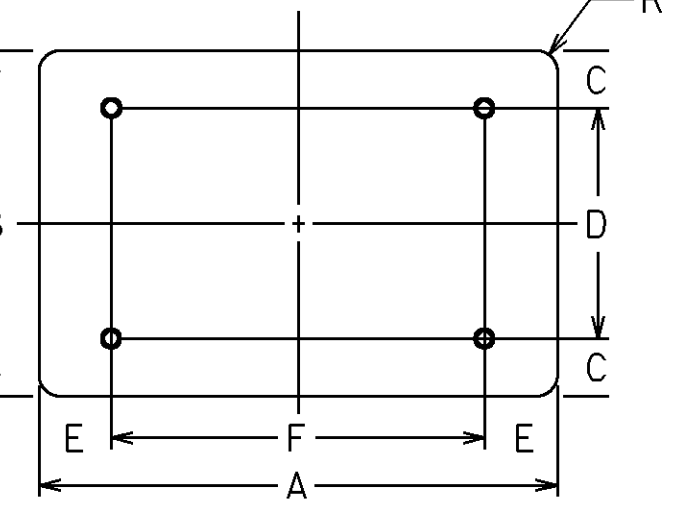

A	B	C	D	E	F	R
48	36	6	24	9	30	2/4
60	24	3	18	12	36	1/2
60	36	6	24	12	36	2/4

FIGURE 6-4

DATE	REVISIONS	GEORGIA DEPARTMENT OF TRANSPORTATION OFFICE OF TRAFFIC OPERATIONS
		DETAILS OF SIGN PLATES
		NO SCALE
		JANUARY 2000

SECTION 7 SIGN LAYOUTS

7.1 General

Sign detail layouts are provided for specific applications. The length of the legend can be calculated for each sign by using the most recent GDOT-approved software. Sign measurements must be in 6-inch increments.

Table 7-1 shows the border and radius requirements for all sign layouts.

Table 7-1: Border and Radius Requirements

Sign Height	Less than 3'-0"	3'-0" to 5'-0"	5'-6" to 7'-0"	7'-6" to 10'-0"	Greater than 10'-0"
Border	*1"	*1"	2"	2"	3"
Radius	3"	6"	9"	12"	12"

*Signs 5'-0" or less in height with 10" or 12" capital letters or 13.33" upper case/10" lower case and greater letters shall have 2" borders. Signs 5'-0" or less in height with 8" upper case/6" lower case or 6" capital letters shall have 1 1/8" borders. Exit panels shall have 1" border and 3" radius.

Sign layouts for specific signs are detailed in figures as shown below.

Code	Sign Legend	Figure
R554-5	NO TRUCKS OVER 6 WHEELS ALLOWED IN LEFT LANE	7-1
R554-11	ALL THRU TRUCKS OVER 6 WHEELS MUST USE I-285	4-4
	RIDESHARE	7-2
R554-X	NO TRUCKS OVER 6 WHEELS ALLOWED IN X LEFT LANES	7-1

Appendix A provides details and use of the layout. The signs are grouped by categories of advance exit signs, intermediate exit signs, exit signs, destination signs, and political boundary signs. This includes:

- Exit numbering – Numbered or unnumbered
- Mounting – Overhead or ground
- Sign sequence position – Advance, intermediate, or exit
- Exit lane arrangement – Normal, one lane continuous, one lane continuous with an optional lane, two or more lanes continuous
- Number of destination lines on the sign – One, two, or three
- Exit route shields and directions – Interstate shield, U.S. or Georgia route shield, cardinal directions

SECTION 8 SPECIAL ROADSIDE SIGNS

8.1 General

Special roadside signs are ground-mounted signs that require extruded aluminum panels. Typical special roadside signs include destination signs, political boundary signs, hospital signs, exit gore signs, and supplemental guide signs. Advanced exit signs and exit signs are also classified as special roadside signs if the facility is two lanes or less.

The height, width, and cross section of the sign are used to calculate the foundation and structural shape posts needed. The information can be calculated by using current GDOT standards referenced as:

[#9054A](#): Erection and Foundation Details for Special Roadside Signs, Breakaway Type Posts

[#9054B](#): Erection and Foundation Details for Special Roadside Signs, Breakaway Type Posts

[#9054C](#): Erection and Foundation Details for Special Roadside Signs, Breakaway Type Posts

Only structural steel shape or square tube posts shall be used. The post length is a function of the height of the sign and the cross-section slope. Standard 9054A indicates that the bottom of the sign should be at least 7 feet above the outside normal edge of pavement. In addition, no portion of the sign shall be less than 1 foot above the ground.

Special roadside signs with structural shape posts have a foundation that requires concrete. The amount of concrete is dependent on the foundation type, post size(s), and depth of the foundation. Table 8-1 provides calculations for the amount of concrete. D is the depth of the footing.

The locations of special roadside signs to be installed are identified on the plans with the station number, special sign number, and sign template with overall sign dimensions. The special sign number is a unique number assigned to all special roadside signs that are removed or installed. This number is in station order and requires that all signs with the same size and legend have the same number. The sign number is unique to each type of sign. Special roadside signs are defined with a two-digit number.

Table 8-1: Class A Concrete for Special Roadside Signs

TYPE 1 FOOTING

D (ft)	Concrete (ft³)	D (ft)	Concrete (ft³)	D (ft)	Concrete (ft³)
3'-0"	5.3013	8'-3"	14.5785	13'-3"	23.4140
3'-3"	5.7430	8'-6"	15.0203	13'-6"	23.8558
3'-6"	6.1848	8'-9"	15.4621	13'-9"	24.2976
3'-9"	6.6266	9'-0"	15.9039	14'-0"	24.7394
4'-0"	7.0684	9'-3"	16.3456	14'-3"	25.1811
4'-3"	7.5101	9'-6"	16.7874	14'-6"	25.6229
4'-6"	7.9519	9'-9"	17.2292	14'-9"	26.0647
4'-9"	8.3937	10'-0"	17.6710	15'-0"	26.5065
5'-0"	8.8355	10'-3"	18.1127	15'-3"	26.9482
5'-3"	9.2772	10'-6"	18.5545	15'-6"	27.3901
5'-6"	9.7190	10'-9"	18.9963	15'-9"	29.8318
5'-9"	10.1608	11'-0"	19.4381	16'-0"	28.2736
6'-0"	10.6026	11'-3"	19.8798	16'-3"	28.7153
6'-3"	11.0443	11'-6"	20.3216	16'-6"	29.1571
6'-6"	11.4861	11'-9"	20.7634	16'-9"	29.5989
6'-9"	11.9279	12'-0"	21.2052	17'-0"	30.0407
7'-0"	12.3697	12'-3"	21.6469	17'-3"	30.4824
7'-3"	12.8114	12'-6"	22.0887	17'-6"	30.9242
7'-6"	13.2532	12'-9"	22.5305	17'-9"	31.3660
7'-9"	13.6950	13'-0"	22.9723	18'-0"	31.8078
8'-0"	14.1368				

Deduct concrete for post sizes below from D values above for Type 1 footings.

Post Size	Concrete (ft³)	Post Size	Concrete (ft³)
S3x5.7	0.0138	W8x18	0.0780
S4x7.7	0.0185	W8x21	0.1139
W6x9	0.0304	W10x22	0.1200
W6x12	0.0428	W10x26	0.1424
W6x15	0.0721	W12x26	0.1545

TYPE 3 FOOTING

Post Size	Concrete (ft³)	Post Size	Concrete (ft³)
S3x5.7	20.7347	W8x18	28.0343
S4x7.7	20.7302	W8x21	31.8265
W6x9	24.5478	W10x22	31.8204
W6x12	24.5352	W10x26	31.7075
W6x15	28.0402	W12x26	31.7859

8.2 Placement

The locations of special roadside signs to be removed are shown on the plans with the station number, sign template with no dimensions, special sign number, and the following note: “REMOVE HIGHWAY SIGN SPECIAL ROADSIDE, X EACH,” where X is the number of signs to be removed. Special roadside signs that shall be left are noted with “RETAIN IN PLACE.”

The following are common pay items associated with special roadside signs:

Item No.	Description	Unit
500-3101	CLASS A CONCRETE	CY
610-6520	REM HIGHWAY SIGN, SPCL ROADSIDE	EA
633-3500	REMOUNT UNMODIFIED HIGHWAY SIGN, SPCL ROADSIDE	EA
636-1072	HIGHWAY SIGNS, ALUM EXTRUDED PANELS, REFL SHEETING, TP 3	SF
636-2080	GALV STEEL POSTS, TP 8	LF
636-2090	GALV STEEL POSTS, TP 9	LF
636-3000	GALV STEEL STR SHAPE POST	LB
636-9094	PILING IN PLACE, SIGNS, STEEL H, HP 12 X 53	LF

Each special roadside sign to be installed requires a layout showing the details of that sign with all of the dimensions. These are provided on Details of Special Roadside Signs sheets. The [Special Roadside Signs General Notes](#) are required on one of the Details of Special Roadside Signs sheets.

- An example of the [Summary of Quantities for Special Roadside Signs](#) to be installed sheet and [Summary of Quantities, Remove and Remount Special Roadside Signs](#) is provided in Appendix D.

SECTION 9 OVERHEAD HIGHWAY SIGNS

9.1 General

Overhead highway signs are signs that are mounted over the roadway on overhead highway sign structures. All advance exit signs and exit signs on facilities that have three lanes or more in one direction shall be installed overhead. In addition, the “no trucks over six wheels in left X lane(s)” sign (R554-X, [Figure 7-1](#)) is mounted on bridges or other structures as an overhead sign.

Georgia DOT approval is required before attaching signs to bridges.

9.2 Placement

Advance exit signs may be mounted on Type I, Type III, or Type VII sign structures. Type I or Type VII structures are required if the advance exit sign is for an exit-only lane. Type I structures are required for all signs that contain arrows. All structures require barrier or guardrail protection.

All interstates with three or more lanes in each direction require overhead guide signs. All interstates with four or more lanes in the direction of travel require guide signs to be placed over the travel lane.

Each overhead sign requires a clearance diagram that indicates the relative position of each sign and the position of the structure with relationship to the roadway cross section. The clearance diagram also indicates the layout of each overhead sign, including all dimensions. Type I structures require that the entire width of the roadway be shown with future signs. See [Section 10](#) for more information on clearance diagrams.

All overhead signs on a single structure should be the same height with the exception of general information or regulatory signs such as Rest Area or an R554-X. A minimum 1-foot horizontal spacing shall be maintained between each sign.

The locations of overhead signs to be installed are identified on the plans with the station number or mile post, special overhead sign number, sign template with overall sign dimensions, and a note indicating the structural support number and structure type. The special overhead sign number is a unique number assigned in station order to each special overhead sign that is removed or installed. If the sign is removed with the sign structure, then no special overhead sign number is assigned. The sequence of sign numbers for overhead signs should begin with a sequence that is not used by the special roadside signs. For example, if there are less than 100 numbered special roadside signs, the overhead sign numbers should begin with 101.

The structural support number combines an alphabetic code for the direction and facility with the milepost location in tenths of a mile. See [Figure 9-1](#) for Overhead Sign Structure Numbering. For example, I-95 southbound uses the alphabetic code of HH, so an overhead structure located at milepost 67.5 on I-95 southbound becomes structure number HH0675. The note for the location of new overhead signs and structure should be “STRUCTURAL SUPPORT #XYYY TYPE Z STRUCTURE REQUIRED,” where X = alphabetic code for facility and direction, YYY = milepost location in tenths of a mile, and Z = type of overhead sign structure.

The locations of overhead signs to be removed as part of a sign structure are shown on the plans with the station number, sign template with no dimensions, and the following note: “REMOVE STRUCTURAL SUPPORT #XYYYY, TYPE Z – LUMP.”

Removal shall include the following:

- Removing structure, complete, from STA. AAAA+AA, I-BB CBL (including removal of concrete footing to a depth of 1 foot below the existing ground line)
- Disposing of sign and structure by the contractor, unless specified otherwise in the plans.

Where:

X – Alphabetic code for the interstate facility and direction

Y – Milepost for the location in tenths of a mile

Z – Overhead sign structure type

A – Station number

B – Number of the interstate facility

C – Cardinal direction of the facility

The following are common pay items associated with overhead signs and structures.

Item No.	Description	Unit
610-6510	REM HWY SIGN, OVHD	EA
610-9401	REM STR SUPPORT, TYPE 1, , STA - AAAA + BB	LUMP
610-9402	REM STR SUPPORT, TYPE 2, , STA - AAAA + BB	LUMP
610-9403	REM STR SUPPORT, TYPE 3, , STA - AAAA + BB	LUMP
610-9407	REM STR SUPPORT, TYPE 7, , STA - AAAA + BB	LUMP
633-3000	REMOUNT UNMODIFIED HIGHWAY SIGN, OVERHEAD	EA
636-1072	HIGHWAY SIGNS, ALUM EXTRUDED PANELS, REFL SHEETING, TP 3	SF
636-1072	HIGHWAY SIGNS, ALUM EXTRUDED PANELS, REFL SHEETING, TP 3 INCLUDING BRACKETS	SF
638-1001	STR SUPPORT FOR OVERHEAD SIGN, TP I, STA - AAAA + BB	LUMP
638-1003	STR SUPPORT FOR OVERHEAD SIGN, TP III, STA - AAAA + BB	LUMP
638-1007	STR SUPPORT FOR OVERHEAD SIGN, TP VII, STA - AAAA + BB	LUMP
641-1200	GUARDRAIL, TP W	LF
641-5001	GUARDRAIL ANCHORAGE, TP 1	EA
641-5012	GUARDRAIL ANCHORAGE, TP 12	EA

An example of the [Summary of Quantities for Overhead Highway Signs](#) is provided in Appendix D.

OVERHEAD SIGN STRUCTURES WILL BE NUMBERED WITH A LETTER (FROM THE LIST BELOW) AND 3 OR 4 DIGITS. THE DIGITS WILL BE DETERMINED BY THE MAINLINE MILE POST TO THE NEAREST TENTH OF A MILE. STRUCTURES ON RAMPS WILL INCLUDE AN "R" BETWEEN THE APPROPRIATE ROUTE LETTER AND MAINLINE MILE POST TO THE NEAREST TENTH OF A MILE.

A - I-20	EAST	AA - I-185	NORTH
B - I-20	WEST	BB - I-185	SOUTH
C - I-75	NORTH	CC - I-675	NORTH
D - I-75	SOUTH	DD - I-675	SOUTH
E - I-85	NORTH	EE - S.R. 985	NORTH
F - I-85	SOUTH	FF - S.R. 985	SOUTH
G - I-285	CLOCKWISE	GG - I-95	NORTH
H - I-285	COUNTERCLOCKWISE	HH - I-95	SOUTH
I - NOT USED		JJ - I-16	EAST
J - S.R. 400	NORTH	KK - I-16	WEST
K - S.R. 400	SOUTH	LL - I-516	EAST
L - S.R. 166	EAST	MM - I-516	WEST
M - S.R. 166	WEST	NN - I-520	SOUTH/EAST
N - S.R. 410	EAST	PP - I-520	NORTH/WEST
O - NOT USED		SS - S.R. 10	CLOCKWISE
P - S.R. 410	WEST	TT - S.R. 10	COUNTERCLOCKWISE
Q - NOT USED		XX - I-24	EAST
R - RAMP	RAMP	YY - I-24	WEST
S - I-575	NORTH	ZZ - I-59	NORTH
T - I-575	SOUTH		
U - S.R. 5 CONN.	NORTH		
V - S.R. 5 CONN.	SOUTH		
W - S.R. 13	NORTH		
X - S.R. 13	SOUTH		
Y - AIRPORT			
Z - AIRPORT			

FIGURE 9-1 OVERHEAD SIGN STRUCTURE NUMBERING

SECTION 10 CLEARANCE DIAGRAMS

10.1 General

Clearance diagrams are required for all overhead signs. The length of the legend should be calculated for each sign using the current GDOT-approved software. Sign measurements shall be in 6-inch increments.

10.2 Design Elements

Critical elements on the clearance diagrams are:

- Project Number
- The location of existing guardrail or barrier wall
- The cross section of the roadway and shoulders, including the widths of paved surfaces
- The location of any proposed guardrail or median barrier to protect sign structures within the clear area that are not of breakaway construction
- The horizontal and vertical location of the signs in relation to the cross section of the roadway and lanes
- The structural support number and station number
- The sign design layout
- The design sign area (sq. ft.) for the structure
- The location of any footings for the sign structure
- Structure Type
- Bridge Name and Number for Type VII Bridge Attachments

The location of existing guardrail is indicated on the clearance diagram by the note “EXISTING GUARDRAIL.” The location of existing guardrail or barrier should be shown for all roadways within the clear zone of the proposed structure, including frontage roads and in medians. Existing guardrail should be verified to meet current standards. An example of a clearance diagram for a Type I structure is shown on [Figure 10-1](#). New Type I structures should be designed to accommodate maximum loading. The maximum loading (sq. ft.) can be calculated by multiplying the width of the roadway plus half of each shoulder by maximum height of 22 feet. [Figure 10-2](#) shows an example of a clearance diagram for a Type III structure. [Figure 10-3](#) is an example of a clearance diagram for a Type I structure with a concrete median barrier. [Figure 10-4](#) is an example of a clearance diagram for a Type VII structure.

The placement of guardrail and barrier wall must also be shown on the plan view of the plans. The placement must be in accordance with GDOT standards.

The GDOT standard for a median barrier is Standard 4940, CONCRETE BARRIER.

Construction details of Type 26 and 26S median barriers with sign supports are shown on [Figures 10-5](#) and [Figure 10-6](#), respectively.

The Overhead Highway Signs General Notes shall be included with the first clearance diagram.

DETAILS & CLEARANCE DIAGRAM FOR OVERHEAD SIGNS

STRUCTURAL SUPPORT #A0208

STA XXXX+XX, I-20 EBL

- NO SCALE -

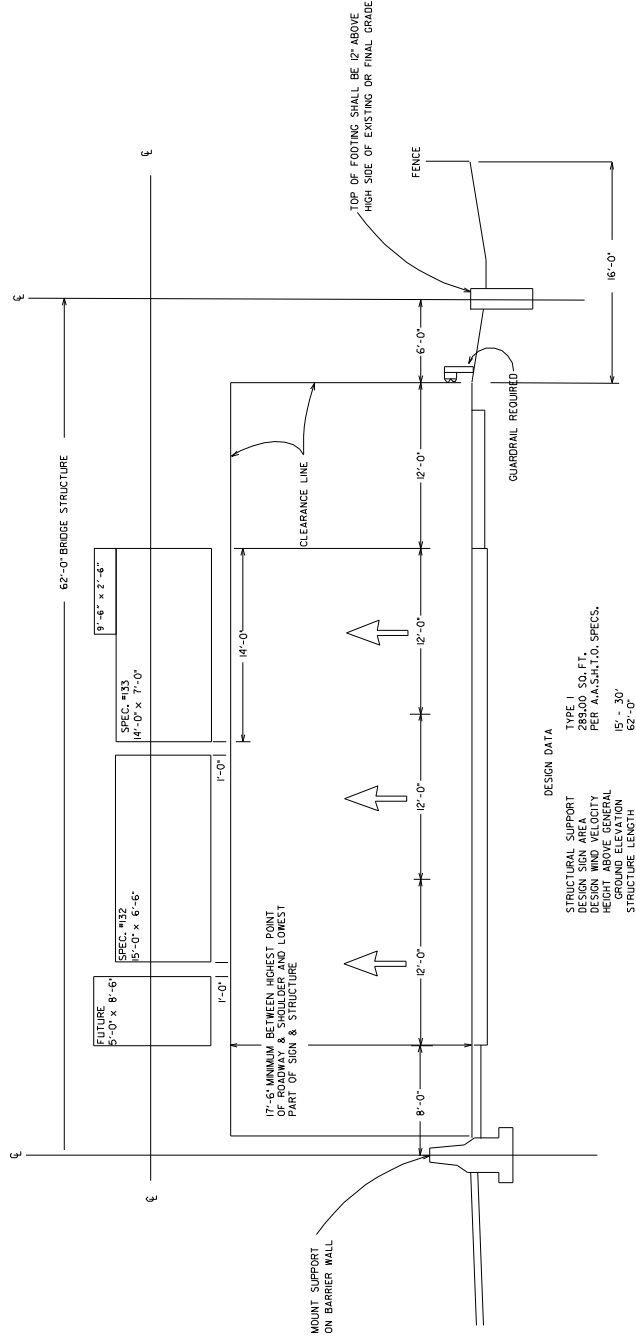
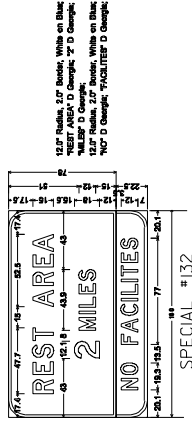
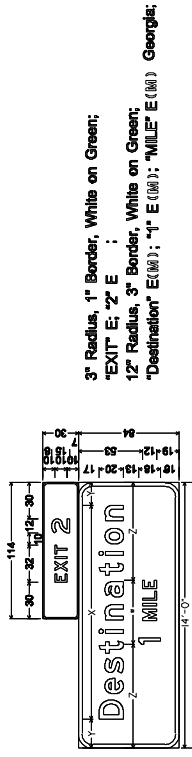
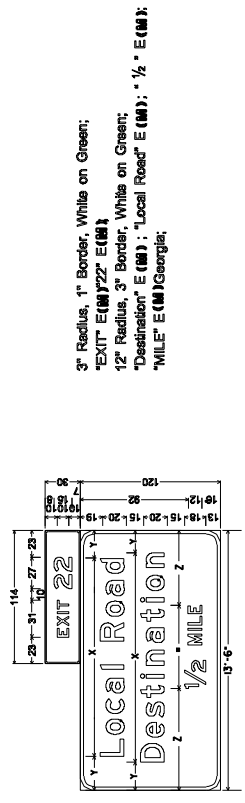

FIGURE 10-3

STATE	PROJECT NUMBER	SHEET NUMBER	TOTAL SHEETS
GA.	123-4567	51	99

DETAILS & CLEARANCE DIAGRAM FOR OVERHEAD SIGNS

STRUCTURAL SUPPORT # B0228
 STA XXXX+XX, I-20 WBL
 - NO SCALE -



- 3" Radius, 1" Border, White on Green;
- "EXIT" E(M) 22" E(M)
- 12" Radius, 3" Border, White on Green;
- "Destination" E (M) ; "Local Road" E (M) ; "1/2" * E (M) ;
- "MILE" E (M) Georgia;

NOTE:
 1- BOTTOM OF SIGN STRUCTURE SHALL BE A MINIMUM OF 0'-9" ABOVE
 BOTTOM OF BRIDGE BEAM.

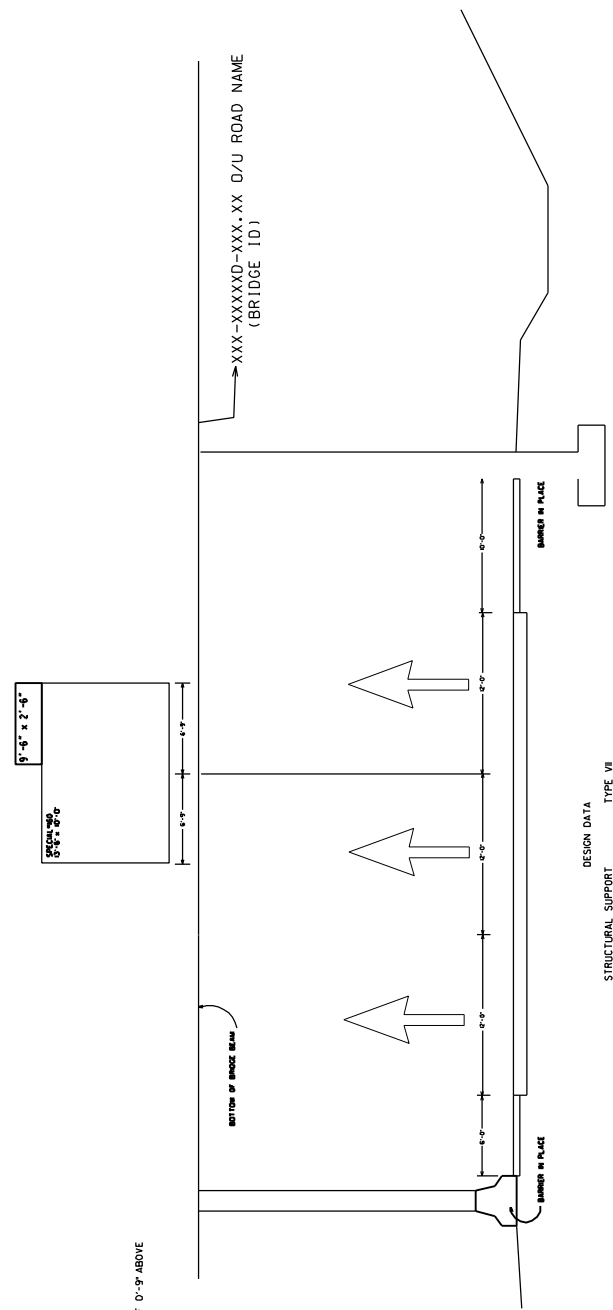

DESIGN DATA
 STRUCTURAL SUPPORT TYPE VI

FIGURE 10-4

GEORGIA DEPARTMENT OF TRANSPORTATION CLEARANCE DIAGRAM PROJECT NO. \$PROJECT\$ COUNTY \$COUNTY\$ DATE \$\$-\$\$-\$\$ DWG NO. 26-51		REVISIONS DATE REVISIONS DATE
REVISIONS DATE REVISIONS DATE	REVISIONS DATE REVISIONS DATE	REVISIONS DATE REVISIONS DATE

STATE	PROJECT NUMBER	SHEET TOTAL
GA.		NO. SHEETS

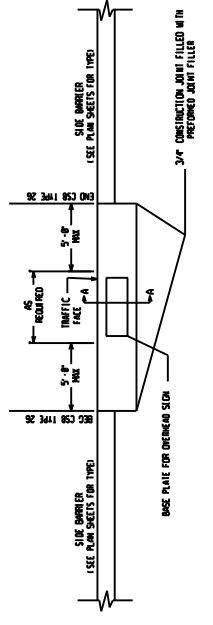

ALTERNATE DETAIL - APPLICABLE WHERE SHOWN ON PLANS

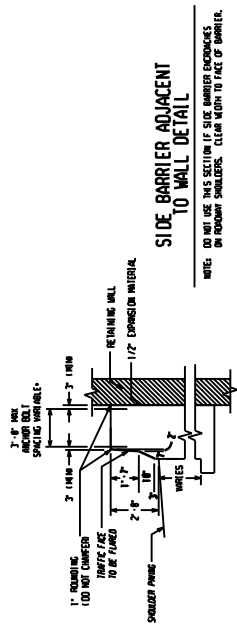

SECTION B-B

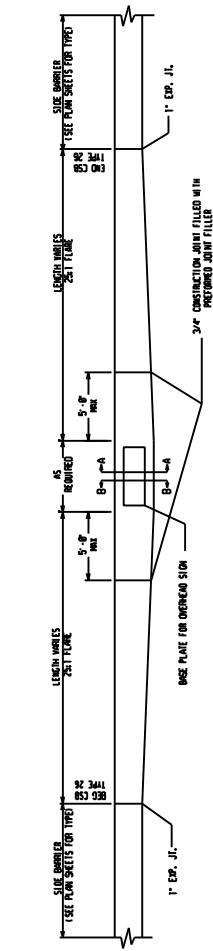

SIDE BARRIER DETAIL

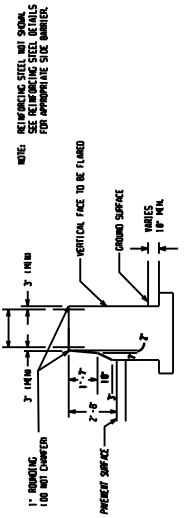

SECTION A-A

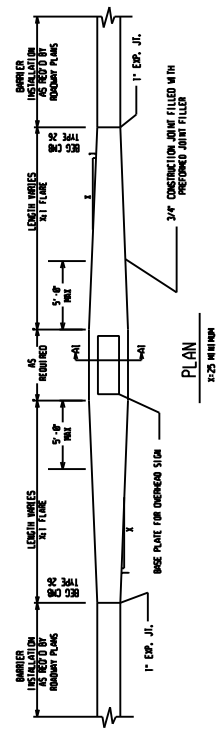

PLAN

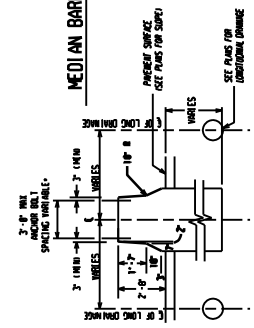

SECTION A1-A1

NOTES:

1. THE DESIGN OF SIGN SUPPORT AND FOOTING SHALL BE DESIGNED BY THE CONTRACTOR RESPONSIBLE FOR CONSTRUCTING THE TYPE 26 BARRIER, AND APPROVED BY THE GA. DEPT. OF TRANSPORTATION PRIOR TO START OF CONSTRUCTION.
2. ANCHOR BOLT SPACING AND BARRIER WIDTH WILL DEPEND ON THE DESIGN OF THE SUPPORT BASE AND WILL BE DETERMINED BY THE CONTRACTOR AND APPROVED BY THE ENGINEER.
3. DEPTH AND SHAPE OF FOOTING SHALL BE DETERMINED BY THE CONTRACTOR.
4. THE PRICE BID FOR CONCRETE BARRIER, TP 26, SHALL INCLUDE THE ANCHOR BOLTS, BARRIER, FOOTING, AND MATERIAL NECESSARY TO BUILD THE FOOTING UP TO THE TOP OF THE BARRIER.
5. SEE PLANS FOR LOCATIONS.
6. BASIS OF PAYMENT: CONC. MED. BARRIER, TP. 26, PER LIN FT OR CONC. SIDE BARRIER, TP. 26, PER LIN FT
7. PAYMENT FOR TYPE 26 BARRIER SHALL INCLUDE THE 1" EXPANSION JOINTS AT EACH END AND NEAR VERTICAL SAVED JOINTS AT ANY REMOVAL LINES.
8. PAYMENT FOR TYPE 26 BARRIER SHALL INCLUDE RESTORING DISTURBED SHOULDER TO EXISTING ELEVATION WITH A MINIMUM 1/2" DEPTH CLASS "B" CONCRETE PLUS SURFACE COURSE TO MATCH THE EXISTING SHOULDER OR REPLACING THE DISTURBED SHOULDER IN KIND.

- IN LIEU OF AN APPROVED SIGN FOOTING DESIGN THE CONTRACTOR SHALL USE THE ALTERNATE SIGN FOOTING DESIGN FOR TYPE 26 CONCRETE BARRIER, AS SHOWN ON SHEET
- THE CONTRACTOR RESPONSIBLE FOR CONSTRUCTING THE TYPE 26S CONCRETE BARRIER SHALL BE RESPONSIBLE FOR OBTAINING APPROVED ANCHOR BOLT SIZES AND SPACINGS FROM THE SIGN CONTRACTOR.

NOTE: WHERE BARRIER HEIGHTS ON OPPOSITE SIDES VARY, PAYMENT FOR TP 26 BARRIER SHALL INCLUDE ALL EXTENDED FOOTINGS AND ADDITIONAL HEIGHTS WITH THE REQUIRED RETROFITTING AS SHOWN ON SEPARATE DETAILS AND/OR STANDARDS FOR TPs 21, 22-A, 22-B, OR OTHER SPECIFIED DESIGNS FOR THE REQUIRED ELEVATION DIFFERENCES.

DEPARTMENT OF TRANSPORTATION		STATE OF GEORGIA	OFFICE OF ROAD DESIGN
DESIGNED BY	DRAWN BY	CHECKED BY	NO. SCALE
CONCRETE MEDIAN BARRIER			
DETAILS OF TYPE 26			
(FOR SIGN SUPPORTS)			
NO. 16, 1999			

FIGURE 10-5

STATE	PROJECT NUMBER	SHEET TOTAL
GA.		NO. SHEETS

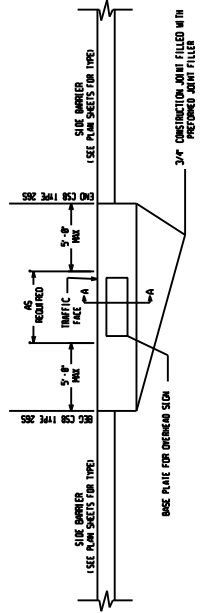

ALTERNATE DETAIL - APPLICABLE WHERE SHOWN ON PLANS

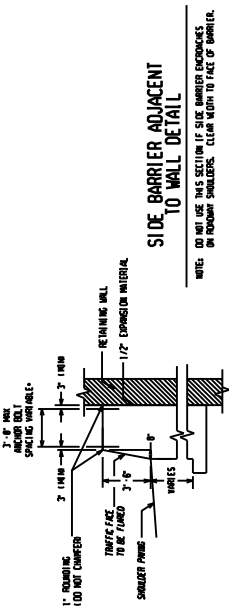

SIDE BARRIER ADJACENT TO WALL DETAIL

NOTE: DO NOT USE THIS SECTION IF SIDE BARRIER ENCLOSED IN RIGID SHOULDER. CLEAR WIDTH TO FACE OF BARRIER.

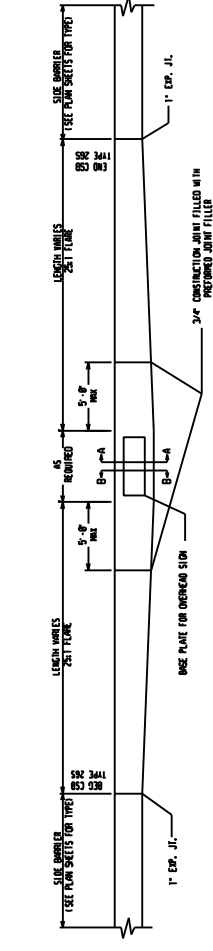

SIDE BARRIER DETAIL

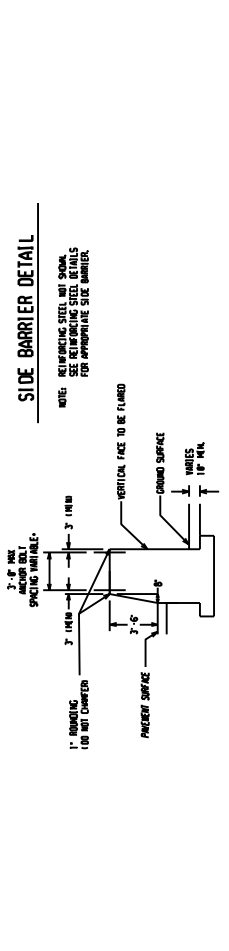

SECTION A-A

NOTE: REINFORCING STEEL NOT SHOWN. SEE REINFORCING STEEL DETAILS FOR APPROPRIATE SIDE BARRIER.

NOTE: IN LIEU OF AN APPROVED SIGN FOOTING DESIGN THE CONTRACTOR SHALL USE THE ALTERNATE SIGN FOOTING DESIGN FOR TYPE 265 CONCRETE BARRIER.

- NOTES:
1. THE DESIGN OF SIGN SUPPORT AND FOOTING SHALL BE DESIGNED BY THE CONTRACTOR RESPONSIBLE FOR CONSTRUCTING THE TYPE 265 BARRIER, AND APPROVED BY THE GA. DEPT. OF TRANSPORTATION PRIOR TO START OF CONSTRUCTION.
 2. ANCHOR BOLT SPACING AND BARRIER WIDTH WILL DEPEND ON THE DESIGN OF THE SUPPORT BASE AND WILL BE DETERMINED BY THE CONTRACTOR AND APPROVED BY THE ENGINEER.
 3. DEPTH AND SHAPE OF FOOTING SHALL BE DETERMINED BY THE CONTRACTOR.
 4. THE PRICE BID FOR CONCRETE BARRIER, TP 265, SHALL INCLUDE THE ANCHOR BOLTS, BARRIER, FOOTING, AND MATERIAL NECESSARY TO BUILD THE FOOTING UP TO THE TOP OF THE BARRIER.
 5. SEE PLANS FOR LOCATIONS.
 6. BASIS OF PAYMENT: TP. 265.....PER LIN FT OR CONC. MED. BARRIER, TP. 265.....PER LIN FT
 7. CONCRETE BARRIER, TP. 265.....PER LIN FT
 8. PAYMENT FOR TYPE 265 BARRIER SHALL INCLUDE THE 1" EXPANSION JOINTS AT EACH END AND NEAR VERTICAL SAVED JOINTS AT ANY REMOVAL LINES.
 9. PAYMENT FOR TYPE 265 BARRIER SHALL INCLUDE RESTORING DISTURBED SHOULDER TO EXISTING ELEVATION WITH A MINIMUM 12" DEPTH CLASS "B" CONCRETE PLUS SURFACE COURSE TO MATCH THE EXISTING SHOULDER OR REPLACING THE DISTURBED SHOULDER IN KIND.

- IN LIEU OF AN APPROVED SIGN FOOTING DESIGN THE CONTRACTOR SHALL USE THE ALTERNATE SIGN FOOTING DESIGN FOR TYPE 265 CONCRETE BARRIER.
- THE CONTRACTOR RESPONSIBLE FOR CONSTRUCTING THE TYPE 265 CONCRETE BARRIER SHALL BE RESPONSIBLE FOR OBTAINING APPROVED ANCHOR BOLT SIZES AND SPACINGS FROM THE SIGN CONTRACTOR.

WHERE BARRIER HEIGHTS ON OPPOSITE SIDES VARY, PAYMENT FOR TP 265 BARRIER SHALL INCLUDE ALL EXTENDED FOOTINGS AND ADDITIONAL HEIGHTS WITH THE REQUIRED REINFORCING AS SHOWN ON SEPARATE DETAILS AND/OR STANDARDS FOR TYP. 21, 22-A, 22-B, OR OTHER SPECIFIED DESIGNS FOR THE REQUIRED ELEVATION DIFFERENCES.

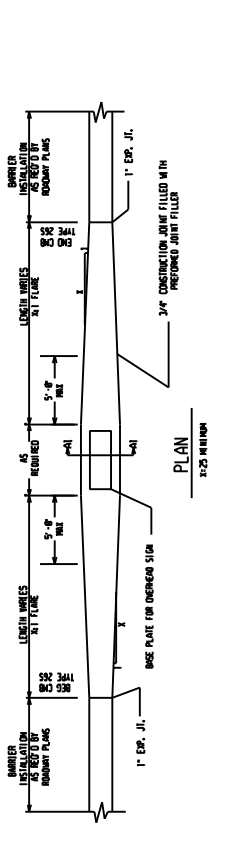

MEDIAN BARRIER DETAIL

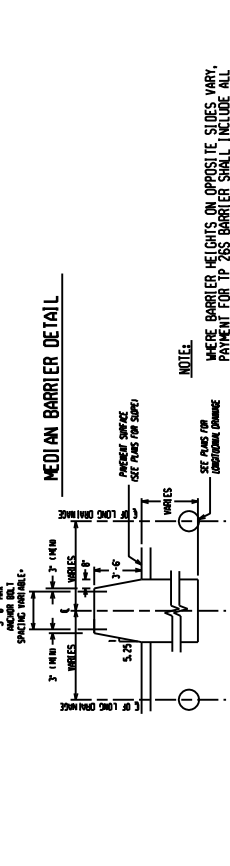

SECTION A1-A1

NOTE: WHERE BARRIER HEIGHTS ON OPPOSITE SIDES VARY, PAYMENT FOR TP 265 BARRIER SHALL INCLUDE ALL EXTENDED FOOTINGS AND ADDITIONAL HEIGHTS WITH THE REQUIRED REINFORCING AS SHOWN ON SEPARATE DETAILS AND/OR STANDARDS FOR TYP. 21, 22-A, 22-B, OR OTHER SPECIFIED DESIGNS FOR THE REQUIRED ELEVATION DIFFERENCES.

DEPARTMENT OF TRANSPORTATION		STATE OF GEORGIA	OFFICE OF ROAD DESIGN
CONCRETE MEDIAN BARRIER		DETAILS OF TYPE 265	
(FOR SIGN SUPPORTS)		NO SCALE	NO. 16, 1999
DESIGNED	DRAWN	CHECKED	

FIGURE 10-6

SECTION 11 LOGO SIGNS

11.1 General

The design and location of logo signs are not normal parts of an interstate signing project. The design and installation of logo signs are a function of Georgia LOGO Signing, which designs, installs, and maintains these signs on the right-of-way. However, in the design of an interstate signing project, there may be conflicts with existing logo signs. As part of the interstate signing project, it is required that any logo signs that conflict with locations where a new sign is to be installed be moved and remounted. Relocation should be considered if a special roadside or overhead sign structure needs to be installed within 800 feet of the logo sign.

The GDOT TOPPS Document [6775-10](#), Guidelines for Specific Service Signing – LOGO Business Signs, details the specific information on design and placement of logo signs. The relocation of any logo signing should be in accordance with this document. Relocation of one logo sign for an interchange may require moving other logo signs to provide for the sequence of 24-hour pharmacies, attractions, camping, lodging, food, and gas in the direction of travel.

An example of the [Summary of Quantities for Removing and Resetting Logo Signs](#) sheet is provided in Appendix D.

The following are common pay items associated with relocating logo signs.

Item No.	Description	Unit
610-0019	REMOVE AND RESET LOGO SIGN	EA
610-9000	REMOVE LOGO SIGN	EA
611-5550	RESET LOGO SIGN	EA

SECTION 12 PAVEMENT MARKING DESIGN STANDARDS

12.1 Materials

Pavement marking material is typically thermoplastic or paint; however, preformed material with contrast should be used on bridges and all other concrete surfaces. Widths for longitudinal lines, hatching, and stop bars are defined in the [GDOT Signing and Marking Details](#).

Pavement marking material should conform to [Policies and Procedures \(P&P\) 6146-2](#) for maintenance activities.

12.2 Pavement Markings

12.2.1 Edge lines shall be placed on all paved roadways, including curb and gutter sections. When the width of a roadway with curb and gutter exceeds the normal distance from face of gutter to face of gutter for the number of travel lanes, the edge line shall be placed the appropriate distance from the centerline markings based on a lane width of 12 feet. Edge lines shall not be placed on roadways with curb and gutter if parallel or angle parking is permitted.

12.2.2 All pavement markings for bicycle lanes, including the edge line separating vehicular and bicycle traffic, shall be paint. [Appendix C](#) contains examples of pavement markings for bicycle lanes.

12.2.3 The design of crosswalks shall be in accordance with the [GDOT Signing and Marking Details](#). The installation of crosswalks shall conform to the attached [Draft Crosswalk Guidance](#) and shall be provided across paved public side roads where sidewalk exists.

12.2.4 Borders around detail yellow striping and borders around detail white striping are included in the square yard pay item as indicated in the [Construction Detail](#).

12.2.5 Pavement marking “ONLY” should be where a thru lane becomes a turn lane and where multiple adjacent left turn lanes exist as indicated in the [Construction Detail](#).

12.2.6 Pavement marking arrows should be spaced every 100 feet (150 feet if “ONLY” words are used) as indicated in the [Construction Detail](#).

12.3 Raised Pavement Markers

Raised pavement markers shall be provided in the design for all new roadways and on reconstruction where new pavement marking will be provided. The [GDOT Signing and Marking Details](#) referenced above describe each type of marker and provide guidelines for the location and spacing of raised pavement markers.

Georgia Department of Transportation Guidance on Marking Crosswalks

This guidance is intended to address the need to provide safer pedestrian crossings on Georgia’s roads. The guidance promotes engineering strategies to decrease pedestrian injuries and fatalities. Research indicates that simply marking a crosswalk does not necessarily improve pedestrian safety, and in some situations may decrease pedestrian safety. This guidance establishes the recommended pedestrian crossing treatment for various types of roadways.

Guidance: The following provisions for pedestrian facilities at intersections are recommended for Georgia DOT preconstruction and maintenance projects, commercial driveway and access permits:

1) Controlled Intersections:

a. At signalized intersections, marked crosswalks should be placed across all approaches that have adequate ADA and pedestrian accommodations/displays. Limited right-of-way and other limiting factors may not allow adequate pedestrian access.

b. At all-way stops, marked crosswalks should be placed across all roads where there is sidewalk, or any evidence of pedestrian movement (such as worn paths on the roadside, transit stops, adjacent land uses that generate pedestrian trips – schools, parks, retail, dense residential development, etc).

2) Uncontrolled Intersections:

a. At uncontrolled intersections *, where only the side road is required to stop or yield, marked crosswalks should be placed across all side roads where there is sidewalk, or any evidence of pedestrian movement (such as worn paths on the roadside, transit stops, adjacent land uses that generate pedestrian trips – schools, parks, retail, dense residential development, etc).

b. At uncontrolled locations*, marked crosswalks and/or additional crossing enhancements should be placed across the state route or main route in accordance with Table 1.

c. Marked crosswalks may be used at non-signalized street crossing locations in designated school zones to delineate preferred pedestrian paths across roadways. Use of adult crossing guards, school signs and markings, and/or traffic signals with pedestrian signals (when warranted) should be considered in conjunction with the marked crosswalk, as needed.

d. Crosswalks and pedestrian crossing improvements at uncontrolled mid-block locations should be considered on a case-by-case basis based on sound engineering judgment or an engineering study.

Exceptions:

1. Crosswalks should not be installed at locations with poor sight distance, complex or confusing designs, or substantial heavy truck volume without first providing adequate design features and/or traffic control devices.

TABLE 1

Roadway Type (number of Travel Lanes and Median Type)	Vehicle ADT < 9,000			Vehicle ADT > 9,000 to 12,000			Vehicle ADT >12,000 to 15,000			Vehicle ADT >15,000		
	Speed Limit**											
	<30 mph	35 mph	40 mph	<30 mph	35 mph	40 mph	<30 mph	35 mph	40 mph	<30 mph	35 mph	40 mph
Two Lanes	C	C	P	C	C	P	C	C	N	C	P	N
Three Lanes	C	C	P	C	P	P	P	P	N	P	N	N
Multilane (four or more lanes) with raised median***	C	C	P	C	P	N	P	P	N	N	N	N
Multilane (four or more lanes) without raised median	C	P	N	P	P	N	N	N	N	N	N	N

* These guidelines include intersection and midblock locations with no traffic signals or stop signs on the approach to the crossing. They do not apply to school crossings. Crosswalks should not be installed at locations that could present an increased safety risk to pedestrians, such as where there is poor sight distance, complex or confusing designs, a substantial volume of heavy trucks, or other dangers, without first providing adequate design features and/or traffic control devices. Adding crosswalks alone will not make crossings safer, nor will they necessarily result in more vehicles stopping for pedestrians. Whether or not marked crosswalks are installed, it is important to consider other pedestrian facility enhancements (e.g., raised median, roadway narrowing, enhanced overhead lighting, curb extensions), as needed, to improve the safety of the crossing. These are general recommendations; good engineering judgment should be used in individual cases for deciding where to install crosswalks.

** Where the speed limit exceeds 64.4 km/h (40 mi/h), marked crosswalks alone should not be used at unsignalized locations.

*** The raised median or crossing island must be at least 1.2 m (4 ft) wide and 1.8 m (6 ft) long to serve adequately as a refuge area for pedestrians, in accordance with MUTCD and American Association of State Highway and Transportation Officials (AASHTO) guidelines.

C = Candidate sites for marked crosswalks. Marked crosswalks must be installed carefully and selectively. Before installing new marked crosswalks, an engineering study is needed to determine whether the location is suitable for a marked crosswalk. For an engineering study, a site review may be sufficient at some locations, while a more in depth study of pedestrian volume, vehicle speed, sight distance, vehicle mix, and other factors may be needed at other sites. It is recommended that a minimum utilization of 20 pedestrian crossings per peak hour (or 15 or more elderly and/or child pedestrians) be confirmed at a location before placing a high priority on the installation of a marked crosswalk alone. **P** = Possible increase in pedestrian crash risk may occur if crosswalks are added without other pedestrian facility enhancements. These locations should be closely monitored and enhanced with other pedestrian crossing improvements, if necessary, before adding a marked crosswalk. **N** = Marked crosswalks alone are insufficient, since pedestrian crash risk may be increased by providing marked crosswalks alone. Consider using other treatments or other substantial crossing improvement to improve crossing safety for pedestrians.

Last updated August 28, 2007

APPENDIX A – SIGN LAYOUT TEMPLATES

A-00 Legend (Applies to Sign Details 1 – 58)

Interstate

- A-01 Sign Template 1 – Details of Advance Guide Signs
- A-02 Sign Template 2 – Details of Advance Guide Signs
- A-03 Sign Template 3 – Details of Advance Guide Signs
- A-04 Sign Template 4 – Details of Advance Guide Signs
- A-05 Sign Template 5 – Details of Advance Guide Signs
- A-06 Sign Template 6 – Details of Exit Direction Signs
- A-07 Sign Template 7 – Details of Exit Direction Signs
- A-08 Sign Template 8 – Details of Exit Direction Signs
- A-09 Sign Template 9 – Details of Exit Direction Signs
- A-10 Sign Template 10 – Details of Exit Direction Signs
- A-11 Sign Template 11 – Details of Advance Lane Drop Signs
- A-12 Sign Template 12 – Details of Advance Lane Drop Signs
- A-13 Sign Template 13 – Details of Advance Lane Drop Signs
- A-14 Sign Template 14 – Details of Advance Lane Drop Signs
- A-15 Sign Template 15 – Details of Advance Lane Drop Signs
- A-16 Sign Template 16 – Details of Intermediate Lane Drop Signs
- A-17 Sign Template 17 – Details of Intermediate Lane Drop Signs
- A-18 Sign Template 18 – Details of Intermediate Lane Drop Signs
- A-19 Sign Template 19 – Details of Intermediate Lane Drop Signs
- A-20 Sign Template 20 – Details of Intermediate Lane Drop Signs
- A-21 Sign Template 21 – Details of Exit Direction (Lane Drop) Signs
- A-22 Sign Template 22 – Details of Exit Direction (Lane Drop) Signs
- A-23 Sign Template 23 – Details of Exit Direction (Lane Drop) Signs
- A-24 Sign Template 24 – Details of Exit Direction (Lane Drop) Signs
- A-25 Sign Template 25 – Details of Exit Direction (Lane Drop) Signs
- A-26 Sign Template 26 – Details of Advance Lane Drop Signs
- A-27 Sign Template 27 – Details of Advance Lane Drop Signs
- A-28 Sign Template 28 – Details of Advance Lane Drop Signs
- A-29 Sign Template 29 – Details of Advance Lane Drop Signs
- A-30 Sign Template 30 – Details of Advance Lane Drop Signs
- A-31 Sign Template 31 – Details of Intermediate Lane Drop Signs
- A-32 Sign Template 32 – Details of Intermediate Lane Drop Signs
- A-33 Sign Template 33 – Details of Intermediate Lane Drop Signs
- A-34 Sign Template 34 – Details of Advance Lane Drop Signs
- A-35 Sign Template 35 – Details of Advance Lane Drop Signs
- A-36 Sign Template 36 – Details of Advance Lane Drop Signs
- A-37 Sign Template 37 – Details of Advance Lane Drop Signs
- A-38 Sign Template 38 – Details of Advance Lane Drop Signs
- A-39 Sign Template 39 – Details of Advance Lane Drop Signs
- A-40 Sign Template 40 – Details of Advance Lane Drop Signs
- A-41 Sign Template 41 – Details of Intermediate Lane Drop Signs

- A-42 Sign Template 42 – Details of Intermediate Lane Drop Signs
- A-43 Sign Template 43 – Details of Intermediate Lane Drop Signs
- A-44 Sign Template 44 – Details of Intermediate Lane Drop Signs
- A-45 Sign Template 45 – Details of Intermediate Lane Drop Signs

Limited Access

- A-46 Sign Template 46 – Details of Advance Guide Signs
- A-47 Sign Template 47 – Details of Advance Guide Signs
- A-48 Sign Template 48 – Details of Advance Guide Signs
- A-49 Sign Template 49 – Details of Advance Guide Signs
- A-50 Sign Template 50 – Details of Advance Guide Signs
- A-51 Sign Template 51 – Details of Exit Direction Signs
- A-52 Sign Template 52 – Details of Exit Direction Signs
- A-53 Sign Template 53 – Details of Exit Direction Signs

Supplemental Signs

- A-54 Sign Template 54 – Details of Supplemental Signs
- A-55 Sign Template 55 – Details of Supplemental Signs
- A-56 Sign Template 56 – Details of Supplemental Signs
- A-57 Sign Template 57 – Details of Supplemental Signs
- A-58 Sign Template 58 – Details of Supplemental Signs

Miscellaneous Signs

- A-59 Sign Template 59 – Details of Hospital Signs
- A-60 Sign Template 60 – Details of Mileage Signs
- A-61 Sign Template 61 – Details of Interchange Sequence Signs
- A-62 Sign Template 62 – Details of Political Boundary Signs
- A-63 Sign Template 63 – Details of River to City Signs

SIGN TEMPLATE I

DETAILS OF ADVANCE GUIDE SIGNS

- NO SCALE -

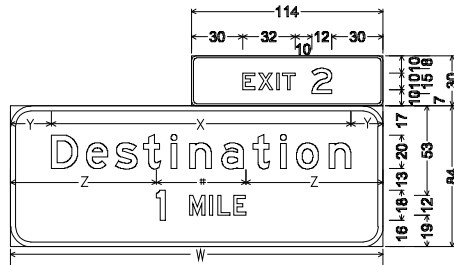

3" Radius, 1" Border, White on Green;
 "EXIT" E Mod. ; "2" E Mod. ;
 12" Radius, 3" Border, White on Green;
 "Destination" E Mod. ; "1" E Mod. ; "MILE" E Mod. Georgia;

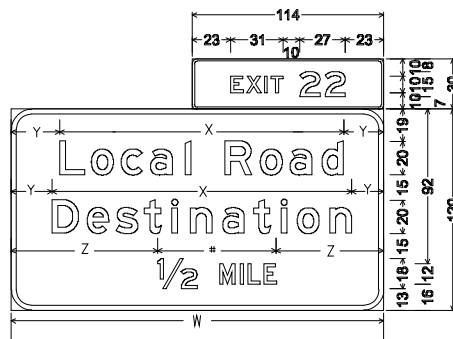

3" Radius, 1" Border, White on Green;
 "EXIT" E Mod. ; "22" E Mod. ;
 12" Radius, 3" Border, White on Green;
 "Destination" E Mod. ; "Local Road" E Mod. ; " 1/2 " E Mod. ;
 "MILE" E Mod. Georgia;

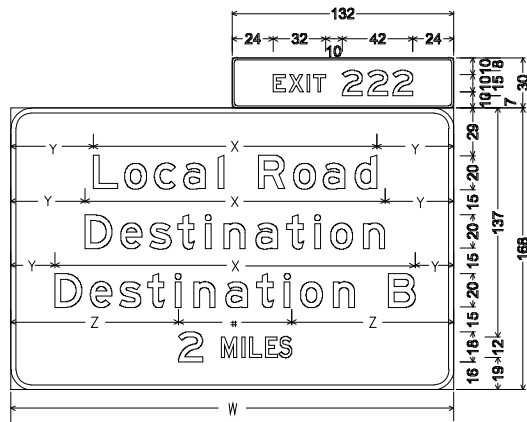

3" Radius, 1" Border, White on Green;
 "EXIT" E Mod. ; "222" E Mod. ;
 12" Radius, 3" Border, White on Green;
 "Destination" E Mod. ; "Destination B" E Mod. ; "Local Road" E Mod. ;
 "2" E Mod. ; "MILE" E Mod. Georgia;

SEE LEGEND ON A-0 FOR VARIABLE DEFINITIONS

SIGN TEMPLATE 2

DETAILS OF ADVANCE GUIDE SIGNS

- NO SCALE -

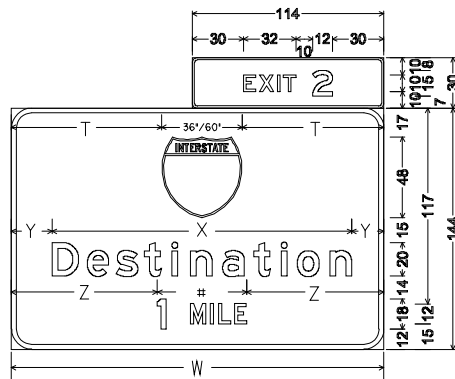

3" Radius, 1" Border, White on Green;
 "EXIT" E Mod. ; "2" E Mod. ;
 12" Radius, 3" Border, White on Green;
 "Destination" E Mod. ; "1" E Mod. ; "MILE" E Mod. Georgia;

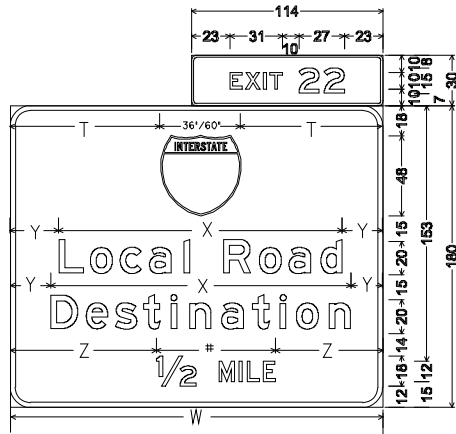

3" Radius, 1" Border, White on Green;
 "EXIT" E Mod. ; "22" E Mod. ;
 12" Radius, 3" Border, White on Green;
 "Destination" E Mod. ; "Local Road" E Mod. ; " 1/2 " E Mod. ;
 "MILE" E Mod. Georgia;

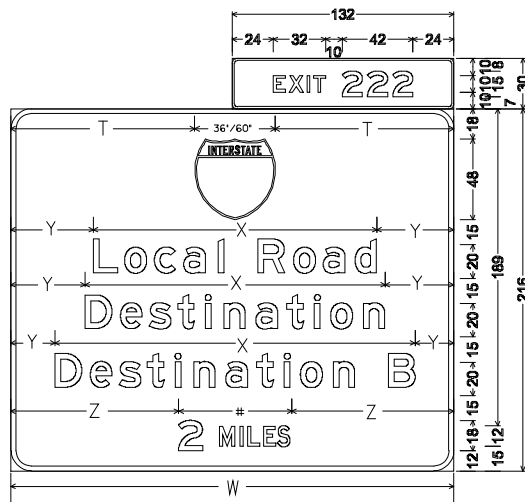

3" Radius, 1" Border, White on Green;
 "EXIT" E Mod. ; "222" E Mod. ;
 12" Radius, 3" Border, White on Green;
 "Destination" E Mod. ; "Destination B" E Mod. ; "Local Road" E Mod. ;
 "2" E Mod. ; "MILE" E Mod. Georgia;

NOTE:
 20" SER. E NUMBERING USED IN INTERSTATE SHIELD

SEE LEGEND ON A-O FOR VARIABLE DEFINITIONS

SIGN TEMPLATE 3 DETAILS OF ADVANCE GUIDE SIGNS

- NO SCALE -

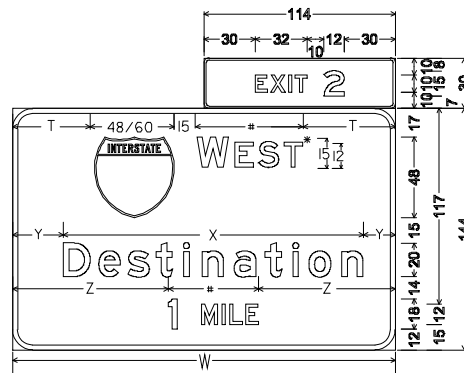

3" Radius, 1" Border, White on Green;
 "EXIT" E Mod.; "2" E Mod.; "WEST" E Mod.;
 12" Radius, 3" Border, White on Green;
 "Destination" E Mod.; "1" E Mod.; "MILE" E Mod. Georgia;

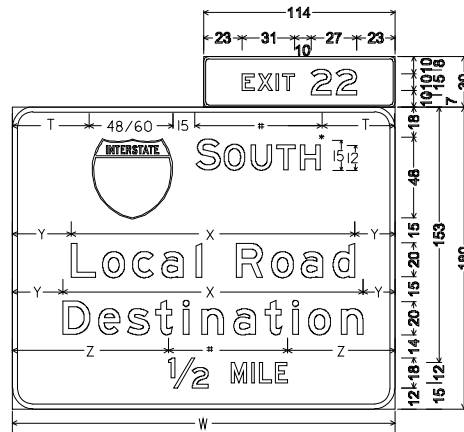

3" Radius, 1" Border, White on Green;
 "EXIT" E Mod.; "22" E Mod.; "SOUTH" E Mod.;
 12" Radius, 3" Border, White on Green;
 "Destination" E Mod.; "Local Road" E Mod.; "1/2" E Mod.;
 "MILE" E Mod. Georgia;

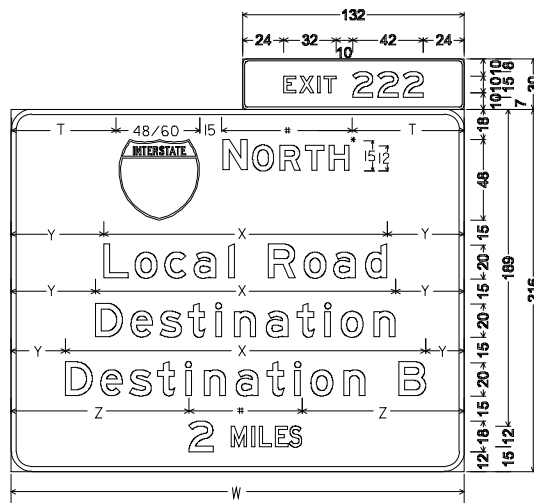

3" Radius, 1" Border, White on Green;
 "EXIT" E Mod.; "222" E Mod.; "NORTH" E Mod.;
 12" Radius, 3" Border, White on Green;
 "Destination" E Mod.; "Destination B" E Mod.; "Local Road" E Mod.;
 "2" E Mod.; "MILE" E Mod. Georgia;

NOTE:
 20" SER. E NUMBERING USED IN INTERSTATE SHIELD

SEE LEGEND ON A-0 FOR VARIABLE DEFINITIONS

SIGN TEMPLATE 4

DETAILS OF ADVANCE GUIDE SIGNS

- NO SCALE -

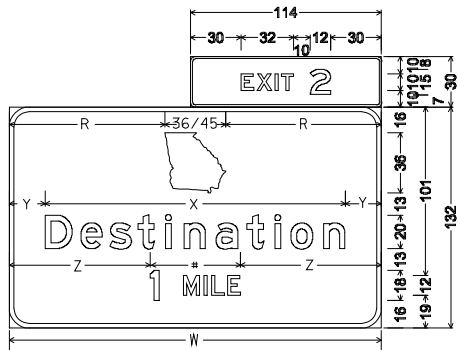

3" Radius, 1" Border, White on Green;
 EXIT E Mod.; *2* E Mod.;
 12" Radius, 3" Border, White on Green;
 Destination E Mod.; *1* E Mod.; *MILE* E Mod. Georgia;

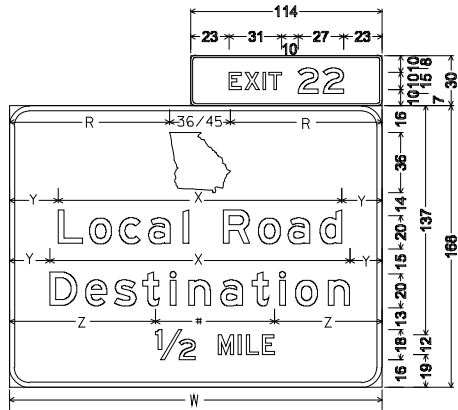

3" Radius, 1" Border, White on Green;
 EXIT E Mod. ; *22* E Mod. ;
 12" Radius, 3" Border, White on Green;
 Destination E Mod. ; *Local Road* E Mod. ; *1/2* E Mod. ;
 MILE E Mod. Georgia;

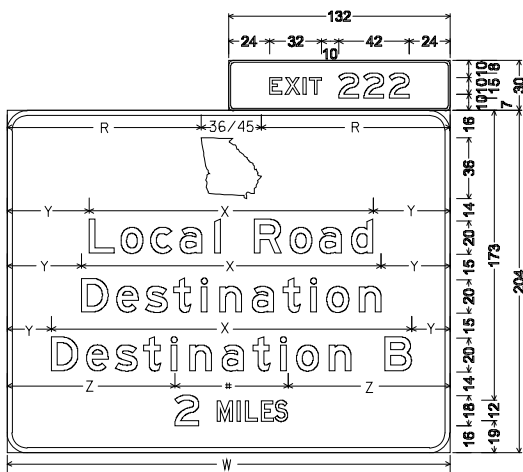

3" Radius, 1" Border, White on Green;
 EXIT E Mod. ; *222* E Mod. ;
 12" Radius, 3" Border, White on Green;
 Destination E Mod. ; *Destination B* E Mod. ; *Local Road* E Mod. ;
 2 E Mod. ; *MILE* E Mod. Georgia;

NOTE:
 15" & 12" SER. E NUMBERING USED IN GEORGIA SHIELD

SEE LEGEND ON A-O FOR VARIABLE DEFINITIONS

SIGN TEMPLATE 5

DETAILS OF ADVANCE GUIDE SIGNS

- NO SCALE -

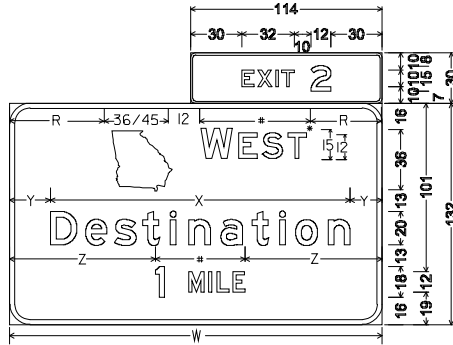

3" Radius, 1" Border, White on Green;
 "EXIT" E Mod.; "2" E Mod.; "WEST" E Mod.;
 12" Radius, 3" Border, White on Green;
 "Destination" E Mod.; "1" E Mod.; "MILE" E Mod. Georgia;

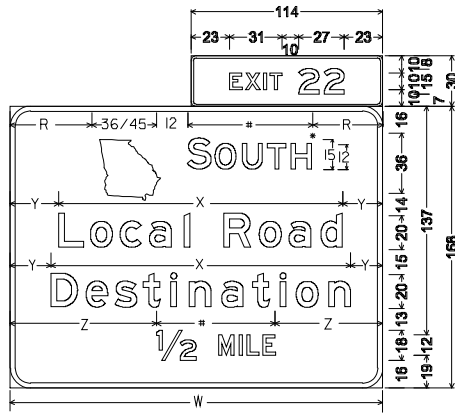

3" Radius, 1" Border, White on Green;
 "EXIT" E Mod.; "22" E Mod.; "SOUTH" E Mod.;
 12" Radius, 3" Border, White on Green;
 "Destination" E Mod.; "Local Road" E Mod.; "1/2" E Mod.;
 "MILE" E Mod. Georgia;

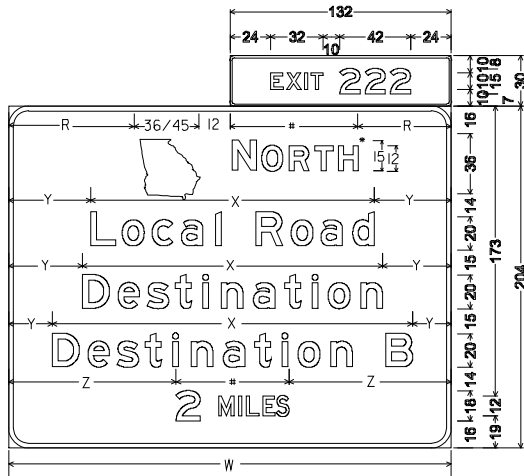

3" Radius, 1" Border, White on Green;
 "EXIT" E Mod.; "222" E Mod.; "NORTH" E Mod.;
 12" Radius, 3" Border, White on Green;
 "Destination" E Mod.; "Destination B" E Mod.; "Local Road" E Mod.;
 "2" E Mod.; "MILE" E Mod. Georgia;

NOTE:

15" & 12" SER. E NUMBERING USED IN GEORGIA SHIELD

SEE LEGEND ON A-O FOR VARIABLE DEFINITIONS

SIGN TEMPLATE 7 DETAILS OF EXIT DIRECTION SIGNS

- NO SCALE -

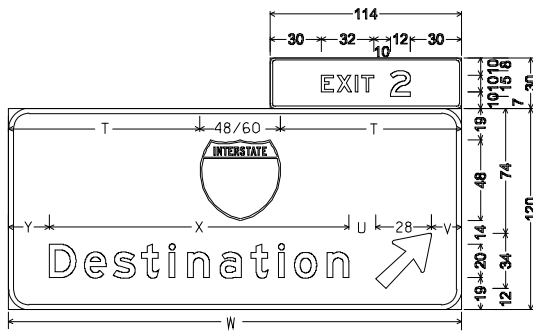

3" Radius, 1" Border, White on Green;
 "EXIT" E Mod. ; "2" E Mod. ;
 12" Radius, 3" Border, White on Green;
 "Destination" E Mod. ; Arrow 18 - 42" 45°;

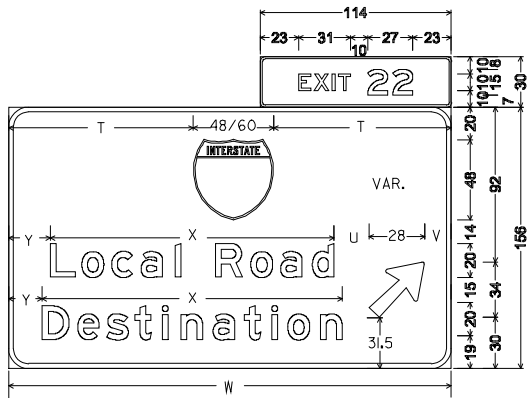

3" Radius, 1" Border, White on Green;
 "EXIT" E Mod. ; "22" E Mod. ;
 12" Radius, 3" Border, White on Green;
 "Destination" E Mod. ; "Local Road" E Mod. ; Arrow 18 - 42" 45°;

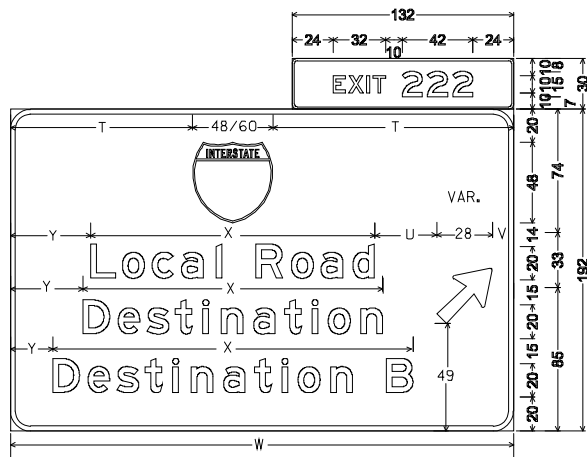

3" Radius, 1" Border, White on Green;
 "EXIT" E Mod. ; "222" E Mod. ;
 12" Radius, 3" Border, White on Green;
 "Destination" E Mod. ; "Destination B" E Mod. ; "Local Road" E Mod. ;
 Arrow 18 - 42" 45°;

~~NOTE:~~
 20" SER. E NUMBERING USED IN INTERSTATE SHIELD

SEE LEGEND ON A-O FOR VARIABLE DEFINITIONS

SIGN TEMPLATE 8

DETAILS OF EXIT DIRECTION SIGNS

- NO SCALE -

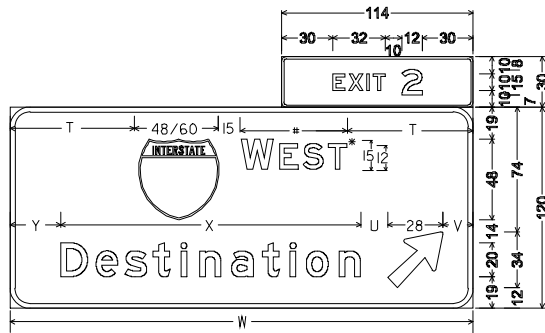

3" Radius, 1" Border, White on Green;
 "EXIT" E Mod.; "2" E Mod.; "WEST" E Mod.;
 12" Radius, 3" Border, White on Green;
 "Destination" E Mod.; Arrow 18 - 42° 45°;

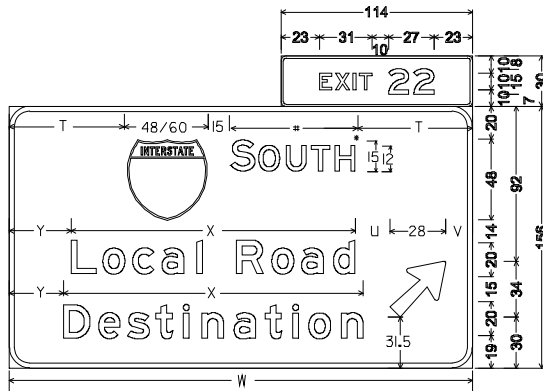

3" Radius, 1" Border, White on Green;
 "EXIT" E; "22" E Mod.; "SOUTH" E Mod.;
 12" Radius, 3" Border, White on Green;
 "Destination" E Mod.; "Local Road" E Mod.; Arrow 18 - 42° 45°;

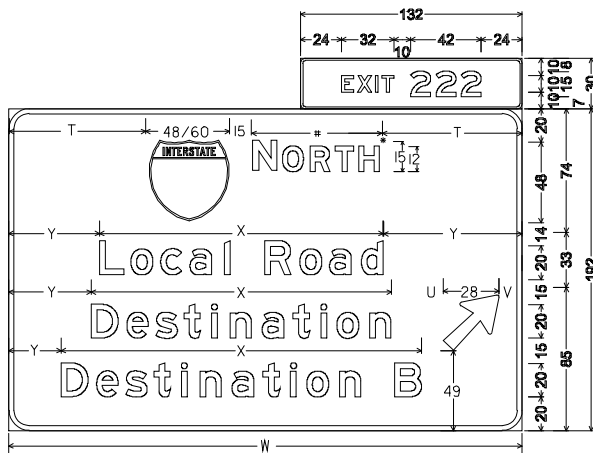

3" Radius, 1" Border, White on Green;
 "EXIT" E Mod.; "222" E Mod.; "NORTH" E Mod.;
 12" Radius, 3" Border, White on Green;
 "Destination" E Mod.; "Destination B" E Mod.; "Local Road" E Mod.;
 Arrow 18 - 42° 45°;

NOTE:
 20" SER. E NUMBERING USED IN INTERSTATE SHIELD

SEE LEGEND ON A-0 FOR VARIABLE DEFINITIONS

SIGN TEMPLATE 9 DETAILS OF EXIT DIRECTION SIGNS

- NO SCALE -

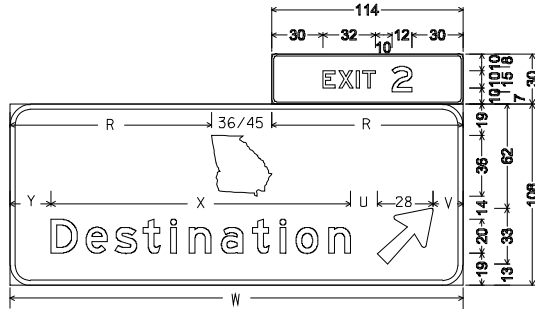

3" Radius, 1" Border, White on Green;
 "EXIT" E Mod. ; "2" E Mod. ;
 12" Radius, 3" Border, White on Green;
 "Destination" E Mod. ; Arrow 18 - 42° 45°;

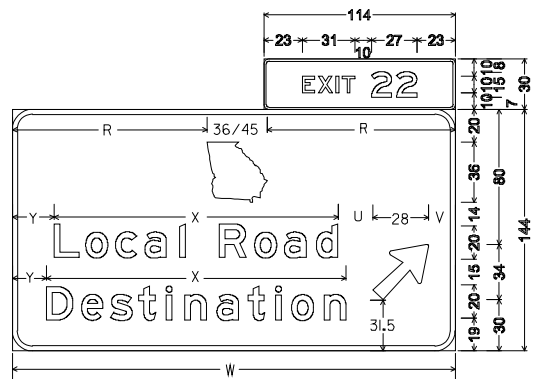

3" Radius, 1" Border, White on Green;
 "EXIT" E Mod. ; "22" E Mod. ;
 12" Radius, 3" Border, White on Green;
 "Destination" E Mod. ; "Local Road" E Mod. ; Arrow 18 - 42° 45°;

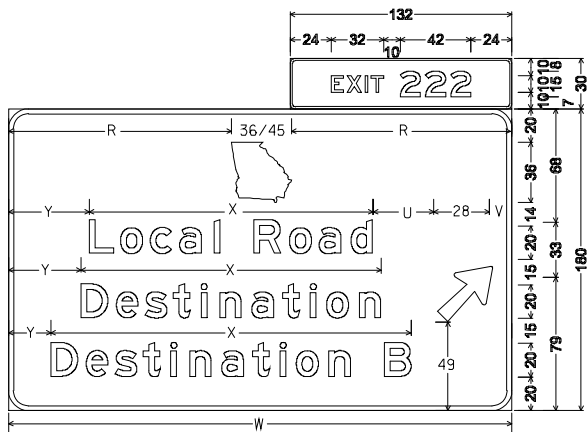

3" Radius, 1" Border, White on Green;
 "EXIT" E Mod. ; "222" E Mod. ;
 12" Radius, 3" Border, White on Green;
 "Destination" E Mod. ; "Destination B" E Mod. ; "Local Road" E Mod. ;
 Arrow 18 - 42° 45°;

NOTE:

15" & 12" SER. E NUMBERING USED IN GEORGIA SHIELD

SEE LEGEND ON A-O FOR VARIABLE DEFINITIONS

SIGN TEMPLATE 10 DETAILS OF EXIT DIRECTION SIGNS

- NO SCALE -

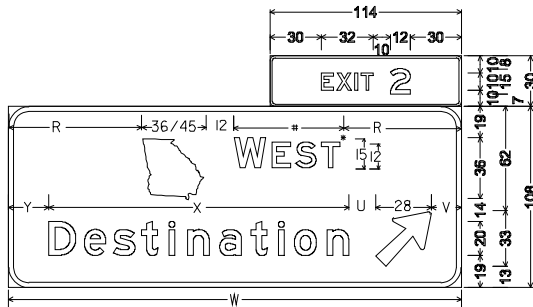

3" Radius, 1" Border, White on Green;
 "EXIT" E Mod. ; "2" E Mod. ; "WEST" E Mod. ;
 12" Radius, 3" Border, White on Green;
 "Destination" E Mod. ; Arrow 18 - 42° 45°;

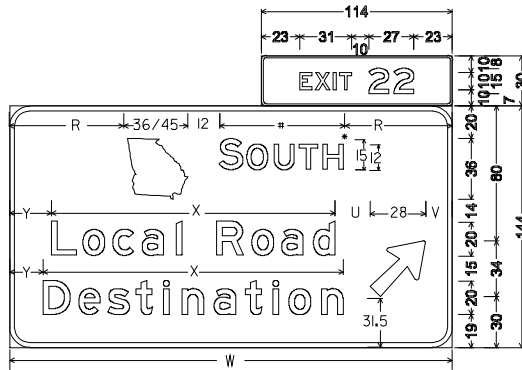

3" Radius, 1" Border, White on Green;
 "EXIT" E Mod. ; "22" E Mod. ; "SOUTH" E Mod. ;
 12" Radius, 3" Border, White on Green;
 "Destination" E Mod. ; "Local Road" E Mod. ; Arrow 18 - 42° 45°;

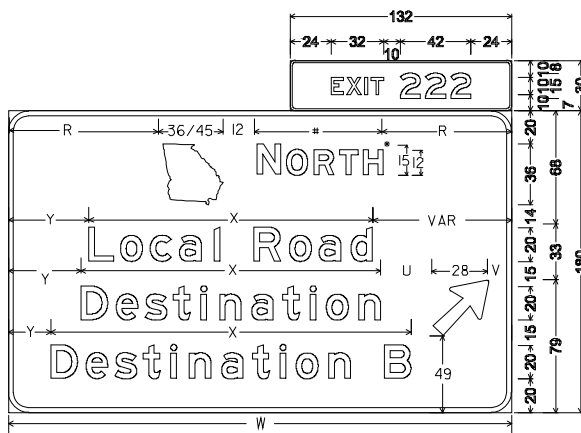

3" Radius, 1" Border, White on Green;
 "EXIT" E Mod. ; "222" E Mod. ; "NORTH" E Mod. ;
 12" Radius, 3" Border, White on Green;
 "Destination" E Mod. ; "Destination B" E Mod. ; "Local Road" E Mod. ;
 Arrow 18 - 42° 45°;

NOTE:

15" & 12" SER. E NUMBERING USED IN GEORGIA SHIELD

SEE LEGEND ON A-O FOR VARIABLE DEFINITIONS

SIGN TEMPLATE II

DETAILS OF ADVANCE LANE DROP SIGNS

- NO SCALE -

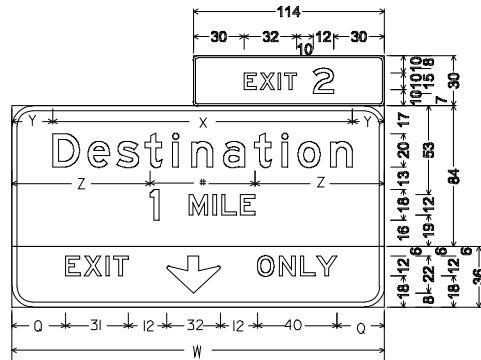

3" Radius, 1" Border, White on Green;
 EXIT E Mod. ; *2* E Mod. ;
 12" Radius, 3" Border, White on Green;
 Destination E Mod. ; *1 MILE* E Mod. ;
 12" Radius, 3" Border, Black on Yellow;
 EXIT D; Down Arrow 22" 270"; *ONLY* D;

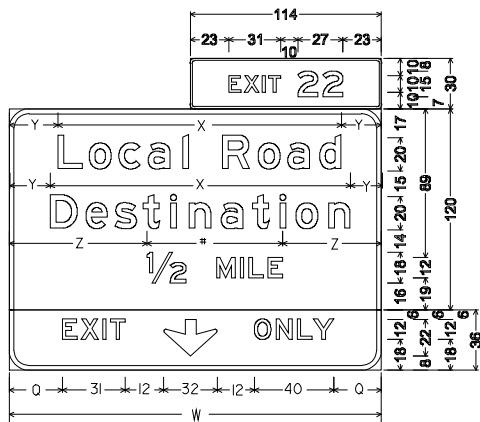

3" Radius, 1" Border, White on Green;
 EXIT E Mod. ; *22* E Mod. ;
 12" Radius, 3" Border, White on Green;
 Destination E Mod. ; *Local Road* E Mod. ; *1/2 MILE* E Mod. ;
 12" Radius, 3" Border, Black on Yellow;
 EXIT D; Down Arrow 22" 270"; *ONLY* D;

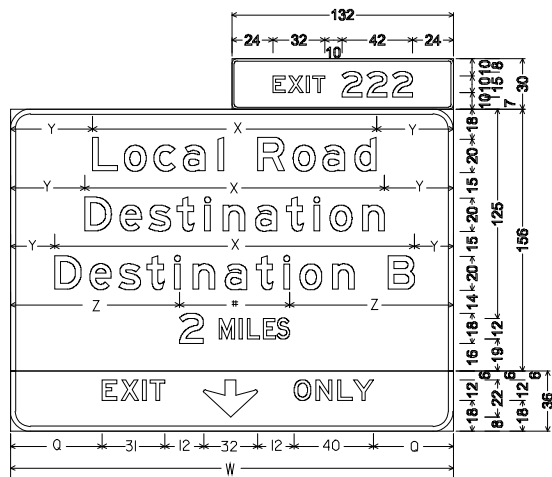

3" Radius, 1" Border, White on Green;
 EXIT E Mod. ; *222* E Mod. ;
 12" Radius, 3" Border, White on Green;
 Destination E Mod. ; *Destination B* E Mod. ; *Local Road* E Mod. ;
 2 MILE E Mod. ;
 12" Radius, 3" Border, Black on Yellow;
 EXIT D; Down Arrow 22" 270"; *ONLY* D;

SEE LEGEND ON A-0 FOR VARIABLE DEFINITIONS

SIGN TEMPLATE 12

DETAILS OF ADVANCE LANE DROP SIGNS

- NO SCALE -

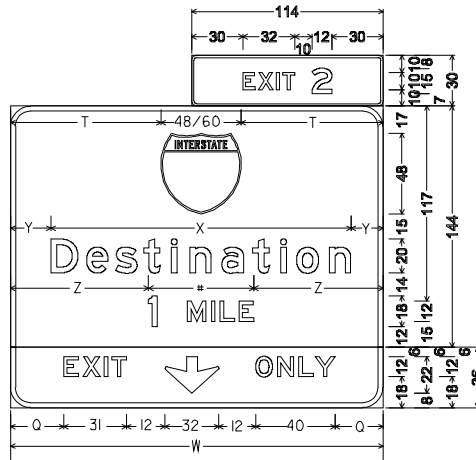

3" Radius, 1" Border, White on Green;
 "EXIT" E Mod. ; "2" E Mod. ;
 12" Radius, 3" Border, White on Green;
 "Destination" E Mod. ; "1 MILE" E Mod. ;
 12" Radius, 3" Border, Black on Yellow;
 "EXIT" D; Down Arrow 22" 270"; "ONLY" D;

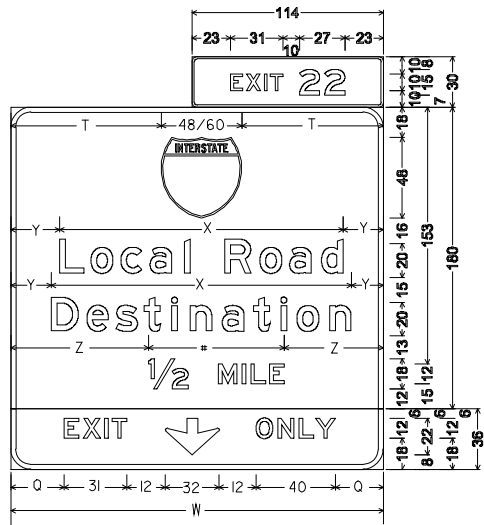

3" Radius, 1" Border, White on Green;
 "EXIT" E Mod. ; "22" E Mod. ;
 12" Radius, 3" Border, White on Green;
 "Destination" E Mod.; "Local Road" E Mod.; " 1/2 MILE" E Mod. ;
 12" Radius, 3" Border, Black on Yellow;
 "EXIT" D; Down Arrow 22" 270"; "ONLY" D;

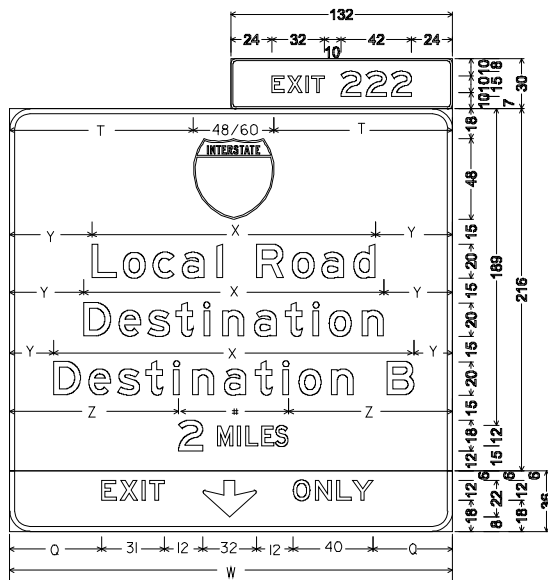

3" Radius, 1" Border, White on Green;
 "EXIT" E Mod. ; "222" E Mod. ;
 12" Radius, 3" Border, White on Green;
 " " Black E Mod.; "Destination" E Mod. ; "Destination B" E Mod.;
 "Local Road" E Mod.; "2 MILE" E Mod. ;
 12" Radius, 3" Border, Black on Yellow;
 "EXIT" D; Down Arrow 22" 270"; "ONLY" D;

NOTE:
 20" SER. E NUMBERING USED IN INTERSTATE SHIELD

SEE LEGEND ON A-0 FOR VARIABLE DEFINITIONS

SIGN TEMPLATE 13

DETAILS OF ADVANCE LANE DROP SIGNS

- NO SCALE -

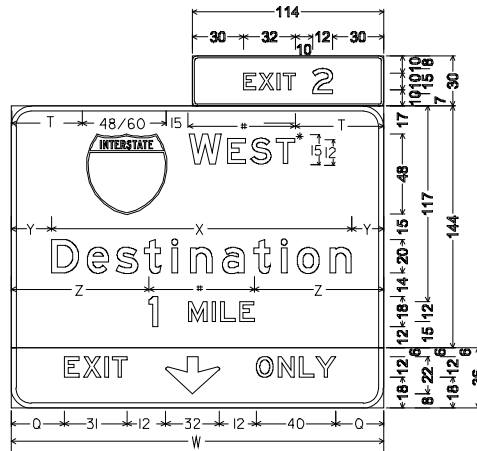

3" Radius, 1" Border, White on Green;
 "EXIT" E; "2" E Mod.; "WEST" E Mod.;
 12" Radius, 3" Border, White on Green;
 "Destination" E Mod.; "1 MILE" E Mod.;
 12" Radius, 3" Border, Black on Yellow;
 "EXIT" D; Down Arrow 22" 270"; "ONLY" D;

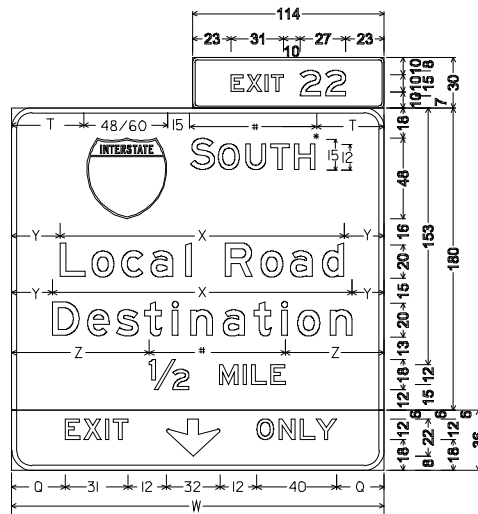

3" Radius, 1" Border, White on Green;
 "EXIT" E Mod.; "22" E Mod.; "SOUTH" E Mod.;
 12" Radius, 3" Border, White on Green;
 "Destination" E Mod.; "Local Road" E Mod.; "1/2 MILE" E Mod.;
 12" Radius, 3" Border, Black on Yellow;
 "EXIT" D; Down Arrow 22" 270"; "ONLY" D;

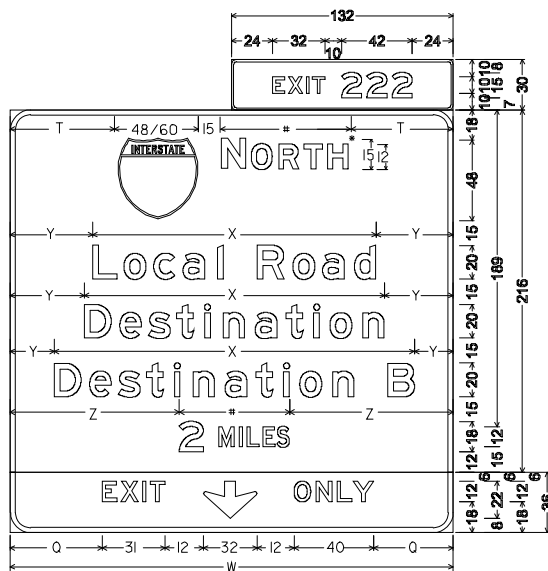

3" Radius, 1" Border, White on Green;
 "EXIT" E Mod.; "222" E Mod.; "NORTH" E Mod.;
 12" Radius, 3" Border, White on Green;
 "Destination" E Mod.; "Destination B" E Mod.; "Local Road" E Mod.;
 "2 MILE" E Mod.;
 12" Radius, 3" Border, Black on Yellow;
 "EXIT" D; Down Arrow 22" 270"; "ONLY" D;

NOTE:
 20" SER. E NUMBERING USED IN INTERSTATE SHIELD

SEE LEGEND ON A-O FOR VARIABLE DEFINITIONS

SIGN TEMPLATE 14

DETAILS OF ADVANCE LANE DROP SIGNS

- NO SCALE -

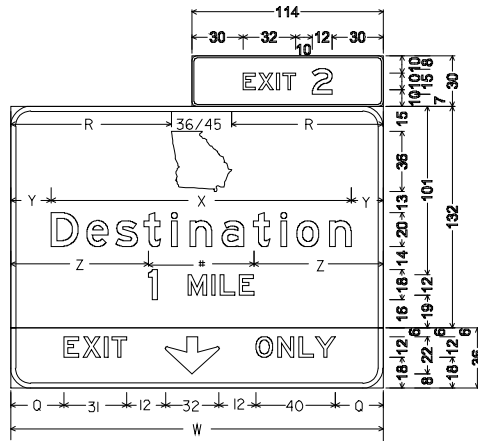

3" Radius, 1" Border, White on Green;
 "EXIT" E Mod. ; "2" E Mod. ;
 12" Radius, 3" Border, White on Green;
 "Destination" E Mod. ; "1 MILE" E Mod. ;
 12" Radius, 3" Border, Black on Yellow;
 "EXIT" D; Down Arrow 22" 270"; "ONLY" D;

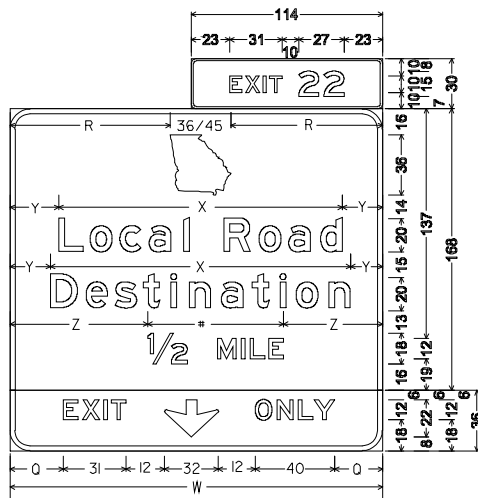

3" Radius, 1" Border, White on Green;
 "EXIT" E Mod. ; "22" E Mod. ;
 12" Radius, 3" Border, White on Green;
 "Destination" E Mod. ; "Local Road" E Mod. ; "1/2 MILE" E Mod. ;
 12" Radius, 3" Border, Black on Yellow;
 "EXIT" D; Down Arrow 22" 270"; "ONLY" D;

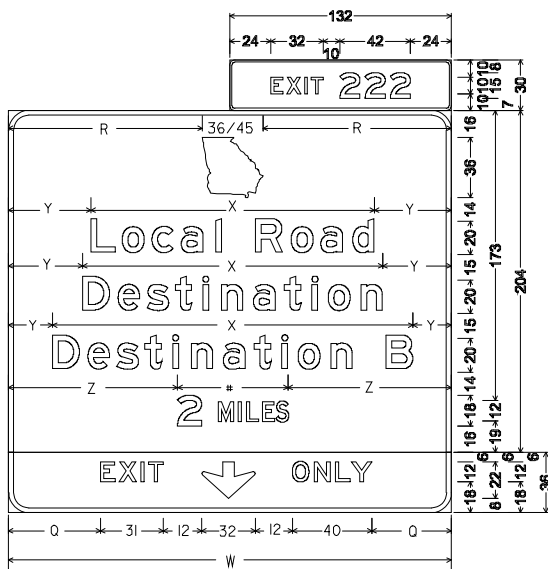

3" Radius, 1" Border, White on Green;
 "EXIT" E Mod. ; "222" E Mod. ;
 12" Radius, 3" Border, White on Green;
 "Destination" E Mod. ; "Destination B" E Mod. ; "Local Road" E Mod. ;
 "2 MILE" E Mod. ;
 12" Radius, 3" Border, Black on Yellow;
 "EXIT" D; Down Arrow 22" 270"; "ONLY" D;

NOTE:

15" & 12" SER. E NUMBERING USED IN GEORGIA SHIELD

SEE LEGEND ON A-0 FOR VARIABLE DEFINITIONS

SIGN TEMPLATE 15

DETAILS OF ADVANCE LANE DROP SIGNS

- NO SCALE -

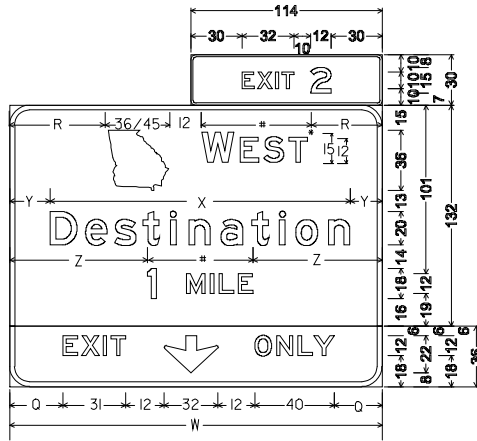

3" Radius, 1" Border, White on Green;
 "EXIT" E Mod. ; "2" E Mod. ; "WEST" E Mod. ;
 12" Radius, 3" Border, White on Green;
 "Destination" E Mod. ; "1 MILE" E Mod. ;
 12" Radius, 3" Border, Black on Yellow;
 "EXIT" D; Down Arrow 22" 270"; "ONLY" D;

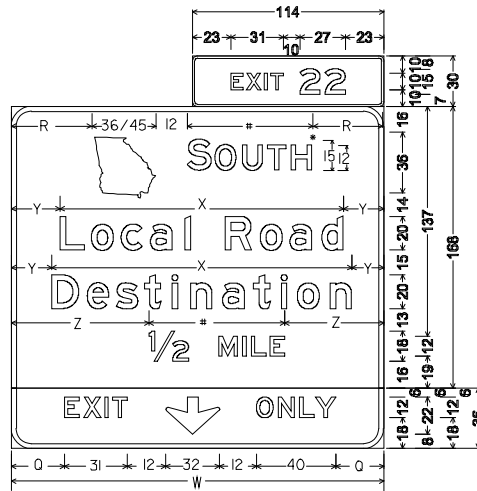

3" Radius, 1" Border, White on Green;
 "EXIT" E Mod. ; "22" E Mod. ; "NORTH" E Mod. ;
 12" Radius, 3" Border, White on Green;
 "Destination" E Mod. ; "Local Road" E Mod. ; "1/2 MILE" E Mod. ;
 12" Radius, 3" Border, Black on Yellow;
 "EXIT" D; Down Arrow 22" 270"; "ONLY" D;

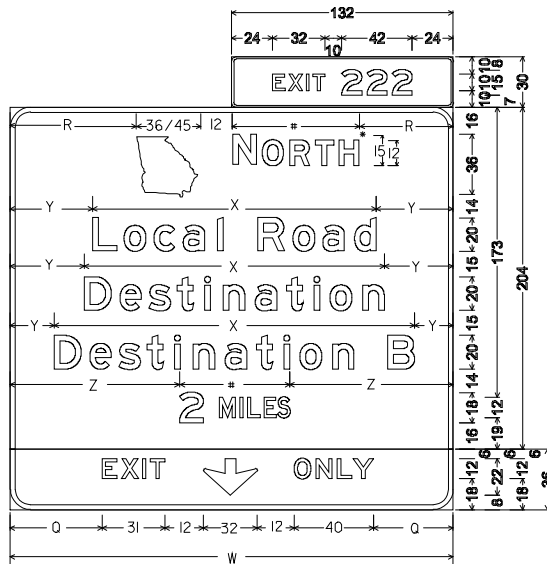

3" Radius, 1" Border, White on Green;
 "EXIT" E; "222" E Mod. ; "SOUTH" E Mod. ;
 12" Radius, 3" Border, White on Green;
 "Destination" E Mod. ; "Destination B" E Mod. ; "Local Road" E Mod. ;
 "2 MILE" E Mod. ;
 12" Radius, 3" Border, Black on Yellow;
 "EXIT" D; Down Arrow 22" 270"; "ONLY" D;

NOTE:
 15" & 12" SER. E NUMBERING USED IN GEORGIA SHIELD
 SEE LEGEND ON A-O FOR VARIABLE DEFINITIONS

SIGN TEMPLATE 16

DETAILS OF INTERMEDIATE LANE DROP SIGNS

- NO SCALE -

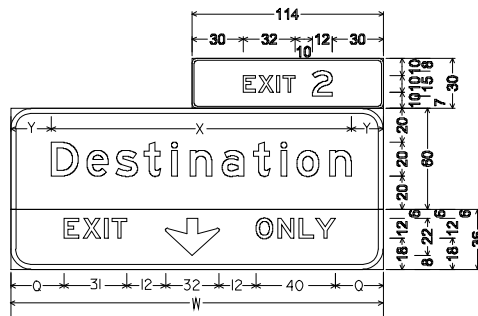

3" Radius, 1" Border, White on Green;
 "EXIT" E Mod.; "2" E Mod.;
 12" Radius, 3" Border, White on Green;
 "Destination" E Mod.;
 12" Radius, 3" Border, Black on Yellow;
 "EXIT" D; Down Arrow 22° 270°; "ONLY" D;

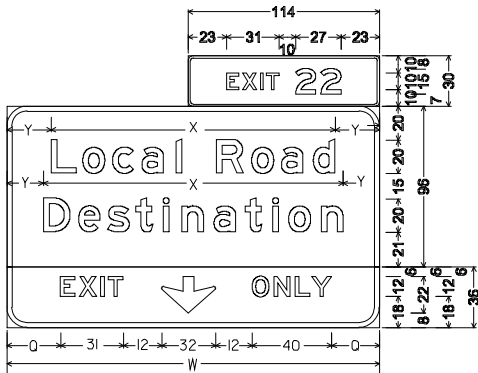

3" Radius, 1" Border, White on Green;
 "EXIT" E Mod.; "22" E Mod.;
 12" Radius, 3" Border, White on Green;
 "Destination" E Mod.; "Local Road" E Mod.;
 12" Radius, 3" Border, Black on Yellow;
 "EXIT" D; Down Arrow 22° 270°; "ONLY" D;

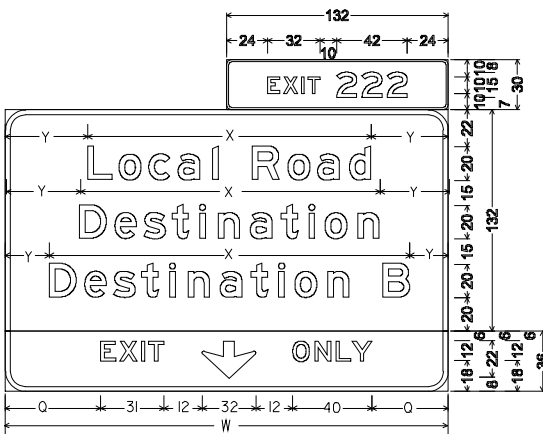

3" Radius, 1" Border, White on Green;
 "EXIT" E Mod.; "222" E Mod.;
 12" Radius, 3" Border, White on Green;
 "Destination" E Mod.; "Destination B" E Mod.; "Local Road" E Mod.;
 12" Radius, 3" Border, Black on Yellow;
 "EXIT" D; Down Arrow 22° 270°; "ONLY" D;

SEE LEGEND ON A-O FOR VARIABLE DEFINITIONS

SIGN TEMPLATE 17

DETAILS OF INTERMEDIATE LANE DROP SIGNS

- NO SCALE -

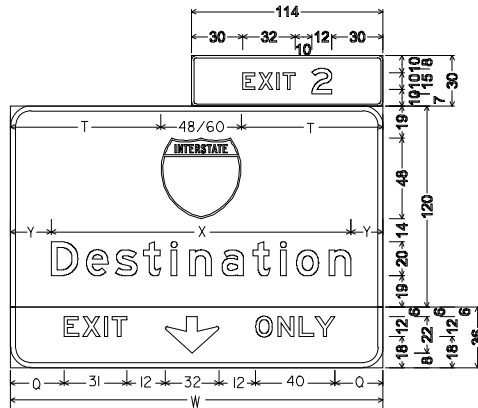

3" Radius, 1" Border, White on Green;
 "EXIT" E Mod. ; "2" E Mod. ;
 12" Radius, 3" Border, White on Green;
 "Destination" E Mod. ;
 12" Radius, 3" Border, Black on Yellow;
 "EXIT" D; Down Arrow 22" 270"; "ONLY" D;

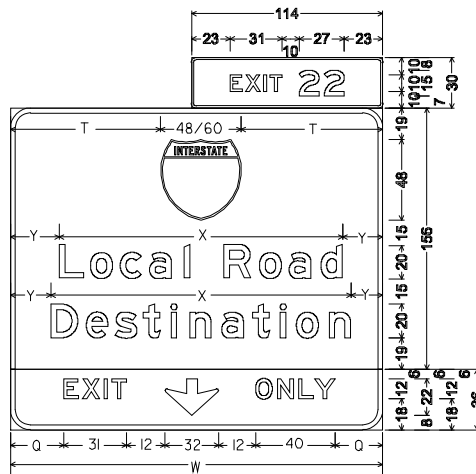

3" Radius, 1" Border, White on Green;
 "EXIT" E Mod. ; "22" E Mod. ;
 12" Radius, 3" Border, White on Green;
 "Destination" E Mod.; "Local Road" E Mod. ;
 12" Radius, 3" Border, Black on Yellow;
 "EXIT" D; Down Arrow 22" 270"; "ONLY" D;

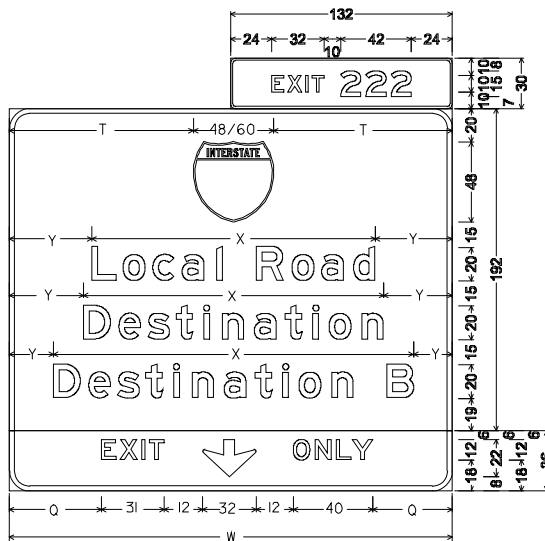

3" Radius, 1" Border, White on Green;
 "EXIT" E Mod. ; "222" E Mod. ;
 12" Radius, 3" Border, White on Green;
 "Destination" E Mod. ; "Destination B" E Mod. ; "Local Road" E Mod. ;
 12" Radius, 3" Border, Black on Yellow;
 "EXIT" D; Down Arrow 22" 270"; "ONLY" D;

NOTE:
 20" SER. E NUMBERING USED IN INTERSTATE SHIELD

SEE LEGEND ON A-0 FOR VARIABLE DEFINITIONS

SIGN TEMPLATE 18

DETAILS OF INTERMEDIATE LANE DROP SIGNS

- NO SCALE -

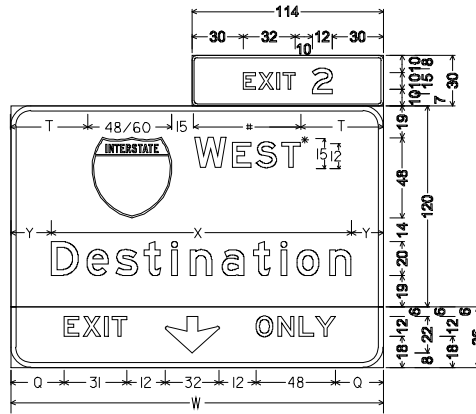

3" Radius, 1" Border, White on Green;
 "EXIT" E Mod.; "2" E Mod.; "WEST" E Mod.;
 12" Radius, 3" Border, White on Green;
 "Destination" E Mod.;
 12" Radius, 3" Border, Black on Yellow;
 "EXIT" D; Down Arrow 22" 270"; "ONLY" D;

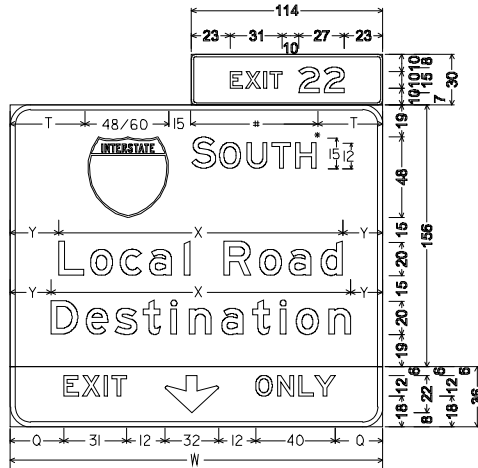

3" Radius, 1" Border, White on Green;
 "EXIT" E Mod.; "22" E Mod.; "NORTH" E Mod.;
 12" Radius, 3" Border, White on Green;
 "Destination" E Mod.; "Local Road" E Mod.;
 12" Radius, 3" Border, Black on Yellow;
 "EXIT" D; Down Arrow 22" 270"; "ONLY" D;

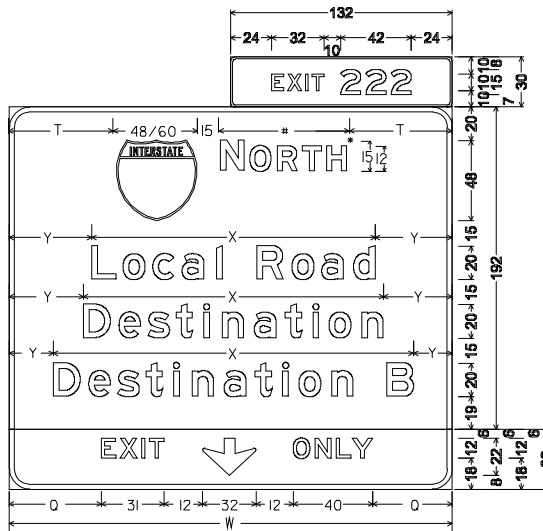

3" Radius, 1" Border, White on Green;
 "EXIT" E Mod.; "222" E Mod.; "SOUTH" E Mod.;
 12" Radius, 3" Border, White on Green;
 "Destination" E Mod.; "Destination B" E Mod.; "Local Road" E Mod.;
 12" Radius, 3" Border, Black on Yellow;
 "EXIT" D; Down Arrow 22" 270"; "ONLY" D;

NOTE:
 20" SER. E NUMBERING USED IN INTERSTATE SHIELD

SEE LEGEND ON A-O FOR VARIABLE DEFINITIONS

SIGN TEMPLATE 19

DETAILS OF INTERMEDIATE LANE DROP SIGNS

- NO SCALE -

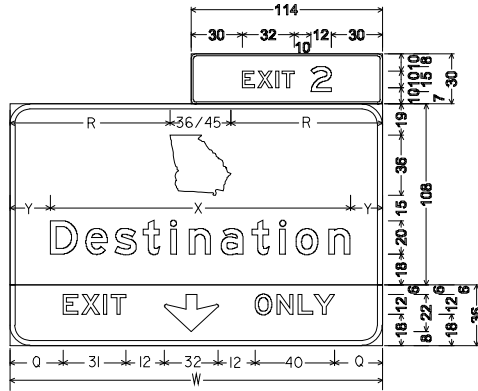

3" Radius, 1" Border, White on Green;
 "EXIT" E Mod. ; "2" E Mod. ;
 12" Radius, 3" Border, White on Green;
 "Destination" E Mod. ;
 12" Radius, 3" Border, Black on Yellow;
 "EXIT" D; Down Arrow 22" 270"; "ONLY" D;

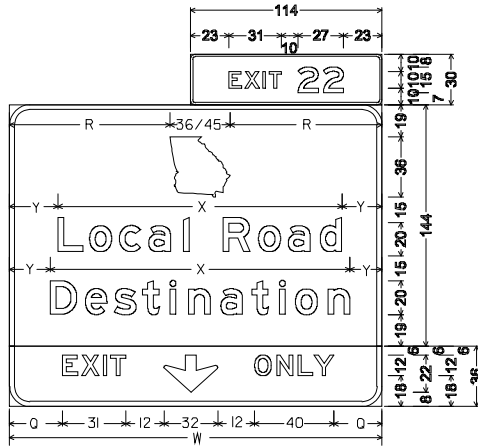

3" Radius, 1" Border, White on Green;
 "EXIT" E Mod. ; "22" E Mod. ;
 12" Radius, 3" Border, White on Green;
 "Destination" E Mod. ; "Local Road" E Mod. ;
 12" Radius, 3" Border, Black on Yellow;
 "EXIT" D; Down Arrow 22" 270"; "ONLY" D;

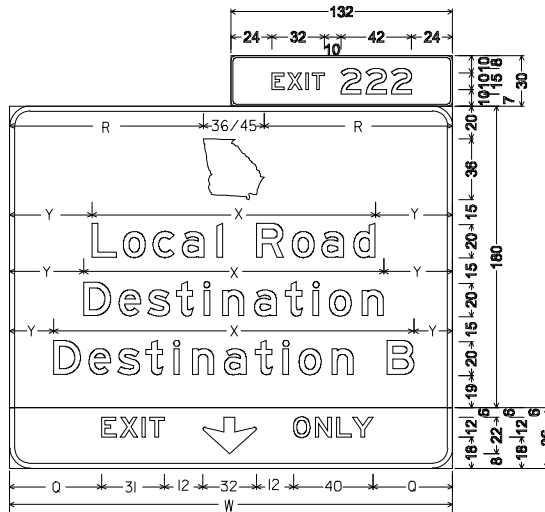

3" Radius, 1" Border, White on Green;
 "EXIT" E Mod. ; "222" E Mod. ;
 12" Radius, 3" Border, White on Green;
 "Destination" E Mod. ; "Destination B" E Mod. ; "Local Road" E Mod. ;
 12" Radius, 3" Border, Black on Yellow;
 "EXIT" D; Down Arrow 22" 270"; "ONLY" D;

NOTE:

15" & 12" SER. E NUMBERING USED IN GEORGIA SHIELD

SEE LEGEND ON A-0 FOR VARIABLE DEFINITIONS

SIGN TEMPLATE 20

DETAILS OF INTERMEDIATE LANE DROP SIGNS

- NO SCALE -

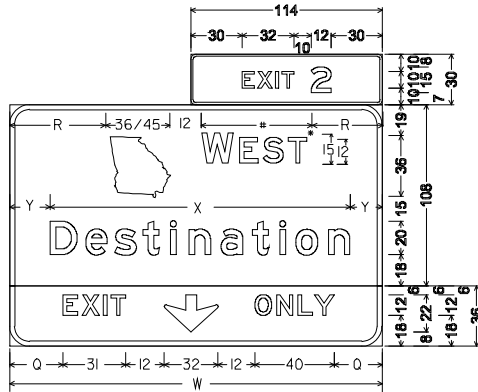

3" Radius, 1" Border, White on Green;
 "EXIT" E Mod.; "2" E Mod.; "WEST" E Mod.;
 12" Radius, 3" Border, White on Green;
 "Destination" E Mod.;
 12" Radius, 3" Border, Black on Yellow;
 "EXIT" D; Down Arrow 22" 270"; "ONLY" D;

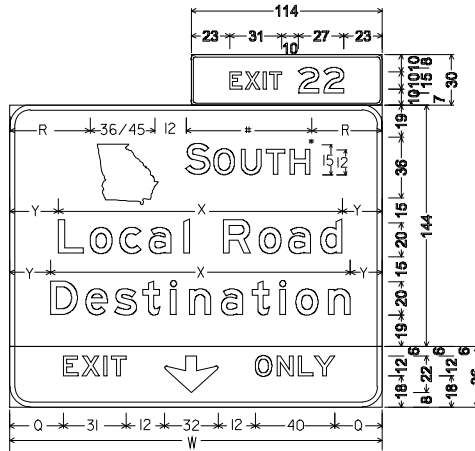

3" Radius, 1" Border, White on Green;
 "EXIT" E Mod.; "22" E Mod.; "NORTH" E Mod.;
 12" Radius, 3" Border, White on Green;
 "Destination" E Mod.; "Local Road" E Mod.;
 12" Radius, 3" Border, Black on Yellow;
 "EXIT" D; Down Arrow 22" 270"; "ONLY" D;

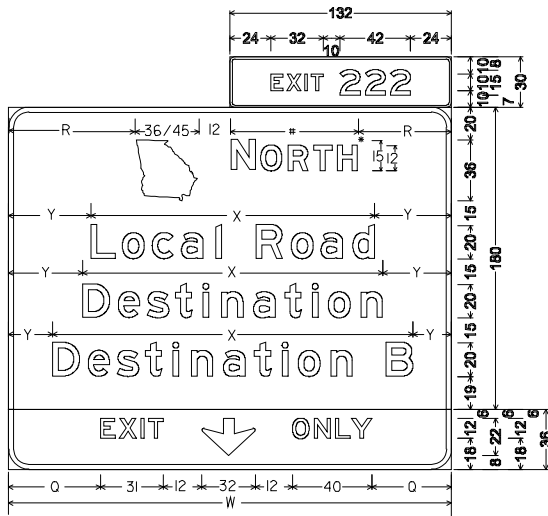

3" Radius, 1" Border, White on Green;
 "EXIT" E Mod.; "222" E Mod.; "SOUTH" E Mod.;
 12" Radius, 3" Border, White on Green;
 "Destination" E Mod.; "Destination B" E Mod.; "Local Road" E Mod.;
 12" Radius, 3" Border, Black on Yellow;
 "EXIT" D; Down Arrow 22" 270"; "ONLY" D;

NOTE:

15" & 12" SER. E NUMBERING USED IN GEORGIA SHIELD

SEE LEGEND ON A-O FOR VARIABLE DEFINITIONS

SIGN TEMPLATE 21

DETAILS OF EXIT DIRECTION (LANE DROP) SIGNS

- NO SCALE -

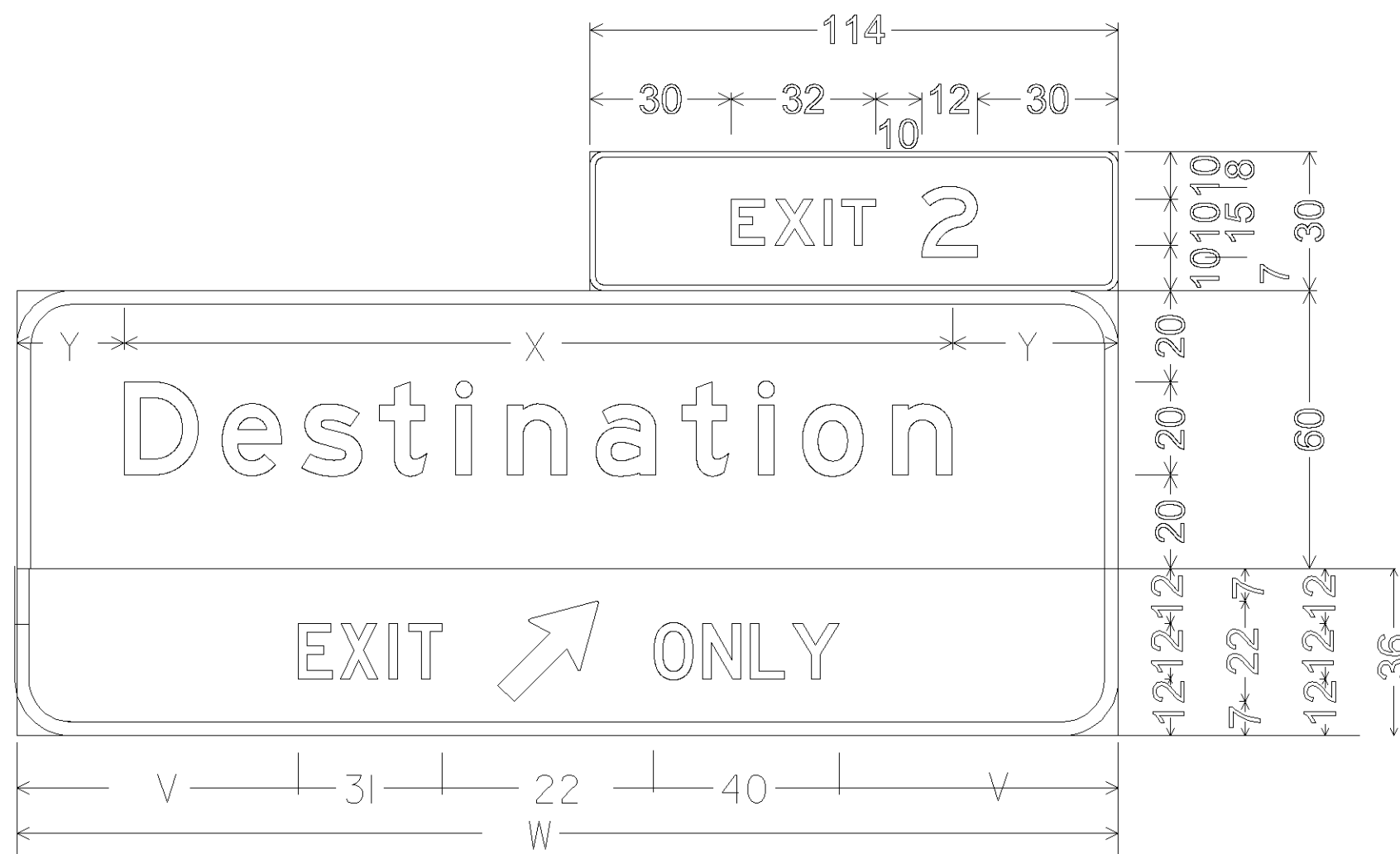

3" Radius, 1" Border, White on Green;
 "EXIT" E; "2" E;
 12" Radius, 3" Border, White on Green;
 "Destination" E; Arrow 18 - 42° 45°;
 12" Radius, 3" Border, Black on Yellow;
 "EXIT ONLY" D;

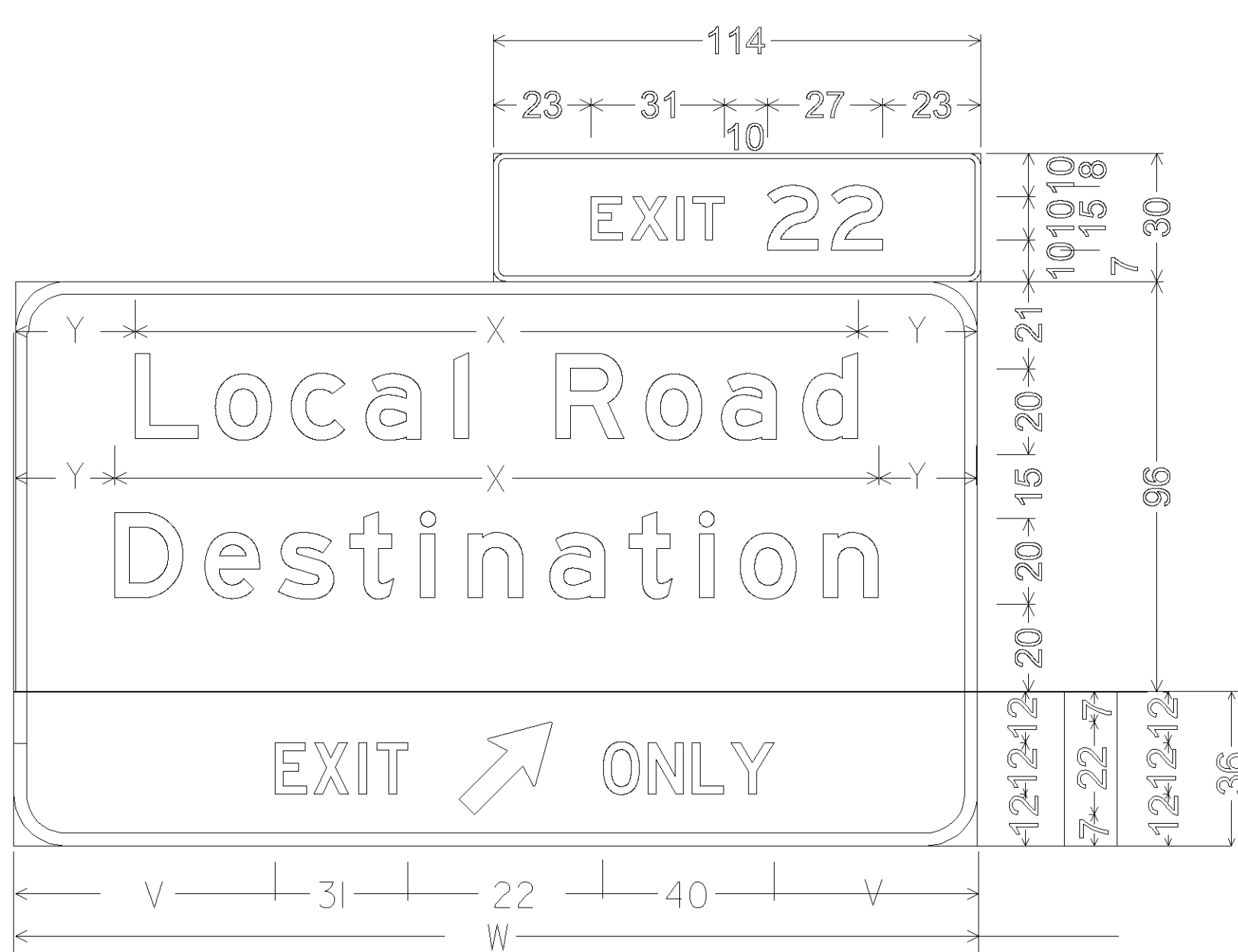

3" Radius, 1" Border, White on Green;
 "EXIT" E; "22" E;
 12" Radius, 3" Border, White on Green;
 "Destination" E; "Local Road" E; Arrow 18 - 42° 45°;
 12" Radius, 3" Border, Black on Yellow;
 "EXIT" D; "ONLY" D;

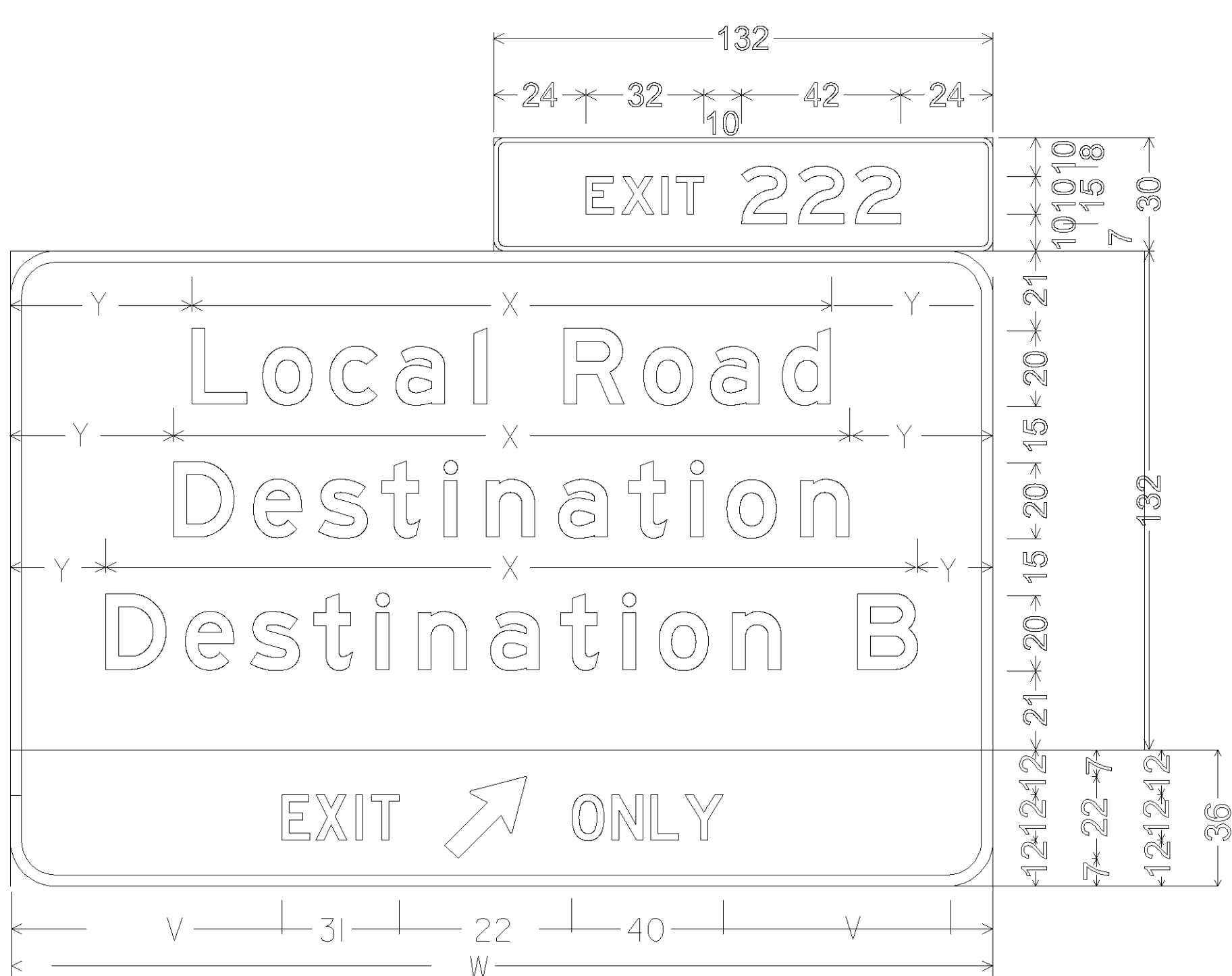

3" Radius, 1" Border, White on Green;
 "EXIT" E; "222" E;
 12" Radius, 3" Border, White on Green;
 "Destination" E; "Destination B" E; "Local Road" E;
 Arrow 18 - 42° 45°;
 12" Radius, 3" Border, Black on Yellow;
 "EXIT" D; "ONLY" D;

SEE LEGEND ON A-0 FOR VARIABLE DEFINITIONS

SIGN TEMPLATE 22

DETAILS OF EXIT DIRECTION (LANE DROP) SIGNS

- NO SCALE -

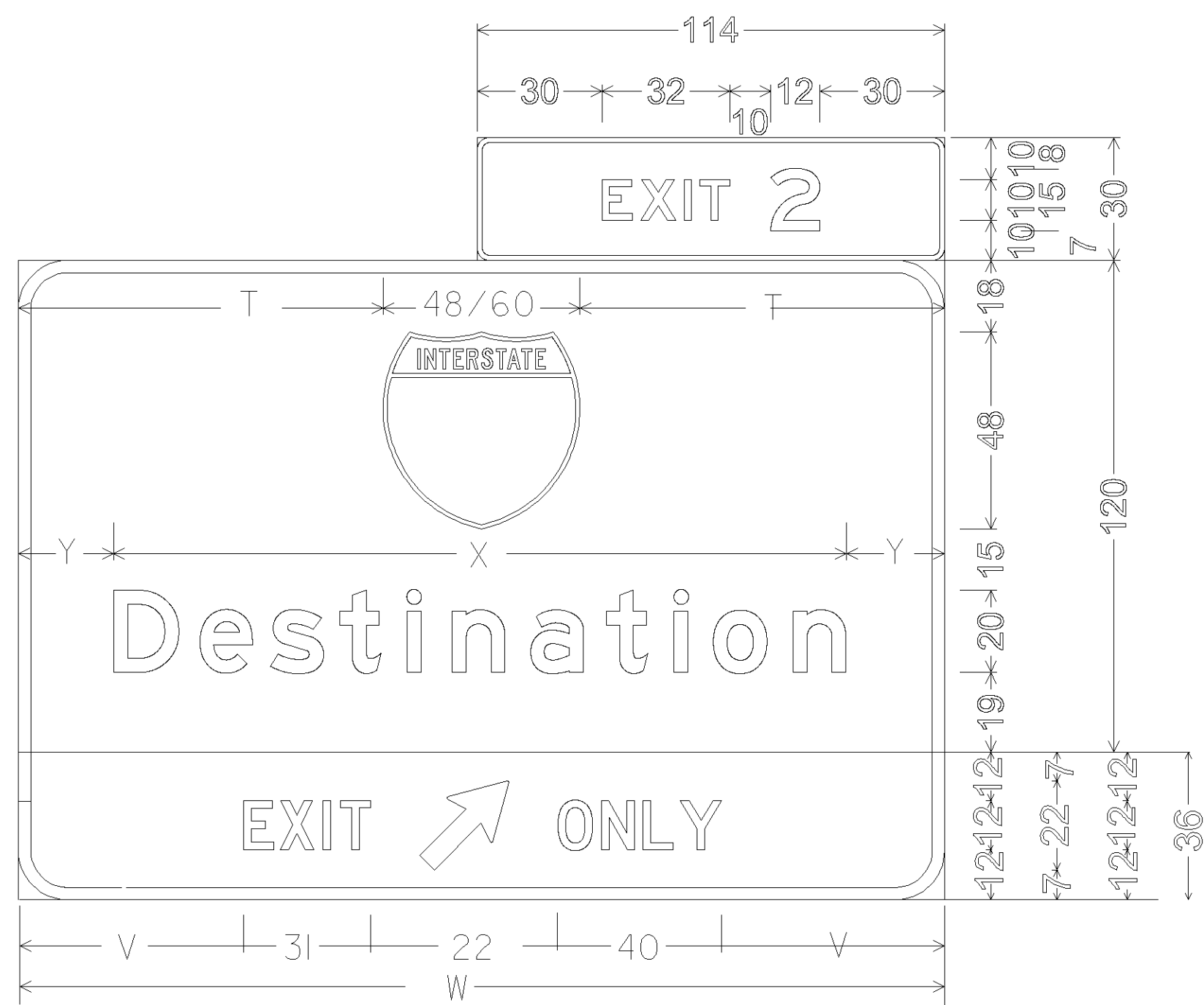

3" Radius, 1" Border, White on Green;
 "EXIT" E; "2" E;
 12" Radius, 3" Border, White on Green;
 "Destination" E; Arrow 18 - 42° 45°;
 12" Radius, 3" Border, Black on Yellow;
 "EXIT ONLY" D;

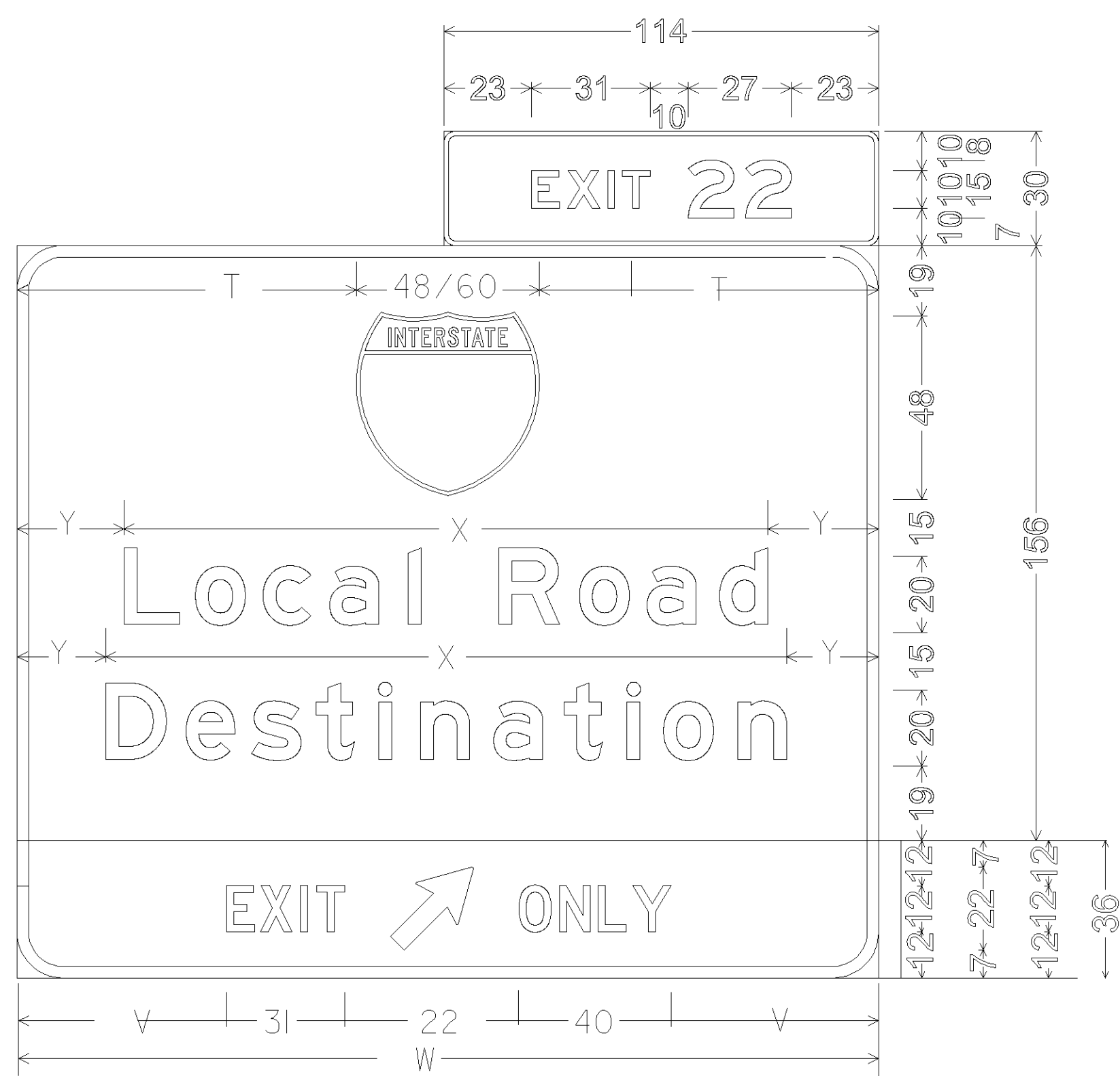

3" Radius, 1" Border, White on Green;
 "EXIT" E; "22" E;
 12" Radius, 3" Border, White on Green;
 "Destination" E; "Local Road" E; Arrow 18 - 42° 45°;
 12" Radius, 3" Border, Black on Yellow;
 "EXIT ONLY" D;

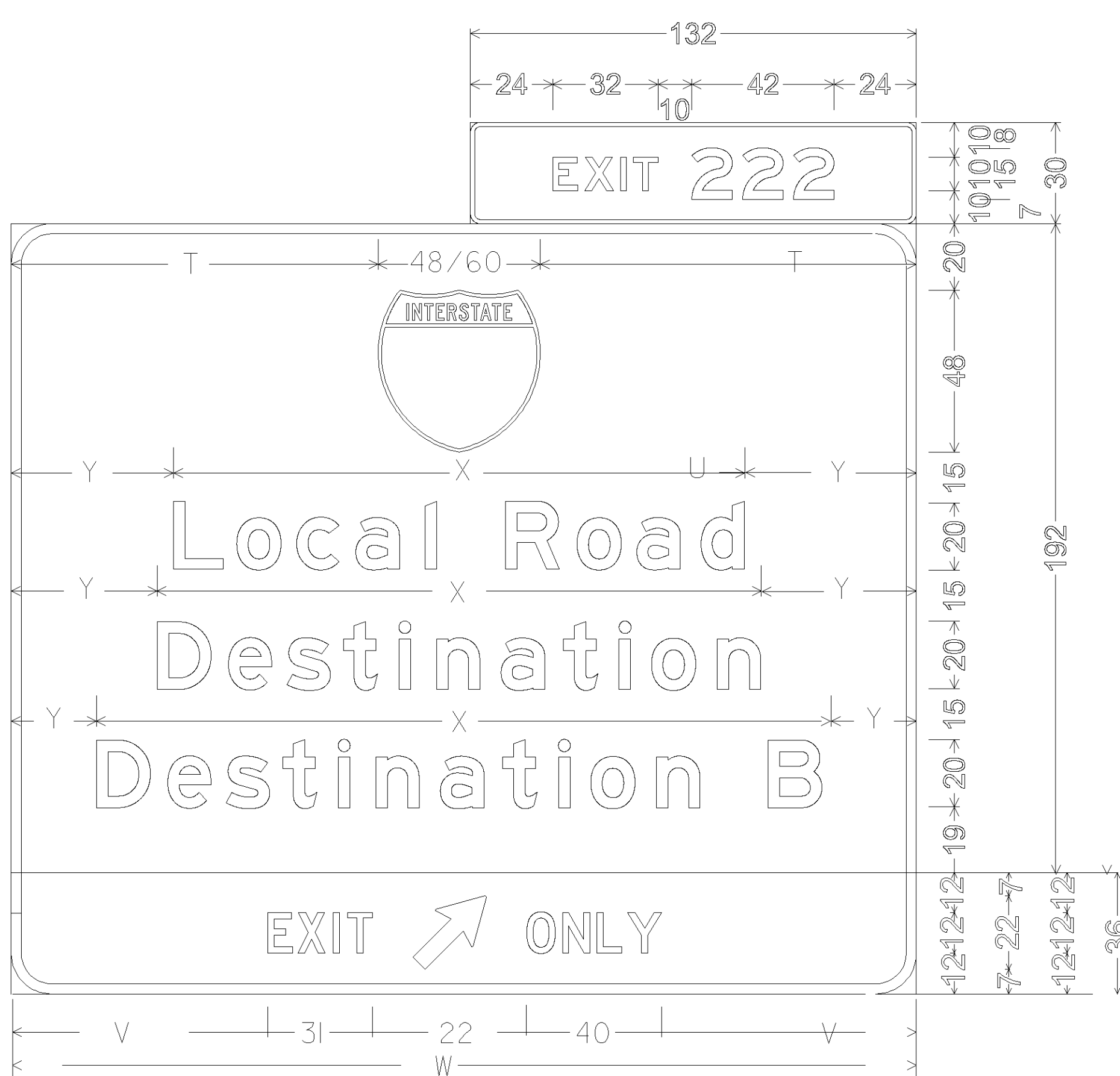

3" Radius, 1" Border, White on Green;
 "EXIT" E; "222" E;
 12" Radius, 3" Border, White on Green;
 "Destination" E; "Destination B" E; "Local Road" E;
 Arrow 18 - 42° 45°;
 12" Radius, 3" Border, Black on Yellow;
 "EXIT ONLY" D;

NOTE:
 20" SER. E NUMBERING USED IN INTERSTATE SHIELD

SEE LEGEND ON A-0 FOR VARIABLE DEFINITIONS

SIGN TEMPLATE 23

DETAILS OF EXIT DIRECTION (LANE DROP) SIGNS

- NO SCALE -

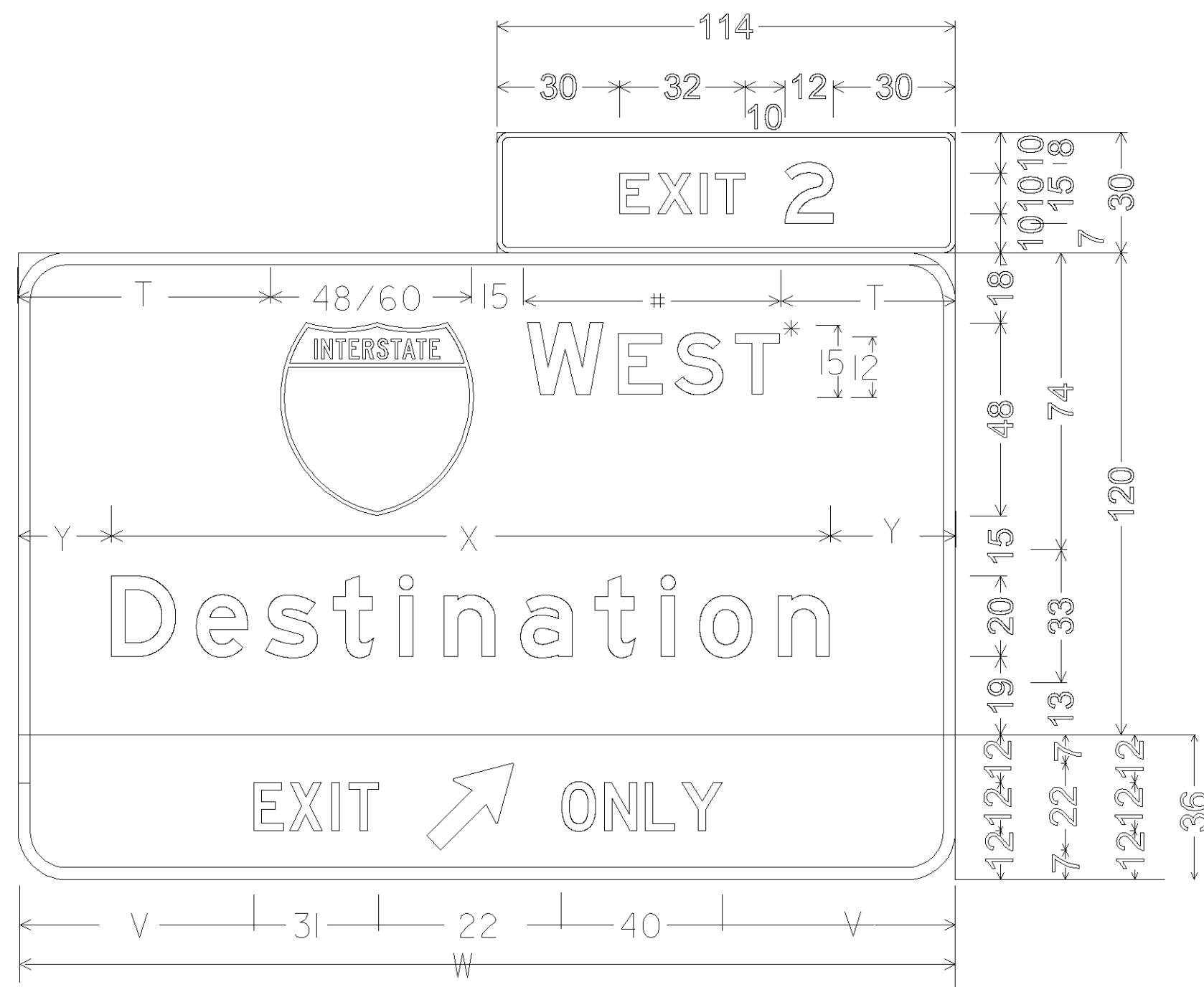

3" Radius, 1" Border, White on Green;
 "EXIT" E; "2" E; "WEST" E;
 12" Radius, 3" Border, White on Green;
 "Destination" E; Arrow 18 - 42° 45°;
 12" Radius, 3" Border, Black on Yellow;
 "EXIT ONLY" D;

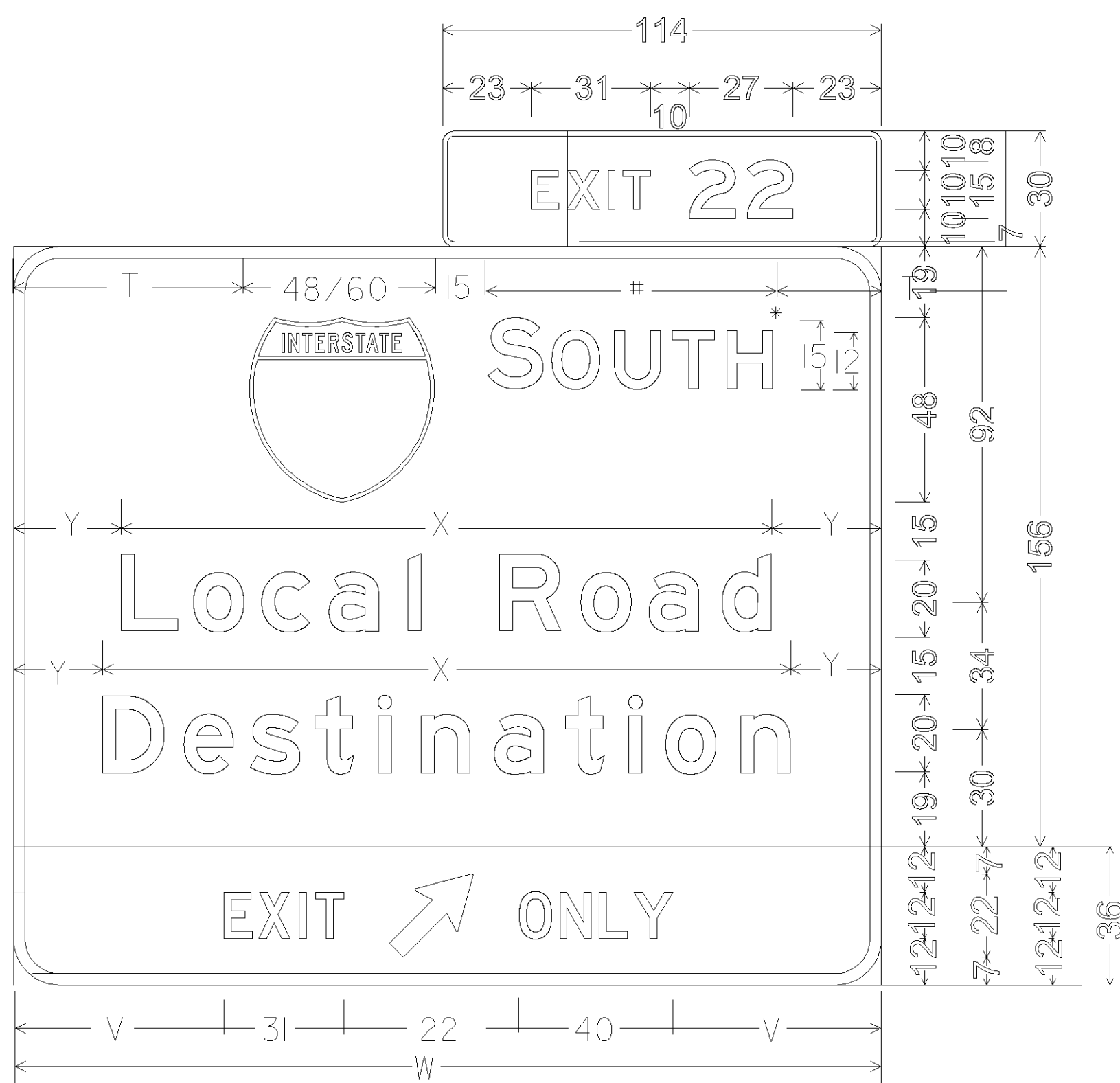

3" Radius, 1" Border, White on Green;
 "EXIT" E; "22" E; "NORTH" E;
 12" Radius, 3" Border, White on Green;
 "Destination" E; "Local Road" E; Arrow 18 - 42° 45°;
 12" Radius, 3" Border, Black on Yellow;
 "EXIT" D; "ONLY" D;

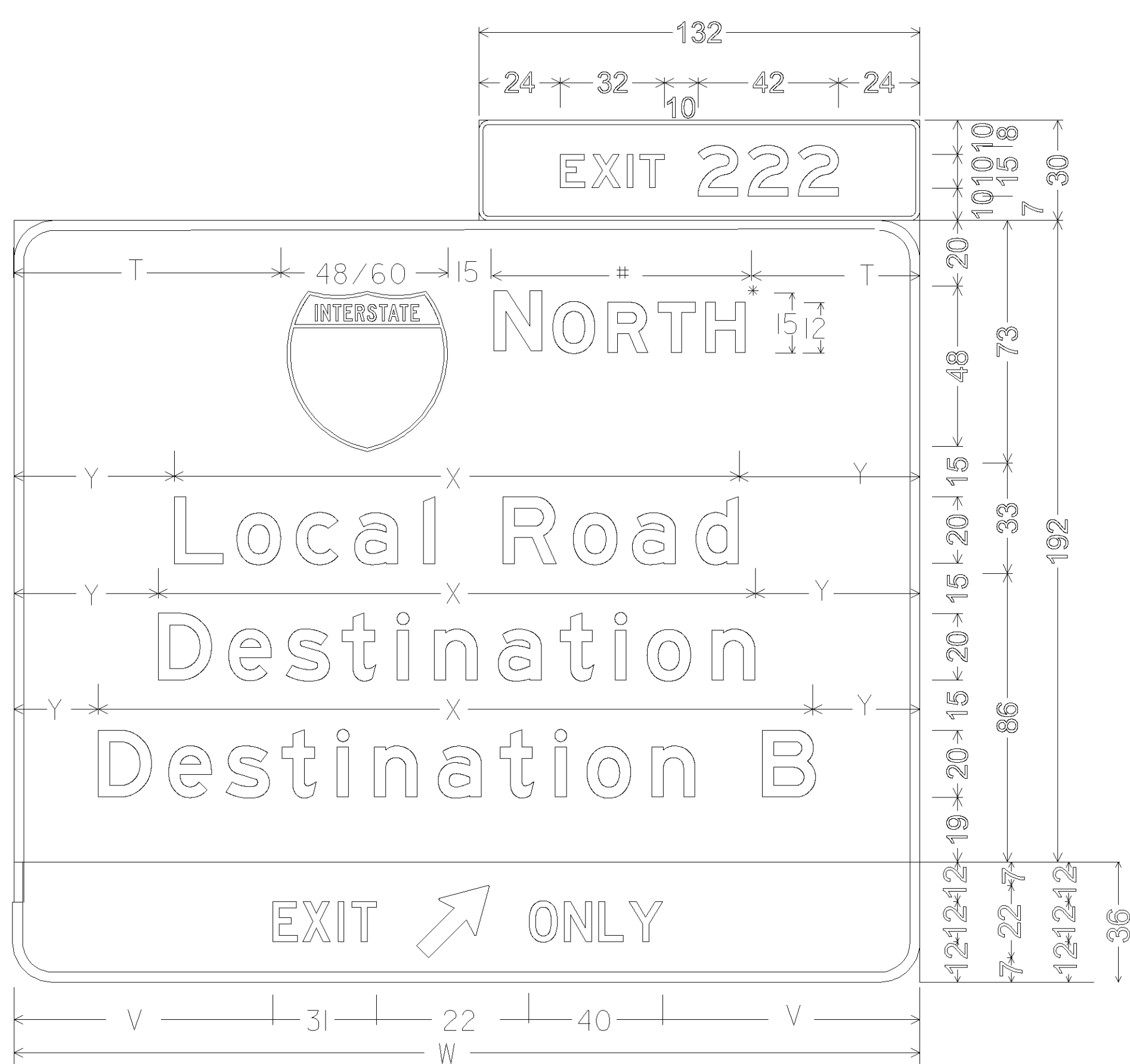

3" Radius, 1" Border, White on Green;
 "EXIT" E; "222" E; "SOUTH" E;
 12" Radius, 3" Border, White on Green;
 "Destination" E; "Destination B" E; "Local Road" E;
 Arrow 18 - 42° 45°;
 12" Radius, 3" Border, Black on Yellow;
 "EXIT" D; "ONLY" D;

NOTE:
 20" SER. E NUMBERING USED IN INTERSTATE SHIELD

SEE LEGEND ON A-0 FOR VARIABLE DEFINITIONS

SIGN TEMPLATE 24

DETAILS OF EXIT DIRECTION (LANE DROP) SIGNS

- NO SCALE -

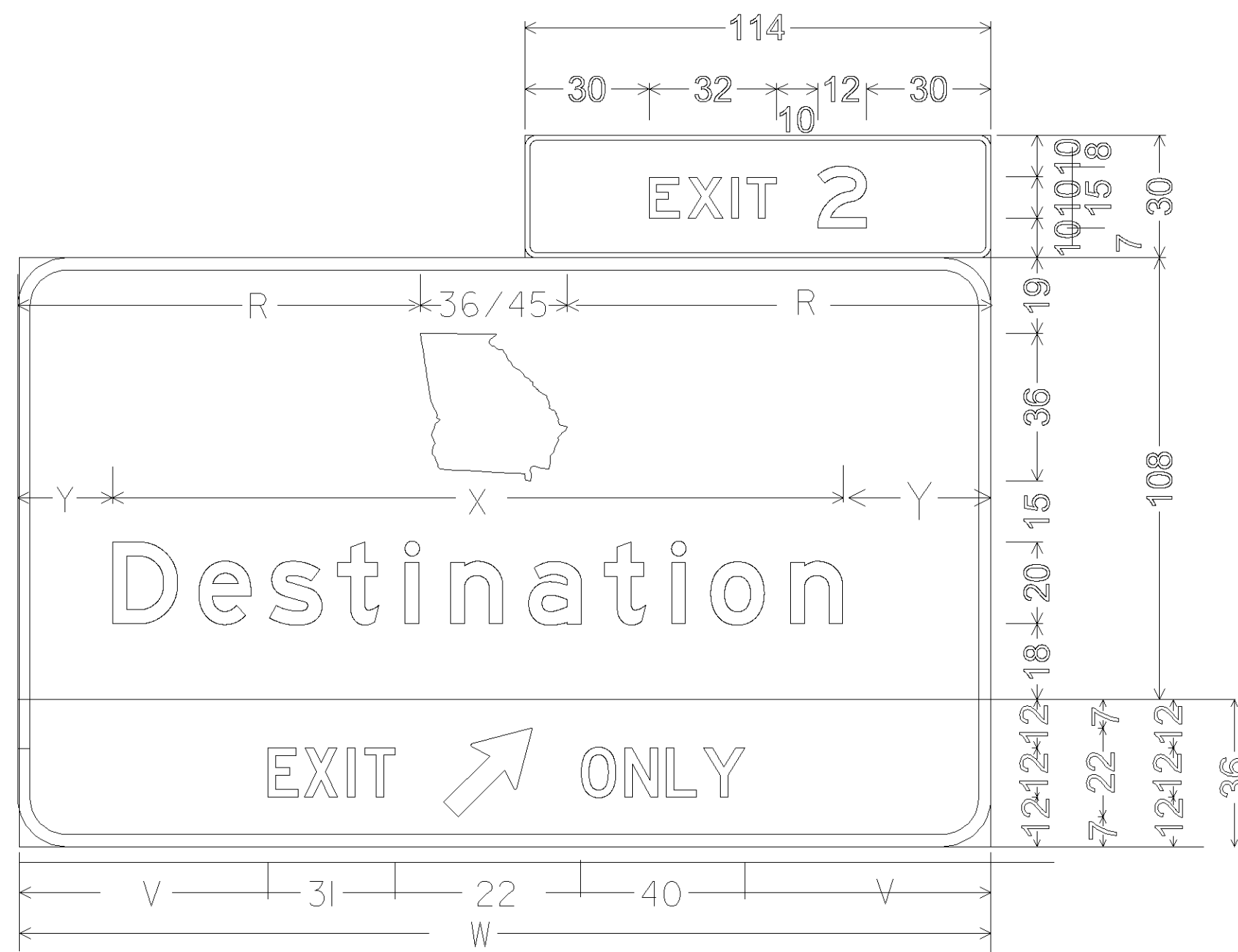

3" Radius, 1" Border, White on Green;
 "EXIT" E; "2" E;
 12" Radius, 3" Border, White on Green;
 "Destination" E; Arrow 18 - 42° 45°;
 12" Radius, 3" Border, Black on Yellow;
 "EXIT ONLY" D;

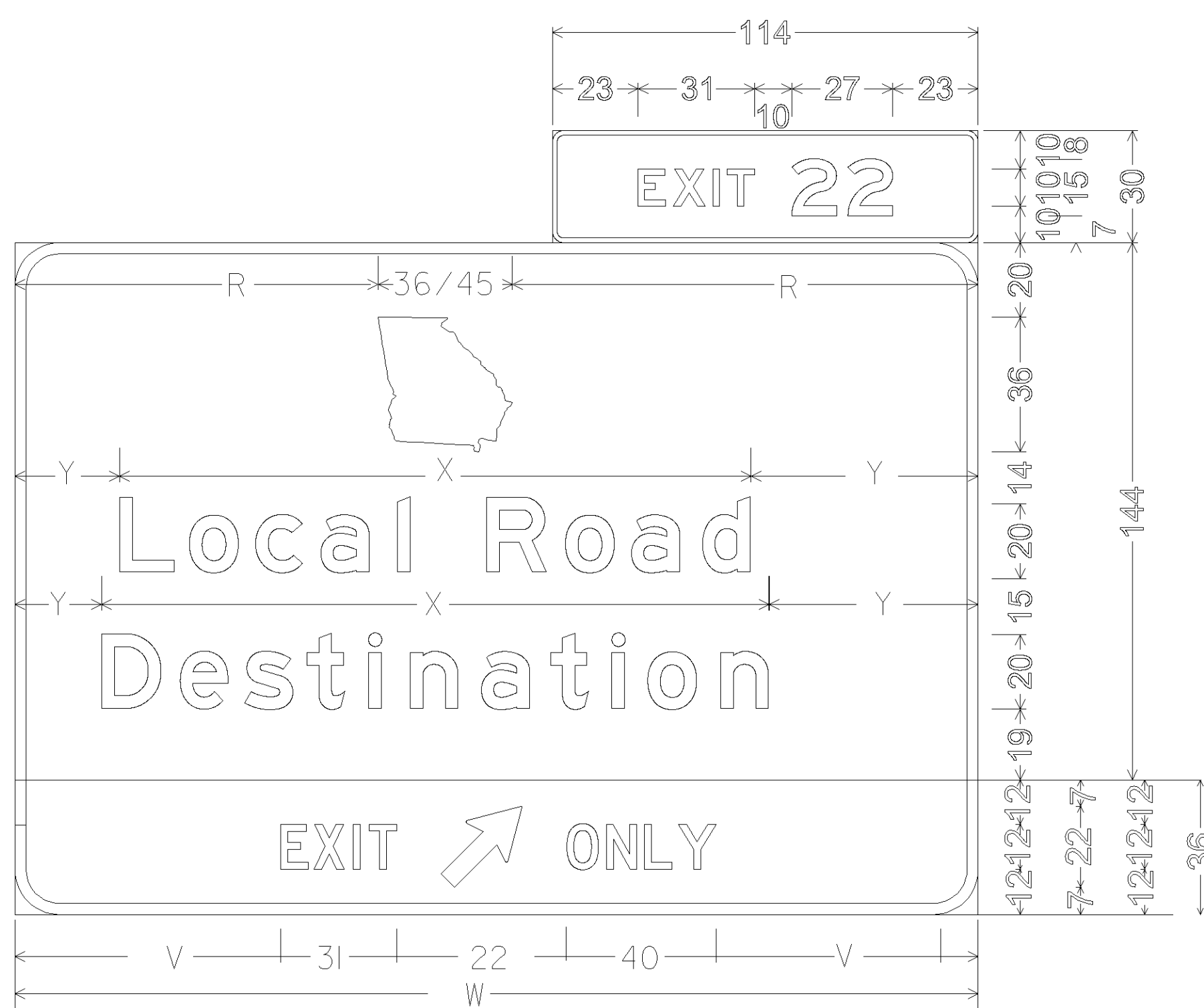

3" Radius, 1" Border, White on Green;
 "EXIT" E; "22" E;
 12" Radius, 3" Border, White on Green;
 "Destination" E; "Local Road" E; Arrow 18 - 42° 45°;
 12" Radius, 3" Border, Black on Yellow;
 "EXIT" D; "ONLY" D;

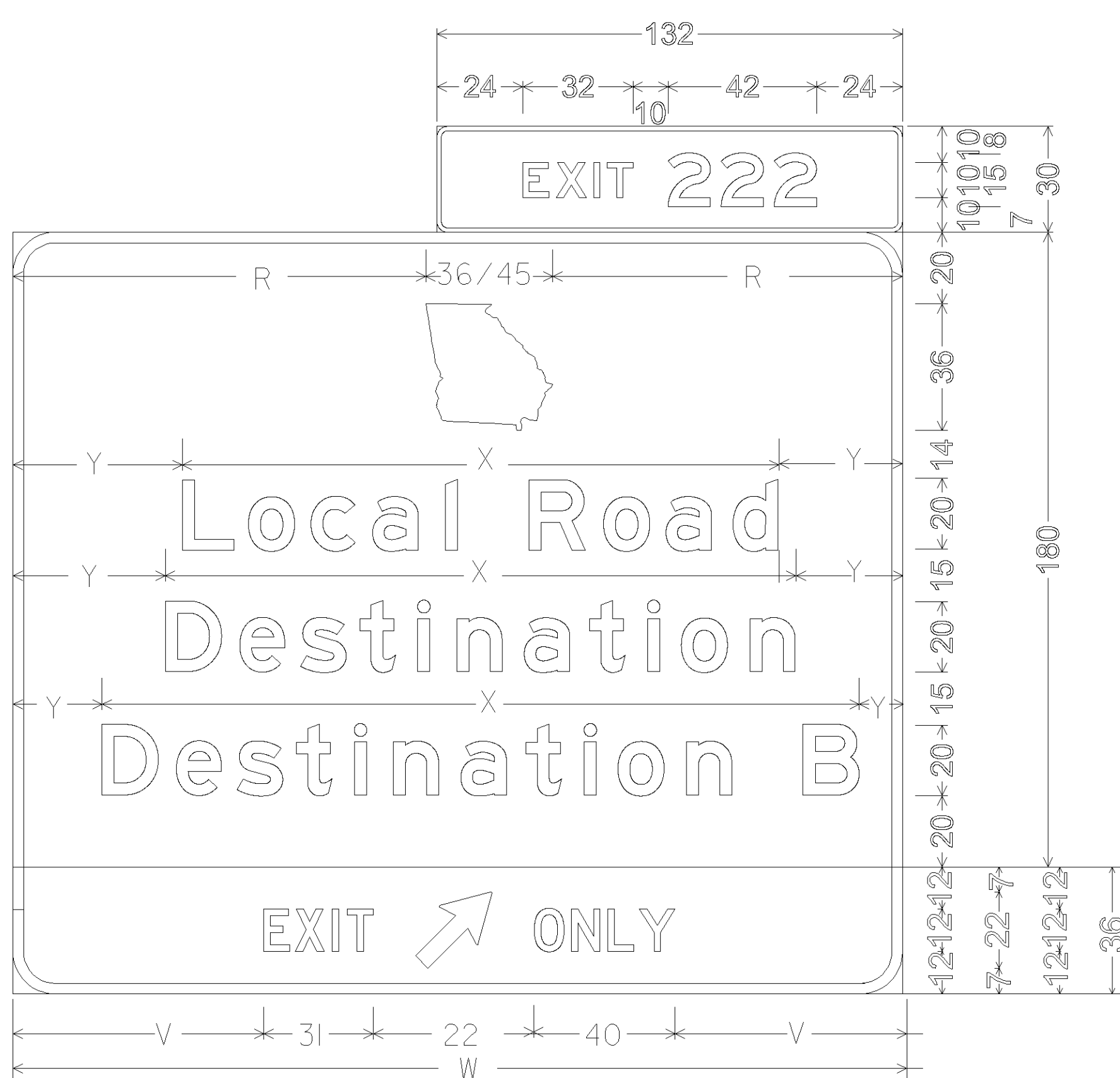

3" Radius, 1" Border, White on Green;
 "EXIT" E; "222" E;
 12" Radius, 3" Border, White on Green;
 "Destination" E; "Destination B" E; "Local Road" E;
 Arrow 18 - 42° 45°;
 12" Radius, 3" Border, Black on Yellow;
 "EXIT" D; "ONLY" D;

NOTE:
 15" & 12" SER. E NUMBERING USED IN GEORGIA SHIELD
 SEE LEGEND ON A-0 FOR VARIABLE DEFINITIONS

SIGN TEMPLATE 25

DETAILS OF EXIT DIRECTION (LANE DROP) SIGNS

- NO SCALE -

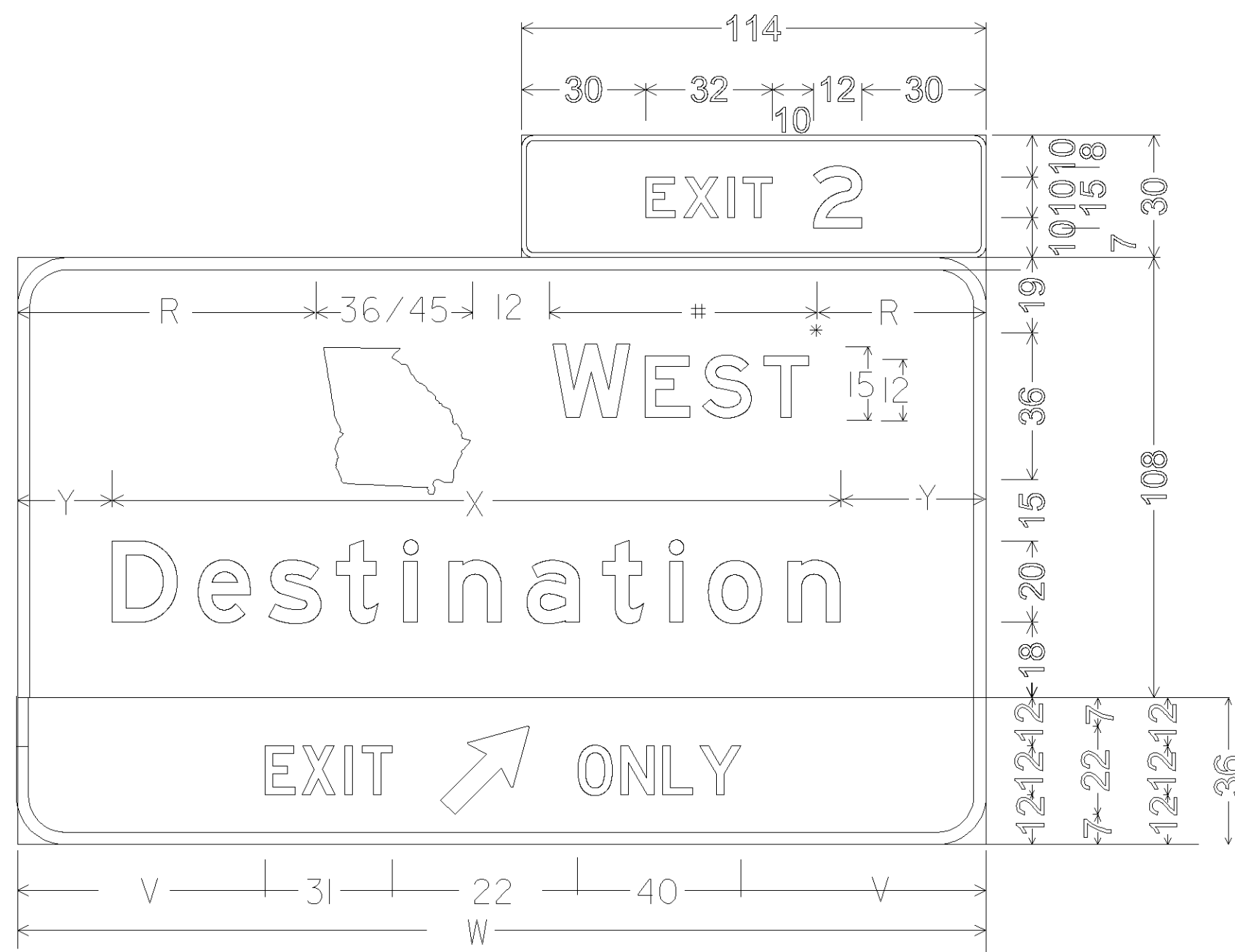

3" Radius, 1" Border, White on Green;
 "EXIT" E; "2" E; "WEST" E;
 12" Radius, 3" Border, White on Green;
 "Destination" E; Arrow 18 - 42" 45°;
 12" Radius, 3" Border, Black on Yellow;
 "EXIT ONLY" D;

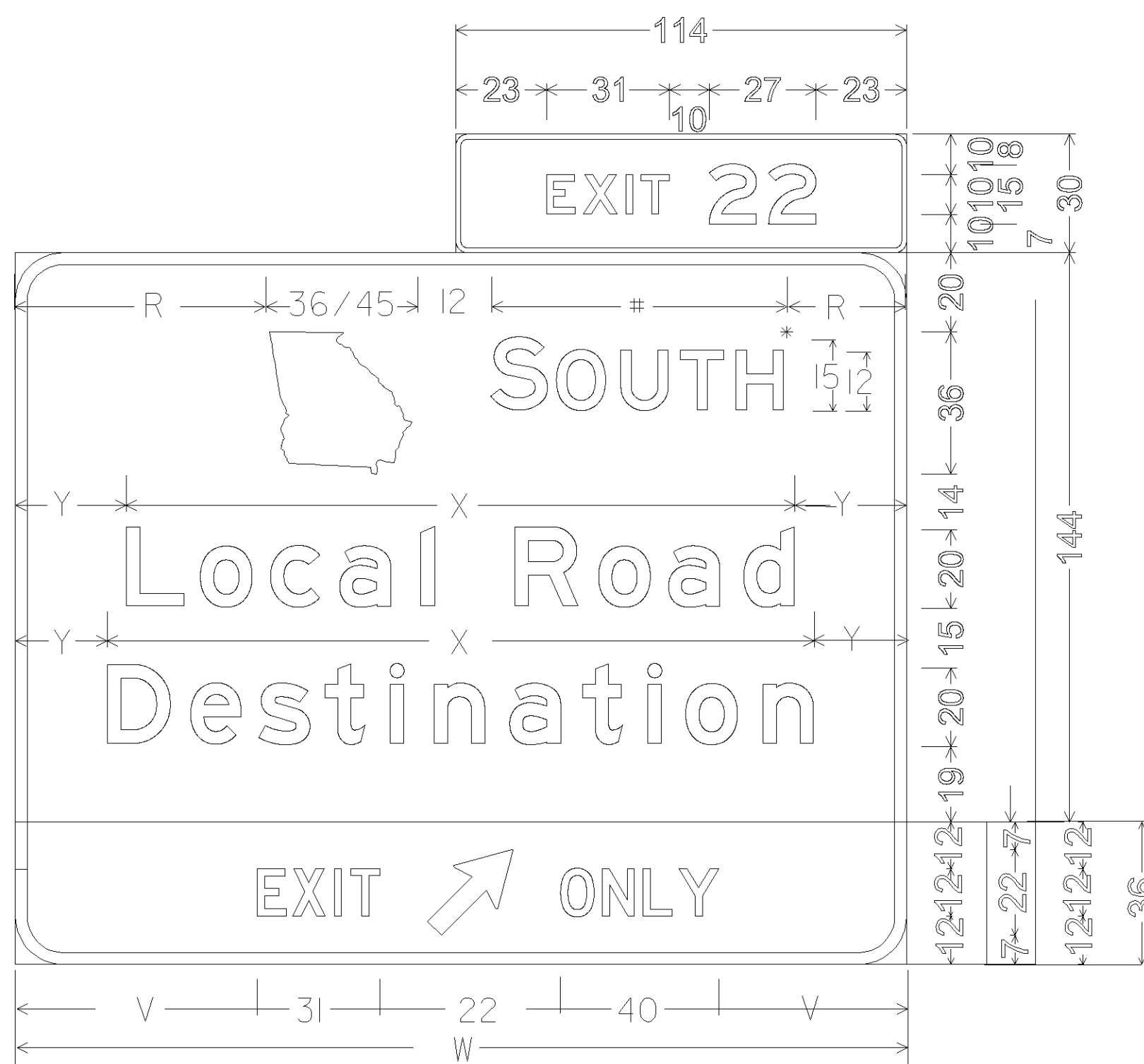

3" Radius, 1" Border, White on Green;
 "EXIT" E; "22" E; "SOUTH" E;
 12" Radius, 3" Border, White on Green;
 "Destination" E; "Local Road" E; Arrow 18 - 42" 45°;
 12" Radius, 3" Border, Black on Yellow;
 "EXIT" D; "ONLY" D;

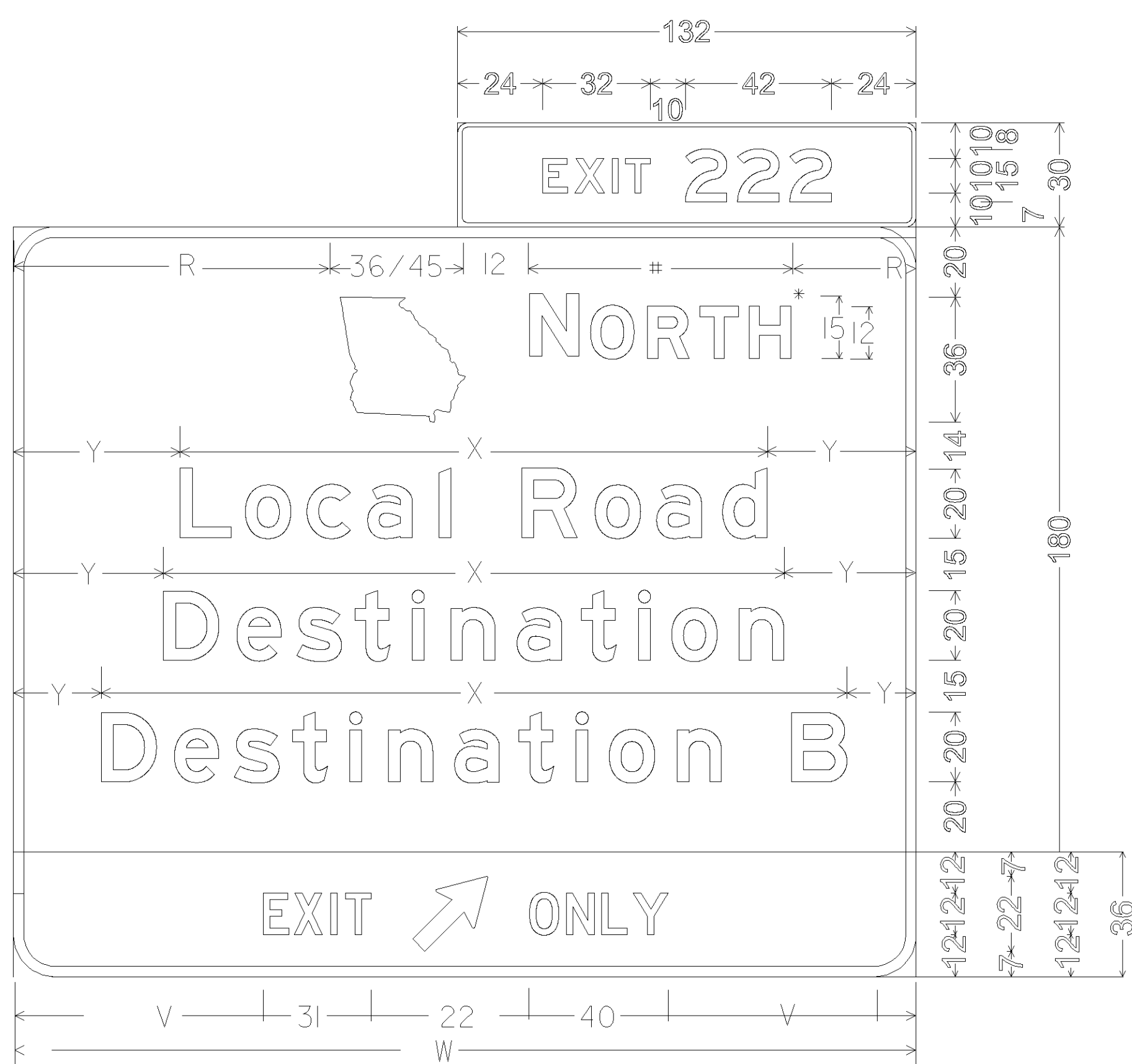

3" Radius, 1" Border, White on Green;
 "EXIT" E; "222" E; "SOUTH" E;
 12" Radius, 3" Border, White on Green;
 "Destination" E; "Destination B" E; "Local Road" E;
 Arrow 18 - 42" 45°;
 12" Radius, 3" Border, Black on Yellow;
 "EXIT" D; "ONLY" D;

NOTE:
 15" & 12" SER. E NUMBERING USED IN GEORGIA SHIELD

SEE LEGEND ON A-0 FOR VARIABLE DEFINITIONS

SIGN TEMPLATE 36

DETAILS OF ADVANCE LANE DROP SIGNS

- NO SCALE -

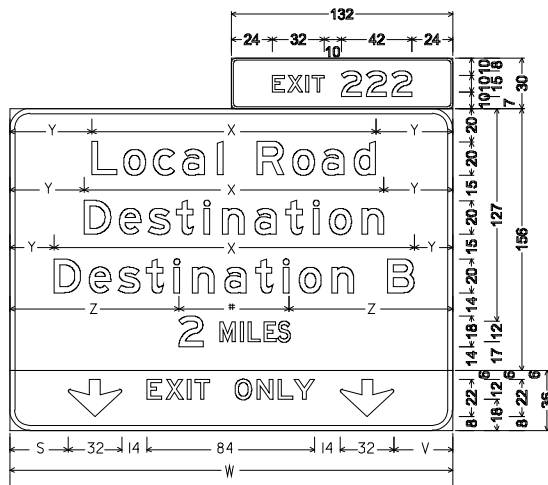
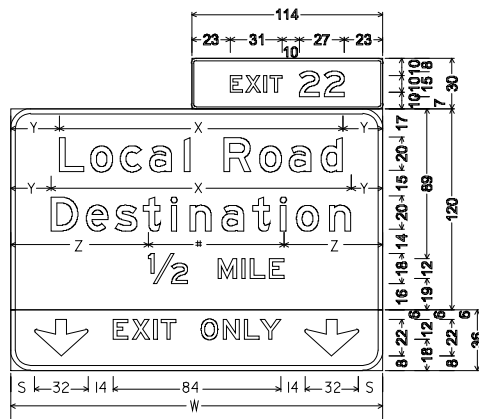
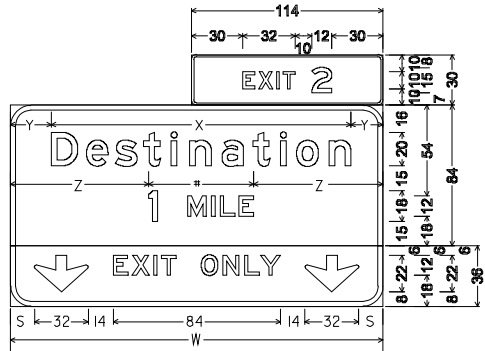

SEE LEGEND ON A-0 FOR VARIABLE DEFINITIONS

SIGN TEMPLATE 37

DETAILS OF ADVANCE LANE DROP SIGNS

- NO SCALE -

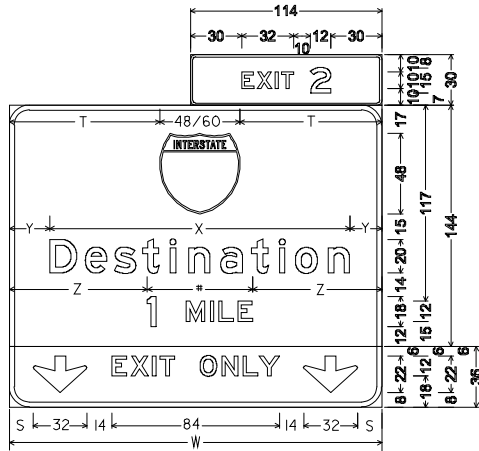

3" Radius, 1" Border, White on Green;
 "EXIT" E Mod. ; "2" E Mod. ;
 12" Radius, 3" Border, White on Green;
 "Destination" E Mod. ; "1 MILE" E Mod. ;
 12" Radius, 3" Border, Black on Yellow;
 Down Arrow 22" 270"; "EXIT" D; "ONLY" D;
 Down Arrow 22" 270";

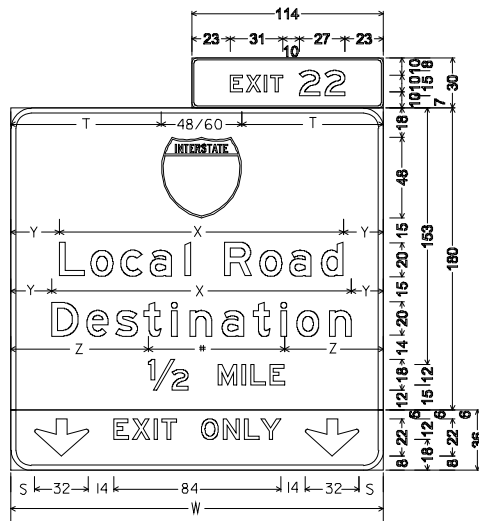

3" Radius, 1" Border, White on Green;
 "EXIT" E Mod. ; "22" E Mod. ;
 12" Radius, 3" Border, White on Green;
 "Destination" E Mod. ; "Local Road" E Mod. ; " 1/2 MILE" E Mod. ;
 12" Radius, 3" Border, Black on Yellow;
 Down Arrow 22" 270"; "EXIT" D; "ONLY" D;
 Down Arrow 22" 270";

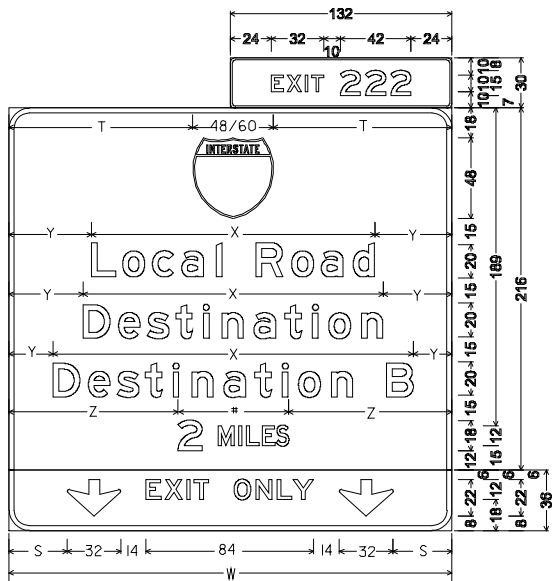

3" Radius, 1" Border, White on Green;
 "EXIT" E Mod. ; "222" E Mod. ;
 12" Radius, 3" Border, White on Green;
 "Destination" E Mod. ; "Destination B" E Mod. ; "Local Road" E Mod. ;
 "2 MILE" E Mod. ;
 12" Radius, 3" Border, Black on Yellow;
 Down Arrow 22" 270"; "EXIT" D; "ONLY" D;
 Down Arrow 22" 270";

NOTE:
 20" SER. E NUMBERING USED IN INTERSTATE SHIELD

SEE LEGEND ON A-O FOR VARIABLE DEFINITIONS

SIGN TEMPLATE 38

DETAILS OF ADVANCE LANE DROP SIGNS

- NO SCALE -

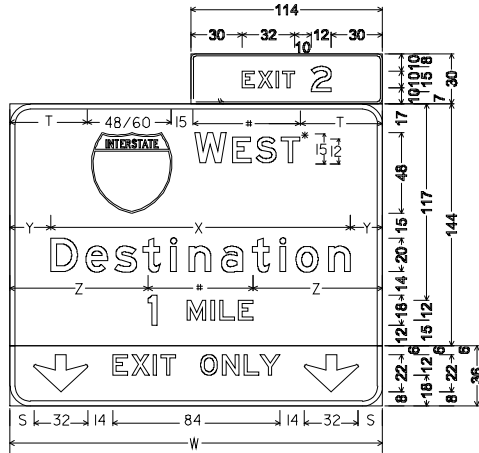

3" Radius, 1" Border, White on Green;
 "EXIT" E; "2" E Mod. ; "WEST" E Mod. ;
 12" Radius, 3" Border, White on Green;
 "Destination" E Mod. ; "1 MILE" E Mod. ;
 12" Radius, 3" Border, Black on Yellow;
 Down Arrow 22° 270°; "EXIT" D; "ONLY" D;
 Down Arrow 22° 270°;

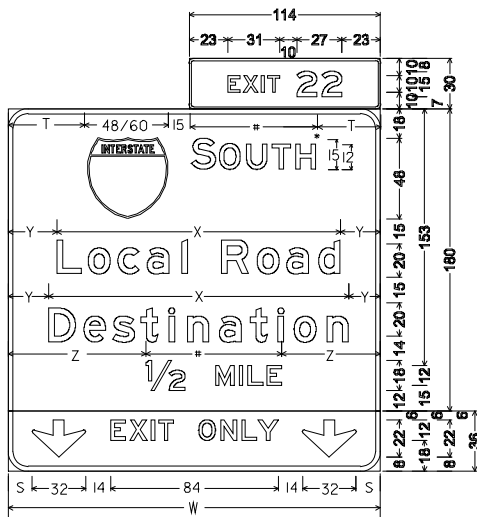

3" Radius, 1" Border, White on Green;
 "EXIT" E Mod. ; "22" E Mod. ; "NORTH" E Mod. ;
 12" Radius, 3" Border, White on Green;
 "Destination" E Mod. ; "Local Road" E Mod. ; "1/2 MILE" E Mod. ;
 12" Radius, 3" Border, Black on Yellow;
 Down Arrow 22° 270°; "EXIT" D; "ONLY" D;
 Down Arrow 22° 270°;

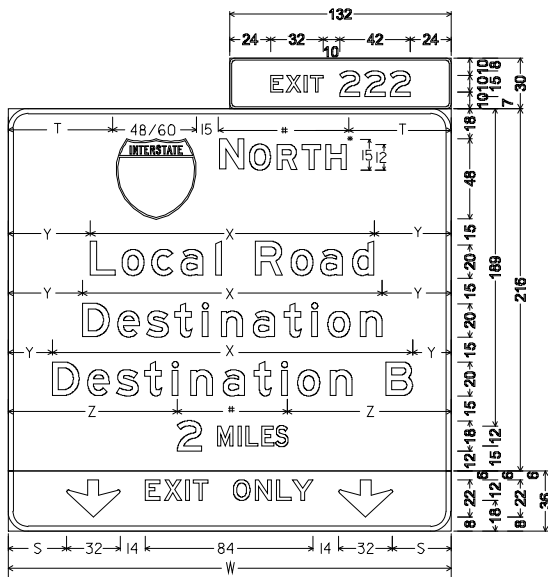

3" Radius, 1" Border, White on Green;
 "EXIT" E; "222" E; "SOUTH" E Mod. ;
 12" Radius, 3" Border, White on Green;
 "Destination" E Mod. ; "Destination B" E Mod. ; "Local Road" E Mod. ;
 "2 MILE" E Mod. ;
 12" Radius, 3" Border, Black on Yellow;
 Down Arrow 22° 270°; "EXIT" D; "ONLY" D;
 Down Arrow 22° 270°;

SCOPE:
 20" SER. E NUMBERING USED IN INTERSTATE SHIELD

SEE LEGEND ON A-O FOR VARIABLE DEFINITIONS

SIGN TEMPLATE 39

DETAILS OF ADVANCE LANE DROP SIGNS

- NO SCALE -

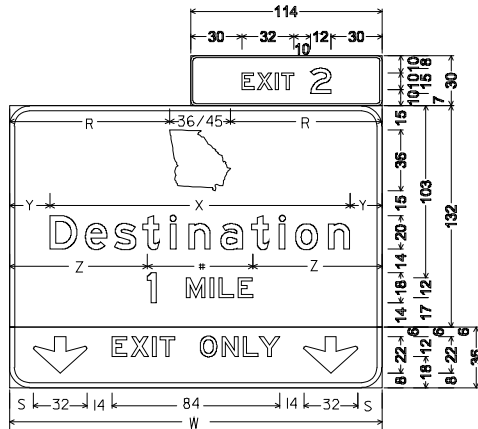

3" Radius, 1" Border, White on Green;
 "EXIT" E Mod.; "2" E Mod.;
 12" Radius, 3" Border, White on Green;
 "Destination" E Mod.; "1 MILE" E Mod.;
 12" Radius, 3" Border, Black on Yellow;
 Down Arrow 22" 270"; "EXIT" D; "ONLY" D;
 Down Arrow 22" 270";

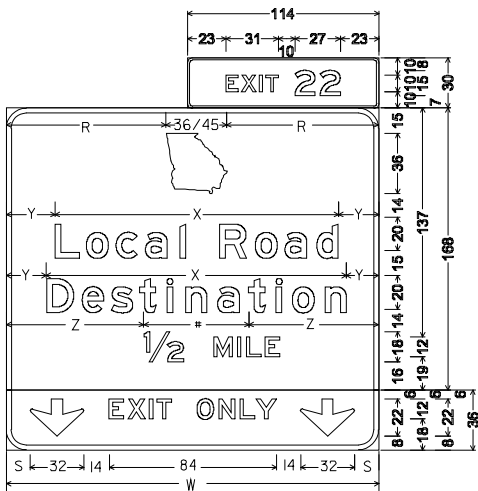

3" Radius, 1" Border, White on Green;
 "EXIT" E Mod.; "22" E Mod.;
 12" Radius, 3" Border, White on Green;
 "Destination" E Mod.; "Local Road" E Mod.; "1/2 MILE" E Mod.;
 12" Radius, 3" Border, Black on Yellow;
 Down Arrow 22" 270"; "EXIT" D; "ONLY" D;
 Down Arrow 22" 270";

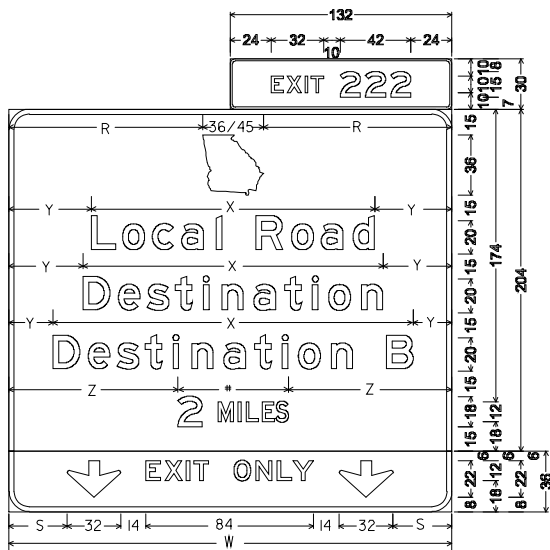

3" Radius, 1" Border, White on Green;
 "EXIT" E Mod.; "222" E Mod.;
 12" Radius, 3" Border, White on Green;
 "Destination" E Mod.; "Destination B" E Mod.; "Local Road" E Mod.;
 "2 MILE" E Mod.;
 12" Radius, 3" Border, Black on Yellow;
 Down Arrow 22" 270"; "EXIT" D; "ONLY" D;
 Down Arrow 22" 270";

NOTE:

15" & 12" SER. E NUMBERING USED IN GEORGIA SHIELD

SEE LEGEND ON A-O FOR VARIABLE DEFINITIONS

SIGN TEMPLATE 40

DETAILS OF ADVANCE LANE DROP SIGNS

- NO SCALE -

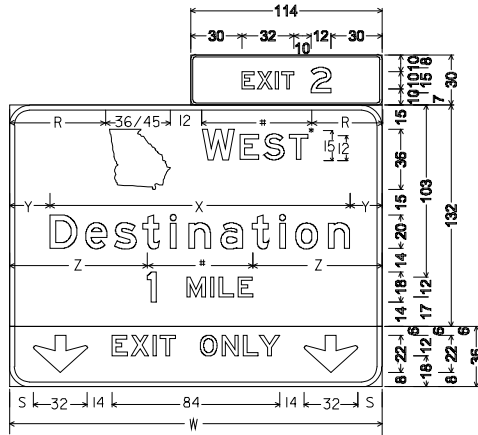

3" Radius, 1" Border, White on Green;
 "EXIT" E Mod. ; "2" E ; "WEST" E Mod. ;
 12" Radius, 3" Border, White on Green;
 "Destination" E Mod. ; "1 MILE" E Mod. ;
 12" Radius, 3" Border, Black on Yellow;
 Down Arrow 22" 270"; "EXIT" D; "ONLY" D;
 Down Arrow 22" 270";

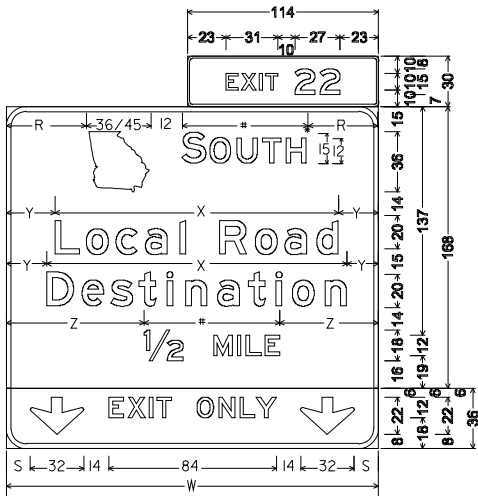

3" Radius, 1" Border, White on Green;
 "EXIT" E Mod. ; "22" E Mod. ; "NORTH" E Mod. ;
 12" Radius, 3" Border, White on Green;
 "Destination" E Mod. ; "Local Road" E Mod. ; " 1/2 MILE" E Mod. ;
 12" Radius, 3" Border, Black on Yellow;
 Down Arrow 22" 270"; "EXIT" D; "ONLY" D;
 Down Arrow 22" 270";

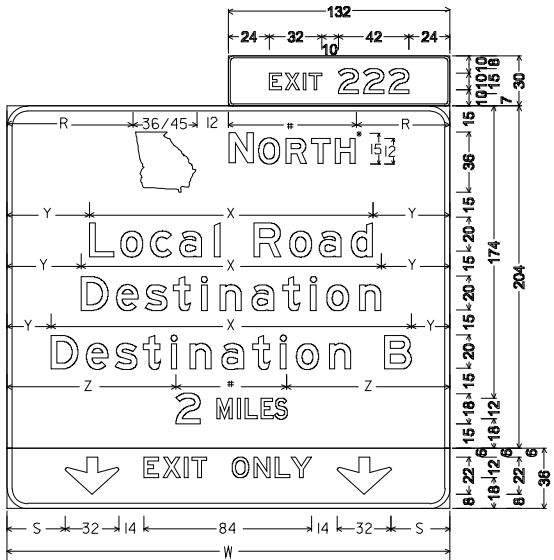

3" Radius, 1" Border, White on Green;
 "EXIT" E Mod. ; "222" E Mod. ; "SOUTH" E Mod. ;
 12" Radius, 3" Border, White on Green;
 "Destination" E Mod. ; "Destination B" E Mod. ; "Local Road" E Mod. ;
 "2 MILE" E Mod. ;
 12" Radius, 3" Border, Black on Yellow;
 Down Arrow 22" 270"; "EXIT" D; "ONLY" D;
 Down Arrow 22" 270";

NOTE:
 15" & 12" SER. E NUMBERING USED IN GEORGIA SHIELD

SEE LEGEND ON A-O FOR VARIABLE DEFINITIONS

SIGN TEMPLATE 4I DETAILS OF INTERMEDIATE LANE DROP SIGNS

- NO SCALE -

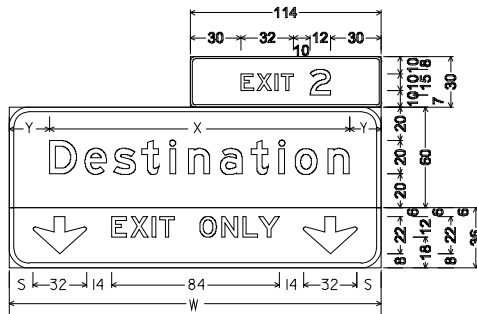

3" Radius, 1" Border, White on Green;
 "EXIT" E Mod. ; "2" E Mod. ;
 12" Radius, 3" Border, White on Green;
 "Destination" E Mod. ;
 12" Radius, 3" Border, Black on Yellow;
 Down Arrow 22" 270"; "EXIT" D; "ONLY" D;
 Down Arrow 22" 270";

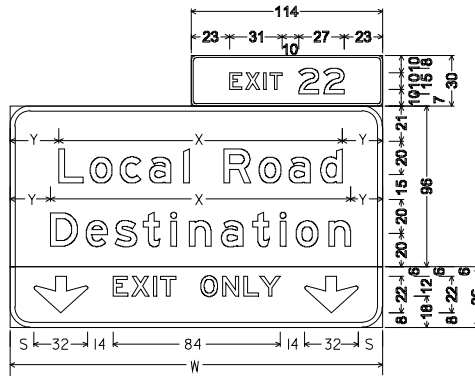

3" Radius, 1" Border, White on Green;
 "EXIT" E Mod. ; "22" E Mod. ;
 12" Radius, 3" Border, White on Green;
 "Destination" E Mod. ; "Local Road" E Mod. ;
 12" Radius, 3" Border, Black on Yellow;
 Down Arrow 22" 270"; "EXIT" D; "ONLY" D;
 Down Arrow 22" 270";

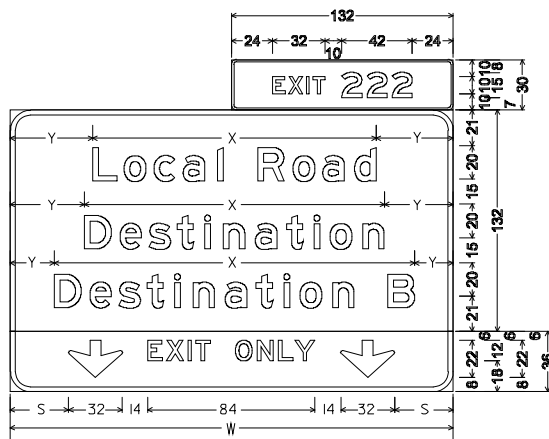

3" Radius, 1" Border, White on Green;
 "EXIT" E Mod. ; "222" E Mod. ;
 12" Radius, 3" Border, White on Green;
 "Destination" E Mod. ; "Destination B" E Mod. ; "Local Road" E Mod. ;
 12" Radius, 3" Border, Black on Yellow;
 Down Arrow 22" 270"; "EXIT" D; "ONLY" D;
 Down Arrow 22" 270";

SEE LEGEND ON A-0 FOR VARIABLE DEFINITIONS

SIGN TEMPLATE 42

DETAILS OF INTERMEDIATE LANE DROP SIGNS

- NO SCALE -

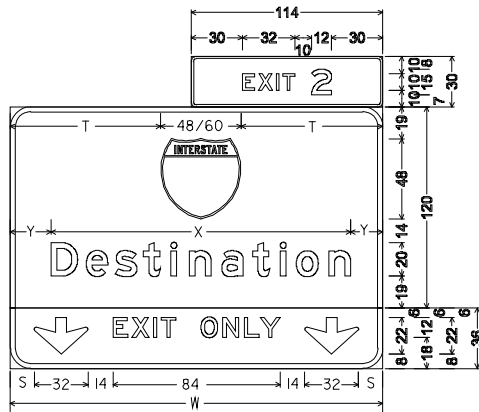

3" Radius, 1" Border, White on Green;
 "EXIT" E Mod. ; "2" E Mod. ;
 12" Radius, 3" Border, White on Green;
 "Destination" E Mod. ;
 12" Radius, 3" Border, Black on Yellow;
 Down Arrow 22" 270"; "EXIT" D; "ONLY" D;
 Down Arrow 22" 270";

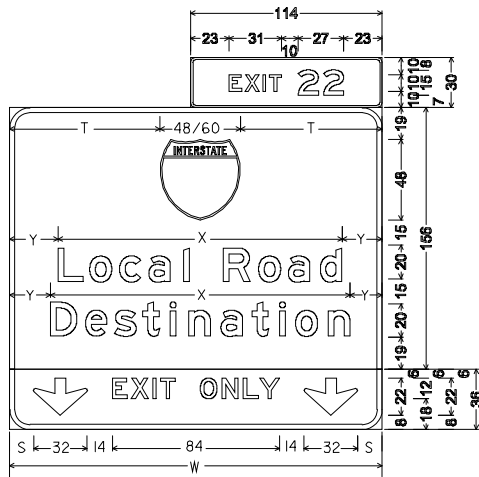

3" Radius, 1" Border, White on Green;
 "EXIT" E Mod. ; "22" E Mod.;
 12" Radius, 3" Border, White on Green;
 "Destination" E Mod. ; "Local Road" E Mod. ;
 12" Radius, 3" Border, Black on Yellow;
 Down Arrow 22" 270"; "EXIT" D; "ONLY" D;
 Down Arrow 22" 270";

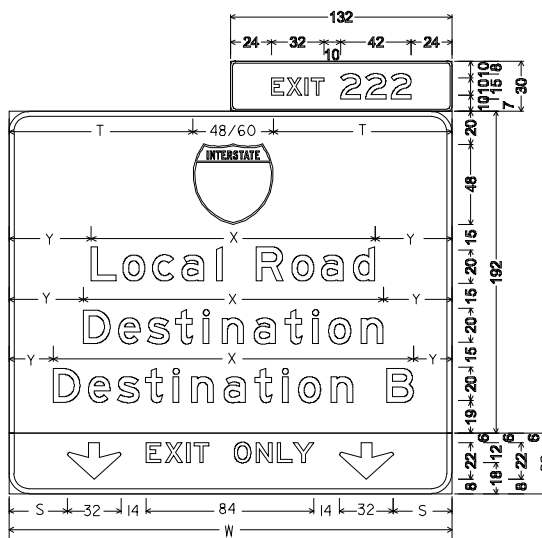

3" Radius, 1" Border, White on Green;
 "EXIT" E Mod; "222" E Mod. ;
 12" Radius, 3" Border, White on Green;
 "Destination" E Mod. ; "Destination B" E Mod.; "Local Road" E Mod.;
 12" Radius, 3" Border, Black on Yellow;
 Down Arrow 22" 270"; "EXIT" D; "ONLY" D;
 Down Arrow 22" 270";

NOTE:
 20" SER. E NUMBERING USED IN INTERSTATE SHIELD

SEE LEGEND ON A-O FOR VARIABLE DEFINITIONS

SIGN TEMPLATE 43

DETAILS OF INTERMEDIATE LANE DROP SIGNS

- NO SCALE -

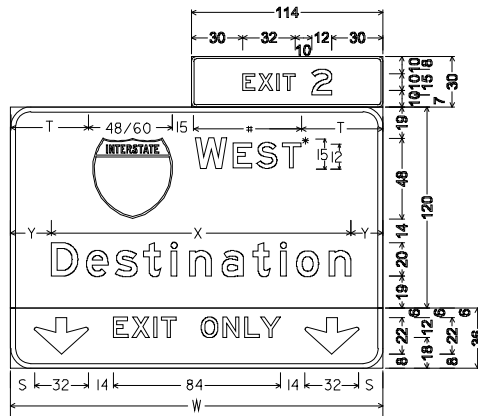

3" Radius, 1" Border, White on Green;
 "EXIT" E Mod. ; "2" E Mod. ; "WEST" E Mod. ;
 12" Radius, 3" Border, White on Green;
 "Destination" E Mod. ;
 12" Radius, 3" Border, Black on Yellow;
 Down Arrow 22" 270"; "EXIT" D; "ONLY" D;
 Down Arrow 22" 270";

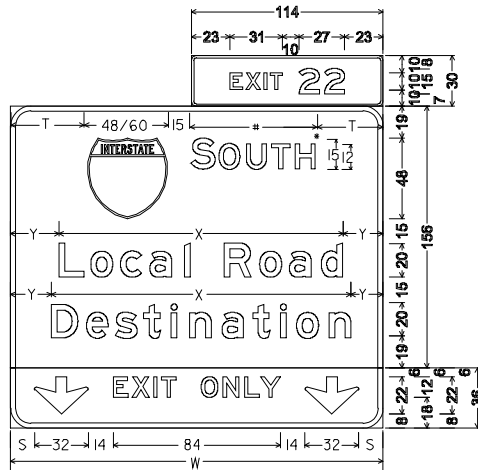

3" Radius, 1" Border, White on Green;
 "EXIT" E Mod. ; "22" E Mod. ; "NORTH" E Mod. ;
 12" Radius, 3" Border, White on Green;
 "Destination" E Mod. ; "Local Road" E Mod. ;
 12" Radius, 3" Border, Black on Yellow;
 Down Arrow 22" 270"; "EXIT" D; "ONLY" D;
 Down Arrow 22" 270";

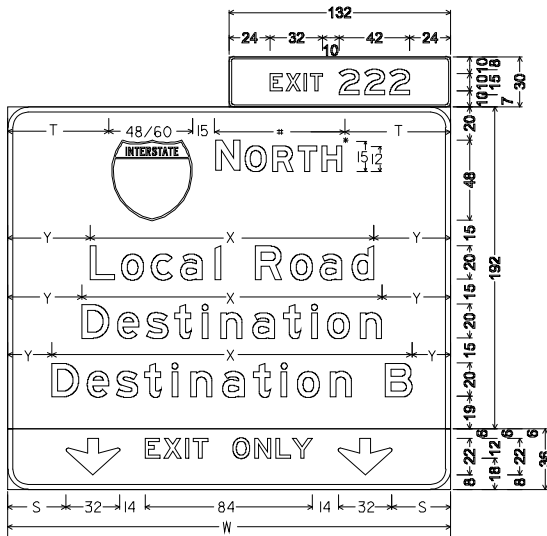

3" Radius, 1" Border, White on Green;
 "EXIT" E Mod. ; "222" E Mod. ; "SOUTH" E Mod. ;
 12" Radius, 3" Border, White on Green;
 "Destination" E Mod. ; "Destination B" E Mod. ; "Local Road" E Mod. ;
 12" Radius, 3" Border, Black on Yellow;
 Down Arrow 22" 270"; "EXIT" D; "ONLY" D;
 Down Arrow 22" 270";

NOTE:
 20" SER. E NUMBERING USED IN INTERSTATE SHIELD

SEE LEGEND ON A-0 FOR VARIABLE DEFINITIONS

SIGN TEMPLATE 44

DETAILS OF INTERMEDIATE LANE DROP SIGNS

- NO SCALE -

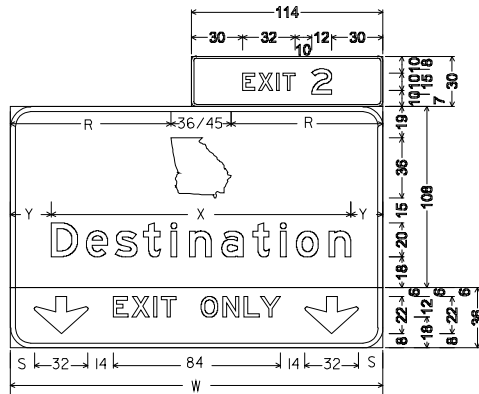

3" Radius, 1" Border, White on Green;
 "EXIT" E Mod. ; "2" E Mod. ;
 12" Radius, 3" Border, White on Green;
 "Destination" E Mod. ;
 12" Radius, 3" Border, Black on Yellow;
 Down Arrow 22° 270°; "EXIT" D; "ONLY" D;
 Down Arrow 22° 270°;

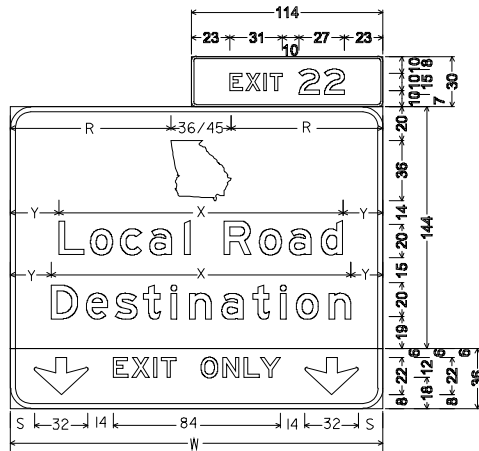

3" Radius, 1" Border, White on Green;
 "EXIT" E Mod. ; "22" E Mod. ;
 12" Radius, 3" Border, White on Green;
 "Destination" E Mod. ; "Local Road" E Mod. ;
 12" Radius, 3" Border, Black on Yellow;
 Down Arrow 22° 270°; "EXIT" D; "ONLY" D;
 Down Arrow 22° 270°;

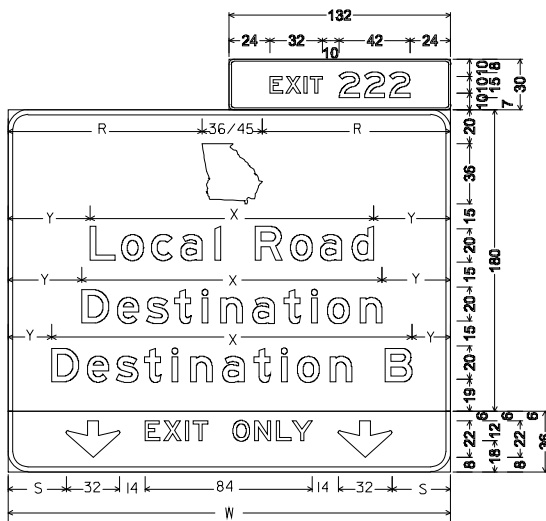

3" Radius, 1" Border, White on Green;
 "EXIT" E Mod. ; "222" E Mod. ;
 12" Radius, 3" Border, White on Green;
 "Destination" E Mod. ; "Destination B" E Mod.; "Local Road" E Mod. ;
 12" Radius, 3" Border, Black on Yellow;
 Down Arrow 22° 270°; "EXIT" D; "ONLY" D;
 Down Arrow 22° 270°;

NOTE:

15" & 12" SER. E NUMBERING USED IN GEORGIA SHIELD

SEE LEGEND ON A-0 FOR VARIABLE DEFINITIONS

SIGN TEMPLATE 45

DETAILS OF INTERMEDIATE LANE DROP SIGNS

- NO SCALE -

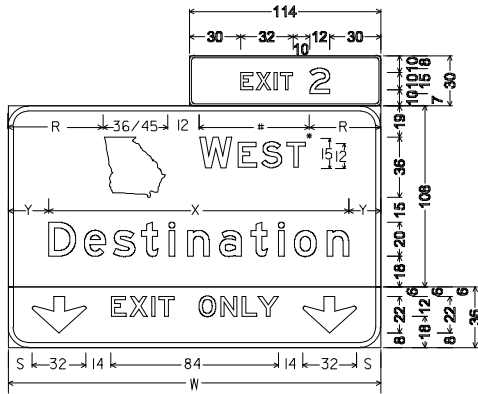

3" Radius, 1" Border, White on Green;
 "EXIT" E Mod. ; "2" E Mod. ; "WEST" E Mod. ;
 12" Radius, 3" Border, White on Green;
 "Destination" E Mod. ;
 12" Radius, 3" Border, Black on Yellow;
 Down Arrow 22" 270"; "EXIT" D; "ONLY" D;
 Down Arrow 22" 270";

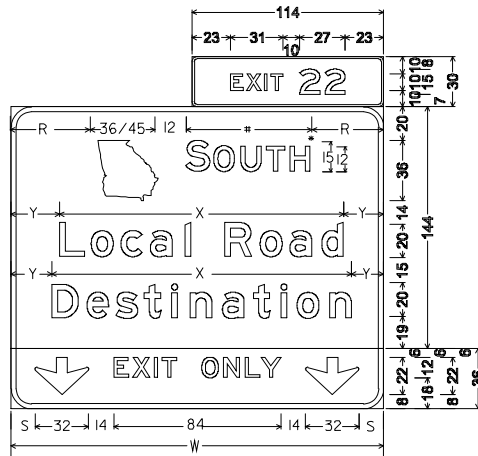

3" Radius, 1" Border, White on Green;
 "EXIT" E Mod. ; "22" E Mod. ; "SOUTH" E Mod. ;
 12" Radius, 3" Border, White on Green;
 "Destination" E Mod. ; "Local Road" E Mod. ;
 12" Radius, 3" Border, Black on Yellow;
 Down Arrow 22" 270"; "EXIT" D; "ONLY" D;
 Down Arrow 22" 270";

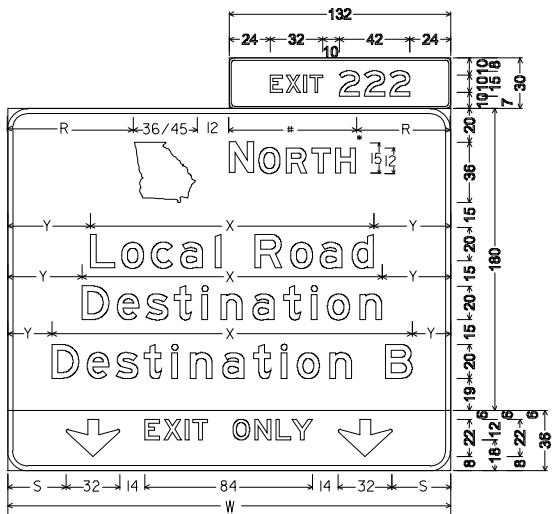

3" Radius, 1" Border, White on Green;
 "EXIT" E Mod. ; "222" E Mod. ; "NORTH" E Mod. ;
 12" Radius, 3" Border, White on Green;
 "Destination" E Mod. ; "Destination B" E Mod. ; "Local Road" E Mod. ;
 12" Radius, 3" Border, Black on Yellow;
 Down Arrow 22" 270"; "EXIT" D; "ONLY" D;
 Down Arrow 22" 270";

NOTE:

15" & 12" SER. E NUMBERING USED IN GEORGIA SHIELD

SEE LEGEND ON A-O FOR VARIABLE DEFINITIONS

SIGN TEMPLATE 46

DETAILS OF ADVANCE GUIDE SIGNS

- NO SCALE -

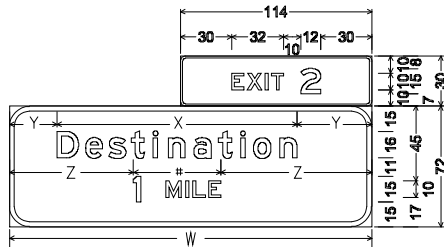

3" Radius, 1" Border, White on Green;
 "EXIT" E Mod. ; "2" E Mod. ;
 12" Radius, 3" Border, White on Green;
 "Destination" E Mod. ; "1 MILE" E Mod. ;

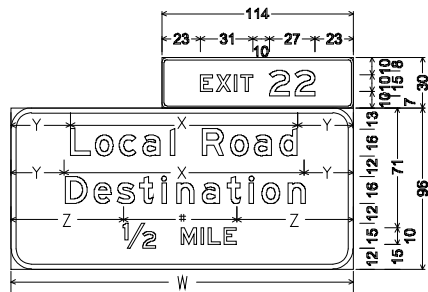

3" Radius, 1" Border, White on Green;
 "EXIT" E Mod. ; "22" E Mod. ;
 12" Radius, 3" Border, White on Green;
 "Destination" E Mod. ; "Local Road" E Mod. ; "1/2 MILE" E Mod. ;

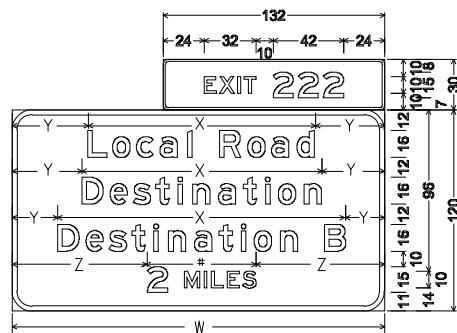

3" Radius, 1" Border, White on Green;
 "EXIT" E Mod. ; "222" E Mod. ;
 12" Radius, 3" Border, White on Green;
 "Destination" E Mod. ; "Destination B" E Mod. ;
 "Local Road" E Mod. ; "2 MILES" E Mod. ;

SEE LEGEND ON A-0 FOR VARIABLE DEFINITIONS

SIGN TEMPLATE 47 DETAILS OF ADVANCE GUIDE SIGNS

- NO SCALE -

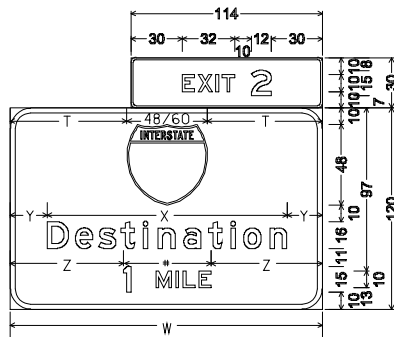

3" Radius, 1" Border, White on Green;
 "EXIT" E Mod. ; "2" E Mod. ;
 12" Radius, 3" Border, White on Green;
 "Destination" E Mod. ; "1 MILE" E Mod. ;

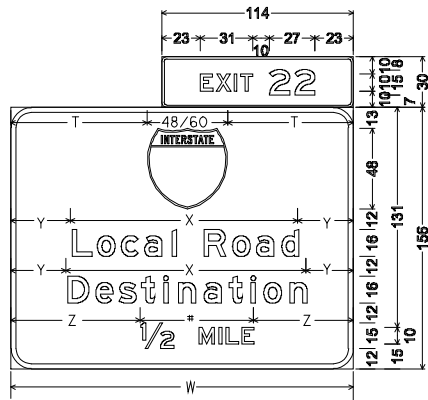

3" Radius, 1" Border, White on Green;
 "EXIT" E; "22" E;
 12" Radius, 3" Border, White on Green;
 "Destination" E; "Local Road" E; " 1/2 MILE" E;

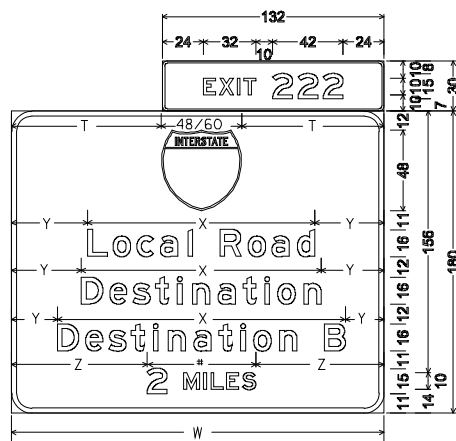

3" Radius, 1" Border, White on Green;
 "EXIT" E Mod. ; "222" E Mod. ;
 12" Radius, 3" Border, White on Green;
 "Destination" E Mod. ; "Destination B" E Mod. ;
 "Local Road" E Mod. ; "2 MILES" E Mod. ;

NOTE:

- USE THIS DETAIL ONLY FOR THE TWO-MILE GROUND MOUNTED ADVANCE SIGN FOR INTERSTATE TO INTERSTATE INTERCHANGES. 09420* SER. E NUMBERING USED IN INTERSTATE SHIELD

SEE LEGEND ON A-O FOR VARIABLE DEFINITIONS

SIGN TEMPLATE 48

DETAILS OF ADVANCE GUIDE SIGNS

- NO SCALE -

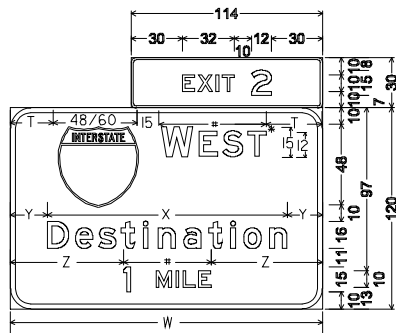

3" Radius, 1" Border, White on Green;
 "EXIT" E Mod. ; "2" E Mod.; "WEST" E Mod.;
 12" Radius, 3" Border, White on Green;
 "Destination" E Mod.; "1 MILE" E Mod.;

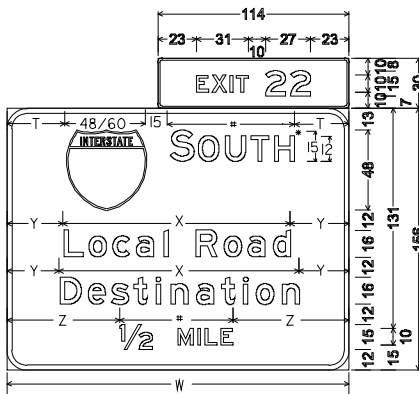

3" Radius, 1" Border, White on Green;
 "EXIT" E Mod. ; "22" E Mod. ; "NORTH" E Mod. ;
 12" Radius, 3" Border, White on Green;
 "Destination" E Mod. ; "Local Road" E Mod. ; " 1/2 MILE" E Mod. ;

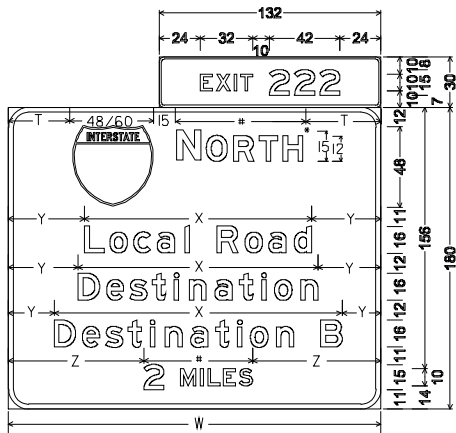

3" Radius, 1" Border, White on Green;
 "EXIT" E Mod. ; "222" E Mod. ; "SOUTH" E Mod. ;
 12" Radius, 3" Border, White on Green;
 "Destination" E Mod. ; "Destination B" E Mod. ;
 "Local Road" E Mod. ; "2 MILES" E Mod. ;

NOTE:

- USE THIS DETAIL ONLY FOR THE TWO-MILE GROUND MOUNTED ADVANCE SIGN FOR INTERSTATE TO INTERSTATE INTERCHANGES. \varnothing 7920° SER. E NUMBERING USED IN INTERSTATE SHIELD

SEE LEGEND ON A-0 FOR VARIABLE DEFINITIONS

SIGN TEMPLATE 49

DETAILS OF ADVANCE GUIDE SIGNS

- NO SCALE -

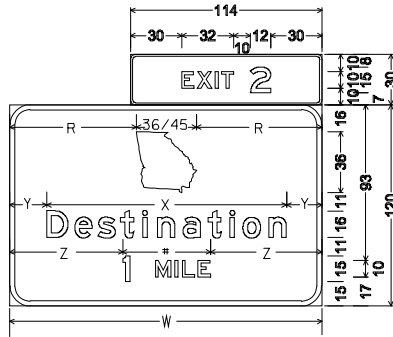

3" Radius, 1" Border, White on Green;
 "EXIT" E Mod.; "2" E Mod.;
 12" Radius, 3" Border, White on Green;
 "Destination" E Mod.; "1 MILE" E Mod.;

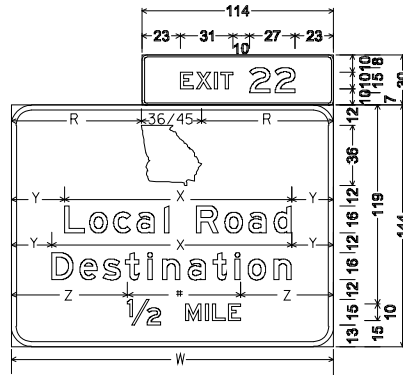

3" Radius, 1" Border, White on Green;
 "EXIT" E Mod. ; "22" E Mod.;
 12" Radius, 3" Border, White on Green;
 "Local Road" E Mod. ; "Destination" E Mod. ; "1/2 MILE" E Mod. ;

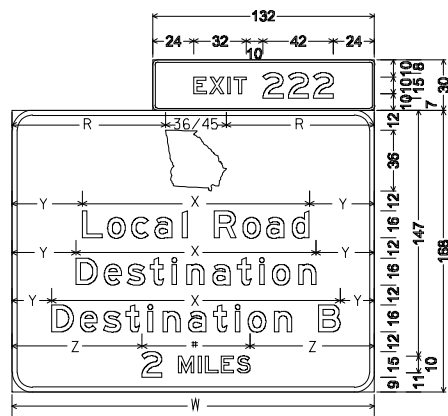

3" Radius, 1" Border, White on Green;
 "EXIT" E Mod. ; "222" E Mod. ;
 12" Radius, 3" Border, White on Green;
 "Local Road" E Mod. ; "Destination" E Mod.;
 "Destination B" E Mod. ; "2 MILES" E Mod.;

NOTE:
 15" & 12" SER. E NUMBERING USED IN GEORGIA SHIELD

SEE LEGEND ON A-O FOR VARIABLE DEFINITIONS

SIGN TEMPLATE 50

DETAILS OF ADVANCE GUIDE SIGNS

- NO SCALE -

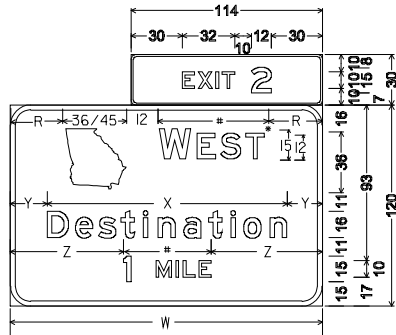

3" Radius, 1" Border, White on Green;
 "EXIT" E Mod. ; "2" E Mod. ; "WEST" E Mod.;
 12" Radius, 3" Border, White on Green;
 "Destination" E Mod. ; "1 MILE" E Mod.;

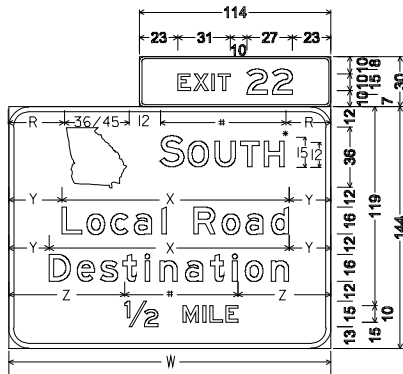

3" Radius, 1" Border, White on Green;
 "EXIT" E Mod. ; "22" E Mod. ; "NORTH" E Mod.;
 12" Radius, 3" Border, White on Green;
 "Local Road" E Mod.; "Destination" E Mod. ; " 1/2 MILE" E Mod.;

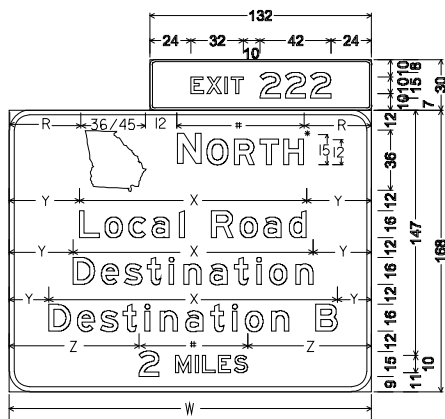

3" Radius, 1" Border, White on Green;
 "EXIT" E Mod. ; "222" E Mod. ; "SOUTH" E Mod.;
 12" Radius, 3" Border, White on Green;
 "Local Road" E Mod.; "Destination" E Mod.;
 "Destination B" E Mod. ; "2 MILES" E Mod.;

NOTE:
 15" & 12" SER. E NUMBERING USED IN GEORGIA SHIELD

SEE LEGEND ON A-O FOR VARIABLE DEFINITIONS

SIGN TEMPLATE 51

DETAILS OF EXIT DIRECTION SIGNS

- NO SCALE -

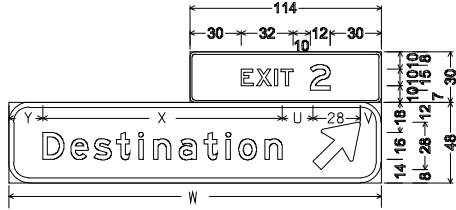

3" Radius, 1" Border, White on Green;
 "EXIT" E Mod.; "2" E Mod.;
 12" Radius, 3" Border, White on Green;
 "Destination" E; Arrow 18 - 36° 45°;

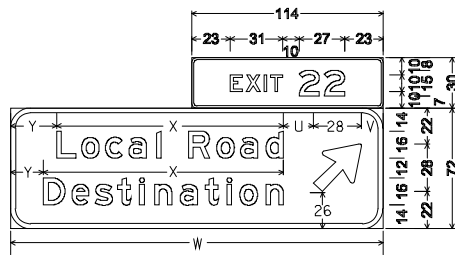

3" Radius, 1" Border, White on Green;
 "EXIT" E Mod.; "22" E Mod.;
 12" Radius, 3" Border, White on Green;
 "Local Road" E Mod.; "Destination" E Mod.; Arrow 18 - 36° 45°;

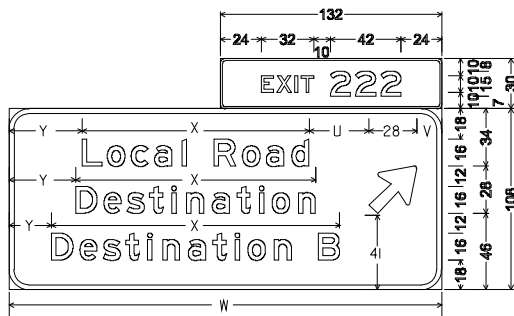

3" Radius, 1" Border, White on Green;
 "EXIT" E Mod.; "222" E Mod.;
 12" Radius, 3" Border, White on Green;
 "Local Road" E Mod.; "Destination" E Mod.;
 "Destination B" E; Arrow 18 - 36° 45°;

SEE LEGEND ON A-O FOR VARIABLE DEFINITIONS

SIGN TEMPLATE 52

DETAILS OF EXIT DIRECTION SIGNS

- NO SCALE -

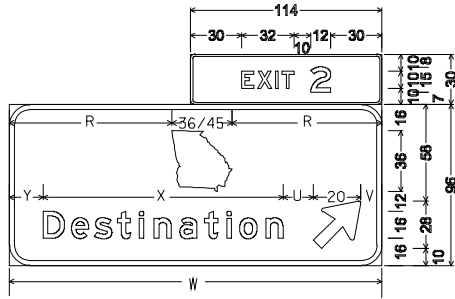

3" Radius, 1" Border, White on Green;
 "EXIT" E Mod. ; "2" E Mod. ;
 12" Radius, 3" Border, White on Green;
 "Destination" E Mod. ; Arrow 18 - 36" 45";

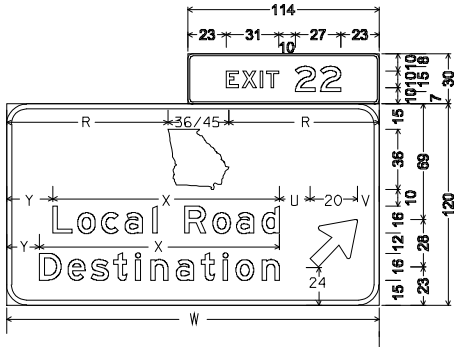

3" Radius, 1" Border, White on Green;
 "EXIT" E Mod. ; "22" E Mod. ;
 12" Radius, 3" Border, White on Green;
 "Local Road" E Mod. ; "Destination" E Mod.; Arrow 18 - 36" 45";

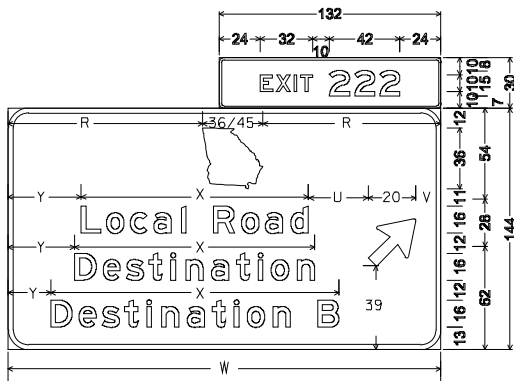

3" Radius, 1" Border, White on Green;
 "EXIT" E Mod. ; "222" E Mod. ;
 12" Radius, 3" Border, White on Green;
 "Local Road" E Mod. ; "Destination" E Mod.;
 "Destination B" E Mod. ; Arrow 18 - 36" 45";

NOTE:

15" & 12" SER. E NUMBERING USED IN GEORGIA SHIELD

SEE LEGEND ON A-O FOR VARIABLE DEFINITIONS

SIGN TEMPLATE 53 DETAILS OF EXIT DIRECTION SIGNS

- NO SCALE -

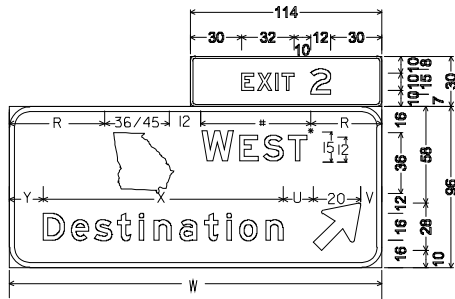

3" Radius, 1" Border, White on Green;
 "EXIT" E Mod. ; "2" E Mod.; "WEST" E Mod.;
 12" Radius, 3" Border, White on Green;
 "Destination" E Mod. ; Arrow 18 - 36° 45°;

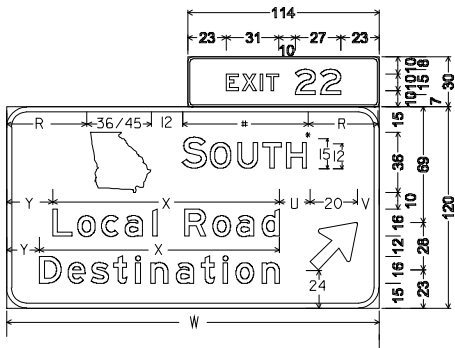

3" Radius, 1" Border, White on Green;
 "EXIT" E Mod. ; "22" E Mod. ; "NORTH" E Mod. ;
 12" Radius, 3" Border, White on Green;
 "Local Road" E Mod. ; "Destination" E Mod. ; Arrow 18 - 36° 45°;

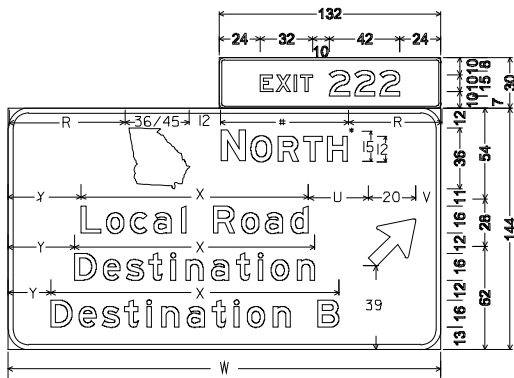

3" Radius, 1" Border, White on Green;
 "EXIT" E Mod. ; "222" E Mod. ; "SOUTH" E Mod. ;
 12" Radius, 3" Border, White on Green;
 "Local Road" E Mod. ; "Destination" E Mod. ;
 "Destination B" E Mod. ; Arrow 18 - 36° 45°;

NOTE:
 15" & 12" SER. E NUMBERING USED IN GEORGIA SHIELD

SEE LEGEND ON A-O FOR VARIABLE DEFINITIONS

SIGN TEMPLATE 54 DETAILS OF SUPPLEMENTAL SIGNS

- NO SCALE -

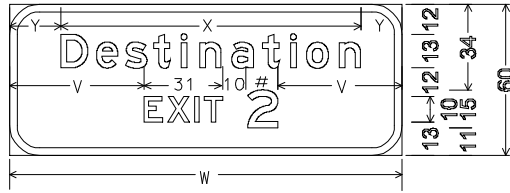

12" Radius, 3" Border, White on Green;
"Destination" E Mod.; "EXIT 2" E Mod. ;

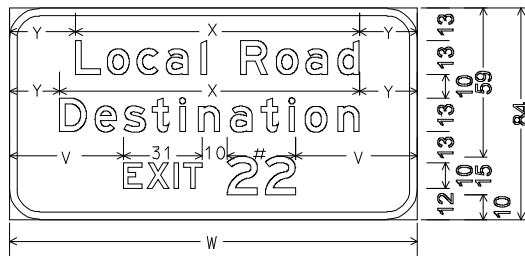

12" Radius, 3" Border, White on Green;
"Destination" E Mod.; "Local Road" E Mod.;
"EXIT 22" E Mod.;

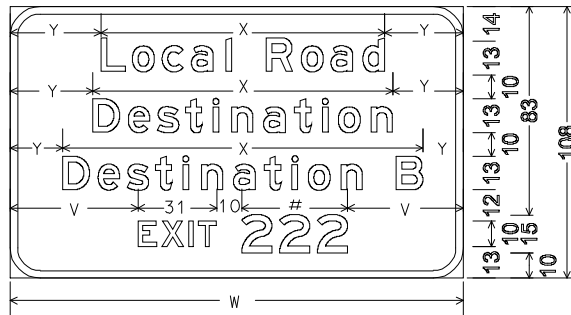

12" Radius, 3" Border, White on Green;
"Destination" E Mod. ;
"Destination B" E Mod.; "Local Road" E Mod.;
"EXIT 222" E Mod.;

NOTE:
USE THIS DETAIL ON ALL ROUTES WITH
EXIT NUMBERS.

SEE LEGEND ON A-0 FOR VARIABLE DEFINITIONS

SIGN TEMPLATE 55 DETAILS OF SUPPLEMENTAL SIGNS

- NO SCALE -

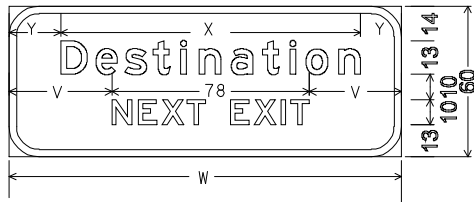

12" Radius, 3" Border, White on Green;
"Destination" E Mod.; "NEXT EXIT" E Mod.;



12" Radius, 3" Border, White on Green;
"Destination" E Mod.; "Local Road" E Mod.;
"NEXT EXIT" E Mod.;



12" Radius, 3" Border, White on Green
"Destination" E Mod.;
"Destination B" E Mod.; "Local Road" E Mod.; n;
"NEXT EXIT" E Mod.;

NOTE:
USE THIS DETAIL ON ALL ROUTES WITHOUT EXIT NUMBERS FOR SINGLE EXIT
INTERCHANGES AND FOR THE FIRST EXIT AT DUAL EXIT INTERCHANGES.

SEE LEGEND ON A-O FOR VARIABLE DEFINITIONS

SIGN TEMPLATE 56 DETAILS OF SUPPLEMENTAL SIGNS

- NO SCALE -

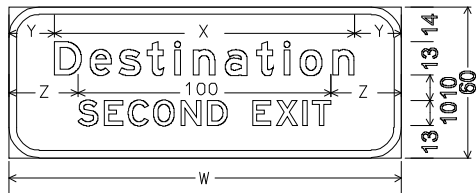

12" Radius, 3" Border, White on Green;
"Destination" E Mod.; "SECOND EXIT" E Mod.;



12" Radius, 3" Border, White on Green;
"Destination" E Mod.; "Local Road" E Mod. ;
"SECOND EXIT" E Mod.;

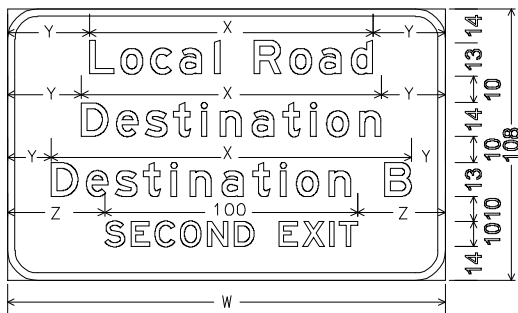

12" Radius, 3" Border, White on Green;
"Destination" E Mod. ;
"Destination B" E Mod. ; "Local Road" E Mod. ;
"SECOND EXIT" E Mod. ;

NOTE:
USE THIS DETAIL ON ALL ROUTES WITHOUT EXIT NUMBERS
~~FOR~~ THE SECOND EXIT AT DUAL EXIT INTERCHANGES.

SIGN TEMPLATE 57 DETAILS OF SUPPLEMENTAL SIGNS

- NO SCALE -

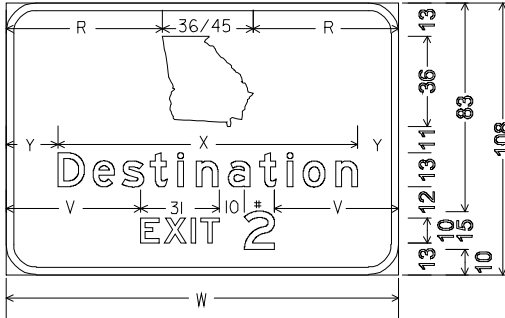

12" Radius, 3" Border, White on Green;
"Destination" E Mod. ; "EXIT 2" E Mod. ;

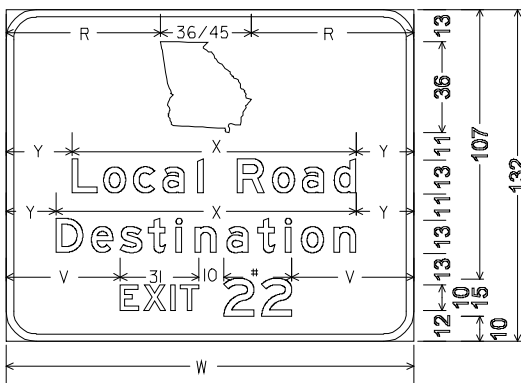

12" Radius, 3" Border, White on Green;
"Destination" E Mod. ; "Local Road" E Mod. ;
"EXIT 22" E Mod. ;

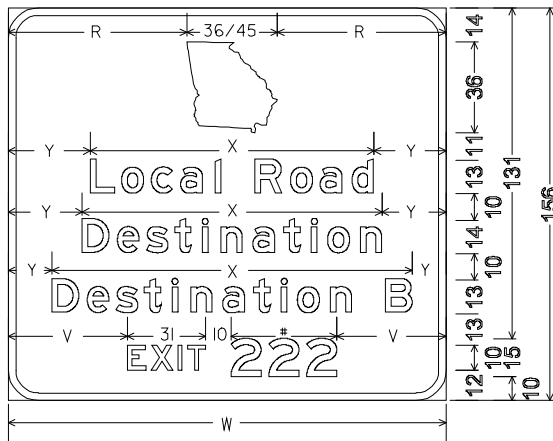

12" Radius, 3" Border, White on Green;
"Destination" E Mod. ;
"Destination B" E Mod. ; "Local Road" E Mod. ;
"EXIT 222" E Mod. ;

NOTE:
15" & 12" SER. E NUMBERING USED IN GEORGIA SHIELD

SEE LEGEND ON A-O FOR VARIABLE DEFINITIONS

SIGN TEMPLATE 58 DETAILS OF SUPPLEMENTAL SIGNS

- NO SCALE -

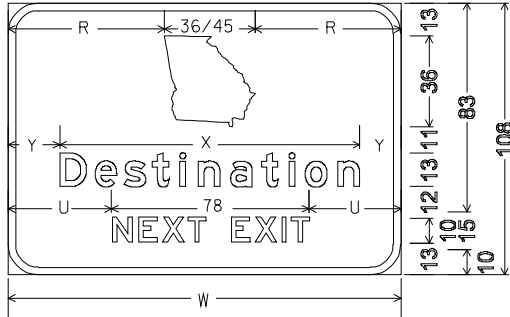

12" Radius, 3" Border, White on Green;
"Destination" E Mod. ; "EXIT 2" E Mod. ;

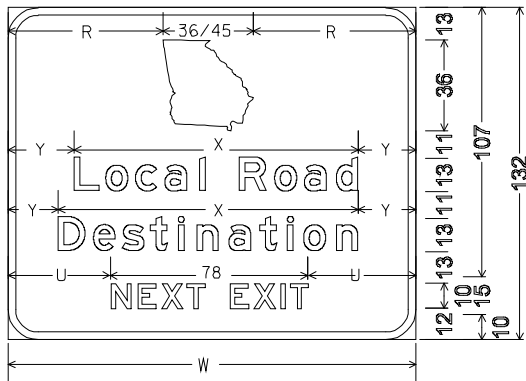

12" Radius, 3" Border, White on Green;
"Destination" E Mod.; "Local Road" E Mod.;
"EXIT 22" E Mod. ;

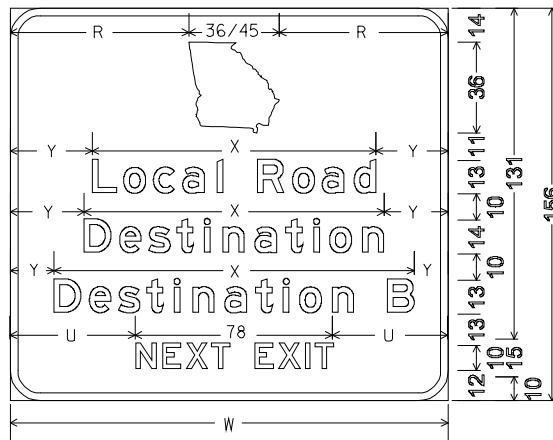

12" Radius, 3" Border, White on Green;
"Destination" E Mod. ;
"Destination B" E Mod.; "Local Road" E Mod.;
"EXIT 222" E Mod. ;

NOTE:

15" & 12" SER. E NUMBERING USED IN GEORGIA SHIELD

SEE LEGEND ON A-O FOR VARIABLE DEFINITIONS

SIGN TEMPLATE 59 DETAILS OF HOSPITAL SIGNS

- NO SCALE -

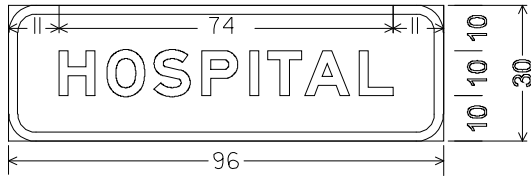

6.0" Radius, 2.0" Border, White on Blue;
"HOSPITAL" E Mod.;

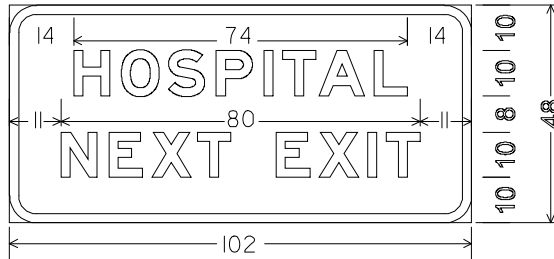

6.0" Radius, 2.0" Border, White on Blue;
"HOSPITAL" E Mod. ;
"NEXT EXIT" E Mod. ;

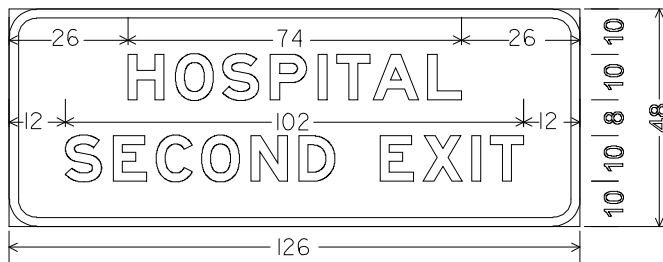

6.0" Radius, 2.0" Border, White on Blue;
"HOSPITAL" E Mod. ;
"SECOND EXIT" E Mod. ;

NOTE:

USE THIS DETAIL ON ALL ROUTES WITHOUT EXIT NUMBERS
~~FOR~~ THE SECOND EXIT AT DUAL EXIT INTERCHANGES.

LEGEND:

W SIGN WIDTH (FEET & INCHES)

~~1079~~ DETERMINED BY CENTERING: 10.5" IF GOVERNING LINE OF COPY

SIGN TEMPLATE 60 DETAILS OF MILEAGE SIGNS

- NO SCALE -

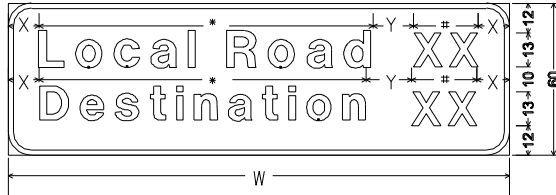

9" Radius, 2" Border, White on Green;
"LOCAL ROAD" E; "XX" E; "DESTINATION" E; "XX" E;

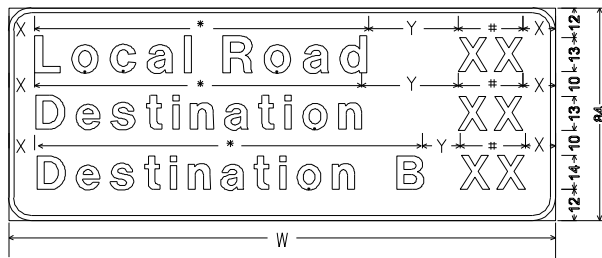

9" Radius, 2" Border, White on Green;
"LOCAL ROAD" E; "XX" E; "DESTINATION" E; "XX" E;
"DESTINATION B" E; "XX" E;

LEGEND:

- * DETERMINED BY LENGTH OF DESTINATION NAME
- W SIGN WIDTH (FEET & INCHES)
- X VARIABLE (10" MINIMUM, 13" MAXIMUM)
- Y VARIABLE, 13" MINIMUM (IF IN GOVERNING LINE OF COPY)
- # DETERMINED BY LENGTH OF NUMBER

SIGN TEMPLATE 6I

DETAILS OF INTERCHANGE SEQUENCE SIGNS

- NO SCALE -

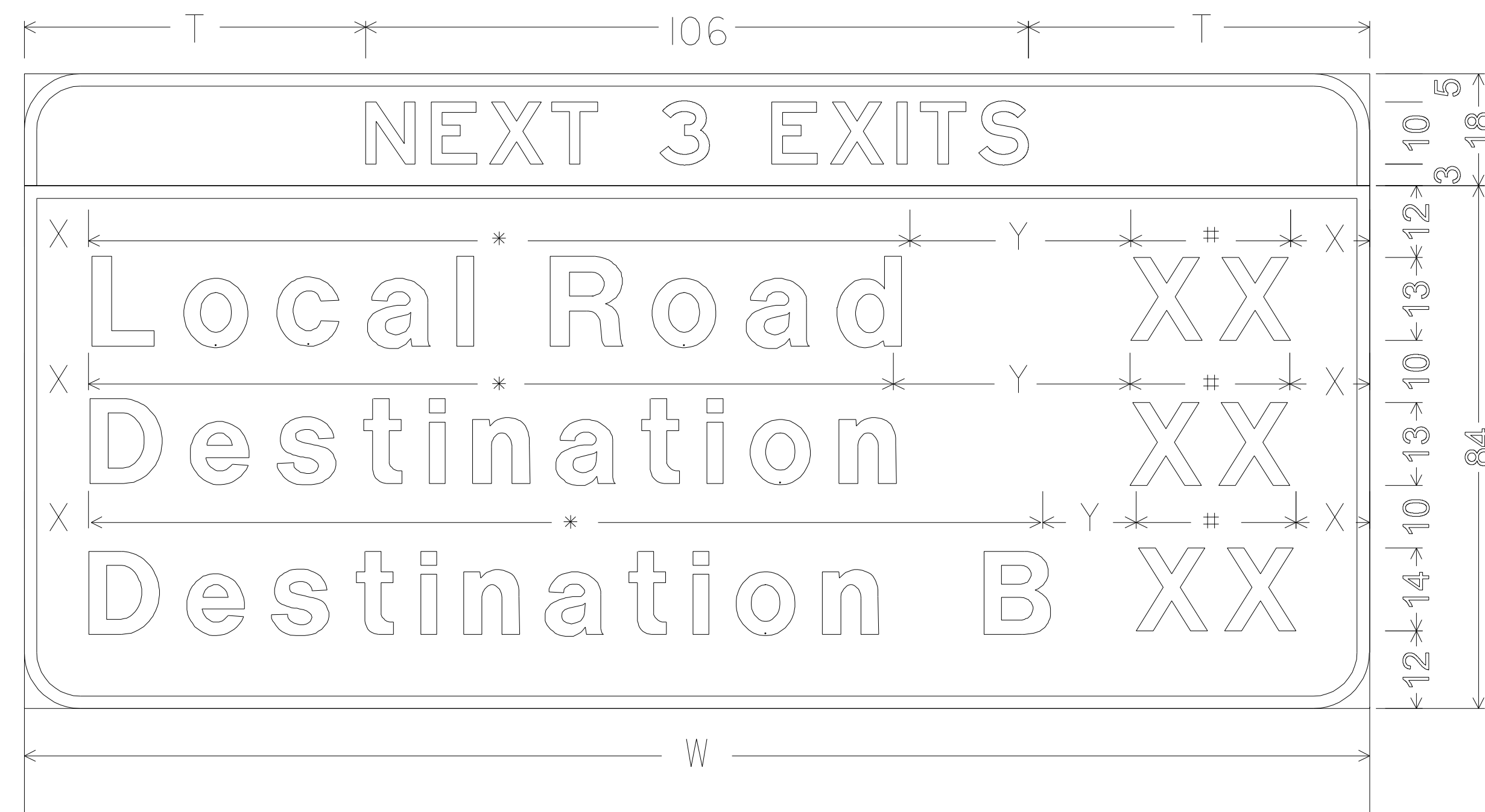

9" Radius, 2" Border, White on Green;
 "NEXT 3 EXITS" E;
 9" Radius, 2" Border, White on Green;
 "LOCAL ROAD" D; "XX" D; "DESTINATION" D; "XX" D; "DESTINATION B" D;
 "XX" D;

NOTE:
 WHEN 2 SIGNS ARE PLACED BACK-TO-BACK ON THE SAME
 STRUCTURE, BOTH SIGNS SHALL BE THE SAME WIDTH

LEGEND:

- * DETERMINED BY LENGTH OF DESTINATION NAME
- # SEE SPACING CHART ON THIS SHEET
- T DETERMINED BY CENTERING: (12" MINIMUM IF GOVERNING LINE OF COPY)
- W WIDTH OF SIGN (FEET & INCHES)
- X VARIABLE, 10" MINIMUM, 13" MAXIMUM
- Y 13" MINIMUM AND DESIRABLE IF ON GOVERNING LINE OF COPY

SIGN TEMPLATE 62

DETAILS OF POLITICAL BOUNDARY SIGNS

- NO SCALE -

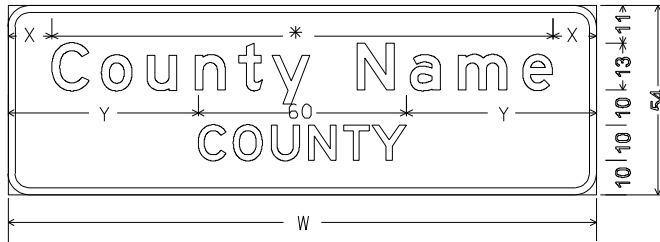

6" Radius, 2" Border, White on Green;
 "County Name" E; "COUNTY" E;

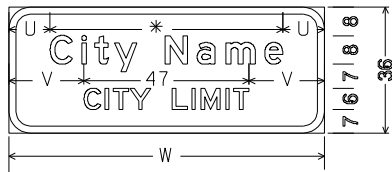

6" Radius, 2" Border, White on Green;
 "City Name" E; "CITY LIMIT" E;

LEGEND:

- * DETERMINED USING MOST CURRENT DESIGN SOFTWARE PROGRAM
- U VARIABLE (6" MINIMUM, 8.5" MAXIMUM IF GOVERNING LINE OF COPY)
- V DETERMINED BY CENTERING LEGEND (7" IF GOVERNING LINE OF COPY)
- W SIGN WIDTH (FEET & INCHES)
- X VARIABLE (10" MINIMUM, 13" MAXIMUM IF GOVERNING LINE OF COPY)
- Y DETERMINED BY CENTERING LEGEND (10.5" IF GOVERNING LINE OF COPY)

SIGN TEMPLATE 63

DETAILS OF RIVER/TO CITY SIGN

- NO SCALE -



6" Radius, 2" Border, White on Green;
 "River Name" E; "River" E;



6" Radius, 2" Border, White on Green;
 "To Athens" E; "EXIT 22" E;

LEGEND:

- * DETERMINED BY LENGTH OF RIVER NAME/TO CITY
- W SIGN WIDTH (FEET & INCHES)
- X VARIABLE (10" MINIMUM, 13" MAXIMUM IF GOVERNING LINE OF COPY)
- Y DETERMINED BY CENTERING (11.5" IF GOVERNING LINE OF COPY)
- # DETERMINED BY LENGTH OF NUMBER

APPENDIX B – TYPICAL SIGNING AND PAVEMENT MARKING

- B-1 Signing To/From Divided Highway
- B-2 Marking To/From Divided Highway
- B-3 Signing at a Closed Median “T” Intersection
- B-4 Marking at a Closed Median “T” Intersection
- B-5 Signing at a Type A Median Opening
- B-6 Signing at a Type A Median “T” Intersection
- B-7 Signing at a Type A Median Cross Road Intersection
- B-8 Marking at a Type A Median “T” Intersection
- B-9 Signing at a Type B Median Opening
- B-10 Signing at a Type B Median “T” Intersection
- B-11 Signs at a Type B Median Cross Road Intersection
- B-12 Marking at a Type B Median “T” Intersection
- B-13 Signing at a Type C Median Opening
- B-14 Signing at a Type C Median “T” Intersection
- B-15 Signing at a Type C Median Cross Road Intersection
- B-16 Marking at a Type C Median “T” Intersection
- B-17 School Zone Signing
- B-18 Stop Sign Placement Detail
- B-19 Typical Rural RPM Passing Detail

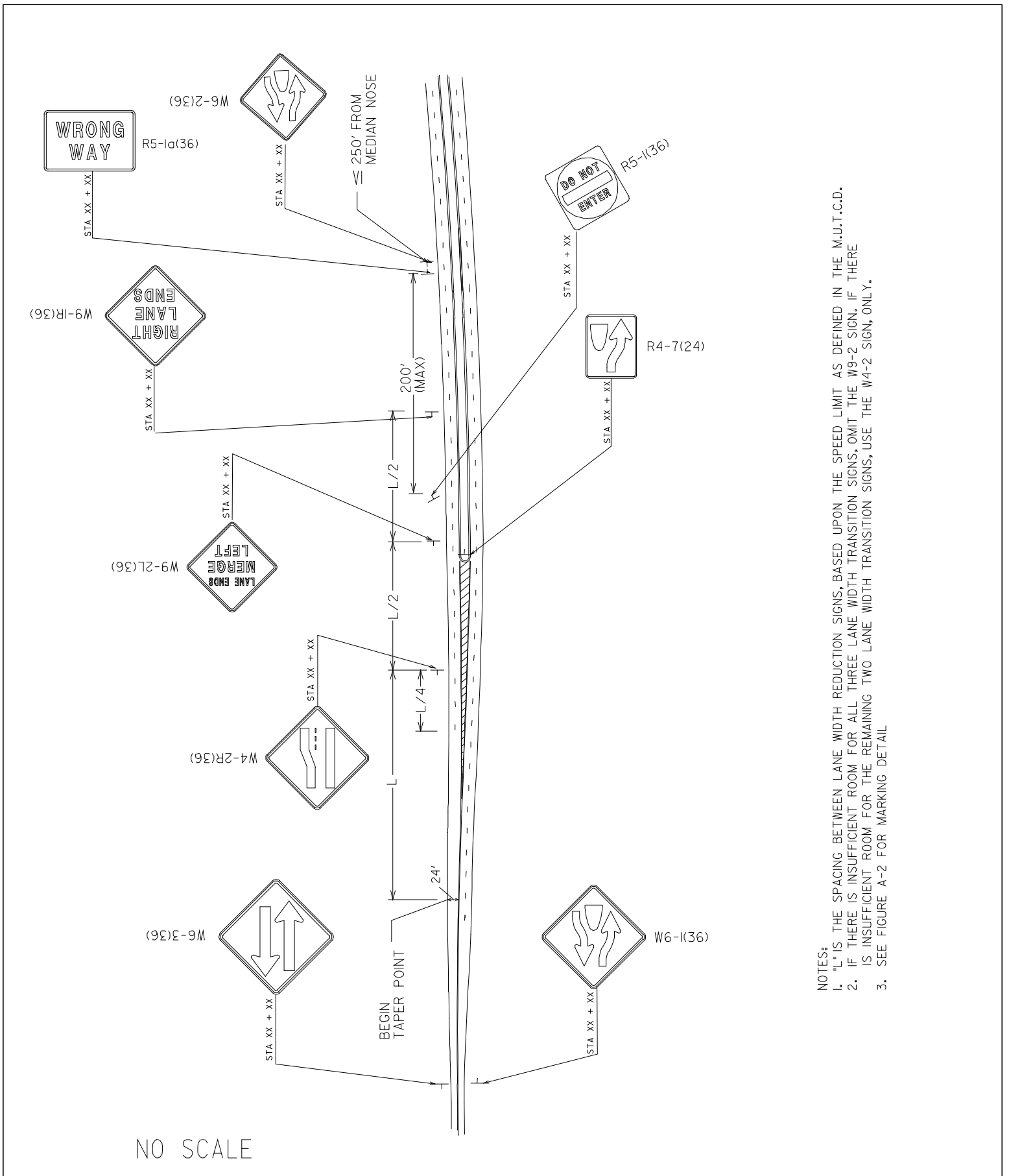

NO SCALE

- NOTES:
1. "L" IS THE SPACING BETWEEN LANE WIDTH REDUCTION SIGNS, BASED UPON THE SPEED LIMIT AS DEFINED IN THE M.U.T.C.D.
 2. IF THERE IS INSUFFICIENT ROOM FOR ALL THREE LANE WIDTH TRANSITION SIGNS, OMIT THE W9-2 SIGN. IF THERE IS INSUFFICIENT ROOM FOR THE REMAINING TWO LANE WIDTH TRANSITION SIGNS, USE THE W4-2 SIGN, ONLY.
 3. SEE FIGURE A-2 FOR MARKING DETAIL

SIGNING TO/FROM DIVIDED HIGHWAY

FIGURE B-1

NO SCALE

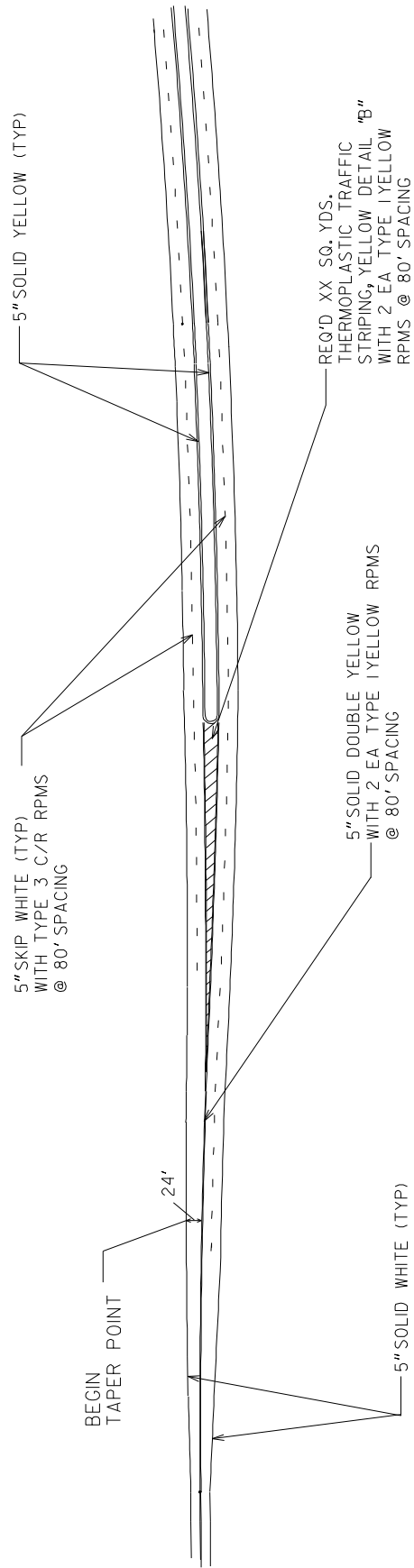

NOTES:
1. SEE DETAIL T-15 FOR ADDITIONAL GUIDANCE ON RPM PLACEMENT AND USAGE

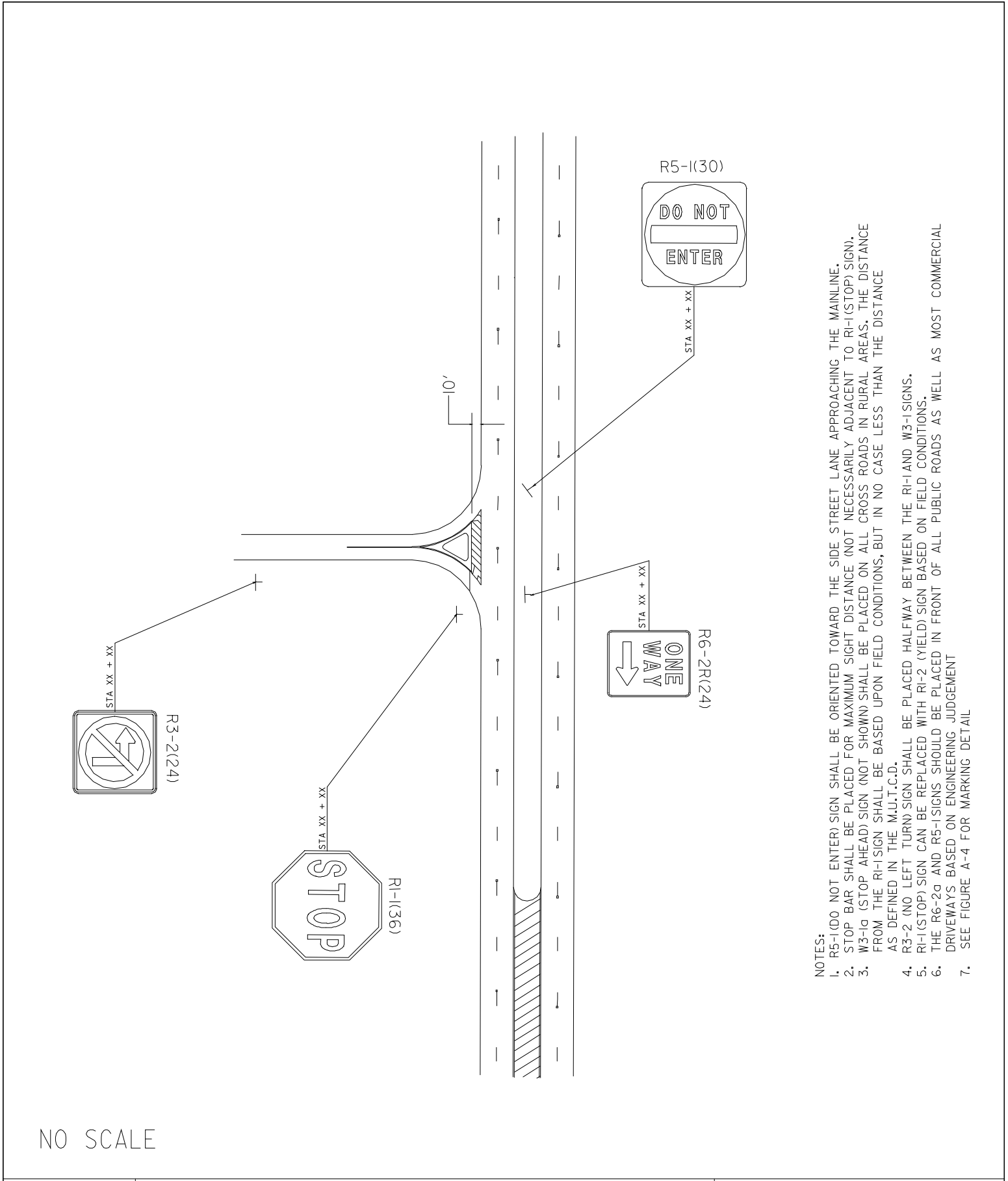

- NOTES:
1. R5-1(DO NOT ENTER) SIGN SHALL BE ORIENTED TOWARD THE SIDE STREET LANE APPROACHING THE MAINLINE.
 2. STOP BAR SHALL BE PLACED FOR MAXIMUM SIGHT DISTANCE (NOT NECESSARILY ADJACENT TO R1-1(STOP) SIGN).
 3. W3-1c (STOP AHEAD) SIGN (NOT SHOWN) SHALL BE PLACED ON ALL CROSS ROADS IN RURAL AREAS. THE DISTANCE FROM THE R1-1 SIGN SHALL BE BASED UPON FIELD CONDITIONS, BUT IN NO CASE LESS THAN THE DISTANCE AS DEFINED IN THE M.U.T.C.D.
 4. R3-2 (NO LEFT TURN) SIGN SHALL BE PLACED HALFWAY BETWEEN THE R1-1 AND W3-1 SIGNS.
 5. R1-1 (STOP) SIGN CAN BE REPLACED WITH R1-2 (YIELD) SIGN BASED ON FIELD CONDITIONS.
 6. THE R6-2a AND R5-1 SIGNS SHOULD BE PLACED IN FRONT OF ALL PUBLIC ROADS AS WELL AS MOST COMMERCIAL DRIVEWAYS BASED ON ENGINEERING JUDGEMENT
 7. SEE FIGURE A-4 FOR MARKING DETAIL

NO SCALE

SIGNING AT A CLOSED
MEDIAN "T" INTERSECTION

FIGURE B-3

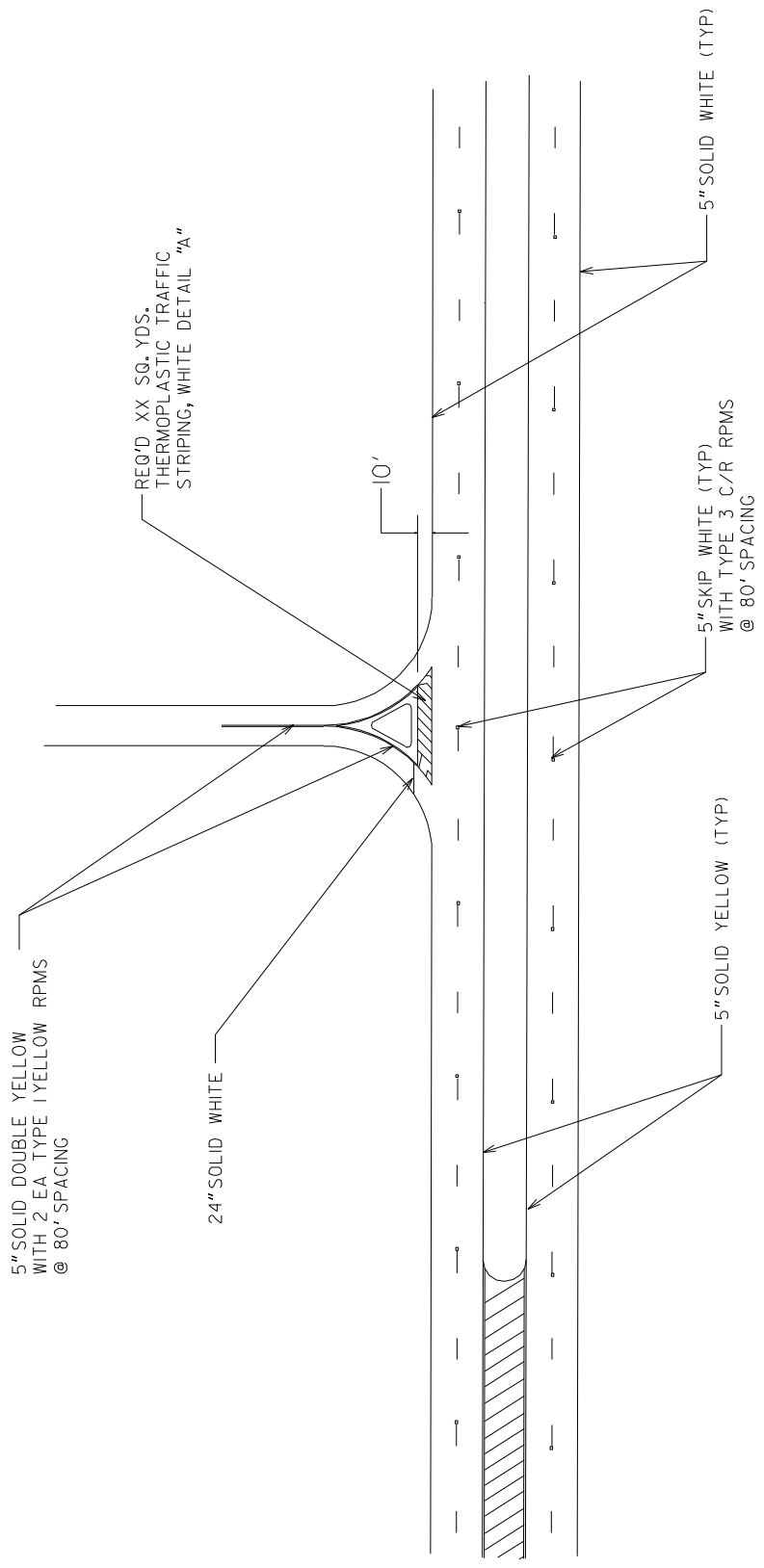

- NOTES:
1. STOP BAR SHALL BE PLACED FOR MAXIMUM SIGHT DISTANCE (NOT NECESSARILY ADJACENT TO R1-1(STOP) SIGN). SEE A-2 FOR SIGNING DETAIL
 2. SEE DETAIL T-15 FOR ADDITIONAL GUIDANCE ON RPM PLACEMENT AND USAGE

NO SCALE

MARKING AT A CLOSED MEDIAN "T" INTERSECTION

FIGURE B-4

NO SCALE

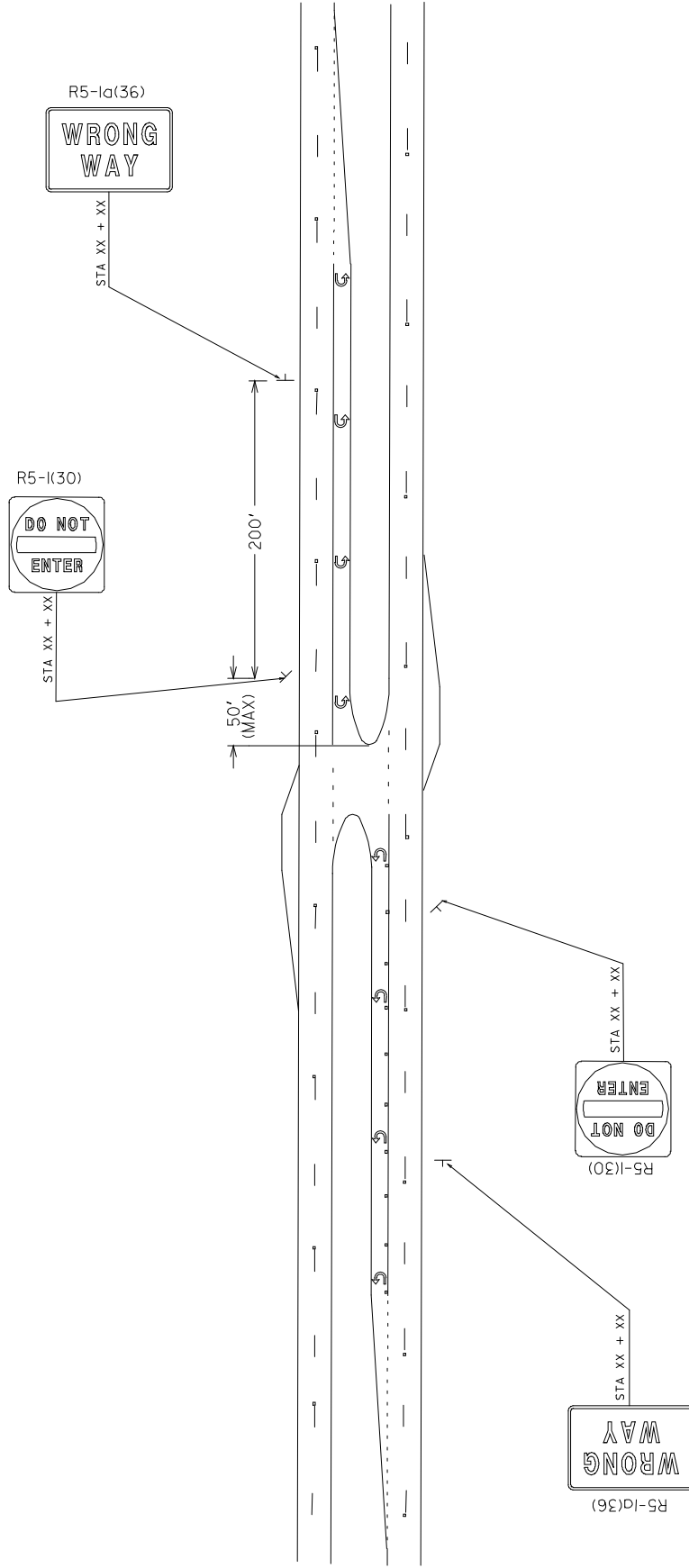

- NOTES:
1. R5-1(DO NOT ENTER) SIGNS SHALL BE ORIENTED TOWARD THE OPPOSING U-TURN LANES.
 2. ADDITIONAL SIGNING MAY BE REQUIRED AS DETERMINED BY A SOUND TRAFFIC ENGINEERING STUDY BASED UPON CONDITIONS AT EACH LOCATION.
 3. SEE DETAIL T-15 FOR ADDITIONAL GUIDANCE ON RPM PLACEMENT
 4. SEE FIGURE A-8 FOR MARKING DETAIL

SIGNING AT TYPE A MEDIAN OPENING

FIGURE B-5

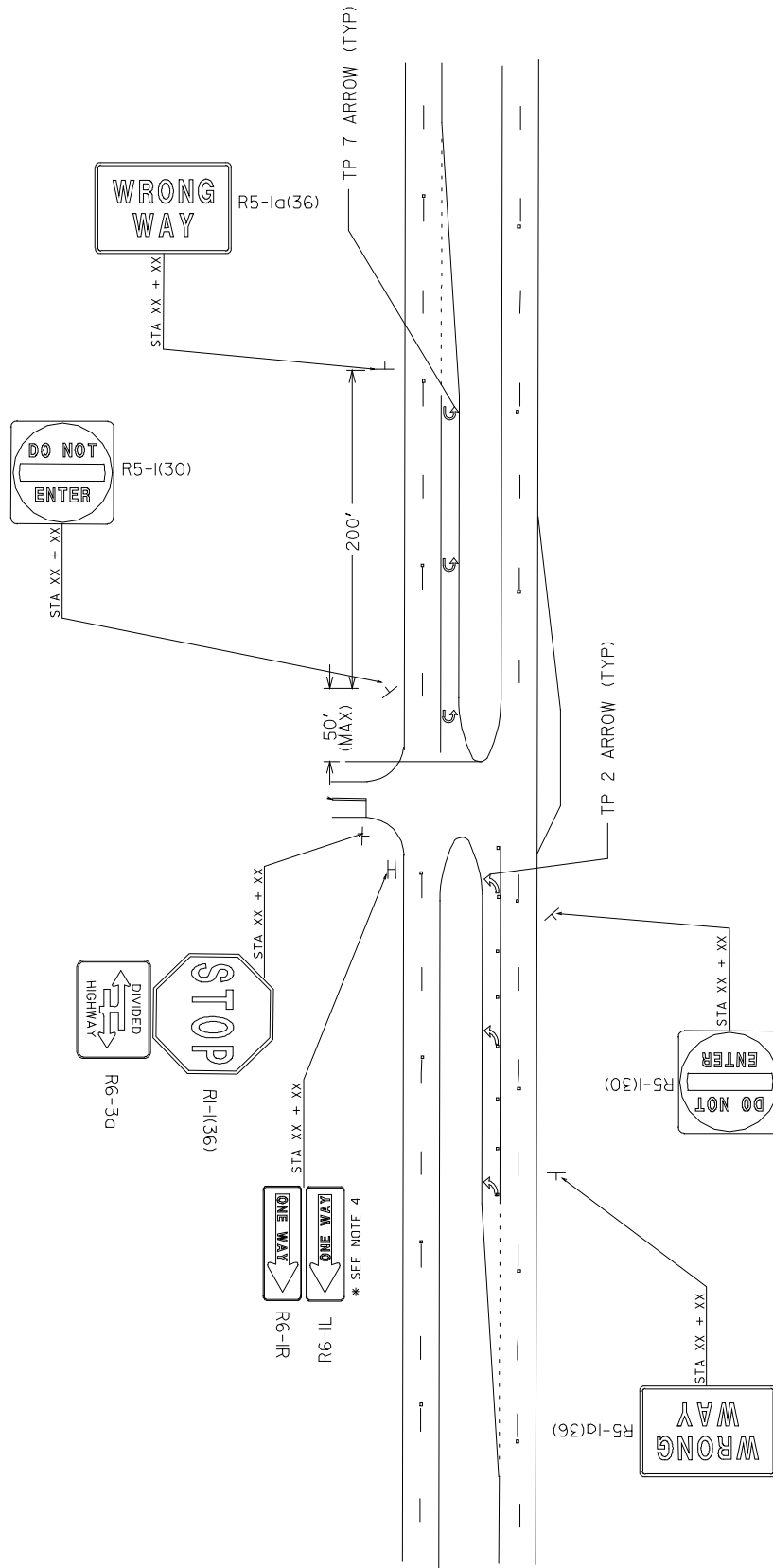

- NOTES:
1. R5-1(DO NOT ENTER) SIGNS SHALL BE ORIENTED TOWARD THE MAINLINE LEFT/J-TURN LANES.
 2. W3-1(STOP AHEAD) SIGN (NOT SHOWN) SHALL BE PLACED ON ALL CROSS ROADS IN RURAL AREAS. THE DISTANCE FROM THE R1-1 SIGN SHALL BE BASED UPON FIELD CONDITIONS, BUT IN NO CASE LESS THAN THE DISTANCE AS DEFINED IN THE M.U.T.C.D.
 3. ADDITIONAL SIGNING MAY BE REQUIRED AS DETERMINED BY A SOUND TRAFFIC ENGINEERING STUDY BASED UPON CONDITIONS AT EACH LOCATION.
 4. R6-1R, R6-1L (ONE WAY) SIGN SHALL BE USED ONLY IF MEDIAN WIDTH IS GREATER THAN 30'
 5. SEE FIGURE A-8 FOR MARKING DETAIL

NO SCALE

SIGNING AT TYPE A
MEDIAN "T" INTERSECTION

FIGURE B-6

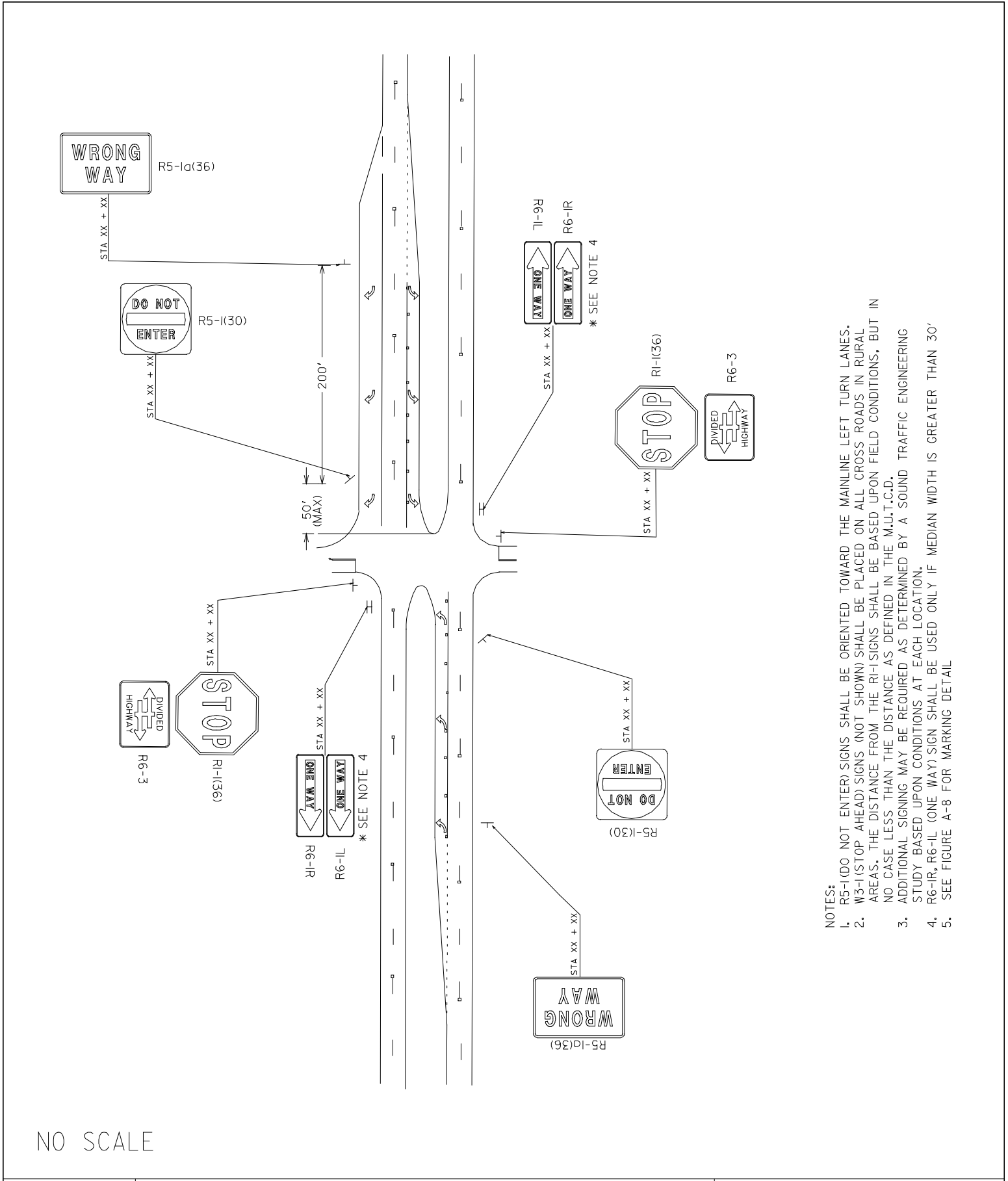

NO SCALE

SIGNING AT TYPE A
MEDIAN CROSS ROAD INTERSECTION

FIGURE B-7

- NOTES:
1. R5-1(DO NOT ENTER) SIGNS SHALL BE ORIENTED TOWARD THE MAINLINE LEFT TURN LANES.
 2. W3-1(STOP AHEAD) SIGNS (NOT SHOWN) SHALL BE PLACED ON ALL CROSS ROADS IN RURAL AREAS. THE DISTANCE FROM THE R1-1 SIGNS SHALL BE BASED UPON FIELD CONDITIONS, BUT IN NO CASE LESS THAN THE DISTANCE AS DEFINED IN THE M.U.T.C.D.
 3. ADDITIONAL SIGNING MAY BE REQUIRED AS DETERMINED BY A SOUND TRAFFIC ENGINEERING STUDY BASED UPON CONDITIONS AT EACH LOCATION.
 4. R6-1R, R6-1L (ONE WAY) SIGN SHALL BE USED ONLY IF MEDIAN WIDTH IS GREATER THAN 30'
 5. SEE FIGURE A-8 FOR MARKING DETAIL

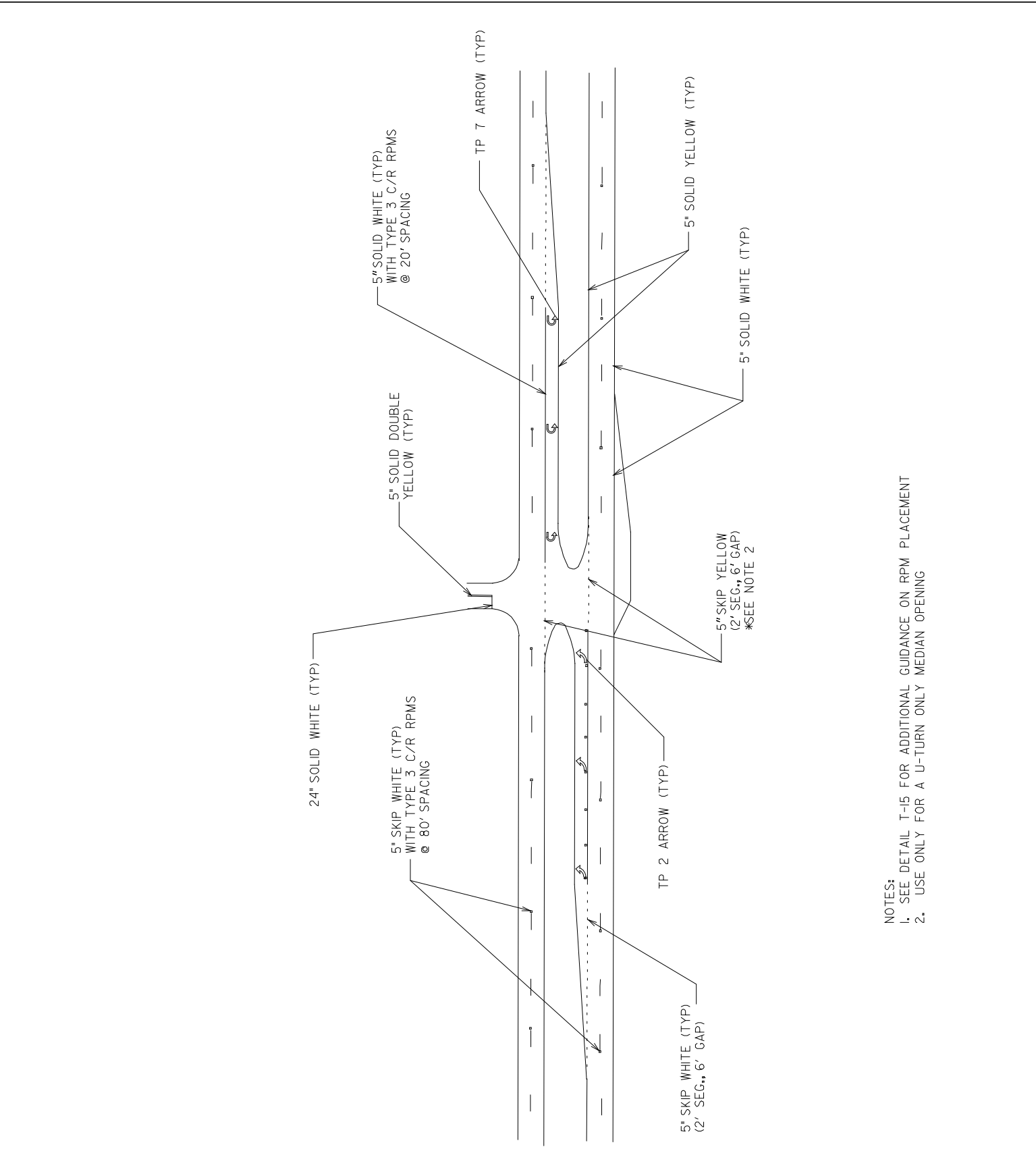

- NOTES:
1. SEE DETAIL T-15 FOR ADDITIONAL GUIDANCE ON RPM PLACEMENT
 2. USE ONLY FOR A U-TURN ONLY MEDIAN OPENING

NO SCALE

MARKING AT TYPE A
MEDIAN "T" INTERSECTION

FIGURE B-8

NO SCALE

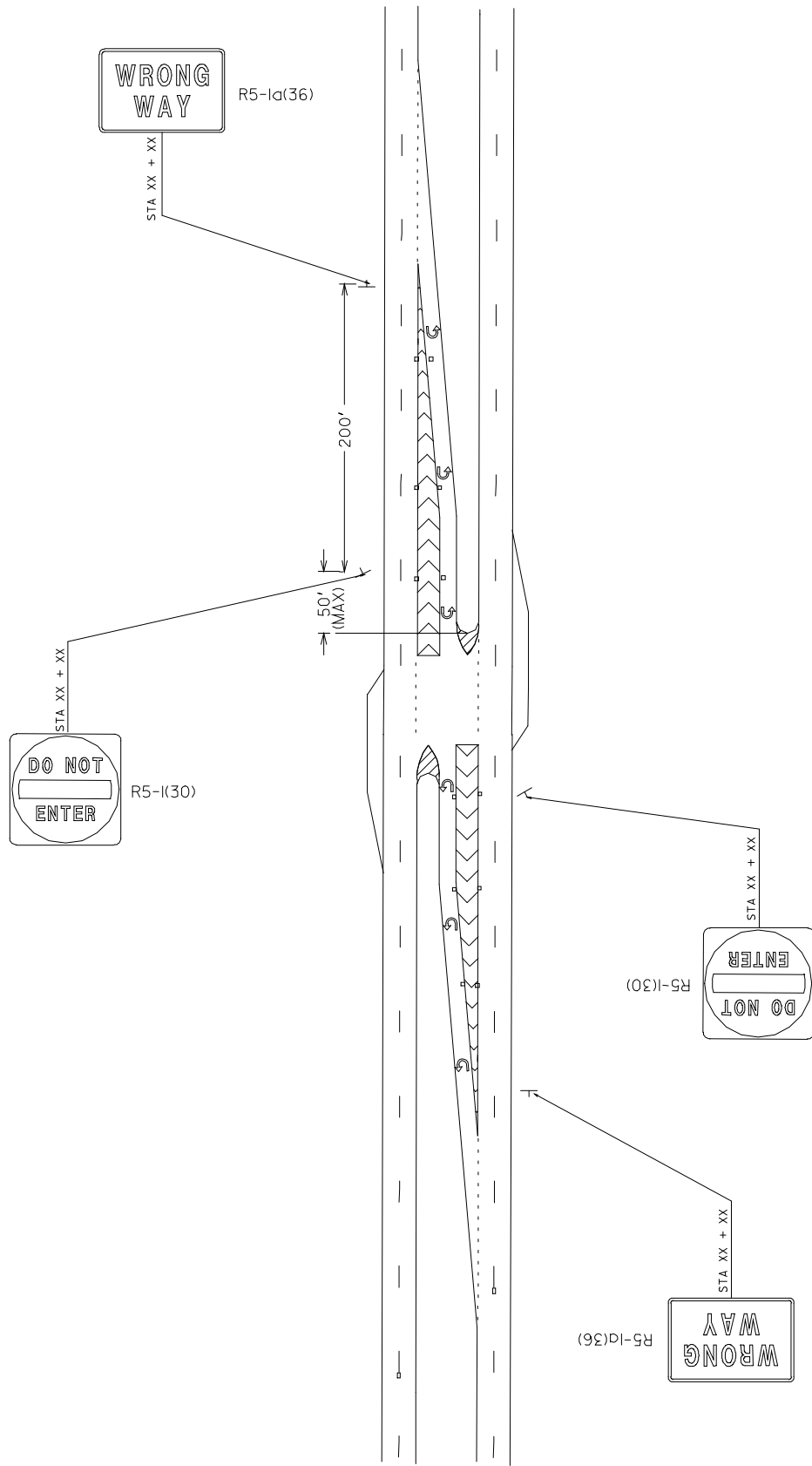

- NOTES:
1. R5-I(DO NOT ENTER) SIGNS SHALL BE ORIENTED TOWARD THE OPPOSING U-TURN LANES.
 2. ADDITIONAL SIGNING MAY BE REQUIRED AS DETERMINED BY A SOUND TRAFFIC ENGINEERING STUDY BASED UPON CONDITIONS AT EACH LOCATION.
 3. SEE FIGURE A-12 FOR MARKING DETAIL

SIGNING AT TYPE B MEDIAN OPENING

FIGURE B-9

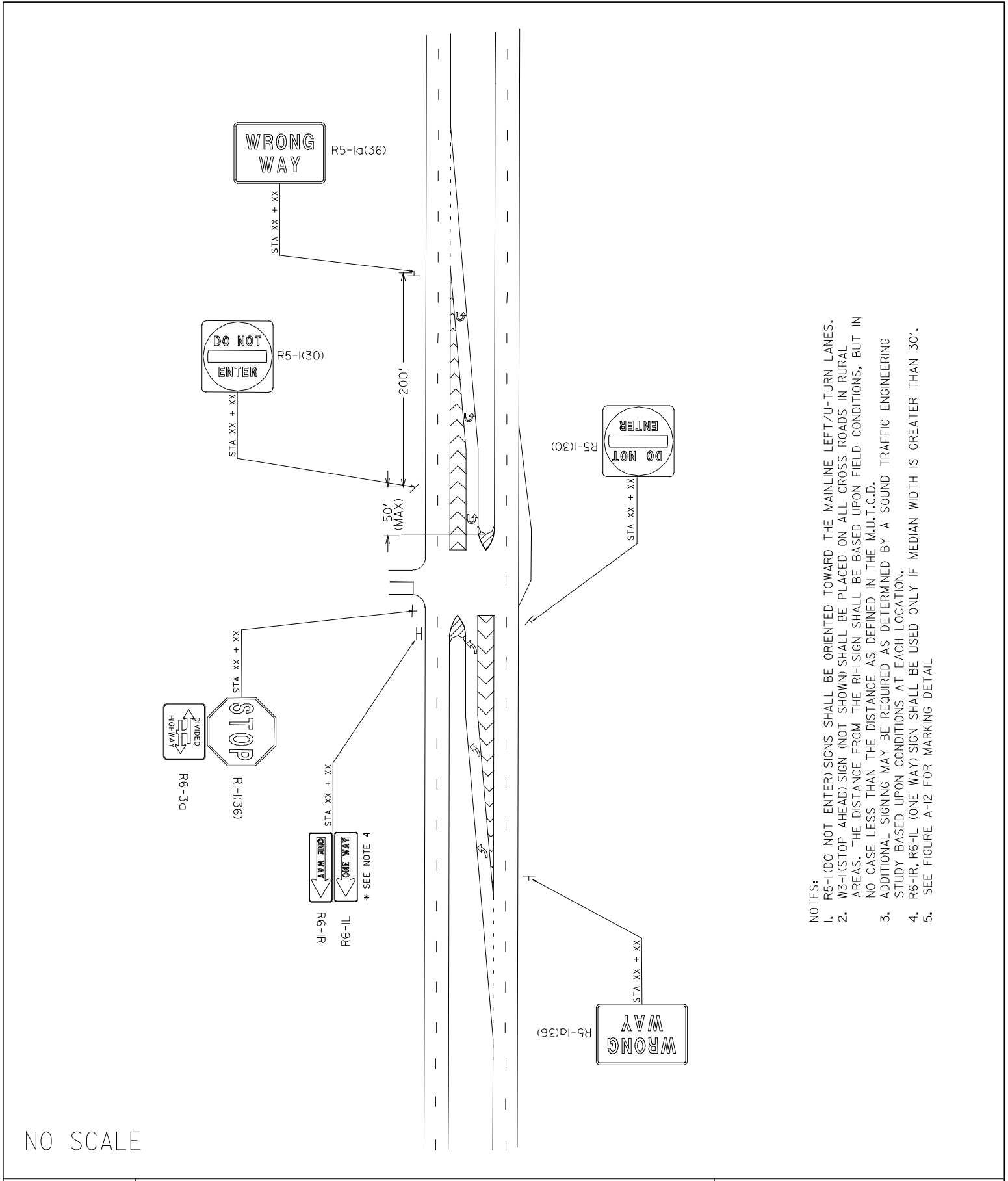

- NOTES:
1. R5-1 (DO NOT ENTER) SIGNS SHALL BE ORIENTED TOWARD THE MAINLINE LEFT/RIGHT-TURN LANES.
 2. W3-1 (STOP AHEAD) SIGN (NOT SHOWN) SHALL BE PLACED ON ALL CROSS ROADS IN RURAL AREAS. THE DISTANCE FROM THE R1-1 SIGN SHALL BE BASED UPON FIELD CONDITIONS, BUT IN NO CASE LESS THAN THE DISTANCE AS DEFINED IN THE M.U.T.C.D.
 3. ADDITIONAL SIGNING MAY BE REQUIRED AS DETERMINED BY A SOUND TRAFFIC ENGINEERING STUDY BASED UPON CONDITIONS AT EACH LOCATION.
 4. R6-1R, R6-1L (ONE WAY) SIGN SHALL BE USED ONLY IF MEDIAN WIDTH IS GREATER THAN 30'.
 5. SEE FIGURE A-12 FOR MARKING DETAIL

NO SCALE

SIGNING AT TYPE B
MEDIAN "T" INTERSECTION

FIGURE B-10

NO SCALE

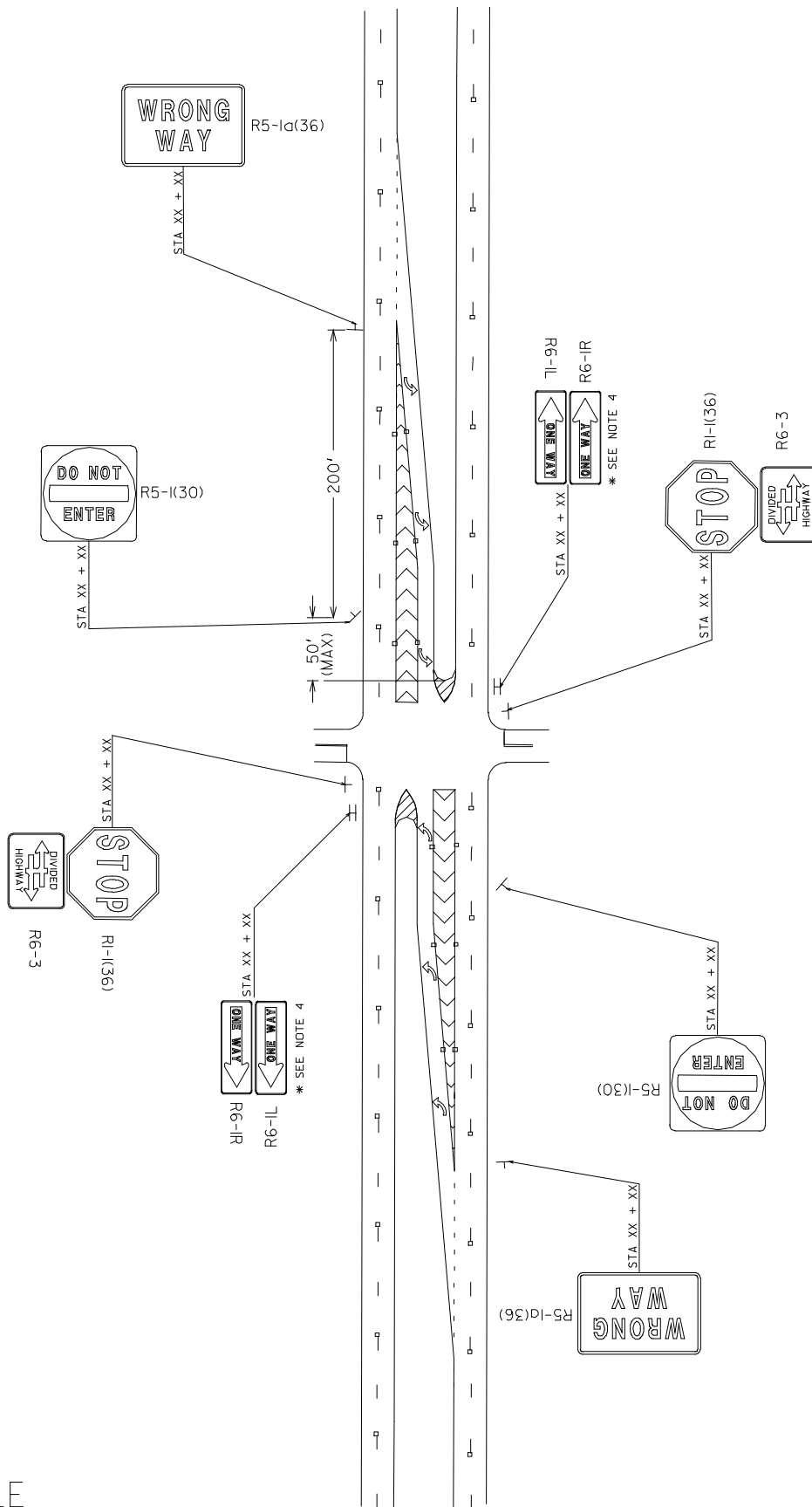

- NOTES:
1. R5-I(DO NOT ENTER) SIGNS SHALL BE ORIENTED TOWARD THE MAINLINE LEFT TURN LANES.
 2. W3-I(STOP AHEAD) SIGNS (NOT SHOWN) SHALL BE PLACED ON ALL CROSS ROADS IN RURAL AREAS. THE DISTANCE FROM THE R1-I SIGNS SHALL BE BASED UPON FIELD CONDITIONS, BUT IN NO CASE LESS THAN THE DISTANCE AS DEFINED IN THE M.U.T.C.D.
 3. ADDITIONAL SIGNING MAY BE REQUIRED AS DETERMINED BY A SOUND TRAFFIC ENGINEERING STUDY BASED UPON CONDITIONS AT EACH LOCATION.
 4. R6-IR, R6-IL (ONE WAY) SIGN SHALL BE USED ONLY IF MEDIAN WIDTH IS GREATER THAN 30'.
 5. SEE FIGURE A-12 FOR MARKING DETAIL

SIGNS AT TYPE B
MEDIAN CROSS ROAD INTERSECTION

FIGURE B-II

NO SCALE

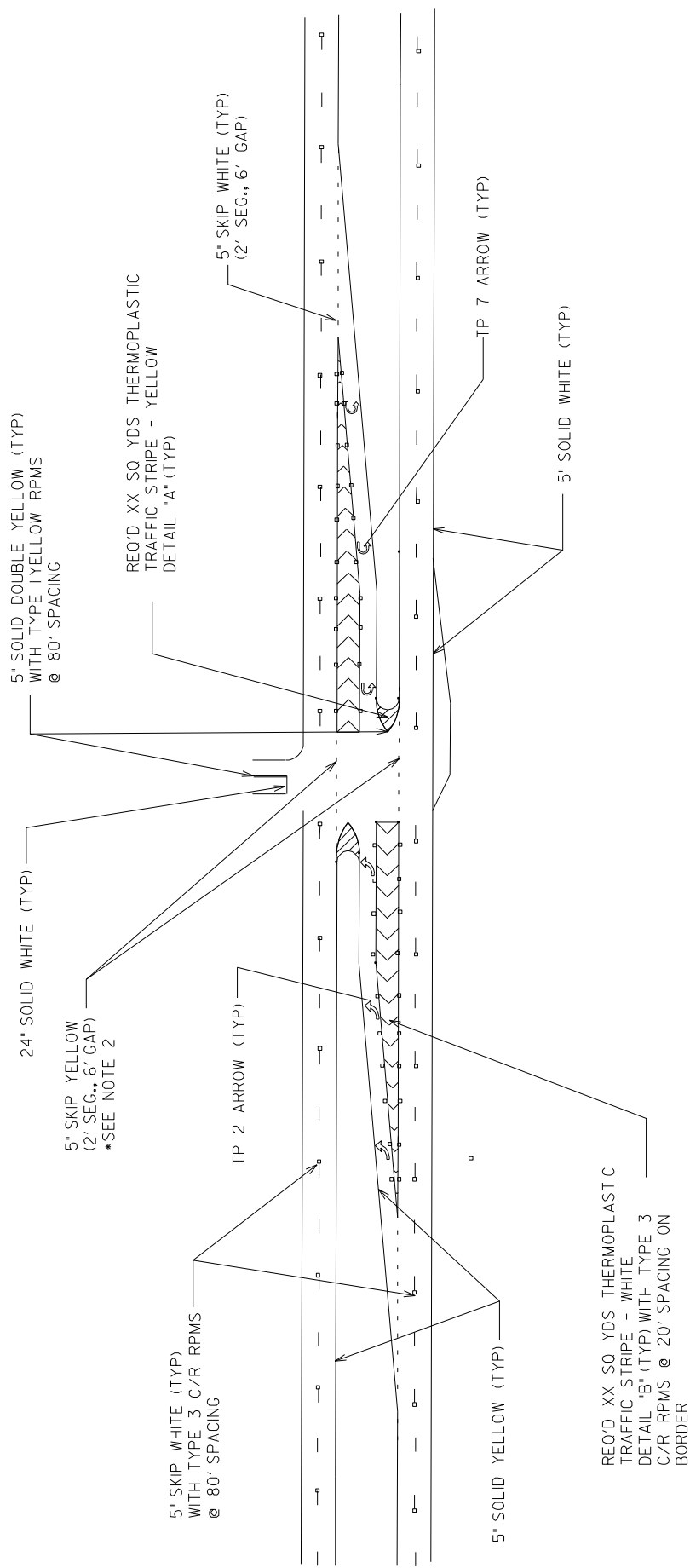

- NOTES:
1. SEE DETAIL T-15 FOR ADDITIONAL GUIDANCE ON RPM PLACEMENT AND USAGE
 2. USE ONLY FOR A U-TURN ONLY MEDIAN OPENING

MARKING AT TYPE B MEDIAN "T" INTERSECTION

FIGURE B-12

NO SCALE

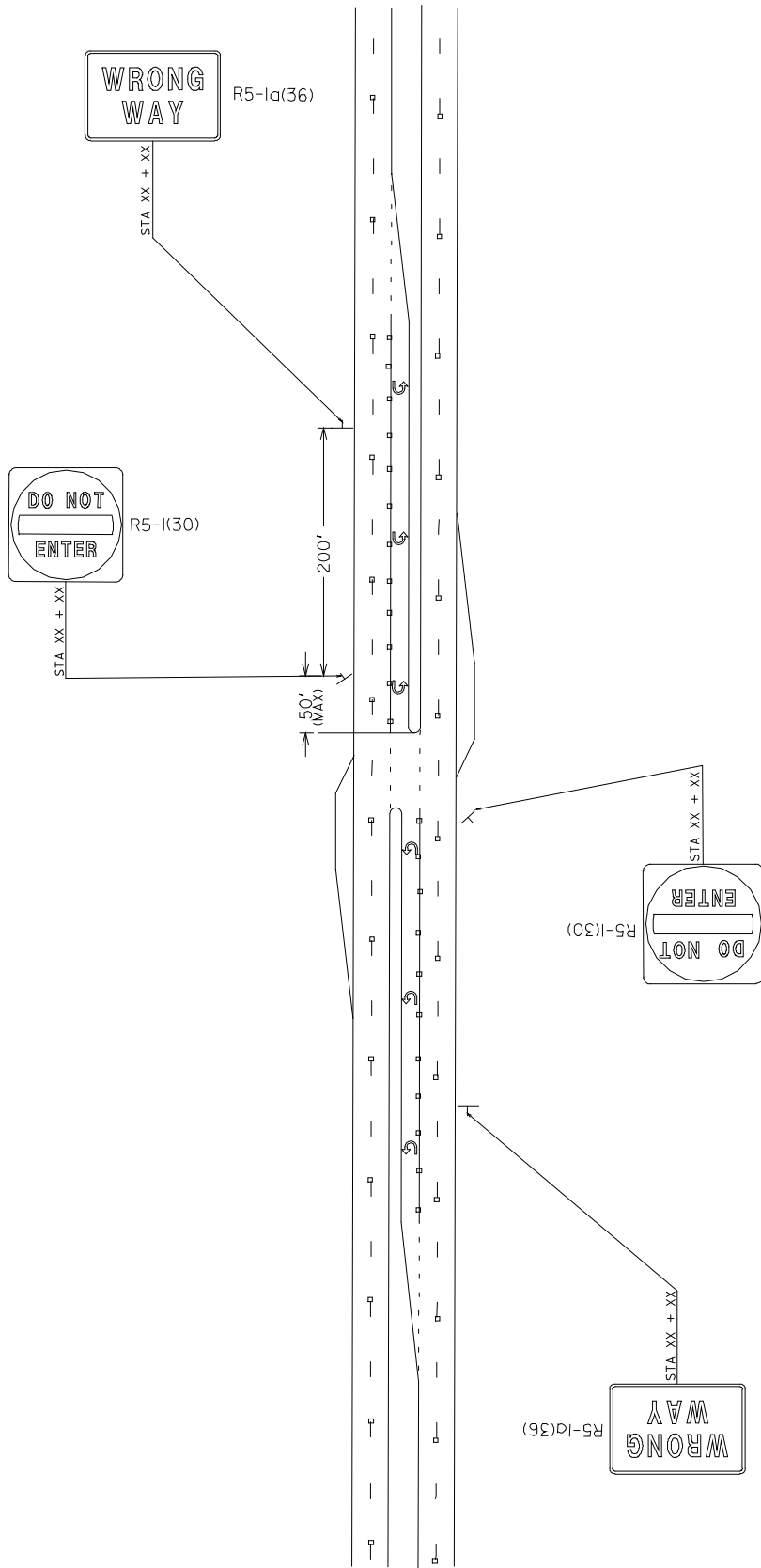

- NOTES:
1. R5-1(DO NOT ENTER) SIGNS SHALL BE ORIENTED TOWARD THE OPPOSING U-TURN LANES.
 2. ADDITIONAL SIGNING MAY BE REQUIRED AS DETERMINED BY A SOUND TRAFFIC ENGINEERING STUDY BASED UPON CONDITIONS AT EACH LOCATION.
 3. SEE FIGURE A-16 FOR MARKING DETAIL

SIGNING AT TYPE C MEDIAN OPENING

FIGURE B-13

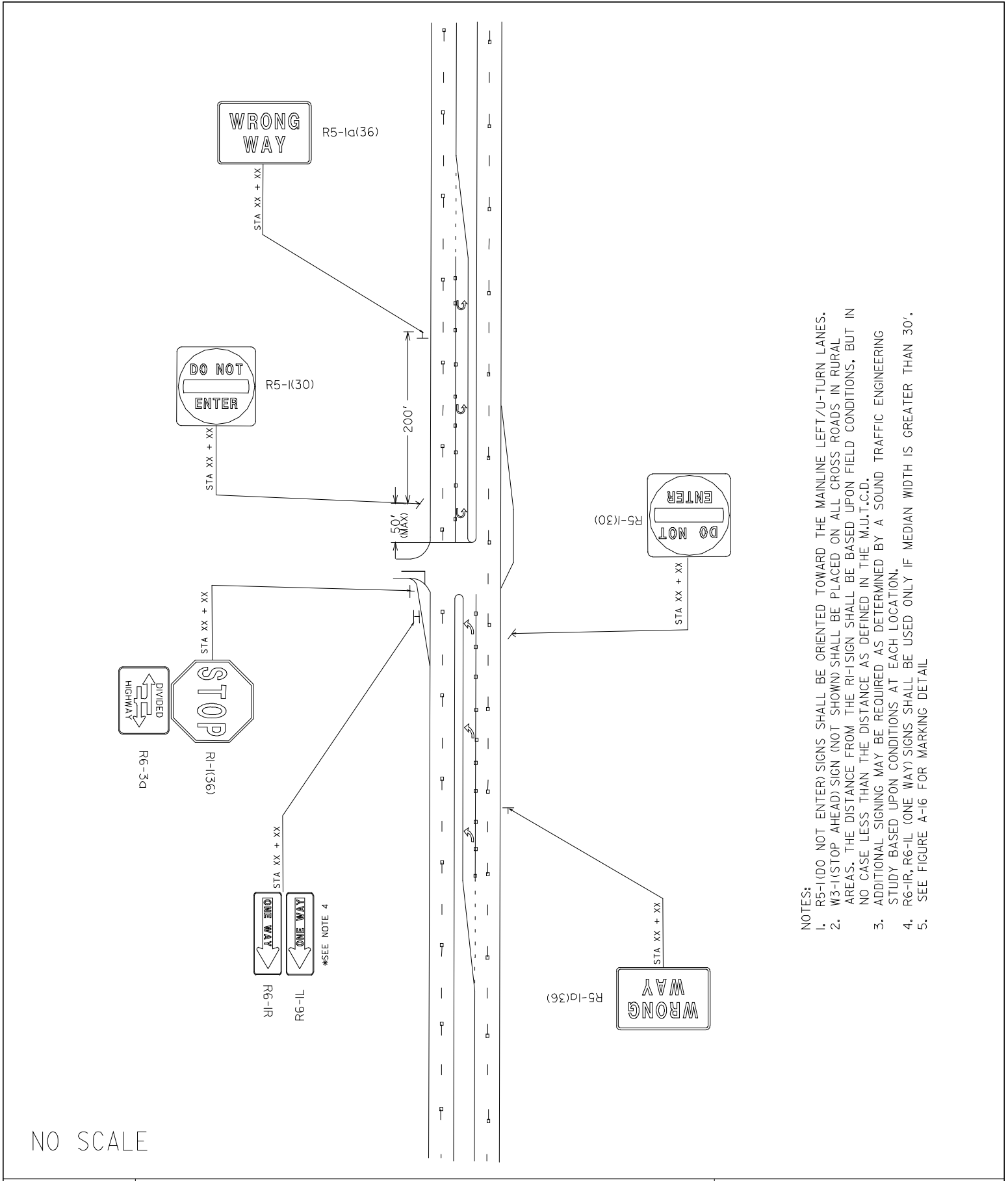

NO SCALE

SIGNING AT TYPE C
MEDIAN "T" INTERSECTION

FIGURE B-14

- NOTES:
1. R5-1(DO NOT ENTER) SIGNS SHALL BE ORIENTED TOWARD THE MAINLINE LEFT/U-TURN LANES.
 2. W3-1(STOP AHEAD) SIGN (NOT SHOWN) SHALL BE PLACED ON ALL CROSS ROADS IN RURAL AREAS. THE DISTANCE FROM THE R1-SIGN SHALL BE BASED UPON FIELD CONDITIONS, BUT IN NO CASE LESS THAN THE DISTANCE AS DEFINED IN THE M.U.T.C.D.
 3. ADDITIONAL SIGNING MAY BE REQUIRED AS DETERMINED BY A SOUND TRAFFIC ENGINEERING STUDY BASED UPON CONDITIONS AT EACH LOCATION.
 4. R6-1R, R6-1L (ONE WAY) SIGNS SHALL BE USED ONLY IF MEDIAN WIDTH IS GREATER THAN 30'.
 5. SEE FIGURE A-16 FOR MARKING DETAIL

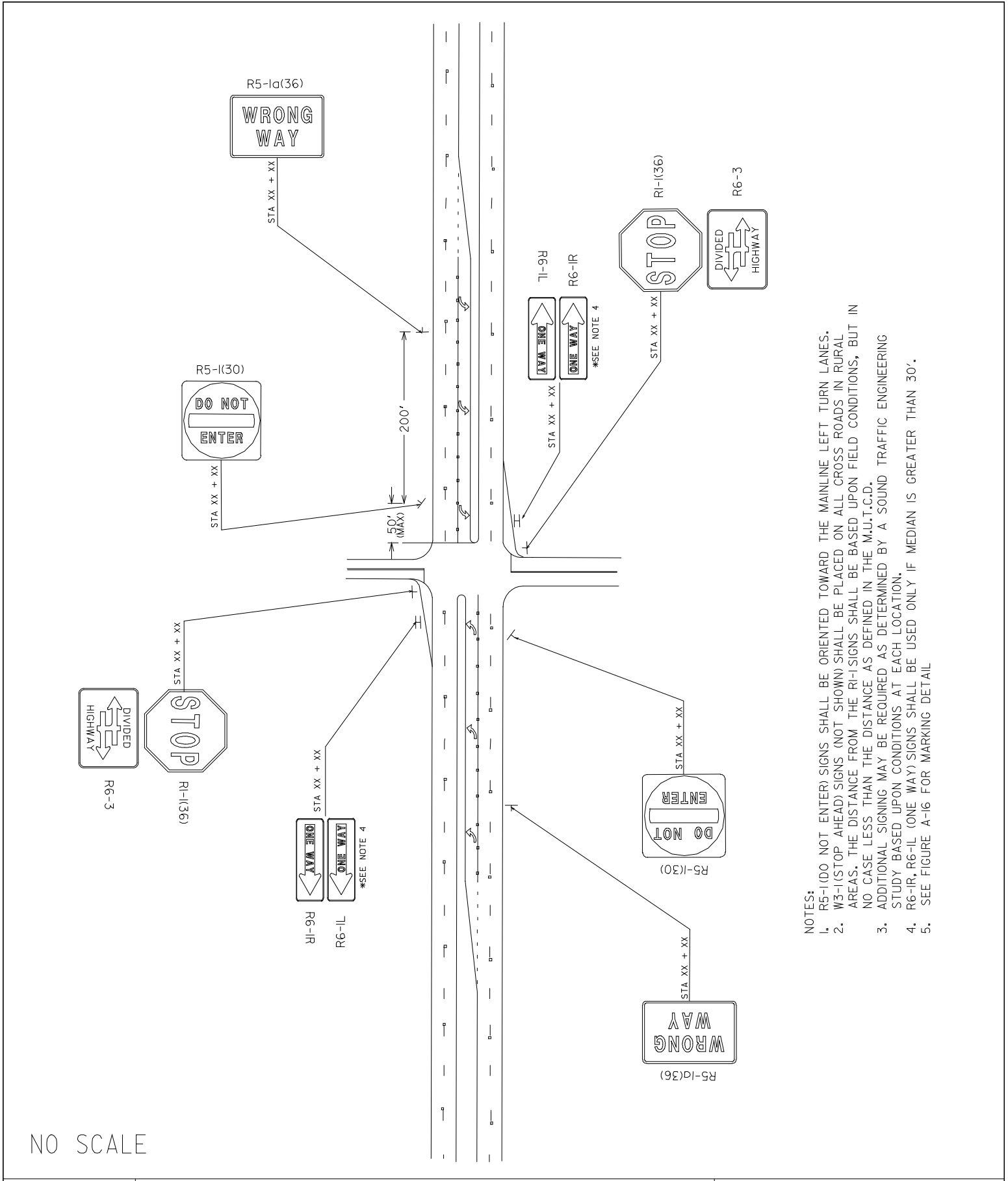

NO SCALE

SIGNING AT TYPE C
MEDIAN CROSS ROAD INTERSECTION

FIGURE B-15

- NOTES:
1. R5-1(DO NOT ENTER) SIGNS SHALL BE ORIENTED TOWARD THE MAINLINE LEFT TURN LANES.
 2. W3-1(STOP AHEAD) SIGNS (NOT SHOWN) SHALL BE PLACED ON ALL CROSS ROADS IN RURAL AREAS. THE DISTANCE FROM THE R1-SIGNS SHALL BE BASED UPON FIELD CONDITIONS, BUT IN NO CASE LESS THAN THE DISTANCE AS DEFINED IN THE M.U.T.C.D.
 3. ADDITIONAL SIGNING MAY BE REQUIRED AS DETERMINED BY A SOUND TRAFFIC ENGINEERING STUDY BASED UPON CONDITIONS AT EACH LOCATION.
 4. R6-IR, R6-IL (ONE WAY) SIGNS SHALL BE USED ONLY IF MEDIAN IS GREATER THAN 30'.
 5. SEE FIGURE A-16 FOR MARKING DETAIL

NO SCALE

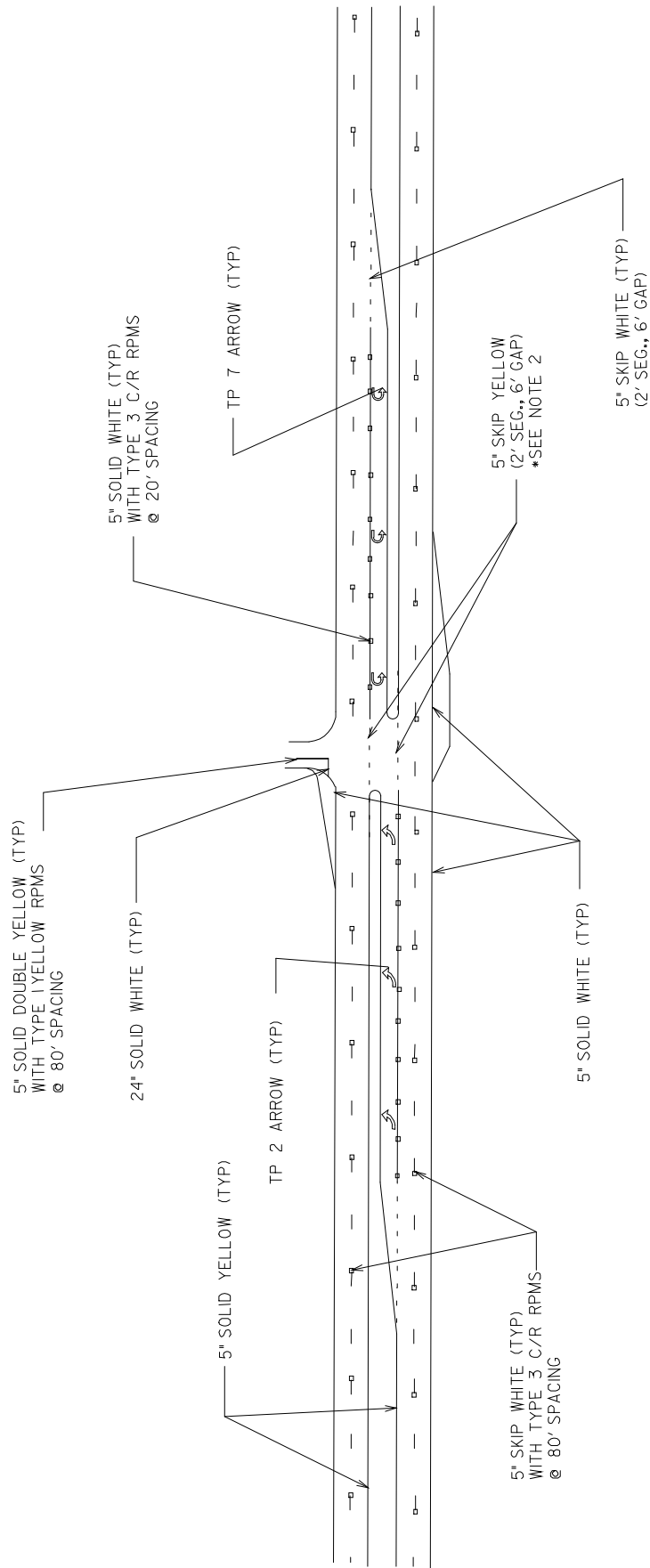

- NOTES:
1. SEE DETAIL T-15 FOR ADDITIONAL GUIDANCE ON RPM PLACEMENT
 2. USE ONLY FOR A U-TURN ONLY MEDIAN OPENING

MARKING AT TYPE C
MEDIAN "T" INTERSECTION

FIGURE B-16

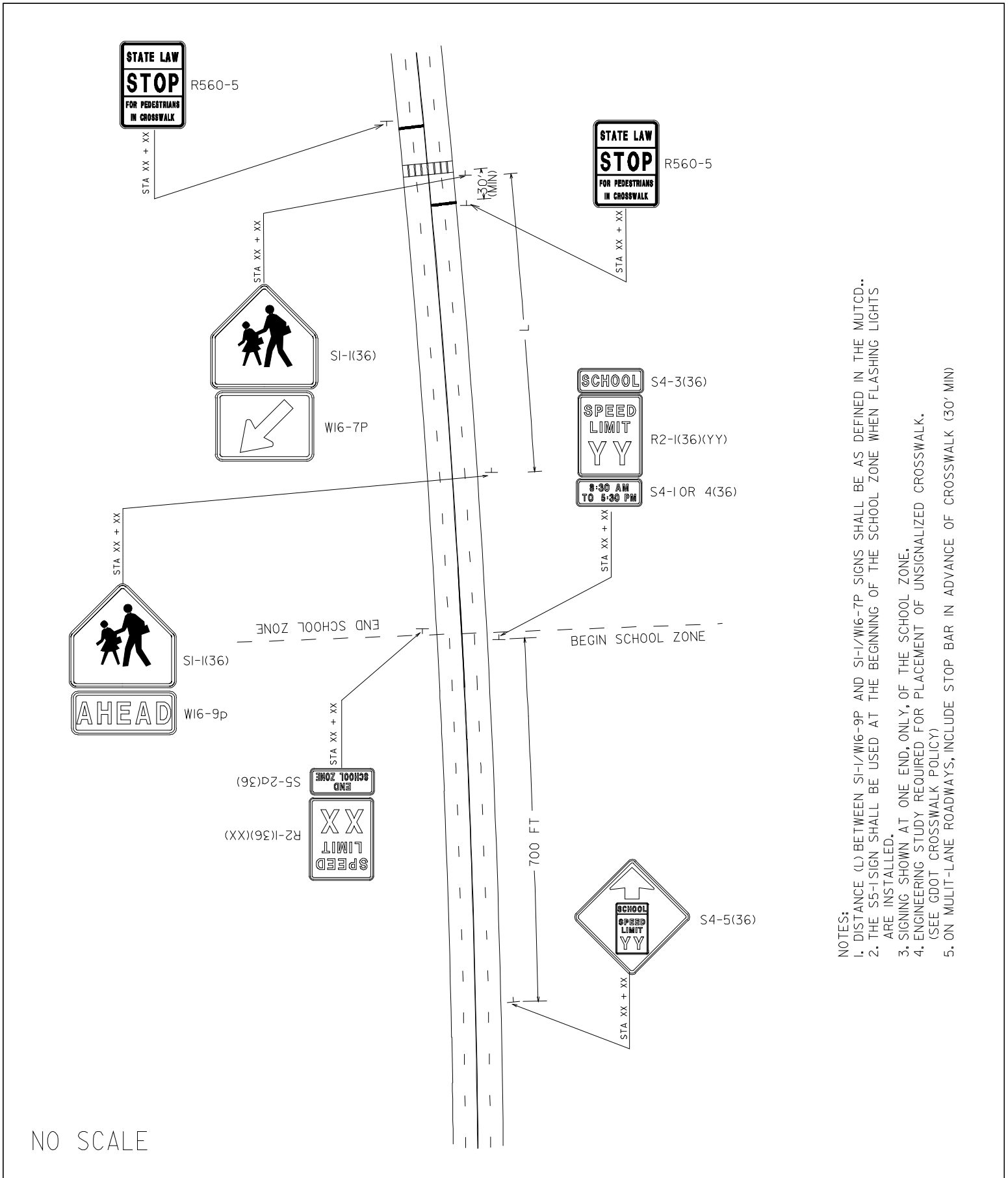

- NOTES:
1. DISTANCE (L) BETWEEN SI-1/W16-9P AND SI-1/W16-7P SIGNS SHALL BE AS DEFINED IN THE MUTCD.
 2. THE S5-1 SIGN SHALL BE USED AT THE BEGINNING OF THE SCHOOL ZONE WHEN FLASHING LIGHTS ARE INSTALLED.
 3. SIGNING SHOWN AT ONE END, ONLY, OF THE SCHOOL ZONE.
 4. ENGINEERING STUDY REQUIRED FOR PLACEMENT OF UNSIGNALIZED CROSSWALK. (SEE GOOT CROSSWALK POLICY)
 5. ON MULTILANE ROADWAYS, INCLUDE STOP BAR IN ADVANCE OF CROSSWALK (30' MIN)

SCHOOL ZONE SIGNING

FIGURE B-17

NO SCALE

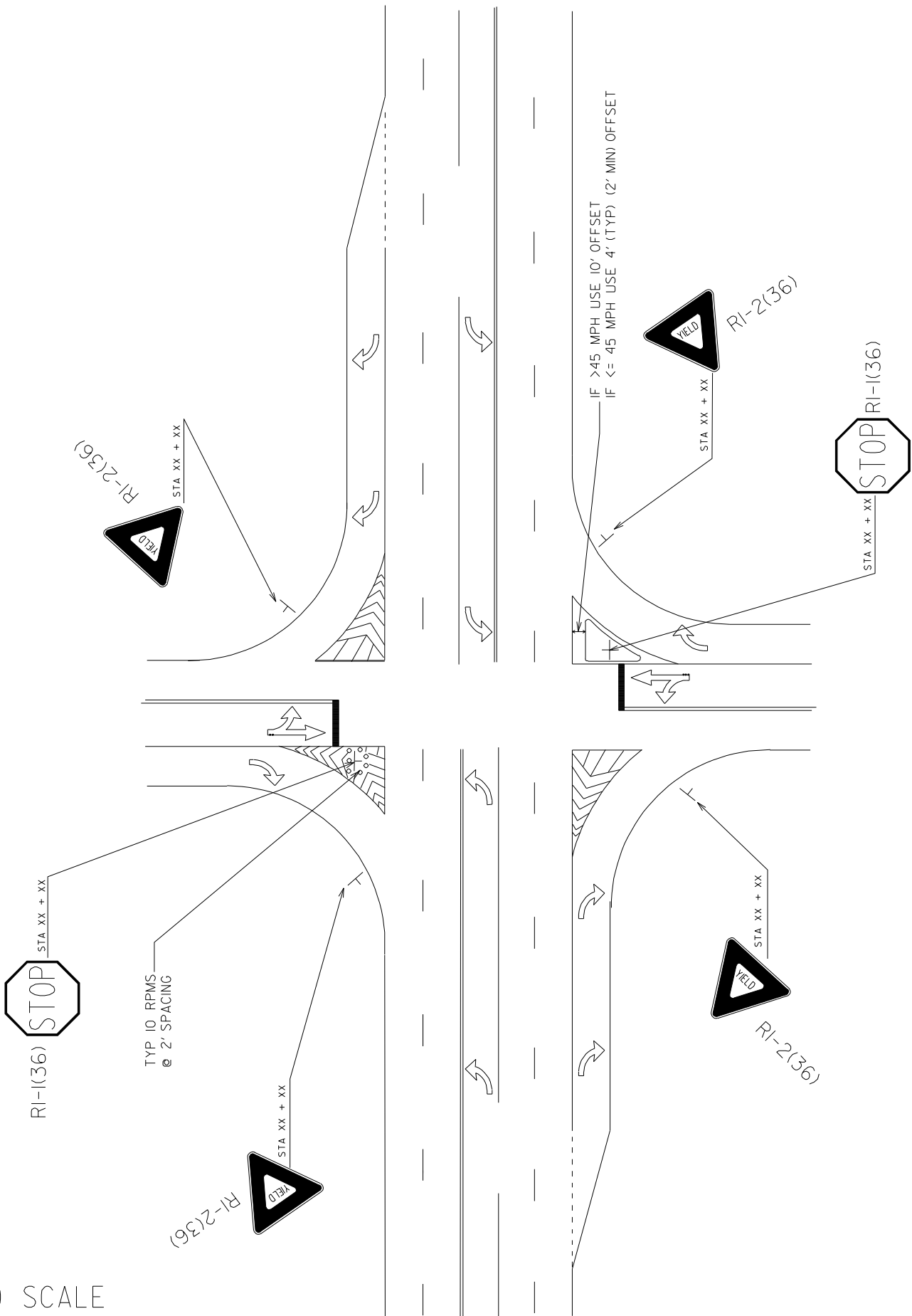

STOP SIGN PLACEMENT DETAIL

FIGURE B-18

NO SCALE

R4-2 (OPT)

PASS WITH CARE

STA XX + XX

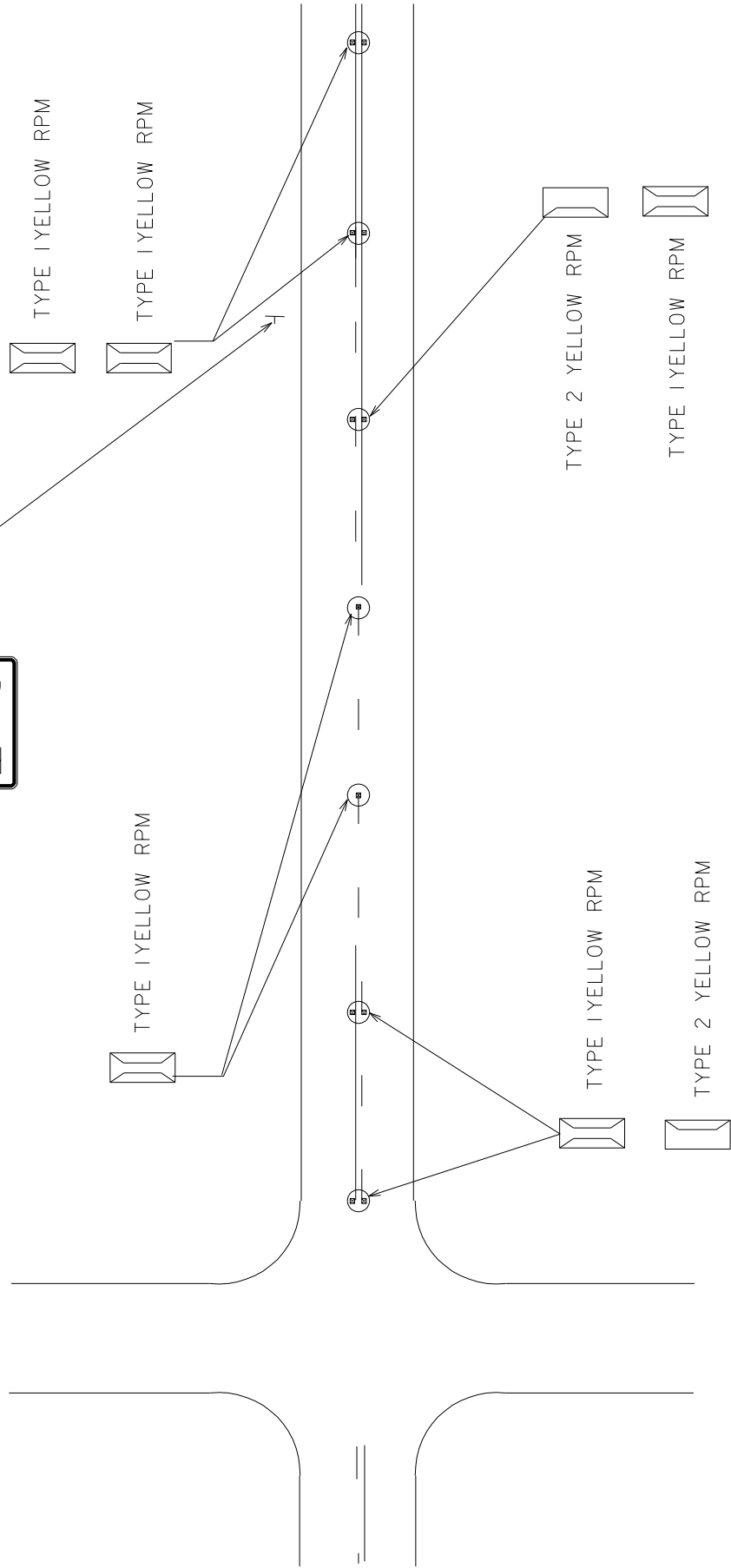

- NOTES:
- 1. SEE DETAIL T-15 FOR ADDITIONAL GUIDANCE ON PLACEMENT AND USAGE OF RPMs
 - 2. PASSING STRIPING NOT SHOWN TO SCALE

TYPICAL RURAL RPM PASSING DETAIL

FIGURE B-19

APPENDIX C – BICYCLE SIGNING AND MARKING

- C-1 Bicycle Lane Signing and Marking (four-lane divided highway)
- C-2 Bicycle Shoulder Signing and Marking
- C-3 Bicycle Lane Signing and Marking (two-lane highway)

NO SCALE

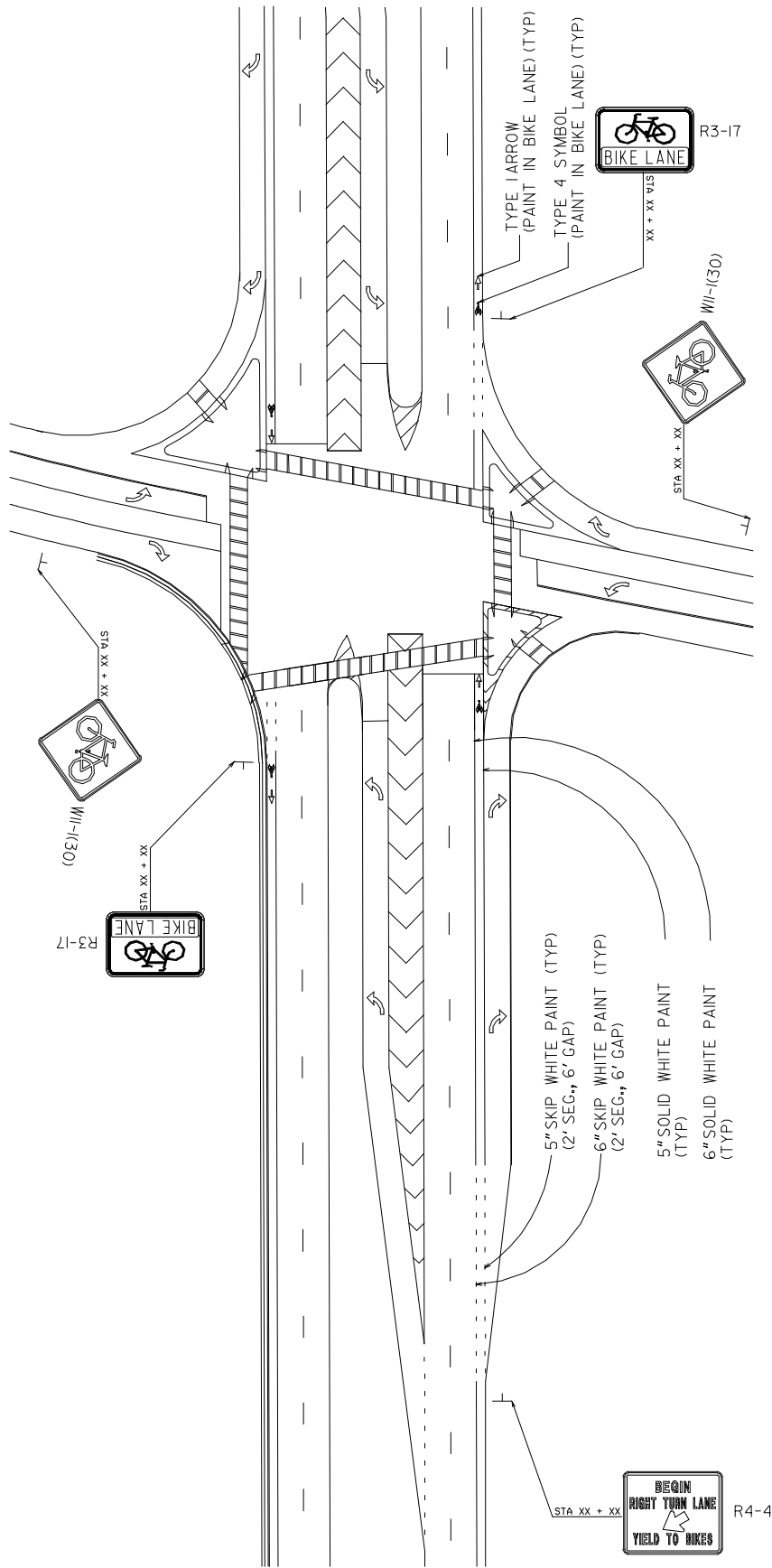

NOTES:

1. ALL BICYCLE LANE PAVEMENT MARKINGS SHALL BE PAINT.
2. ONLY BICYCLE LANE SIGNING SHOWN, PLACE OTHER SIGNS AS REQUIRED.
3. FOR DESIGN AND PLACEMENT OF BICYCLE LANE PAVEMENT SYMBOLS, SEE BICYCLE LANE PAVEMENT MARKING DETAILS.
4. R3-17 SIGNS SHALL BE PLACED ADJACENT TO BICYCLE LANE PAVEMENT SYMBOLS.
5. LOCATION OF W11-1 SIGNS SHALL BE BASED UPON SPEED LIMIT AS DEFINED IN THE M.U.T.C.D.
6. BICYCLE LANE PAVEMENT SYMBOLS AND R3-17 SIGNS SHALL BE PLACED ON THE FAR SIDE EVERY MAJOR INTERSECTION. ON LONG UNINTERRUPTED STRETCHES, R3-17 SIGNS AND BICYCLE LANE PAVEMENT SYMBOLS SHALL BE PLACED NO MORE THAN 5 MILES APART.

BICYCLE LANE SIGNING AND MARKING

FIGURE C-1

NO SCALE

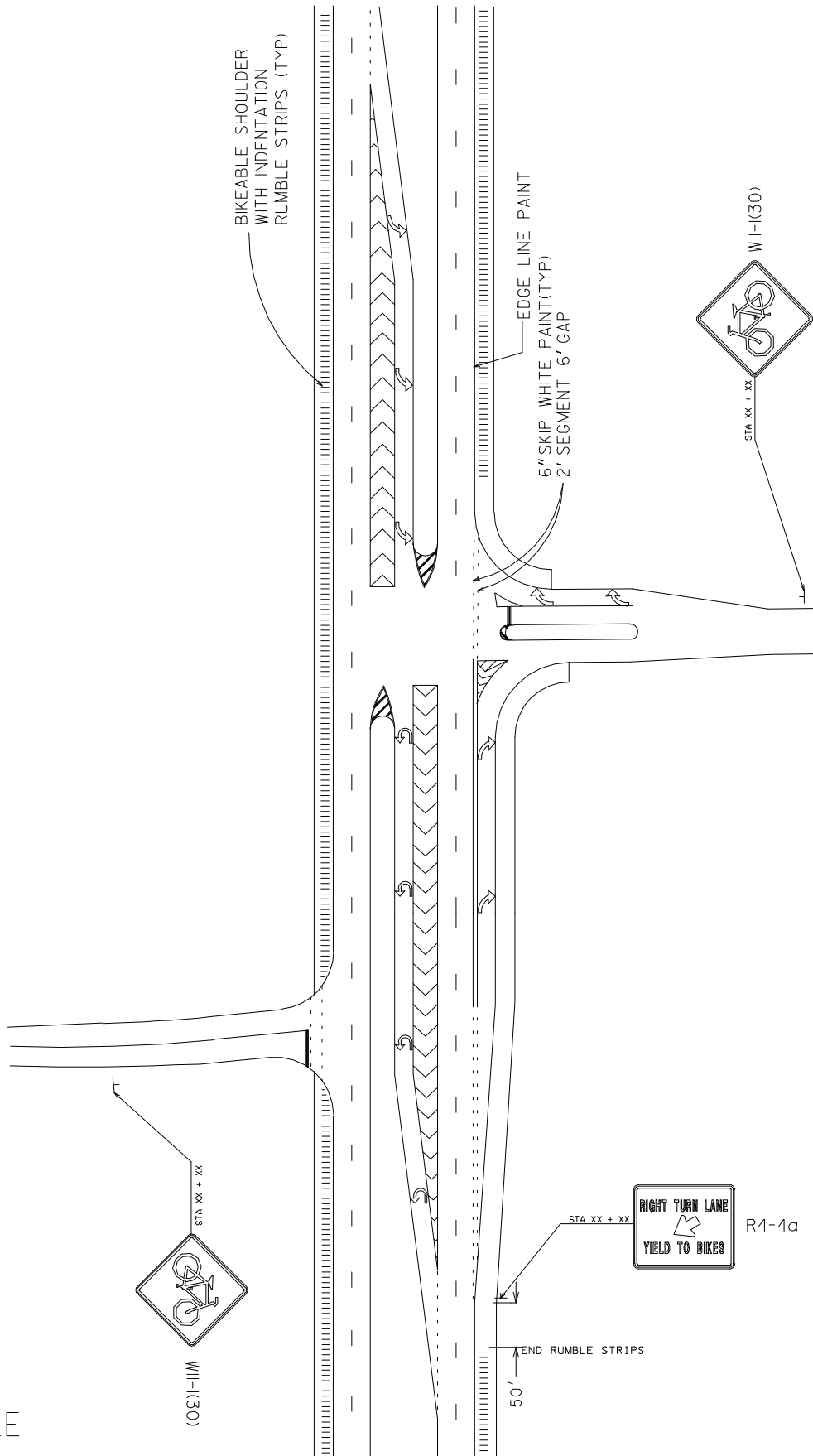

- NOTES:
1. ALL BICYCLE LANE PAVEMENT MARKINGS SHALL BE PAINT.
 2. ONLY BICYCLE LANE SIGNING SHOWN. PLACE OTHER SIGNS AS REQUIRED.
 3. LOCATE THE W11-SIGN BETWEEN THE STOP SIGN AND STOP AHEAD SIGN.

BICYCLE SHOULDER SIGNING AND MARKING

FIGURE C-2

NO SCALE

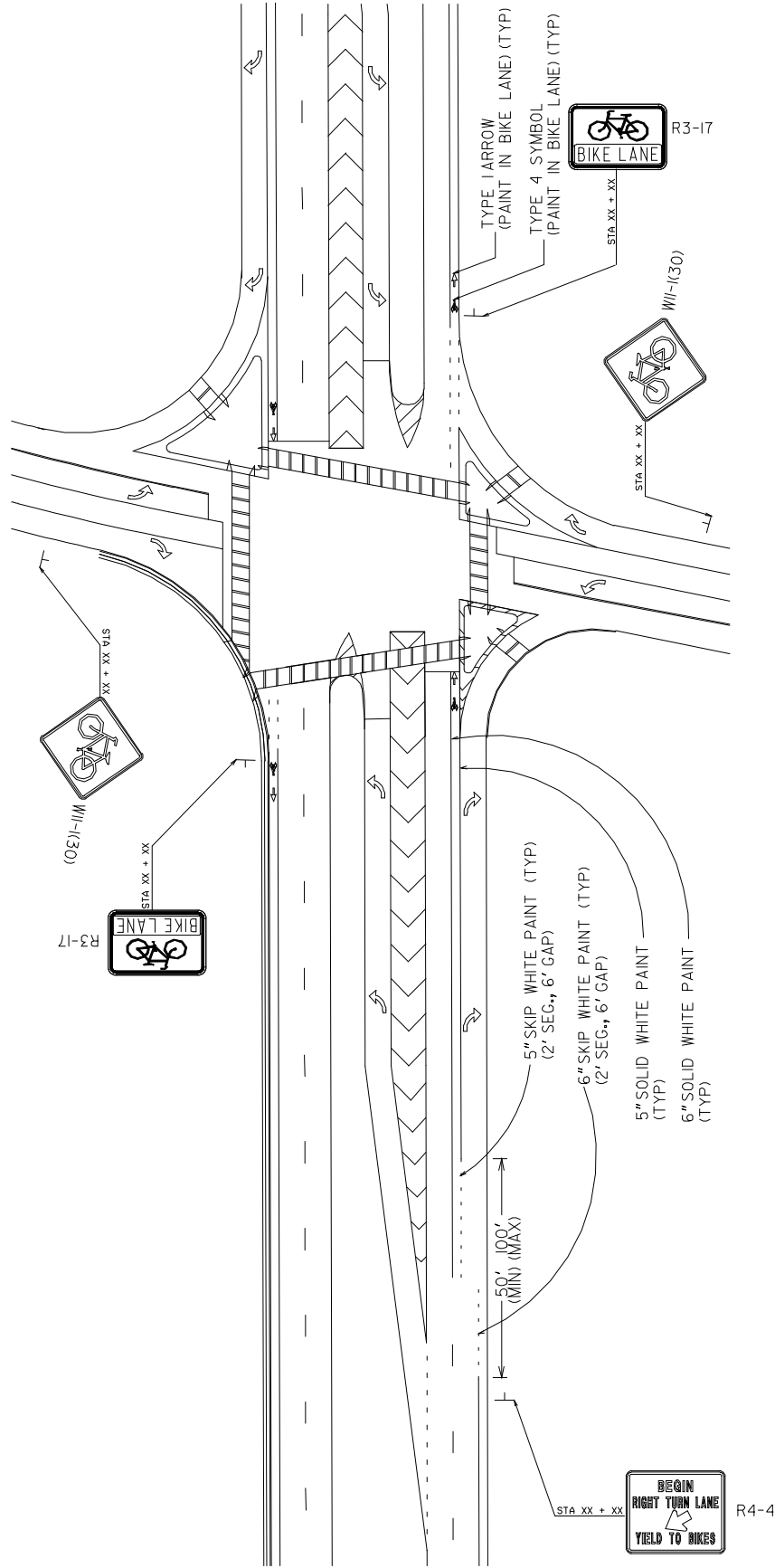

- NOTES:
1. ALL BICYCLE LANE PAVEMENT MARKINGS SHALL BE PAINT.
 2. ONLY BICYCLE LANE SIGNING SHOWN. PLACE OTHER SIGNS AS REQUIRED.
 3. FOR DESIGN AND PLACEMENT OF BICYCLE LANE PAVEMENT SYMBOLS, SEE BICYCLE LANE PAVEMENT MARKING DETAILS.
 4. R3-17 SIGNS SHALL BE PLACED ADJACENT TO BICYCLE LANE PAVEMENT SYMBOLS.
 5. LOCATION OF W11 SIGNS SHALL BE BASED UPON SPEED LIMIT AS DEFINED IN THE M.U.T.C.D.
 6. BICYCLE LANE PAVEMENT SYMBOLS AND R3-17 SIGNS SHALL BE PLACED ON THE FAR SIDE EVERY MAJOR INTERSECTION. ON LONG UNINTERRUPTED STRETCHES, R3-17 SIGNS AND BICYCLE LANE PAVEMENT SYMBOLS SHALL BE PLACED NO MORE THAN 5 MILES APART.

BICYCLE LANE SIGNING AND MARKING

FIGURE C-3

APPENDIX D – SUMMARY OF QUANTITIES

- D-1 Summary of Quantities – Pavement Markings
- D-2 Summary of Quantities – Standard Signs
- D-3 Summary of Quantities – Special Roadside Signs
- D-4 Summary of Quantities – Remove and Remount Special Signs
- D-5 Summary of Quantities – Overhead Highway Signs
- D-6 Summary of Quantities – Remove and Remount Overhead Signs
- D-7 Summary of Quantities – Remove and Reset Logo Signs

SUMMARY OF QUANTITIES-PAVEMENT MARKINGS

LOCATION	RAISED PAVEMENT MARKERS (EACH)													
	REFLECTIVE-RAISED			REFLECTIVE-RECESSED			OPAQUE		JUGGLE BAR		CHANNEL MKR			
	YELLOW	CLEAR	CLEAR/RED	YELLOW	CLEAR	CLEAR/RED	WHITE	YELLOW	TYPE 5	TYPE 6	TYPE 7	TYPE 8	TYPE 9	TYPE 10
STREET NAME 1
STREET NAME 2
STREET NAME 3
STREET NAME 4
STREET NAME 5
STREET NAME 6
TOTALS

NOTES: 1. TYPE 4, 2, AND 3 PAVEMENT MARKERS SHALL BE SPACED AS SPECIFIED ON THE RAISED PAVEMENT MARKERS LOCATION DETAILS.

DESCRIPTION	UNIT	TRAFFIC STRIPE QUANTITY			
		PAINT	THERMOPLASTIC	POLYUREA	PREFORMED
5" SOLID WHITE	LN FEET	#	#	#	#
5" SOLID YELLOW	LN FEET	#	#	#	#
6" SOLID WHITE	LN FEET	#	#	#	#
8" SOLID WHITE	LN FEET	#	#	#	#
10" SOLID WHITE	LN FEET	#	#	#	#
12" SOLID WHITE	LN FEET	#	#	#	#
24" SOLID WHITE	LN FEET	#	#	#	#
5" SOLID WHITE	LN MILE	#	#	#	#
5" SOLID YELLOW	LN MILE	#	#	#	#
5" SKIP WHITE	GR LN FT	#	#	#	#
5" SKIP YELLOW	GR LN FT	#	#	#	#
6" SKIP WHITE	GR LN FT	#	#	#	#
8" SKIP CONTRAST	GR LN FT	#	#	#	#
5" SKIP WHITE	GR LN MILE	#	#	#	#
5" SKIP YELLOW	GR LN MILE	#	#	#	#
8" SKIP CONTRAST	GR LN MILE	#	#	#	#

NOTE: PREFORMED 8" SKIP CONTRAST WILL BE 5" SKIP WHITE STRIPE BETWEEN TWO 1/2" BLACK STRIPES

DESCRIPTION	ARROWS (EACH) QUANTITY	
	PAINT	THERMOPLASTIC
TYPE 1	#	#
TYPE 2	#	#
TYPE 3	#	#
TYPE 4	#	#
TYPE 5	#	#
TYPE 6	#	#
TYPE 7	#	#

DESCRIPTION	SYMBOLS (EACH) QUANTITY	
	PAINT	THERMOPLASTIC
STREET NAME 1	#	#
STREET NAME 2	#	#
STREET NAME 3	#	#
STREET NAME 4	#	#
STREET NAME 5	#	#
STREET NAME 6	#	#
STREET NAME 7	#	#

STRIPE PAINTING (SQ YD) QUANTITY	
WHITE	YELLOW
#	#

DESCRIPTION	WORDS (EACH) QUANTITY	
	PAINT	THERMOPLASTIC
TYPE 1	#	#
TYPE 2	#	#
TYPE 3A	#	#
TYPE 3B	#	#
TYPE 4	#	#
TYPE 5	#	#
TYPE 6	#	#

THERMO TRAF STRIPE (SQ YD) QUANTITY	
WHITE	YELLOW
#	#

DESCRIPTION	UNIT	REM TRAFFIC MARKINGS QUANTITY			
		PAINT	THERMOPLASTIC	POLYUREA	PREFORMED
ARROWS	EA
HATCHING	SY

DESCRIPTION	UNIT	REM TRAFFIC STRIPE QUANTITY	
		PAINT	THERMOPLASTIC
5" SOLID	LN FEET	#	#
10" SOLID	LN FEET	#	#
24" SOLID	LN FEET	#	#
5" SKIP	GR LN FT	#	#
5" SOLID	LN MILE	#	#
5" SKIP	GR LN MILE	#	#

LOCATION	PAVEMENT ARROW W/RAISED REFLECTORS (EACH) QUANTITY	
	PAINT	THERMOPLASTIC
STREET NAME 1	#	#
STREET NAME 2	#	#
STREET NAME 3	#	#
TOTAL	#	#

GEORGIA
DEPARTMENT
OF
TRANSPORTATION

REVISION DATES	STATE OF GEORGIA DEPARTMENT OF TRANSPORTATION OFFICE:
.....	SUMMARY OF QUANTITIES
.....	
.....	
.....	
.....	
.....	
.....	
.....	
.....	
.....	

APPENDIX E – GENERAL NOTES

- E-1 Special Roadway and Overhead Highway Signs General Notes
- E-2 Standard Signs General Notes

GENERAL NOTES - SPECIAL ROADSIDE SIGNS

1. SPECIAL ROADSIDE SIGNS SHALL CONFORM TO THE REQUIREMENTS SET FORTH IN THE MANUAL ON UNIFORM TRAFFIC CONTROL DEVICES, CURRENT EDITION, AND ALL SUPPLEMENTS THERETO, AS WELL AS TO THE GEORGIA STANDARD SPECIFICATIONS AND/OR SPECIAL PROVISIONS.
2. SPECIAL ROADSIDE SIGNS SHALL BE FABRICATED USING ALUMINUM BOLTED EXTRUDED PANELS.
3. BACKGROUND FOR SPECIAL ROADSIDE SIGNS SHALL BE STANDARD INTERSTATE GREEN, TYPE III (ENCAPSULATED LENS), REFLECTIVE SHEETING, UNLESS SPECIFIED OTHERWISE IN THE PLANS.
4. LEGENDS FOR SPECIAL ROADSIDE SIGNS SHALL BE WHITE, TYPE IX (PRISMATIC LENS), REFLECTIVE SHEETING LETTERS, NUMERALS, SYMBOLS, AND BORDERS ON 0.032 INCH ALUMINUM CUTOUTS.
5. SHIELDS SHALL BE 0.08 INCH ALUMINUM OF THE SIZE AND SHAPE SPECIFIED IN THE PLANS. U.S. AND GEORGIA SHIELD LEGENDS SHALL BE BLACK NUMERALS AND LETTERS SILK SCREENED ON WHITE, TYPE IX (PRISMATIC LENS), REFLECTIVE SHEETING BACKGROUNDS WITH NO BORDERS. INTERSTATE SHIELDS SHALL BE PER THE MANUAL ON UNIFORM TRAFFIC CONTROL DEVICES, CURRENT EDITION.
6. FOR DETAILS OF U.S. AND INTERSTATE SHIELDS AND ARROWS, REFER TO THE MANUAL ON UNIFORM TRAFFIC CONTROL DEVICES, CURRENT EDITION.
7. LEGENDS FOR SPECIAL ROADSIDE SIGNS SHALL BE FASTENED TO SIGN PANELS WITH ALUMINUM PULL-THROUGH BLIND RIVETS OR WITH AN APPROVED NON-CORROSIVE FASTENER.
8. SPACING BETWEEN LETTERS OR OTHER CHARACTERS THAT IS NOT SHOWN IN THE PLANS MAY BE RECOMMENDED BY THE MANUFACTURER, BUT SHALL CONFORM TO INTERSTATE SIGNING REQUIREMENTS.
9. FOR ASSEMBLY DETAILS AND ASSEMBLY COMPONENTS DETAILS ON ALUMINUM BOLTED EXTRUDED PANELS, REFER TO GEORGIA STANDARDS 9041 AND 9042.
10. FOR DETAILS OF SPECIAL ROADSIDE SIGNS SEE DETAILS OF SPECIAL ROADSIDE SIGNS.
11. SIGN ERECTION STATIONS ARE APPROXIMATE AND MAY BE ADJUSTED TO MEET FIELD CONDITIONS WHERE NECESSARY, BUT SHALL BE WITHIN THE LIMITATIONS SET FORTH IN THE MANUAL ON UNIFORM TRAFFIC CONTROL DEVICES, CURRENT EDITION. NO SIGN LOCATION SHALL BE CHANGED BY THE CONTRACTOR OR BY THE PROJECT ENGINEER WITHOUT PRIOR APPROVAL FROM THE DISTRICT 7 OFFICE OF TRAFFIC OPERATIONS.
12. HORIZONTAL CLEARANCE FOR SPECIAL ROADSIDE SIGNS SHALL BE 32 FEET FROM THE NORMAL EDGE OF PAVEMENT TO THE NEAR EDGE OF THE SIGN UNLESS SPECIFIED OTHERWISE IN THE PLANS.
13. SPECIAL ROADSIDE SIGNS ERECTED ON STEEP CUT SLOPES SHALL HAVE A MINIMUM CLEARANCE OF 10 FEET ABOVE THE GROUNDLINE AND MAXIMUM HEIGHT OF 10 FEET ABOVE THE NORMAL EDGE OF PAVEMENT TO THE BOTTOM OF THE SIGN.
14. EXIT GORE SIGNS SHALL BE ERECTED WITHIN A RANGE OF 25 FEET MINIMUM TO 100 FEET MAXIMUM FROM THE PHYSICAL NOSE OF THE RAMP. A MINIMUM CLEARANCE OF 2 FEET FROM THE EDGES OF THE RAMP AND MAINLINE PAVED SHOULDERS TO THE RIGHT AND LEFT EDGES OF THE SIGN, RESPECTIVELY SHALL BE MAINTAINED.
15. POST LENGTHS, POST SIZES, AND FOOTING SIZES FOR SPECIAL ROADSIDE SIGNS ARE ESTIMATED, ONLY. IT SHALL BE THE RESPONSIBILITY OF THE CONTRACTOR TO DETERMINE THE CORRECT LENGTHS AND SIZES ACCORDING TO GEORGIA STANDARDS PRIOR TO ORDERING MATERIALS. FOR ERECTION AND FOUNDATION DETAILS FOR SPECIAL ROADSIDE SIGNS WITH BREAK-AWAY POSTS, REFER TO GEORGIA STANDARDS 9054A, 9054B, AND 9054C.
16. GALVANIZED STEEL I-BEAMS SHALL HAVE ALL IDENTIFICATION NUMBERS RE-ESTABLISHED AFTER COMPLETION OF GALVANIZING.
17. FOR BREAK-AWAY POSTS THE CONTRACT BID PRICE FOR CLASS "A" CONCRETE SHALL INCLUDE THE COST OF FURNISHING AND PLACING REINFORCEMENT STEEL AND STUB POSTS AS SHOWN IN THE FOOTING DETAILS ON GEORGIA STANDARD 9054A.
18. THE NEAR EDGE OF SIGNS ERECTED BEHIND GUARD RAIL SHALL BE 6 FEET BEHIND THE FACE OF THE GUARD RAIL.
19. THE CONTRACTOR SHALL ENSURE THAT ALL SPECIAL ROADSIDE SIGNS INSTALLED BY THIS PROJECT HAVE A MINIMUM SIGHT DISTANCE OF 1000 FEET. CLEARING OF OBSTACLES TO OBTAIN THE MINIMUM SIGHT DISTANCE SHALL BE IN ACCORDANCE WITH SECTION 201 OF THE GEORGIA STANDARD SPECIFICATIONS. THE COST FOR THIS WORK SHALL BE INCLUDED IN THE OVERALL PRICE BID FOR THE PROJECT.
20. BREAK-AWAY POSTS MARKED WITH AN (M) ARE SPECIAL DESIGN. THE CONTRACTOR SHALL NOT CHANGE THESE POSTS IN ANY WAY WITHOUT APPROVAL FROM THE DISTRICT 7 OFFICE OF TRAFFIC OPERATIONS.

GENERAL NOTES - OVERHEAD HIGHWAY SIGNS

1. OVERHEAD HIGHWAY SIGNS SHALL CONFORM TO THE REQUIREMENTS SET FORTH IN THE MANUAL ON UNIFORM TRAFFIC CONTROL DEVICES, CURRENT EDITION, AND ALL SUPPLEMENTS THERETO, AS WELL AS TO THE GEORGIA STANDARD SPECIFICATIONS AND/OR SPECIAL PROVISIONS.
2. OVERHEAD HIGHWAY SIGNS SHALL BE FABRICATED WITH ALUMINUM BOLTED EXTRUDED PANELS.
3. BACKGROUNDS FOR OVERHEAD HIGHWAY SIGNS SHALL BE STANDARD INTERSTATE GREEN, TYPE III (ENCAPSULATED LENS) REFLECTIVE SHEETING, UNLESS SPECIFIED OTHERWISE IN THE PLANS.
4. LEGENDS FOR OVERHEAD HIGHWAY SIGNS SHALL BE WHITE, TYPE IX (PRISMATIC LENS) REFLECTIVE SHEETING LETTERS, NUMERALS, SYMBOLS, AND BORDERS ON 0.032 INCH ALUMINUM CUTOUTS.
5. SHIELDS SHALL BE 0.08 INCH ALUMINUM OF THE SIZE AND SHAPE SPECIFIED IN THE PLANS. U.S. AND GEORGIA SHIELD LEGENDS SHALL BE BLACK NUMERALS AND LETTERS SILK SCREENED ON WHITE, TYPE IX (PRISMATIC LENS) REFLECTIVE SHEETING BACKGROUNDS WITH NO BORDERS. INTERSTATE SHIELDS SHALL BE PER THE MANUAL ON UNIFORM TRAFFIC CONTROL DEVICES, CURRENT EDITION.
6. FOR DETAILS OF U.S. AND INTERSTATE SHIELDS AND ARROWS, REFER TO THE MANUAL ON UNIFORM TRAFFIC CONTROL DEVICES, CURRENT EDITION.
7. LEGENDS FOR OVERHEAD HIGHWAY SIGNS SHALL BE FASTENED TO SIGN WITH ALUMINUM PULL-THROUGH BLIND RIVETS OR WITH AN APPROVED NON-CORROSIVE FASTENER.
8. SPACING BETWEEN LETTERS OR OTHER CHARACTERS THAT IS NOT SHOWN IN THE PLANS MAY BE RECOMMENDED BY THE MANUFACTURER, BUT SHALL CONFORM TO INTERSTATE SIGNING REQUIREMENTS.
9. YELLOW OVERLAYS SHALL BE 0.08 INCH ALUMINUM OF THE SIZE SPECIFIED IN THE PLANS. LEGENDS SHALL BE BLACK LETTERS, NUMERALS, AND SYMBOLS SILK SCREENED ON STANDARD INTERSTATE YELLOW, TYPE III (ENCAPSULATED LENS) REFLECTIVE SHEETING BACKGROUNDS. SEE GENERAL NOTE NO. 4 FOR BORDER. SIGN PANELS BEHIND YELLOW OVERLAYS SHALL BE THE SAME COLOR AS THE REST OF THE SIGN.
10. ALL OVERHEAD STRUCTURES SHALL BE DESIGNED FOR EXTERNAL ILLUMINATION. ALTHOUGH ILLUMINATION IS NOT REQUIRED ON THIS PROJECT, FOR SPECIFICATIONS ON STRUCTURAL SUPPORTS FOR OVERHEAD HIGHWAY SIGNS, SEE SECTION 638 OF THE GEORGIA STANDARD SPECIFICATIONS AND SUPPLEMENTS THERETO.
11. STRUCTURE NUMBER SHALL BE PLACED ON OUTSIDE SHOULDER VERTICAL SUPPORT OF STRUCTURE USING DIE CUT, 6 INCH SERIES "D," WHITE, TYPE I (ENCLOSED LENS) REFLECTIVE SHEETING CHARACTERS ON STANDARD INTERSTATE GREEN, TYPE I (ENCLOSED LENS) REFLECTIVE SHEETING. THE STRUCTURE NUMBER, WHICH SHALL READ FROM TOP TO BOTTOM, SHALL BE PLACED AT EYE LEVEL AND POSITIONED SO THAT IT IS VISIBLE TO ONCOMING TRAFFIC. COAT AREA WHERE STRUCTURE NUMBER IS TO BE PLACED WITH PRIMER AND ALLOW TO DRY BEFORE PLACING STRUCTURE NUMBER.

ON TYPE VII STRUCTURES, STRUCTURE NUMBER SHALL BE PLACED ON TYPE 1 ALUMINUM SIGN MATERIAL WITH GREEN, ENGINEERING GRADE, REFLECTIVE SHEETING BACKGROUND AND ATTACHED TO BRIDGE PIER ON OUTSIDE SHOULDER IN THE SAME ORIENTATION AS ABOVE.
12. FOR ASSEMBLY DETAILS AND ASSEMBLY COMPONENTS DETAILS ON ALUMINUM BOLTED EXTRUDED PANELS, REFER TO GEORGIA STANDARDS 9041 AND 9042.
13. ANCHOR BOLTS SHALL MEET THE REQUIREMENTS OF ASSHTO M 314 GRADE 55.
14. THE RESPONSIBILITY TO DETERMINE THAT THE SPAN LENGTHS SHOWN ON THE PLANS ARE CORRECT AND TO DETERMINE THE ELEVATION OF THE HIGHEST POINT OF THE PAVEMENT OR SHOULDER AND OF THE GROUNDLINE AT THE CENTERLINE OF EACH VERTICAL SUPPORT FOR ALL OVERHEAD STRUCTURES PRIOR TO THEIR DESIGN AND FABRICATION SHALL BE THE CONTRACTOR'S.
15. SHORING SHALL BE INCLUDED AT NO COST TO THE DEPARTMENT IF REQUIRED FOR FOOTING CONSTRUCTION ON SIGN PROJECTS WITH NO ROADWAY CONSTRUCTION.
16. IT SHALL BE THE CONTRACTOR'S RESPONSIBILITY TO AVOID ANY INTERFERENCE WITH UNDERGROUND UTILITIES. ANY DAMAGE TO UTILITIES CAUSED BY THE CONTRACTOR SHALL BE REPAIRED AT THE CONTRACTOR'S EXPENSE. CONTRACTOR SHALL CALL 811 PRIOR TO ANY DIGGING.
17. COST FOR ANY REQUIRED TEMPORARY EROSION CONTROL SHALL BE INCLUDED IN PRICE BID FOR SIGN STRUCTURE.
18. ANY TREES, SHRUBS, OR FLOWERS THAT ARE DAMAGED DURING INSTALLATION OF NEW SIGN STRUCTURES SHALL BE REPLACED IN KIND AT NO ADDITIONAL COST TO THE DEPARTMENT IN ACCORDANCE WITH SECTION 702 OF THE GEORGIA STANDARD SPECIFICATIONS, EXCEPT THAT SECTION 702.17 SHALL NOT APPLY TO THIS PROJECT.
19. CONTRACTOR SHALL ENSURE THAT ALL OVERHEAD SIGNS INSTALLED BY THIS PROJECT HAVE MINIMUM SIGHT DISTANCE OF 1000 FEET. CLEARING OF OBSTACLES TO OBTAIN THE MINIMUM SIGHT DISTANCE SHALL BE IN ACCORDANCE WITH SECTION 201 OF THE GEORGIA STANDARD SPECIFICATIONS. THE COST FOR THIS WORK SHALL BE INCLUDED IN THE OVERALL PRICE BID FOR THE PROJECT.

GEORGIA
DEPARTMENT
OF
TRANSPORTATION

- NO SCALE -

DATE	REVISIONS

STATE OF GEORGIA
DEPARTMENT OF TRANSPORTATION
OFFICE: TRAFFIC OPERATIONS
SIGNING AND MARKING PLANS

OVERHEAD / SPECIAL SIGNS
GENERAL NOTES

DRAWING No. 4 -

GENERAL NOTES - STANDARD SIGNS

1. ALL STANDARD HIGHWAY SIGNS SHALL BE FABRICATED AND ERECTED IN ACCORDANCE WITH THE DETAILS SHOWN IN THE PLANS, THE MANUAL ON UNIFORM TRAFFIC CONTROL DEVICES, CURRENT EDITION, AND THE GEORGIA SPECIFICATIONS, SUPPLEMENTAL SPECIFICATIONS, AND/OR SPECIAL PROVISIONS.
2. SIGN ERECTION STATIONS ARE APPROXIMATE AND MAY BE ADJUSTED TO MEET FIELD CONDITIONS WHERE NECESSARY, BUT SHALL BE WITHIN THE LIMITATIONS SET FORTH IN THE MANUAL ON UNIFORM TRAFFIC CONTROL DEVICES, CURRENT EDITION. NO SIGN LOCATION SHALL BE CHANGED BY THE CONTRACTOR OR BY THE PROJECT ENGINEER WITHOUT PRIOR APPROVAL FROM THE OFFICE OF TRAFFIC SAFETY AND DESIGN.
3. ALL STANDARD HIGHWAY SIGNS SHALL BE ERECTED AT A HEIGHT OF 7 FEET ABOVE THE NORMAL EDGE OF PAVEMENT TO THE BOTTOM OF THE SIGN OR ASSEMBLY.
- 4a. HORIZONTAL CLEARANCE FOR STANDARD HIGHWAY SIGNS ON INTERSTATE HIGHWAYS SHALL BE 32 FEET FROM THE NORMAL EDGE OF PAVEMENT TO THE NEARER EDGE OF THE SIGN(S), UNLESS SPECIFIED OTHERWISE IN THE PLANS. HORIZONTAL CLEARANCE FOR STANDARD HIGHWAY SIGNS ON RAMP SHALL BE 2 FEET FROM THE NORMAL EDGE OF PAVED SHOULDER, OR EDGE OF GRADED SHOULDER WHEN PRESENT.
- 4b. HORIZONTAL CLEARANCE FOR STANDARD HIGHWAY SIGNS ON ALL OTHER ROADWAYS SHALL BE 6 FEET FROM THE EDGE OF THE PAVED SHOULDER OR 12 FEET FROM THE NORMAL EDGE OF PAVEMENT TO THE NEARER EDGE OF THE SIGN(S), WHICHEVER IS GREATER. THE HORIZONTAL CLEARANCE IN NON-MOUNTABLE CURB SECTIONS SHALL BE AT LEAST 2 FEET FROM THE CURB FACE TO THE NEARER EDGE OF THE SIGN(S).
- 4c. HORIZONTAL CLEARANCE FOR STANDARD HIGHWAY SIGNS MOUNTED BEHIND GUARD RAIL SHALL BE 6 FEET FROM THE FACE OF THE GUARD RAIL TO THE NEARER EDGE OF THE SIGN(S).
5. SINGLE PLATE, HORIZONTAL RECTANGULAR SIGNS OVER 48 INCHES IN WIDTH SHALL BE MOUNTED ON TWO POSTS WITH 2 EACH 2 INCH x 1/2 INCH x (WIDTH OF SIGN) ALUMINUM OR GALVANIZED STEEL STRAPS. THE STRAPS SHALL BE FLUSH WITH THE BACK OF THE SIGN WITH ONE EACH ACROSS THE TOP AND BOTTOM OF THE SIGN. THE CENTERLINE OF EACH POST SHALL BE INSET 1/6TH OF THE SIGN WIDTH FROM THE EDGE OF THE SIGN. SIGN PLATE BOLT HOLES SHALL BE 3/8 INCH DIAMETER, DRILLED OR PUNCHED, AS SHOWN ON THE SIGN PLATE DETAILS.
6. EACH 42 OR 48 INCH WIDE x 18 OR 24 INCH HIGH SIGN REQUIRES ONE 2 INCH x 1/2 INCH x (WIDTH OF SIGN) ALUMINUM OR GALVANIZED STEEL STRAP LOCATED IN THE CENTER OF THE SIGN AND FLUSH WITH THE BACK OF THE SIGN.
7. SIGN ASSEMBLIES SHALL BE MOUNTED ON ALUMINUM OR GALVANIZED STEEL STRAP FRAMES. FOR DETAILS AND STRAP SPECIFICATIONS REFER TO SIGN ASSEMBLY-TYPICAL FRAMING DETAILS.
8. TYPE 3 (ENCAPSULATED LENS) REFLECTIVE SHEETING SHALL BE USED FOR ALL STANDARD HIGHWAY SIGNS REQUIRING REFLECTORIZED BACKGROUNDS EXCEPT AS SPECIFIED BELOW OR SPECIFIED OTHERWISE IN THE PLANS. EITHER CLASS 1 OR CLASS 2 ADHESIVE BACKING IS PERMISSIBLE.
9. TYPE 9 (VERY HIGH INTENSITY) REFLECTIVE SHEETING SHALL BE USED FOR ALL RED SERIES SIGNS (R1-1, R1-2, R1-3A, R1-4A, R5-1, R5-1A).
10. TYPE 9 (VERY HIGH INTENSITY) FLUORESCENT YELLOW GREEN REFLECTIVE SHEETING SHALL BE USED FOR SCHOOL ZONE (S1-1, S2-1, S3-1, S4-3, AND THE TOP PORTION OF THE S5-1) SIGNS, BICYCLE CROSSING (W11-1) SIGNS, AND PEDESTRIAN CROSSING (W11-2 AND W11A-2) SIGNS. SIGNS WITHIN THE SAME ASSEMBLY AS THE SCHOOL ZONE SIGNS SPECIFICALLY LISTED ABOVE AND ALL REGULATORY SIGNS PLACED AS PART OF THE SCHOOL ZONE SIGNING SHALL HAVE TYPE IX (VERY HIGH INTENSITY) REFLECTIVE SHEETING BACKGROUNDS OF THE APPROPRIATE COLOR.
11. TYPE 9 (VERY HIGH INTENSITY) FLUORESCENT YELLOW REFLECTIVE SHEETING SHALL BE USED FOR ALL WARNING SIGNS.
12. A 1/2 INCH MINIMUM AIR SPACE SHALL BE REQUIRED BETWEEN ALL SIGN PLATES WITHIN AN ASSEMBLY.
13. WHERE SIGNS WITHIN AN ASSEMBLY EXTEND BELOW THE STANDARD MOUNTING HOLES ON THE POST(S), ADDITIONAL 3/8 INCH DIAMETER HOLE(S), DRILLED OR PUNCHED, SHALL BE REQUIRED TO PROPERLY MOUNT THE ASSEMBLY.
14. INTERSTATE SHIELDS SHALL CONTAIN THE WORD GEORGIA. ALL INTERSTATE, U.S., AND GEORGIA SHIELDS REQUIRING ALT, BUS, CONN, LOOP, OR SPUR SHALL USE 4 INCH SERIES "D" LETTERS. REFER TO THE MANUAL ON UNIFORM TRAFFIC CONTROL DEVICES, CURRENT EDITION, FOR DETAILS.
15. FOR DETAILS OF SPECIAL DESIGN HIGHWAY SIGNS, SEE DETAILS OF MISCELLANEOUS SIGNS.
16. REFER TO PLAN SHEETS FOR LOCATION OF THE DISTRICT ENGINEERS' OFFICE TO BE SHOWN ON ALL R552-1 (LIMITED ACCESS) SIGNS IN THIS PROJECT, IF ANY.
17. THE CONTRACTOR WILL, AS REQUESTED BY THE DISTRICT TRAFFIC OPERATIONS ENGINEER, BE REQUIRED TO REMOVE ANY EXISTING SIGNS THAT ARE DUPLICATED OR ARE CONTRARY TO THESE SIGN PLANS.

GEORGIA
DEPARTMENT
OF
TRANSPORTATION

- NO SCALE -

DATE	REVISIONS

STATE OF GEORGIA
DEPARTMENT OF TRANSPORTATION
OFFICE OF TRAFFIC SAFETY & DESIGN
SIGNING AND MARKING PLANS

STANDARD SIGNS
GENERAL NOTES

JULY 2002

APPENDIX F – FIGURES

Figure 2-1	Example Sign Detail Sheet
Figure 3-1	State Line Signing Sequence (Non-Limited Access)
Figure 3-2	Route Signing for Turning Route
Figure 3-3	Route Signing at “T” Intersection
Figure 3-4	Route Signing at Crossing Routes
Figure 3-5	Details of Destination Signs
Figure 3-6	Details of Mileage Signs
Figure 3-7	Details of Road Name Signs
Figure 3-8	Details of Political Boundary Signs
Figure 3-9	Overhead Signing
Figure 4-1	Normal Exit Sign Sequence
Figure 4-2	Post Interchange Sign Sequence
Figure 4-3	Political Boundary Signing
Figure 4-4	All Thru Trucks Sign Details
Figure 4-5	Details of Regulatory Signs
Figure 4-6	Details of Regulatory Signs
Figure 5-1R	Lane Reduction Signing
Figure 5-1L	Lane Reduction Signing
Figure 5-2	Lane Drop Signing (Continuous Lane)
Figure 5-3	Lane Drop Signing (Auxiliary Lane)
Figure 5-4	Lane Drop Signing (Drop Option)
Figure 6-1	Details of Warning Signs
Figure 6-2	Type 7, 8, and 9 Square Tube Post Installation
Figure 6-3	Details of Square Tube Post (Breakaway Sign Support)
Figure 6-4	Details of Sign Plates
Figure 7-1	Details of Bridge Attachment
Figure 7-2	Details of Rideshare Signs
Figure 9-1	Overhead Sign Structure Numbering
Figure 10-1	Clearance Diagram
Figure 10-2	Clearance Diagram
Figure 10-3	Clearance Diagram
Figure 10-4	Clearance Diagram
Figure 10-5	Concrete Median Barrier Details of Type 26 (for Sign Supports)
Figure 10-6	Concrete Median Barrier Details of Type 26S (for Sign Supports)