

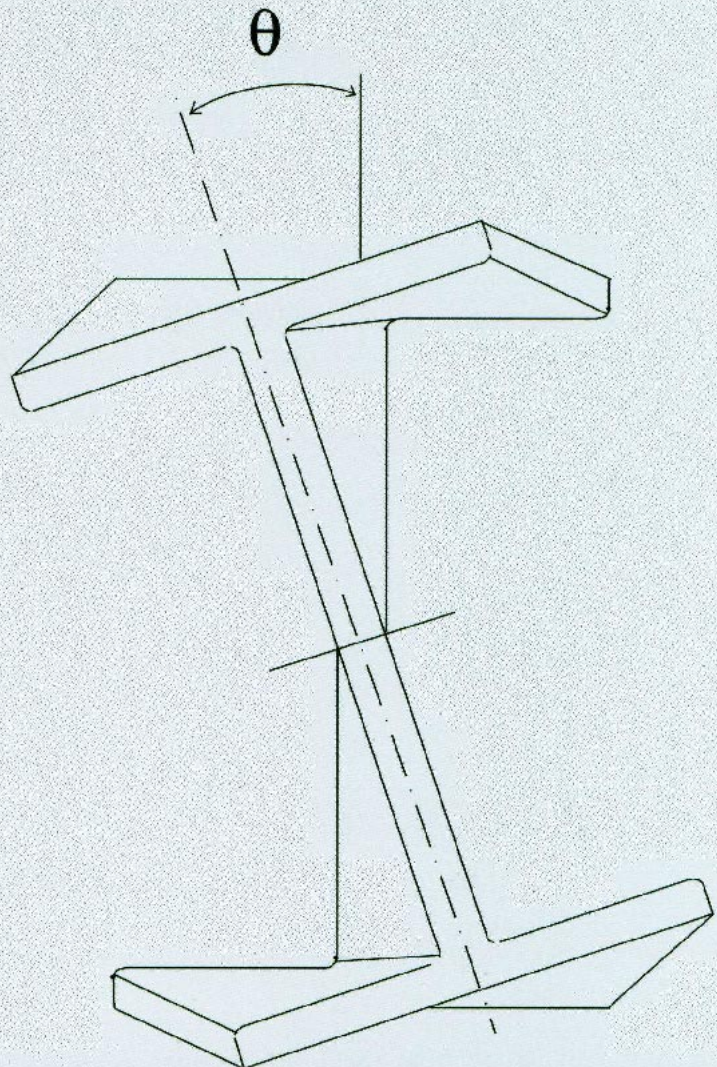

Steel Design Guide Series

9

Torsional Analysis of Structured Steel Members





Steel Design Guide Series



Torsional Analysis of Structural Steel Members

Paul A. Seaburg, PhD, PE
Head, Department of Architectural Engineering
Pennsylvania State University
University Park, PA

Charles J. Carter, PE
American Institute of Steel Construction
Chicago, IL

AMERICAN INSTITUTE OF STEEL CONSTRUCTION

© 2003 by American Institute of Steel Construction, Inc. All rights reserved.
This publication or any part thereof must not be reproduced in any form without permission of the publisher.

Copyright © 1997

by

American Institute of Steel Construction, Inc.

*All rights reserved. This book or any part thereof
must not be reproduced in any form without the
written permission of the publisher.*

The information presented in this publication has been prepared in accordance with recognized engineering principles and is for general information only. While it is believed to be accurate, this information should not be used or relied upon for any specific application without competent professional examination and verification of its accuracy, suitability, and applicability by a licensed professional engineer, designer, or architect. The publication of the material contained herein is not intended as a representation or warranty on the part of the American Institute of Steel Construction or of any other person named herein, that this information is suitable for any general or particular use or of freedom from infringement of any patent or patents. Anyone making use of this information assumes all liability arising from such use.

Caution must be exercised when relying upon other specifications and codes developed by other bodies and incorporated by reference herein since such material may be modified or amended from time to time subsequent to the printing of this edition. The Institute bears no responsibility for such material other than to refer to it and incorporate it by reference at the time of the initial publication of this edition.

Printed in the United States of America

Second Printing: October 2003

TABLE OF CONTENTS

1. Introduction	1	4.6.1 Open Cross-Sections	14
2. Torsion Fundamentals	3	4.6.2 Closed Cross-Sections.....	15
2.1 Shear Center.....	3	4.7 Specification Provisions.....	15
2.2 Resistance of a Cross-Section to a Torsional Moment.....	3	4.7.1 Load and Resistance Factor Design	15
2.3 Avoiding and Minimizing Torsion.....	4	4.7.2 Allowable Stress Design	16
2.4 Selection of Shapes for Torsional Loading	5	4.7.3 Effect of Lateral Restraint at Load Point.....	17
3. General Torsional Theory	7	4.8 Torsional Serviceability Criteria.....	18
3.1 Torsional Response.....	7	5. Design Examples	19
3.2 Torsional Properties	7	Appendix A. Torsional Properties	33
3.2.1 Torsional Constant J	7	Appendix B. Case Graphs of Torsional Functions...	54
3.2.2 Other Torsional Properties for Open Cross-Sections.....	7	Appendix C. Supporting Information	107
3.3 Torsional Functions	9	C.1 General Equations for 6 and its Derivatives ...	107
4. Analysis for Torsion	11	C.1.1 Constant Torsional Moment	107
4.1 Torsional Stresses on I-, C-, and Z-Shaped Open Cross-Sections	11	C.1.2 Uniformly Distributed Torsional Moment.....	107
4.1.1 Pure Torsional Shear Stresses	11	C.1.3 Linearly Varying Torsional Moment...	107
4.1.2 Shear Stresses Due to Warping	11	C.2 Boundary Conditions	107
4.1.3 Normal Stresses Due to Warping	12	C.3 Evaluation of Torsional Properties.....	108
4.1.4 Approximate Shear and Normal Stresses Due to Warping on I-Shapes..	12	C.3.1 General Solution	108
4.2 Torsional Stress on Single Angles	12	C.3.2 Torsional Constant J for Open Cross-Sections.....	108
4.3 Torsional Stress on Structural Tees	12	C.4 Solutions to Differential Equations for Cases in Appendix B	110
4.4 Torsional Stress on Closed and Solid Cross-Sections	12	References	113
4.5 Elastic Stresses Due to Bending and Axial Load	13	Nomenclature	115
4.6 Combining Torsional Stresses With Other Stresses.....	14		

Chapter 1

INTRODUCTION

This design guide is an update to the AISC publication *Torsional Analysis of Steel Members* and advances further the work upon which that publication was based: Bethlehem Steel Company's *Torsion Analysis of Rolled Steel Sections* (Heins and Seaburg, 1963). Coverage of shapes has been expanded and includes W-, M-, S-, and HP-Shapes, channels (C and MC), structural tees (WT, MT, and ST), angles (L), Z-shapes, square, rectangular and round hollow structural sections (HSS), and steel pipe (P). Torsional formulas for these and other non-standard cross sections can also be found in Chapter 9 of Young (1989).

Chapters 2 and 3 provide an overview of the fundamentals and basic theory of torsional loading for structural steel members. Chapter 4 covers the determination of torsional stresses, their combination with other stresses, Specification provisions relating to torsion, and serviceability issues. The design examples in Chapter 5 illustrate the design process as well as the use of the design aids for torsional properties and functions found in Appendices A and B, respectively. Finally, Appendix C provides supporting information that illustrates the background of much of the information in this design guide.

The design examples are generally based upon the provisions of the 1993 AISC LRFD *Specification for Structural Steel Buildings* (referred to herein as the LRFD Specification). Accordingly, forces and moments are indicated with the subscript u to denote factored loads. Nonetheless, the information contained in this guide can be used for design according to the 1989 AISC ASD *Specification for Structural Steel Buildings* (referred to herein as the ASD Specification) if service loads are used in place of factored loads. Where this is not the case, it has been so noted in the text. For single-angle members, the provisions of the AISC *Specification for LRFD of Single-Angle Members* and *Specification for ASD of Single-Angle Members* are appropriate. The design of curved members is beyond the scope of this publication; refer to AISC (1986), Liew et al. (1995), Nakai and Heins (1977), Tung and Fountain (1970), Chapter 8 of Young (1989), Galambos (1988), AASHTO (1993), and Nakai and Yoo (1988).

The authors thank Theodore V. Galambos, Louis F. Geschwindner, Nestor R. Iwankiw, LeRoy A. Lutz, and Donald R. Sherman for their helpful review comments and suggestions.

Chapter 2

TORSION FUNDAMENTALS

2.1 Shear Center

The shear center is the point through which the applied loads must pass to produce bending without twisting. If a shape has a line of symmetry, the shear center will always lie on that line; for cross-sections with two lines of symmetry, the shear center is at the intersection of those lines (as is the centroid). Thus, as shown in Figure 2.1a, the centroid and shear center coincide for doubly symmetric cross-sections such as W-, M-, S-, and HP-shapes, square, rectangular and round hollow structural sections (HSS), and steel pipe (P).

Singly symmetric cross-sections such as channels (C and MC) and tees (WT, MT, and ST) have their shear centers on the axis of symmetry, but not necessarily at the centroid. As illustrated in Figure 2.1b, the shear center for channels is at a distance e_o from the face of the channel; the location of the shear center for channels is tabulated in Appendix A as well as Part 1 of AISC (1994) and may be calculated as shown in Appendix C. The shear center for a tee is at the intersection of the centerlines of the flange and stem. The shear center location for unsymmetric cross-sections such as angles (L) and Z-shapes is illustrated in Figure 2.1c.

2.2 Resistance of a Cross-section to a Torsional Moment

At any point along the length of a member subjected to a torsional moment, the cross-section will rotate through an angle θ as shown in Figure 2.2. For non-circular cross-sections this rotation is accompanied by warping; that is, transverse sections do not remain plane.¹ If this warping is completely unrestrained, the torsional moment resisted by the cross-section is:

$$T_t = GJ\theta' \quad (2.1)$$

where

T_t = resisting moment of unrestrained cross-section, kip-in.

G = shear modulus of elasticity of steel, 11,200 ksi

J = torsional constant for the cross-section, in.⁴

θ' = angle of rotation per unit length, first derivative of θ with respect to z measured along the length of the member from the left support

When the tendency for a cross-section to warp freely is prevented or restrained, longitudinal bending results. This

bending is accompanied by shear stresses in the plane of the cross-section that resist the externally applied torsional moment according to the following relationship:

$$T_w = -EC_w\theta''' \quad (2.2)$$

where

T_w = resisting moment due to restrained warping of the cross-section, kip-in,

E = modulus of elasticity of steel, 29,000 ksi

C_w = warping constant for the cross-section, in.⁴

θ''' = third derivative of θ with respect to z

The total torsional moment resisted by the cross-section is the sum of T_t and T_w . The first of these is always present; the second depends upon the resistance to warping. Denoting the total torsional resisting moment by T , the following expression is obtained:

$$T = GJ\theta' - EC_w\theta''' \quad (2.3)$$

Rearranging, this may also be written as:

$$\frac{T}{EC_w} = \frac{\theta'}{a^2} - \theta''' \quad (2.4)$$

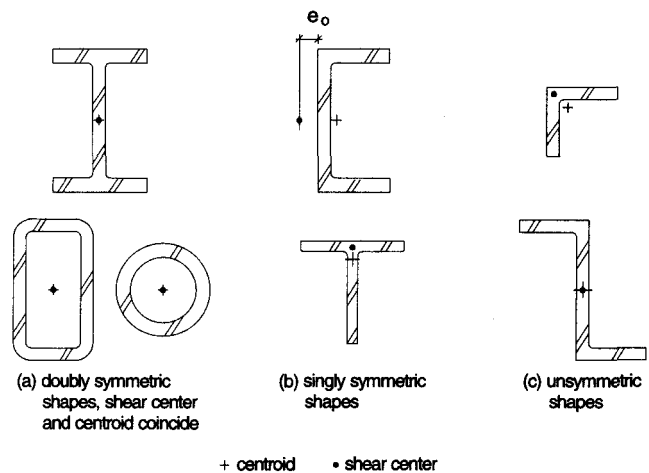

Figure 2.1.

¹ An exception to this occurs in cross-sections composed of plate elements having centerlines that intersect at a common point such as a structural tee. For such cross-sections, $W_{hs} = S_{ws} = C_w = a = 0$.

where

$$a^2 = \frac{EC_w}{GJ} \quad (2.5)$$

2.3 Avoiding and Minimizing Torsion

The commonly used structural shapes offer relatively poor resistance to torsion. Hence, it is best to avoid torsion by detailing the loads and reactions to act through the shear center of the member. However, in some instances, this may not always be possible. AISC (1994) offers several suggestions for eliminating torsion; see pages 2-40 through 2-42. For example, rigid facade elements spanning between floors (the weight of which would otherwise induce torsional loading of the spandrel girder) may be designed to transfer lateral forces into the floor diaphragms and resist the eccentric effect as illustrated in Figure 2.3. Note that many systems may be too flexible for this assumption. Partial facade panels that do not extend from floor diaphragm to floor diaphragm may be designed with diagonal steel "kickers," as shown in Figure 2.4, to provide the lateral forces. In either case, this eliminates torsional loading of the spandrel beam or girder. Also, torsional bracing may be provided at eccentric load points to reduce or eliminate the torsional effect; refer to Salmon and Johnson (1990).

When torsion must be resisted by the member directly, its effect may be reduced through consideration of intermediate torsional support provided by secondary framing. For example, the rotation of the spandrel girder cannot exceed the total end rotation of the beam and connection being supported. Therefore, a reduced torque may be calculated by evaluating the torsional stiffness of the member subjected to torsion relative to the rotational stiffness of the loading system. The bending stiffness of the restraining member depends upon its end conditions; the torsional stiffness k of the member under consideration (illustrated in Figure 2.5) is:

$$k = \frac{T}{\theta} \quad (2.6)$$

where

T = torque

θ = the angle of rotation, measured in radians.

A fully restrained (FR) moment connection between the framing beam and spandrel girder maximizes the torsional restraint. Alternatively, additional intermediate torsional supports may be provided to reduce the span over which the torsion acts and thereby reduce the torsional effect.

As another example, consider the beam supporting a wall and slab illustrated in Figure 2.6; calculations for a similar case may be found in Johnston (1982). Assume that the beam

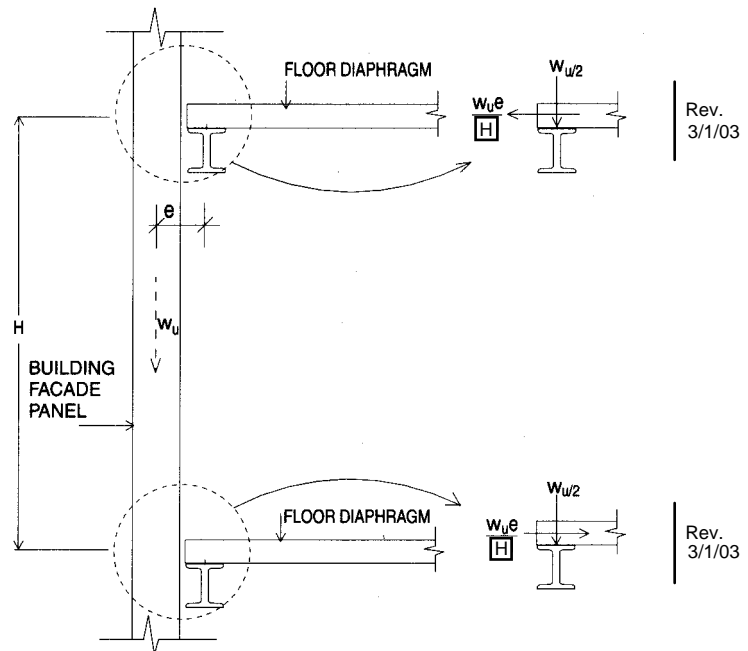

Figure 2.3.

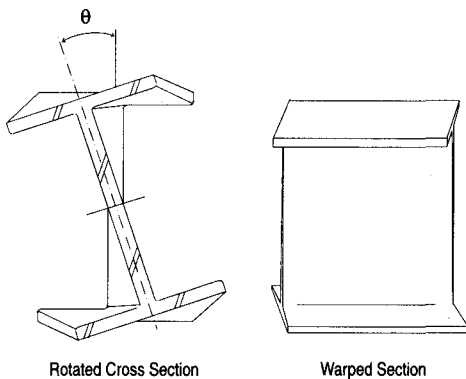

Figure 2.2.

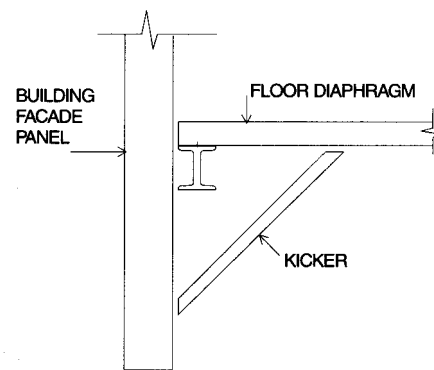

Figure 2.4.

alone resists the torsional moment and the maximum rotation of the beam due to the weight of the wall is 0.01 radians. Without temporary shoring, the top of the wall would deflect laterally by nearly $\frac{3}{4}$ -in. (72 in. x 0.01 rad.). The additional load due to the slab would significantly increase this lateral deflection. One solution to this problem is to make the beam and wall integral with reinforcing steel welded to the top flange of the beam. In addition to appreciably increasing the torsional rigidity of the system, the wall, because of its bending stiffness, would absorb nearly all of the torsional load. To prevent twist during construction, the steel beam would have to be shored until the floor slab is in place.

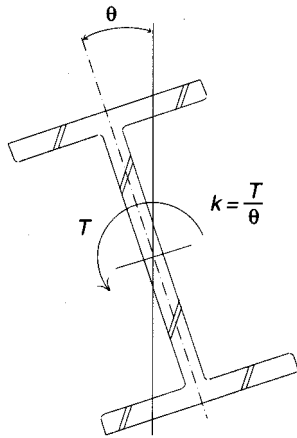

Figure 2.5.

2.4 Selection of Shapes for Torsional Loading

In general, the torsional performance of closed cross-sections is superior to that for open cross-sections. Circular closed shapes, such as round HSS and steel pipe, are most efficient for resisting torsional loading. Other closed shapes, such as square and rectangular HSS, also provide considerably better resistance to torsion than open shapes, such as W-shapes and channels. When open shapes must be used, their torsional resistance may be increased by creating a box shape, e.g., by welding one or two side plates between the flanges of a W-shape for a portion of its length.

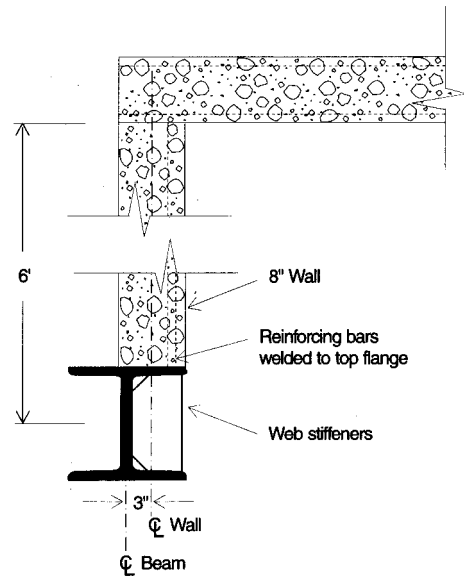

Figure 2.6.

Chapter 3

GENERAL TORSIONAL THEORY

A complete discussion of torsional theory is beyond the scope of this publication. The brief discussion that follows is intended primarily to define the method of analysis used in this book. More detailed coverage of torsional theory and other topics is available in the references given.

3.1 Torsional Response

From Section 2.2, the total torsional resistance provided by a structural shape is the sum of that due to pure torsion and that due to restrained warping. Thus, for a constant torque T along the length of the member:

$$T = GJ\theta' - EC_w\theta''' \quad (3.1)$$

where

- G = shear modulus of elasticity of steel, 11,200 ksi
- J = torsional constant of cross-section, in.⁴
- E = modulus of elasticity of steel, 29,000 ksi
- C_w = warping constant of cross-section, in.⁶

For a uniformly distributed torque t :

$$t = EC_w\theta'''' - GJ\theta'' \quad (3.2)$$

For a linearly varying torque $t \times (z/l)$:

$$\frac{tz}{l} = EC_w\theta'''' - GJ\theta'' \quad (3.3)$$

where

- t = maximum applied torque at right support, kip-in./ft
- z = distance from left support, in.
- l = span length, in.

In the above equations, θ' , θ'' , θ''' , and θ'''' are the first, second, third, and fourth derivatives of θ with respect to z and θ is the total angle of rotation about the Z -axis (longitudinal axis of member). For the derivation of these equations, see Appendix C.1.

3.2 Torsional Properties

Torsional properties J , a , C_w , W_{ns} , and S_w , are necessary for the solution of the above equations and the equations for torsional stress presented in Chapter 4. Since these values are dependent only upon the geometry of the cross-section, they have been tabulated for common structural shapes in Appendix A as well as Part 1 of AISC (1994). For the derivation of torsional properties for various cross-sections, see Appendix

C and Heins (1975). Values for Q_f and Q_w , which are used to compute plane bending shear stresses in the flange and edge of the web, are also included in the tables for all relevant shapes except Z-shapes.

The terms J , a , and C_w are properties of the entire cross-section. The terms W_n and S_w vary at different points on the cross-section as illustrated in Appendix A. The tables give all values of these terms necessary to determine the maximum values of the combined stress.

3.2.1 Torsional Constant J

The torsional constant J for solid round and flat bars, square, rectangular and round HSS, and steel pipe is summarized in Table 3.1. For open cross-sections, the following equation may be used (more accurate equations are given for selected shapes in Appendix C.3):

$$J \approx \Sigma \left(\frac{bt^3}{3} \right) \quad (3.4)$$

where

- b = length of each cross-sectional element, in.
- t = thickness of each cross-sectional element, in.

3.2.2 Other Torsional Properties for Open Cross-Sections²

For rolled and built-up I-shapes, the following equations may be used (fillets are generally neglected):

$$C_w = \frac{I_y h^2}{4} \quad (3.5)$$

$$a = \frac{h}{2} \sqrt{\frac{EI_y}{GJ}} = \sqrt{\frac{EC_w}{GJ}} \quad (3.6)$$

$$W_{no} = \frac{hb_f}{4} \quad (3.7)$$

$$S_w = \frac{W_{no} b_f t_f}{4} = \frac{hb_f^2 t_f}{16} \quad (3.8)$$

$$Q_f = \frac{ht_f(b_f - t_w)}{4} \quad (3.9)$$

$$Q_w = \frac{hb_f t_f}{2} + \frac{(h - t_f)^2 t_w}{8} \quad (3.10)$$

where

² For shapes with sloping-sided flanges, sloping flange elements are simplified into rectangular elements of thickness equal to the average thickness of the flange.

**Table 3.1
Torsional Constants J**

Solid Cross-Sections

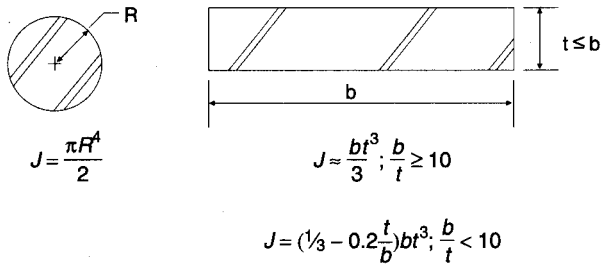

Closed Cross-Sections

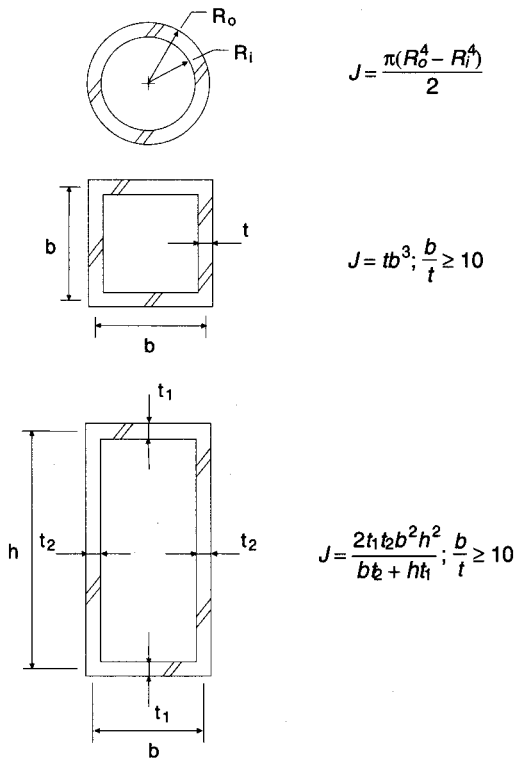

Note: tabulated values for HSS in Appendix A differ slightly because the effect of corner radii has been considered.

$$h = d - t_f \quad (3.11)$$

For channels, the following equations may be used:

$$a = \sqrt{\frac{EC_w}{GJ}} \quad (3.12)$$

$$W_{no} = \frac{uh}{2} \quad (3.13)$$

$$W_{n2} = \frac{E_o h}{2} \quad (3.14)$$

$$S_{w1} = \frac{u^2 h t_f}{4} \quad (3.15)$$

$$S_{w2} = \frac{h b' t_f (b' - 2E_o)}{4} \quad (3.16)$$

$$S_{w3} = S_{w2} - \frac{E_o h^2 t_w}{8} \quad (3.17)$$

$$C_w = \frac{h^2 b'^2 t_f (b' - 3E_o)}{6} + E_o^2 I_x \quad (3.18)$$

where, as illustrated in Figure 3.1:

$$E_o = \frac{t_f b'^2}{2b't_f + \frac{ht_w}{3}} = e_o + \frac{t_w}{2} \quad (3.19)$$

$$h = d - t_f \quad (3.20)$$

$$b' = b_f - \frac{t_w}{2} \quad (3.21)$$

$$u = b' - E_o \quad (3.22)$$

For Z-shapes:

$$a = \sqrt{\frac{EC_w}{GJ}} \quad (3.23)$$

$$W_{no} = \frac{uh}{2} \quad (3.24)$$

$$W_{n2} = \frac{u'h}{2} \quad (3.25)$$

$$S_{w1} = \frac{h b'^2 t_f (h t_w + b' t_f)^2}{4(h t_w + 2b' t_f)^2} \quad (3.26)$$

$$S_{w2} = \frac{t_w t_f h^2 b'^2}{4(h t_w + 2b' t_f)} \quad (3.27)$$

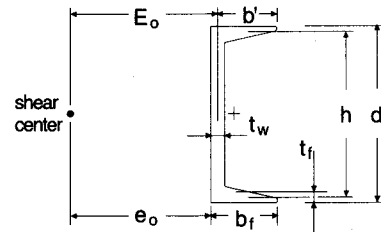

Figure 3.1.

$$C_w = \frac{t_f h^2 b'^3}{12} \left(\frac{b' t_f + 2 h t_w}{h t_w + 2 b' t_f} \right) \quad (3.28)$$

where, as illustrated in Figure 3.2:

$$h = d - t_f \quad (3.29)$$

$$b' = b_f - \frac{t_w}{2} \quad (3.30)$$

$$u = b' - u' \quad (3.31)$$

$$u' = \frac{b'^2 t_f}{h t_w + 2 b' t_f} \quad (3.32)$$

For single-angles and structural tees, J may be calculated using Equation 3.4, excluding fillets. For more accurate equations including fillets, see El Darwish and Johnston (1965). Since pure torsional shear stresses will generally dominate over warping stresses, stresses due to warping are usually neglected in single angles (see Section 4.2) and structural tees (see Section 4.3); equations for other torsional properties have not been included. Since the centerlines of each element of the cross-section intersect at the shear center, the general solution of Appendix C3.1 would yield $W_{ns} = S_{ws} = C_w = a = 0$. A value of a (and therefore C_w) is required, however, to determine the angle of rotation using the charts of Appendix B.

$$a = \sqrt{\frac{EC_w}{GJ}} \quad (3.33)$$

For single angles, the following formulas (Bleich, 1952) may be used to determine C_w :

$$C_w = \frac{t^3}{36} (h_1^3 + h_2^3) \quad (3.34)$$

where h_1 and h_2 are the centerline leg dimensions (overall leg dimension minus half the angle thickness t for each leg). For structural tees:

$$C_w = \frac{t_f^3 b_f^3}{144} + \frac{t_w^3 h^3}{36} \quad (3.35)$$

where

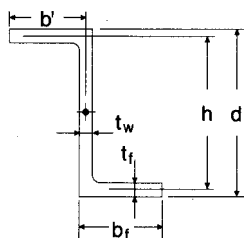

Figure 3.2.

$$h = d - \frac{t_f}{2} \quad (3.36)$$

3.3 Torsional Functions

In addition to the torsional properties given in Section 3.2 above, the torsional rotation θ and its derivatives are necessary for the solution of equations 3.1, 3.2, and 3.3. In Appendix B, these equations have been evaluated for twelve common combinations of end condition (fixed, pinned, and free) and load type. Members are assumed to be prismatic. The idealized fixed, pinned, and free torsional end conditions, for which practical examples are illustrated in Figure 3.3, are defined in Appendix C.2.

The solutions give the rotational response θ and derivatives along the span corresponding to different values of l/a , the ratio of the member span length l to the torsional property a of its cross-section. The functions given are non-dimensional, that is, each term is multiplied by a factor that is dependent upon the torsional properties of the member and the magnitude of the applied torsional moment.

For each case, there are four graphs providing values of θ , θ' , θ'' , and θ''' . Each graph shows the value of the torsional functions (vertical scale) plotted against the fraction of the span length (horizontal scale) from the left support. Some of the curves have been plotted as a dotted line for ease of reading. The resulting equations for each of these cases are given in Appendix C.4.

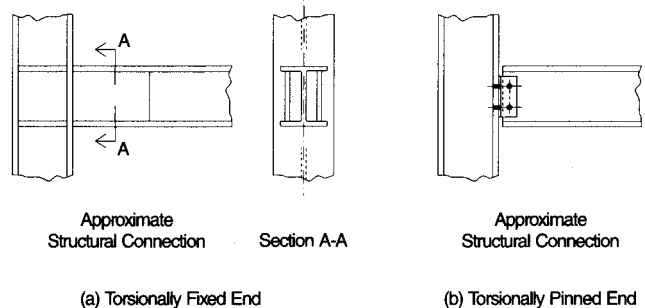
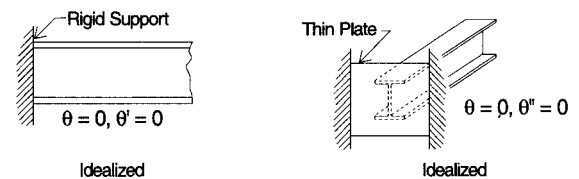

Figure 3.3.

Chapter 4

ANALYSIS FOR TORSION

In this chapter, the determination of torsional stresses and their combination with stresses due to bending and axial load is covered for both open and closed cross-sections. The AISC Specification provisions for the design of members subjected to torsion and serviceability considerations for torsional rotation are discussed.

4.1 Torsional Stresses on I-, C-, and Z-shaped Open Cross-Sections

Shapes of open cross-section tend to warp under torsional loading. If this warping is unrestrained, only pure torsional stresses are present. However, when warping is restrained, additional direct shear stresses as well as longitudinal stresses due to warping must also be considered. Pure torsional shear stresses, shear stresses due to warping, and normal stresses due to warping are each related to the derivatives of the rotational function θ . Thus, when the derivatives of θ are determined along the girder length, the corresponding stress conditions can be evaluated. The calculation of these stresses is described in the following sections.

4.1.1 Pure Torsional Shear Stresses

These shear stresses are always present on the cross-section of a member subjected to a torsional moment and provide the resisting moment T , as described in Section 2.2. These are in-plane shear stresses that vary linearly across the thickness of an element of the cross-section and act in a direction parallel to the edge of the element. They are maximum and equal, but of opposite direction, at the two edges. The maximum stress is determined by the equation:

$$\tau_t = Gt\theta' \quad (4.1)$$

where

- τ_t = pure torsional shear stress at element edge, ksi
- G = shear modulus of elasticity of steel, 11,200 ksi
- t = thickness of element, in.
- θ' = rate of change of angle of rotation θ , first derivative of θ with respect to z (measured along longitudinal axis of member)

The pure torsional shear stresses will be largest in the thickest elements of the cross-section. These stress states are illustrated in Figures 4.1b, 4.2b, and 4.3b for I-shapes, channels, and Z-shapes.

4.1.2 Shear Stresses Due to Warping

When a member is allowed to warp freely, these shear stresses will not develop. When warping is restrained, these are in-plane shear stresses that are constant across the thickness of an element of the cross-section, but vary in magnitude along the length of the element. They act in a direction parallel to the edge of the element. The magnitude of these stresses is determined by the equation:

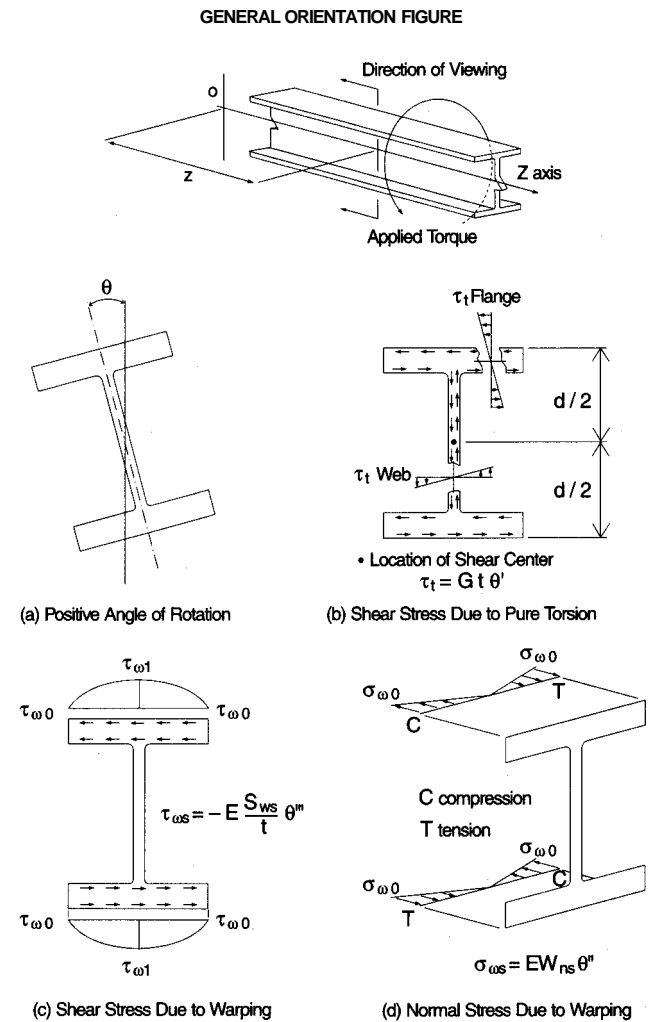

Figure 4.1.

$$\tau_{ws} = \frac{-ES_{ws}\theta'''}{t} \quad (4-2a)$$

where

- τ_{ws} = shear stress at point s due to warping, ksi
- E = modulus of elasticity of steel, 29,000 ksi
- S_{ws} = warping statical moment at point s (see Appendix A), in.⁴
- t = thickness of element, in.
- θ''' = third derivative of θ with respect to z

These stress states are illustrated in Figures 4.1c, 4.2c, and 4.3c for I-shapes, channels, and Z-shapes. Numerical subscripts are added to represent points of the cross-section as illustrated.

4.1.3 Normal Stresses Due to Warping

When a member is allowed to warp freely, these normal stresses will not develop. When warping is restrained, these are direct stresses (tensile and compressive) resulting from bending of the element due to torsion. They act perpendicular to the surface of the cross-section and are constant across the thickness of an element of the cross-section but vary in magnitude along the length of the element. The magnitude of these stresses is determined by the equation:

$$\sigma_{ws} = EW_{ns}\theta'' \quad (4.3a)$$

where

- σ_{ws} = normal stress at point s due to warping, ksi
- E = modulus of elasticity of steel, 29,000 ksi
- W_{ns} = normalized warping function at point s (see Appendix A), in.²
- θ'' = second derivative of θ with respect to z

These stress states are illustrated in Figures 4.1d, 4.2d, and 4.3d for I-shapes, channels, and Z-shapes. Numerical subscripts are added to represent points of the cross-section as illustrated.

4.1.4 Approximate Shear and Normal Stresses Due to Warping on I-Shapes

The shear and normal stresses due to warping may be approximated for short-span I-shapes by resolving the torsional moment T into an equivalent force couple acting at the flanges as illustrated in Figure 4.4. Each flange is then analyzed as a beam subjected to this force. The shear stress at the center of the flange is approximated as:

$$\tau_w = \frac{1.5V_f}{bt_f} \quad (4.2b)$$

where V_f is the value of the shear in the flange at any point along the length. The normal stress at the tips of the flange is approximated as:

$$\sigma_w = \frac{M_f}{S_f} \quad (4.3b)$$

where

- $S_f = \frac{tb_f^2}{6}$
- M_f = bending moment on the flange at any point along the length.

4.2 Torsional Stress on Single-Angles

Single-angles tend to warp under torsional loading. If this warping is unrestrained, only pure torsional shear stresses develop. However, when warping is restrained, additional direct shear stresses as well as longitudinal stress due to warping are present.

Pure torsional shear stress may be calculated using Equation 4.1. Gjelsvik (1981) identified that the shear stresses due to warping are of two kinds: in-plane shear stresses, which vary from zero at the toe to a maximum at the heel of the angle; and secondary shear stresses, which vary from zero at the heel to a maximum at the toe of the angle. These stresses are illustrated in Figure 4.5.

Warping strengths of single-angles are, in general, relatively small. Using typical angle dimensions, it can be shown that the two shear stresses due to warping are of approximately the same order of magnitude, but represent less than 20 percent of the pure torsional shear stress (AISC, 1993b). When all the shear stresses are added, the result is a maximum surface shear stress near mid-length of the angle leg. Since this is a local maximum that does not extend through the thickness of the angle, it is sufficient to ignore the shear stresses due to warping. Similarly, normal stresses due to warping are considered to be negligible.

For the design of shelf angles, refer to Tide and Krogstad (1993).



4.3 Torsional Stress on Structural Tees

Structural tees tend to warp under torsional loading. If this warping is unrestrained, only pure torsional shear stresses develop. However, when warping is restrained, additional direct shear stresses as well as longitudinal or normal stress due to warping are present. Pure torsional shear stress may be calculated using Equation 4.1. Warping stresses of structural tees are, in general, relatively small. Using typical tee dimensions, it can be shown that the shear and normal stresses due to warping are negligible.

4.4 Torsional Stress on Closed and Solid Cross-Sections

Torsion on a circular shape (hollow or solid) is resisted by shear stresses in the cross-section that vary directly with distance from the centroid. The cross-section remains plane as it twists (without warping) and torsional loading develops pure torsional stresses only. While non-circular closed cross-

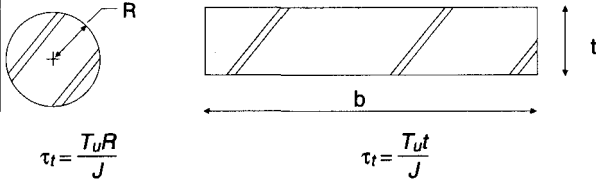
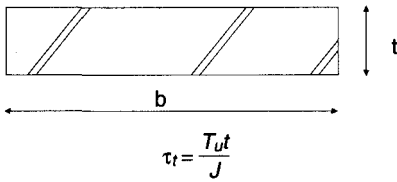
**Table 4.1
Shear Stress Due to St. Venant's Torsion**

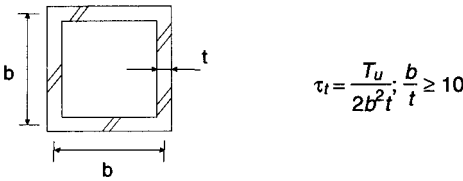
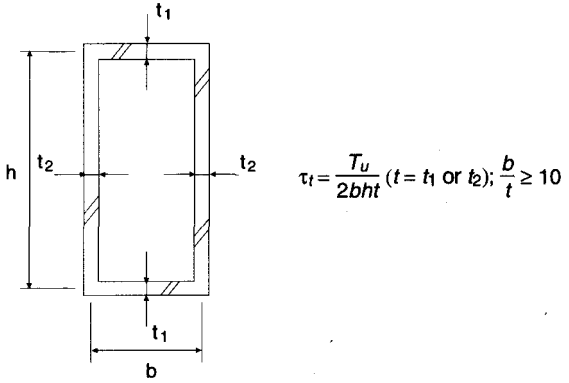
Solid Cross-Sections	
	
Use appropriate J from Table 3.1	
Closed Cross-Sections	
	$\tau_t = \frac{T_u R}{J}$
	$\tau_t = \frac{T_u}{2b^2 t} \cdot \frac{b}{t} \ge 10$
	$\tau_t = \frac{T_u}{2bht} (t = t_1 \text{ or } t_2); \frac{b}{t} \ge 10$

sections tend to warp under torsional loading, this warping is minimized since longitudinal shear prevents relative displacement of adjacent plate elements as illustrated in Figure 4.6.

The analysis and design of thin-walled ($b/t \geq 10$) closed cross-sections for torsion is simplified with the assumption that the torque is absorbed by shear forces that are uniformly distributed over the thickness of the element (Siev, 1966). The general torsional response can be determined from Equation 3.1 with the warping term neglected. For a constant torsional moment T the shear stress τ_t may be calculated as:

$$\tau_t = \frac{T}{2tA_o} \quad (4.4)$$

where

A_o = area enclosed by shape, measured to centerline of thickness of bounding elements as illustrated in Figure 4.7, in.²

t = thickness of bounding element, in.

For solid round and flat bars, square, rectangular and round HSS and steel pipe, the torsional shear stress may be calculated using the equations given in Table 4.1. Note that the equation for the hollow circular cross-section in Table 4.1 is not in a form based upon Equation 4.4 and is valid for any wall thickness.

4.5 Elastic Stresses Due to Bending and Axial Load

In addition to the torsional stresses, bending and shear stresses (σ_b and τ_b , respectively) due to plane bending are normally present in the structural member. These stresses are determined by the following equations:

$$\sigma_b = \frac{M}{S} \quad (4.5)$$

$$\tau_b = \frac{VQ}{It} \quad (4.6)$$

where

σ_b = normal stress due to bending about either the x or y axis, ksi

M = bending moment about either the x or y axis, kip-in.

S = elastic section modulus, in.³

τ_b = shear stress due to applied shear in either x or y direction, ksi

V = shear in either x or y direction, kips

Q = Q_f for the maximum shear stress in the flange

= Q_w for the maximum shear stress in the web.

I = moment of inertia I_x or I_y , in.⁴

t = thickness of element, in.

The value of τ_b computed using Q_f from Appendix A is the theoretical value at the center of the flange. It is within the accuracy of the method presented herein to combine this theoretical value with the torsional shearing stress calculated for the point at the intersection of the web and flange centerlines.

Figure 4.8 illustrates the distribution of these stresses, shown for the case of a moment causing bending about the major axis of the cross-section and shear acting along the minor axis of the cross-section. The stress distribution in the Z-shape is somewhat complicated because the major axis is not parallel to the flanges.

Axial stress σ_a may also be present due to an axial load P .

This stress may be tensile or compressive and is determined by the following equation:

$$\sigma_a = \frac{P}{A} \quad (4.7)$$

where

- σ_a = normal stress due to axial load, ksi
- P = axial load, kips
- A = area, in.²

4.6 Combining Torsional Stresses With Other Stresses

4.6.1 Open Cross-Sections

To determine the total stress condition, the stresses due to torsion are combined algebraically with all other stresses using the principles of superposition. The total normal stress f_n is:

$$f_n = \sigma_a \pm \sigma_{bx} \pm \sigma_{by} \pm \sigma_w \quad (4.8a)$$

and the total shear stress f_v , is:

$$f_v = \tau_{bx} \pm \tau_{by} \pm \tau_t \pm \tau_w \quad (4.9a)$$

As previously mentioned, the terms σ_w and τ_w may be taken as zero in the following cases:

1. members for which warping is unrestrained
2. single-angle members
3. structural tee members

In the foregoing, it is imperative that the direction of the stresses be carefully observed. The positive direction of the torsional stresses as used in the sign convention presented herein is indicated in Figures 4.1, 4.2, and 4.3. In the sketches accompanying each figure, the stresses are shown acting on a cross-section of the member located at distance z from the left support and viewed in the direction indicated in Figure 4.1. In all of the sketches, the applied torsional moment acts at some arbitrary point along the member in the direction indicated. In the sketches of Figure 4.8, the moment acts about the major axis of the cross-section and causes compression in the top flange. The applied shear is assumed to act vertically downward along the minor axis of the cross-section.

For I-shapes, σ_w and σ_b are both at their maximum values at the edges of the flanges as shown in Figures 4.1 and 4.8. Likewise, there are always two flange tips where these stresses add regardless of the directions of the applied torsional moment and bending moment. Also for I-shapes, the maximum values of τ_t , τ_w , and τ_b in the flanges will always add at some point regardless of the directions of the applied torsional moment and vertical shear to give the maximum

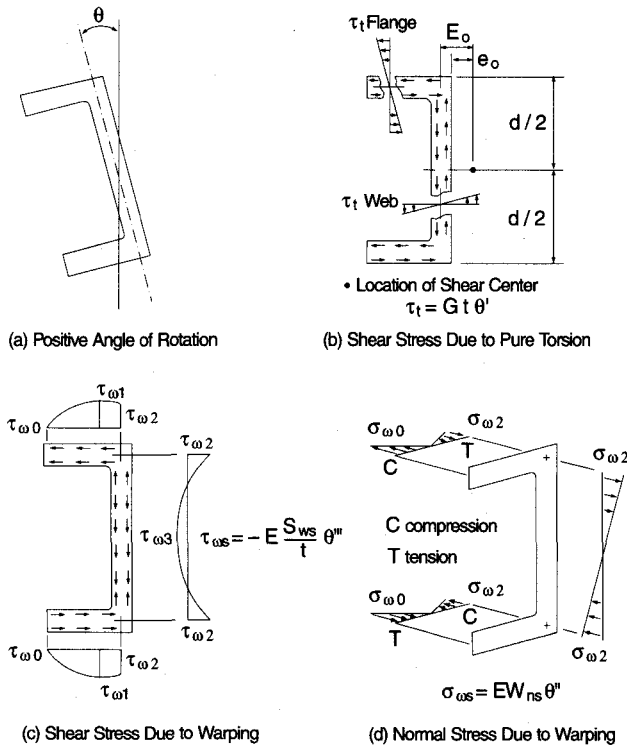

Figure 4.2.

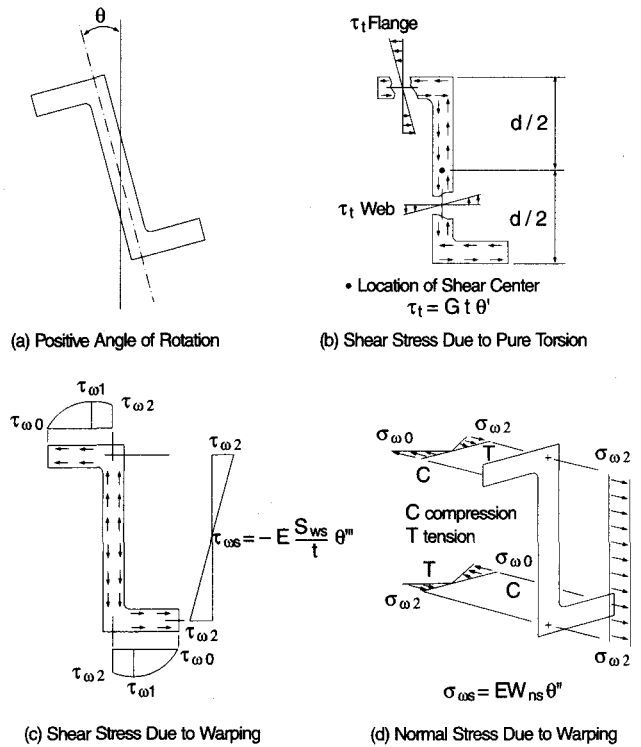

Figure 4.3.

shear stress in the flange. For the web, the maximum value of τ_b adds to the value of τ_t in the web, regardless of the direction of loading, to give the maximum shear stress in the web. Thus, for I-shapes, Equations 4.8a and 4.9a may be simplified as follows:

$$f_n = \sigma_a \pm (\sigma_{bx} + \sigma_{by} + \sigma_w) \quad (4.8b)$$

$$f_v = \tau_{bx} + \tau_{by} + \tau_t + \tau_w \quad (4.9b)$$

For channels and Z-shapes, generalized rules cannot be given for the determination of the magnitude of the maximum combined stress. For shapes such as these, it is necessary to consider the directions of the applied loading and to check the combined stresses at several locations in both the flange and the web.

Determining the maximum values of the combined stresses for all types of shapes is somewhat cumbersome because the stresses τ_t , τ_w , σ_w , σ_b , and τ_b are not all at their maximum values at the same transverse cross-section along the length of the member. Therefore, in many cases, the stresses should be checked at several locations along the member.

4.6.2 Closed Cross-Sections

For closed cross-sections, stresses due to warping are either not induced³ or negligible. Torsional loading does, however, cause shear stress, and the total shear stress f_v is:

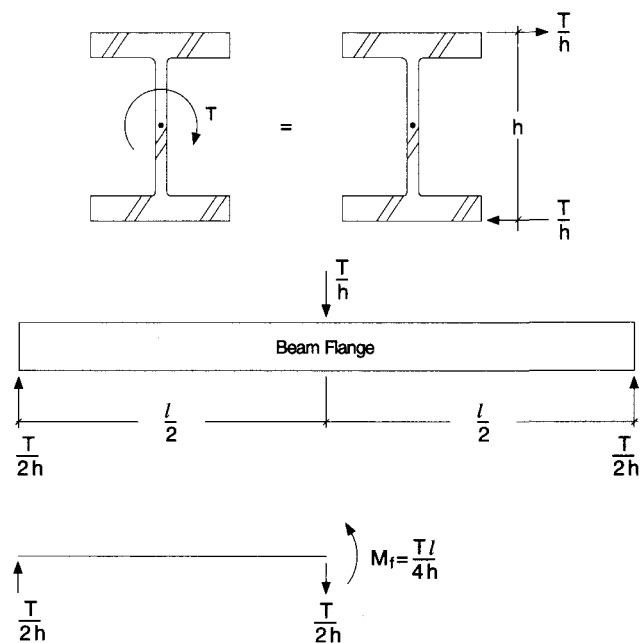

Figure 4.4.

$$f_v = \tau_{bx} + \tau_{by} + \tau_t \quad (4.10)$$

In the above equation,

$$\tau_b = \frac{V}{A_v} \quad (4.11)$$

where

A_v = total web area for square and rectangular HSS and half the cross-sectional area for round HSS and steel pipe.

4.7 Specification Provisions

4.7.1 Load and Resistance Factor Design (LRFD)

In the following, the subscript u denotes factored loads. LRFD Specification Section H2 provides general criteria for members subjected to torsion and torsion combined with other forces. Second-order amplification (P-delta) effects, if any, are presumed to already be included in the elastic analysis from which the calculated stresses (f_{un} , f_{uv} , σ_a , σ_b , σ_w , τ_b , τ_t , and τ_w) were determined.

For the limit state of yielding under normal stress:

$$f_{un} \leq \phi F_y \quad (4.12)$$

For the limit state of yielding under shear stress:

$$f_{uv} \leq \phi 0.6 F_y \quad (4.13)$$

For the limit state of buckling:

$$f_{un} \leq \phi_c F_{cr} \quad (4.14)$$

or

$$f_{uv} \leq \phi_c F_{cr} \quad (4.15)$$

as appropriate. In the above equations,

F_y = yield strength of steel, ksi

F_{cr} = critical buckling stress in either compression (LRFD)

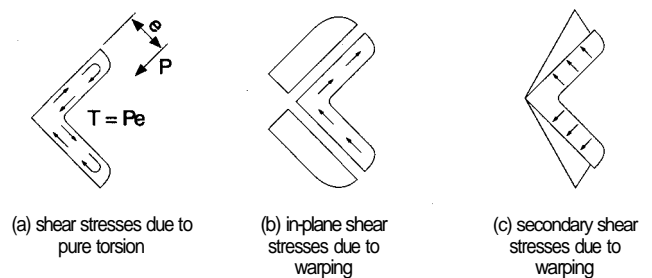

Figure 4.5.

³ For a circular shape or for a non-circular shape for which warping is unrestrained, warping does not occur, i.e., σ_w and τ_w are equal to zero.

Specification Chapter E) or shear (LRFD Specification Section F2), ksi

$$\phi = 0.90$$

$$\phi_c = 0.85$$

When it is unclear whether the dominant limit state is yielding, buckling, or stability, in a member subjected to combined forces, the above provisions may be too simplistic. Therefore, the following interaction equations may be useful to conservatively combine the above checks of normal stress for the limit states of yielding (Equation 4.12) and buckling (Equation 4.14). When second order effects, if any, are considered in the determination of the normal stresses:

$$\frac{\sigma_a}{0.85F_{cr}} \pm \frac{\sigma_{bx}}{\phi_b F_{cr}} \pm \frac{\sigma_{by}}{0.9F_y} \pm \frac{\sigma_w}{0.9F_y} \leq 1.0 \quad (4.16a)$$

If second order effects occur but are not considered in determining the normal stresses, the following equation must be used:

$$\frac{\sigma_a}{0.85F_{cr}} \pm \frac{\sigma_{bx}}{\left(1 - \frac{P_u}{P_{ex}}\right)\phi_b F_{cr}} \pm \frac{\sigma_{by}}{\left(1 - \frac{P_u}{P_{ey}}\right)0.9F_y} \pm \frac{\sigma_w}{\left(1 - \frac{P_u}{P_{ey}}\right)0.9F_y} \leq 1.0 \quad (4.16b)$$

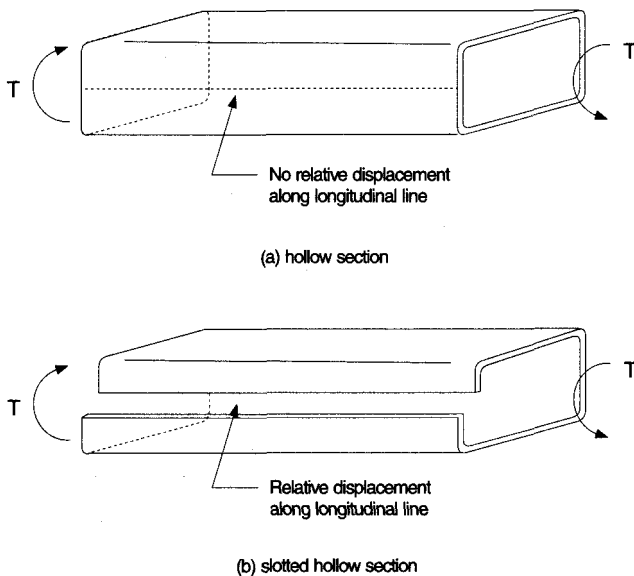

Figure 4.6.

In the above equations,

F_{cr} = compressive critical stress for flexural or flexural-torsional member buckling from LRFD Specification Chapter E (σ_a term), ksi; critical flexural stress controlled by yielding, lateral-torsional buckling (LTB), web local buckling (WLB), or flange local buckling (FLB) from LRFD Specification Chapter F (σ_{bx} term)

P_u = factored axial force in the member (kips)

P_e = elastic (Euler) buckling load.

Shear stresses due to combined torsion and flexure may be checked for the limit state of yielding as in Equation 4.13. Note that a shear buckling limit state for torsion (Equation 4.15) has not yet been defined.

For single-angle members, see AISC (1993b). A more advanced analysis and/or special design precautions are suggested for slender open cross-sections subjected to torsion.

4.7.2 Allowable Stress Design (ASD)

Although not explicitly covered in the ASD Specification, the design for the combination of torsional and other stresses in ASD can proceed essentially similarly to that in LRFD, except that service loads are used in place of factored loads. In the absence of allowable stress provisions for the design of members subjected to torsion and torsion combined with other forces, the following provisions, which parallel the LRFD Specification provisions above, are recommended. Second-order amplification (P-delta) effects, if any, are presumed to already be included in the elastic analysis from which the calculated stresses (f_n , f_v , σ_a , σ_b , σ_w , τ_b , τ_n , and τ_w) were determined.

For the limit state of yielding under normal stress:

$$f_n \leq 0.6F_y \quad (4.17)$$

For the limit state of yielding under shear stress:

$$f_v \leq 0.4F_y \quad (4.18)$$

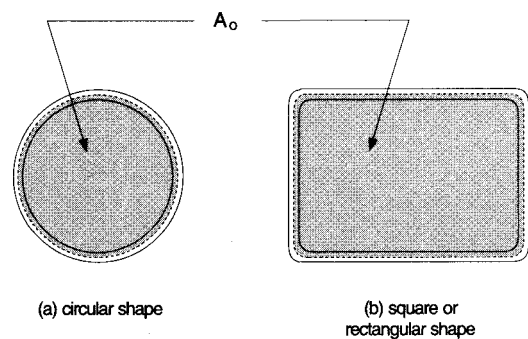

Figure 4.7.

For the limit state of buckling:

$$f_n \leq F_a \quad \text{or} \quad f_n \leq F_{bx} \quad (4.19)$$

or

$$f_v \leq F_v \quad (4.20)$$

as appropriate. In the above equations,

- F_y = yield strength of steel, ksi
- F_a = allowable buckling stress in compression (ASD Specification Chapter E), ksi
- F_{bx} = allowable bending stress (ASD Specification Chapter F), ksi
- F_v = allowable buckling stress in shear (ASD Specification Section F4), ksi

When it is unclear whether the dominant limit state is yielding, buckling, or stability, in a member subjected to combined forces, the above provisions may be too simplistic. Therefore, the following interaction equations may be useful to conservatively combine the above checks of normal stress for the limit states of yielding (Equation 4.17) and buckling (Equation 4.19). When second order effects, if any, are considered in determining the normal stresses:

$$\frac{\sigma_a}{F_a} \pm \frac{\sigma_{bx}}{F_{bx}} \pm \frac{\sigma_{by}}{0.6F_y} \pm \frac{\sigma_w}{0.6F_y} \leq 1.0 \quad (4.21a)$$

If second order effects occur but are not considered in determining the normal stresses, the following equation must be used:

$$\frac{\sigma_a}{F_a} \pm \frac{\sigma_{bx}}{\left(1 - \frac{f_a}{F'_{ex}}\right) F_{bx}} \pm \frac{\sigma_{by}}{\left(1 - \frac{f_a}{F'_{ey}}\right) 0.6F_y} \pm \frac{\sigma_w}{\left(1 - \frac{f_a}{F'_{ey}}\right) 0.6F_y} \leq 1.0 \quad (4.21b)$$

In the above equations,

- F_a = allowable axial stress (ASD Specification Chapter E), ksi
- F_{bx} = allowable bending stress controlled by yielding, lateral-torsional buckling (LTB), web local buckling (WLB), or flange local buckling (FLB) from ASD Specification Chapter F, ksi
- f_a = axial stress in the member, ksi
- F'_e = elastic (Euler) stress divided by factor of safety (see ASD Specification Section H1).

Shear stresses due to combined torsion and flexure may be checked for the limit state of yielding as in Equation 4.18. As with LRFD Specification provisions, a shear buckling limit state for torsion has not yet been defined.

For single-angle members, see AISC (1989b). A more advanced analysis and/or special design precautions are suggested for slender open cross-sections subjected to torsion.

4.7.3 Effect of Lateral Restraint at Load Point

Chu and Johnson (1974) showed that for an unbraced beam subjected to both flexure and torsion, the stress due to warping is magnified for a W-shape as its lateral-torsional buckling strength is approached; this is analogous to beam-column behavior. Thus, if lateral displacement or twist is not restrained at the load point, the secondary effects of lateral bending and warping restraint stresses may become significant and the following additional requirement is also conservatively suggested.

For the LRFD Specification provisions of Section 4.7.1, amplify the minor-axis bending stress σ_{by} and the warping normal stress σ_w by the factor

$$\left(\frac{\phi F_{cr}^e}{\phi F_{cr}^e - \sigma_{bx}} \right) \quad (4.22)$$

where ϕF_{cr}^e is the elastic LTB stress (ksi), which can be derived for W-shapes from LRFD Specification Equation FI-13. For the ASD Specification provisions of Section 4.7.2, amplify the minor-axis bending stress σ_{by} and the warping normal stress σ_w by the factor

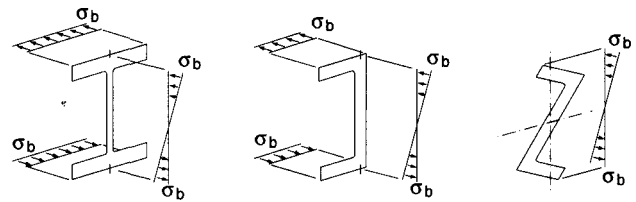

(a) Bending Stresses Due to Beam Action $\sigma_b = \frac{M}{S}$

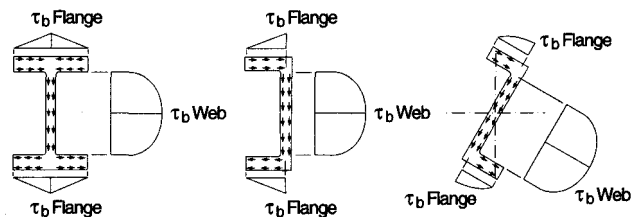

(b) Shear Stresses Due to Beam Action $\tau_b = \frac{VQ}{It}$

Figure 4.8.

$$\left(\frac{F_{bx}^e}{F_{bx}^e - \sigma_{bx}} \right) \quad (4.23)$$

where F_{bx}^e is the elastic LTB stress (ksi), given for W-shapes, by the larger of ASD Specification Equations F1-7 and F1-8.

4.8 Torsional Serviceability Criteria

In addition to the strength provisions of Section 4.7, members subjected to torsion must be checked for torsional rotation θ . The appropriate serviceability limitation varies; the rotation limit for a member supporting an exterior masonry wall may

differ from that for a member supporting a curtain-wall system. Therefore, the rotation limit must be selected based upon the requirements of the intended application.

Whether the design check was determined with factored loads and LRFD Specification provisions, or service loads and ASD Specification provisions, the serviceability check of θ should be made at service load levels (i.e., against Unfactored torsional moment). The design aids of Appendix B as well as the general equations in Appendix C are required for the determination of θ .

Chapter 5

DESIGN EXAMPLES

Example 5.1

As illustrated in Figure 5.1a, a W10x49 spans 15 ft (180 in.) and supports a 15-kip factored load (10-kip service load) at midspan that acts at a 6 in. eccentricity with respect to the shear center. Determine the stresses on the cross-section and the torsional rotation.

Given:

The end conditions are assumed to be flexurally and torsionally pinned. The eccentric load can be resolved into a torsional moment and a load applied through the shear center as shown in Figure 5.1b. The resulting flexural and torsional loadings are illustrated in Figure 5.1c. The torsional properties are as follows:

- $J = 1.39 \text{ in.}^4$
- $a = 62.1 \text{ in.}$
- $C_w = 2070 \text{ in.}^6$
- $W_{no} = 23.6 \text{ in.}^2$
- $S_{w1} = 33.0 \text{ in.}^4$
- $Q_f = 13.0 \text{ in.}^3$
- $Q_w = 30.2 \text{ in.}^3$

The flexural properties are as follows:

- $I_x = 272 \text{ in.}^4$
- $S_x = 54.6 \text{ in.}^3$
- $t_f = 0.560 \text{ in.}$
- $t_w = 0.340 \text{ in.}$

Solution:

Calculate Bending Stresses

$$\begin{aligned}
 M_u &= \frac{P_u l}{4} \\
 &= \frac{(15 \text{ kips})(180 \text{ in.})}{4} \\
 &= 675 \text{ kip-in.} \\
 V_u &= \frac{P_u}{2} \\
 &= \frac{15 \text{ kips}}{2} \\
 &= 7.5 \text{ kips}
 \end{aligned}$$

$$\sigma_{bx} = \frac{M_u}{S_x} \tag{4.5}$$

$$\begin{aligned}
 &= \frac{675 \text{ kip-in.}}{54.6 \text{ in.}^3} \\
 &= 12.4 \text{ ksi (compression at top; tension at bottom)}
 \end{aligned}$$

$$\tau_{bw} = \frac{V_u Q_w}{I_x t_w} \tag{4.6}$$

$$\begin{aligned}
 &= \frac{(7.5 \text{ kips})(30.2 \text{ in.}^3)}{(272 \text{ in.}^4)(0.340 \text{ in.})} \\
 &= 2.45 \text{ ksi}
 \end{aligned}$$

$$\tau_{bf} = \frac{V_u Q_f}{I_x t_f} \tag{4.6}$$

$$\begin{aligned}
 &= \frac{(7.5 \text{ kips})(13.0 \text{ in.}^3)}{(272 \text{ in.}^4)(0.560 \text{ in.})} \\
 &= 0.64 \text{ ksi}
 \end{aligned}$$

For this loading, stresses are constant from the support to the load point.

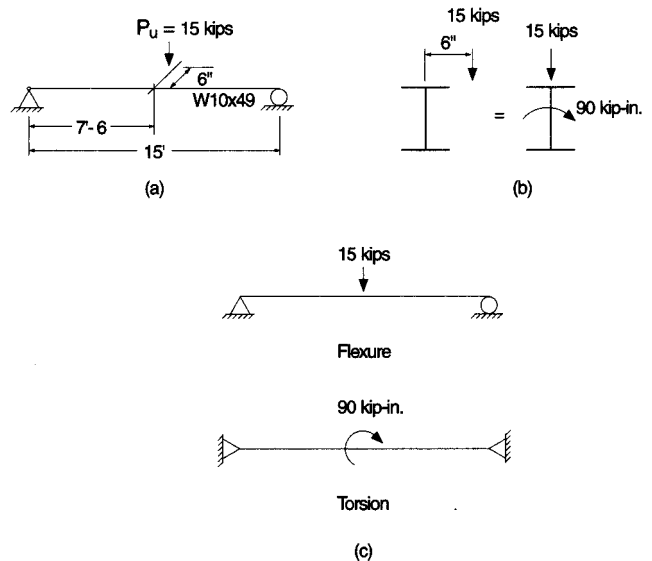

Figure 5.1.

Calculate Torsional Stresses

$$\begin{aligned} T_u &= P_u e \\ &= 15 \text{ kips} \times 6 \text{ in.} \\ &= 90 \text{ kip-in.} \end{aligned}$$

The following functions are taken from Appendix B, Case 3, with $\alpha = 0.5$:

$$\begin{aligned} \frac{l}{a} &= \frac{180 \text{ in.}}{62.1 \text{ in.}} \\ &= 2.90 \end{aligned}$$

At midspan ($z/l = 0.5$)

$$\begin{aligned} \theta \times \frac{GJ}{T_u} \times \frac{1}{l} &= +0.09 & \theta &= +0.09 \frac{T_u l}{GJ} \\ \theta'' \times \frac{GJ}{T_u} \times a &= -0.44 & \theta'' &= -0.44 \frac{T_u}{GJa} \\ \theta' \times \frac{GJ}{T_u} &= 0 & \theta' &= 0 \\ \theta''' \times \frac{GJ}{T_u} \times a^2 &= -0.50 & \theta''' &= -0.50 \frac{T_u}{GJa^2} \end{aligned}$$

At the support ($z/l = 0$)

$$\begin{aligned} \theta \times \frac{GJ}{T_u} \times \frac{1}{l} &= 0 & \theta &= 0 \\ \theta'' \times \frac{GJ}{T_u} \times a &= 0 & \theta'' &= 0 \\ \theta' \times \frac{GJ}{T_u} &= +0.28 & \theta' &= +0.28 \frac{T_u}{GJ} \\ \theta''' \times \frac{GJ}{T_u} \times a^2 &= -0.22 & \theta''' &= -0.22 \frac{T_u}{GJa^2} \end{aligned}$$

In the above calculations (note that the applied torque is negative with the sign convention used in this book):

$$\begin{aligned} \frac{T_u}{GJ} &= \frac{-90 \text{ kip-in.}}{(11,200 \text{ ksi})(1.39 \text{ in.}^4)} \\ &= -5.78 \times 10^{-3} \text{ rad./in.} \end{aligned}$$

The shear stress due to pure torsion is:

$$\tau_t = Gt\theta' \quad (4.1)$$

At midspan, since $\theta' = 0$, $\tau_t = 0$. At the support, for the web,

$$\begin{aligned} \tau_t &= (11,200 \text{ ksi})(0.340 \text{ in.})(0.28 \times -5.78 \times 10^{-3} \text{ rad./in.}) \\ &= -6.16 \text{ ksi} \end{aligned}$$

and for the flange,

$$\begin{aligned} \tau_t &= (11,200 \text{ ksi})(0.560 \text{ in.})(0.28 \times -5.78 \times 10^{-3} \text{ rad./in.}) \\ &= -10.2 \text{ ksi} \end{aligned}$$

The shear stress due to warping is:

$$\tau_w = \frac{-ES_w \theta'''}{t_f} \quad (4.2a)$$

At midspan,

$$\begin{aligned} \tau_w &= \frac{(-29,000 \text{ ksi})(33.0 \text{ in.}^4)}{0.560 \text{ in.}} \left[\frac{(-0.50)(-5.78 \times 10^{-3} \text{ rad./in.})}{(62.1 \text{ in.})^2} \right] \\ &= -1.28 \text{ ksi} \end{aligned}$$

At the support,

$$\begin{aligned} \tau_w &= \frac{(-29,000 \text{ ksi})(33.0 \text{ in.}^4)}{0.560 \text{ in.}} \left[\frac{(-0.22)(-5.78 \times 10^{-3} \text{ rad./in.})}{(62.1 \text{ in.})^2} \right] \\ &= -0.56 \text{ ksi} \end{aligned}$$

The normal stress due to warping is:

$$\sigma_w = EW_{no} \theta'' \quad (4.3a)$$

At midspan,

$$\begin{aligned} \sigma_w &= (29,000 \text{ ksi})(23.6 \text{ in.}^2) \left[\frac{(-0.44)(-5.78 \times 10^{-3} \text{ rad./in.})}{(62.1 \text{ in.})} \right] \\ &= 28.0 \text{ ksi} \end{aligned}$$

At the support, since $\theta'' = 0$, $\sigma_w = 0$

Calculate Combined Stress

Summarizing stresses due to flexure and torsion:

Location	σ_w	σ_b	f_{un}	τ_t	τ_w	τ_b	f_{uv}
Midspan flange	± 28.0	± 12.4	± 40.4	0	-1.28	± 0.64	-1.92
Midspan web	—	—	—	0	—	± 2.45	± 2.45
Support flange	0	0	0	-10.2	-0.56	± 0.64	-11.4
Support web	—	—	—	-6.16	—	± 2.45	-8.61
Maximum	± 40.4						-11.4

Thus, as illustrated in Figure 5.2, it can be seen that the maximum normal stress occurs at midspan in the flange at the left side tips of the flanges when viewed toward the left support and the maximum shear stress occurs at the support in the middle of the flange.

Calculate Maximum Rotation

The maximum rotation occurs at midspan. The service-load torque is:

$$T = Pe$$

$$= -10 \text{ kips} \times 6 \text{ in.}$$

$$= -60 \text{ kip-in.}$$

and the maximum rotation is:

$$\theta = +0.09 \frac{Tl}{GJ}$$

$$= \frac{0.09(-60 \text{ kip-in.})(180 \text{ in.})}{(11,200 \text{ ksi})(1.39 \text{ in.}^4)}$$

$$= -0.062 \text{ rad.}$$

Example 5.2

Repeat Example 5.1 for a **TS10**×6×½ ($F_y = 50 \text{ ksi}$). Compare the magnitudes of the resulting stresses and rotation with those determined in Example 5.1.

Given:

$$S_x = 36.2 \text{ in.}^3$$

$$J = 187 \text{ in.}^4$$

Solution:

Calculate Bending Stresses

From Example 5.1,

$$M_u = 675 \text{ kip-in.}$$

$$V_u = 7.5 \text{ kips}$$

$$\sigma_b = \frac{M_u}{S_x} \tag{4.5}$$

$$= \frac{675 \text{ kip-in.}}{36.2 \text{ in.}^3}$$

$$= 18.7 \text{ ksi}$$

$$\tau_b = \frac{V_u}{A_v} \tag{4.11}$$

$$= \frac{7.5 \text{ kips}}{2 \times 10 \text{ in.} \times \frac{1}{2} \text{ in.}}$$

$$= 0.75 \text{ ksi}$$

Calculate Torsional Stress

From Example 5.1,

$$T_u = -90 \text{ kip-in.}$$

$$\tau_t = \frac{T_u}{2tA_o} \tag{4.4}$$

$$= \frac{-90 \text{ kip-in.}}{2(\frac{1}{2} \text{ in.})(9.5 \text{ in.} \times 5.5 \text{ in.})}$$

$$= -1.72 \text{ ksi}$$

Calculate Combined Stress

$$f_{uv} = \tau_b + \tau_t \tag{4.10}$$

$$= \pm 0.75 \text{ ksi} - 1.72 \text{ ksi}$$

$$= -2.47 \text{ ksi}$$

Calculate Maximum Rotation

From Example 5.1,

$$T = -60 \text{ kip-in.}$$

$$\theta = \frac{(T/2)(l/2)}{GJ}$$

$$= \frac{(-60 \text{ kip-in.}/2)(180 \text{ in.}/2)}{(11,200 \text{ ksi})(187 \text{ in.}^4)}$$

$$= -0.0013 \text{ rad.}$$

Comparing the magnitudes of the maximum stresses and rotation for this HSS with those for the W-shape of Example 5.1:

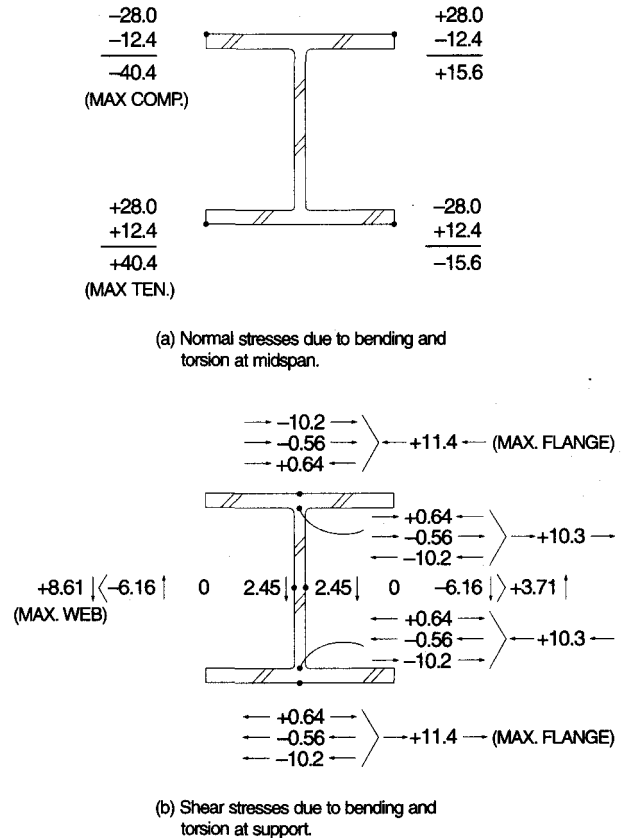

Figure 5.2.

	W10×49	TS10×6×½
f_{un}	40.4 ksi	18.7 ksi
f_{uv}	11.4 ksi	2.47 ksi
θ	0.062 rad.	0.0013 rad.

Thus, stresses and rotation are significantly reduced in comparable closed sections when torsion is a major factor.

Example 5.3

Repeat Example 5.1 assuming the concentrated force is introduced by a W6x9 column framed rigidly to the W10x49 beam as illustrated in Figure 5.3. Assume the column is 12 ft long with its top pinned end and a floor diaphragm provides lateral restraint at the load point. Compare the magnitudes of the resulting stresses and rotation with those determined in Examples 5.1 and 5.2.

Given:

For the W10X49 beam:

$$S_y = 18.7 \text{ in.}^4$$

For the W6x9 column:

$$A = 2.68 \text{ in.}^2$$

$$I_x = 16.4 \text{ in.}^4$$

$$r_x = 2.47 \text{ in.}$$

Solution:

In this example, the torsional restraint provided by the rigid connection joining the beam and column will be utilized.

Determine Flexural Stiffness of Column

$$\begin{aligned} \frac{M}{\theta} &= \frac{3EI_x}{l} \\ &= \frac{3(29,000 \text{ ksi})(16.4 \text{ in.}^4)}{144 \text{ in.}} \end{aligned}$$

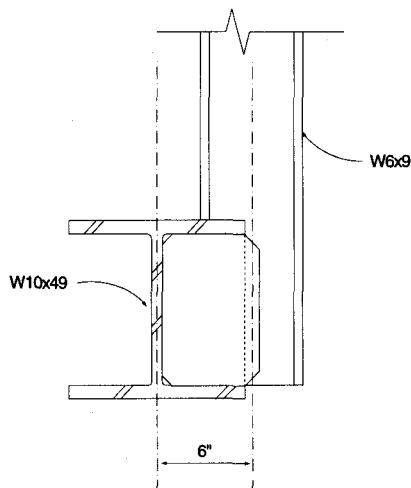

Figure 5.3.

$$= 9,910 \text{ kip-in./rad.}$$

Determine Torsional Stiffness of Beam

From Example 5.1,

$$\theta = 0.09 \frac{Tl}{GJ}$$

or

$$\frac{T}{\theta} = \frac{GJ}{0.09l}$$

$$= \frac{(11,200 \text{ ksi})(1.39 \text{ in.}^4)}{0.09(180 \text{ in.})}$$

$$= 961 \text{ kip-in./rad.}$$

Determine Distribution of Moment

	Stiffness	Relative Stiffness	Moment
Beam	961	0.09	8.1 kip-in.
Column	9,910	0.91	81.9 kip-in.
Total	10,871	1.00	90.0 kip-in.

Thus, the torsional moment on the beam has been reduced from 90 kip-in. to 8.1 kip-in. The column must be designed for an axial load of 15 kips plus an end-moment of 81.9 kip-in. The beam must be designed for the torsional moment of 8.1 kip-in., the 15-kip force from the column axial load, and a lateral force P_{uy} due to the horizontal reaction at the bottom of the column, where

$$\begin{aligned} P_{uy} &= \frac{M_u}{l} \\ &= \frac{81.9 \text{ kip-in.}}{144 \text{ in.}} \\ &= 0.57 \text{ kips} \end{aligned}$$

Calculate Bending Stresses

From Example 5.1,

$$\sigma_{bx} = 12.4 \text{ ksi}$$

$$\tau_{bw} = 2.45 \text{ ksi}$$

$$\tau_{bf} = 0.64 \text{ ksi}$$

In the weak axis,

$$\begin{aligned} M_{uy} &= \frac{P_{uy}l}{4} \\ &= \frac{0.57 \text{ kips}(180 \text{ in.})}{4} \end{aligned}$$

$$= 25.6 \text{ kip-in.}$$

$$V_{uy} = \frac{P_{uy}}{2}$$

$$= \frac{0.57 \text{ kips}}{2}$$

$$= 0.29 \text{ kips}$$

$$\sigma_{by} = \frac{M_{uy}}{S_y} \quad (4.5)$$

$$= \frac{25.6 \text{ kip-in.}}{18.7 \text{ in.}^3}$$

$$= 1.37 \text{ ksi}$$

$$\tau_{by} = \frac{P_{uy} \times 1.5}{2A_f} \quad (4.2b)$$

$$= \frac{0.57 \text{ kips} \times 1.5}{2(10.0 \text{ in.} \times 0.560 \text{ in.})}$$

$$= 0.076 \text{ ksi}$$

Calculate Torsional Stress

Since the torsional moment has been reduced to 9 percent of that used in Example 5.1, the torsional stresses are also reduced to 9 percent of those calculated in Example 5.1. These stresses are summarized below.

Calculate Combined Stress

Summarizing stresses due to flexure and torsion

Location		σ_w	σ_{bx}	σ_{by}	f_{un}	
Midspan	flange	-2.52	± 12.4	± 1.37	-16.3	
	web	—	—	—	—	
Support	flange	0	0	0	0	
	web	—	—	—	—	
Maximum					-16.3	
Location		τ_t	τ_w	τ_{bx}	τ_{by}	f_{uv}
Midspan	flange	0	-0.12	± 0.64	± 0.076	-0.84
	web	0	—	± 2.45	—	± 2.45
Support	flange	-0.92	-0.05	± 0.64	± 0.076	-1.67
	web	-0.55	—	± 2.45	—	-3.00
Maximum					-3.00	

As before, the maximum normal stress occurs at midspan in the flange. In this case, however, the maximum shear stress occurs at the support in the web.

Calculate Maximum Rotation

Since the torsional moment has been reduced to 9 percent of

that used in Example 5.1, the maximum rotation, which occurs at midspan, is also reduced to 9 percent of that calculated in Example 5.1 or:

$$\theta = -0.0056 \text{ rad.}$$

Comments

Comparing the magnitudes of the stresses and rotation for this case with that of Example 5.1:

	W10x49 unrestrained	W10x49 restrained
f_{un}	40.4 ksi	16.3 ksi
f_{uv}	11.4 ksi	3.00 ksi
θ	0.062 rad.	0.0056 rad.

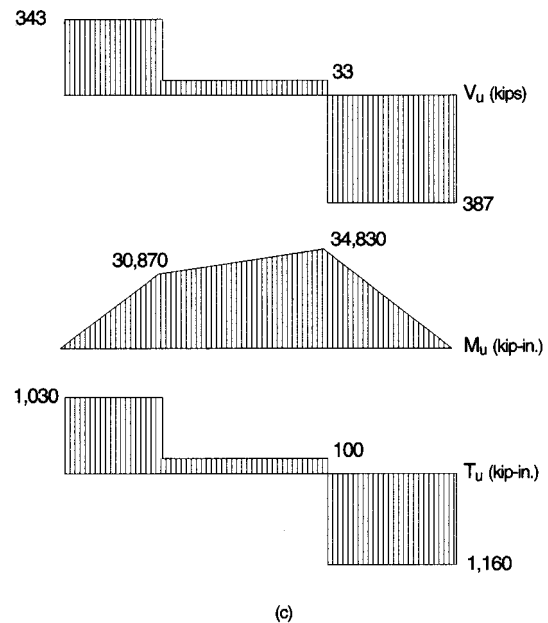
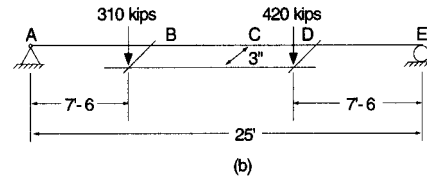
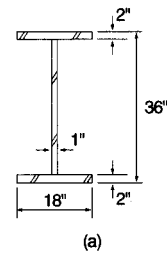

Figure 5.4.

Thus, consideration of available torsional restraint significantly reduces the torsional stresses and rotation.

Example 5.4

The welded plate-girder shown in Figure 5.4a spans 25 ft (300 in.) and supports 310-kip and 420-kip factored loads (210-kip and 285-kip service loads). As illustrated in Figure 5.4b, these concentrated loads are acting at a 3-in. eccentricity with respect to the shear center. Determine the stresses on the cross-section and the torsional rotation.

Given:

The end conditions are assumed to be flexurally and torsionally pinned.

Solution:

Calculate Cross-Sectional Properties

$$I_x = \frac{(18 \text{ in.})(36 \text{ in.})^3}{12} - \frac{(18 \text{ in.})(32 \text{ in.})^3}{12} + \frac{(1 \text{ in.})(32 \text{ in.})^3}{12}$$

$$= 23,600 \text{ in.}^4$$

$$S_x = \frac{I_x}{c_x}$$

$$= \frac{23,600 \text{ in.}^4}{18 \text{ in.}}$$

$$= 1,310 \text{ in.}^3$$

$$I_y = \frac{(36 \text{ in.})(18 \text{ in.})^3}{12} - \frac{(32 \text{ in.})(18 \text{ in.})^3}{12} + \frac{(32 \text{ in.})(1 \text{ in.})^3}{12}$$

$$= 1,950 \text{ in.}^4$$

$$S_y = \frac{I_y}{c_y}$$

$$= \frac{1,950 \text{ in.}^4}{9 \text{ in.}}$$

$$= 217 \text{ in.}^3$$

Calculate Torsional Properties

$$J \approx \sum \frac{bt^3}{3} \quad (3.4)$$

$$\approx \frac{(2 \times 18 \text{ in.})(2 \text{ in.})^3}{3} + \frac{(32 \text{ in.})(1 \text{ in.})^3}{3}$$

$$\approx 107 \text{ in.}^4$$

$$h = d - t_f \quad (3.11)$$

$$= 36 \text{ in.} - 2 \text{ in.}$$

$$= 34 \text{ in.}$$

$$C_w = \frac{I_y h^2}{4} \quad (3.5)$$

$$= \frac{(1,950 \text{ in.}^4)(34 \text{ in.})^2}{4}$$

$$= 564,000 \text{ in.}^6$$

$$a = \frac{h}{2} \sqrt{\frac{EI_y}{GJ}} \quad (3.6)$$

$$= \frac{34 \text{ in.}}{2} \sqrt{\frac{(29,000 \text{ ksi})(1,950 \text{ in.}^4)}{(11,200 \text{ ksi})(107 \text{ in.}^4)}}$$

$$= 117 \text{ in.}$$

$$W_{no} = \frac{hb_f}{4} \quad (3.7)$$

$$= \frac{(34 \text{ in.})(18 \text{ in.})}{4}$$

$$= 153 \text{ in.}^2$$

$$S_w = \frac{hb_f^2 t_f}{16} \quad (3.8)$$

$$= \frac{(34 \text{ in.})(18 \text{ in.})^2(2 \text{ in.})}{16}$$

$$= 1,380 \text{ in.}^4$$

$$Q_f = \frac{ht_f(b_f - t_w)}{4} \quad (3.9)$$

$$= \frac{(34 \text{ in.})(2 \text{ in.})(18 \text{ in.} - 1 \text{ in.})}{4}$$

$$= 289 \text{ in.}^3$$

$$Q_w = \frac{hb_f t_f}{2} + \frac{(h - t_f)^2 t_w}{8} \quad (3.10)$$

$$= \frac{(34 \text{ in.})(18 \text{ in.})(2 \text{ in.})}{2} + \frac{(34 \text{ in.} - 2 \text{ in.})^2(1 \text{ in.})}{8}$$

$$= 740 \text{ in.}^3$$

Calculate Bending Stresses

By inspection, points D and E are most critical. At point D:

$$\sigma_b = \frac{M_u}{S_x} \quad (4.5)$$

$$= \frac{34,830 \text{ kip-in.}}{1,310 \text{ in.}^3}$$

$$= 26.6 \text{ ksi (compression at top; tension at bottom)}$$

At point E, $\sigma_b = 0$.

Between points D and E:

$$\tau_{bw} = \frac{V_u Q_w}{I_x t_w} \quad (4.6)$$

$$= \frac{(387 \text{ kips})(740 \text{ in.}^3)}{(23,600 \text{ in.}^4)(1 \text{ in.})}$$

$$= 12.1 \text{ ksi}$$

$$\tau_{bf} = \frac{V_u Q_f}{I_x t_f} \quad (4.6)$$

$$= \frac{(387 \text{ kips})(289 \text{ in.}^3)}{(23,600 \text{ in.}^4)(2 \text{ in.})}$$

$$= 2.37 \text{ ksi}$$

For this loading, shear stresses are constant from point D to point E.

Calculate Torsional Stresses

$$T_{uB} = 310 \text{ kips} \times 3 \text{ in.}$$

$$= 930 \text{ kip-in.}$$

$$T_{uD} = 420 \text{ kips} \times 3 \text{ in.}$$

$$= 1,260 \text{ kip-in.}$$

The effect of each torque at points D and E will be determined individually and then combined by superposition.

Use Case 3 with $\alpha = 0.3$ (The effects of each load are added by superposition).

$$\frac{l}{a} = \frac{300 \text{ in.}}{117 \text{ in.}}$$

$$= 2.56$$

$$\frac{T_{uB}}{GJ} = \frac{+930 \text{ kip-in.}}{(11,200 \text{ ksi})(107 \text{ in.}^4)}$$

$$= +7.76 \times 10^{-4} \text{ rad/in.}$$

$$\frac{T_{uD}}{GJ} = \frac{+1,260 \text{ kip-in.}}{(11,200 \text{ ksi})(107 \text{ in.}^4)}$$

$$= +1.05 \times 10^{-3} \text{ rad/in.}$$

At point D ($z/l = 0.7$ for T_{uB} , $z/l = 0.3$ for T_{uD}):

$$\theta = +0.045 \frac{T_{uB} l}{GJ} + 0.060 \frac{T_{uD} l}{GJ}$$

$$= +2.94 \times 10^{-2} \text{ rad.}$$

$$\theta'' = -0.11 \frac{T_{uB}}{GJa} + -0.38 \frac{T_{uD}}{GJa}$$

$$= -4.14 \times 10^{-6} \text{ rad./in.}^2$$

$$\theta' = -0.12 \frac{T_{uB}}{GJ} + -0.10 \frac{T_{uD}}{GJ}$$

$$= -1.98 \times 10^{-4} \text{ rad./in.}$$

$$\theta''' = +0.17 \frac{T_{uB}}{GJa^2} + +0.60 \frac{T_{uD}}{GJa^2}$$

$$= +5.57 \times 10^{-8} \text{ rad./in.}^3$$

At point E ($z/l = 1.0$ for T_{uB} , $z/l = 0.0$ for T_{uD}):

$$\theta = 0$$

$$\theta'' = 0$$

$$\theta' = -0.16 \frac{T_{uB}}{GJ} + -0.25 \frac{T_{uD}}{GJ}$$

$$= -3.87 \times 10^{-4} \text{ rad./in.}$$

$$\theta''' = +0.13 \frac{T_{uB}}{GJa^2} + +0.47 \frac{T_{uD}}{GJa^2}$$

$$= +4.34 \times 10^{-8} \text{ rad./in.}^3$$

The shear stress due to pure torsion is calculated as:

$$\tau_t = Gt\theta' \quad (4.1)$$

and the stresses are as follows:

τ_t , ksi		
Point	Flange ($t = 2 \text{ in.}$)	Web ($t = 1 \text{ in.}$)
D	-4.47	-2.24
E	-8.75	-4.37

The shear stress due to warping is calculated as:

$$\tau_w = \frac{-ES_w \theta'''}{t_f} \quad (4.2a)$$

At point D,

$$\tau_w = \frac{-(29,000 \text{ ksi})(1,380 \text{ in.}^4)(+5.57 \times 10^{-8} \text{ rad./in.}^3)}{(2 \text{ in.})}$$

$$= -1.11 \text{ ksi}$$

At point E,

$$\tau_w = \frac{-(29,000 \text{ ksi})(1,380 \text{ in.}^4)(+4.34 \times 10^{-8} \text{ rad./in.}^3)}{(2 \text{ in.})}$$

$$= -0.87 \text{ ksi}$$

The normal stress due to warping is calculated as:

$$\sigma_w = EW_{no} \theta'' \quad (4.3a)$$

At point D,

$$\begin{aligned}\sigma_w &= (29,000 \text{ ksi})(153 \text{ in.}^2)(-4.14 \times 10^{-6} \text{ rad./in.}^2) \\ &= -18.4 \text{ ksi}\end{aligned}$$

At point E, since $\theta'' = 0$, $\sigma_w = 0$

Calculate Combined Stress

Summarizing stresses due to flexure and torsion:

Location		σ_w	σ_b	f_{un}	
Point D	flange	-18.4	± 26.6	-45.0	
	web	—	—	—	
Point E	flange	0	0	0	
	web	—	—	—	
Maximum				-45.0	
Location		τ_t	τ_w	τ_b	f_{uw}
Point D	flange	-4.47	-1.11	± 2.37	-7.95
	web	-2.24	—	± 12.1	-14.3
Point E	flange	-8.75	-0.87	± 2.37	-12.0
	web	-4.37	—	± 12.1	-16.5
Maximum				-16.5	

Thus, it can be seen that the maximum normal stress occurs at point D in the flange and the maximum shear stress occurs at point E (the support) in the web.

Calculate Maximum Rotation

From Appendix B, Case 3 with $a = 0.3$, it is estimated that the maximum rotation will occur at approximately 14½ feet

from the left end of the beam (point A). At this location, $z/l \approx 0.58$ for T_b and $z/l \approx (1 - 0.58) = 0.42$ for T_D .

The service-load torques are:

$$\begin{aligned}T_B &= 210 \text{ kips} \times 3 \text{ in.} \\ &= 630 \text{ kip-in.}\end{aligned}$$

$$\begin{aligned}T_D &= 285 \text{ kips} \times 3 \text{ in.} \\ &= 855 \text{ kip-in.}\end{aligned}$$

The maximum rotation is:

$$\begin{aligned}\theta &= +0.055 \frac{T_B l}{GJ} + 0.065 \frac{T_D l}{GJ} \\ &= \frac{0.055(630 \text{ kip-in.})(300 \text{ in.})}{(11,200 \text{ ksi})(107 \text{ in.}^4)} + \\ &\quad \frac{0.065(855 \text{ kip-in.})(300 \text{ in.})}{(11,200 \text{ ksi})(107 \text{ in.}^4)} \\ &= 0.023 \text{ rad.}\end{aligned}$$

Example 5.5

The MC18x42.7 channel illustrated in Figure 5.5a spans 12 ft (144 in.) and supports a uniformly distributed factored load of 3.6 kips/ft (2.4 kips/ft service load) acting through the centroid of the channel. Determine the stresses on the cross-section and the torsional rotation,

Given:

The end conditions are assumed to be flexurally and torsionally fixed. The eccentric load can be resolved into a torsional moment and a load applied through the shear center as shown in Figure 5.5b. The resulting flexural and torsional loadings are illustrated in Figure 5.5c. The torsional properties are as follows:

$$\begin{aligned}J &= 1.23 \text{ in.}^4 \\ a &= 42.4 \text{ in.} \\ C_w &= 852 \text{ in.}^6 \\ W_{no} &= 22.0 \text{ in.}^2 \\ W_{n2} &= 10.4 \text{ in.}^2 \\ S_{w1} &= 17.4 \text{ in.}^4 \\ S_{w2} &= 13.5 \text{ in.}^4 \\ S_{w3} &= 6.75 \text{ in.}^4 \\ e_o &= 0.969 \text{ in.} \\ Q_f &= 19.7 \text{ in.}^3 \\ Q_w &= 37.9 \text{ in.}^3\end{aligned}$$

The flexural properties are as follows:

$$\begin{aligned}I_x &= 554 \text{ in.}^4 \\ S_x &= 61.6 \text{ in.}^3 \\ t_f &= 0.625 \text{ in.} \\ t_w &= 0.450 \text{ in.}\end{aligned}$$

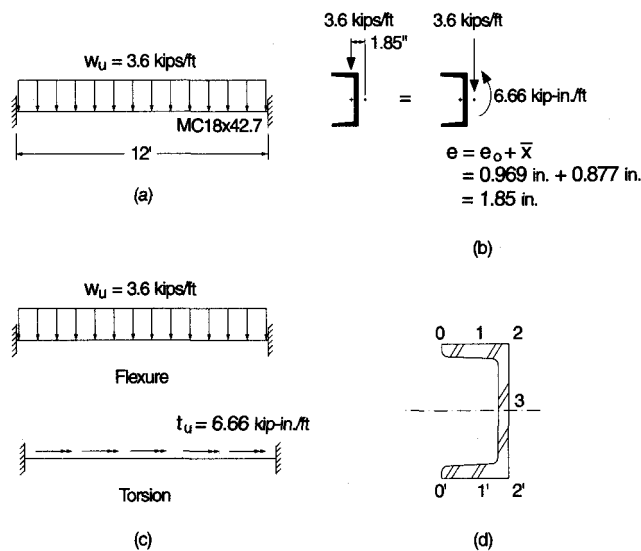

Figure 5.5.

Solution:

From the graphs for Case 7 in Appendix B, the extreme values of the torsional functions are located at z/l values of 0, 0.2, 0.5, and 1.0. Thus, the stresses at the supports ($z/l = 0$ and $z/l = 1.0$), $z/l = 0.2$, and midspan ($z/l = 0.5$) are of interest.

Calculate Bending Stresses

At the support:

$$\begin{aligned}
 M_u &= \frac{w_u l^2}{12} \\
 &= \frac{(3.6 \text{ kips/ft})(12 \text{ ft})^2(12 \text{ in./ft})}{12} \\
 &= 518 \text{ kip-in.} \\
 V_u &= \frac{w_u l}{2} \\
 &= \frac{(3.6 \text{ kips/ft})(12 \text{ ft})}{2} \\
 &= 21.6 \text{ kips} \\
 \sigma_b &= \frac{M_u}{S_x} \tag{4.5} \\
 &= \frac{518 \text{ kip-in.}}{61.6 \text{ in.}^3} \\
 &= 8.41 \text{ ksi}
 \end{aligned}$$

$$\begin{aligned}
 \tau_{bw} &= \frac{V_u Q_w}{I_x t_w} \tag{4.6} \\
 &= \frac{(21.6 \text{ kips})(37.9 \text{ in.}^3)}{(554 \text{ in.}^4)(0.450 \text{ in.})} \\
 &= 3.28 \text{ ksi}
 \end{aligned}$$

$$\begin{aligned}
 \tau_{bf} &= \frac{V_u Q_f}{I_x t_f} \tag{4.6} \\
 &= \frac{(21.6 \text{ kips})(19.7 \text{ in.}^3)}{(554 \text{ in.}^4)(0.625 \text{ in.})} \\
 &= 1.23 \text{ ksi}
 \end{aligned}$$

At midspan ($z/l = 0.5$):

$$\begin{aligned}
 M_u &= \frac{w_u l^2}{24} \\
 &= \frac{(3.6 \text{ kips/ft})(12 \text{ ft})^2(12 \text{ in./ft})}{24} \\
 &= 259 \text{ kip-in.} \\
 \sigma_b &= \frac{M_u}{S_x} \tag{4.5}
 \end{aligned}$$

$$\begin{aligned}
 &= \frac{259 \text{ kip-in.}}{61.6 \text{ in.}^3} \\
 &= 4.20 \text{ ksi}
 \end{aligned}$$

since $V_u = 0$, $\tau_{bw} = \tau_{bf} = 0$.

At $z/l = 0.2$:

$$\begin{aligned}
 V_u &= w_u \left(\frac{l}{2} - 0.2l \right) \\
 &= 3.6 \text{ kips/ft} \left(\frac{12 \text{ ft}}{2} - 0.2(12 \text{ ft}) \right) \\
 &= 13.0 \text{ kips} \\
 \tau_{bw} &= \frac{V_u Q_w}{I_x t_w} \tag{4.6} \\
 &= \frac{(13.0 \text{ kips})(37.9 \text{ in.}^3)}{(554 \text{ in.}^4)(0.450 \text{ in.})} \\
 &= 1.98 \text{ ksi}
 \end{aligned}$$

$$\begin{aligned}
 \tau_{bf} &= \frac{V_u Q_f}{I_x t_f} \tag{4.6} \\
 &= \frac{(13.0 \text{ kips})(19.7 \text{ in.}^3)}{(554 \text{ in.}^4)(0.625 \text{ in.})} \\
 &= 0.740 \text{ ksi}
 \end{aligned}$$

Since M_u is maximum at the support, its value at $z/l = 0.2$, as well as the value of σ_b at $z/l = 0.2$, is not necessary.

Calculate Torsional Stresses

$$\begin{aligned}
 t_u &= w_u e \\
 &= (3.6 \text{ kips/ft})(1.85 \text{ in.}) \\
 &= 6.66 \text{ kip-in./ft}
 \end{aligned}$$

The following functions are taken from Appendix B, Case 7:

$$\begin{aligned}
 \frac{l}{a} &= \frac{144 \text{ in.}}{42.4 \text{ in.}} \\
 &= 3.40
 \end{aligned}$$

At the support ($z/l = 0$):

$$\begin{aligned}
 \theta \times \frac{GJ}{t_u} \times \frac{2}{al} &= 0 & \theta &= 0 \\
 \theta'' \times \frac{GJ}{t_u} \times \frac{2a}{l} &= +0.46 & \theta'' &= +0.46 \frac{t_u l}{2GJa} \\
 \theta' \times \frac{GJ}{t_u} \times \frac{2}{l} &= 0 & \theta' &= 0 \\
 \theta''' \times \frac{GJ}{t_u} \times \frac{2a^2}{l} &= -1.0 & \theta''' &= -1.0 \frac{t_u l}{2GJa^2}
 \end{aligned}$$

At midspan ($z/l = 0.5$):

$$\theta \times \frac{GJ}{t_u} \times \frac{2}{al} = +0.15 \quad \theta = +0.15 \frac{t_u al}{2GJ}$$

$$\theta'' \times \frac{GJ}{t_u} \times \frac{2a}{l} = -0.20 \quad \theta'' = -0.20 \frac{t_u l}{2GJa}$$

$$\theta' \times \frac{GJ}{t_u} \times \frac{2}{l} = 0 \quad \theta' = 0$$

$$\theta''' \times \frac{GJ}{t_u} \times \frac{2a^2}{l} = 0 \quad \theta''' = 0$$

At $z/l = 0.2$:

$$\theta \times \frac{GJ}{t_u} \times \frac{2}{al} = +0.07 \quad \theta = +0.07 \frac{t_u al}{2GJ}$$

$$\theta'' \times \frac{GJ}{t_u} \times \frac{2a}{l} = 0 \quad \theta'' = 0$$

$$\theta' \times \frac{GJ}{t_u} \times \frac{2}{l} = +0.14 \quad \theta' = +0.14 \frac{t_u l}{2GJ}$$

$$\theta''' \times \frac{GJ}{t_u} \times \frac{2a^2}{l} = -0.46 \quad \theta''' = -0.46 \frac{t_u l}{2GJa^2}$$

In the above calculations:

$$\frac{t_u l}{GJ} = \frac{(6.66 \text{ kip-in./ft})(12 \text{ ft})}{(11,200 \text{ ksi})(1.23 \text{ in.}^4)} = 5.80 \times 10^{-3} \text{ rad./in.}$$

The shear stress due to pure torsion is:

$$\tau_t = Gt\theta' \quad (4.1)$$

At the support, and at midspan, since $\theta' = 0$, $\tau_t = 0$. At $z/l = 0.2$, for the web,

$$\tau_t = (11,200 \text{ ksi})(0.450 \text{ in.}) \left(\frac{0.14 \times 5.80 \times 10^{-3} \text{ rad./in.}}{2} \right) = 2.05 \text{ ksi}$$

and for the flange,

$$\tau_t = (11,200 \text{ ksi})(0.625 \text{ in.}) \left(\frac{0.14 \times 5.80 \times 10^{-3} \text{ rad./in.}}{2} \right) = 2.84 \text{ ksi}$$

The shear stress at point s due to warping is:

$$\tau_{ws} = \frac{-ES_{ws}\theta'''}{t} \quad (4.2a)$$

(Refer to Figure 5.5d or Appendix A for locations of critical points s)

At midspan, since $\theta''' = 0$, $\tau_w = 0$. At the support,

$$\tau_{w1} = \frac{-(29,000 \text{ ksi})(17.4 \text{ in.}^4)}{(0.625 \text{ in.})} \left[\frac{-1.0 \times 5.80 \times 10^{-3} \text{ rad./in.}}{2(42.4 \text{ in.})^2} \right] = 1.30 \text{ ksi}$$

$$\tau_{w2} = \frac{-(29,000 \text{ ksi})(13.5 \text{ in.}^4)}{(0.625 \text{ in.})} \left[\frac{-1.0 \times 5.80 \times 10^{-3} \text{ rad./in.}}{2(42.4 \text{ in.})^2} \right] = 1.01 \text{ ksi}$$

$$\tau_{w3} = \frac{-(29,000 \text{ ksi})(6.75 \text{ in.}^4)}{(0.450 \text{ in.})} \left[\frac{-1.0 \times 5.80 \times 10^{-3} \text{ rad./in.}}{2(42.4 \text{ in.})^2} \right] = 0.702 \text{ ksi}$$

At $z/l = 0.2$,

$$\tau_{w1} = \frac{-(29,000 \text{ ksi})(17.4 \text{ in.}^4)}{(0.625 \text{ in.})} \left[\frac{-0.46 \times 5.80 \times 10^{-3} \text{ rad./in.}}{2(42.4 \text{ in.})^2} \right] = 0.599 \text{ ksi}$$

$$\tau_{w2} = \frac{-(29,000 \text{ ksi})(13.5 \text{ in.}^4)}{(0.625 \text{ in.})} \left[\frac{-0.46 \times 5.80 \times 10^{-3} \text{ rad./in.}}{2(42.4 \text{ in.})^2} \right] = 0.465 \text{ ksi}$$

$$\tau_{w3} = \frac{-(29,000 \text{ ksi})(6.75 \text{ in.}^4)}{(0.450 \text{ in.})} \left[\frac{-0.46 \times 5.80 \times 10^{-3} \text{ rad./in.}}{2(42.4 \text{ in.})^2} \right] = 0.323 \text{ ksi}$$

The normal stress at point s due to warping is:

$$\sigma_{ws} = EW_{ns}\theta'' \quad (4.3a)$$

At the support,

$$\sigma_{w1} = (29,000 \text{ ksi})(22.0 \text{ in.}^2) \left(\frac{0.46 \times 5.80 \times 10^{-3} \text{ rad./in.}}{2 \times 42.4 \text{ in.}} \right) = 20.1 \text{ ksi}$$

$$\sigma_{w2} = (29,000 \text{ ksi})(10.4 \text{ in.}^2) \left(\frac{0.46 \times 5.80 \times 10^{-3} \text{ rad./in.}}{2 \times 42.4 \text{ in.}} \right) = 9.49 \text{ ksi}$$

At midspan,

$$\sigma_{w1} = (29,000 \text{ ksi})(22.0 \text{ in.}^2) \left(\frac{-0.20 \times 5.80 \times 10^{-3} \text{ rad./in.}}{2 \times 42.4 \text{ in.}} \right) = -8.73 \text{ ksi}$$

$$\sigma_{w2} = (29,000 \text{ ksi})(10.4 \text{ in.}^2) \left(\frac{-0.20 \times 5.80 \times 10^{-3} \text{ rad./in.}}{2 \times 42.4 \text{ in.}} \right) = -4.13 \text{ ksi}$$

At $z/l = 0.2$, since $\theta'' = 0$, $\sigma_{ws} = 0$.

Calculate Combined Stress

Summarizing stresses due to flexure and torsion:

Location	Point	σ_w	σ_b	f_{un}	
Support	0	20.1(C)	8.41(T)	11.7(C)	
	1	0	8.41(T)	8.41(T)	
	2	9.49(T)	8.41(T)	17.9(T)	
	3	0	0	0	
Midspan	0	8.73(T)	4.20(C)	4.53(T)	
	1	0	4.20(C)	4.20(C)	
	2	4.13(C)	4.20(C)	8.33(C)	
	3	0	0	0	
$z/l = 0.20$	0	0	—	—	
	1	0	—	—	
	2	0	—	—	
	3	0	—	—	
Maximum				17.9(T)	
Location	Point	τ_t	τ_w	τ_b	f_{uv}
Support	0	0	0	0	0
	1	0	1.30←	—	1.30←
	2	0	1.01←	1.23→	0.22→
	3	0	0.702↓	3.28↓	3.98↓
Midspan	0	0	0	0	0
	1	0	0	0	0
	2	0	0	0	0
	3	0	0	0	0
$z/l = 0.20$	0	2.84←	0	0	2.84←
	1	2.84←	0.599←	—	3.44←
	2	2.84→	0.465←	0.740→	3.12→
	3	2.05↓	0.323↓	1.98↓	4.35↓
Maximum				4.35↓	

Thus, it can be seen that the maximum normal stress (tension) occurs at the support at point 2 in the the flange and the maximum shear stress occurs at $z/l = 0.20$ at point 3 in the web.

Calculate Maximum Rotation

The maximum rotation occurs at midspan. The service-load distributed torque is:

$$\begin{aligned}
 t &= we \\
 &= 2.4 \text{ kips/ft} \times 1.85 \text{ in.} \\
 &= 4.44 \text{ kip-in./ft}
 \end{aligned}$$

and the maximum rotation is:

$$\begin{aligned}
 \theta &= +0.15 \frac{tal}{2GJ} \\
 &= \frac{0.15(4.44 \text{ kip-in./ft})(42.4 \text{ in.})(12 \text{ ft})}{2(11,200 \text{ ksi})(1.23 \text{ in.}^4)}
 \end{aligned}$$

$$= 0.012 \text{ rad.}$$

Example 5.6

As illustrated in Figure 5.6a, a 3x3x1/2 single angle is cantilevered 2 ft (24 in.) and supports a 2-kip factored load (1.33-kip service load) at midspan that acts as shown with a 1.5-in. eccentricity with respect to the shear center. Determine the stresses on the cross-section, the torsional rotation, and if the member is adequate if $F_y = 50 \text{ ksi}$.

Given:

The end condition is assumed to be flexurally and torsionally fixed. The eccentric load can be resolved into a torsional moment and a load applied through the shear center as shown in Figure 5.6b. The resulting flexural and torsional loadings are illustrated in Figure 5.6c. The flexural and torsional properties are as follows:

$$\begin{aligned}
 J &= 0.234 \text{ in.}^4 \\
 S_x &= 1.07 \text{ in.}^3
 \end{aligned}$$

Solution:

Check Flexure

$$\begin{aligned}
 M_u &= P_u l \\
 &= 2 \text{ kips} \times 24 \text{ in.} \\
 &= 48 \text{ kip-in.}
 \end{aligned}$$

Since the stresses due to warping of single-angle members are negligible, the flexural design strength will be checked according to the provisions of the AISC Specification for LRFD of Single Angle Members (AISC, 1993b).

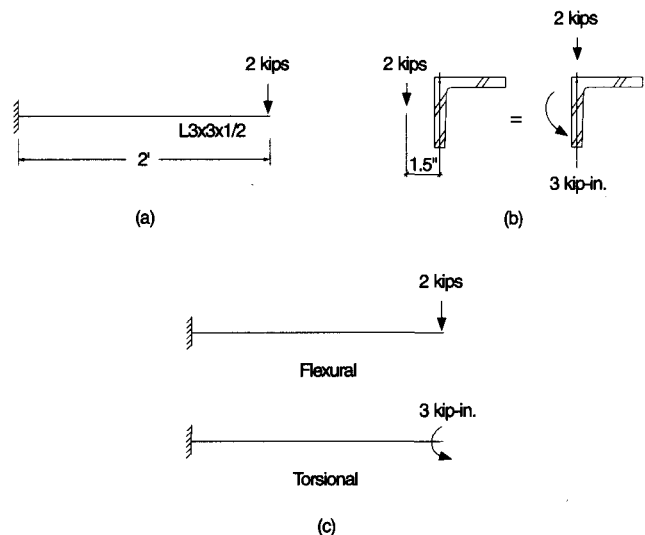

Figure 5.6.

With the tip of the vertical angle leg in compression, local buckling and lateral torsional buckling must be checked. The following checks are made for bending about the geometric axes (Section 5.2.2).

For local buckling (Section 5.1.1),

$$b/t = \frac{3}{0.5}$$

$$= 6 < 0.382 \sqrt{\frac{E}{F_y}}$$

$$\therefore M_n = 1.25M_y$$

$$M_y = F_y(0.80S_x)$$

$$= 50 \text{ ksi} (0.80 \times 1.07 \text{ in.}^3)$$

$$= 42.8 \text{ kip-in.}$$

$$\phi M_n = 0.9(1.25M_y)$$

$$= 0.9 (1.25 \times 42.8 \text{ kip-in.})$$

$$= 48.2 \text{ kip-in.}$$

For LTB,

$$M_{ob} = 1.25 \frac{0.66Eb^4tC_b}{I^2} \left(\sqrt{1 + 0.78 \left(\frac{lt}{b^2} \right)^2} - 1 \right)$$

$$= 1.25 \left[\frac{0.66(29,000 \text{ ksi})(3 \text{ in.})^4(\frac{1}{2} \text{ in.})(1.0)}{(24 \text{ in.})^2} \times \right.$$

$$\left. \left(\sqrt{1 + 0.78 \left(\frac{(24 \text{ in.})(\frac{1}{2} \text{ in.})}{(3 \text{ in.})^2} \right)^2} - 1 \right) \right]$$

$$= 917 \text{ kip-in.}$$

Since $M_{ob} > M_y$,

$$\phi M_n = 0.9 \left(1.58 - 0.83 \sqrt{\frac{M_y}{M_{ob}}} \right) M_y \leq 0.9(1.25M_y)$$

$$= 0.9 \left(1.58 - 0.83 \sqrt{\frac{42.8 \text{ kip-in.}}{917 \text{ kip-in.}}} \right) (42.8 \text{ kip-in.})$$

$$\leq 48.2 \text{ kip-in.}$$

$$= 54.0 \text{ kip-in.} > 48.2 \text{ kip-in.}$$

$$\therefore \phi M_n = 48.2 \text{ kip-in.} > 48 \text{ kip-in.} \quad \mathbf{o.k.}$$

Check Shear Due to Flexure and Torsion

The shear stress due to flexure is,

$$\tau_b = \frac{P_u}{A_v}$$

$$= \frac{2 \text{ kips}}{3 \text{ in.} \times \frac{1}{2} \text{ in.}}$$

$$= 1.33 \text{ ksi}$$

$$\tau_t = \frac{T_u t}{J}$$

$$= \frac{(3 \text{ kip-in.})(\frac{1}{2} \text{ in.})}{0.234 \text{ in.}^4}$$

$$= 6.41 \text{ ksi}$$

The total shear stress is,

$$f_{uv} = \tau_b + \tau_t$$

$$= 1.33 \text{ ksi} + 6.41 \text{ ksi}$$

$$= 7.74 \text{ ksi}$$

From LRFD Single-Angle Specification Section 3,

$$\phi f_n = 0.9(0.6F_y)$$

$$= 0.9(0.6 \times 50 \text{ ksi})$$

$$= 27 \text{ ksi} > 7.74 \text{ ksi} \quad \mathbf{o.k.}$$

Calculate Maximum Rotation

The maximum rotation will occur at the free end of the cantilever. The service-load torque is:

$$T = Pe$$

$$= 1.33 \text{ kips} \times 1.5 \text{ in.}$$

$$= 2.00 \text{ kip-in.}$$

and the maximum rotation is:

$$\theta = \frac{Tl}{GJ}$$

$$= \frac{(2.00 \text{ kip-in.})(24 \text{ in.})}{(11,200 \text{ ksi})(0.234 \text{ in.}^4)}$$

$$= 0.018 \text{ rad.}$$

Example 5.7

The crane girder and loading illustrated in Figure 5.7 is taken from Example 18.1 of the AISC Design Guide *Industrial*

Buildings: Roofs to Column Anchorage (Fisher, 1993). Use the approximate approach of Section 4.1.4 to calculate the maximum normal stress on the combined section. Determine if the member is adequate if $F_y = 36$ ksi.

Given:

For the strong-axis direction:

$M_{ux} = 679$ kip-ft (strong-axis bending moment on combined section)

$S_1 = 268$ in.³

$S_2 = 436$ in.³

Note that the subscripts 1 and 2 indicate that the section modulus is calculated relative to the bottom and top, respectively, of the combined shape. For the channel/top flange assembly:

$M_{uf} = 38.9$ kip-ft (weak-axis bending moment on top flange assembly)

$S_t = 50.3$ in.³

Note that the subscript t indicates that the section modulus is calculated based upon the properties of the channel and top flange area only.

Solution:

Calculate Normal Stress Due to Strong-Axis Bending

$$\begin{aligned} \sigma_{bx\ top} &= \frac{M_{ux}}{S_2} & (4.5) \\ &= \frac{679 \text{ kip-ft}(12 \text{ in./ft})}{436 \text{ in.}^3} \\ &= 18.7 \text{ ksi} \end{aligned}$$

$$\sigma_{bx\ bottom} = \frac{M_{ux}}{S_1} \quad (4.5)$$

$$= \frac{679 \text{ kip-ft}(12 \text{ in./ft})}{268 \text{ in.}^3}$$

$$= 30.4 \text{ ksi}$$

Calculate Normal Stress due to Warping

From Section 4.1.4, the normal stress due to warping may be approximated as:

$$\sigma_w = \frac{M_{uf}}{S_t} \quad (4.3b)$$

$$= \frac{38.9 \text{ kip-ft}(12 \text{ in./ft})}{50.3 \text{ in.}^3}$$

$$= 9.28 \text{ ksi}$$

Calculate Total Normal Stress

$$f_{un\ top} = \sigma_{bx\ top} + \sigma_w \quad (4.8a)$$

$$= 18.7 \text{ ksi} + 9.28 \text{ ksi}$$

$$= 28.0 \text{ ksi}$$

$$f_{un\ bottom} = 30.4 \text{ ksi} \leftarrow \text{controls}$$

Check Design Strength

$$\phi F_y = 0.9(36 \text{ ksi})$$

$$= 32.4 \text{ ksi} > 30.4 \text{ ksi} \quad \text{o.k.}$$

Comments

Since it is common practice in crane-girder design to assume that the lateral loads are resisted only by the top flange assembly, the approximate solution of Section 4.1.4 is extremely useful for this case.

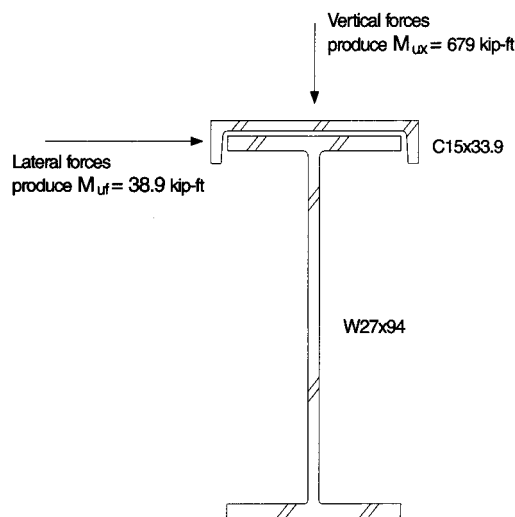
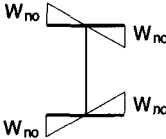

Figure 5.7.

Appendix A

TORSIONAL PROPERTIES



W-, M-, S-, and HP-Shapes

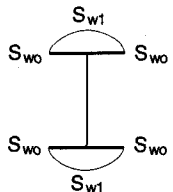

Shape	Torsional Properties					Static Moments	
	<i>J</i>	<i>C_w</i>	<i>a</i>	<i>W_{no}</i>	<i>S_{w1}</i>	<i>Q_r</i>	<i>Q_w</i>
	in. ⁴	in. ⁶	in.	in. ²	in. ⁴	in. ³	in. ³
W44x335	74.4	536,000	137	168	1,190	282	811
290	51.5	463,000	153	166	1,040	251	709
262	37.7	406,000	167	165	922	225	636
230	24.9	346,000	190	164	789	194	551
W40x593	445	996,000	76.1	166	2,240	484	1,380
503	279	791,000	85.7	158	1,540	409	1,160
431	177	639,000	96.7	156	1,380	347	981
372	116	528,000	109	154	1,240	300	836
321	75.4	437,000	123	152	1,100	258	717
297	61.2	397,000	130	151	986	240	665
277	38.1	378,000	160	151	940	230	624
249	37.7	333,000	151	149	836	208	560
215	24.4	283,000	173	149	714	179	481
199	18.1	245,000	187	148	621	157	434
174	11.2	189,000	209	147	481	119	364
W40x466	277	393,000	60.6	125	1,160	322	1,030
392	172	306,000	67.9	121	940	272	856
331	106	242,000	76.8	118	762	228	715
278	64.7	192,000	87.6	115	622	192	596
264	56.1	181,000	91.3	114	589	184	566
235	41.3	161,000	101	113	530	168	506
211	30.4	140,000	109	112	468	151	453
183	19.6	119,000	125	111	402	134	391
167	14.0	99,300	136	111	336	113	346
149	9.60	79,600	147	110	270	92.0	299
W36x848	1,270	1,620,000	57.5	172	3,530	674	1,910
798	1,070	1,480,000	59.8	169	3,270	634	1,790
650	600	1,090,000	68.6	162	2,520	513	1,420
527	330	816,000	80.0	156	1,960	415	1,130
439	195	637,000	92.0	152	1,570	344	928
393	143	554,000	100	150	1,390	309	830
359	109	493,000	108	148	1,240	281	757
328	84.5	441,000	116	146	1,130	258	691
300	64.2	398,000	127	146	1,020	235	628
280	52.6	366,000	134	145	944	219	585
260	41.5	330,000	143	144	858	200	538
245	34.6	306,000	151	143	799	187	505
230	28.6	282,000	160	143	740	175	472

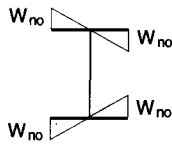

W-, M-, S-, and HP-Shapes

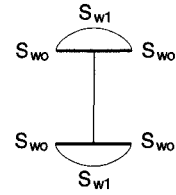

Shape	Torsional Properties					Statical Moments	
	J	C_w	a	W_{no}	S_{w1}	Q_f	Q_w
	in. ⁴	in. ⁶	in.	in. ²	in. ⁴	in. ³	in. ³
W36x256	53.3	168,000	90.3	109	576	176	520
232	39.8	148,000	98.1	108	512	159	468
210	28.0	128,000	109	108	446	138	416
194	22.2	116,000	116	107	407	128	383
182	18.4	107,000	123	106	378	120	359
170	15.1	98,500	130	105	349	111	334
160	12.4	90,200	137	105	321	103	312
150	10.1	82,200	145	105	294	95.1	291
135	6.99	68,100	159	104	245	79.9	255
W33x354	115	408,000	95.8	135	1,130	263	709
318	84.4	357,000	105	133	1,000	237	634
291	65.0	319,000	113	132	906	216	577
263	48.5	281,000	122	130	808	195	519
241	35.8	250,000	134	130	721	174	469
221	27.5	224,000	145	129	650	158	428
201	20.5	198,000	158	128	580	142	386
W33x169	17.7	82,400	110	93.7	329	109	314
152	12.4	71,700	122	93.8	286	95.1	279
141	9.70	64,400	131	93.3	258	86.5	257
130	7.37	56,600	141	92.8	228	76.9	233
118	5.30	48,300	154	92.2	196	66.6	207
W30x477	307	480,000	63.6	124	1,450	329	896
391	174	364,000	73.6	120	1,140	268	716
326	103	286,000	84.8	117	919	223	595
292	74.9	249,000	92.8	115	812	200	530
261	53.8	215,000	102	114	710	177	470
235	40.0	190,000	111	112	633	160	422
211	27.9	166,000	124	112	556	141	374
191	20.6	146,000	135	111	494	126	337
173	15.3	129,000	148	110	439	113	303
W30x148	14.6	49,400	93.6	77.3	239	86.8	250
132	9.72	42,100	106	77.3	204	74.0	219
124	7.99	38,600	112	76.9	188	68.8	204
116	6.43	34,900	119	76.5	171	62.8	189
108	4.99	30,900	127	76.1	152	56.1	173
99	3.77	26,800	136	75.7	133	49.5	156
90	2.92	24,000	146	75.0	119	45.0	142

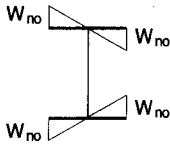

W-, M-, S-, and HP-Shapes

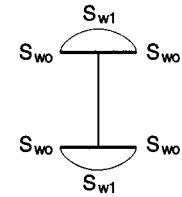

Shape	Torsional Properties					Statical Moments	
	J	C_w	a	W_{no}	S_{w1}	Q_f	Q_w
	in. ⁴	in. ⁶	in.	in. ²	in. ⁴	in. ³	in. ³
W27×539	499	440,000	47.8	111	1,490	342	940
448	297	336,000	54.1	106	1,190	283	766
368	169	254,000	62.4	102	930	231	620
307	101	199,000	71.4	99.4	750	192	511
258	61.0	159,000	82.2	98.2	613	161	424
235	46.3	140,000	88.5	96.0	548	146	384
217	37.0	128,000	94.6	95.0	503	135	354
194	26.5	111,000	104	93.9	442	120	314
178	19.5	98,300	114	93.7	393	107	284
161	14.7	87,300	124	92.9	352	96.6	256
146	10.9	77,200	135	92.2	314	87.0	231
W27×129	11.2	32,500	86.7	66.4	183	69.5	197
114	7.33	27,600	98.7	66.4	155	59.2	171
102	5.29	24,000	108	65.7	137	52.7	153
94	4.03	21,300	117	65.4	122	47.3	139
84	2.81	17,900	128	64.9	103	40.6	122
W24×492	456	283,000	40.1	92.1	1,150	281	774
408	271	214,000	45.2	88.1	909	233	626
335	154	160,000	51.9	84.6	709	189	509
279	91.7	125,000	59.4	82.0	570	157	418
250	67.3	108,000	64.5	80.6	502	141	372
229	51.8	95,800	69.2	79.6	451	128	338
207	38.6	83,900	75.0	78.5	401	116	303
192	31.0	76,200	79.8	77.7	367	107	280
176	24.1	68,400	85.7	77.0	333	97.8	255
162	18.5	62,600	93.6	77.0	304	89.4	234
146	13.4	54,600	103	76.3	268	79.5	209
131	9.50	47,100	113	75.6	233	69.7	185
117	6.72	40,800	125	74.9	204	61.5	164
104	4.72	35,200	139	74.3	178	54.1	144
W24×103	7.10	16,600	77.8	53.0	117	49.4	140
94	5.26	15,000	85.9	53.1	105	44.4	127
84	3.70	12,800	94.6	52.6	91.3	39.0	112
76	2.68	11,100	104	52.2	79.8	34.4	100
68	1.87	9,430	114	51.9	68.0	29.5	88.3
W24×62	1.71	4,620	83.6	40.7	42.3	23.2	76.6
55	1.18	3,870	92.2	40.4	35.7	19.8	67.1
W21×201	41.3	61,800	62.2	67.0	345	102	265
182	31.1	54,300	67.2	66.0	307	92.3	238
166	23.9	48,500	72.5	65.6	277	84.4	216
147	15.4	41,100	83.1	65.4	235	71.4	187
132	11.3	36,000	90.8	64.7	208	64.0	167
122	8.98	32,700	97.1	64.2	191	59.2	154
111	6.83	29,200	105	63.7	172	53.7	139
101	5.21	26,200	114	63.2	155	49.0	127

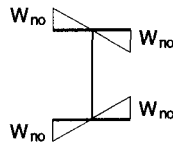

W-, M-, S-, and HP-Shapes

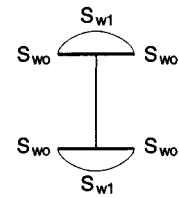

Shape	Torsional Properties					Static Moments	
	J	C_w	a	W_{no}	S_{w1}	Q_f	Q_w
	in. ⁴	in. ⁶	in.	in. ²	in. ⁴	in. ³	in. ³
W21×93	6.03	9,940	65.3	43.6	85.3	38.2	110
83	4.34	8,630	71.8	43.0	75.0	34.2	98.0
73	3.02	7,410	79.7	42.5	65.2	30.3	86.2
68	2.45	6,760	84.5	42.3	59.9	28.0	79.9
62	1.83	5,960	91.8	42.0	53.2	25.1	72.2
W21×57	1.77	3,190	68.3	33.4	35.6	20.9	64.3
50	1.14	2,570	76.4	33.1	28.9	17.2	55.0
44	0.77	2,110	84.2	32.8	24.0	14.5	47.7
W18×311	177	75,700	33.3	59.0	483	141	376
283	135	65,600	35.5	57.5	427	127	338
258	104	57,400	37.8	56.4	382	116	306
234	79.7	49,900	40.3	55.2	339	105	274
211	59.3	43,200	43.4	54.2	299	94.3	245
192	45.2	37,900	46.6	53.3	267	85.7	221
175	34.2	33,200	50.1	52.5	237	77.2	199
158	25.4	28,900	54.3	51.6	210	69.4	178
143	19.4	25,700	58.6	51.0	189	63.2	161
130	14.7	22,700	63.2	50.4	169	57.1	145
W18×119	10.6	20,300	70.4	50.4	151	50.6	131
106	7.48	17,400	77.6	49.8	131	44.6	115
97	5.86	15,800	83.6	49.4	120	41.2	105
86	4.10	13,600	92.7	48.9	104	36.3	92.8
76	2.83	11,700	103	48.4	90.7	31.9	81.4
W18×71	3.48	4,700	59.1	33.7	52.1	25.8	72.7
65	2.73	4,240	63.4	33.4	47.5	23.8	66.6
60	2.17	3,850	67.8	33.1	43.5	22.1	61.4
55	1.66	3,430	73.1	32.9	39.0	19.9	55.9
50	1.24	3,040	79.7	32.6	34.9	18.0	50.4
W18×46	1.22	1,710	60.2	26.4	24.2	15.3	45.3
40	0.81	1,440	67.8	26.1	20.6	13.3	39.2
35	0.51	1,140	76.1	25.9	16.5	10.7	33.2
W16×100	7.73	11,900	63.1	41.7	107	39.0	99.0
89	5.45	10,200	69.6	41.1	93.3	34.4	87.3
77	3.57	8,590	78.9	40.6	79.3	29.7	75.0
67	2.39	7,300	88.9	40.1	68.2	25.9	64.9
W16×57	2.22	2,660	55.7	28.0	35.6	19.0	52.6
50	1.52	2,270	62.2	27.6	30.8	16.7	46.0
45	1.11	1,990	68.1	27.4	27.2	15.0	41.1
40	0.79	1,730	75.3	27.1	23.9	13.4	36.5
36	0.54	1,460	83.7	26.9	20.2	11.4	32.0
W16×31	0.46	739	64.5	21.3	13.0	9.17	27.0
26	0.26	565	75.0	21.1	10.0	7.20	22.1

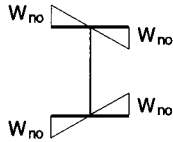

W-, M-, S-, and HP-Shapes

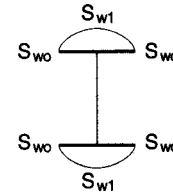

Shape	Torsional Properties					Statical Moments	
	J	C_w	a	W_{no}	S_{w1}	Q_f	Q_w
	in. ⁴	in. ⁶	in.	in. ²	in. ⁴	in. ³	in. ³
W14×808	1,860	433,000	24.6	82.2	1,950	337	916
730	1,450	362,000	25.4	78.3	1,720	319	831
665	1,120	305,000	26.6	75.5	1,510	287	740
605	870	258,000	27.7	73.0	1,320	259	660
550	670	219,000	29.1	70.6	1,160	233	588
500	514	187,000	30.7	68.5	1,020	209	524
455	395	160,000	32.4	66.5	899	189	468
W14×426	331	144,000	33.6	65.3	827	176	434
398	273	129,000	35.0	64.1	756	163	401
370	222	116,000	36.8	62.9	689	151	368
342	178	103,000	38.7	61.6	623	138	336
311	136	89,100	41.2	60.3	553	125	301
283	104	77,700	44.0	59.1	493	113	271
257	79.1	67,800	47.1	57.9	438	102	243
233	59.5	59,000	50.7	56.9	389	91.7	218
211	44.6	51,500	54.7	55.9	345	82.3	195
193	34.8	45,900	58.4	55.1	312	75.4	177
176	26.5	40,500	62.9	54.4	279	68.0	160
159	19.8	35,600	68.2	53.7	248	61.3	143
145	15.2	31,700	73.5	53.0	224	55.8	130
W14×132	12.3	25,500	73.3	50.2	190	49.9	117
120	9.37	22,700	79.2	49.7	171	45.3	106
109	7.12	20,200	85.7	49.1	154	41.2	95.9
99	5.37	18,000	93.2	48.7	138	37.2	86.6
90	4.06	16,000	101	48.3	125	33.7	78.3
W14×82	5.08	6,710	58.5	34.1	73.8	28.1	69.3
74	3.88	5,990	63.2	33.7	66.6	25.7	62.8
68	3.02	5,380	67.9	33.4	60.4	23.5	57.3
61	2.20	4,710	74.5	33.1	53.3	21.0	51.1
W14×53	1.94	2,540	58.2	26.7	35.5	17.3	43.6
48	1.46	2,240	63.0	26.5	31.6	15.6	39.2
43	1.05	1,950	69.3	26.2	27.8	13.9	34.8
W14×38	0.80	1,230	63.1	23.0	20.0	11.5	30.7
34	0.57	1,070	69.7	22.8	17.5	10.2	27.3
30	0.38	887	77.7	22.6	14.7	8.59	23.6
W14×26	0.36	405	54.0	16.9	8.94	6.98	20.1
22	0.21	314	62.2	16.8	7.02	5.58	16.6

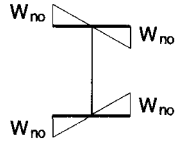

W-, M-, S-, and HP-Shapes

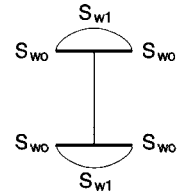

Shape	Torsional Properties					Static Moments	
	J	C_w	a	W_{no}	S_{w1}	Q_f	Q_w
	in. ⁴	in. ⁶	in.	in. ²	in. ⁴	in. ³	in. ³
W12x336	243	57,000	24.6	46.4	459	119	301
305	185	48,600	26.1	45.0	403	107	269
279	143	42,000	27.6	44.0	357	96.3	241
252	108	35,800	29.3	42.8	313	86.4	214
230	83.8	31,200	31.0	41.8	279	78.4	193
210	64.7	27,200	33.0	41.0	249	71.1	174
190	48.8	23,600	35.4	40.1	220	64.1	156
170	35.6	20,100	38.2	39.2	192	56.9	137
152	25.8	17,200	41.5	38.4	168	50.4	121
136	18.5	14,700	45.4	37.7	146	44.5	107
120	12.9	12,400	49.9	37.0	126	38.9	93.2
106	9.13	10,700	55.1	36.4	110	34.6	81.9
96	6.86	9,410	59.6	35.9	98.2	31.3	73.6
87	5.10	8,270	64.8	35.5	87.2	28.0	66.0
79	3.84	7,330	70.3	35.2	78.1	25.3	59.5
72	2.93	6,540	76.0	34.9	70.3	22.9	53.9
65	2.18	5,780	82.9	34.5	62.7	20.6	48.4
W12x58	2.10	3,570	66.3	28.9	46.3	18.2	43.2
53	1.58	3,160	72.0	28.7	41.2	16.3	39.0
W12x50	1.78	1,880	52.3	23.3	30.2	14.7	36.2
45	1.31	1,650	57.1	23.1	26.7	13.1	32.4
40	0.95	1,440	62.6	22.9	23.6	11.8	28.8
W12x35	0.74	879	55.5	19.6	16.8	9.86	25.6
30	0.46	720	63.7	19.4	13.9	8.30	21.6
26	0.30	607	72.4	19.2	11.8	7.15	18.6
W12x22	0.29	164	38.3	12.0	5.13	4.87	14.7
19	0.18	131	43.4	11.8	4.14	4.01	12.4
16	0.10	96.9	50.1	11.7	3.09	3.04	10.0
14	0.07	80.4	54.5	11.6	2.59	2.59	8.72
W10x112	15.1	6,020	32.1	26.3	85.7	30.8	73.7
100	10.9	5,150	35.0	25.8	74.7	27.2	64.9
88	7.53	4,330	38.6	25.3	64.2	23.8	56.4
77	5.11	3,630	42.9	24.8	54.9	20.7	48.8
68	3.56	3,100	47.5	24.4	47.6	18.1	42.6
60	2.48	2,640	52.5	24.0	41.2	15.9	37.3
54	1.82	2,320	57.5	23.8	36.6	14.3	33.3
49	1.39	2,070	62.1	23.6	33.0	13.0	30.2
W10x45	1.51	1,200	45.4	19.0	23.6	11.5	27.5
39	0.98	992	51.2	18.7	19.8	9.77	23.4
33	0.58	790	59.4	18.5	16.0	7.98	19.4
W10x30	0.62	414	41.6	14.5	10.7	7.09	18.3
26	0.40	345	47.3	14.3	9.05	6.08	15.6
22	0.24	275	54.5	14.1	7.30	4.95	13.0

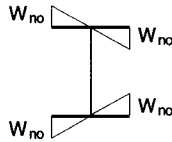

W-, M-, S-, and HP-Shapes

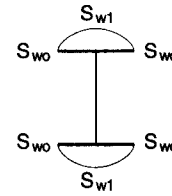

Shape	Torsional Properties					Static Moments	
	J	C_w	a	W_{no}	S_{w1}	Q_f	Q_w
	in. ⁴	in. ⁶	in.	in. ²	in. ⁴	in. ³	in. ³
W10×19	0.23	104	34.2	9.89	3.93	3.76	10.8
17	0.16	85.1	37.1	9.80	3.24	3.13	9.33
15	0.10	68.3	42.1	9.72	2.62	2.56	8.00
12	0.05	50.9	51.3	9.56	1.99	2.00	6.32
W8×67	5.06	1,440	27.1	16.7	32.3	14.7	35.1
58	3.34	1,180	30.2	16.3	27.2	12.5	29.9
48	1.96	931	35.1	15.8	22.0	10.4	24.5
40	1.12	726	41.0	15.5	17.5	8.42	19.9
35	0.77	619	45.6	15.3	15.2	7.39	17.3
31	0.54	530	50.4	15.1	13.1	6.46	15.2
W8×28	0.54	312	38.7	12.4	9.43	5.64	13.6
24	0.35	259	43.8	12.2	7.94	4.83	11.6
W8×21	0.28	152	37.5	10.4	5.47	4.03	10.2
18	0.17	122	43.1	10.3	4.44	3.31	8.52
W8×15	0.14	51.8	31.0	7.82	2.47	2.39	6.78
13	0.09	40.8	34.3	7.74	1.97	1.93	5.70
10	0.04	30.9	44.7	7.57	1.53	1.56	4.43
W6×25	0.46	150	29.1	9.01	6.23	3.92	9.46
20	0.24	113	34.9	8.78	4.82	3.10	7.45
15	0.10	76.5	44.5	8.58	3.34	2.18	5.39
W6×16	0.22	38.2	21.2	5.92	2.42	2.28	5.84
12	0.09	24.7	26.7	5.75	1.61	1.55	4.15
9	0.04	17.7	33.8	5.60	1.19	1.19	3.12
W5×19	0.31	50.8	20.6	5.94	3.21	2.44	5.81
16	0.19	40.6	23.5	5.81	2.62	2.02	4.82
W4×13	0.15	14.0	15.5	3.87	1.36	1.27	3.14
M12×11.8	0.05	37.2	43.9	9.02	1.56	1.98	7.14
10.8	0.04	33.8	46.8	9.01	1.45	1.86	6.58
M10×9	0.03	15.7	36.8	6.59	0.91	1.32	4.60
8	0.02	13.8	42.3	6.57	0.80	1.18	4.06
M8×6.5	0.02	5.45	26.6	4.45	0.48	0.82	2.72
M5×18.9	0.34	41.3	17.7	5.73	2.98	2.28	5.53

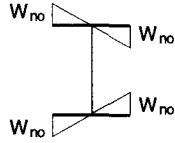

W-, M-, S-, and HP-Shapes

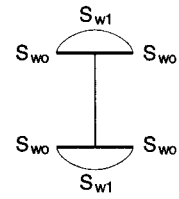

Shape	Torsional Properties					Statical Moments	
	J	C_w	a	W_{no}	S_{w1}	Q_f	Q_w
	in. ⁴	in. ⁶	in.	in. ²	in. ⁴	in. ³	in. ³
S24×121	12.8	11,400	48.0	47.1	103	47.1	154
106	10.1	10,600	52.1	46.1	98.8	47.1	141
S24×100	7.58	6,380	46.7	41.9	66.0	33.5	121
90	6.04	6,000	50.7	41.2	63.8	33.5	112
80	4.88	5,640	54.7	40.5	61.6	33.5	103
S20×96	8.39	4,710	38.1	34.9	57.8	29.2	99.7
86	6.64	4,390	41.4	34.2	55.5	29.2	92.5
S20×75	4.59	2,750	39.4	30.7	38.9	22.6	77.0
66	3.58	2,550	42.9	30.0	37.3	22.6	70.5
S18×70	4.15	1,800	33.5	27.0	29.2	17.1	63.0
54.7	2.37	1,560	41.3	26.0	26.9	17.1	52.9
S15×50	2.12	811	31.5	20.3	17.8	11.8	39.0
42.9	1.54	744	35.4	19.8	16.9	11.8	35.1
S12×50	2.82	505	21.5	15.5	14.0	9.30	31.0
40.8	1.75	437	25.4	14.9	12.9	9.30	26.9
S12×35	1.08	324	27.9	14.5	10.0	7.48	22.7
31.8	0.90	307	29.7	14.3	9.74	7.48	21.3
S10×35	1.29	189	19.5	11.8	7.13	5.24	17.9
25.4	0.60	153	25.7	11.1	6.34	5.24	14.4
S8×23	0.55	61.8	17.1	7.90	3.50	3.10	9.74
18.4	0.34	53.5	20.2	7.58	3.22	3.10	8.38
S6×17.25	0.37	18.4	11.3	5.03	1.61	1.63	5.35
12.5	0.17	14.5	14.9	4.70	1.41	1.63	4.30
S5×10	0.11	6.66	12.3	3.51	0.86	1.11	2.88
S4×9.5	0.12	3.10	8.18	2.59	0.53	0.70	2.05
7.7	0.07	2.62	9.84	2.47	0.48	0.70	1.79
S3×7.5	0.09	1.10	5.63	1.72	0.28	0.40	1.20
5.7	0.04	0.85	7.42	1.60	0.24	0.40	1.00

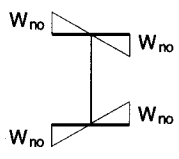

W-, M-, S-, and HP-Shapes

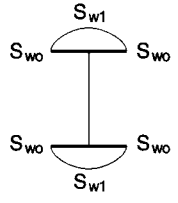

Shape	Torsional Properties					Statical Moments	
	J	C_w	a	W_{no}	S_{w1}	Q_f	Q_w
	in. ⁴	in. ⁶	in.	in. ²	in. ⁴	in. ³	in. ³
HP14×117	8.02	19,900	80.2	49.9	149	38.5	97.2
102	5.40	16,800	89.8	49.2	128	33.5	84.3
89	3.60	14,200	101	48.5	110	29.1	72.9
73	2.01	11,200	120	47.8	88.0	23.8	59.2
HP12×84	4.24	7,160	66.1	35.6	75.0	23.5	59.8
74	2.98	6,170	73.2	35.2	65.5	20.8	52.7
63	1.83	4,990	84.0	34.6	54.1	17.5	44.2
53	1.12	4,090	97.2	34.2	44.7	14.7	37.0
HP10×57	1.97	2,240	54.3	24.1	34.8	13.1	33.2
42	0.81	1,540	70.2	23.4	24.7	9.64	24.2
HP8×36	0.77	578	44.1	15.4	14.0	6.62	16.8

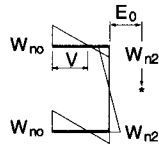

C- and MC-Shapes

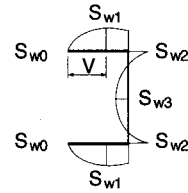

Shape	Torsional Properties									Statical Moments	
	J	C_w	a	W_{no}	W_{n2}	S_{w1}	S_{w2}	S_{w3}	E_o	Q_f	Q_w
	in. ⁴	in. ⁶	in.	in. ²	in. ²	in. ⁴	in. ⁴	in. ⁴	in.	in. ³	in. ³
C15x50	2.67	492	21.8	17.3	6.75	13.6	11.6	5.78	0.941	14.4	34.5
40	1.46	411	27.0	16.0	7.37	11.6	9.17	4.58	1.03	14.4	29.0
33.9	1.02	358	30.1	15.1	7.86	10.3	7.52	3.76	1.10	14.4	25.6
C12x30	0.87	151	21.2	11.7	5.02	6.01	4.91	2.45	0.873	7.83	17.0
25	0.54	130	25.0	11.0	5.40	5.28	4.00	2.00	0.940	7.83	14.8
20.7	0.37	112	28.0	10.3	5.81	4.61	3.14	1.57	1.01	7.83	12.9
C10x30	1.23	79.3	12.9	9.52	3.37	4.13	3.61	1.82	0.706	5.03	13.4
25	0.69	68.4	16.0	8.92	3.62	3.63	3.03	1.52	0.757	5.03	11.6
20	0.37	56.9	20.0	8.24	3.95	3.09	2.38	1.20	0.827	5.03	9.77
15.3	0.21	45.6	23.7	7.48	4.38	2.55	1.68	0.84	0.916	5.03	8.03
C9x20	0.43	39.4	15.4	7.23	3.17	2.52	2.03	1.02	0.739	3.99	8.55
15	0.21	31.0	19.6	6.52	3.54	2.04	1.44	0.73	0.825	3.99	6.88
13.4	0.17	28.2	20.7	6.26	3.69	1.88	1.23	0.62	0.860	3.99	6.35
C8x18.75	0.44	25.1	12.2	6.12	2.57	1.92	1.58	0.79	0.675	3.11	7.00
13.75	0.19	19.2	16.2	5.46	2.87	1.53	1.11	0.55	0.756	3.11	5.53
11.5	0.13	16.5	18.1	5.11	3.07	1.34	0.86	0.43	0.807	3.11	4.87
C7x12.25	0.16	11.2	13.5	4.45	2.31	1.09	0.80	0.40	0.695	2.35	4.27
9.8	0.10	9.18	15.4	4.09	2.49	0.92	0.58	0.29	0.752	2.35	3.63
C6x13	0.24	7.22	8.83	3.79	1.69	0.87	0.70	0.35	0.599	1.72	3.69
10.5	0.13	5.95	10.9	3.49	1.82	0.74	0.54	0.27	0.643	1.72	3.13
8.2	0.08	4.72	12.4	3.17	1.98	0.61	0.37	0.19	0.699	1.72	2.62
C5x9	0.11	2.93	8.30	2.65	1.38	0.48	0.35	0.17	0.590	1.21	2.22
6.7	0.06	2.22	9.79	2.36	1.51	0.38	0.22	0.11	0.647	1.21	1.80
C4x7.25	0.08	1.24	6.34	1.88	1.01	0.28	0.20	0.10	0.547	0.80	1.44
5.4	0.04	0.92	7.72	1.66	1.10	0.22	0.12	0.06	0.594	0.80	1.16
C3x6	0.07	0.46	4.12	1.25	0.68	0.16	0.11	0.06	0.500	0.48	0.77
5	0.04	0.38	4.96	1.16	0.71	0.13	0.08	0.04	0.521	0.48	0.77
4.1	0.03	0.31	5.17	1.06	0.74	0.11	0.06	0.03	0.546	0.48	0.67

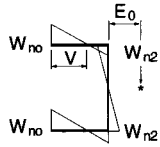

C- and MC-Shapes

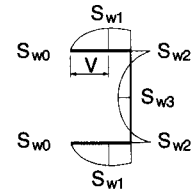

Shape	Torsional Properties									Statcal Moments	
	J	C_w	a	W_{no}	W_{n2}	S_{w1}	S_{w2}	S_{w3}	E_o	Q_f	Q_w
	in. ⁴	in. ⁶	in.	in. ²	in. ²	in. ⁴	in. ⁴	in. ⁴	in.	in. ³	in. ³
MC18×58	2.81	1,070	31.4	24.4	9.08	21.4	18.4	9.21	1.05	19.7	48.0
51.9	2.03	986	35.5	23.5	9.53	19.8	16.6	8.27	1.10	19.7	44.0
45.8	1.45	897	40.0	22.5	10.1	18.2	14.6	7.29	1.16	19.7	39.9
42.7	1.23	852	42.4	22.0	10.4	17.4	13.5	6.75	1.19	19.7	37.9
MC13×50	2.98	558	22.0	17.4	7.49	14.9	12.2	6.09	1.21	14.0	30.6
40	1.57	463	27.6	16.1	8.12	12.7	9.48	4.60	1.31	14.0	25.8
35	1.14	413	30.6	15.3	8.57	11.5	7.86	4.00	1.38	14.0	23.4
31.8	0.94	380	32.4	14.8	8.84	10.7	6.90	3.37	1.43	14.0	21.9
MC12×50	3.24	411	18.1	14.5	6.55	12.9	10.3	5.14	1.16	13.3	28.4
45	2.35	374	20.3	13.9	6.78	11.9	9.08	4.56	1.20	13.3	26.1
40	1.70	336	22.6	13.3	7.05	10.9	7.83	3.92	1.25	13.3	23.9
35	1.25	297	24.8	12.6	7.36	9.83	6.47	3.24	1.30	13.3	21.7
31	1.01	268	26.2	12.0	7.71	8.89	5.20	2.86	1.37	13.3	21.6
MC12×10.6	0.06	11.7	22.5	6.00	2.22	0.95	0.82	0.41	0.379	2.61	6.36
MC10×41.1	2.27	270	17.5	12.5	5.95	9.59	7.44	3.72	1.26	9.86	19.8
33.6	1.21	224	21.9	11.6	6.35	8.23	5.77	2.83	1.35	9.86	17.0
28.5	0.79	194	25.2	10.9	6.70	7.26	4.52	2.19	1.42	9.86	15.2
MC10×25	0.64	125	22.5	9.40	5.75	5.39	3.38	1.77	1.22	7.66	13.0
22	0.51	111	23.7	8.93	6.01	4.87	2.66	1.44	1.28	7.66	11.7
MC10×8.4	0.04	7.01	21.3	4.85	2.03	0.68	0.56	0.28	0.417	1.99	4.32
MC9×25.4	0.69	104	19.8	8.72	5.12	4.95	3.25	1.62	1.21	7.34	11.9
23.9	0.60	98.2	20.6	8.49	5.24	4.69	2.91	1.52	1.24	7.34	11.4
MC8×22.8	0.57	75.3	18.5	7.61	4.68	4.06	2.52	1.22	1.25	6.23	9.65
21.4	0.50	70.9	19.2	7.42	4.77	3.87	2.26	1.08	1.28	6.23	9.23
20	0.44	47.9	16.8	6.68	3.91	2.98	1.96	0.98	1.04	5.10	8.30
18.7	0.38	45.1	17.5	6.51	4.00	2.83	1.76	0.88	1.07	5.10	7.93
MC7×22.7	0.63	58.5	15.5	6.79	4.10	3.55	2.26	1.10	1.26	5.19	8.27
19.1	0.41	49.4	17.7	6.34	4.31	3.09	1.66	0.80	1.33	5.19	7.35
MC6×18	0.38	34.6	15.4	5.40	3.76	2.51	1.29	0.67	1.36	4.22	5.92
MC6×16.3	0.34	22.1	13.0	4.68	3.09	1.88	1.07	0.53	1.12	3.56	5.25
15.1	0.29	20.6	13.6	4.54	3.15	1.77	0.92	0.46	1.14	3.56	4.98
MC6×12	0.15	11.2	13.9	4.11	2.48	1.13	0.72	0.36	0.880	2.38	3.78

WT-, MT-, and ST-Shapes			
Shape	Torsional Properties		
	<i>J</i>	<i>C_w</i>	<i>a</i>
	in. ⁴	in. ⁶	in.
WT22x167.5	37.2	434	5.50
145	25.7	279	5.30
131	18.9	204	5.29
115	12.4	139	5.39
WT20x296.5	223	2,340	5.21
251.5	140	1,420	5.12
215.5	88.5	881	5.08
186	58.2	559	4.99
160.5	37.7	350	4.90
148.5	30.6	279	4.86
138.5	25.8	218	4.68
124.5	19.1	158	4.63
107.5	12.4	101	4.59
99.5	9.14	83.5	4.86
87	5.60	65.3	5.49
WT20x233	139	1,360	5.03
196	86.1	802	4.91
165.5	53.0	485	4.87
139	32.4	278	4.71
132	28.0	233	4.64
117.5	20.6	156	4.43
105.5	15.2	113	4.39
91.5	10.0	72.1	4.32
83.5	7.01	62.9	4.82
74.5	4.68	51.9	5.36
WT18x424	622	6,880	5.35
399	527	5,700	5.29
325	295	3,010	5.14
263.5	163	1,570	4.99
219.5	96.7	894	4.89
196.5	70.7	637	4.83
179.5	54.3	480	4.78
164	42.1	363	4.73
150	32.0	278	4.74
140	26.2	226	4.73
130	20.7	181	4.76
122.5	17.3	151	4.75
115	14.3	125	4.76
WT18x128	26.6	205	4.47
116	19.8	151	4.44
105	13.9	119	4.71
97	11.1	92.7	4.65
91	9.19	77.6	4.68
85	7.51	63.2	4.67
80	6.17	53.6	4.74
75	5.04	46.0	4.86
67.5	3.48	37.3	5.27

WT-, MT-, and ST-Shapes			
Shape	Torsional Properties		
	<i>J</i>	<i>C_w</i>	<i>a</i>
	in. ⁴	in. ⁶	in.
WT16.5x177	57.2	468	4.60
159	42.1	335	4.54
145.5	32.4	256	4.52
131.5	24.2	188	4.48
120.5	17.9	146	4.60
110.5	13.7	113	4.62
100.5	10.2	84.9	4.64
WT16.5x84.5	8.83	55.4	4.03
76	6.16	43.0	4.25
70.5	4.84	35.4	4.35
65	3.67	29.3	4.55
59	2.64	23.4	4.79
WT15x238.5	151	1,170	4.48
195.5	85.9	636	4.38
163	50.8	361	4.29
146	37.2	257	4.23
130.5	26.7	184	4.22
117.5	19.9	132	4.14
105.5	13.9	96.4	4.24
95.5	10.3	71.2	4.23
86.5	7.61	53.0	4.25
WT15x74	7.27	37.6	3.66
66	4.85	28.5	3.90
62	3.98	23.9	3.94
58	3.21	20.5	4.07
54	2.49	17.3	4.24
49.5	1.88	14.3	4.44
45	1.42	10.5	4.38
WT13.5x269.5	245	1,740	4.29
224	146	977	4.16
184	83.6	532	4.06
153.5	49.8	304	3.98
129	30.2	178	3.91
117.5	23.0	135	3.90
108.5	18.5	105	3.83
97	13.2	74.3	3.82
89	9.74	57.7	3.92
80.5	7.31	42.7	3.89
73	5.44	31.7	3.88
WT13.5x64.5	5.60	24.0	3.33
57	3.65	17.5	3.52
51	2.64	12.6	3.52
47	2.01	10.2	3.62
42	1.40	7.79	3.80

WT-, MT-, and ST-Shapes			
Shape	Torsional Properties		
	<i>J</i>	<i>C_w</i>	<i>a</i>
	in. ⁴	in. ⁶	in.
WT12x246	223	1,340	3.94
204	133	748	3.82
167.5	76.0	405	3.71
139.5	45.3	230	3.63
125	33.3	165	3.58
114.5	25.7	125	3.55
103.5	19.1	91.3	3.52
96	15.4	72.5	3.49
88	12.0	55.8	3.47
81	9.22	43.8	3.51
73	6.70	31.9	3.51
65.5	4.74	23.1	3.55
58.5	3.35	16.4	3.56
52	2.35	11.6	3.58
WT12x51.5	3.54	12.3	3.00
47	2.62	9.57	3.08
42	1.84	6.90	3.12
38	1.34	5.30	3.20
34	0.932	4.08	3.37
WT12x31	0.850	3.92	3.46
27.5	0.588	2.93	3.59
WT10.5x100.5	20.6	85.4	3.28
91	15.4	63.0	3.25
83	11.9	47.3	3.21
73.5	7.69	32.5	3.31
66	5.62	23.4	3.28
61	4.47	18.4	3.26
55.5	3.40	13.8	3.24
50.5	2.60	10.4	3.22
WT10.5x46.5	3.01	9.33	2.83
41.5	2.16	6.50	2.79
36.5	1.51	4.42	2.75
34	1.22	3.62	2.77
31	0.513	2.78	3.75
WT10.5x28.5	0.884	2.50	2.71
25	0.570	1.89	2.93
22	0.383	1.40	3.08
WT9x155.5	87.2	339	3.17
141.5	66.5	251	3.13
129	51.5	189	3.08
117	39.4	140	3.03
105.5	29.4	102	3.00
96	22.4	75.7	2.96
87.5	17.0	56.5	2.93
79	12.6	41.2	2.91
71.5	9.70	30.7	2.86
65	7.30	22.8	2.84

WT-, MT-, and ST-Shapes			
Shape	Torsional Properties		
	<i>J</i>	<i>C_w</i>	<i>a</i>
	in. ⁴	in. ⁶	in.
WT9x59.5	5.30	17.4	2.92
53	3.73	12.1	2.90
48.5	2.92	9.29	2.87
43	2.04	6.42	2.85
38	1.41	4.37	2.83
WT9x35.5	1.74	3.96	2.43
32.5	1.36	3.01	2.39
30	1.08	2.35	2.37
27.5	0.829	1.84	2.40
25	0.613	1.36	2.40
WT9x23	0.609	1.20	2.26
20	0.403	0.79	2.25
17.5	0.252	0.60	2.48
WT8x50	3.85	10.4	2.64
44.5	2.72	7.19	2.62
38.5	1.78	4.61	2.59
33.5	1.19	3.01	2.56
WT8x28.5	1.10	1.99	2.16
25	0.760	1.34	2.14
22.5	0.655	0.97	1.96
20	0.396	0.67	2.09
18	0.271	0.52	2.23
WT8x15.5	0.229	0.37	2.05
13	0.130	0.24	2.19
WT7x404	918	6,970	4.43
365	714	5,250	4.36
332.5	555	3,920	4.28
302.5	430	2,930	4.20
275	331	2,180	4.13
250	255	1,620	4.06
227.5	196	1,210	4.00
WT7x213	164	991	3.96
199	135	801	3.92
185	110	640	3.88
171	88.3	502	3.84
155.5	67.5	375	3.79
141.5	51.8	281	3.75
128.5	39.3	209	3.71
116.5	29.6	154	3.67
105.5	22.2	113	3.63
96.5	17.3	87.2	3.61
88	13.2	65.2	3.58
79.5	9.84	47.9	3.55
72.5	7.56	36.3	3.53

WT-, MT-, and ST-Shapes			
Shape	Torsional Properties		
	<i>J</i>	<i>C_w</i>	<i>a</i>
	in. ⁴	in. ⁶	in.
WT7×66	6.13	26.6	3.35
60	4.67	20.0	3.33
54.5	3.55	15.0	3.31
49.5	2.68	11.1	3.27
45	2.03	8.31	3.26
WT7×41	2.53	5.63	2.40
37	1.94	4.19	2.36
34	1.51	3.21	2.35
30.5	1.10	2.29	2.32
WT7×26.5	0.970	1.46	1.97
24	0.726	1.07	1.95
21.5	0.524	0.75	1.93
WT7×19	0.398	0.55	1.89
17	0.284	0.40	1.91
15	0.190	0.29	1.99
WT7×13	0.179	0.21	1.74
11	0.104	0.13	1.80
WT6×168	120	481	3.22
152.5	92.0	356	3.17
139.5	70.9	267	3.12
126	53.5	195	3.07
115	41.6	148	3.04
105	32.2	112	3.00
95	24.4	82.1	2.95
85	17.7	58.3	2.92
76	12.8	41.3	2.89
68	9.22	28.9	2.85
60	6.43	19.7	2.82
53	4.55	13.6	2.78
48	3.42	10.1	2.77
43.5	2.54	7.34	2.74
39.5	1.92	5.43	2.71
36	1.46	4.07	2.69
32.5	1.09	2.97	2.66
WT6×29	1.05	2.08	2.26
26.5	0.788	1.53	2.24
WT6×25	0.889	1.23	1.89
22.5	0.656	0.89	1.87
20	0.476	0.62	1.84
WT6×17.5	0.369	0.44	1.76
15	0.228	0.27	1.75
13	0.150	0.17	1.71
WT6×11	0.146	0.14	1.58
9.5	0.090	0.09	1.61
8	0.051	0.07	1.89
7	0.035	0.05	1.92

WT-, MT-, and ST-Shapes			
Shape	Torsional Properties		
	<i>J</i>	<i>C_w</i>	<i>a</i>
	in. ⁴	in. ⁶	in.
WT5×56	7.50	16.9	2.42
50	5.41	11.9	2.39
44	3.75	8.02	2.35
38.5	2.55	5.31	2.32
34	1.78	3.62	2.29
30	1.23	2.46	2.28
27	0.909	1.78	2.25
24.5	0.693	1.33	2.23
WT5×22.5	0.753	0.98	1.84
19.5	0.487	0.62	1.82
16.5	0.291	0.36	1.79
WT5×15	0.310	0.27	1.50
13	0.201	0.17	1.48
11	0.119	0.11	1.55
WT5×9.5	0.116	0.08	1.34
8.5	0.078	0.06	1.41
7.5	0.052	0.05	1.58
6	0.027	0.03	1.70
WT4×33.5	2.52	3.56	1.91
29	1.66	2.28	1.89
24	0.979	1.30	1.85
20	0.559	0.72	1.83
17.5	0.385	0.48	1.80
15.5	0.268	0.33	1.79
WT4×14	0.268	0.23	1.49
12	0.173	0.14	1.45
WT4×10.5	0.141	0.09	1.29
9	0.086	0.06	1.34
WT4×7.5	0.068	0.04	1.23
6.5	0.043	0.03	1.34
5	0.021	0.01	1.11
WT3×12.5	0.229	0.17	1.39
10	0.120	0.09	1.39
7.5	0.050	0.03	1.25
WT3×8	0.111	0.04	0.966
6	0.045	0.02	1.07
4.5	0.020	0.01	1.14
WT2.5×9.5	0.154	0.08	1.16
8	0.093	0.05	1.18
WT2×6.5	0.075	0.02	0.831

WT-, MT-, and ST-Shapes

Shape	Torsional Properties		
	<i>J</i>	<i>C_w</i>	<i>a</i>
	in. ⁴	in. ⁶	in.
MT6×5.9	0.031	0.03	1.58
5.4	0.020	0.03	1.97
MT5×4.5	0.021	0.01	1.11
4	0.012	0.01	1.47
MT4×3.25	0.015	—	—
MT2.5×9.45	0.165	0.07	1.05
ST12×60.5	6.38	27.5	3.34
53	5.04	15.0	2.78
ST12×50	3.76	19.5	3.66
45	3.01	12.1	3.23
40	2.43	6.94	2.72
ST10×48	4.15	15.0	3.06
43	3.30	9.17	2.68
ST10×37.5	2.28	7.21	2.86
33	1.78	4.02	2.42
ST9×35	2.05	7.03	2.98
27.35	1.18	2.26	2.23
ST7.5×25	1.05	2.02	2.23
21.45	0.767	1.00	1.84
ST6×25	1.39	1.97	1.92
20.4	0.872	0.79	1.53
ST6×17.5	0.538	0.56	1.64
15.9	0.449	0.36	1.44
ST5×17.5	0.633	0.73	1.73
12.7	0.300	0.17	1.21
ST4×11.5	0.271	0.17	1.27
9.2	0.167	0.06	0.965
ST3×8.63	0.182	0.08	1.07
6.25	0.084	0.02	0.785
ST2.5×5	0.057	0.01	0.674
ST2×4.75	0.059	0.01	0.662
3.85	0.036	—	—
ST1.5×3.75	0.044	—	—
2.85	0.022	—	—

Single Angles			
Shape	Torsional Properties		
	<i>J</i>	<i>C_w</i>	<i>a</i>
	in. ⁴	in. ⁶	in.
L8×8×1 ¹ / ₈	7.13	32.5	3.44
1	5.08	23.4	3.45
7/8	3.46	16.1	3.47
3/4	2.21	10.4	3.49
5/8	1.30	6.16	3.50
9/16	0.960	4.55	3.50
1/2	0.682	3.23	3.50
L8×6×1	4.35	16.3	3.11
7/8	2.96	11.3	3.14
3/4	1.90	7.28	3.15
5/8	1.12	4.33	3.16
9/16	0.822	3.20	3.17
1/2	0.584	2.28	3.18
7/16	0.396	1.55	3.18
L8×4×1	3.68	12.9	3.01
7/8	2.48	8.89	3.05
3/4	1.61	5.75	3.04
5/8	0.933	3.42	3.08
9/16	0.704	2.53	3.05
1/2	0.501	1.80	3.05
7/16	0.328	1.22	3.10
L7×4×3/4	1.47	3.97	2.64
5/8	0.873	2.37	2.65
1/2	0.459	1.25	2.66
7/16	0.300	0.85	2.71
3/8	0.200	0.54	2.64
L6×6×1	3.68	9.24	2.55
7/8	2.51	6.41	2.57
3/4	1.61	4.17	2.59
5/8	0.954	2.50	2.60
9/16	0.704	1.85	2.61
1/2	0.501	1.32	2.61
7/16	0.340	0.90	2.62
3/8	0.218	0.58	2.62
5/16	0.129	0.34	2.61
L6×4×7/8	2.07	4.04	2.25
3/4	1.33	2.64	2.27
5/8	0.792	1.59	2.28
9/16	0.585	1.18	2.29
1/2	0.417	0.84	2.28
7/16	0.284	0.58	2.30
3/8	0.183	0.37	2.29
5/16	0.108	0.22	2.30
L6×3 ¹ / ₂ ×1/2	0.396	0.78	2.26
3/8	0.174	0.34	2.25
5/16	0.103	0.20	2.24

Single Angles			
Shape	Torsional Properties		
	<i>J</i>	<i>C_w</i>	<i>a</i>
	in. ⁴	in. ⁶	in.
L5×5×7/8	2.07	3.53	2.10
3/4	1.33	2.32	2.13
5/8	0.792	1.40	2.14
1/2	0.417	0.74	2.14
7/16	0.284	0.51	2.16
3/8	0.183	0.33	2.16
5/16	0.108	0.19	2.13
L5×3 ¹ / ₂ ×3/4	1.11	1.52	1.88
5/8	0.660	0.92	1.90
1/2	0.348	0.49	1.91
3/8	0.153	0.22	1.93
5/16	0.091	0.13	1.92
1/4	0.048	0.07	1.94
L5×3×1/2	0.322	0.44	1.88
7/16	0.219	0.30	1.88
3/8	0.141	0.20	1.92
5/16	0.083	0.12	1.93
1/4	0.044	0.06	1.88
L4×4×3/4	1.02	1.12	1.69
5/8	0.610	0.68	1.70
1/2	0.322	0.37	1.72
7/16	0.219	0.25	1.72
3/8	0.141	0.16	1.71
5/16	0.083	0.10	1.77
1/4	0.044	0.05	1.72
L4×3 ¹ / ₂ ×1/2	0.301	0.30	1.61
3/8	0.132	0.13	1.60
5/16	0.078	0.08	1.63
1/4	0.041	0.04	1.59
L4×3×5/8	0.529	0.47	1.52
1/2	0.281	0.26	1.55
7/16	0.192	0.18	1.56
3/8	0.123	0.11	1.52
5/16	0.073	0.07	1.58
1/4	0.039	0.04	1.63
L3 ¹ / ₂ ×3 ¹ / ₂ ×1/2	0.281	0.24	1.49
7/16	0.192	0.16	1.47
3/8	0.123	0.11	1.52
5/16	0.073	0.06	1.46
1/4	0.039	0.03	1.41
L3 ¹ / ₂ ×3×1/2	0.260	0.19	1.38
3/8	0.114	0.09	1.43
5/16	0.068	0.05	1.38
1/4	0.036	0.03	1.47

Single Angles

Shape	Torsional Properties		
	<i>J</i>	<i>C_w</i>	<i>a</i>
	in. ⁴	in. ⁶	in.
L3½x2½x½	0.234	0.16	1.33
¾	0.103	0.07	1.33
¼	0.032	0.02	1.27
L3x3x½	0.234	0.14	1.24
⅞	0.160	0.10	1.27
¾	0.103	0.07	1.33
⅝	0.061	0.04	1.30
¼	0.032	0.02	1.27
⅜	0.014	0.01	1.36
L3x2½x½	0.213	0.11	1.16
¾	0.094	0.05	1.17
⅝	0.056	0.03	1.18
¼	0.030	0.02	1.31
⅜	0.013	0.01	1.41
L3x2x½	0.192	0.09	1.10
¾	0.086	0.04	1.10
⅝	0.051	0.02	1.01
¼	0.027	0.01	0.979
⅜	0.012	0.01	1.47
L2½x2½x½	0.185	0.08	1.06
¾	0.082	0.04	1.12
⅝	0.048	0.02	1.04
¼	0.025	0.01	1.02
⅜	0.011	0.01	1.53
L2½x2x¾	0.073	0.03	1.03
⅝	0.043	0.02	1.10
¼	0.023	0.01	1.06
⅜	0.010	—	—
L2x2x¾	0.064	0.02	0.900
⅝	0.038	0.01	0.825
¼	0.020	0.01	1.14
⅜	0.009	—	—
⅛	0.003	—	—

Square HSS	
Shape	J
	in. ⁴
TS30×30× ⁵ / ₈	16,000
TS28×28× ⁵ / ₈	13,000
TS26×26× ⁵ / ₈	10,400
TS24×24× ⁵ / ₈	8,100
¹ / ₂	6,570
³ / ₈	4,990
TS22×22× ⁵ / ₈	6,200
¹ / ₂	5,030
³ / ₈	3,830
TS20×20× ⁵ / ₈	4,620
¹ / ₂	3,760
³ / ₈	2,870
TS18×18× ⁵ / ₈	3,340
¹ / ₂	2,720
³ / ₈	2,080
TS16×16× ⁵ / ₈	2,320
¹ / ₂	1,890
³ / ₈	1,450
⁵ / ₁₆	1,220
TS14×14× ⁵ / ₈	1,530
¹ / ₂	1,250
³ / ₈	963
⁵ / ₁₆	812
TS12×12× ⁵ / ₈	943
¹ / ₂	777
³ / ₈	599
⁵ / ₁₆	506
¹ / ₄	410
TS10×10× ⁵ / ₈	529
¹ / ₂	439
³ / ₈	341
⁵ / ₁₆	289
¹ / ₄	235
³ / ₁₆	179
TS8×8× ⁵ / ₈	258
¹ / ₂	217
³ / ₈	170
⁵ / ₁₆	145
¹ / ₄	118
³ / ₁₆	90.6
TS7×7× ⁵ / ₈	166
¹ / ₂	141
³ / ₈	112
⁵ / ₁₆	95.6
¹ / ₄	78.3
³ / ₁₆	60.2

Square HSS	
Shape	J
	in. ⁴
TS6×6× ⁵ / ₈	99.5
¹ / ₂	85.6
³ / ₈	68.5
⁵ / ₁₆	58.9
¹ / ₄	48.5
³ / ₁₆	37.5
¹ / ₈	25.7
TS5 ¹ / ₂ ×5 ¹ / ₂ × ³ / ₈	51.9
⁵ / ₁₆	44.8
¹ / ₄	37.0
³ / ₁₆	28.6
¹ / ₈	19.7
TS5×5× ¹ / ₂	46.8
³ / ₈	38.2
⁵ / ₁₆	33.1
¹ / ₄	27.4
³ / ₁₆	21.3
¹ / ₈	14.7
TS4 ¹ / ₂ ×4 ¹ / ₂ × ³ / ₈	27.1
⁵ / ₁₆	23.6
¹ / ₄	19.7
³ / ₁₆	15.4
¹ / ₈	10.6
TS4×4× ¹ / ₂	21.8
³ / ₈	18.4
⁵ / ₁₆	16.1
¹ / ₄	13.5
³ / ₁₆	10.6
¹ / ₈	7.40
TS3 ¹ / ₂ ×3 ¹ / ₂ × ⁵ / ₁₆	10.4
¹ / ₄	8.82
³ / ₁₆	6.99
¹ / ₈	4.90
TS3×3× ⁵ / ₁₆	6.22
¹ / ₄	5.35
³ / ₁₆	4.28
¹ / ₈	3.03
TS2 ¹ / ₂ ×2 ¹ / ₂ × ⁵ / ₁₆	3.32
¹ / ₄	2.92
³ / ₁₆	2.38
¹ / ₈	1.71
TS2×2× ⁵ / ₁₆	1.49
¹ / ₄	1.36
³ / ₁₆	1.15
¹ / ₈	0.846
TS1 ¹ / ₂ ×1 ¹ / ₂ × ³ / ₁₆	0.431

Rectangular HSS	
Shape	J
	in. ⁴
TS30×24× ¹ / ₂	9,170
³ / ₈	6,960
⁵ / ₁₆	5,830
TS28×24× ¹ / ₂	8,280
³ / ₈	6,290
⁵ / ₁₆	5,270
TS26×24× ¹ / ₂	7,410
³ / ₈	5,630
⁵ / ₁₆	4,720
TS24×22× ¹ / ₂	5,740
³ / ₈	4,370
⁵ / ₁₆	3,660
TS22×20× ¹ / ₂	4,350
³ / ₈	3,310
⁵ / ₁₆	2,780
TS20×18× ¹ / ₂	3,190
³ / ₈	2,440
⁵ / ₁₆	2,050
TS20×12× ¹ / ₂	1,650
³ / ₈	1,270
⁵ / ₁₆	1,070
TS20×8× ¹ / ₂	806
³ / ₈	625
⁵ / ₁₆	529
TS20×4× ¹ / ₂	205
³ / ₈	165
⁵ / ₁₆	143
TS18×12× ¹ / ₂	1,420
³ / ₈	1,090
⁵ / ₁₆	920
TS18×6× ¹ / ₂	410
³ / ₈	322
⁵ / ₁₆	274
¹ / ₄	224
TS16×12× ¹ / ₂	1,200
³ / ₈	922
⁵ / ₁₆	777
TS16×8× ¹ / ₂	599
³ / ₈	465
⁵ / ₁₆	394
TS16×4× ¹ / ₂	157
³ / ₈	127
⁵ / ₁₆	110

Rectangular HSS	
Shape	J
	in. ⁴
TS14x12x1/2	983
3/8	757
TS14x10x1/2	730
3/8	564
5/16	477
TS14x6x5/8	352
1/2	296
3/8	233
5/16	199
1/4	162
TS14x4x5/8	154
1/2	134
3/8	108
5/16	93.1
1/4	77.0
3/16	59.7
TS12x10x1/2	581
3/8	450
5/16	381
1/4	309
TS12x8x5/8	481
1/2	401
3/8	312
5/16	265
1/4	216
3/16	165
TS12x6x5/8	286
1/2	241
3/8	190
5/16	162
1/4	132
3/16	101
TS12x4x5/8	127
1/2	110
3/8	89.0
5/16	76.9
1/4	63.6
3/16	49.3
TS12x3x5/16	43.6
1/4	36.5
3/16	28.7
TS12x2x1/4	15.9
3/16	12.8
TS10x8x1/2	306
3/8	239
5/16	203
1/4	166
3/16	127

Rectangular HSS	
Shape	J
	in. ⁴
TS10x6x1/2	187
3/8	147
5/16	126
1/4	103
3/16	79.1
TS10x5x3/8	107
5/16	91.5
1/4	75.2
3/16	58.0
TS10x4x1/2	86.9
3/8	70.4
5/16	60.8
1/4	50.4
3/16	39.1
TS10x3x3/8	39.8
5/16	34.9
1/4	29.3
3/16	23.0
TS10x2x3/8	16.5
5/16	14.9
1/4	12.8
3/16	10.3
TS8x6x1/2	135
3/8	107
5/16	91.3
1/4	74.9
3/16	57.6
TS8x4x5/8	73.2
1/2	64.1
3/8	52.2
5/16	45.2
1/4	37.5
3/16	29.1
1/8	20.0
TS8x3x1/2	35.7
3/8	29.9
5/16	26.3
1/4	22.1
3/16	17.3
1/8	12.1
TS8x2x3/8	12.6
5/16	11.4
1/4	9.84
3/16	7.94
1/8	5.66

Rectangular HSS	
Shape	J
	in. ⁴
TS7x5x1/2	79.9
3/8	64.2
5/16	55.3
1/4	45.6
3/16	35.3
1/8	24.2
TS7x4x3/8	43.3
5/16	37.5
1/4	31.2
3/16	24.2
1/8	16.7
TS7x3x3/8	25.1
5/16	22.0
1/4	18.5
3/16	14.6
1/8	10.2
TS6x4x1/2	42.1
3/8	34.6
5/16	30.1
1/4	25.0
3/16	19.5
1/8	13.5
TS6x3x1/2	23.9
3/8	20.3
5/16	17.9
1/4	15.1
3/16	11.9
1/8	8.27
TS6x2x3/8	8.72
5/16	7.94
1/4	6.88
3/16	5.56
1/8	3.98
TS5x4x3/8	26.3
5/16	22.9
1/4	19.1
3/16	14.9
TS5x3x1/2	18.2
3/8	15.6
5/16	13.8
1/4	11.7
3/16	9.21
1/8	6.44
TS5x2x5/16	6.24
1/4	5.43
3/16	4.40
1/8	3.15

Rectangular HSS	
Shape	<i>J</i>
	in. ⁴
TS4x3x ⁵ / ₁₆	9.89
1/4	8.41
³ / ₁₆	6.67
1/8	4.68
TS4x2x ³ / ₈	4.97
⁵ / ₁₆	4.58
1/4	4.01
³ / ₁₆	3.26
1/8	2.34
TS3x2x ⁵ / ₁₆	2.97
1/4	2.63
³ / ₁₆	2.16
1/8	1.57
TS2 ¹ / ₂ x1 ¹ / ₂ x ¹ / ₄	1.14
³ / ₁₆	0.976

Steel Pipe			
Nominal Diameter	<i>J</i>		
	in. ⁴		
in.	<i>P</i>	<i>PX</i>	<i>PXX</i>
1/2	0.034	0.040	—
3/4	0.074	0.090	—
1	0.175	0.211	—
1 1/4	0.389	0.484	—
1 1/2	0.620	0.782	—
2	1.33	1.74	2.62
2 1/2	3.06	3.85	5.74
3	6.03	8.13	12.0
3 1/2	9.58	12.6	—
4	14.5	19.2	30.6
5	30.3	41.3	67.3
6	56.3	81.0	133
8	145	211	324
10	321	424	—
12	559	723	—

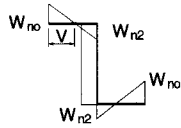

Z-shapes

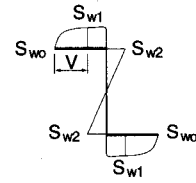

Shape	Torsional Properties					Statical Moments	
	J	C_w	a	W_{no}	S_{w1}	Q_f	Q_w
	in. ⁴	in. ⁶	in.	in. ²	in. ⁴	in. ³	in. ³
Z4×10.3	0.11	10.3	15.8	3.85	1.70	1.24	0.99
8.2	0.06	8.03	19.4	3.82	1.68	0.97	0.79
Z3×6.7	0.05	2.72	12.3	2.38	1.15	0.51	0.39

Appendix B

CASE CHARTS OF TORSIONAL FUNCTIONS

Determine the case based upon the end conditions and type of loading. For the given cross-section and span length, compute the value of l/a using l in inches and a as given in Appendix A. With this value, enter the appropriate chart from the loading. At the desired location along the horizontal scale, read vertically upward to the appropriate l/a curve and read from the vertical scale the value of the torsional function. (For values of l/a between curves, use linear interpolation.) This value should then be divided by the factor indicated by the group of terms shown in the labels on the curves to obtain the value of θ , θ' , θ'' , or θ''' . This result may then be used in Equation 4.1, 4.2, or 4.3 to determine τ , τ_w , or σ_w .

Sign Convention

In all cases, the torsional moment (T , t) is shown acting in a counter-clockwise direction when viewed toward the left end of the member. This is considered to be a positive moment in this book. Thus, if the applied torsional moment is in the opposite direction, it should be assigned a negative value for computational purposes. A positive stress or rotation computed with the equations and torsional constants of this book acts in the direction shown in the cross-sectional views shown in Figures 4.1, 4.2, and 4.3. A negative value indicates the direction is opposite to that shown.

On some of the Case Charts, the applied torsional moment is indicated by a vector notation using a line with two arrowheads. This notation indicates the "right-hand rule," wherein the thumb of the right hand is extended and pointed in the direction of the vector, and the remaining fingers of the right hand curve in the direction of the moment.

In Figures 4.2 and 4.3, the positive direction of the stresses is shown for channels and Z-shapes oriented such that the top flange extended to the left when viewed toward the left end of the member. For the reverse orientation of these members with the applied torque remaining in a counterclockwise direction, the following applies:

- τ = the positive direction of the stresses in the flanges is the same as shown in Figures 4.2b and 4.3b. For example, at the top edge of the top flange, a positive stress acts from left to right. A positive stress at the left edge of the web acts downward; a positive stress at the right edge of the web acts upward.
- σ_w = the positive direction of the stresses at the corresponding points on the reversed section are opposite those shown in Figures 4.2d and 4.3d. For example, a positive stress at the tips of the flanges, point o , is a tensile stress.

Case1

$$\theta \times \left(\frac{GJ}{Tl}\right)$$

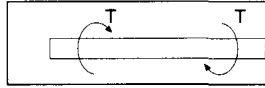

Torsional End Restraints	
Left End	Right End
Free $\theta = \theta'' = 0$	Free $\theta'' = 0$

Concentrated torques at ends of member with free ends

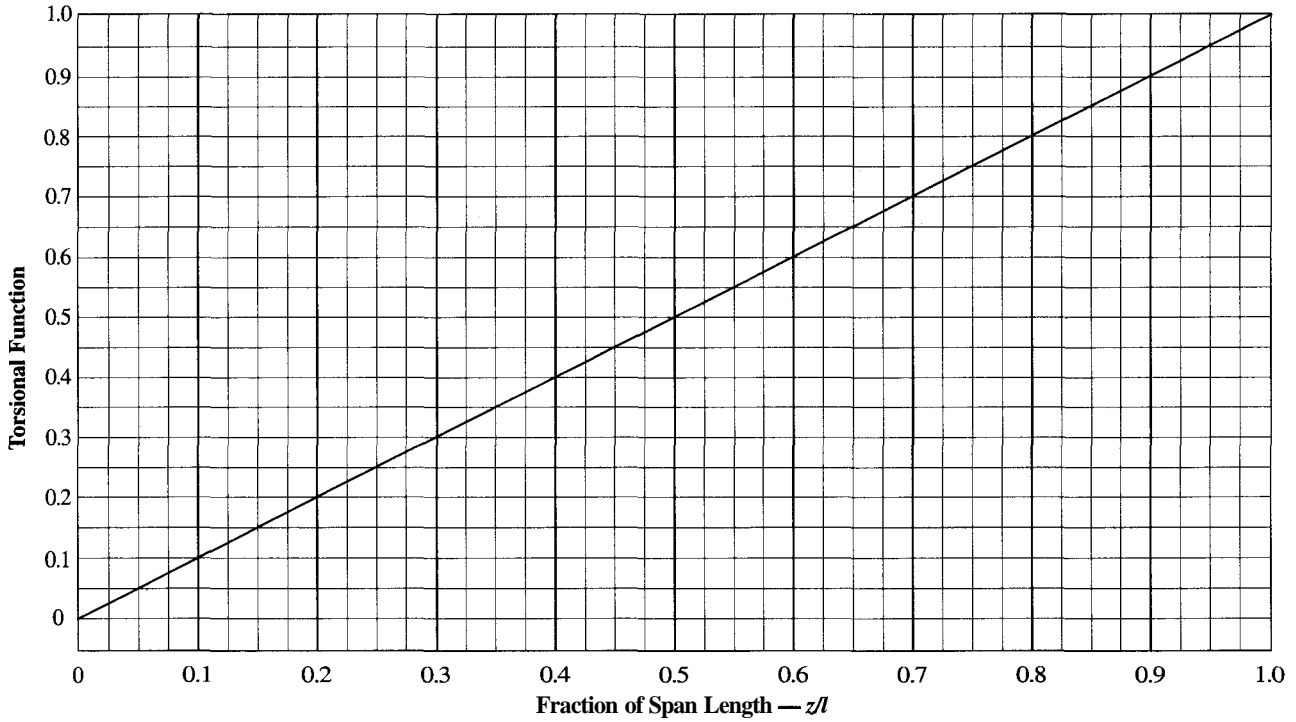

Case1

$$\theta' \times \left(\frac{GJ}{T}\right) = 1.0$$

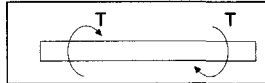

Torsional End Restraints	
Left End	Right End
Free $\theta = \theta'' = 0$	Free $\theta'' = 0$

Concentrated torques at ends of member with free ends

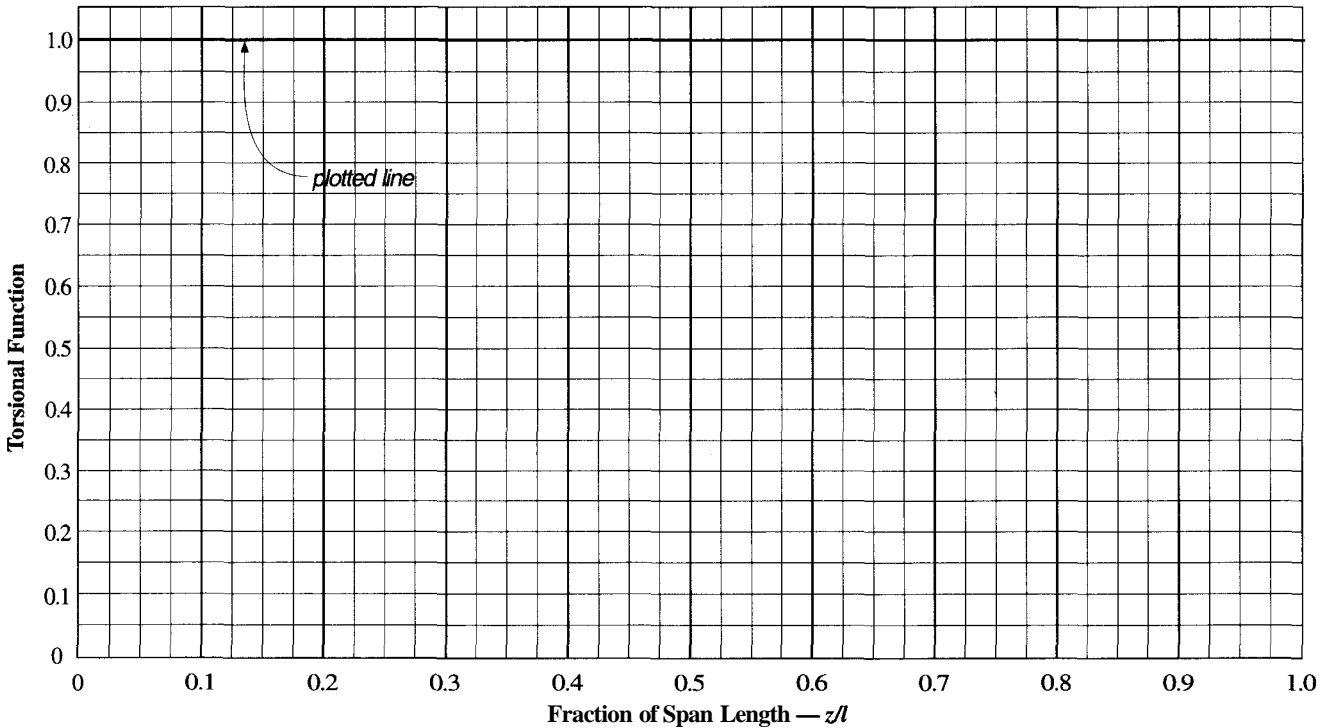

Case 2

$$\theta \times \left(\frac{GJ}{T} \times \frac{1}{2a} \right)$$

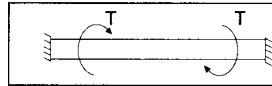

Torsional End Restraints	
Left End	Right End
Fixed $\theta = \theta' = 0$	Fixed $\theta' = 0$

Concentrated torques at ends of member with fixed ends

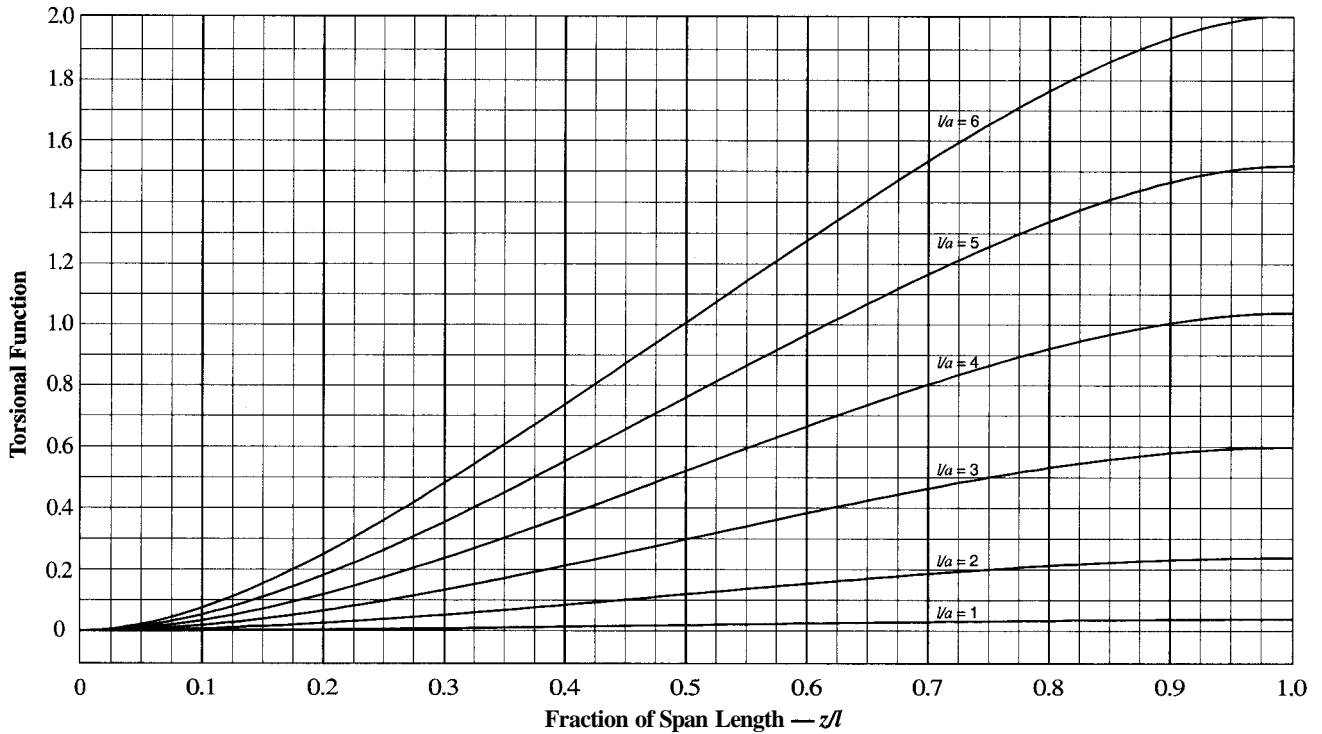

Case 2

$$\theta' \times \left(\frac{GJ}{T} \right)$$

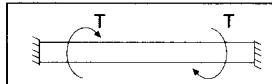

Torsional End Restraints	
Left End	Right End
Fixed $\theta = \theta' = 0$	Fixed $\theta' = 0$

Concentrated torques at ends of member with fixed ends

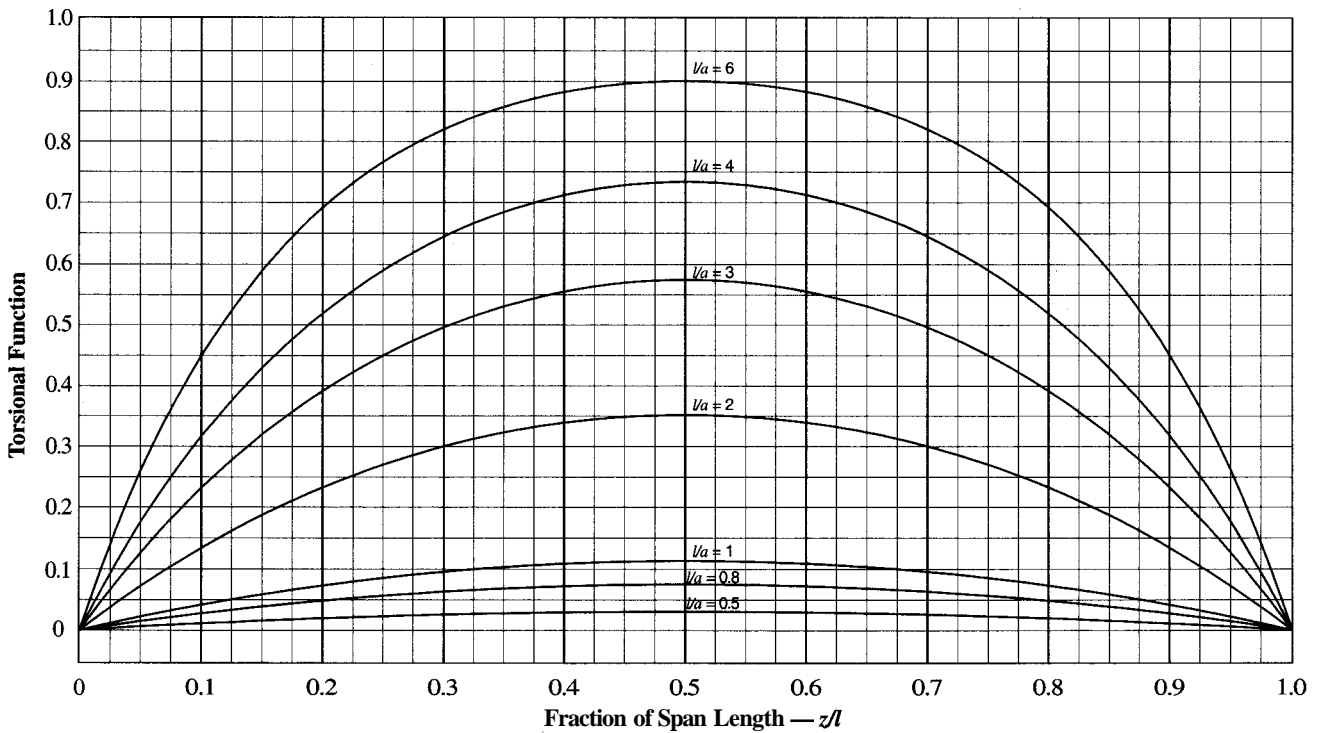

Case 2 $\theta'' \times \left(\frac{GJ}{T} \times a\right)$

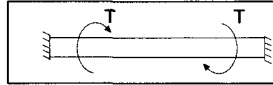

Torsional End Restraints		Concentrated torques at ends of member with fixed ends
Left End	Right End	
Fixed $\theta = \theta' = 0$	Fixed $\theta' = 0$	

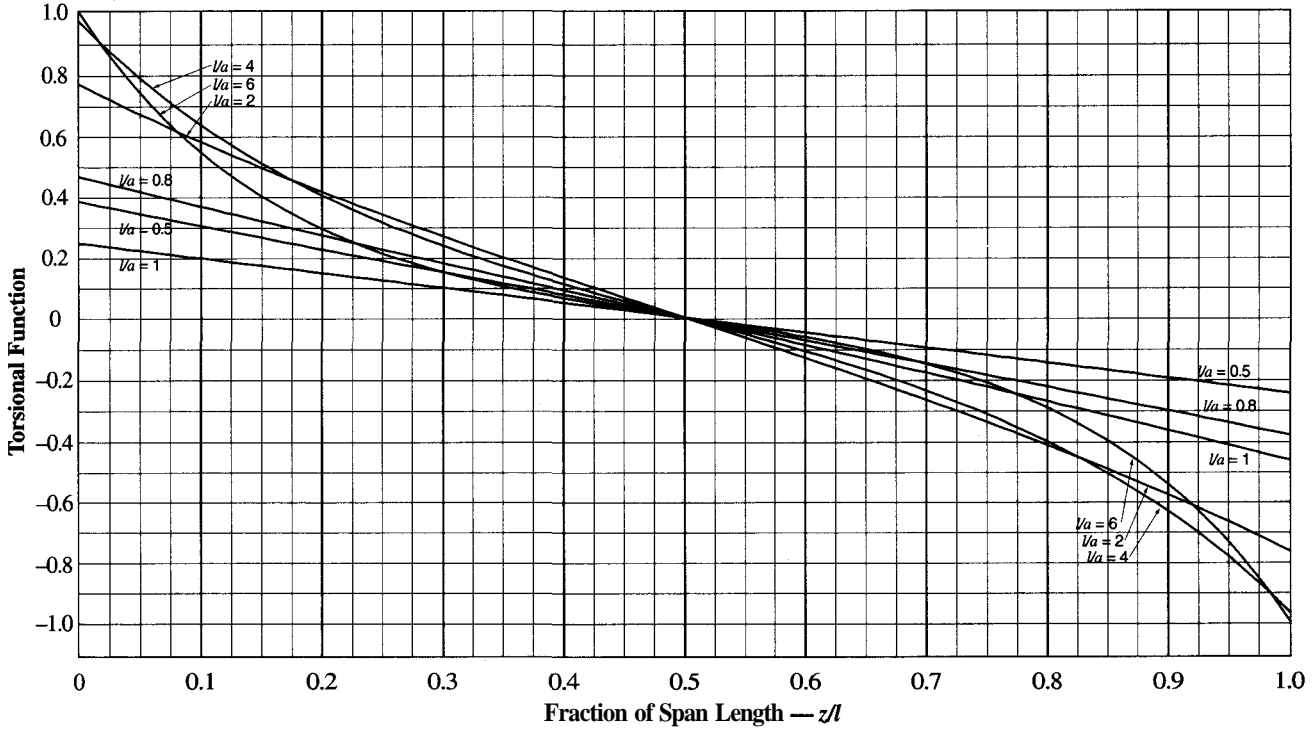

Case 2 $\theta''' \times \left(\frac{GJ}{T} \times a^2\right)$

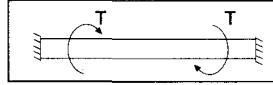

Torsional End Restraints		Concentrated torques at ends of member with fixed ends
Left End	Right End	
Fixed $\theta = \theta' = 0$	Fixed $\theta' = 0$	

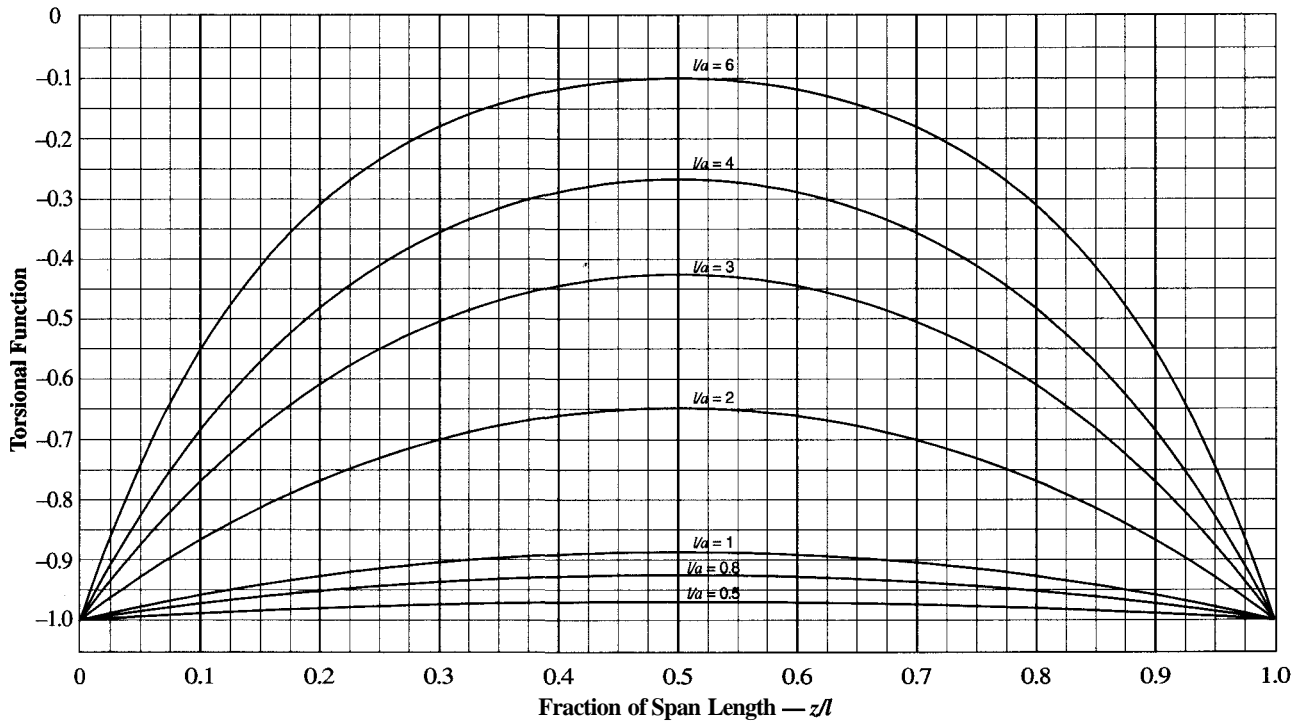

Case 3 $\theta \times \left(\frac{GJ}{T} \times \frac{5}{l}\right)$
 $\alpha = 0.1$

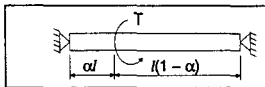

Torsional End Restraints		Concentrated torque at $\alpha = 0.1$ on member with pinned ends. <input type="checkbox"/>
Left End	Right End	
Pinned $\theta = \theta' = 0$	Pinned $\theta' = 0$	<input type="checkbox"/>

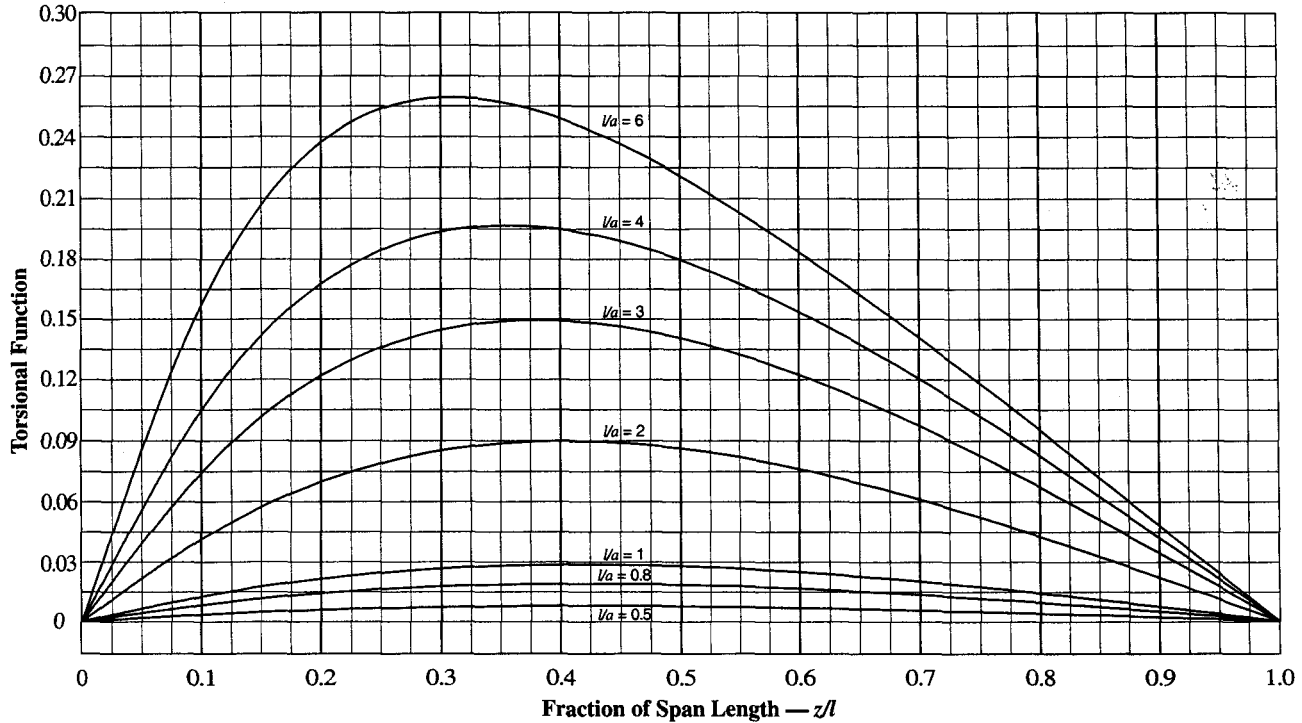

Case 3 $\theta' \times \left(\frac{GJ}{T}\right)$
 $\alpha = 0.1$

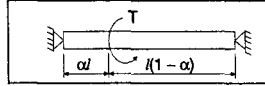

Torsional End Restraints		Concentrated torque at $\alpha = 0.1$ on member with pinned ends. <input type="checkbox"/>
Left End	Right End	
Pinned $\theta = \theta' = 0$	Pinned $\theta' = 0$	<input type="checkbox"/>

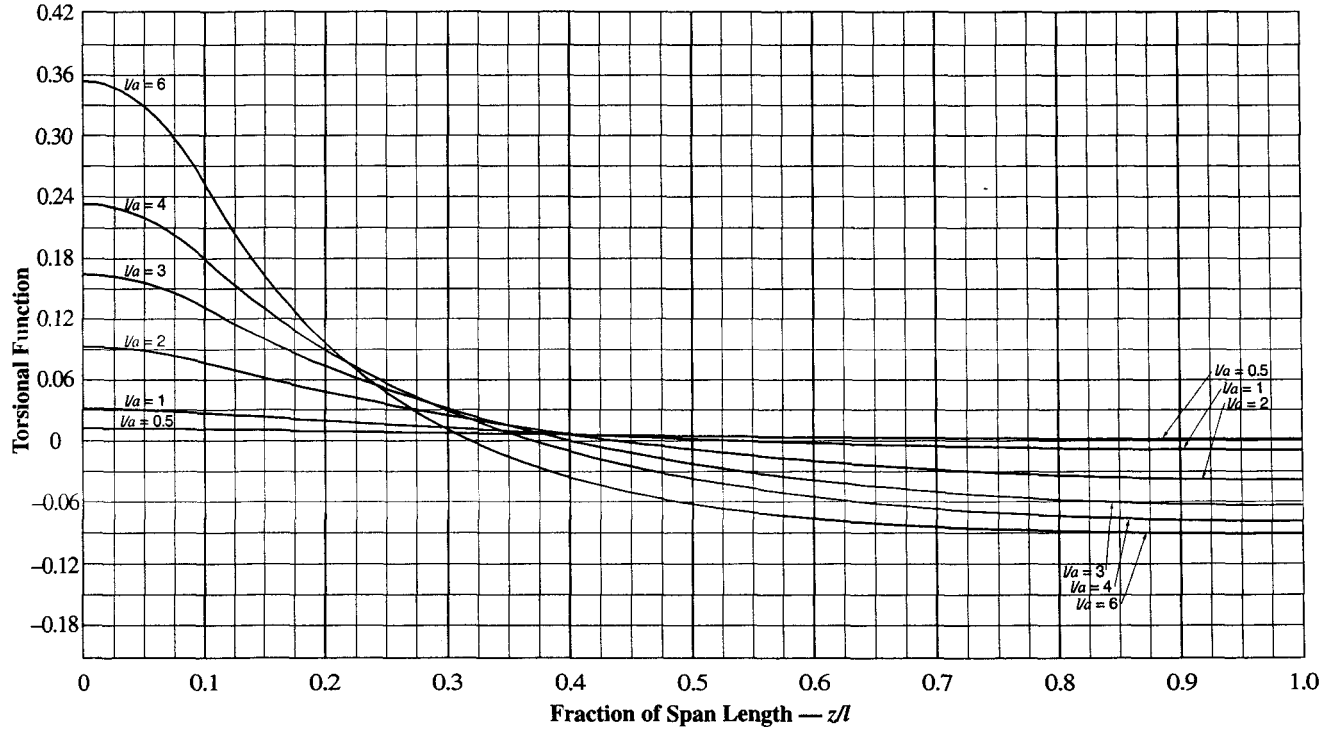

Case3
 $\alpha = 0.1$

$$\theta'' \times \left(\frac{GJ}{T} \times a \right)$$

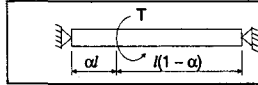

Torsional End Restraints	
Left End	Right End
Pinned $\theta = \theta' = 0$	Pinned $\theta' = 0$

Concentrated torque at $\alpha = 0.1$ on member with pinned ends.

Rev. 3/1/03

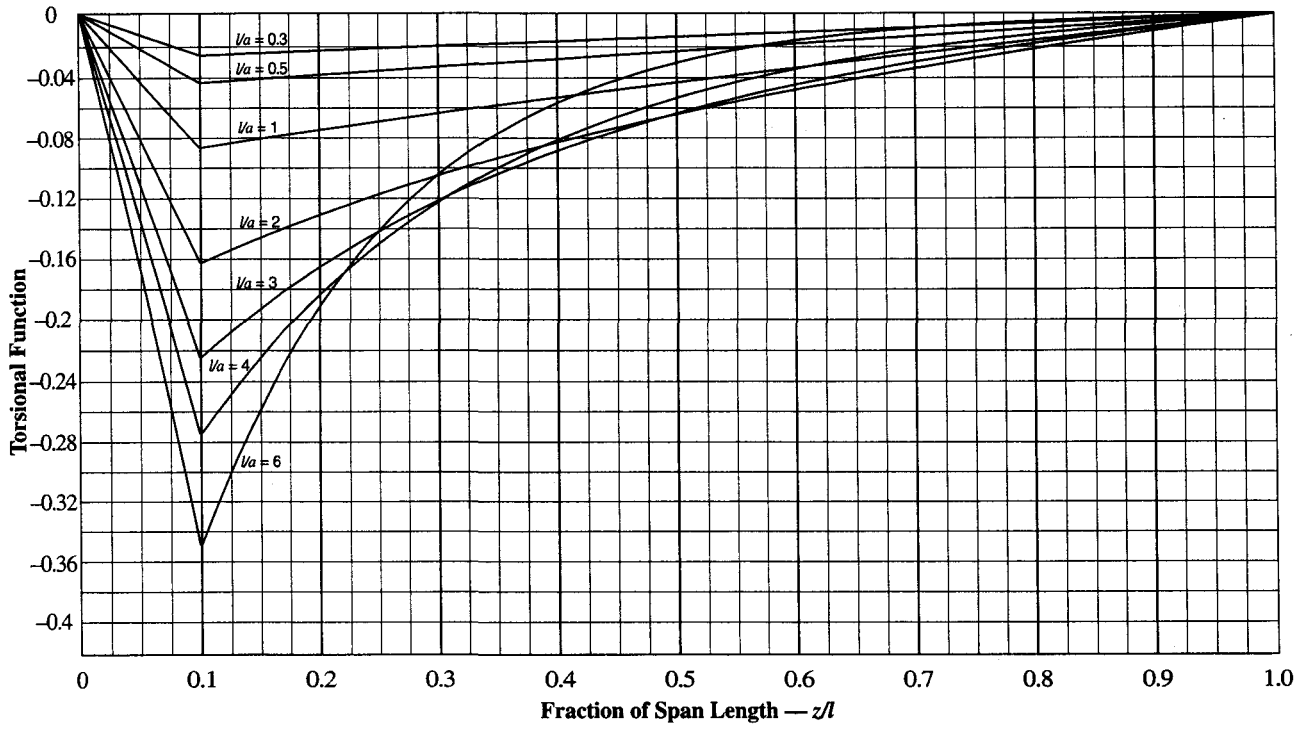

Case3
 $\alpha = 0.1$

$$\theta''' \times \left(\frac{GJ}{T} \times a^2 \right)$$

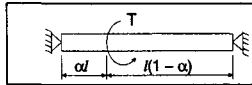

Torsional End Restraints	
Left End	Right End
Pinned $\theta = \theta' = 0$	Pinned $\theta' = 0$

Concentrated torque at $\alpha = 0.1$ on member with pinned ends.

Rev. 3/1/03

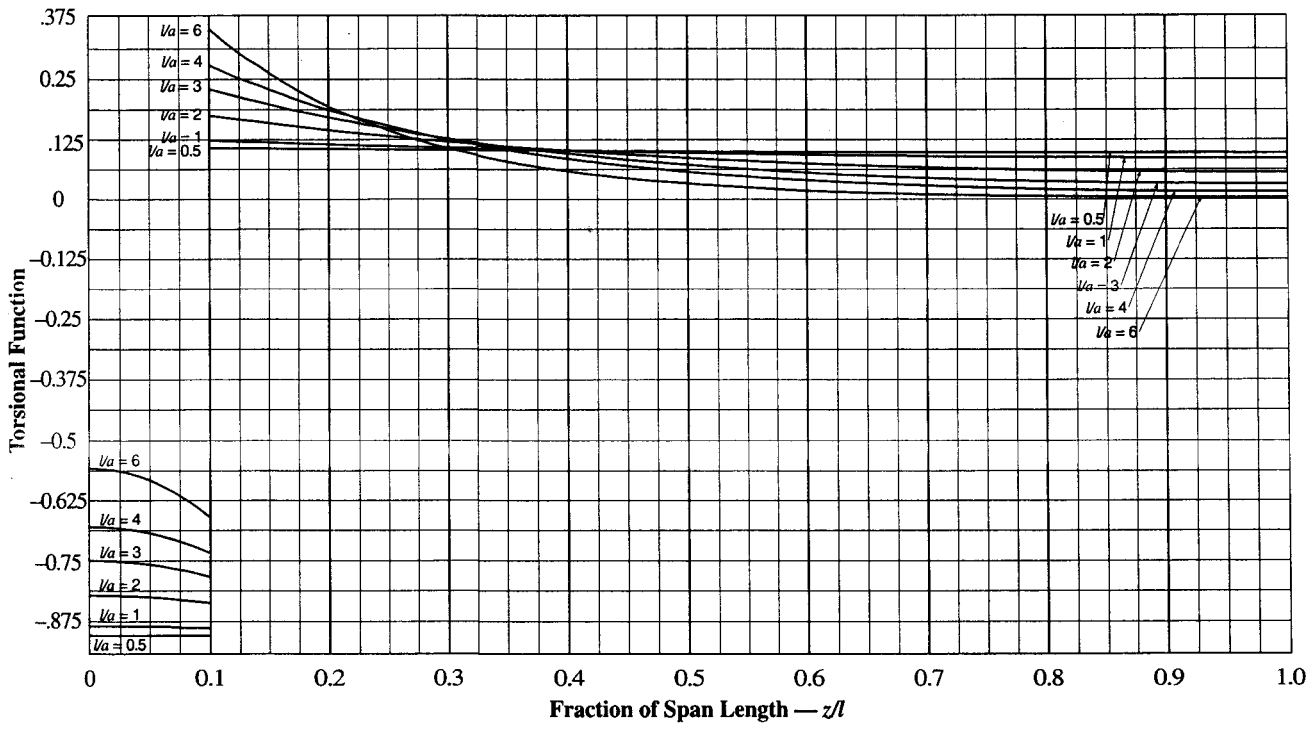

Case 3

$\alpha = 0.3$

$$\theta \times \left(\frac{GJ}{T} \times \frac{1}{l} \right)$$

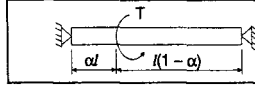

Torsional End Restraints	
Left End	Right End
Pinned $\theta = \theta'' = 0$	Pinned $\theta = \theta'' = 0$

Concentrated torque at $\alpha = 0.3$ on member with pinned ends

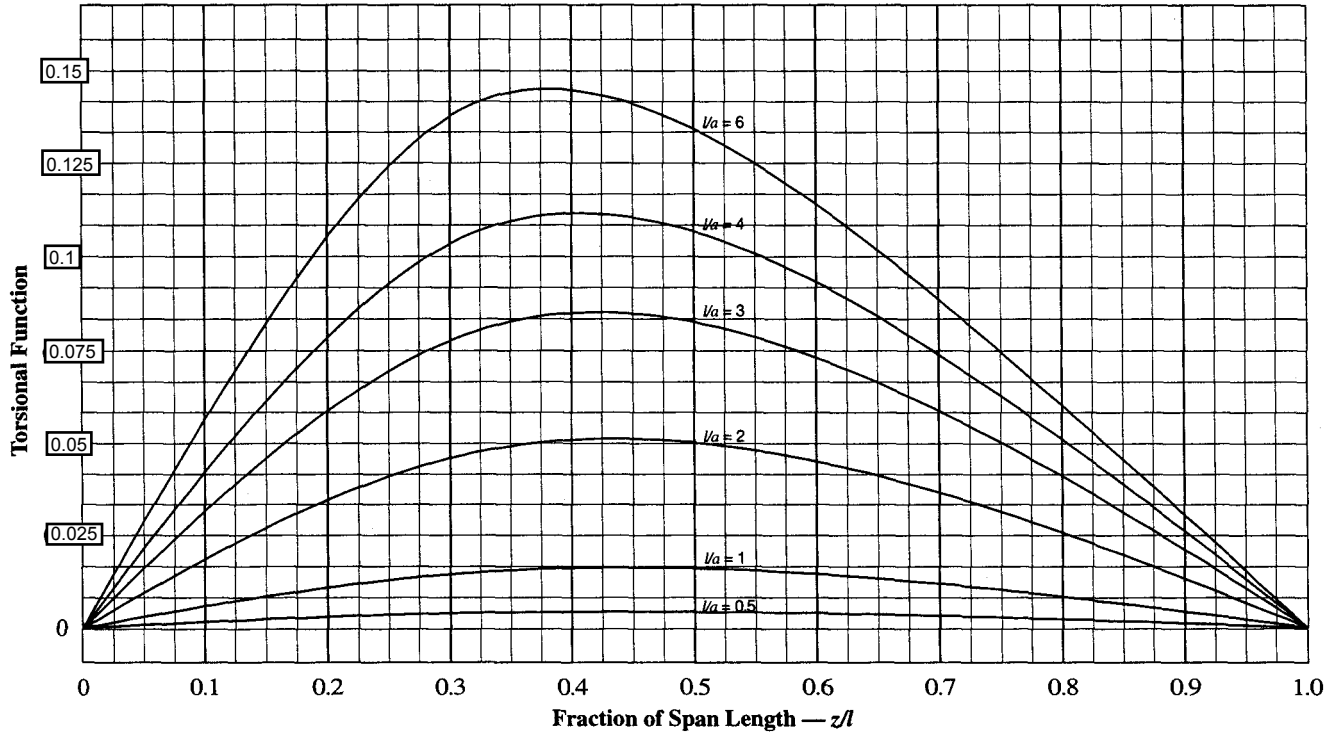

Rev.
3/1/03

Case 3

$\alpha = 0.3$

$$\theta' \times \left(\frac{GJ}{T} \right)$$

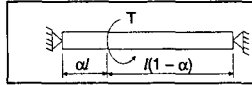

Torsional End Restraints	
Left End	Right End
Pinned $\theta = \theta'' = 0$	Pinned $\theta = \theta'' = 0$

Concentrated torque at $\alpha = 0.3$ on member with pinned ends

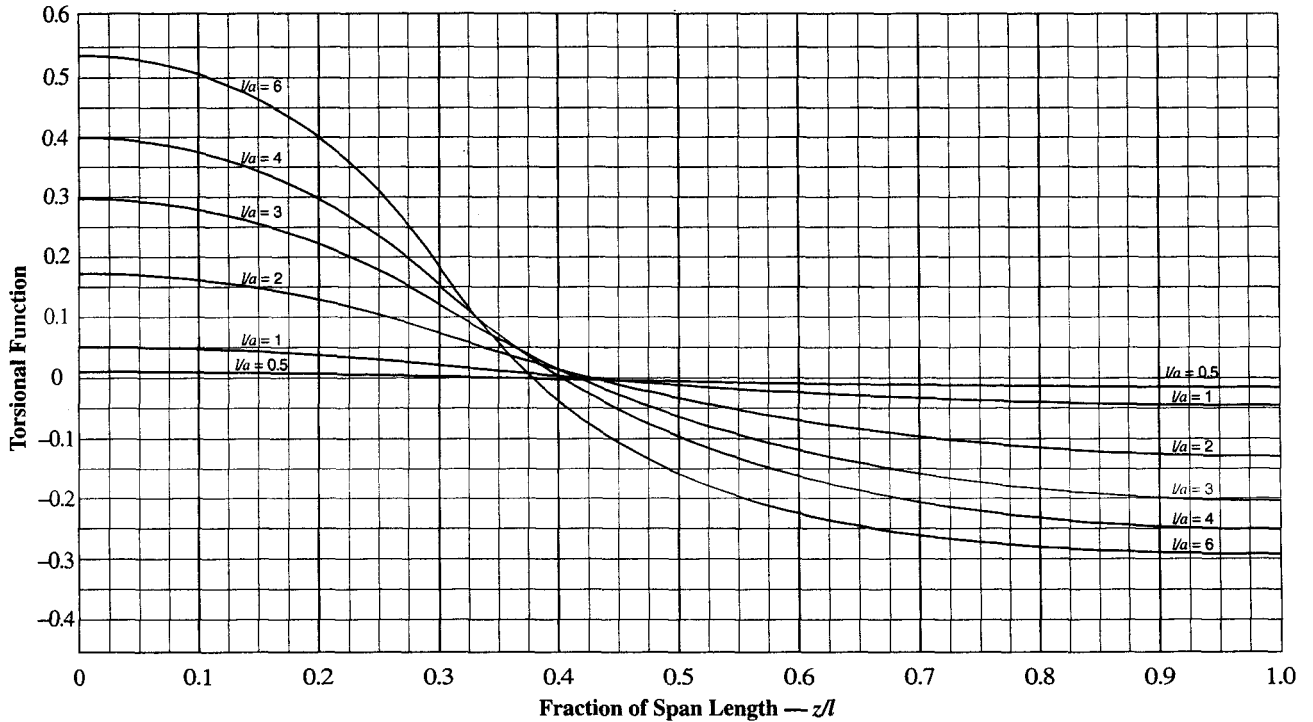

Case 3

$\alpha = 0.3$

$$\theta'' \times \left(\frac{GJ}{T} \times a \right)$$

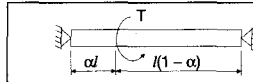

Torsional End Restraints	
Left End	Right End
Pinned $\theta = \theta'' = 0$	Pinned $\theta = \theta'' = 0$

Concentrated torque at $\alpha = 0.3$ on member with pinned ends

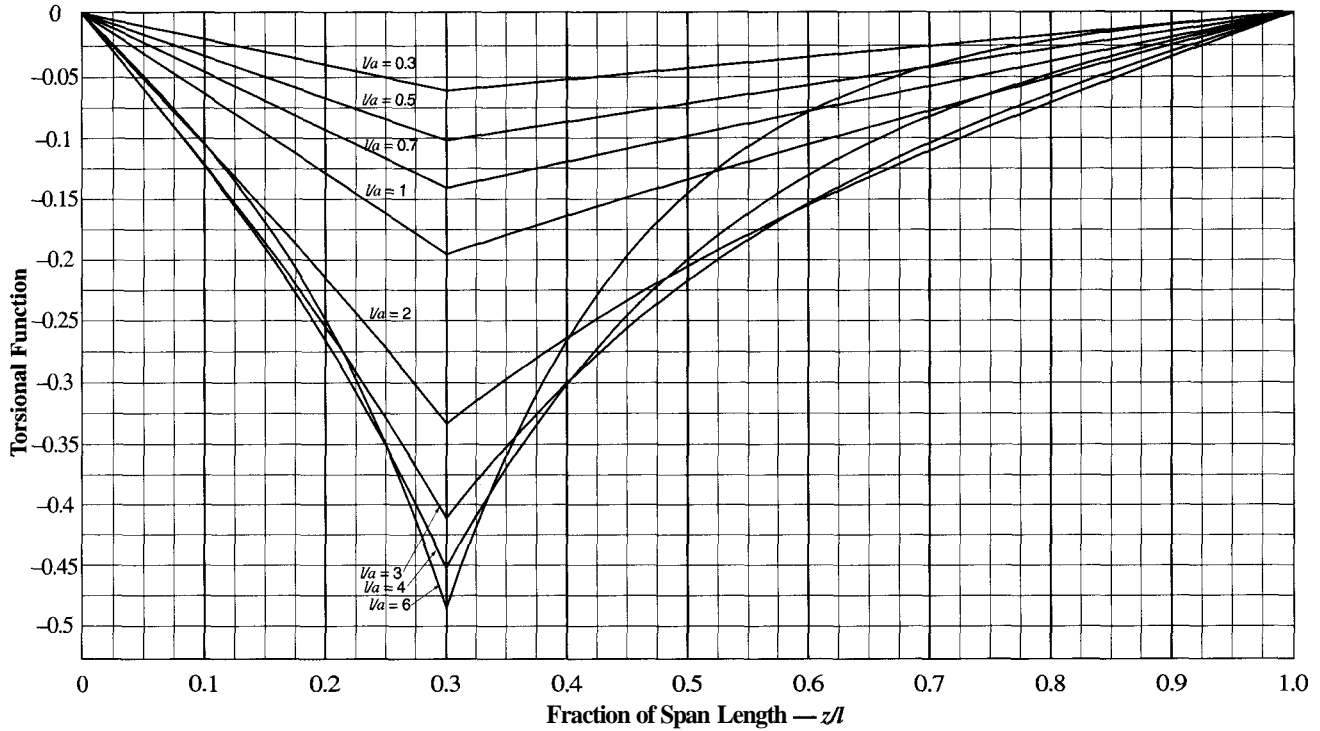

Case 3

$\alpha = 0.3$

$$\theta''' \times \left(\frac{GJ}{T} \times a^2 \right)$$

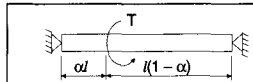

Torsional End Restraints	
Left End	Right End
Pinned $\theta = \theta'' = 0$	Pinned $\theta = \theta'' = 0$

Concentrated torque at $\alpha = 0.3$ on member with pinned ends

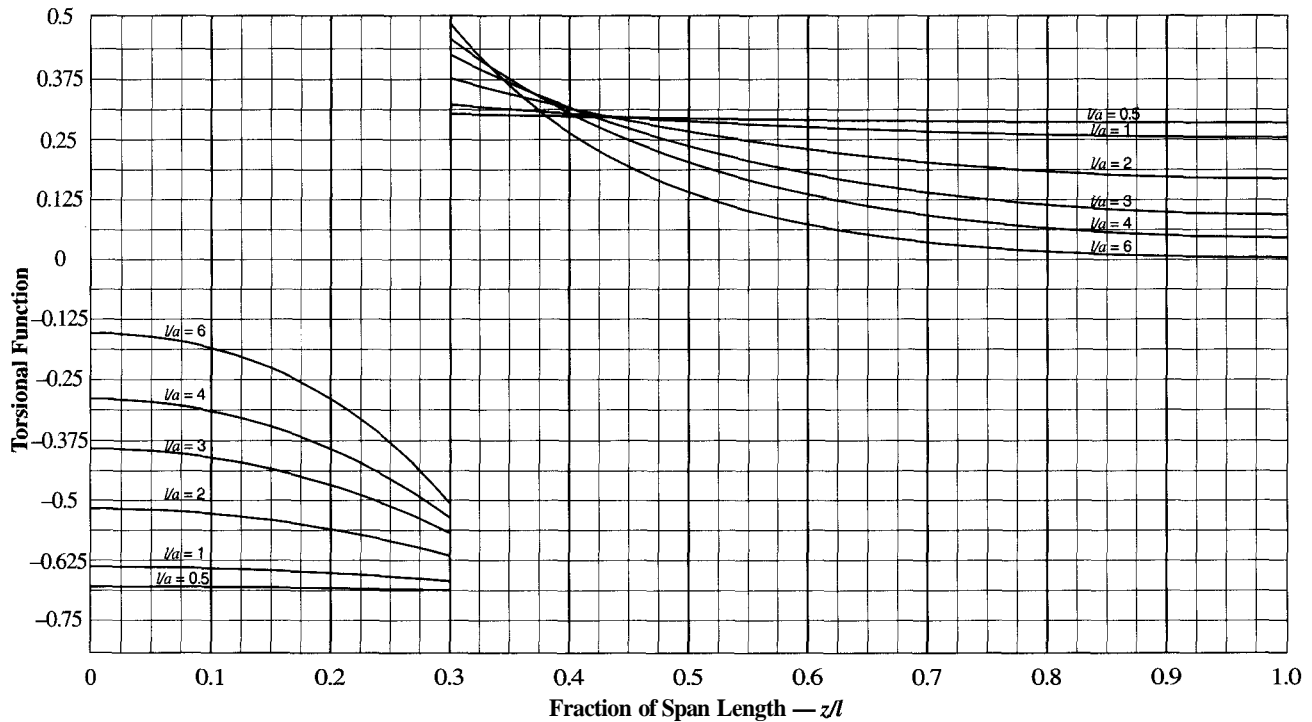

Case3

$\alpha = 0.5$

$$\theta \times \left(\frac{GJ}{T} \times \frac{1}{l} \right)$$

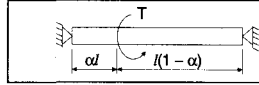

Torsional End Restraints	
Left End	Right End
Pinned $\theta = \theta'' = 0$	Pinned $\theta = \theta'' = 0$

Concentrated torque at $\alpha = 0.5$ on member with pinned ends

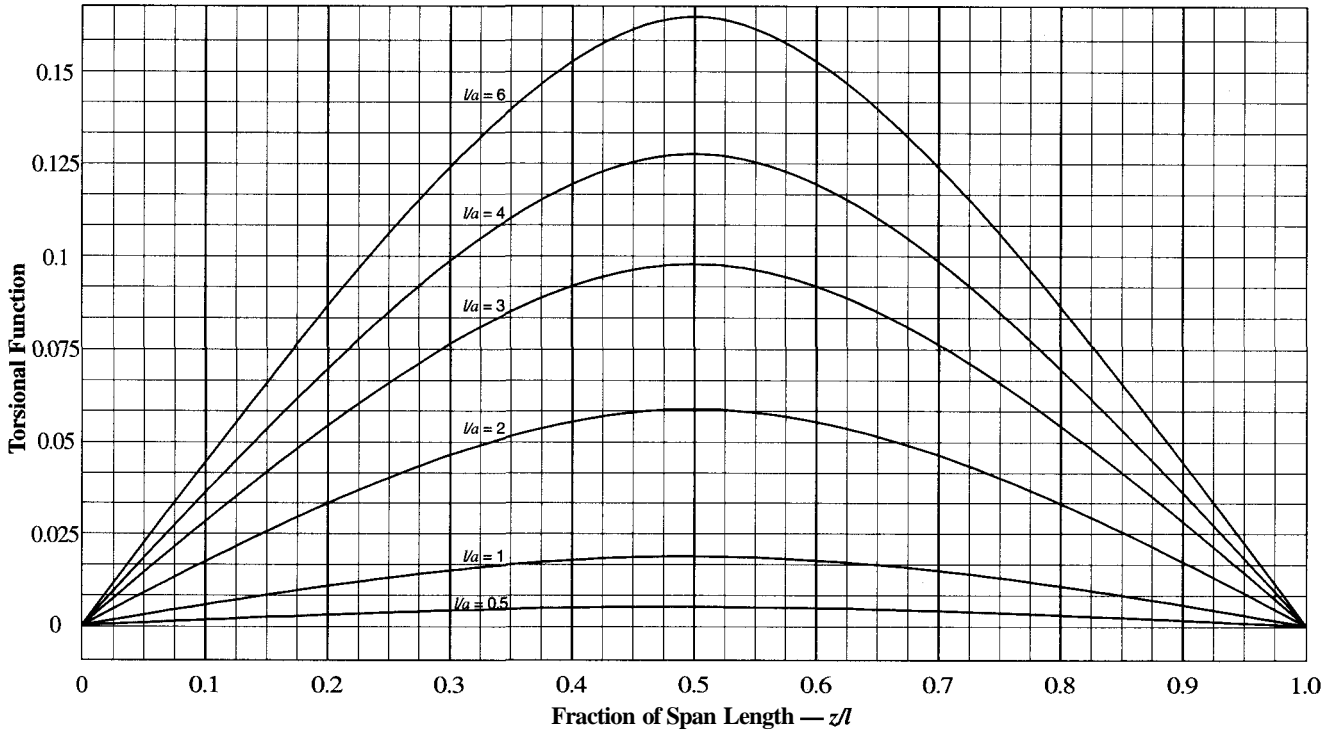

Case3

$\alpha = 0.5$

$$\theta' \times \left(\frac{GJ}{T} \right)$$

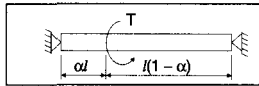

Torsional End Restraints	
Left End	Right End
Pinned $\theta = \theta'' = 0$	Pinned $\theta = \theta'' = 0$

Concentrated torque at $\alpha = 0.5$ on member with pinned ends

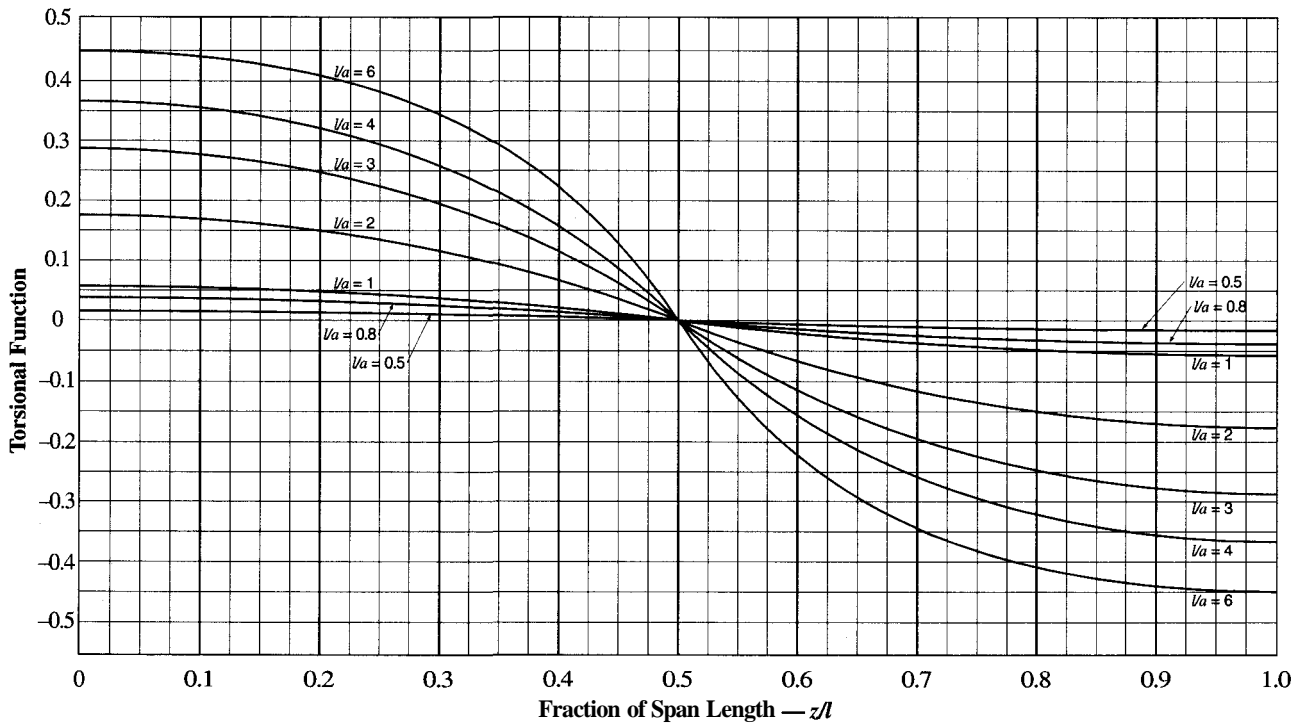

Case3

$\alpha = 0.5$

$$\theta'' \times \left(\frac{GJ}{T} \times a \right)$$

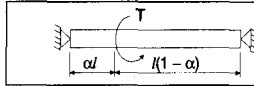

Torsional End Restraints	
Left End	Right End
Pinned $\theta = \theta'' = 0$	Pinned $\theta = \theta'' = 0$

Concentrated torque at $\alpha = 0.5$ on member with pinned ends

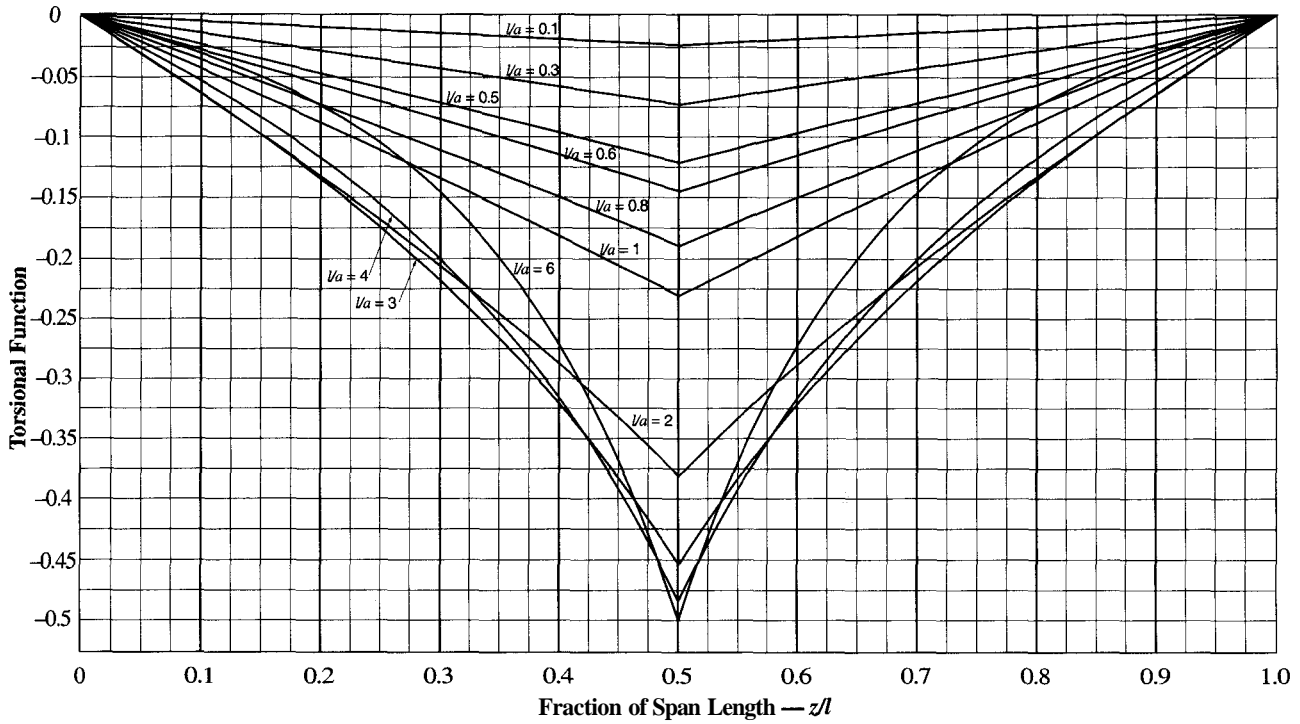

Case3

$\alpha = 0.5$

$$\theta''' \times \left(\frac{GJ}{T} \times a^2 \right)$$

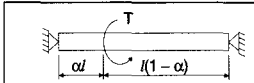

Torsional End Restraints	
Left End	Right End
Pinned $\theta = \theta'' = 0$	Pinned $\theta = \theta'' = 0$

Concentrated torque at $\alpha = 0.5$ on member with pinned ends

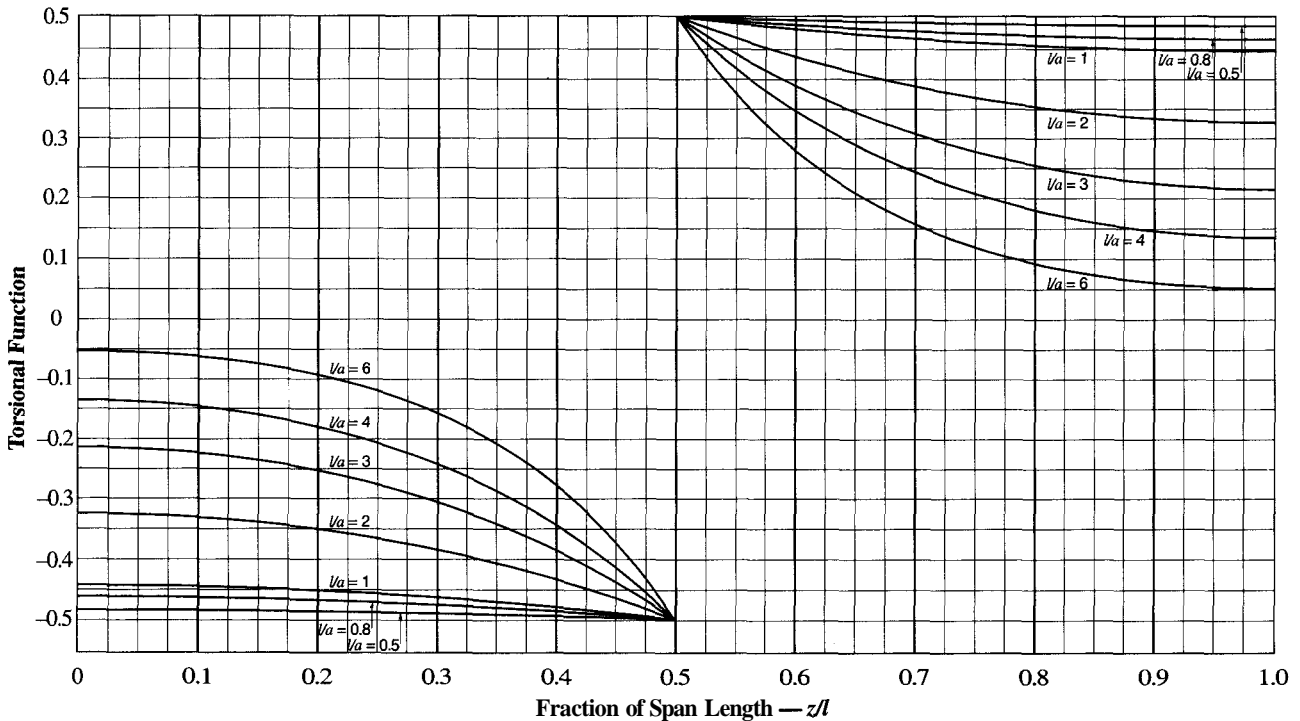

Case 4 $\theta \times \left(\frac{GJ}{t} \times \frac{1}{2a^2} \right)$



Torsional End Restraints		Uniformly distributed torque on member with pinned ends
Left End	Right End	
Pinned $\theta = \theta'' = 0$	Pinned $\theta = \theta'' = 0$	

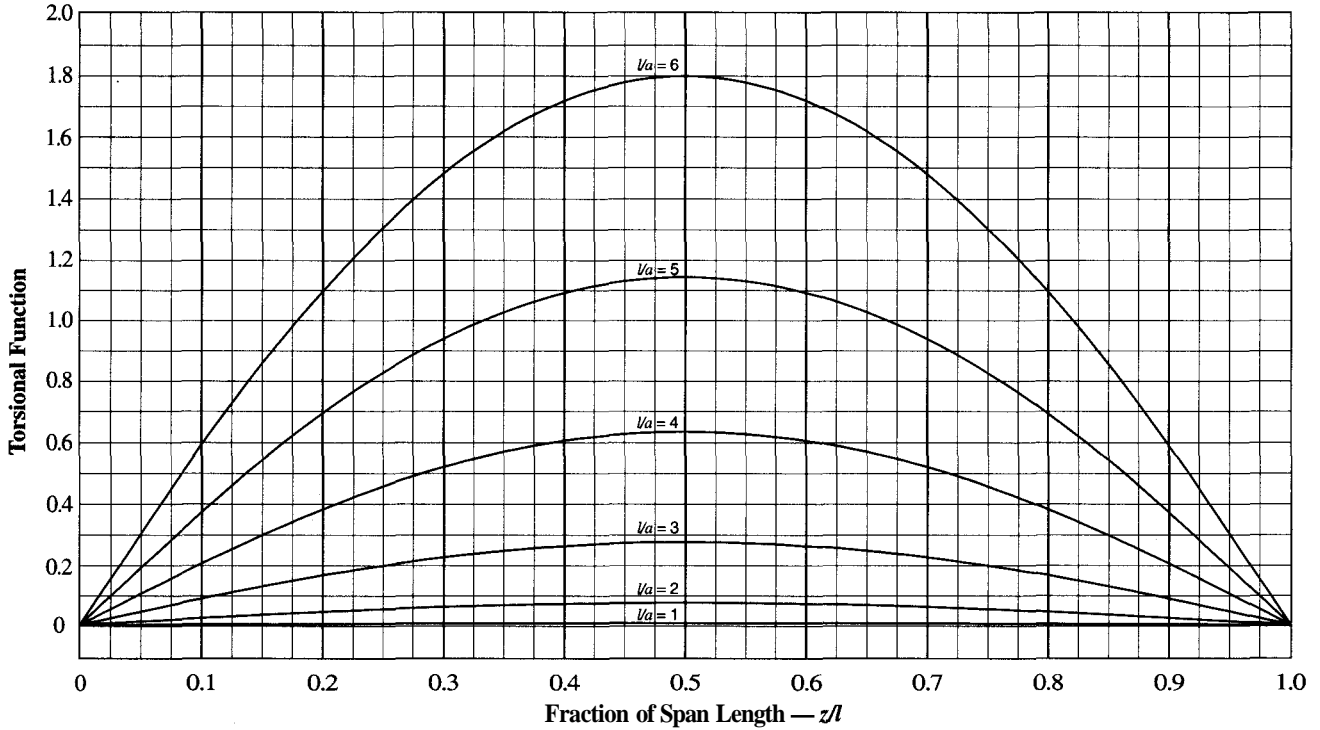

Case 4 $\theta' \times \left(\frac{GJ}{t} \times \frac{l}{10a^2} \right)$



Torsional End Restraints		Uniformly distributed torque on member with pinned ends
Left End	Right End	
Pinned $\theta = \theta'' = 0$	Pinned $\theta = \theta'' = 0$	

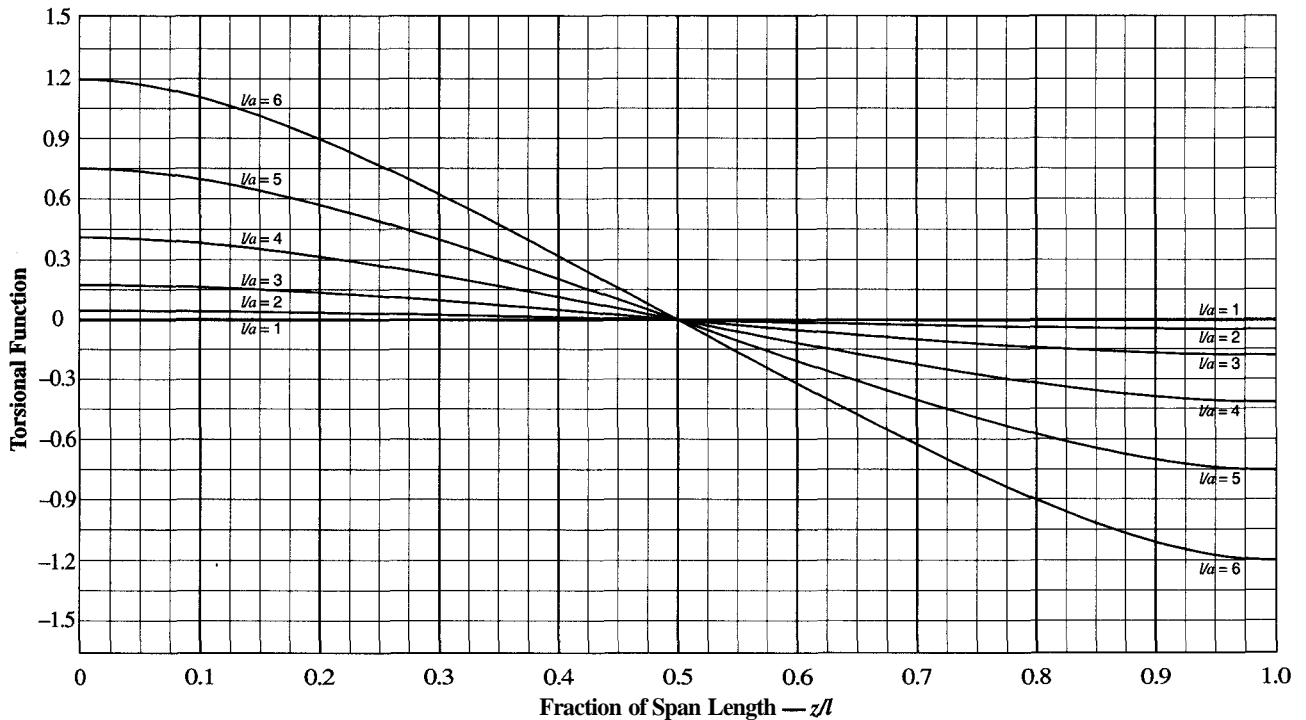

Case 4 $\theta'' \times \left(\frac{GJ}{t}\right)$

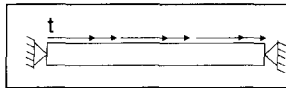

Torsional End Restraints	
Left End	Right End
Pinned $\theta = \theta'' = 0$	Pinned $\theta = \theta'' = 0$

Uniformly distributed torque on member with pinned ends

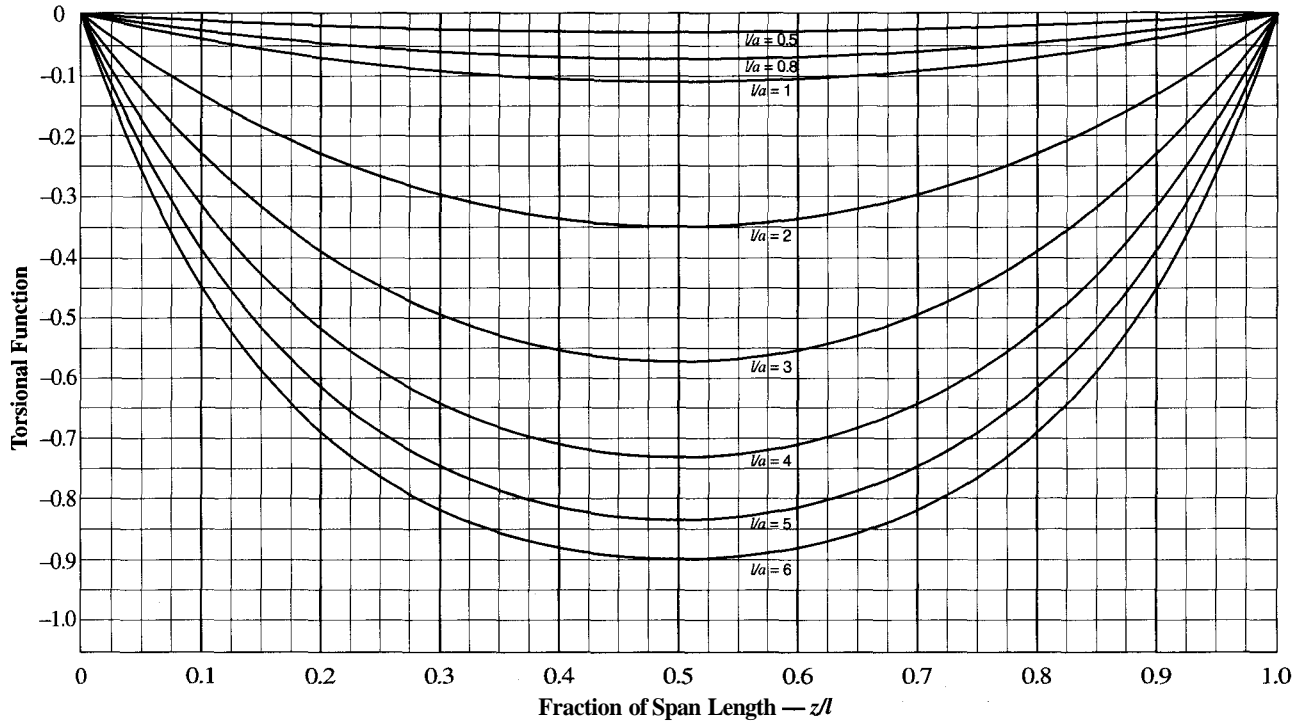

Case 4 $\theta''' \times \left(\frac{GJ}{t} \times a\right)$



Torsional End Restraints	
Left End	Right End
Pinned $\theta = \theta'' = 0$	Pinned $\theta = \theta'' = 0$

Uniformly distributed torque on member with pinned ends

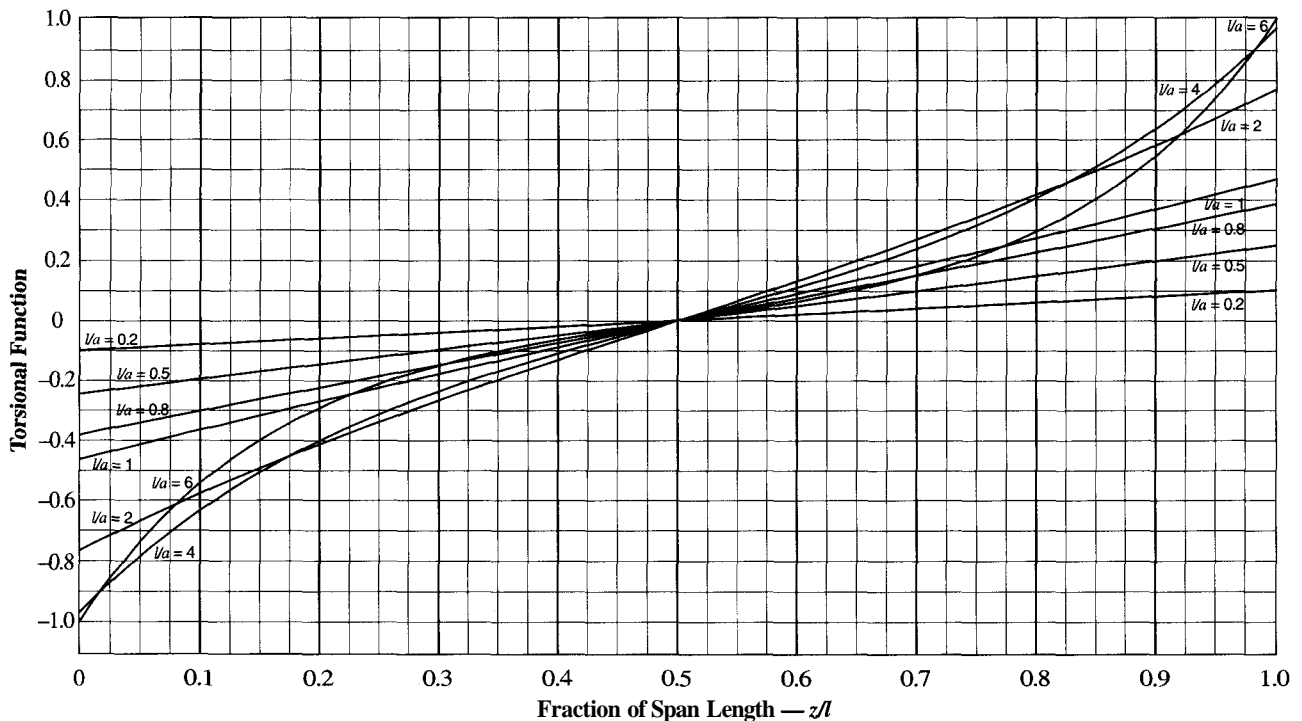

Case 5

$$\theta \times \left(\frac{GJ}{t} \times \frac{1}{l^2} \right)$$

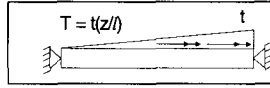

Torsional End Restraints			
Left End		Right End	
Pinned	$\theta = \theta'' = 0$	Pinned	$\theta = \theta'' = 0$

Linearly varying torque on member with pinned ends

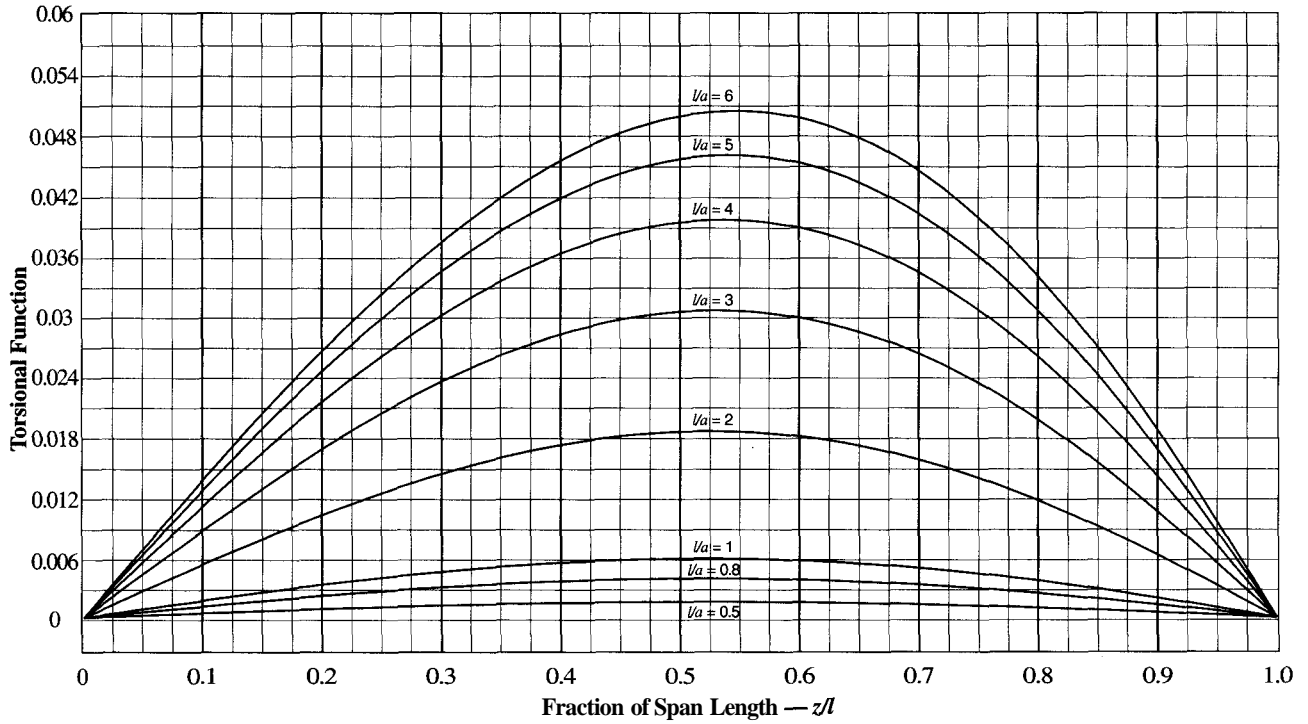

Case 5

$$\theta' \times \left(\frac{GJ}{t} \times \frac{1}{l} \right)$$

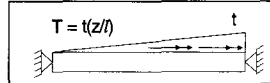

Torsional End Restraints			
Left End		Right End	
Pinned	$\theta = \theta'' = 0$	Pinned	$\theta = \theta'' = 0$

Linearly varying torque on member with pinned ends

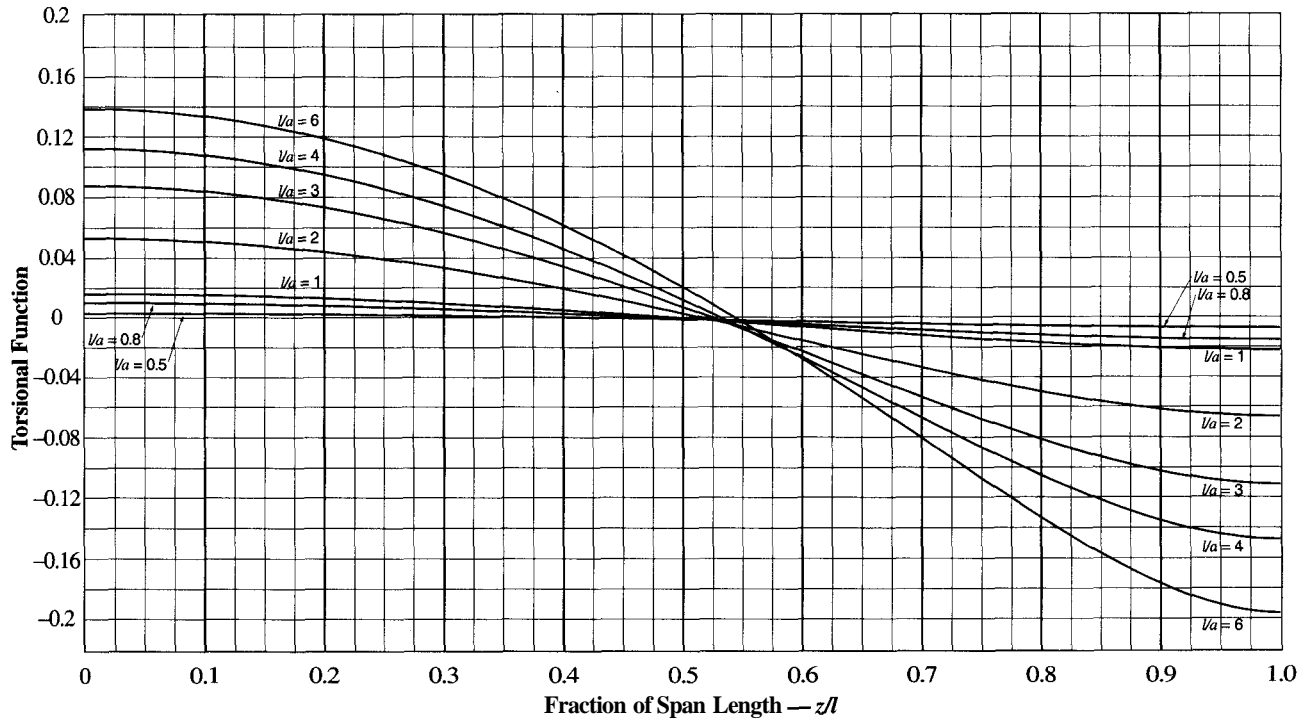

Case 5

$$\theta'' \times \left(\frac{GJ}{t} \right)$$

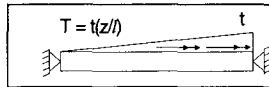

Torsional End Restraints	
Left End	Right End
Pinned $\theta = \theta'' = 0$	Pinned $\theta = \theta'' = 0$

Linearly varying torque on member with pinned ends

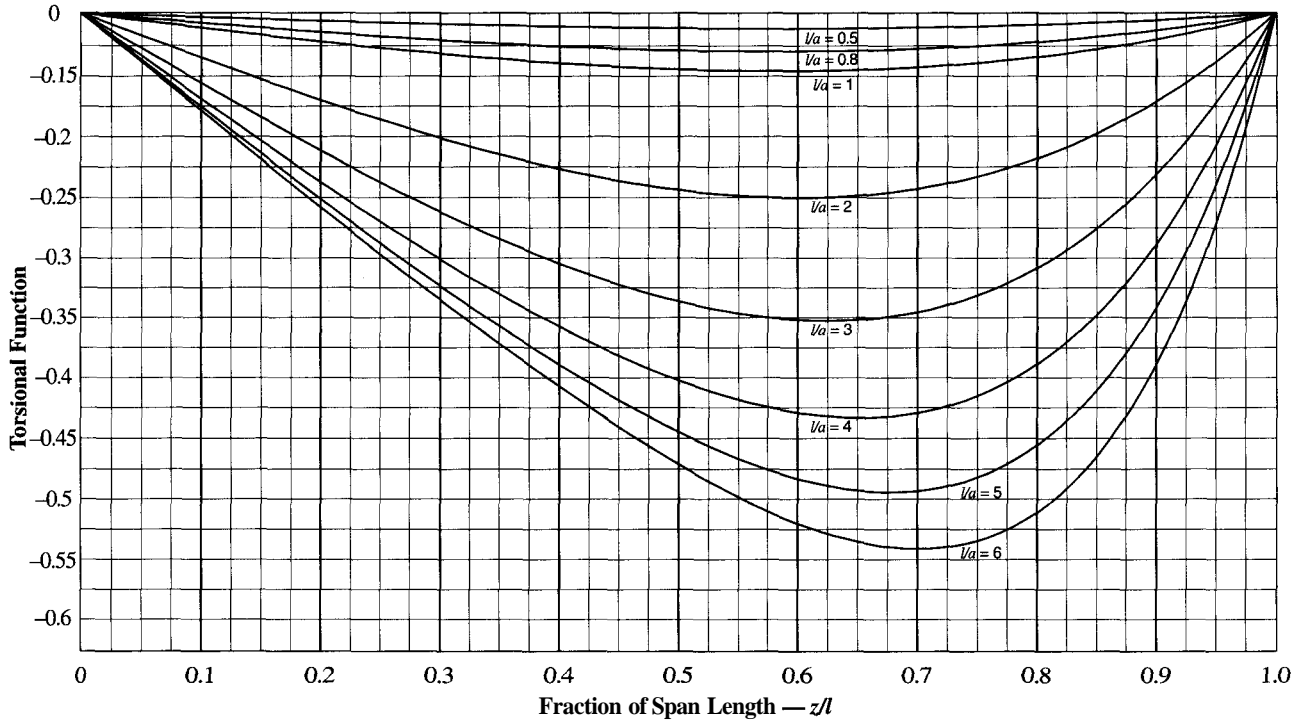

Case 5

$$\theta''' \times \left(\frac{GJ}{t} \times a \right)$$

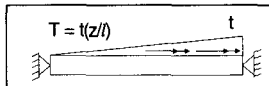

Torsional End Restraints	
Left End	Right End
Pinned $\theta = \theta'' = 0$	Pinned $\theta = \theta'' = 0$

Linearly varying torque on member with pinned ends

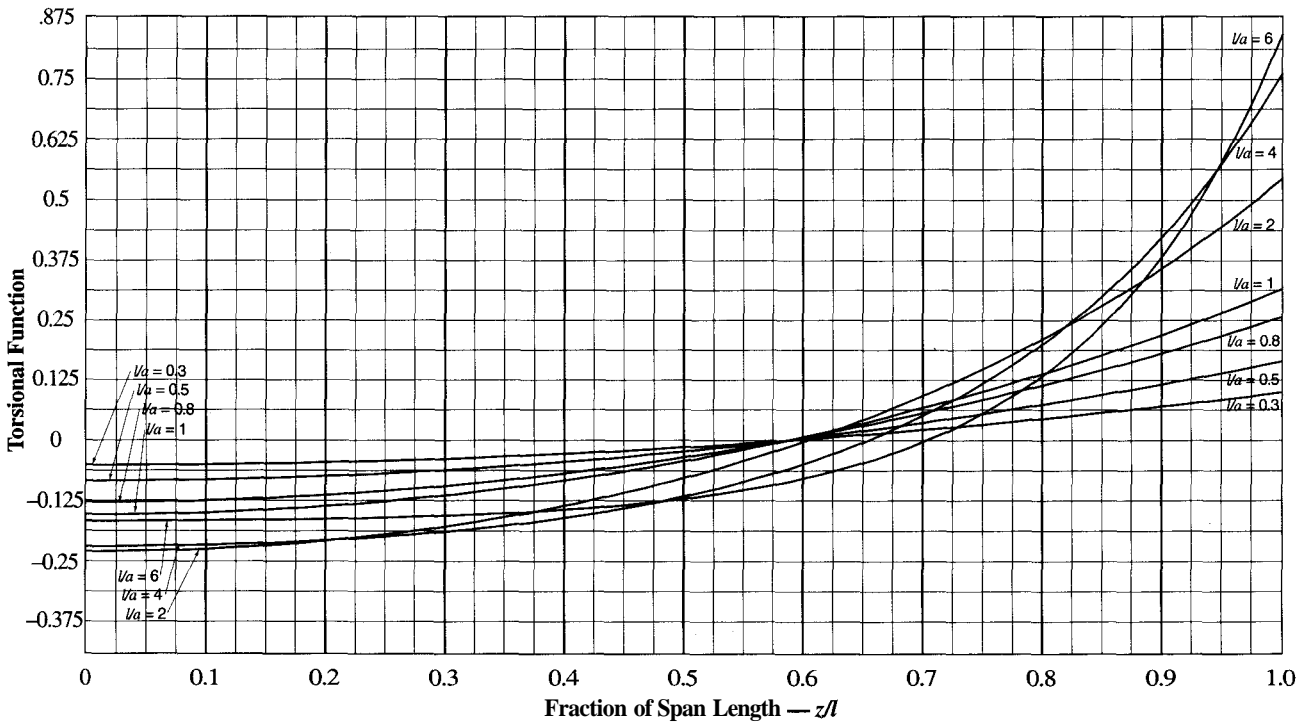

Case 6

$\alpha = 0.1$

$$\theta \times \left(\frac{GJ}{T} \times \frac{5}{a} \right)$$

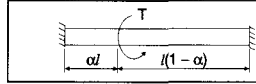

Torsional End Restraints	
Left End	Right End
Fixed $\theta = \theta' = 0$	Fixed $\theta = \theta' = 0$

Concentrated torque at $\alpha = 0.1$ on member with fixed ends

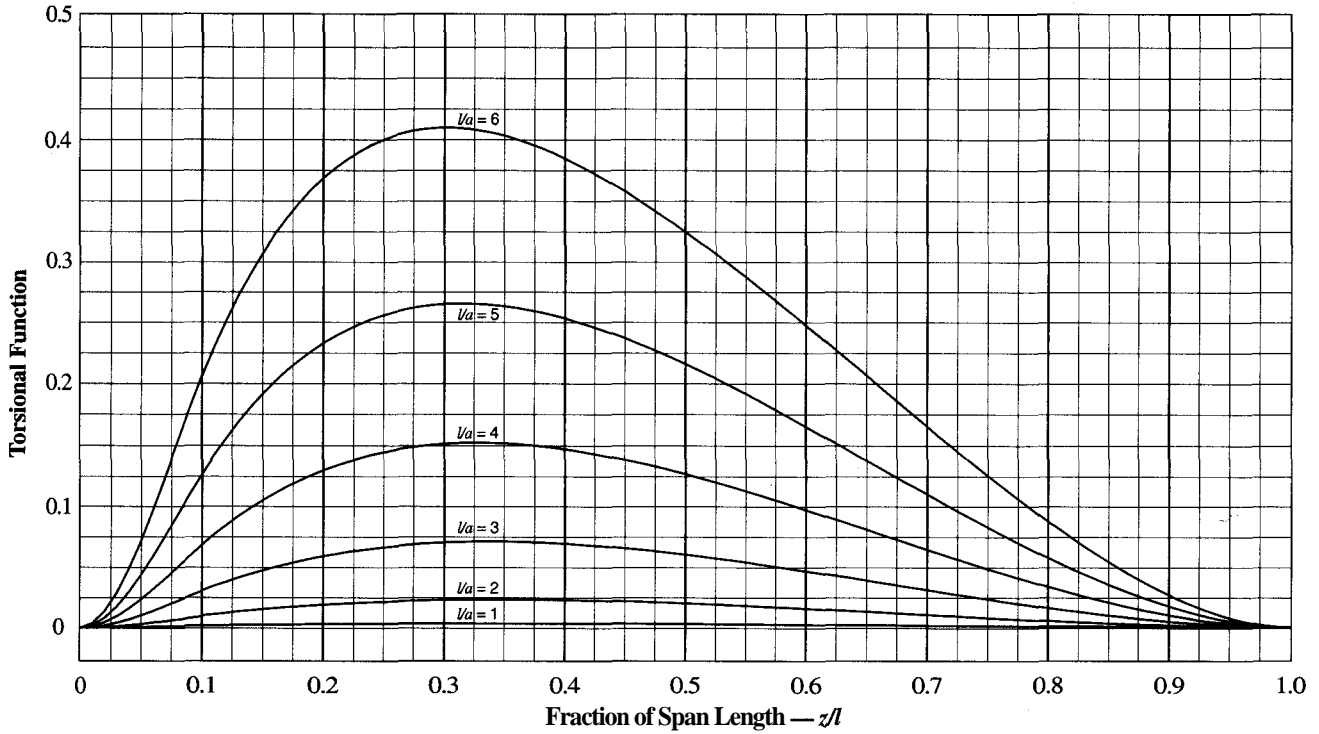

Case 6

$\alpha = 0.1$

$$\theta' \times \left(\frac{GJ}{T} \times 5 \right)$$

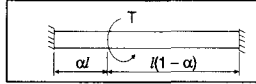

Torsional End Restraints	
Left End	Right End
Fixed $\theta = \theta' = 0$	Fixed $\theta = \theta' = 0$

Concentrated torque at $\alpha = 0.1$ on member with fixed ends

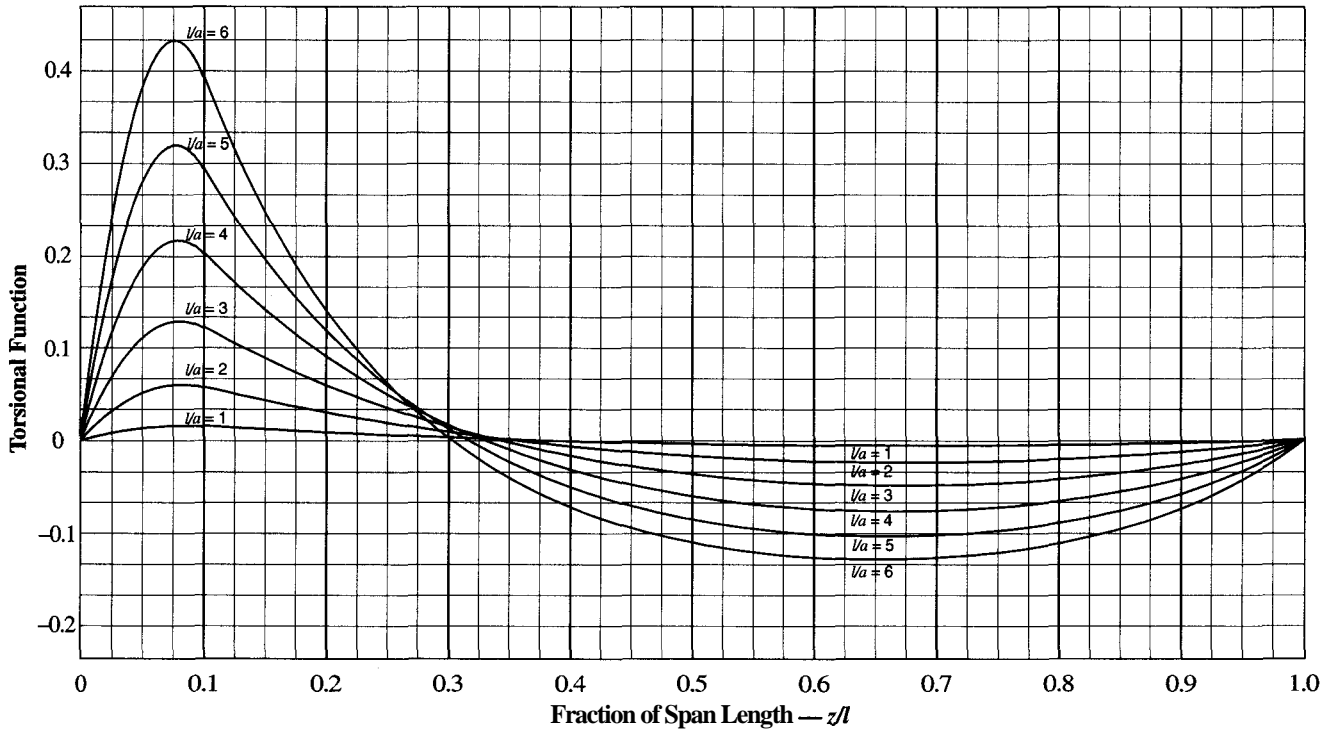

Case 6

$\alpha = 0.1$

$$\theta'' \times \left(\frac{GJ}{T} \times a \right)$$

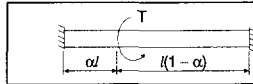

Torsional End Restraints	
Left End	Right End
Fixed $\theta = \theta' = 0$	Fixed $\theta = \theta' = 0$

Concentrated torque at $\alpha = 0.1$ on member with fixed ends

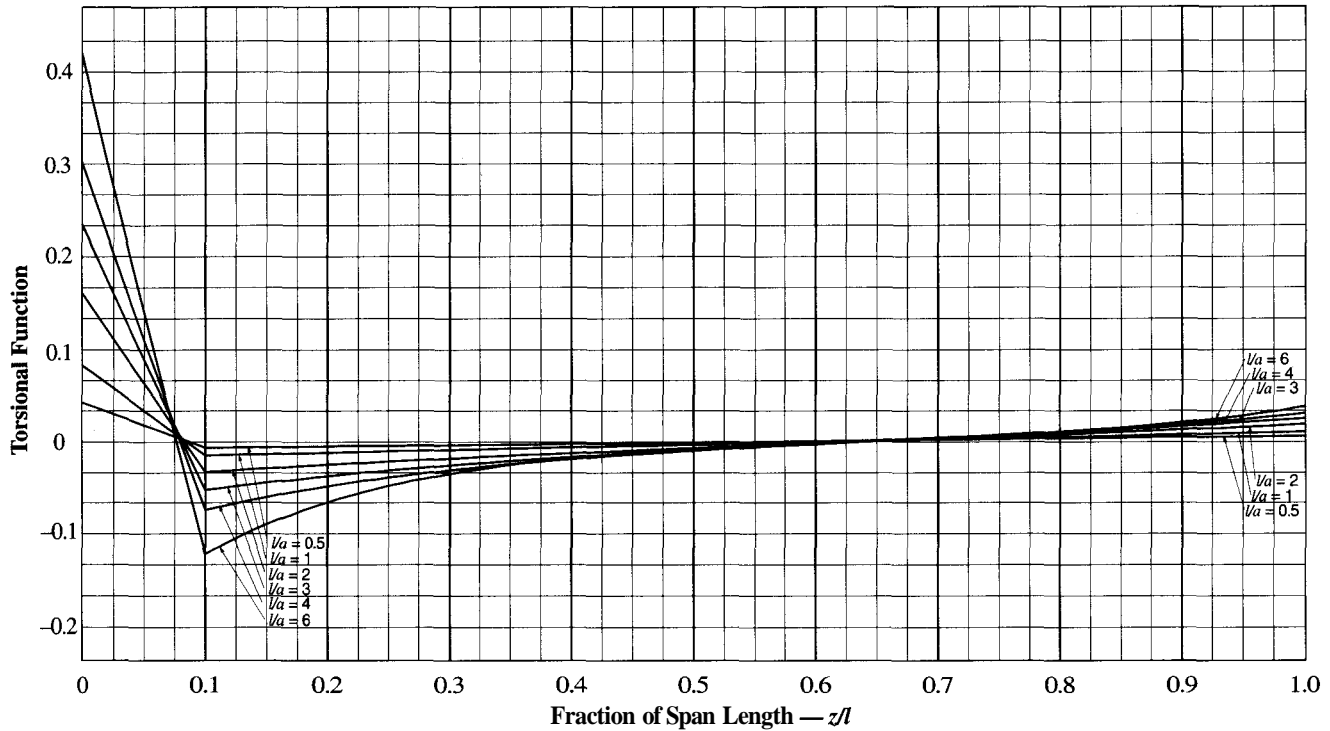

Case 6

$\alpha = 0.1$

$$\theta''' \times \left(\frac{GJ}{T} \times a^2 \right)$$

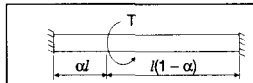

Torsional End Restraints	
Left End	Right End
Fixed $\theta = \theta' = 0$	Fixed $\theta = \theta' = 0$

Concentrated torque at $\alpha = 0.1$ on member with fixed ends

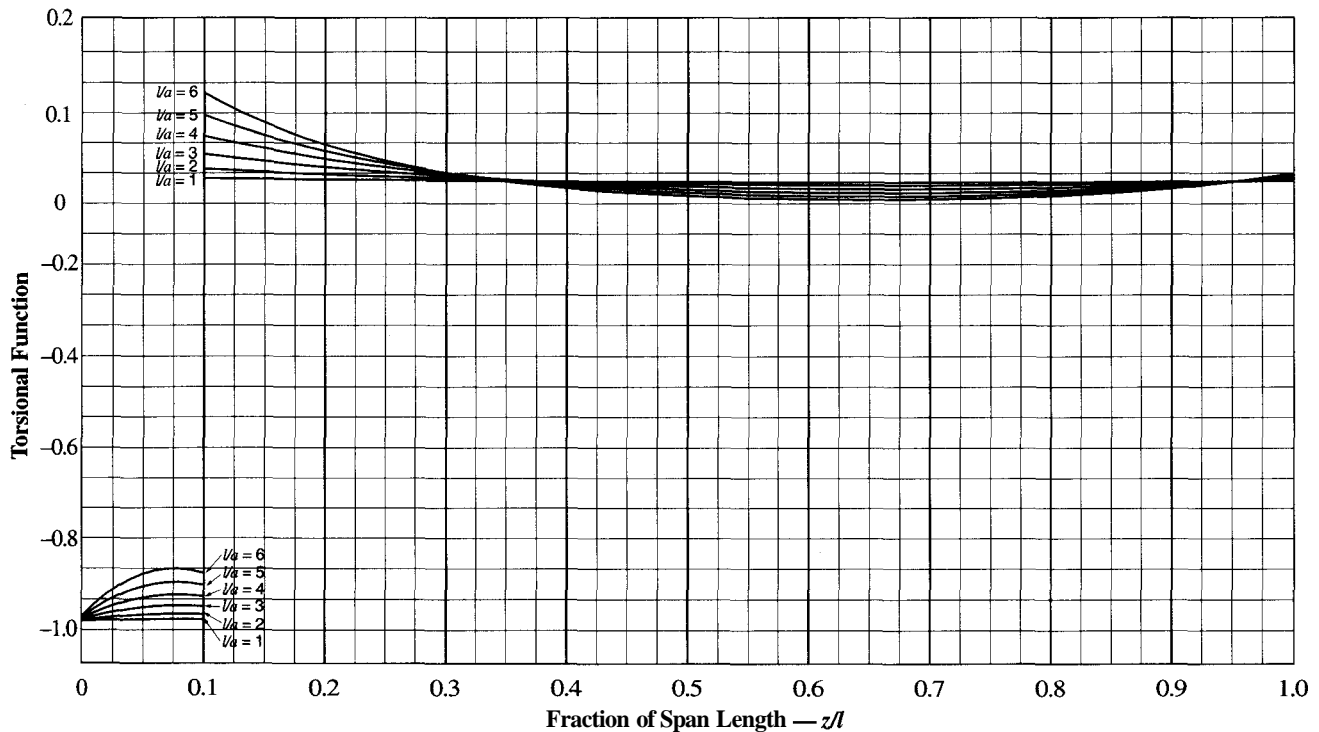

Case 6

$\alpha = 0.3$

$$\theta \times \left(\frac{GJ}{T} \times \frac{2}{a} \right)$$

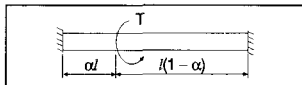

Torsional End Restraints		Concentrated torque at $\alpha = 0.3$ on member with fixed ends
Left End	Right End	
Fixed $\theta = \theta' = 0$	Fixed $\theta = \theta' = 0$	

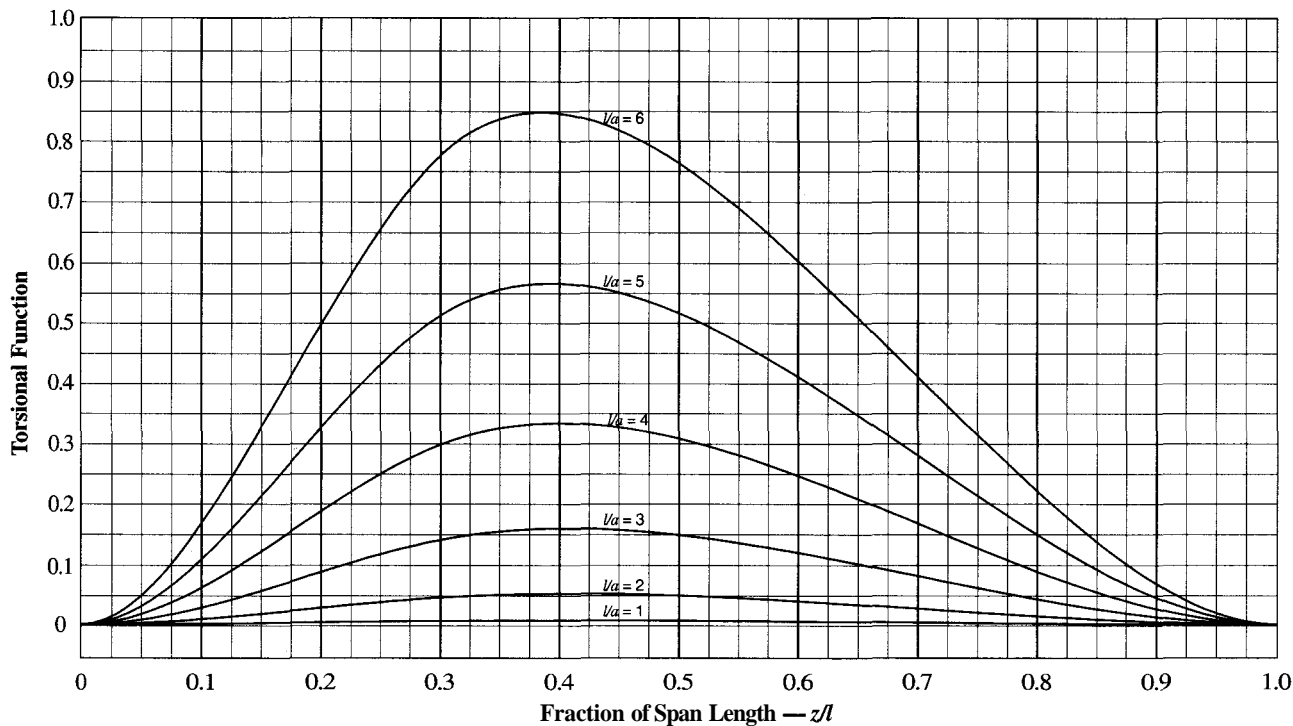

Case 6

$\alpha = 0.3$

$$\theta' \times \left(\frac{GJ}{T} \times 2 \right)$$

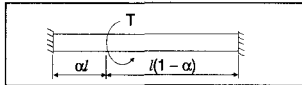

Torsional End Restraints		Concentrated torque at $\alpha = 0.3$ on member with fixed ends
Left End	Right End	
Fixed $\theta = \theta' = 0$	Fixed $\theta = \theta' = 0$	

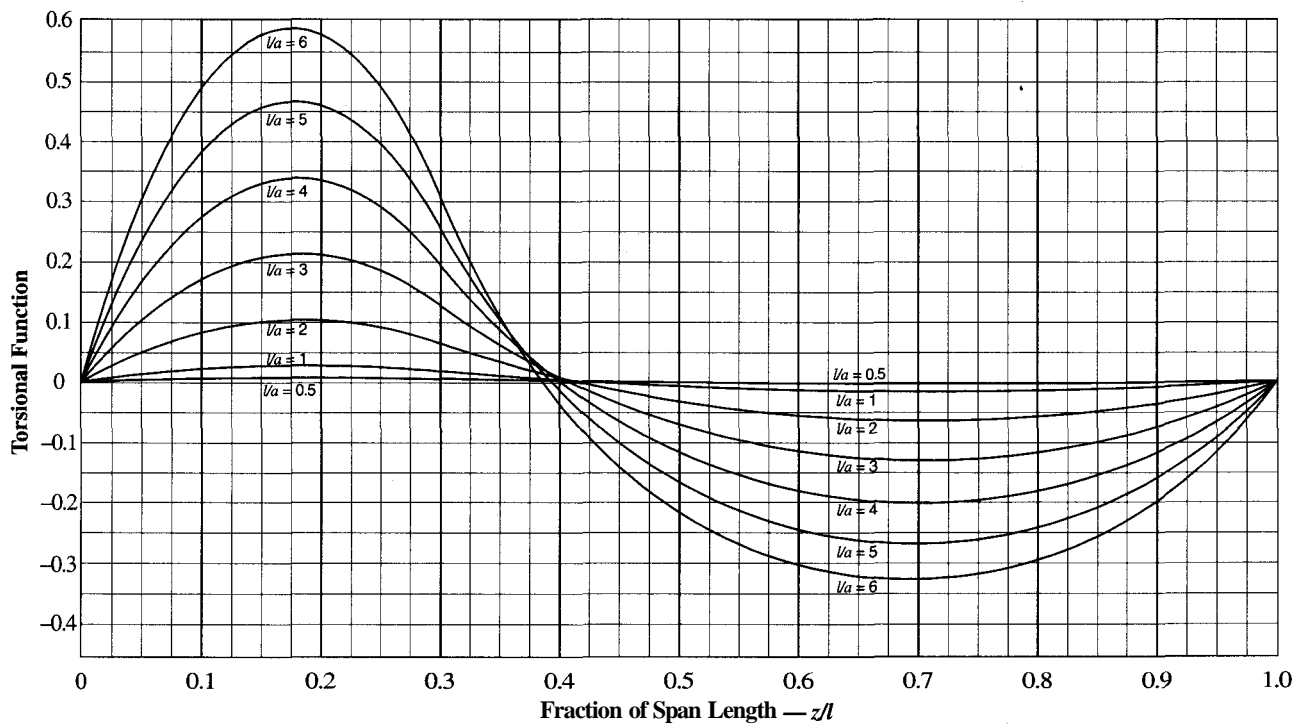

Case 6

$$\theta'' \times \left(\frac{GJ}{T} \times a \right)$$

$\alpha = 0.3$

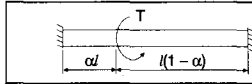

Torsional End Restraints	
Left End	Right End
Fixed $\theta = \theta' = 0$	Fixed $\theta = \theta' = 0$

Concentrated torque at $\alpha = 0.3$ on member with fixed ends

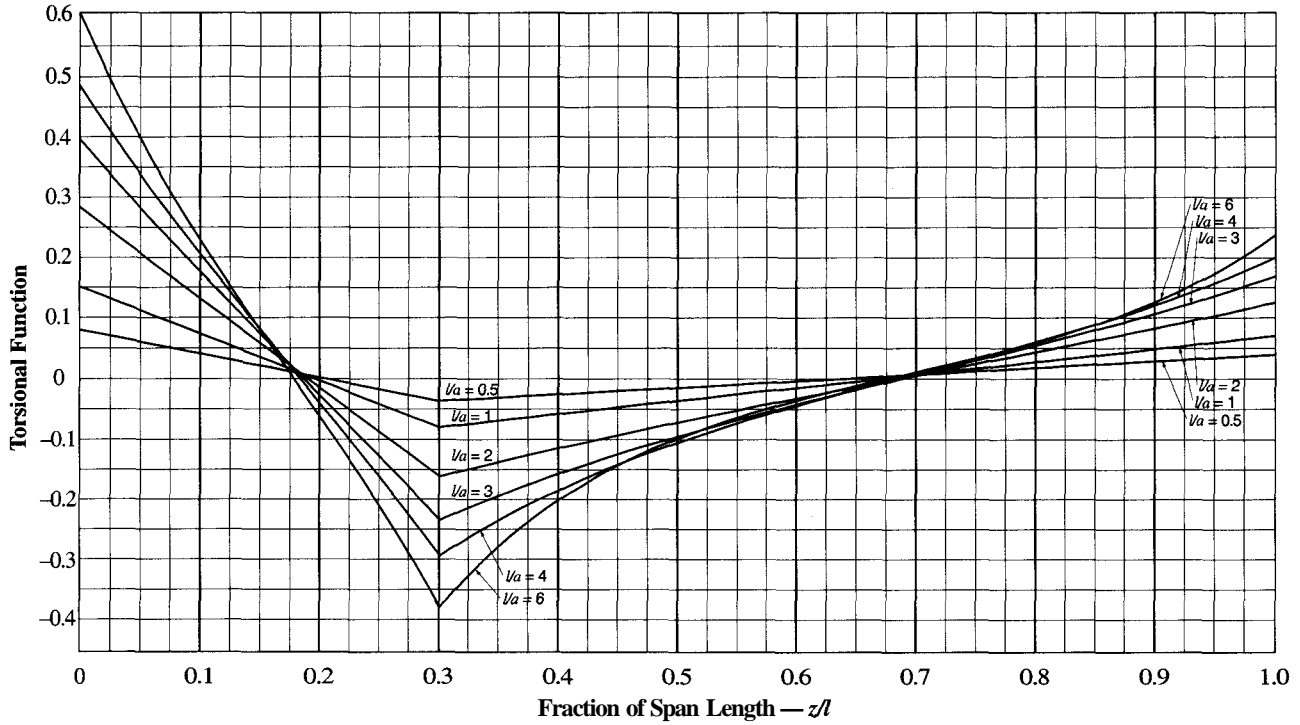

Case 6

$$\theta''' \times \left(\frac{GJ}{T} \times a^2 \right)$$

$\alpha = 0.3$

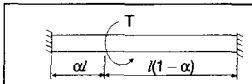

Torsional End Restraints	
Left End	Right End
Fixed $\theta = \theta' = 0$	Fixed $\theta = \theta' = 0$

Concentrated torque at $\alpha = 0.3$ on member with fixed ends

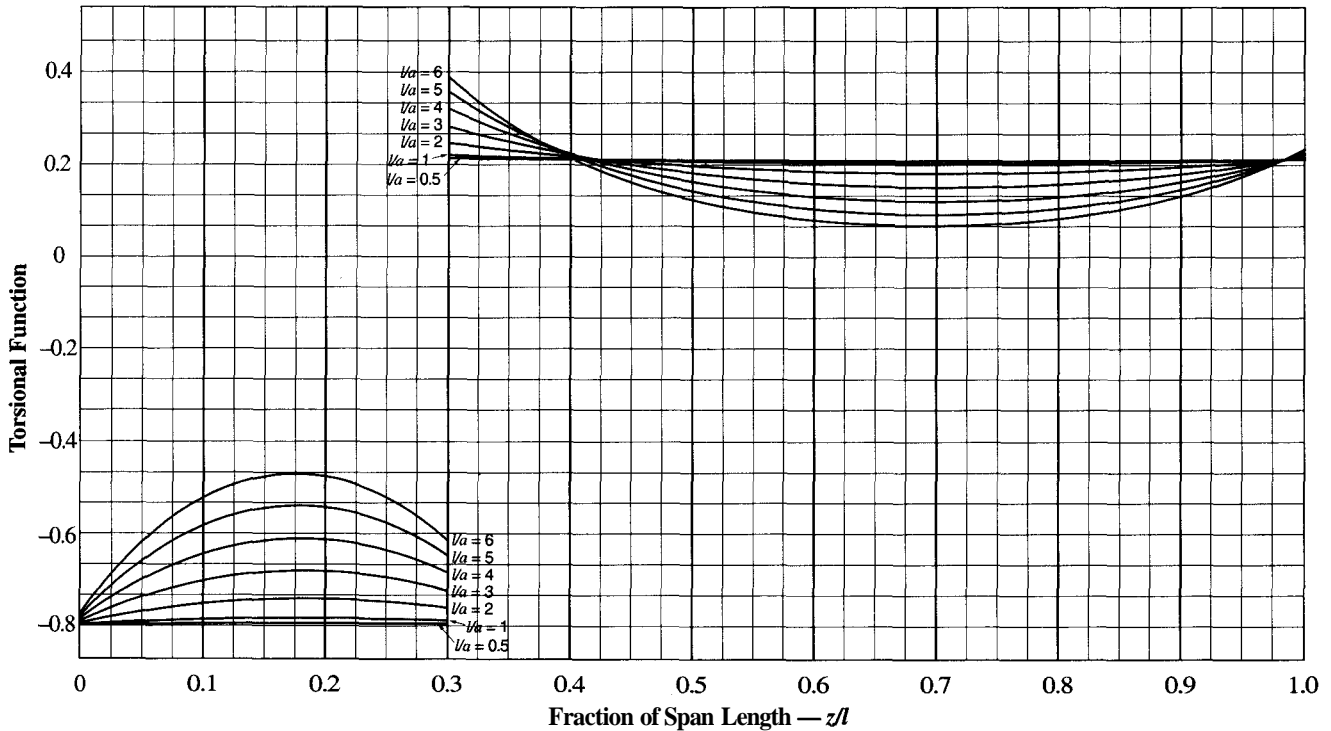

Case 6

$\alpha = 0.5$

$$\theta \times \left(\frac{GJ}{T} \times \frac{1}{a} \right)$$

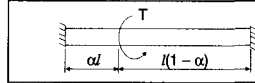

Torsional End Restraints	
Left End	Right End
Fixed $\theta = \theta' = 0$	Fixed $\theta = \theta' = 0$

Concentrated torque at $\alpha = 0.5$ on member with fixed ends

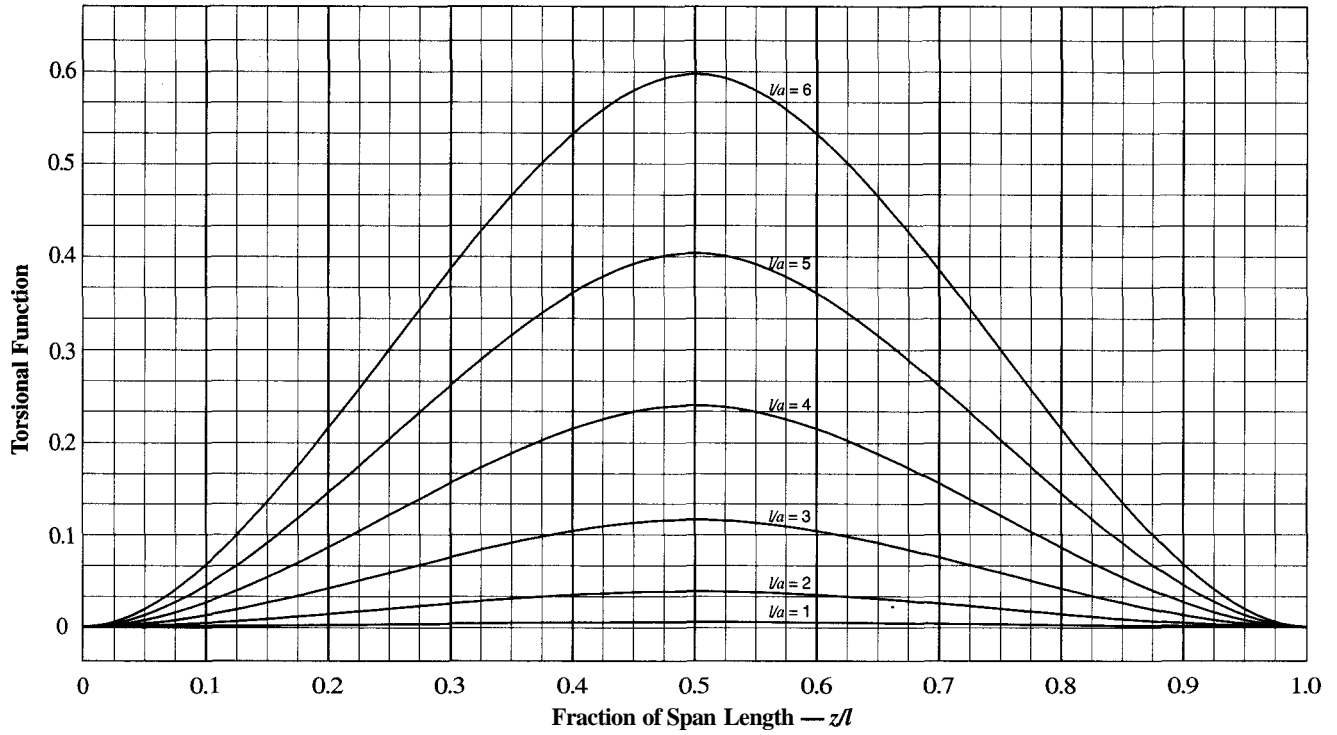

Case 6

$\alpha = 0.5$

$$\theta' \times \left(\frac{GJ}{T} \right)$$

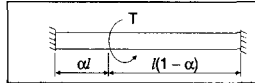

Torsional End Restraints	
Left End	Right End
Fixed $\theta = \theta' = 0$	Fixed $\theta = \theta' = 0$

Concentrated torque at $\alpha = 0.5$ on member with fixed ends

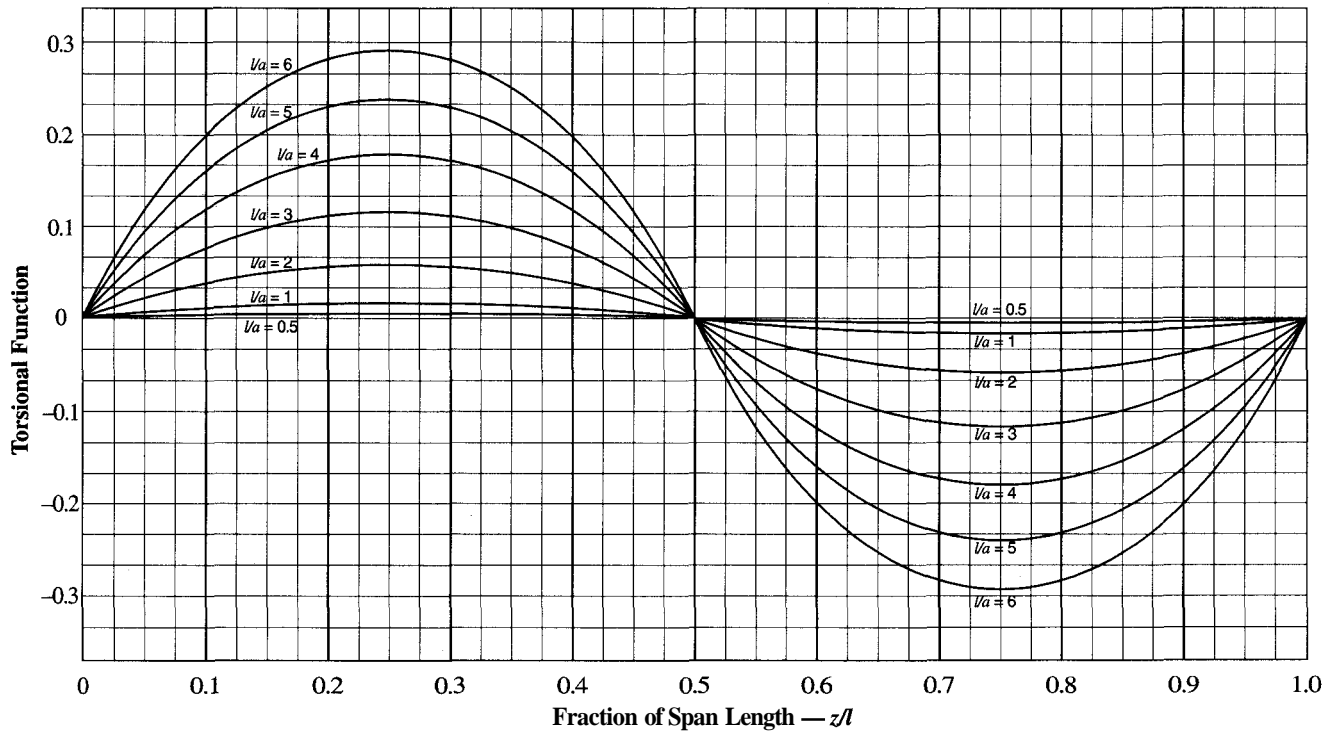

Case 6 $\theta'' \times \left(\frac{GJ}{T} \times a\right)$
 $\alpha = 0.5$

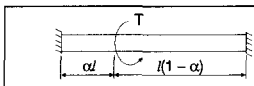

Torsional End Restraints		Concentrated torque at $\alpha = 0.5$ on member with fixed ends
Left End	Right End	
Fixed $\theta = \theta' = 0$	Fixed $\theta = \theta' = 0$	

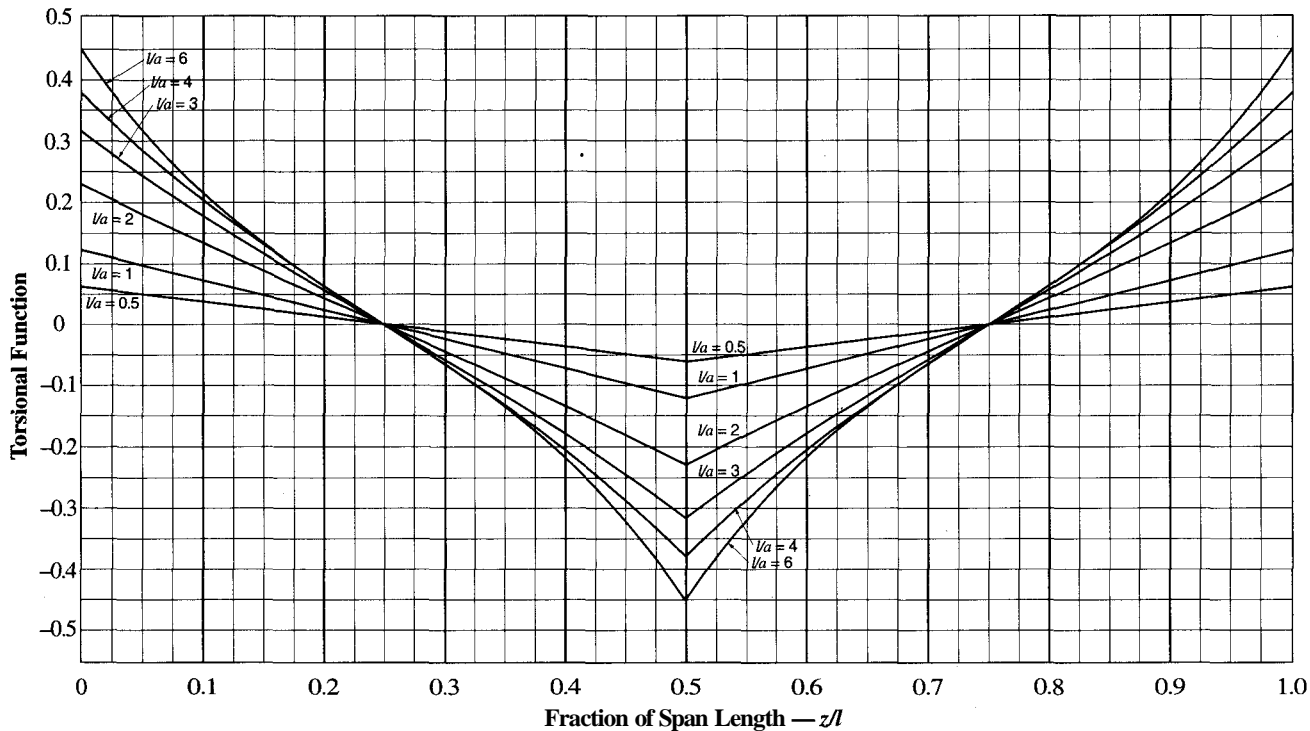

Case 6 $\theta''' \times \left(\frac{GJ}{T} \times a^2\right)$
 $\alpha = 0.5$

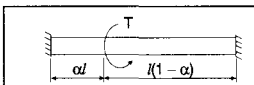

Torsional End Restraints		Concentrated torque at $\alpha = 0.5$ on member with fixed ends
Left End	Right End	
Fixed $\theta = \theta' = 0$	Fixed $\theta = \theta' = 0$	

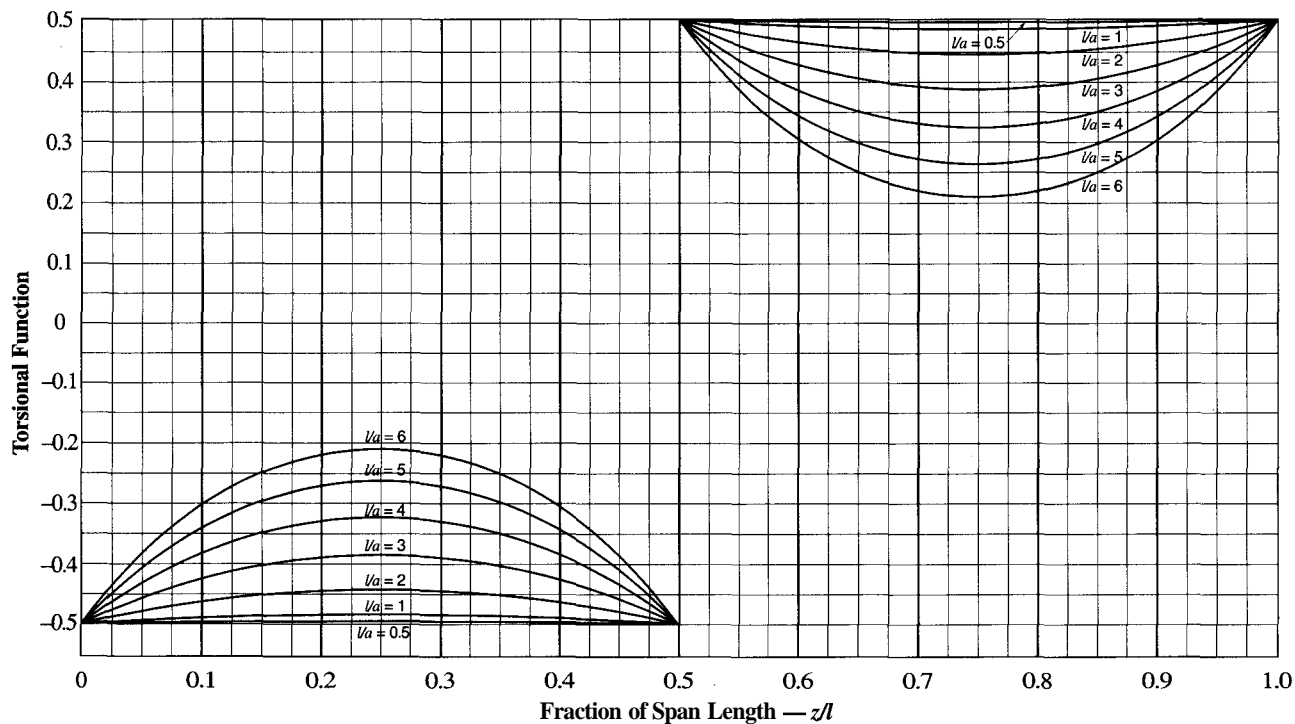

Case 7

$$\theta \times \left(\frac{GJ}{t} \times \frac{2}{al} \right)$$

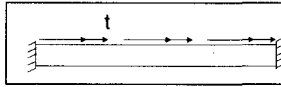

Torsional End Restraints	
Left End	Right End
Fixed $\theta = \theta' = 0$	Fixed $\theta = \theta' = 0$

Uniformly distributed torque on member with fixed ends

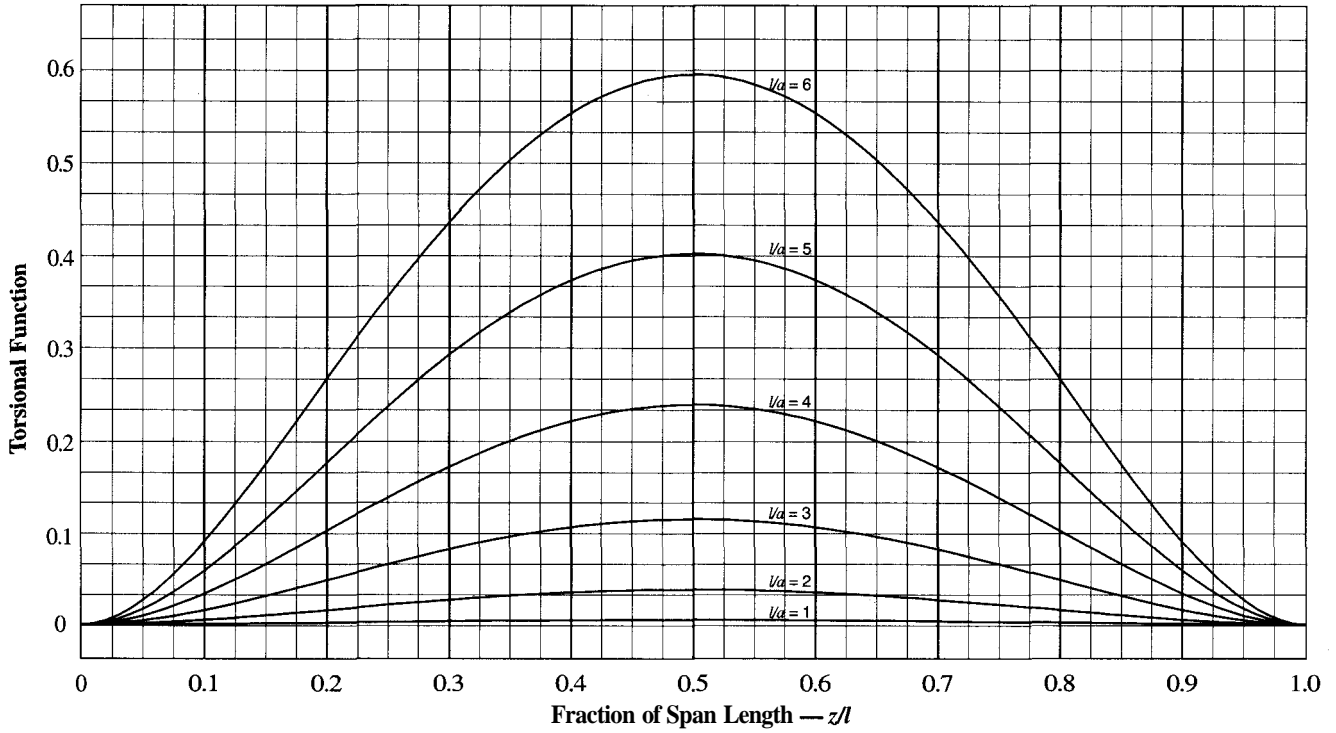

Case 7

$$\theta' \times \left(\frac{GJ}{t} \times \frac{2}{l} \right)$$

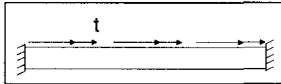

Torsional End Restraints	
Left End	Right End
Fixed $\theta = \theta' = 0$	Fixed $\theta = \theta' = 0$

Uniformly distributed torque on member with fixed ends

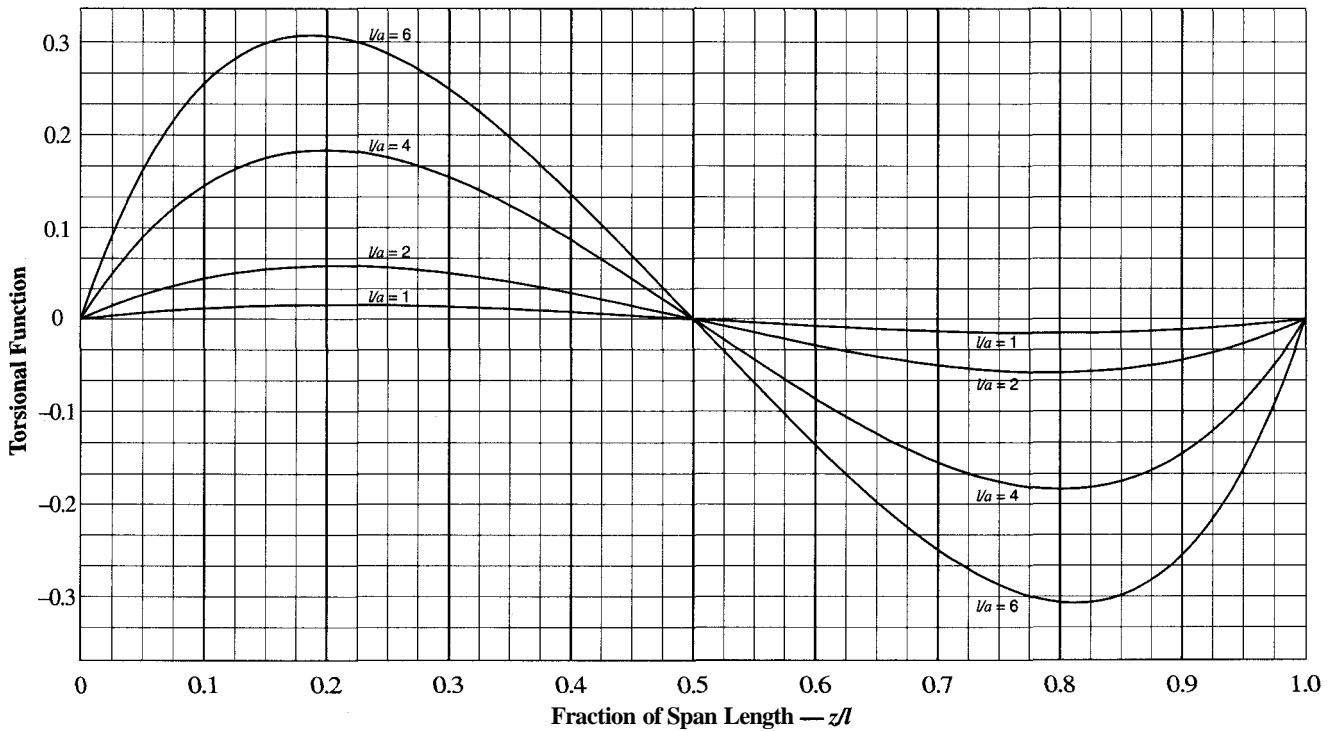

Case 7

$$\theta'' \times \left(\frac{GJ}{t} \times \frac{2a}{l} \right)$$

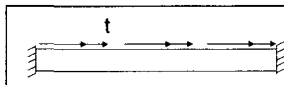

Torsional End Restraints	
Left End	Right End
Fixed $\theta = \theta' = 0$	Fixed $\theta = \theta' = 0$

Uniformly distributed torque on member with fixed ends

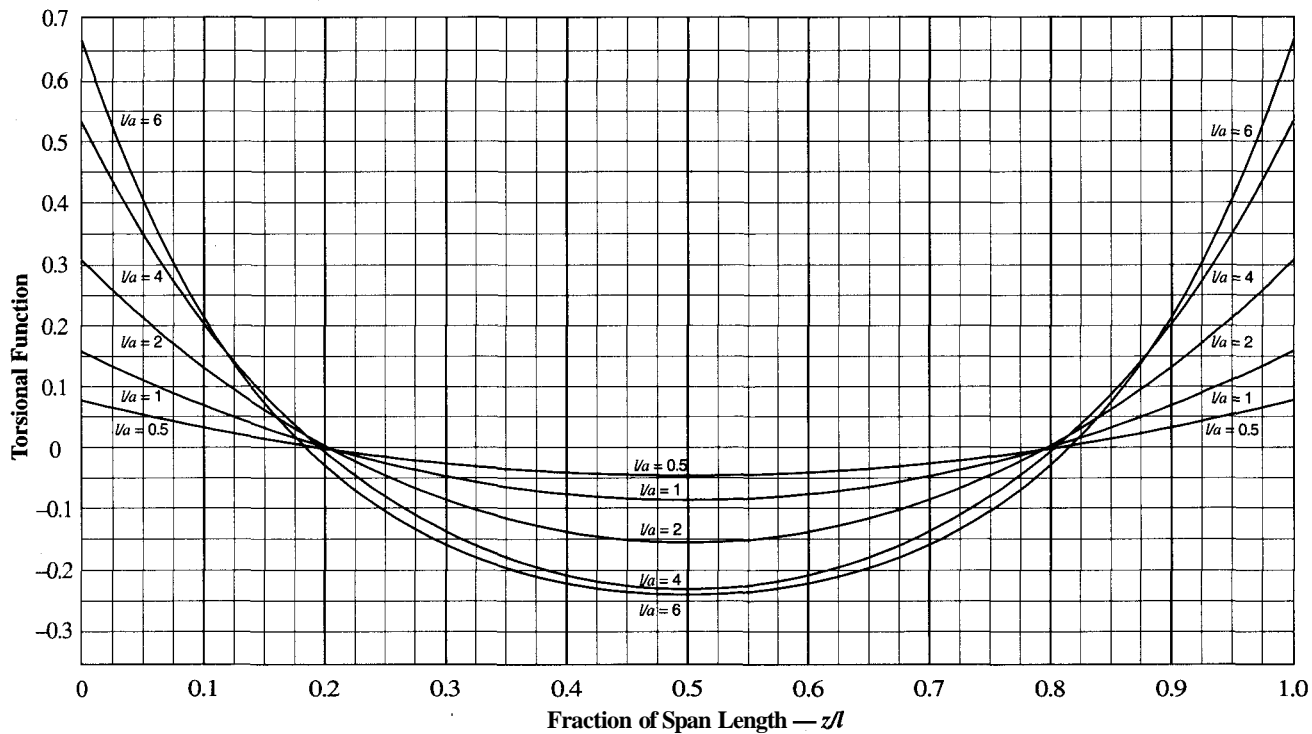

Case 7

$$\theta''' \times \left(\frac{GJ}{t} \times \frac{2a^2}{l} \right)$$

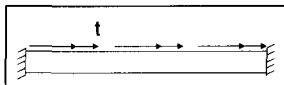

Torsional End Restraints	
Left End	Right End
Fixed $\theta = \theta' = 0$	Fixed $\theta = \theta' = 0$

Uniformly distributed torque on member with fixed ends

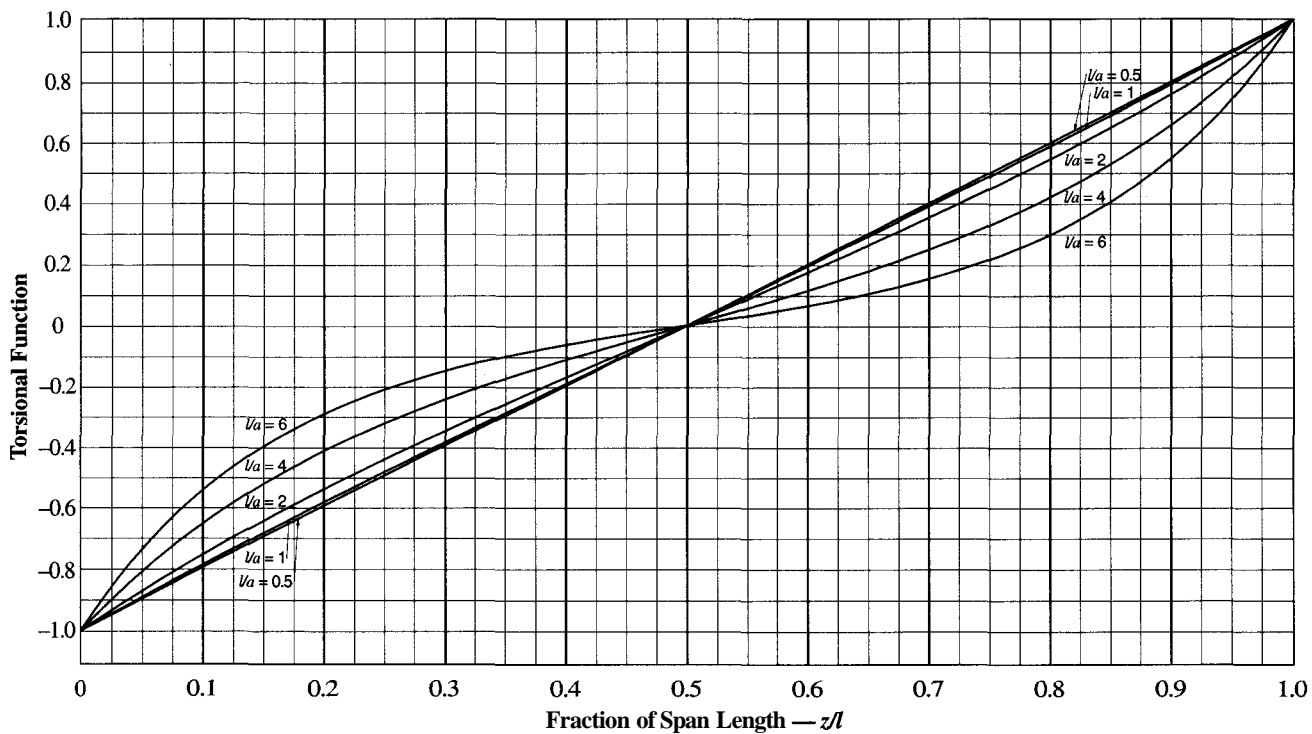

Case8

$$\theta \times \left(\frac{GJ}{t} \times \frac{8}{l^2} \right)$$

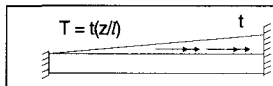

Torsional End Restraints	
Left End	Right End
Fixed $\theta = \theta' = 0$	Fixed $\theta = \theta' = 0$

Linearly varying torque on member with fixed ends

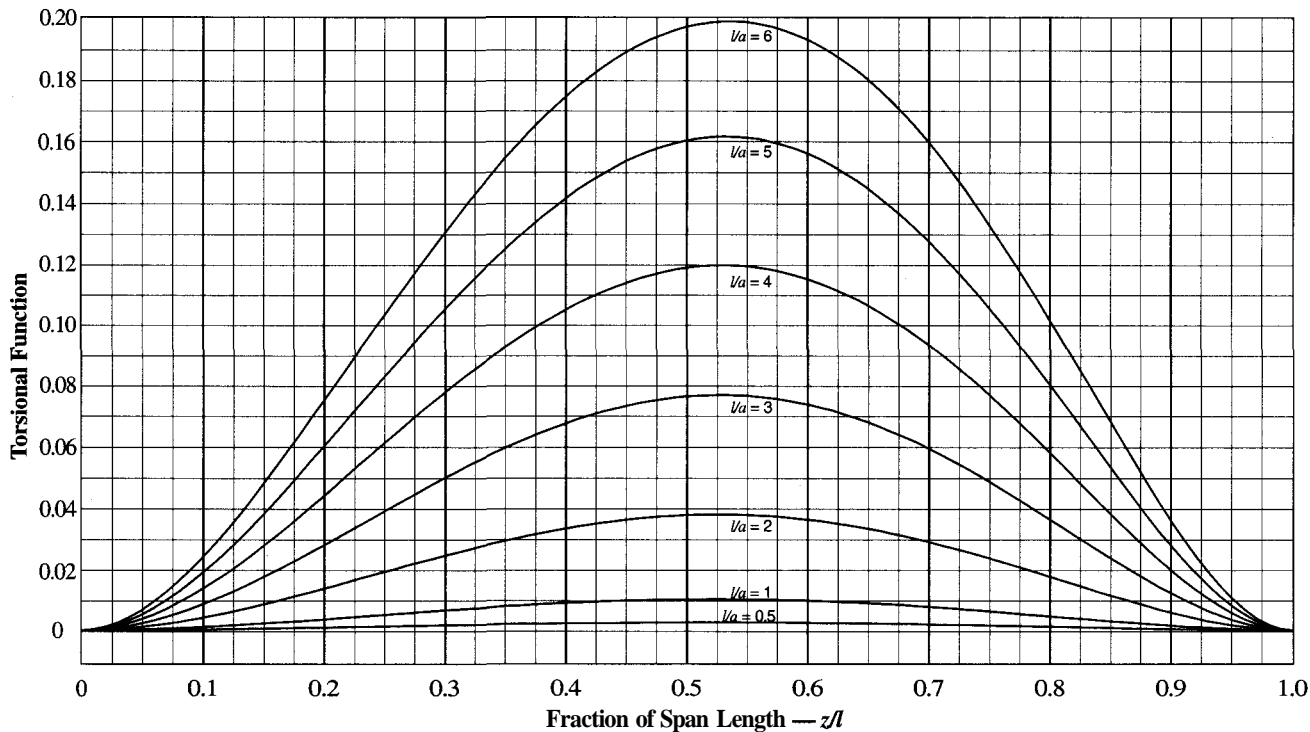

Case8

$$\theta' \times \left(\frac{GJ}{t} \times \frac{4}{l} \right)$$

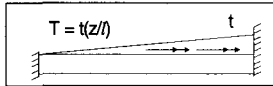

Torsional End Restraints	
Left End	Right End
Fixed $\theta = \theta' = 0$	Fixed $\theta = \theta' = 0$

Linearly varying torque on member with fixed ends

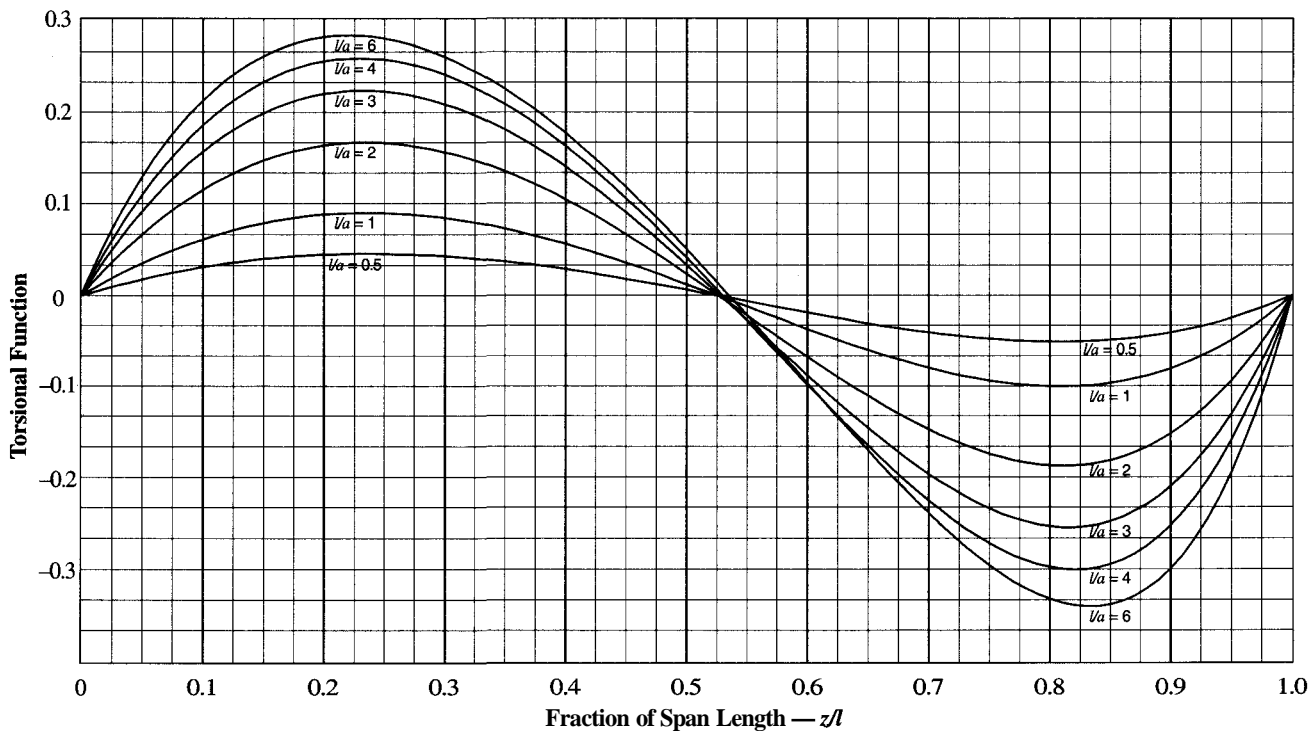

Case 8

$$\theta'' \times \left(\frac{GJ}{t} \times \frac{a}{l} \right)$$

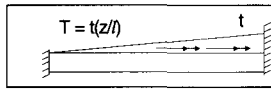

Torsional End Restraints			
Left End		Right End	
Fixed	$\theta = \theta' = 0$	Fixed	$\theta = \theta' = 0$

Linearly varying torque on member with fixed ends

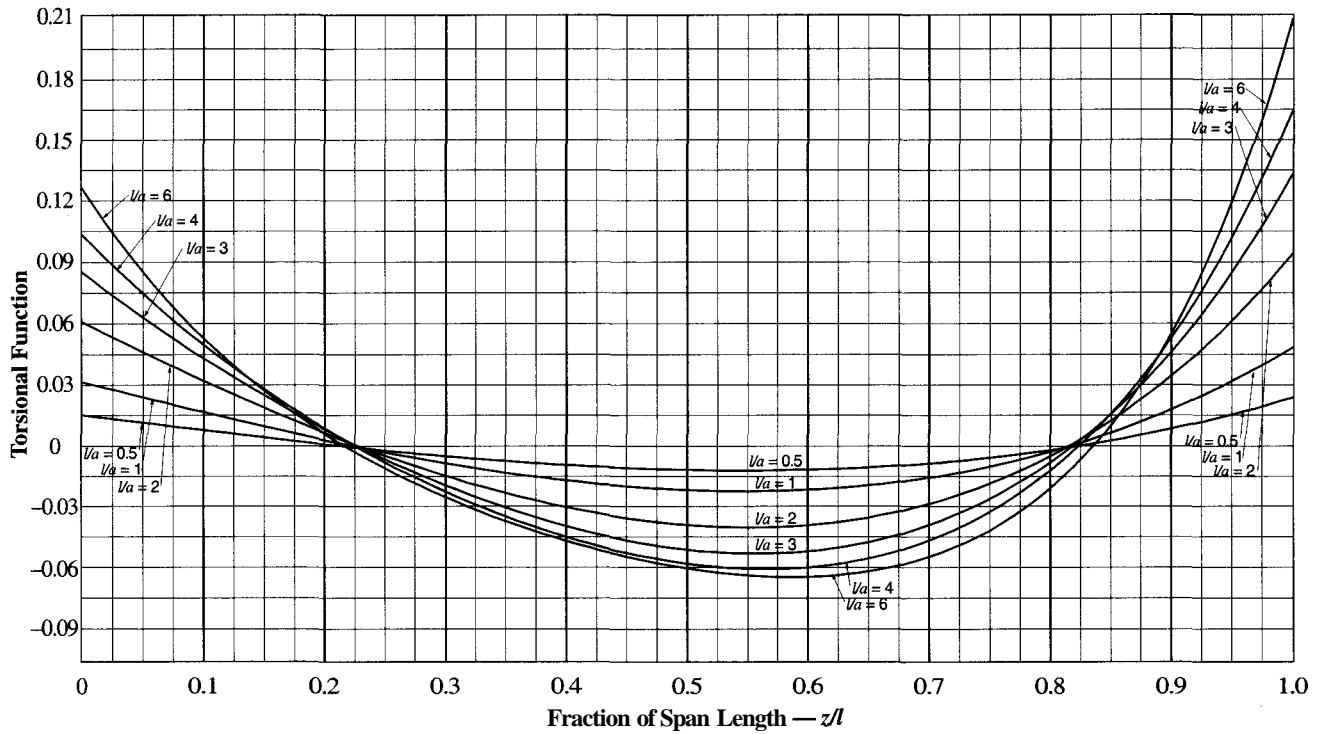

Case 8

$$\theta''' \times \left(\frac{GJ}{t} \times \frac{a^2}{l} \right)$$

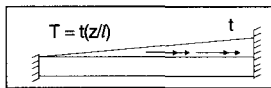

Torsional End Restraints			
Left End		Right End	
Fixed	$\theta = \theta' = 0$	Fixed	$\theta = \theta' = 0$

Linearly varying torque on member with fixed ends

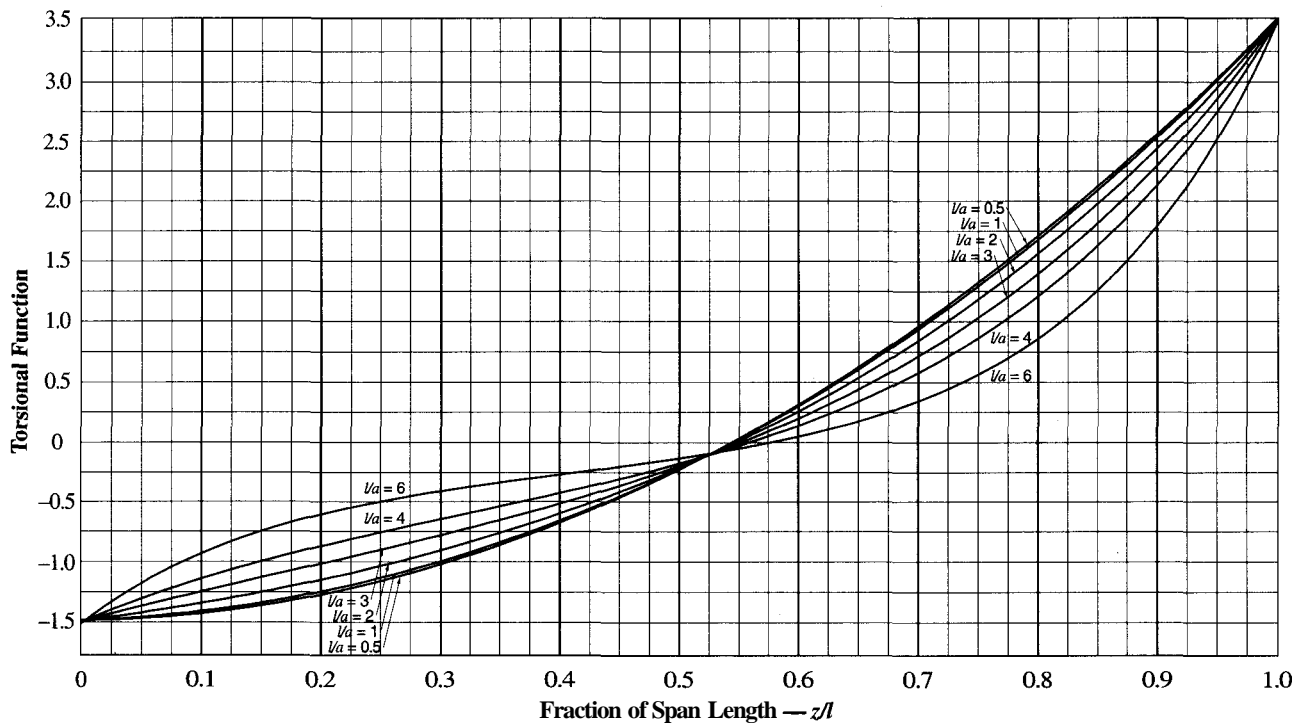

Case 9

$\alpha = 0.1$

$$\theta \times \left(\frac{GJ}{T} \times \frac{2}{a} \right)$$

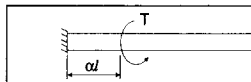

Torsional End Restraints		Concentrated torque at $\alpha = 0.1$ on member with fixed and free ends
Left End	Right End	
Fixed $\theta = \theta' = 0$	Free $\theta'' = 0$	

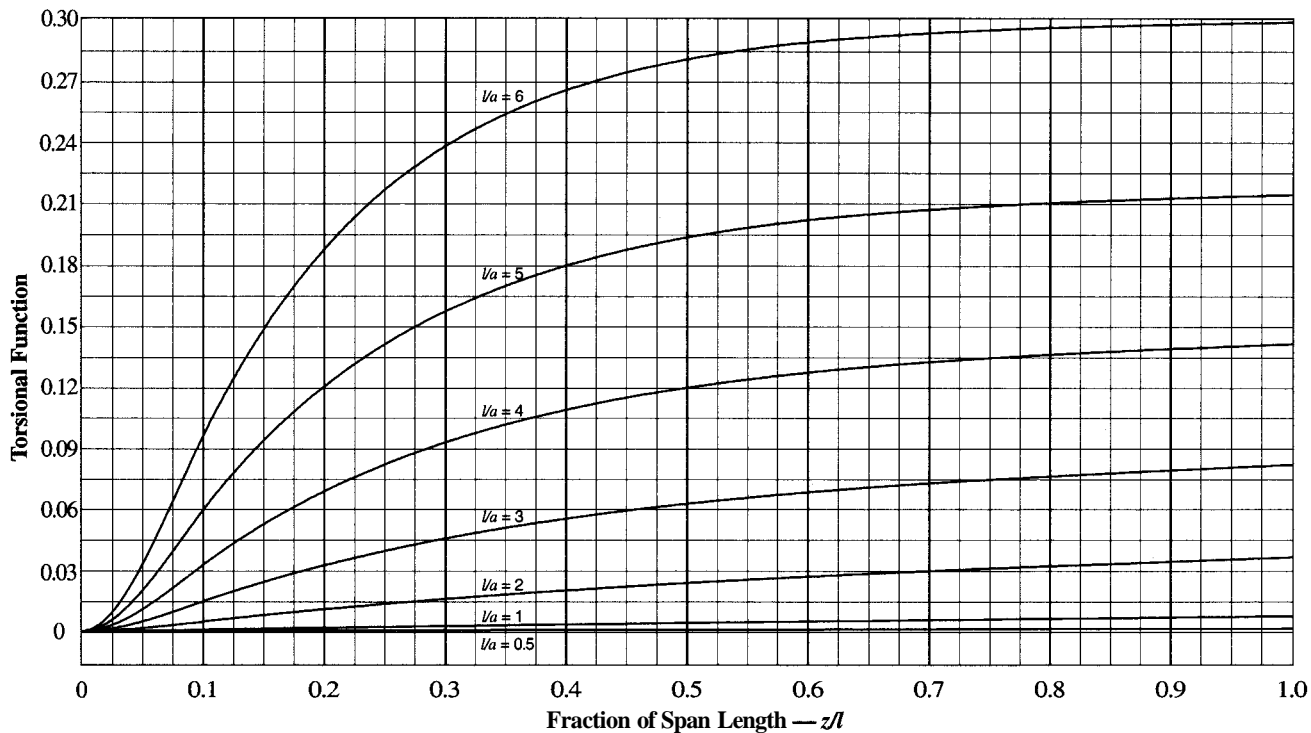

Case 9

$\alpha = 0.1$

$$\theta' \times \left(\frac{GJ}{T} \times 2 \right)$$

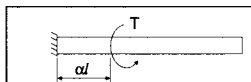

Torsional End Restraints		Concentrated torque at $\alpha = 0.1$ on member with fixed and free ends
Left End	Right End	
Fixed $\theta = \theta' = 0$	Free $\theta'' = 0$	

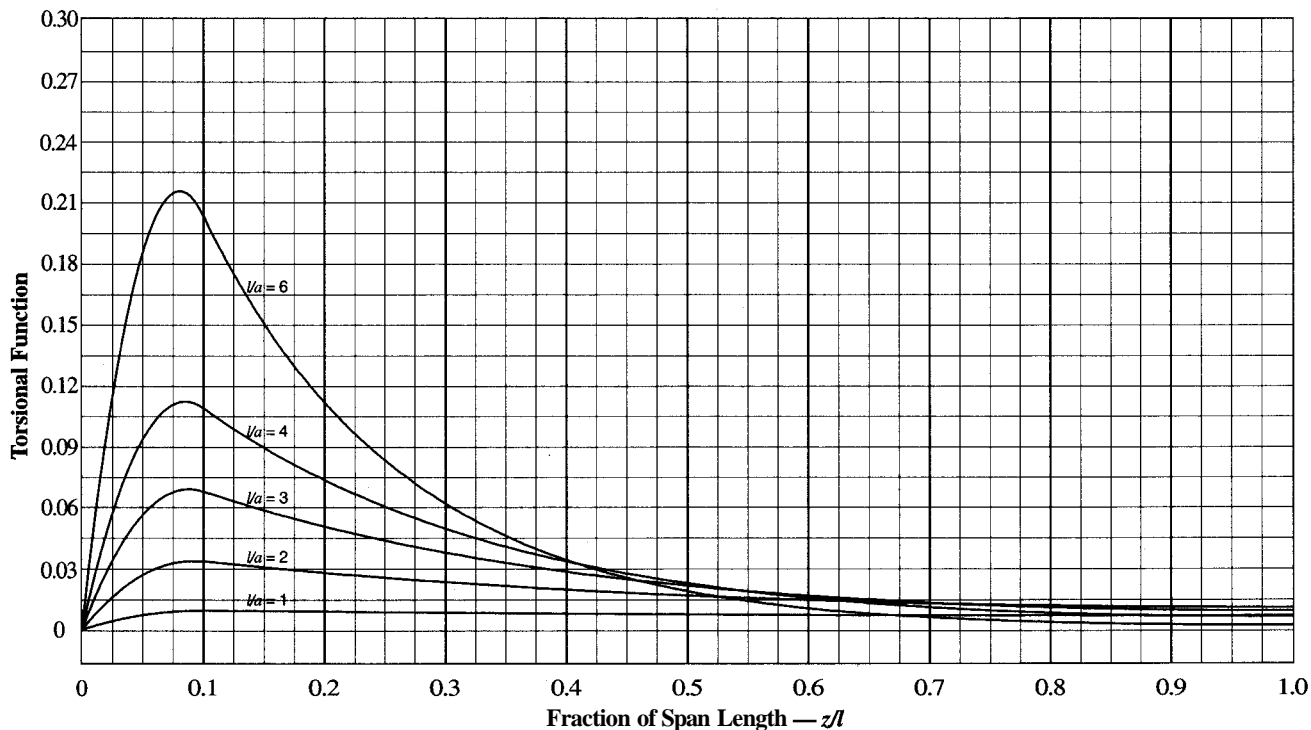

Case 9

$\alpha = 0.1$

$$\theta'' \times \left(\frac{GJ}{T} \times a \right)$$

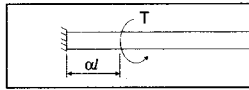

Torsional End Restraints	
Left End	Right End
Fixed $\theta = \theta' = 0$	Free $\theta'' = 0$

Concentrated torque at $\alpha = 0.1$ on member with fixed and free ends

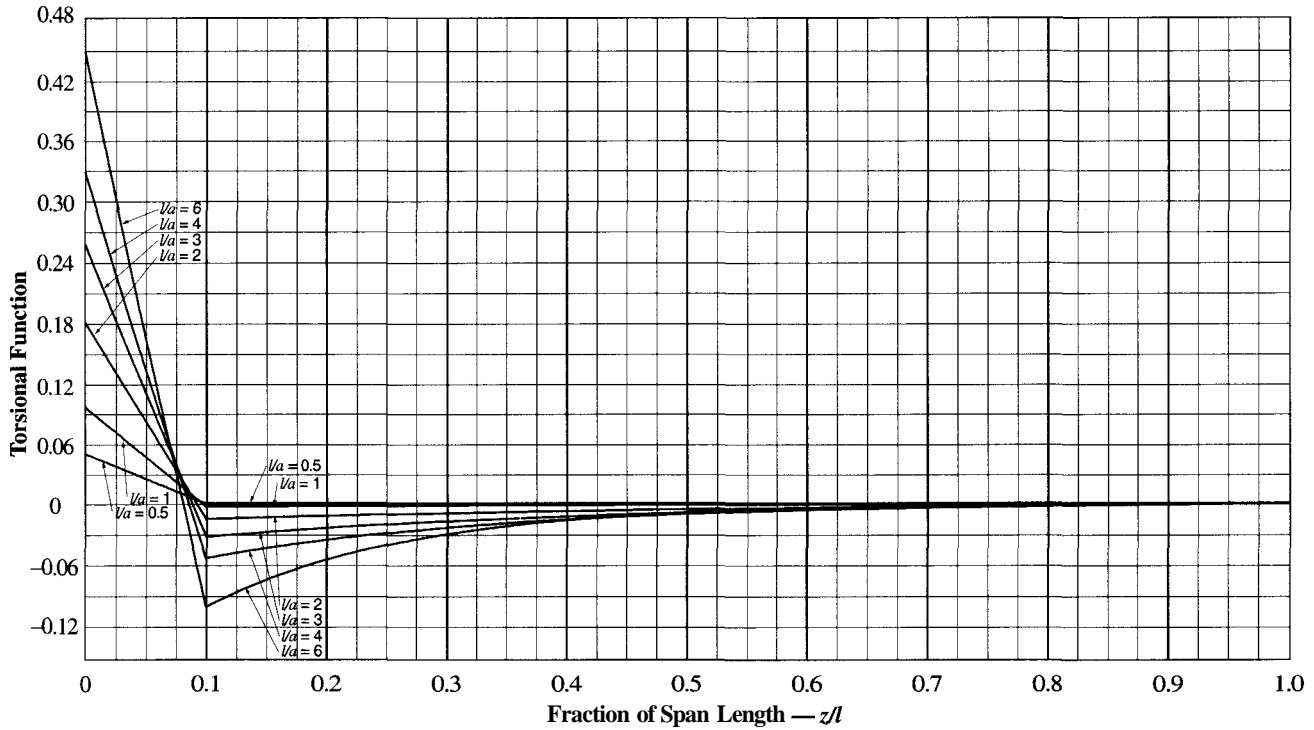

Case 9

$\alpha = 0.1$

$$\theta''' \times \left(\frac{GJ}{T} \times a^2 \right)$$

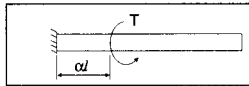

Torsional End Restraints	
Left End	Right End
Fixed $\theta = \theta' = 0$	Free $\theta'' = 0$

Concentrated torque at $\alpha = 0.1$ on member with fixed and free ends

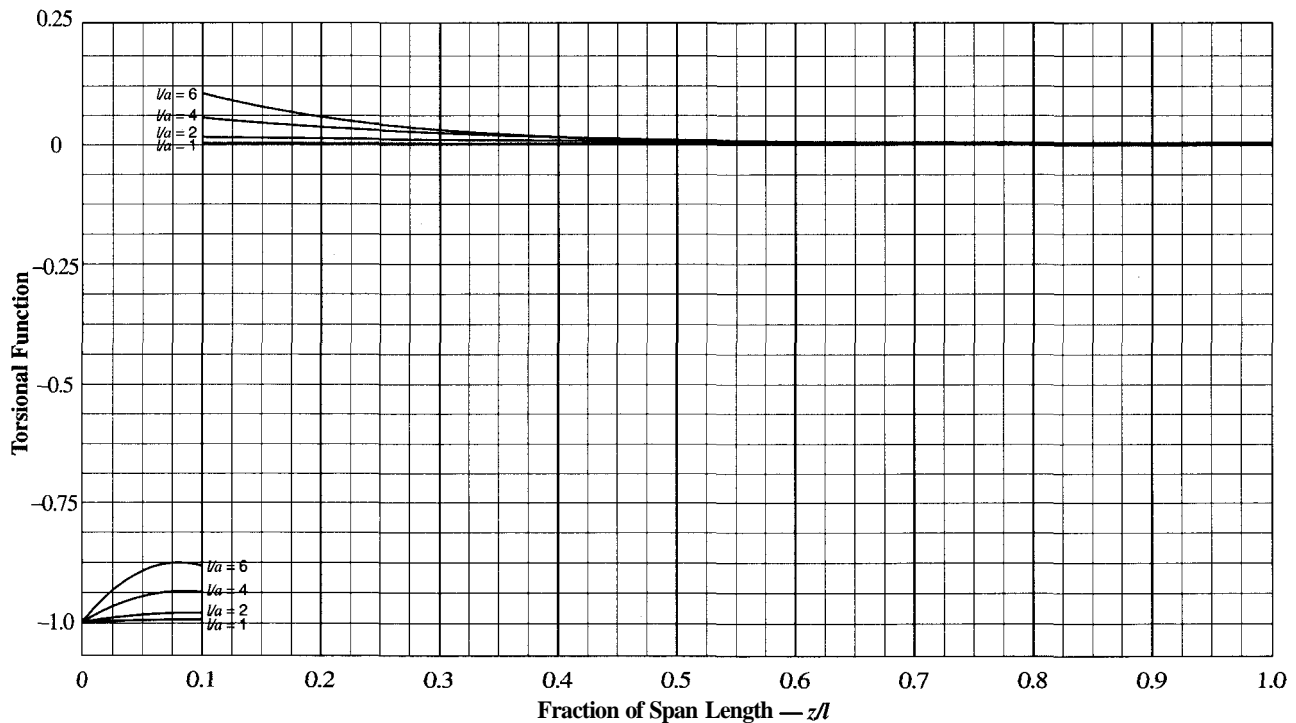

Case 9

$\alpha = 0.3$

$$\theta \times \left(\frac{GJ}{T} \times \frac{1}{a} \right)$$

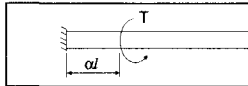

Torsional End Restraints	
Left End	Right End
Fixed $\theta = \theta' = 0$	Free $\theta'' = 0$

Concentrated torque at $\alpha = 0.3$ on member with fixed and free ends

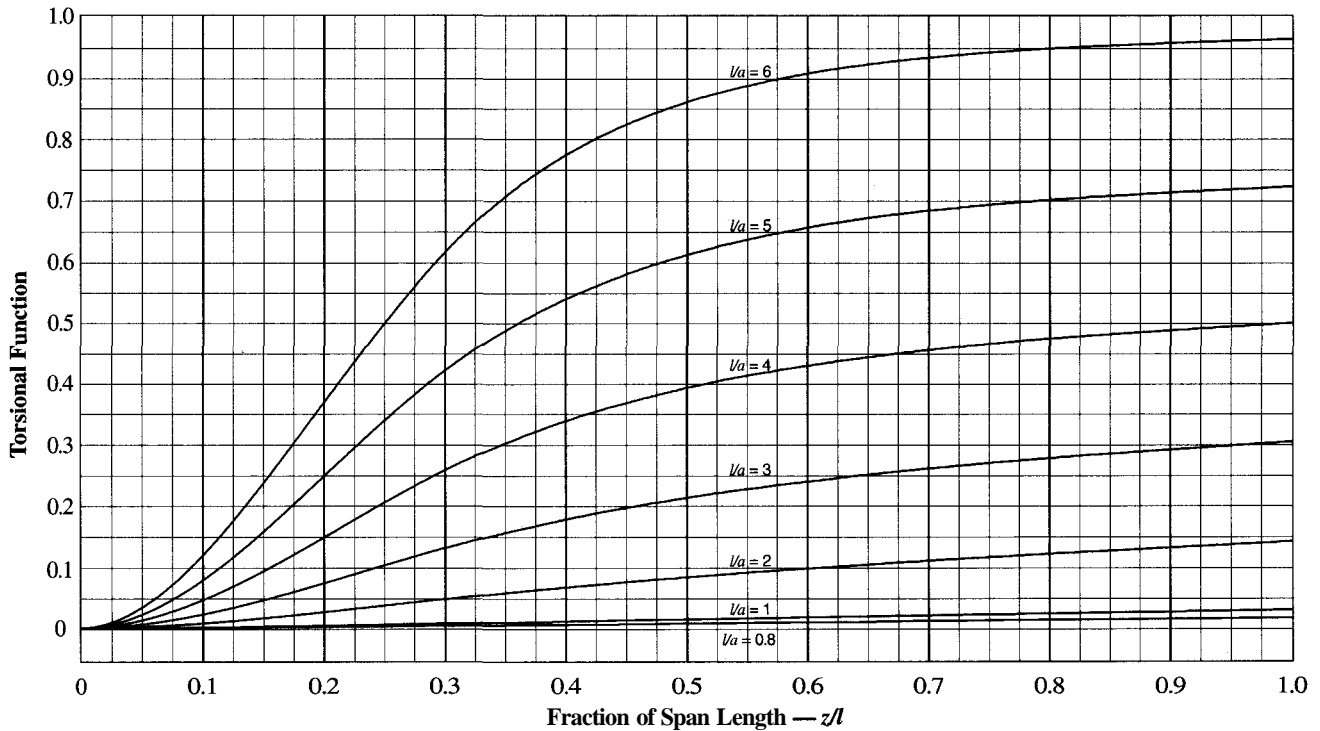

Case 9

$\alpha = 0.3$

$$\theta' \times \left(\frac{GJ}{T} \right)$$

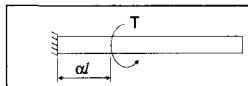

Torsional End Restraints	
Left End	Right End
Fixed $\theta = \theta' = 0$	Free $\theta'' = 0$

Concentrated torque at $\alpha = 0.3$ on member with fixed and free ends

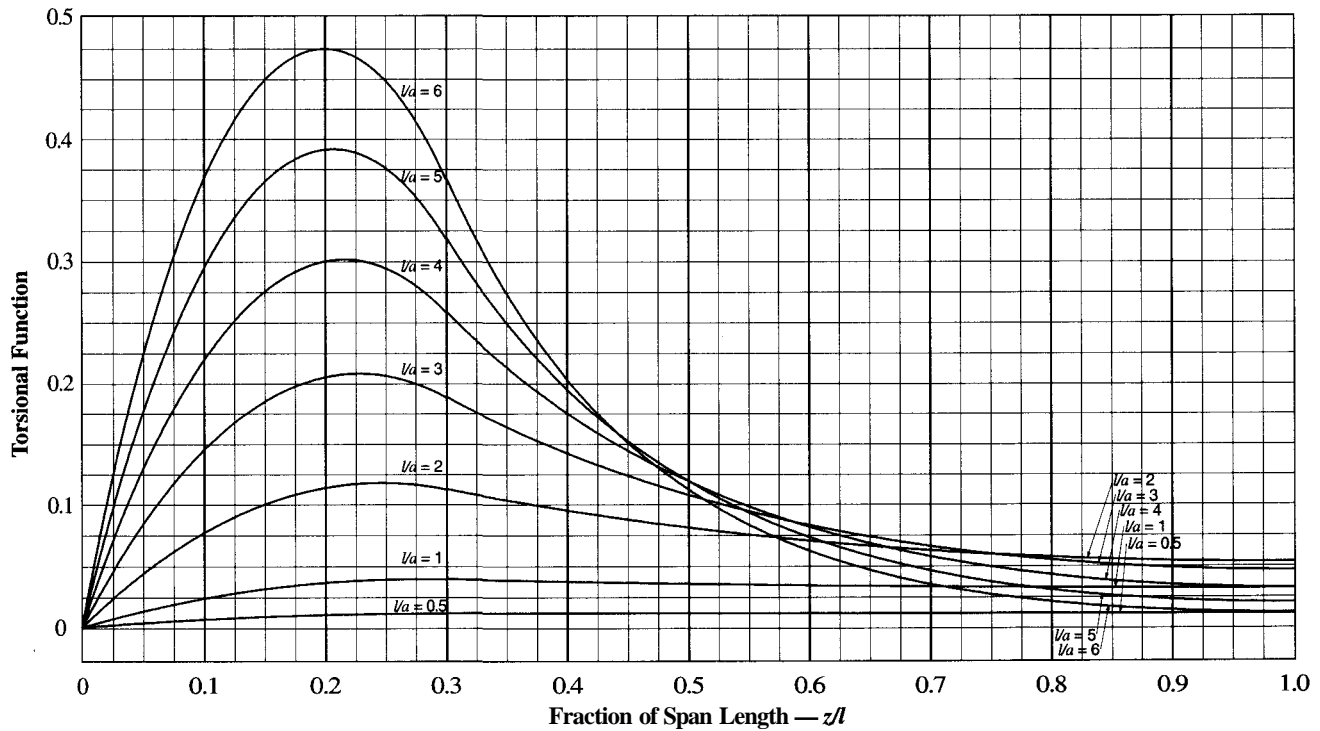

Case 9

$\alpha = 0.3$

$$\theta'' \times \left(\frac{GJ}{T} \times a \right)$$

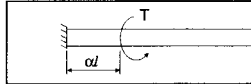

Torsional End Restraints			
Left End		Right End	
Fixed	$\theta = \theta' = 0$	Free	$\theta'' = 0$

Concentrated torque at $\alpha = 0.3$ on member with fixed and free ends

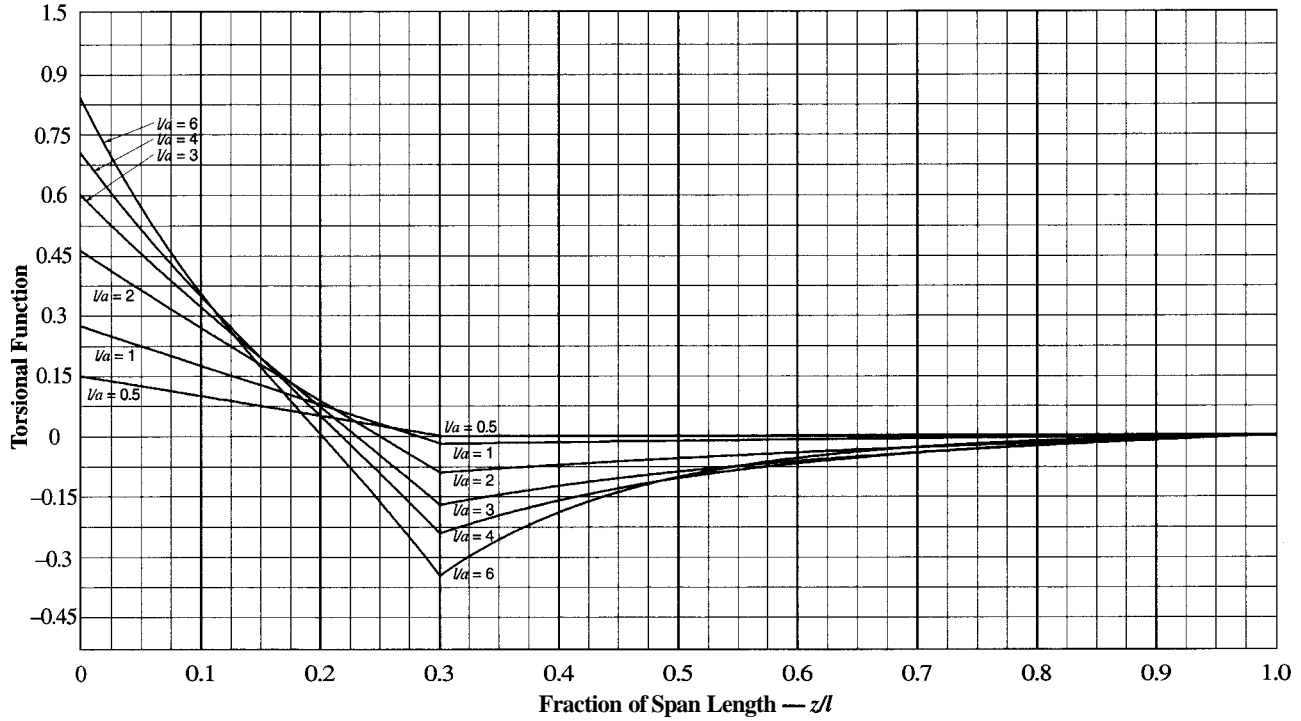

Case 9

$\alpha = 0.3$

$$\theta''' \times \left(\frac{GJ}{T} \times a^2 \right)$$

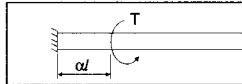

Torsional End Restraints			
Left End		Right End	
Fixed	$\theta = \theta' = 0$	Free	$\theta'' = 0$

Concentrated torque at $\alpha = 0.3$ on member with fixed and free ends

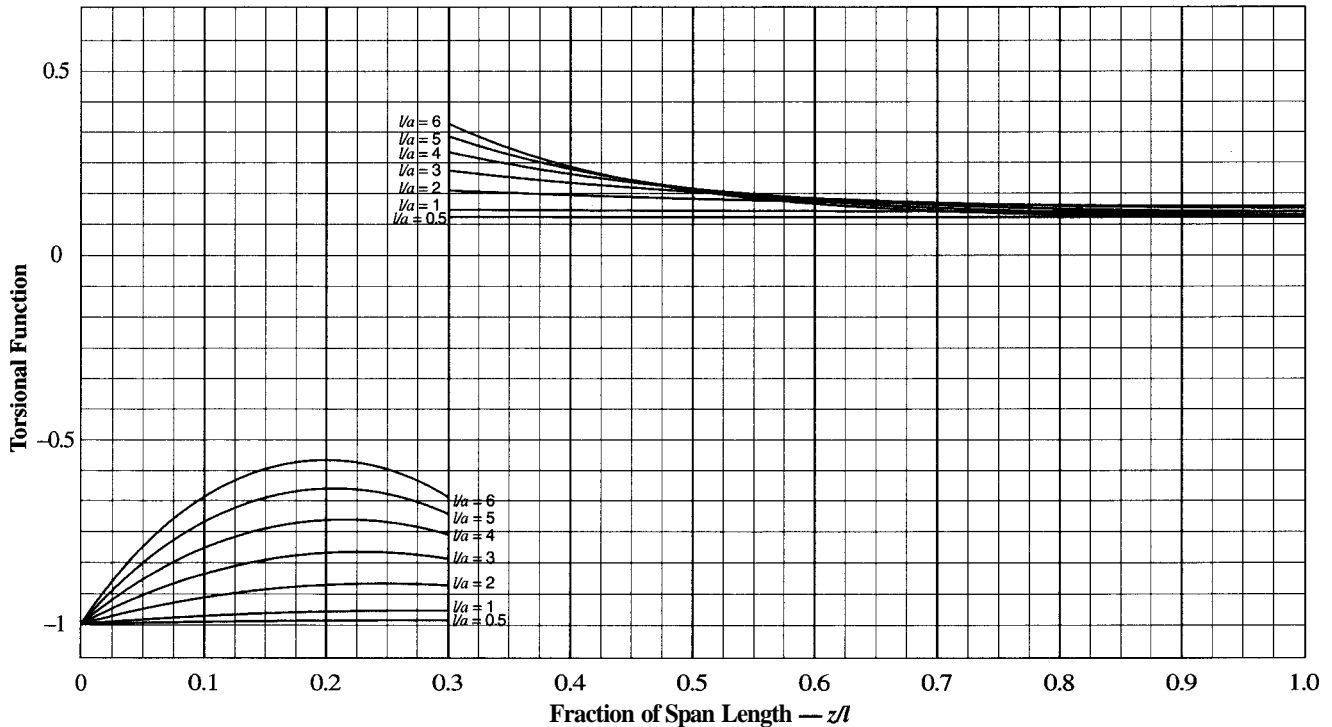

Case 9

$\alpha = 0.5$

$$\theta \times \left(\frac{GJ}{T} \times \frac{1}{a} \right)$$

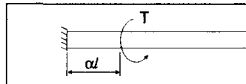

Torsional End Restraints	
Left End	Right End
Fixed $\theta = \theta' = 0$	Free $\theta'' = 0$

Concentrated torque at $\alpha = 0.5$ on member with fixed and free ends

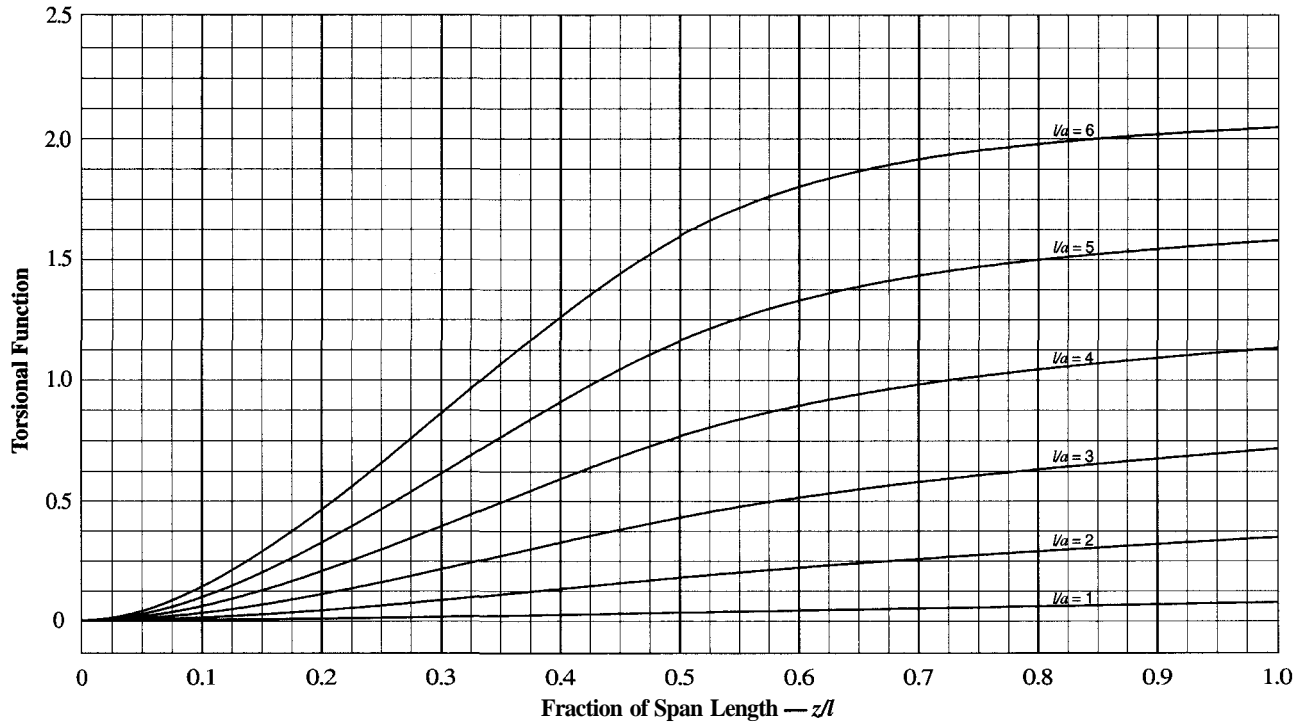

Case 9

$\alpha = 0.5$

$$\theta' \times \left(\frac{GJ}{T} \right)$$

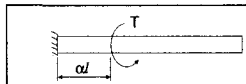

Torsional End Restraints	
Left End	Right End
Fixed $\theta = \theta' = 0$	Free $\theta'' = 0$

Concentrated torque at $\alpha = 0.5$ on member with fixed and free ends

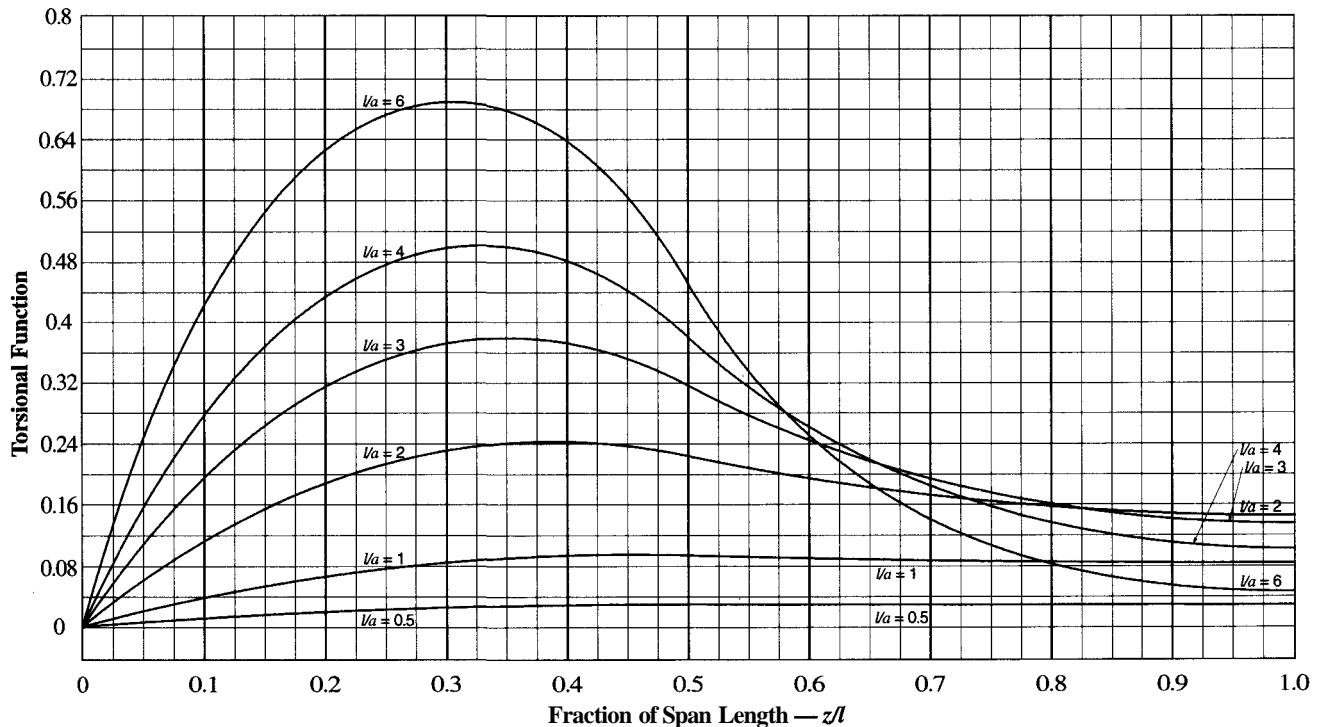

Case 9 $\theta'' \times \left(\frac{GJ}{T} \times a\right)$
 $\alpha = 0.5$

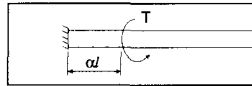

Torsional End Restraints			
Left End		Right End	
Fixed	$\theta = \theta' = 0$	Free	$\theta'' = 0$

Concentrated torque at $\alpha = 0.5$ on member with fixed and free ends

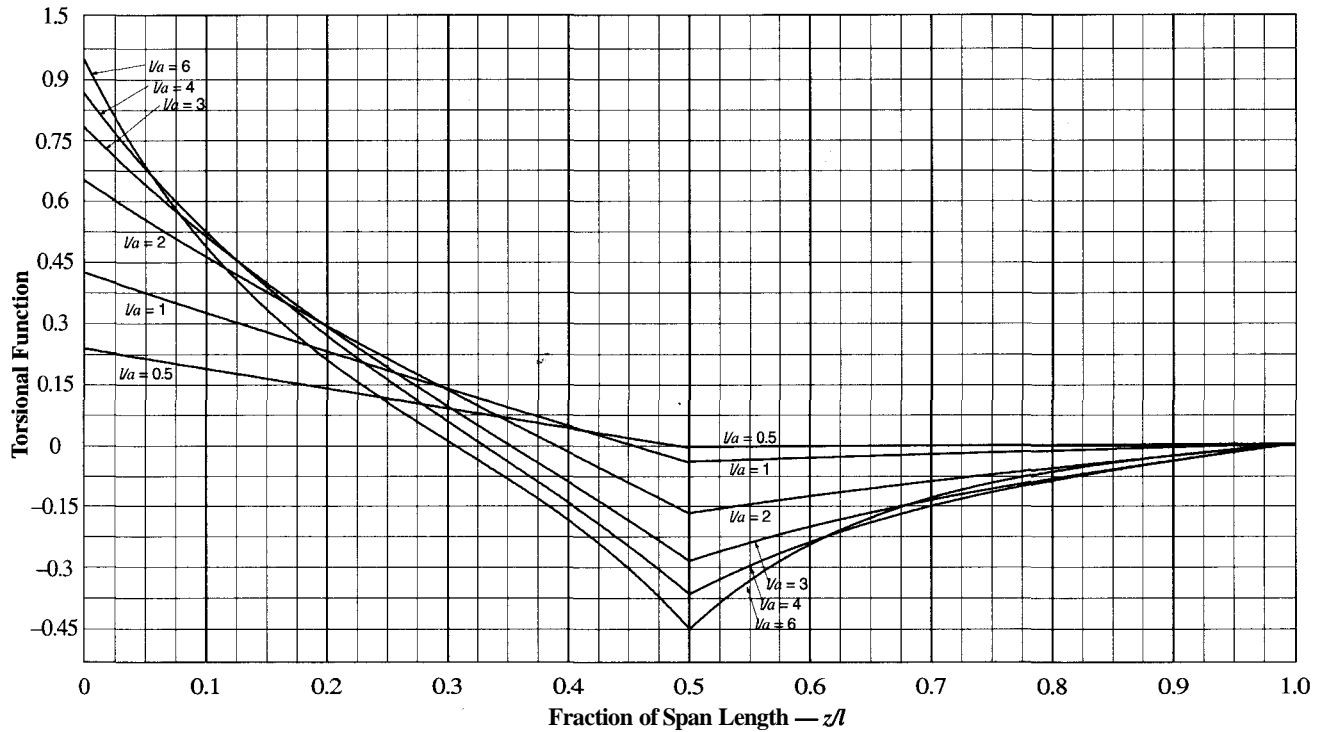

Case 9 $\theta''' \times \left(\frac{GJ}{T} \times a^2\right)$
 $\alpha = 0.5$

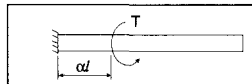

Torsional End Restraints			
Left End		Right End	
Fixed	$\theta = \theta' = 0$	Free	$\theta'' = 0$

Concentrated torque at $\alpha = 0.5$ on member with fixed and free ends

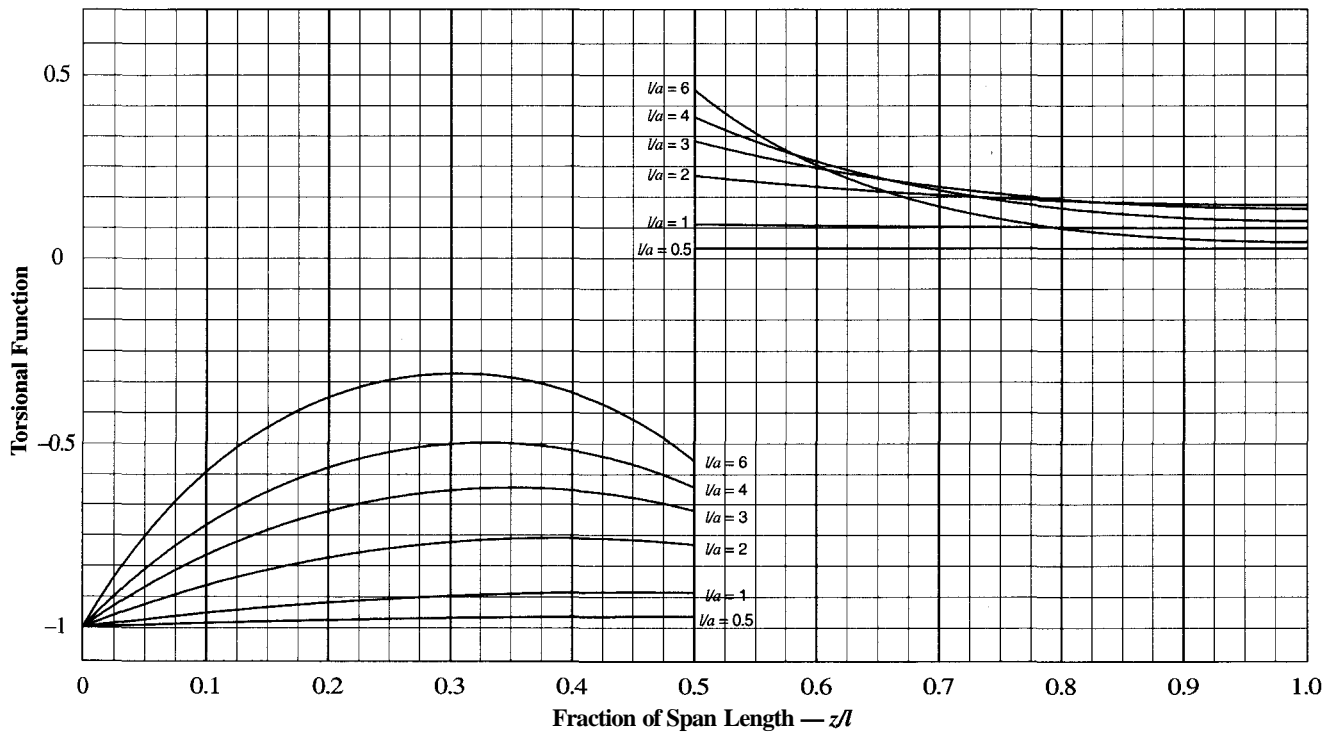

Case 9
 $\alpha = 0.7$

$$\theta \times \left(\frac{GJ}{T} \times \frac{1}{a} \right)$$

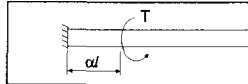

Torsional End Restraints	
Left End	Right End
Fixed $\theta = \theta' = 0$	Free $\theta'' = 0$

Concentrated torque at $\alpha = 0.7$ on member with fixed and free ends

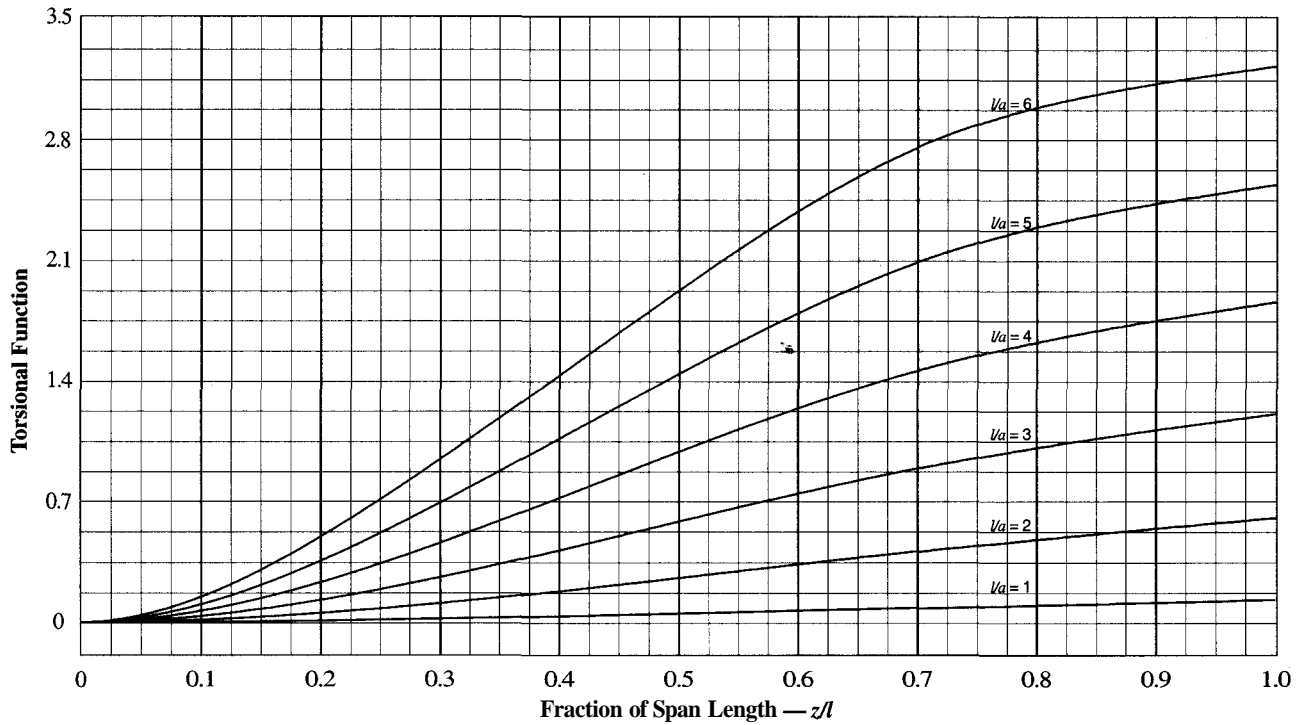

Case 9
 $\alpha = 0.7$

$$\theta' \times \left(\frac{GJ}{T} \right)$$

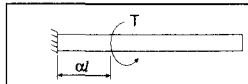

Torsional End Restraints	
Left End	Right End
Fixed $\theta = \theta' = 0$	Free $\theta'' = 0$

Concentrated torque at $\alpha = 0.7$ on member with fixed and free ends

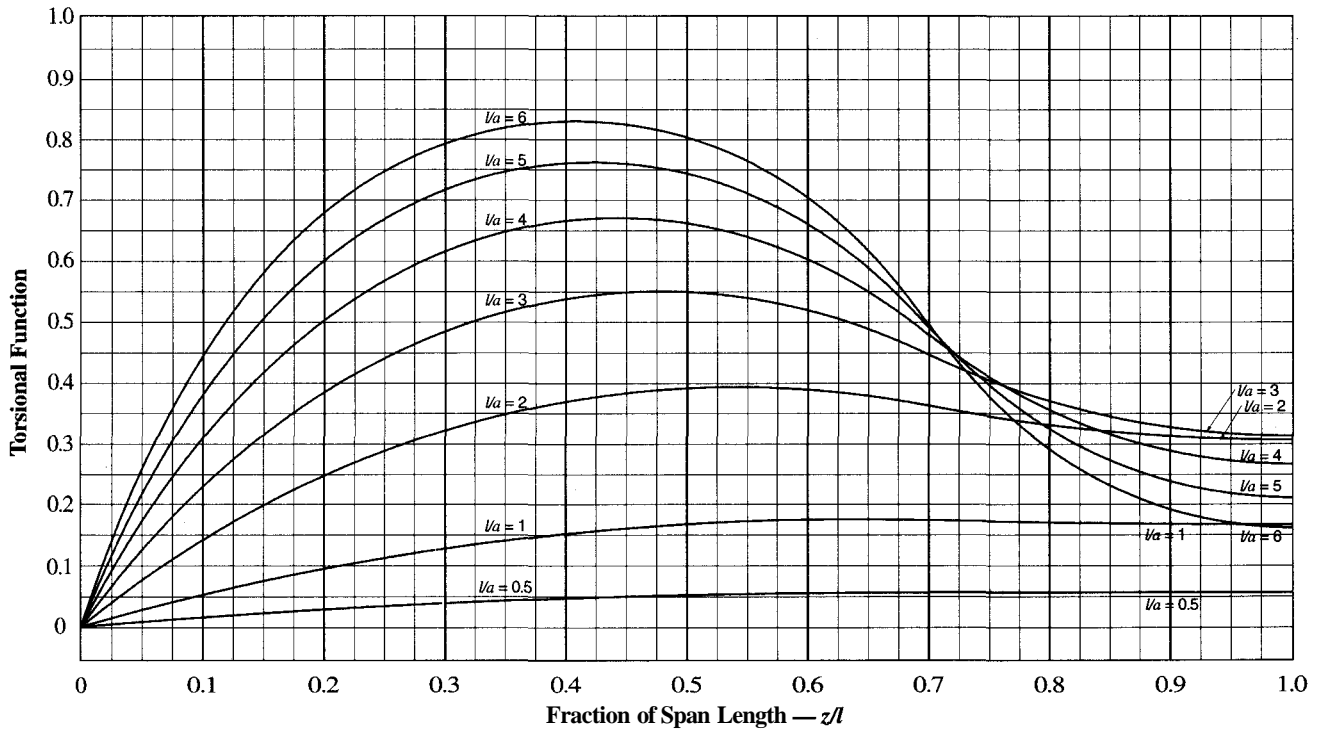

Case 9

$\alpha = 0.7$

$$\theta'' \times \left(\frac{GJ}{T} \times 2a \right)$$

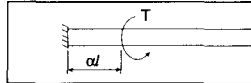

Torsional End Restraints	
Left End	Right End
Fixed $\theta = \theta' = 0$	Free $\theta'' = 0$

Concentrated torque at $\alpha = 0.7$ on member with fixed and free ends

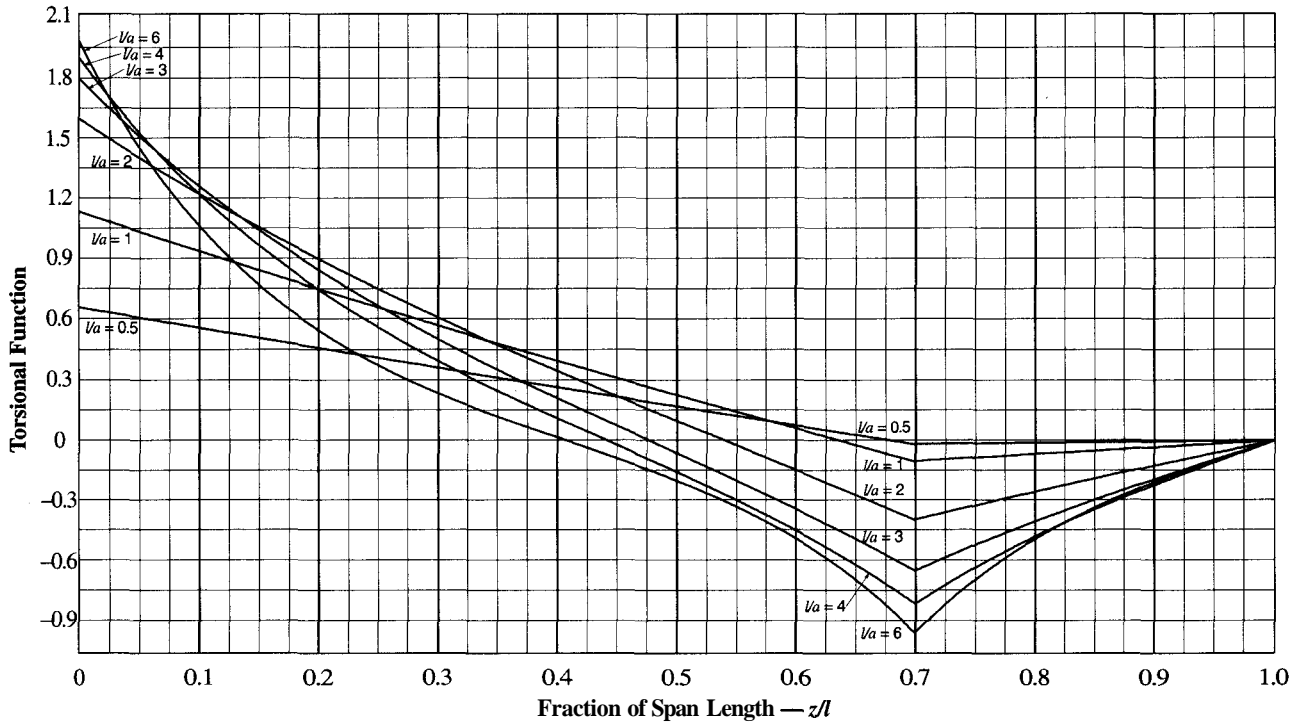

Case 9

$\alpha = 0.7$

$$\theta''' \times \left(\frac{GJ}{T} \times a^2 \right)$$

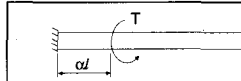

Torsional End Restraints	
Left End	Right End
Fixed $\theta = \theta' = 0$	Free $\theta'' = 0$

Concentrated torque at $\alpha = 0.7$ on member with fixed and free ends

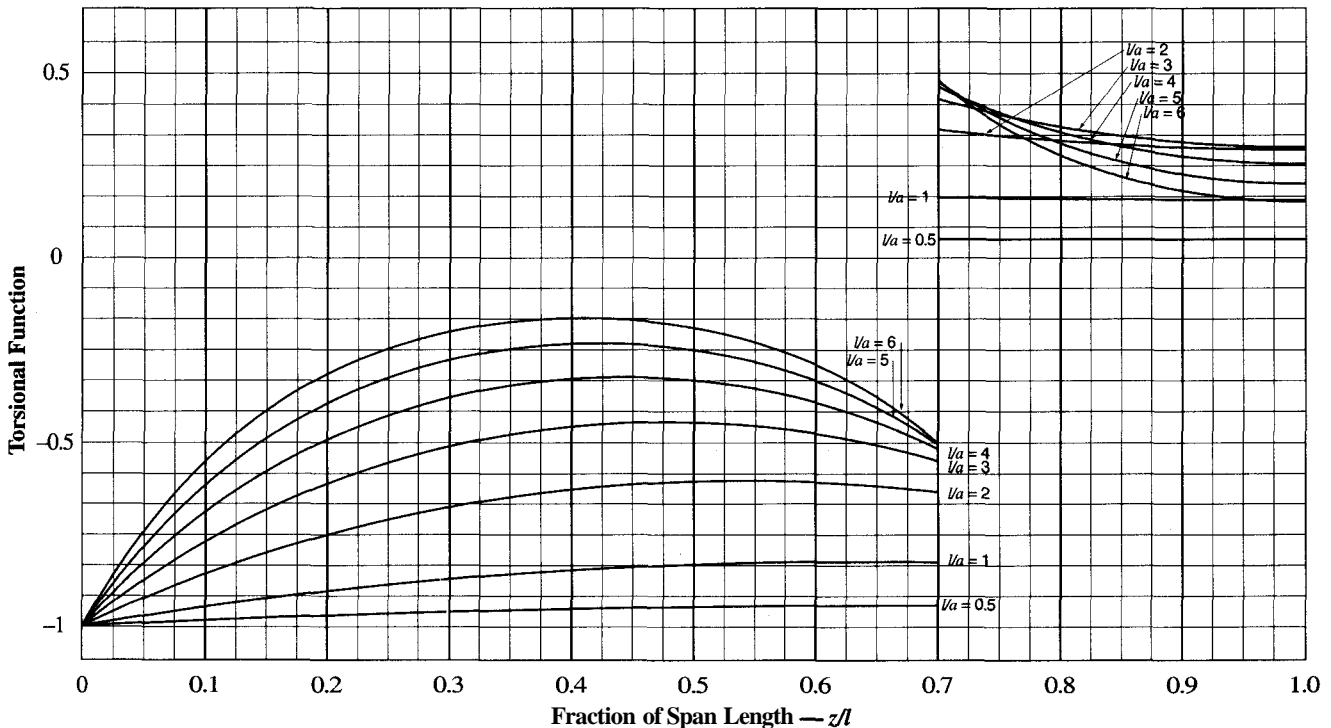

Case 9

$\alpha = 0.9$

$$\theta \times \left(\frac{GJ}{T} \times \frac{1}{a} \right)$$

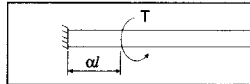

Torsional End Restraints	
Left End	Right End
Fixed $\theta = \theta' = 0$	Free $\theta'' = 0$

Concentrated torque at $\alpha = 0.9$ on member with fixed and free ends

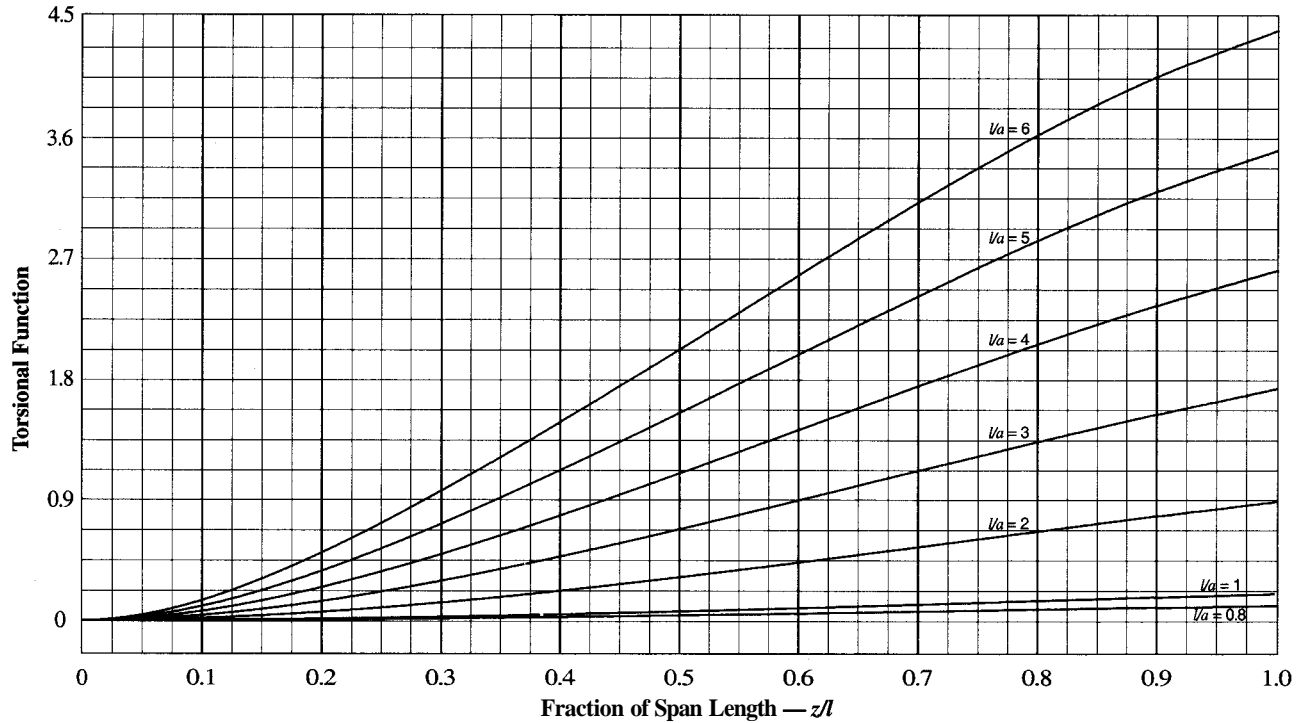

Case 9

$\alpha = 0.9$

$$\theta' \times \left(\frac{GJ}{T} \right)$$



Torsional End Restraints	
Left End	Right End
Fixed $\theta = \theta' = 0$	Free $\theta'' = 0$

Concentrated torque at $\alpha = 0.9$ on member with fixed and free ends

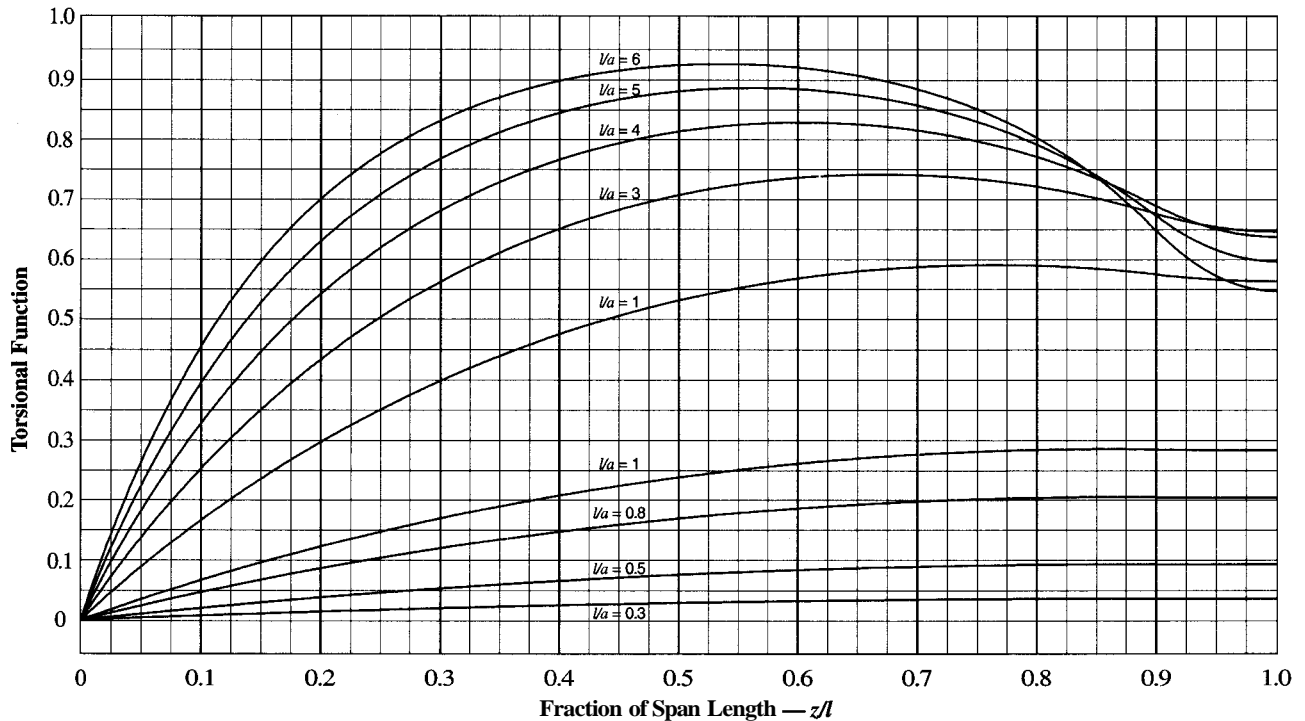

Case 9

$$\theta'' \times \left(\frac{GJ}{T} \times 4a \right)$$

$\alpha = 0.9$

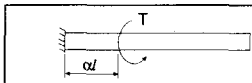

Torsional End Restraints	
Left End	Right End
Fixed $\theta = \theta' = 0$	Free $\theta'' = 0$

Concentrated torque at $\alpha = 0.9$ on member with fixed and free ends

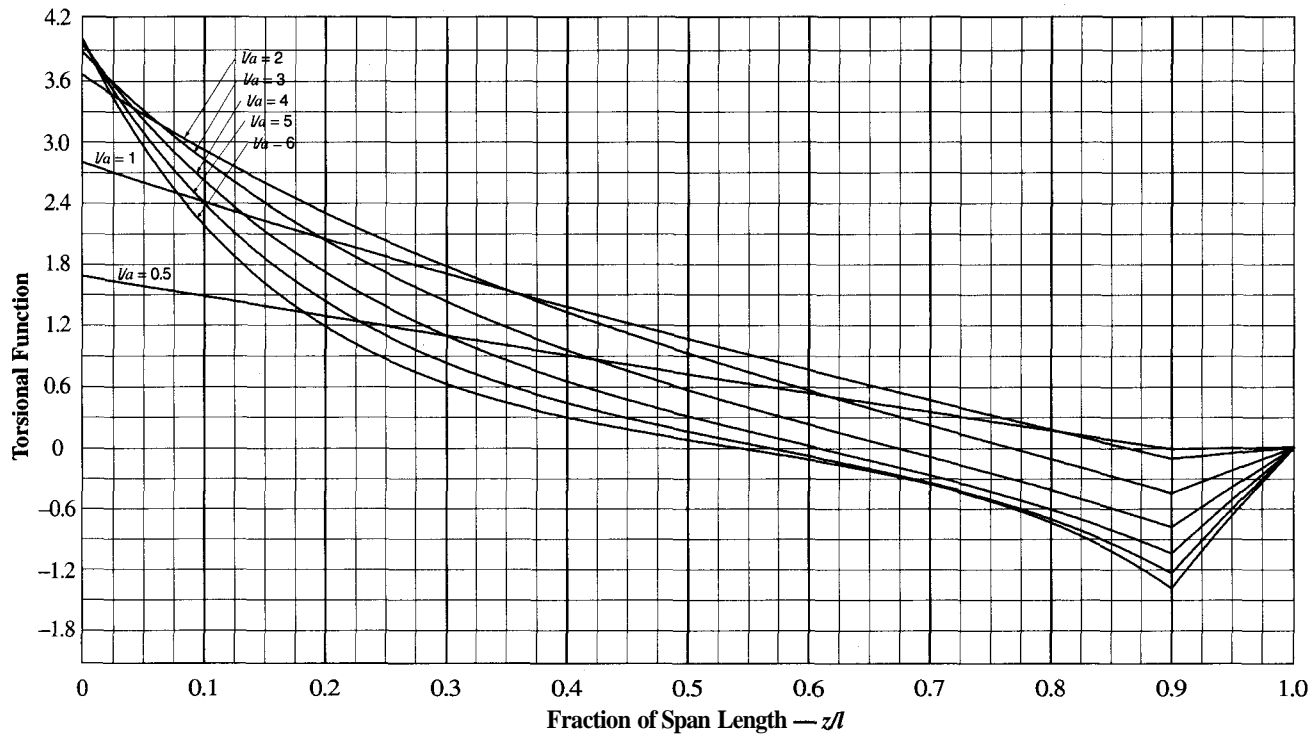

Case 9

$$\theta''' \times \left(\frac{GJ}{T} \times a^2 \right)$$

$\alpha = 0.9$

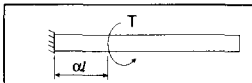

Torsional End Restraints	
Left End	Right End
Fixed $\theta = \theta' = 0$	Free $\theta'' = 0$

Concentrated torque at $\alpha = 0.9$ on member with fixed and free ends

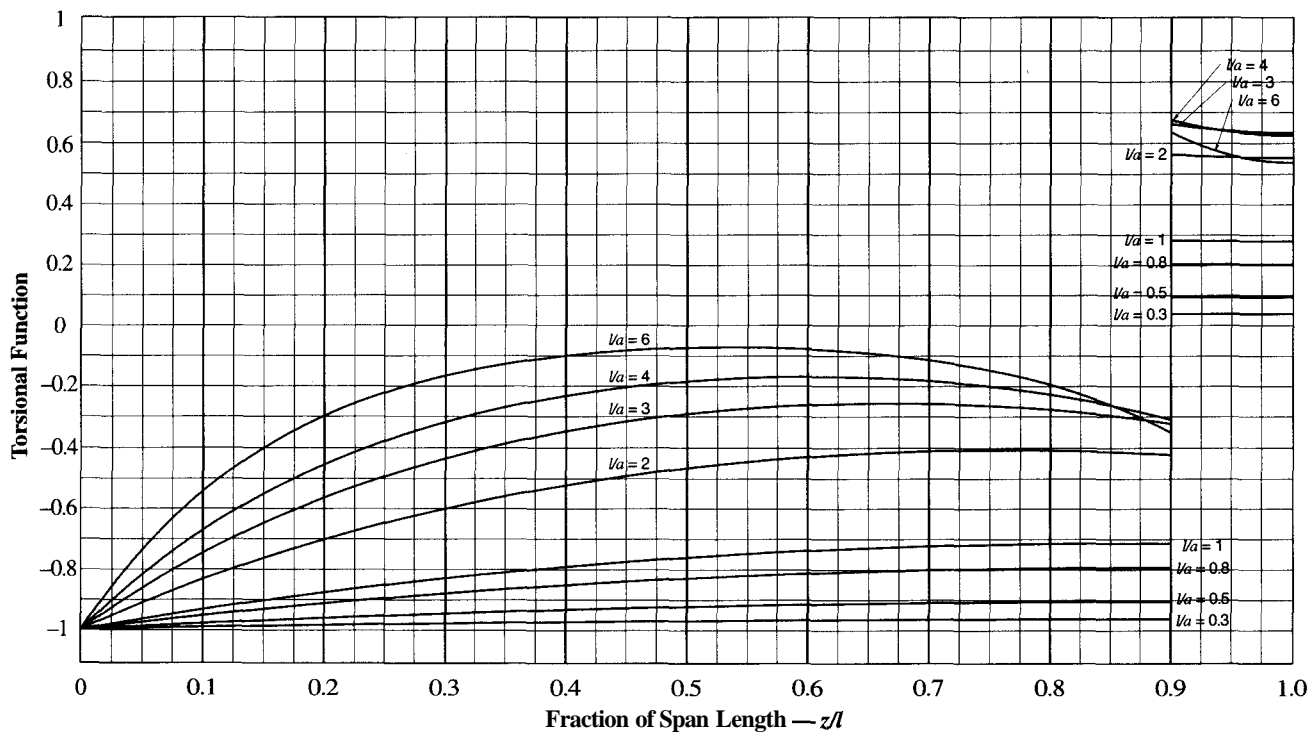

Case 9

$\alpha = 1.0$

$$\theta \times \left(\frac{GJ}{T} \times \frac{1}{a} \right)$$

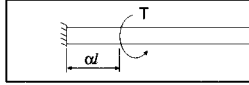

Torsional End Restraints	
Left End	Right End
Fixed $\theta = \theta' = 0$	Free $\theta'' = 0$

Concentrated torque at $\alpha = 1.0$ on member with fixed and free ends

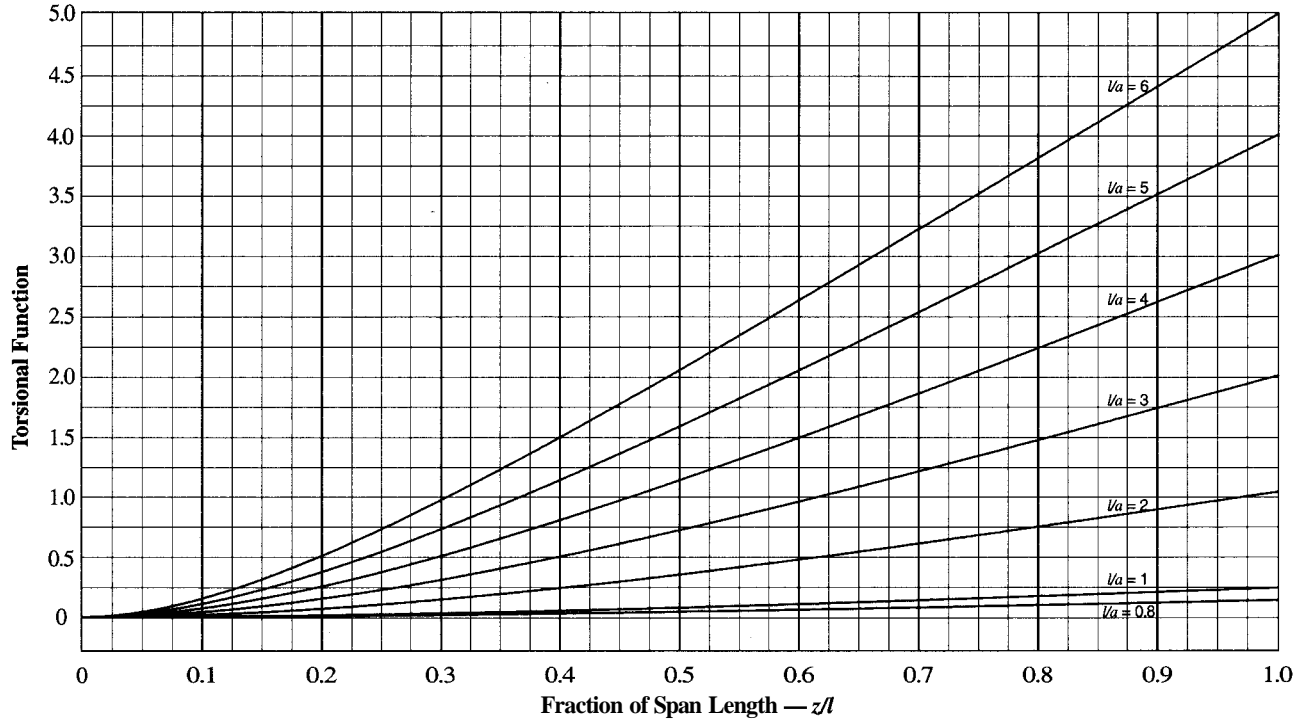

Case 9

$\alpha = 1.0$

$$\theta' \times \left(\frac{GJ}{T} \right)$$

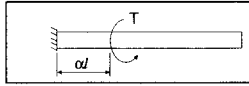

Torsional End Restraints	
Left End	Right End
Fixed $\theta = \theta' = 0$	Free $\theta'' = 0$

Concentrated torque at $\alpha = 1.0$ on member with fixed and free ends

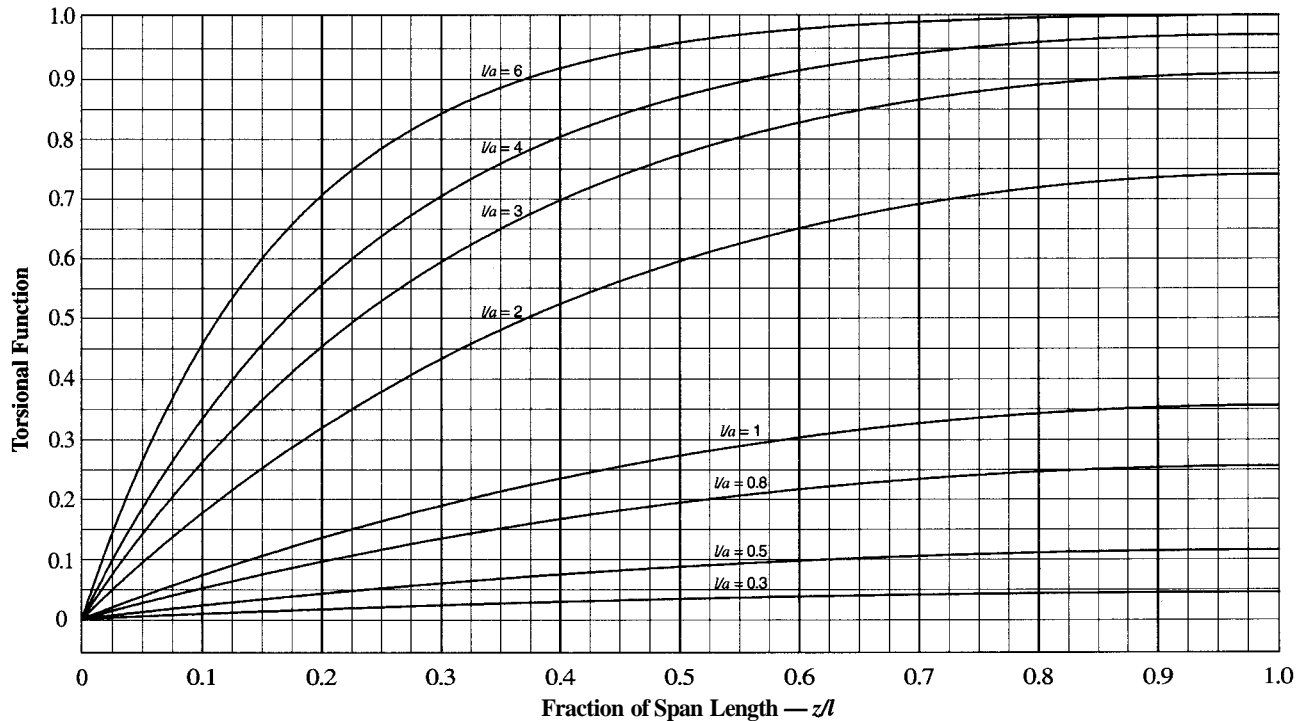

Case 9

$$\theta'' \times \left(\frac{GJ}{T} \times 5a \right)$$

$\alpha = 1.0$

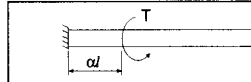

Torsional End Restraints	
Left End	Right End
Fixed $\theta = \theta' = 0$	Free $\theta'' = 0$

Concentrated torque at $\alpha = 1.0$ on member with fixed and free ends

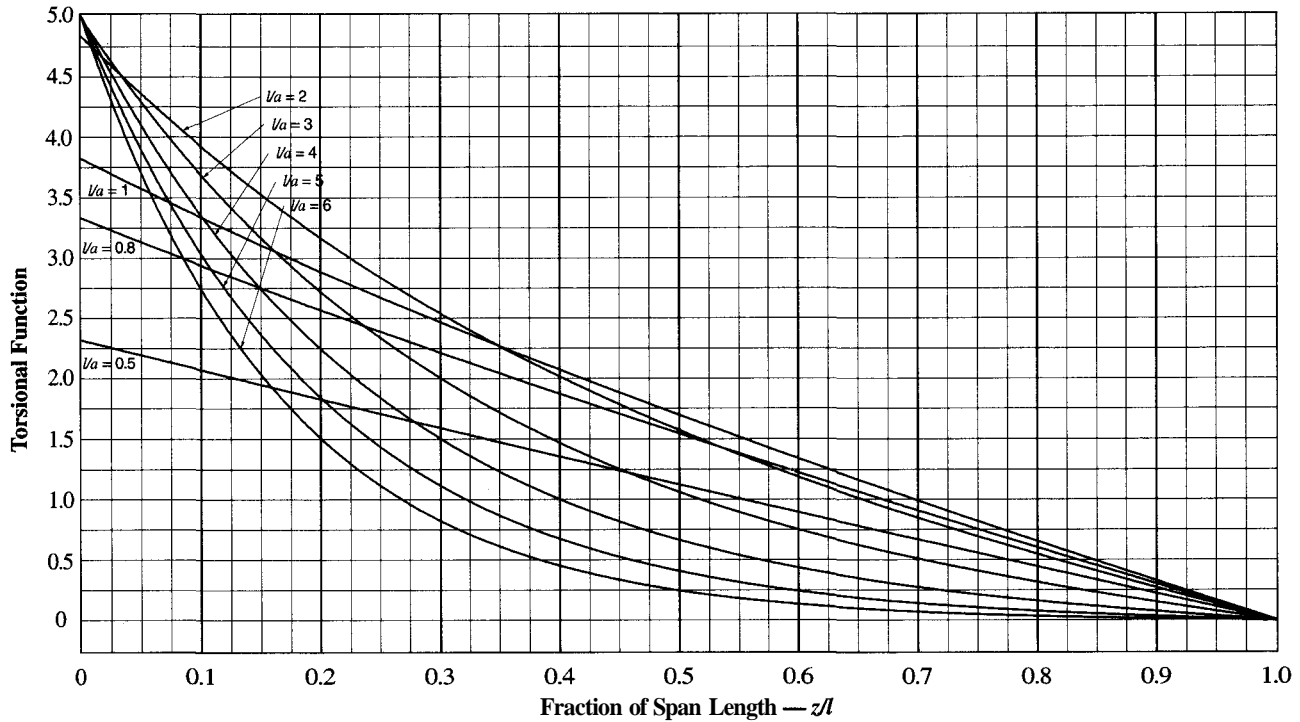

Case 9

$$\theta''' \times \left(\frac{GJ}{T} \times a^2 \right)$$

$\alpha = 1.0$

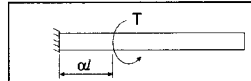

Torsional End Restraints	
Left End	Right End
Fixed $\theta = \theta' = 0$	Free $\theta'' = 0$

Concentrated torque at $\alpha = 1.0$ on member with fixed and free ends

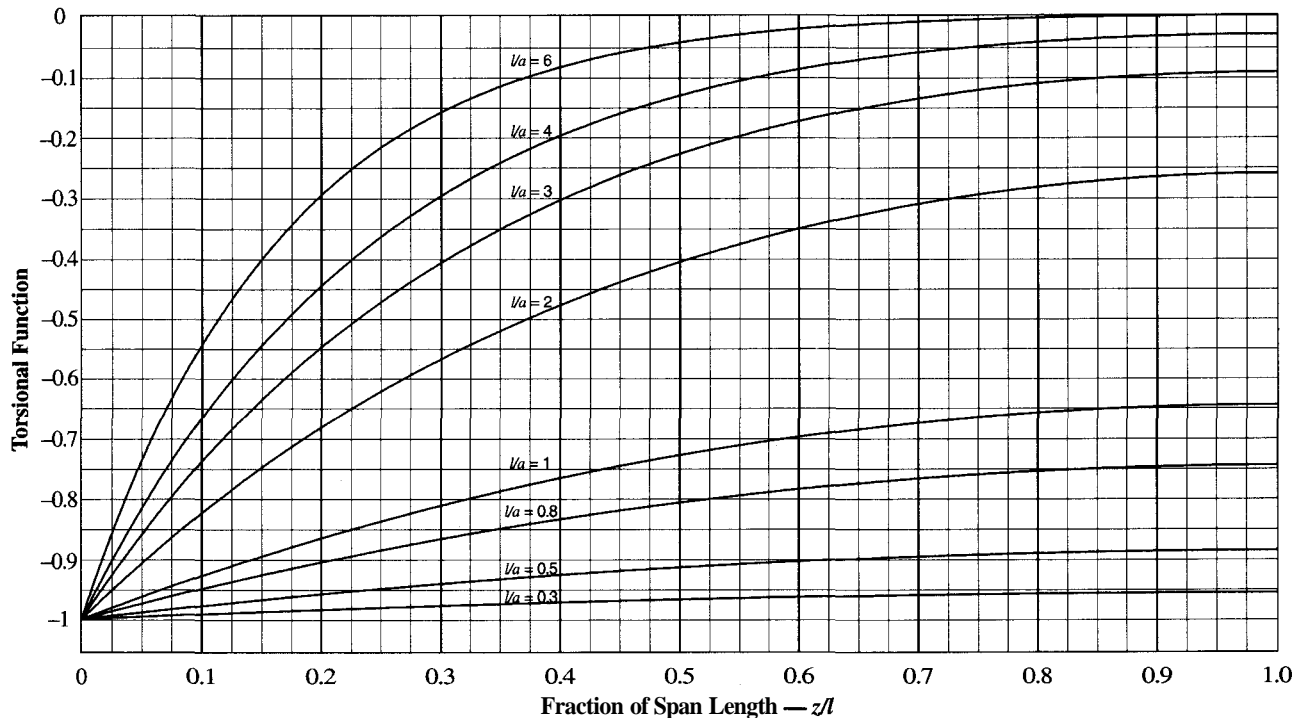

Case 10 $\theta \times \left(\frac{GJ}{t} \times \frac{5}{a^2}\right)$
 $\alpha = 0.1$

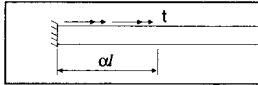

Torsional End Restraints		Partial uniformly distributed torque along $\alpha = 0.1$ with fixed end and free end
Left End	Right End	
Fixed $\theta = \theta' = 0$	Free $\theta'' = 0$	

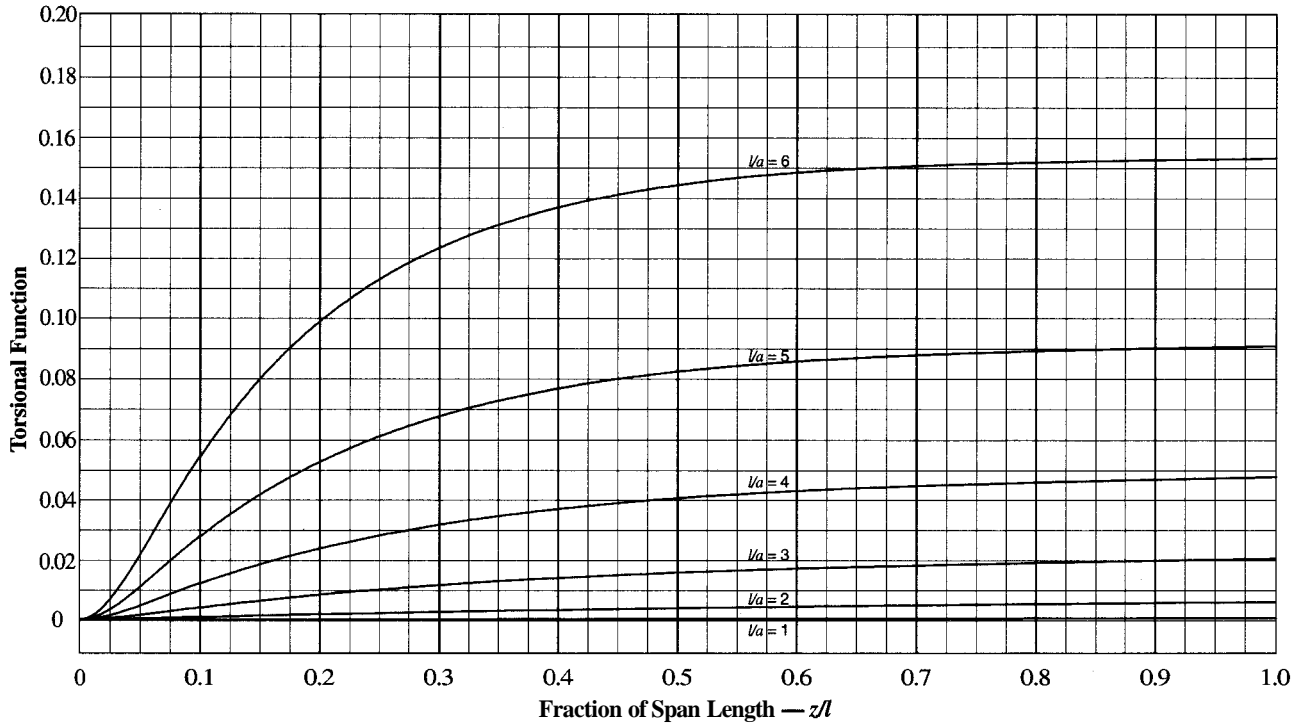

Case 10 $\theta' \times \left(\frac{GJ}{t} \times \frac{1}{a}\right)$
 $\alpha = 0.1$

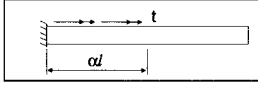

Torsional End Restraints		Partial uniformly distributed torque along $\alpha = 0.1$ with fixed end and free end
Left End	Right End	
Fixed $\theta = \theta' = 0$	Free $\theta'' = 0$	

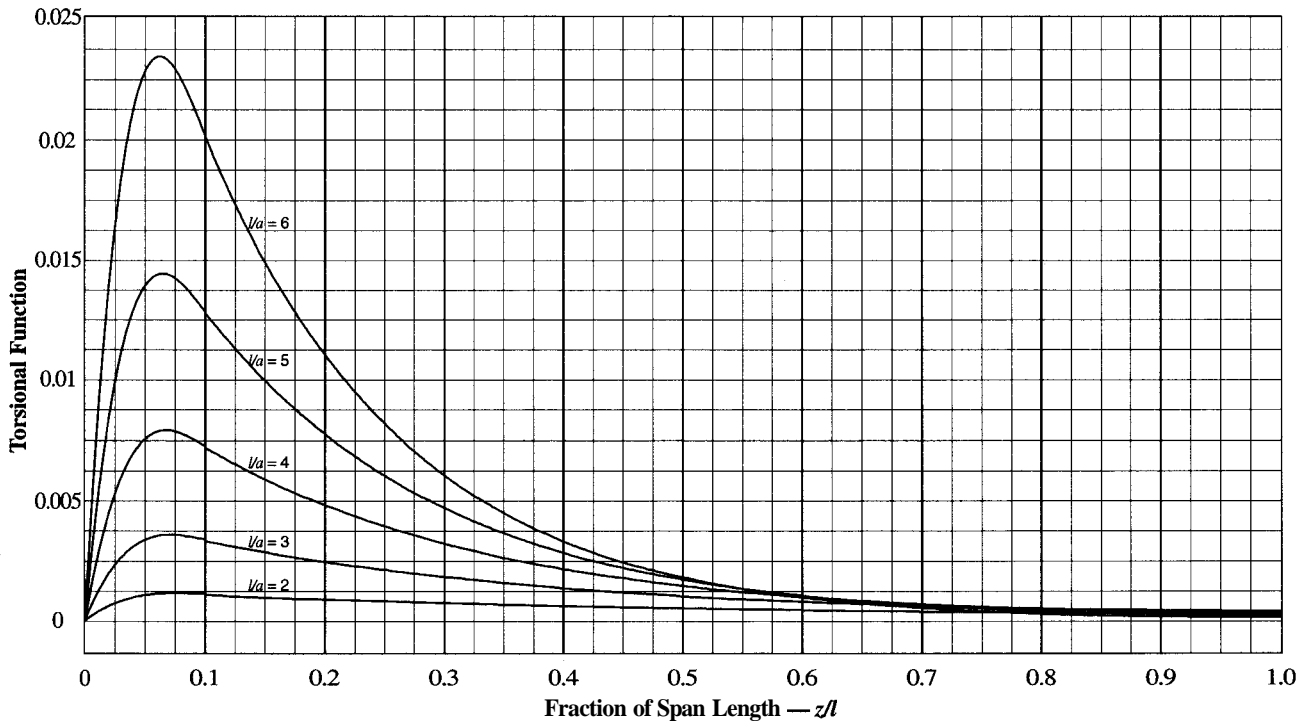

Case 10 $\theta'' \times \left(\frac{GJ}{t}\right)$
 $\alpha = 0.1$

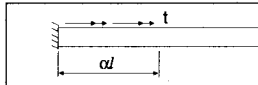

Torsional End Restraints	
Left End	Right End
Fixed $\theta = \theta' = 0$	Free $\theta'' = 0$

Partial uniformly distributed torque along $\alpha = 0.1$ with fixed end and free end

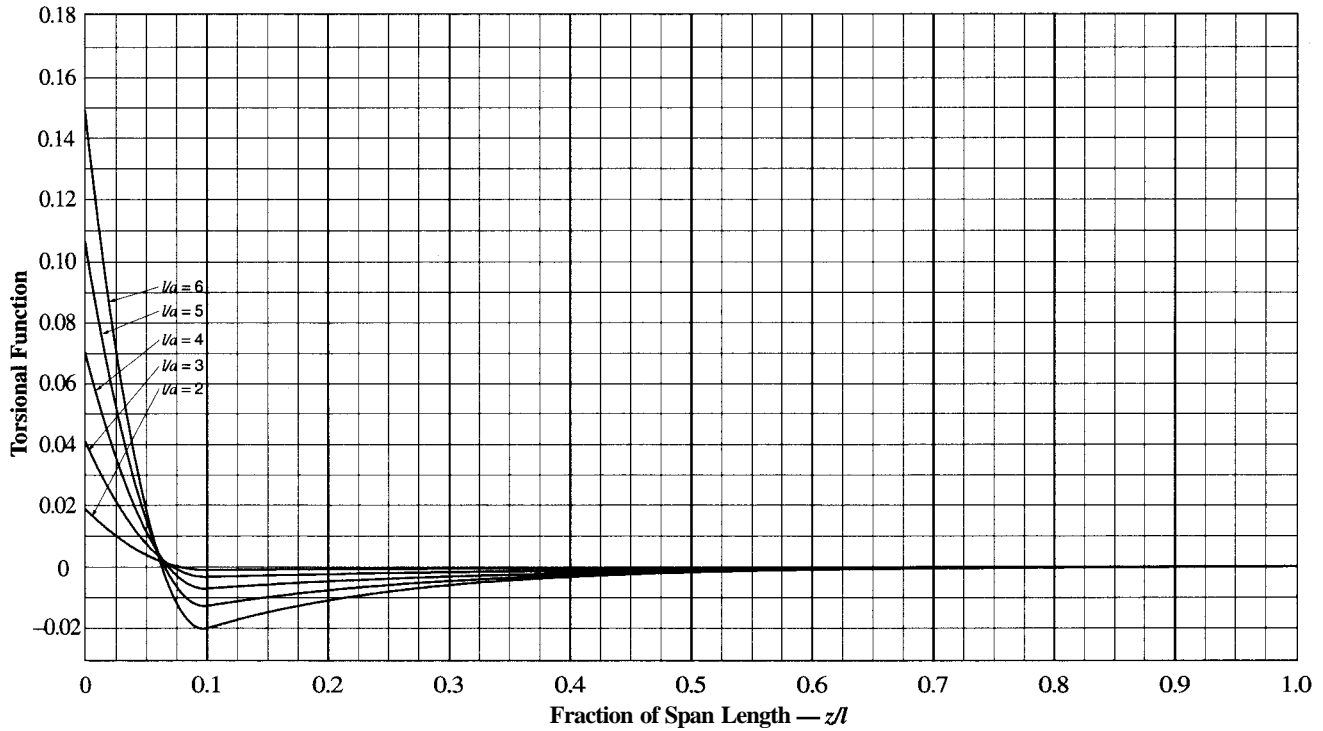

Case 10 $\theta''' \times \left(\frac{GJ}{t} \times a\right)$
 $\alpha = 0.1$

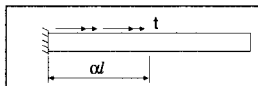

Torsional End Restraints	
Left End	Right End
Fixed $\theta = \theta' = 0$	Free $\theta'' = 0$

Partial uniformly distributed torque along $\alpha = 0.1$ with fixed end and free end

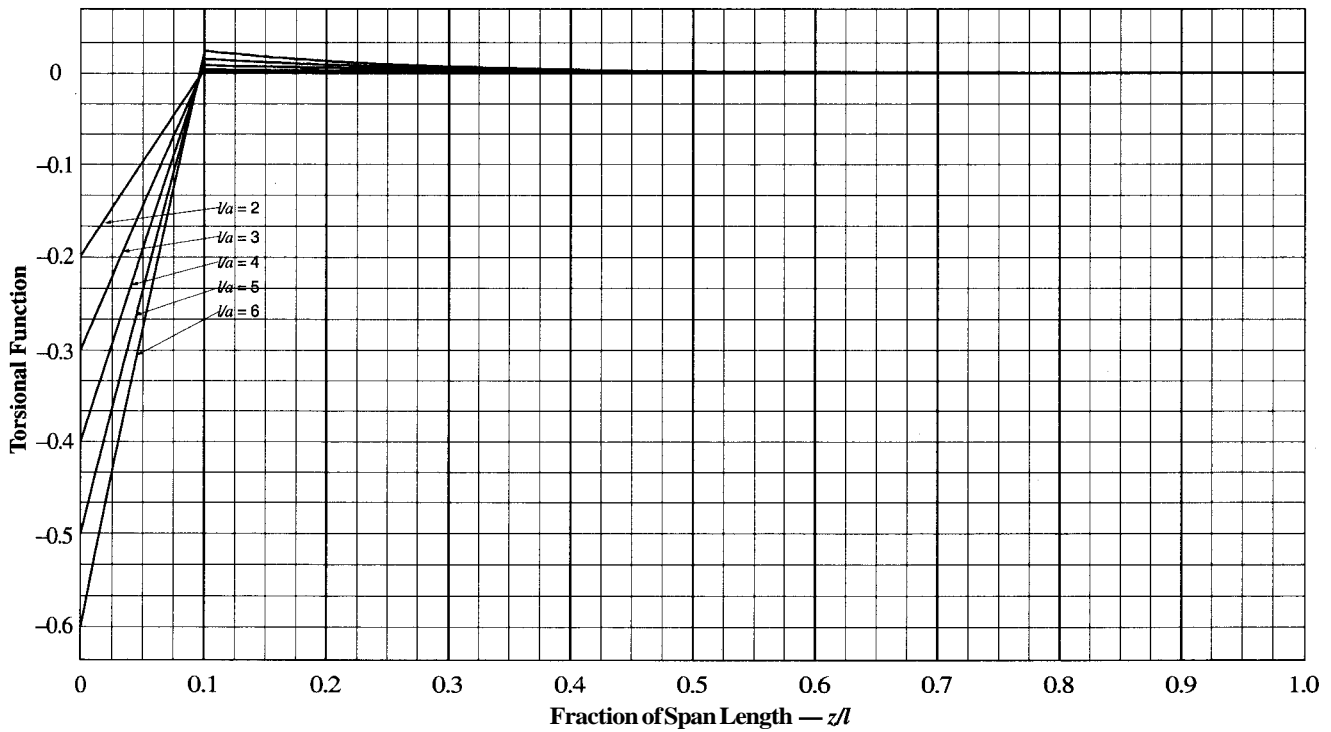

Case 10 $\theta \times \left(\frac{GJ}{t} \times \frac{1}{a^2} \right)$
 $\alpha = 0.3$

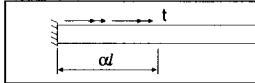

Torsional End Restraints		Partial uniformly distributed torque along $\alpha = 0.3$ with fixed end and free end
Left End	Right End	
Fixed $\theta = \theta' = 0$	Free $\theta'' = 0$	

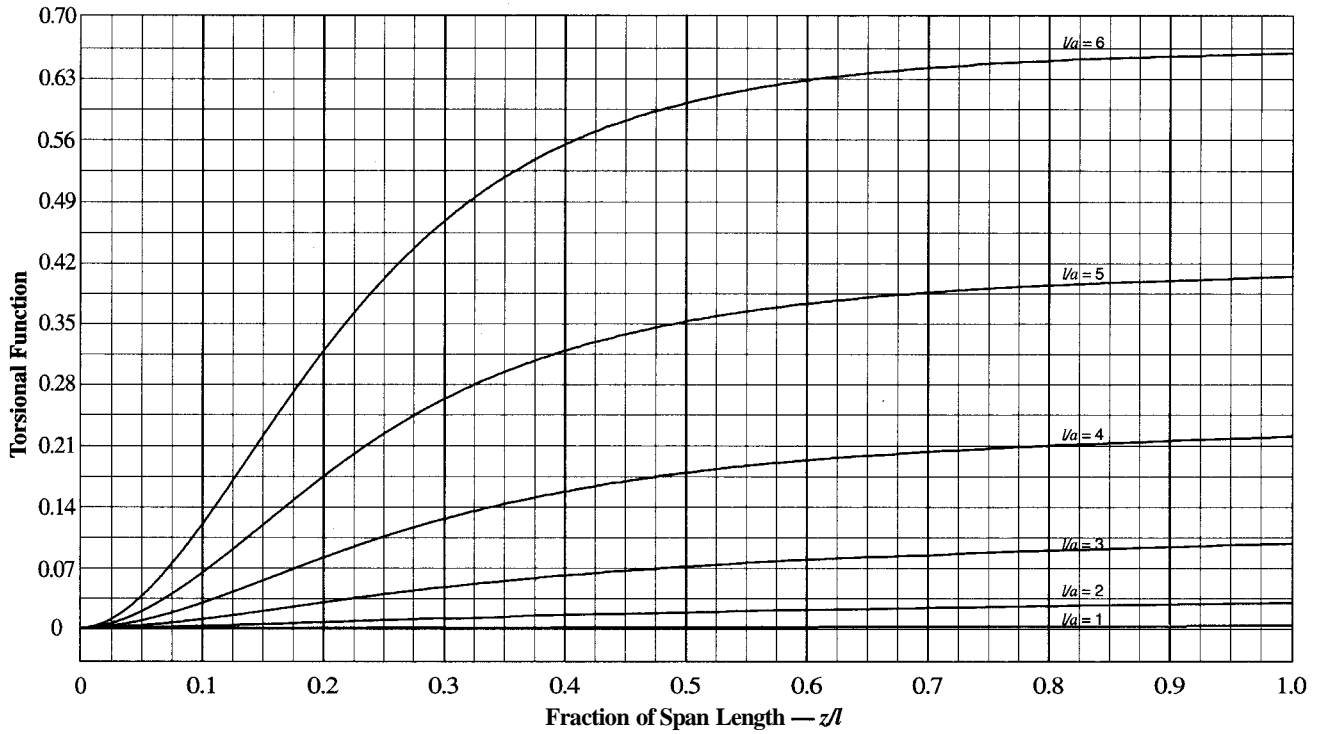

Case 10 $\theta' \times \left(\frac{GJ}{t} \times \frac{2}{a} \right)$
 $\alpha = 0.3$

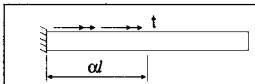

Torsional End Restraints		Partial uniformly distributed torque along $\alpha = 0.3$ with fixed end and free end
Left End	Right End	
Fixed $\theta = \theta' = 0$	Free $\theta'' = 0$	

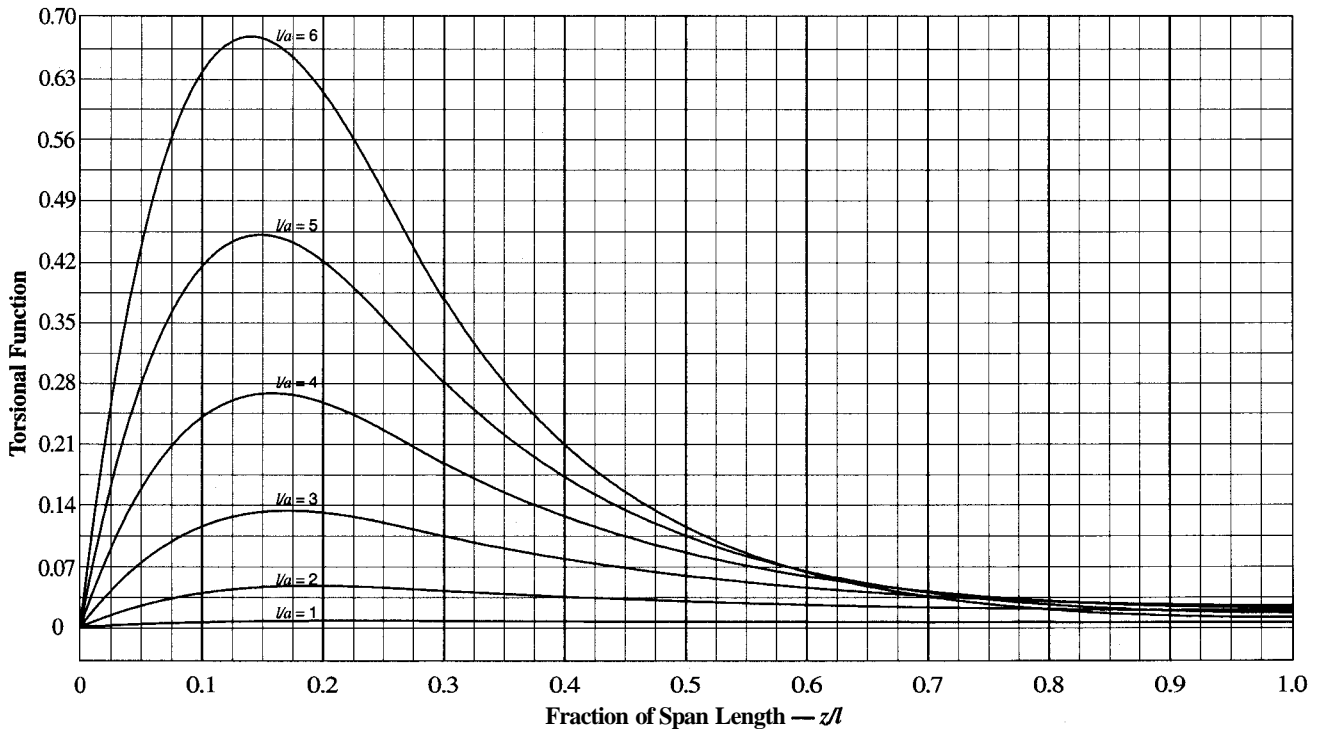

Case 10 $\theta'' \times \left(\frac{GJ}{t}\right)$
 $\alpha = 0.3$

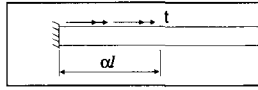

Torsional End Restraints			
Left End		Right End	
Fixed	$\theta = \theta' = 0$	Free	$\theta'' = 0$

Partial uniformly distributed torque along $\alpha = 0.3$ with fixed end and free end

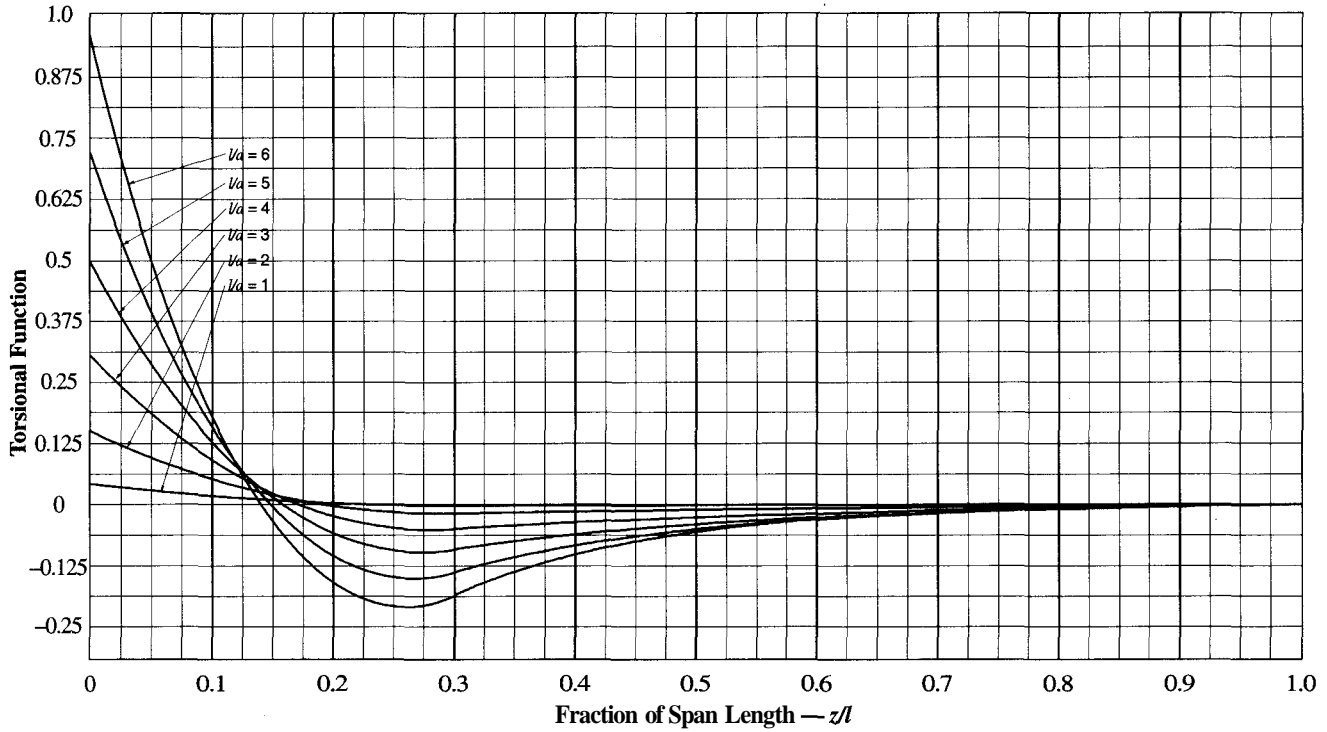

Case 10 $\theta''' \times \left(\frac{GJ}{t} \times a\right)$
 $\alpha = 0.3$

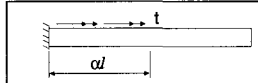

Torsional End Restraints			
Left End		Right End	
Fixed	$\theta = \theta' = 0$	Free	$\theta'' = 0$

Partial uniformly distributed torque along $\alpha = 0.3$ with fixed end and free end

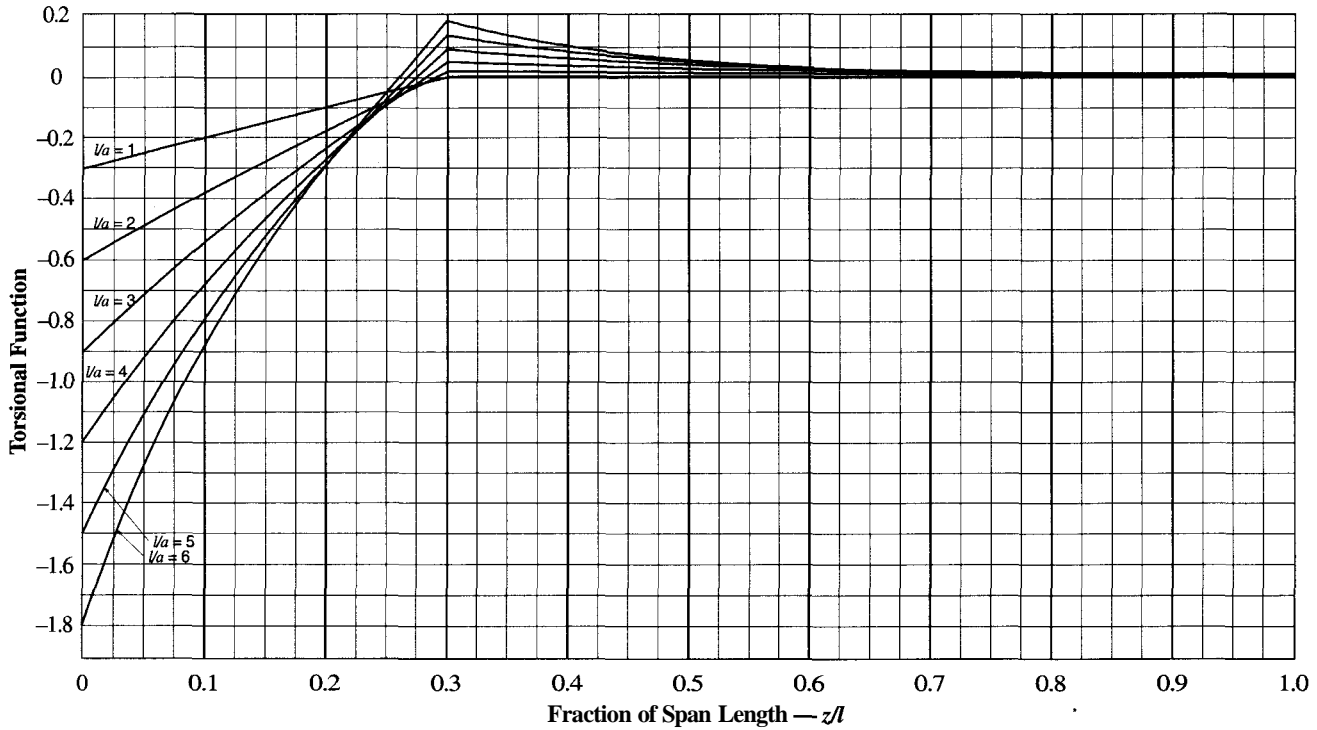

Case 10 $\theta \times \left(\frac{GJ}{t} \times \frac{1}{a^2} \right)$
 $\alpha = 0.5$

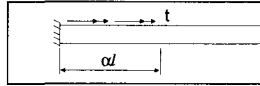

Torsional End Restraints	
Left End	Right End
Fixed $\theta = \theta' = 0$	Free $\theta'' = 0$

Partial uniformly distributed torque along $\alpha = 0.5$ with fixed end and free end

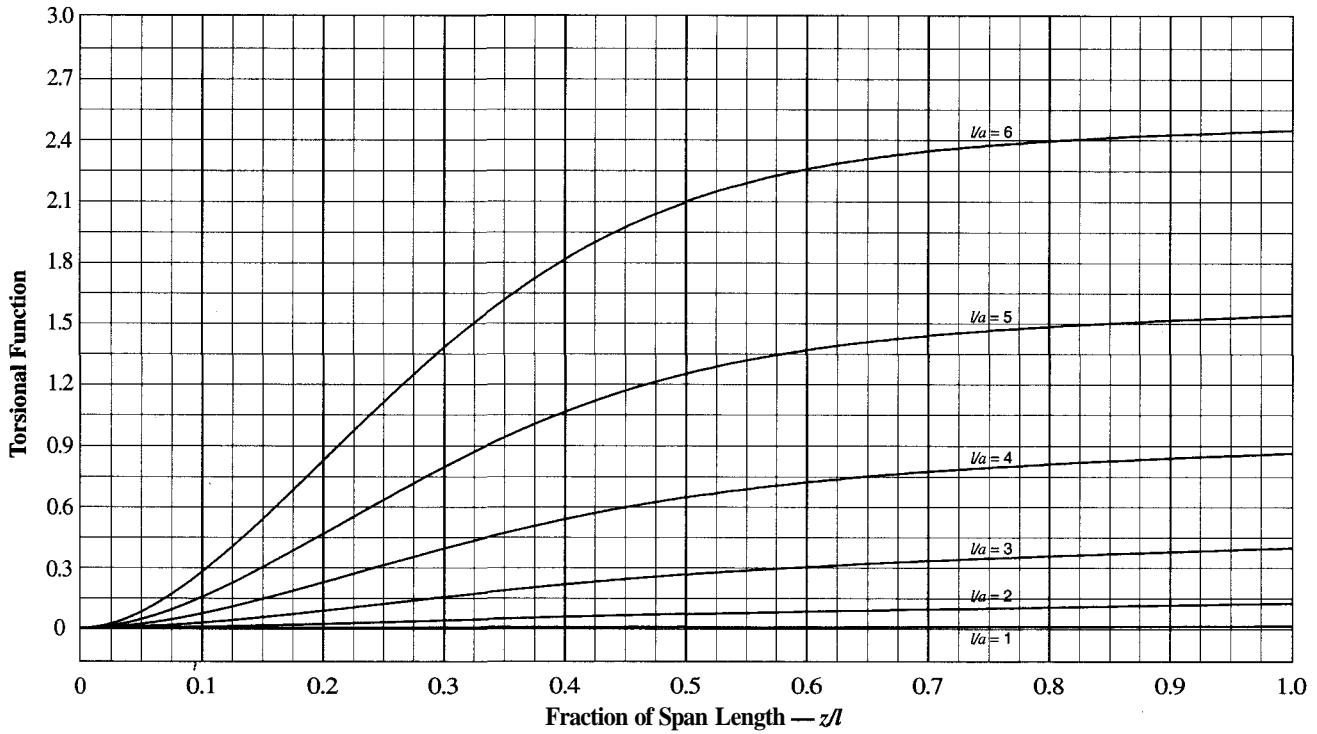

Case 10 $\theta' \times \left(\frac{GJ}{t} \times \frac{2}{a} \right)$
 $\alpha = 0.5$

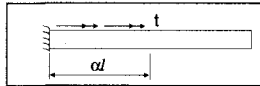

Torsional End Restraints	
Left End	Right End
Fixed $\theta = \theta' = 0$	Free $\theta'' = 0$

Partial uniformly distributed torque along $\alpha = 0.5$ with fixed end and free end

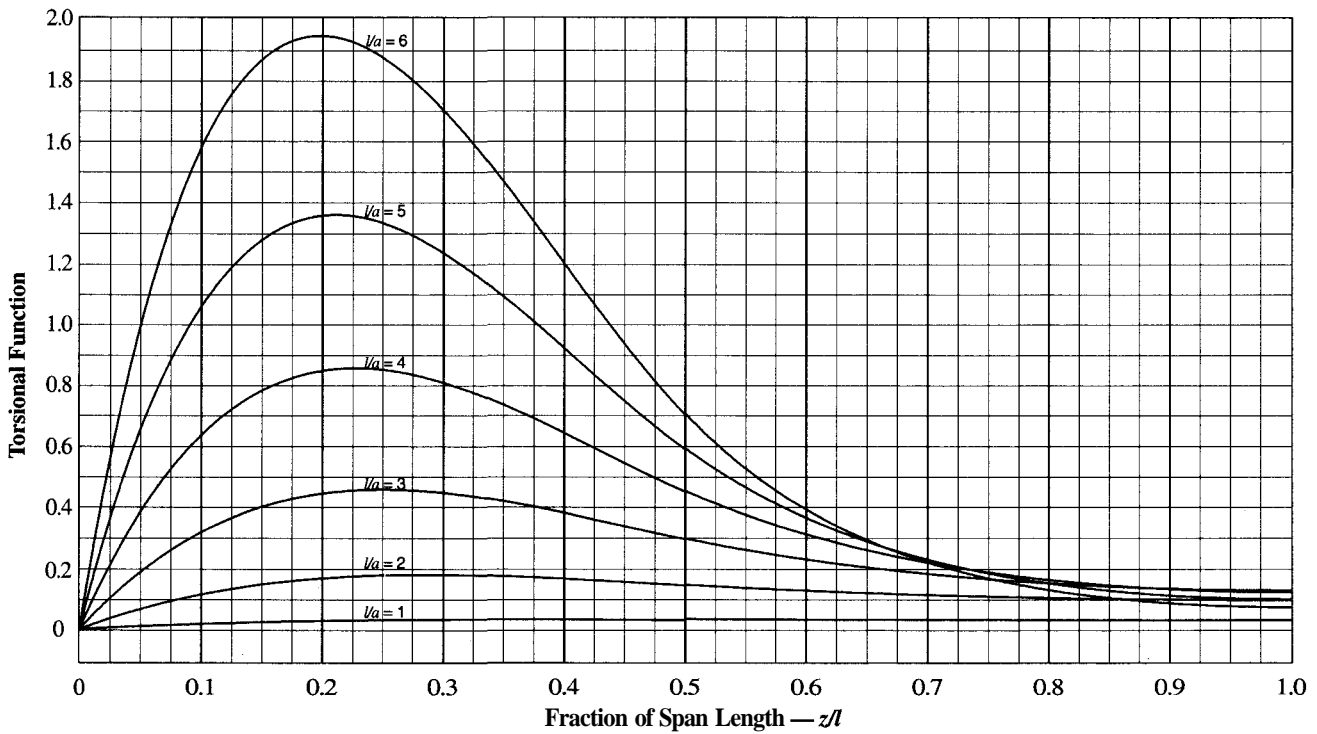

Case 10 $\theta'' \times \left(\frac{GJ}{t}\right)$
 $\alpha = 0.5$

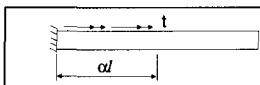

Torsional End Restraints			
Left End		Right End	
Fixed	$\theta = \theta' = 0$	Free	$\theta'' = 0$

Partial uniformly distributed torque along $\alpha = 0.5$ with fixed end and free end

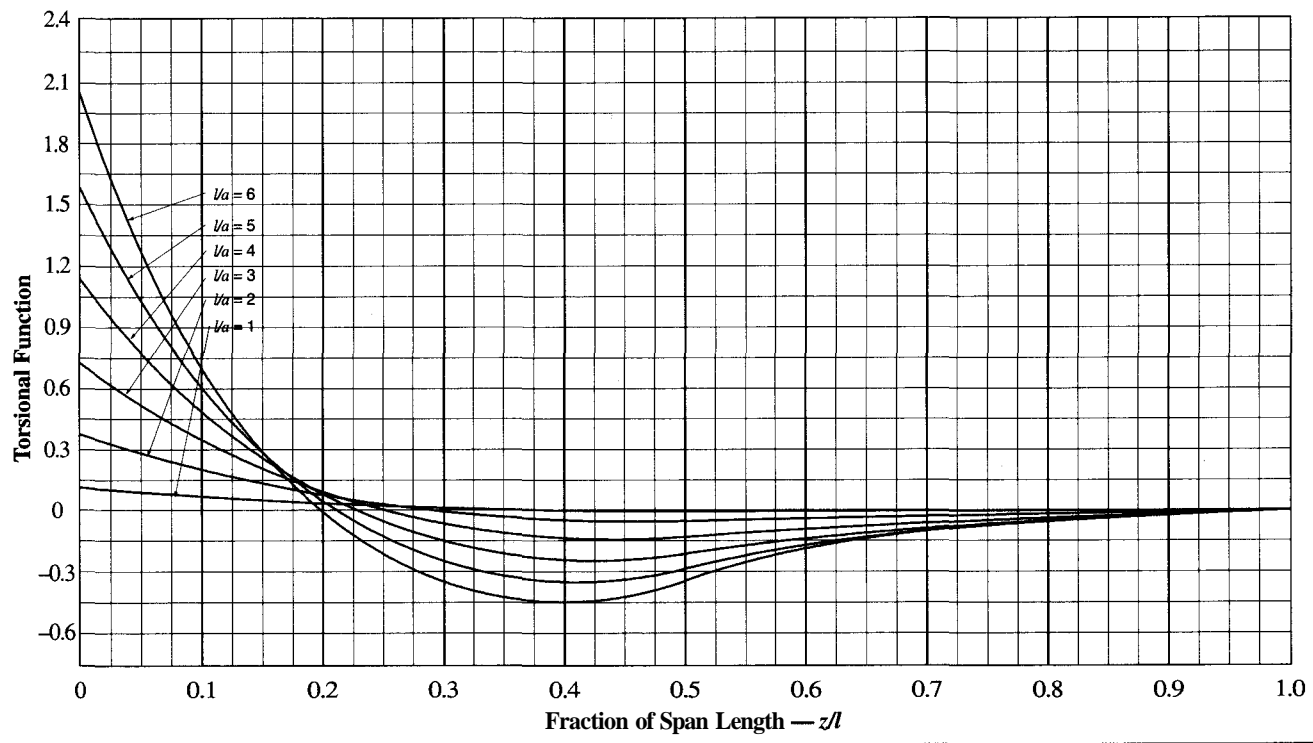

Case 10 $\theta''' \times \left(\frac{GJ}{t} \times a\right)$
 $\alpha = 0.5$

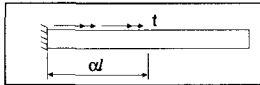

Torsional End Restraints			
Left End		Right End	
Fixed	$\theta = \theta' = 0$	Free	$\theta'' = 0$

Partial uniformly distributed torque along $\alpha = 0.5$ with fixed end and free end

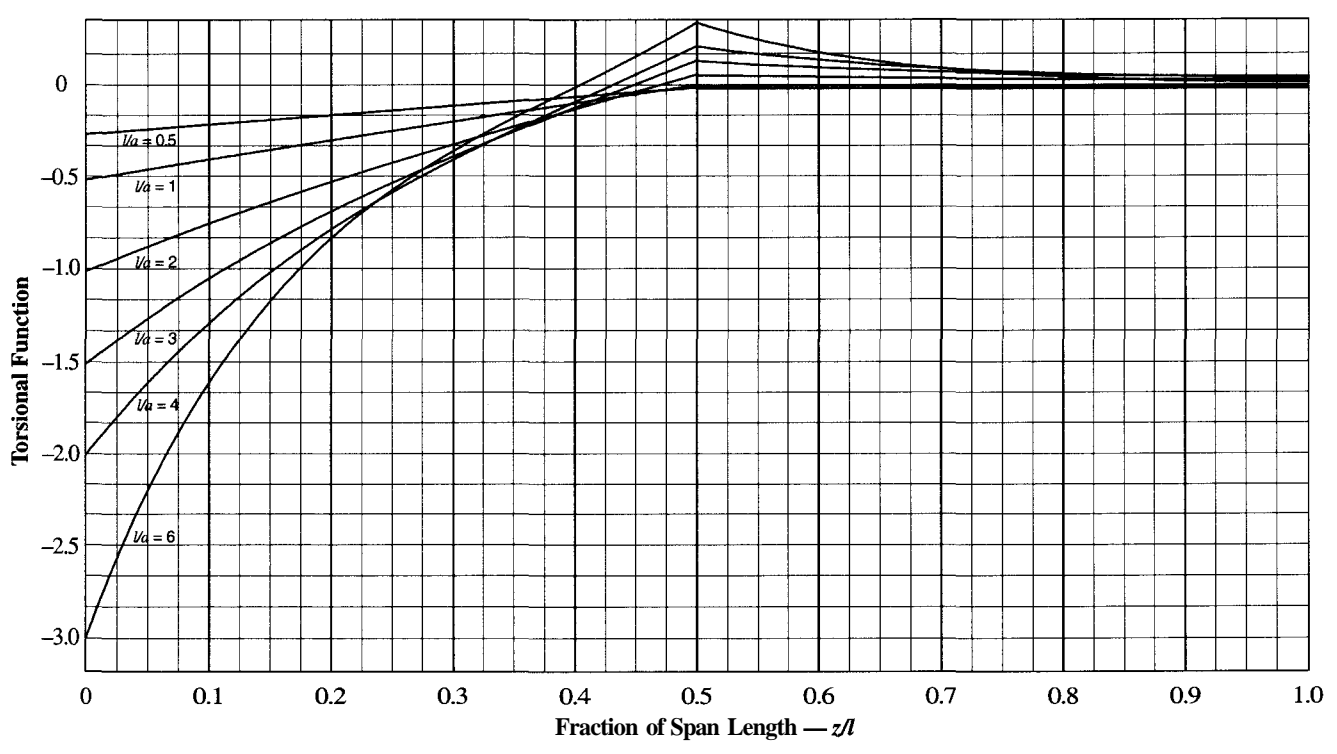

Case 10

$$\theta \times \left(\frac{GJ}{t} \times \frac{1}{a^2} \right)$$

$\alpha = 0.7$

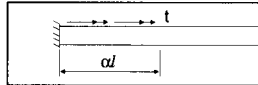

Torsional End Restraints			
Left End		Right End	
Fixed	$\theta = \theta' = 0$	Free	$\theta'' = 0$

Partial uniformly distributed torque along $\alpha = 0.7$ with fixed end and free end

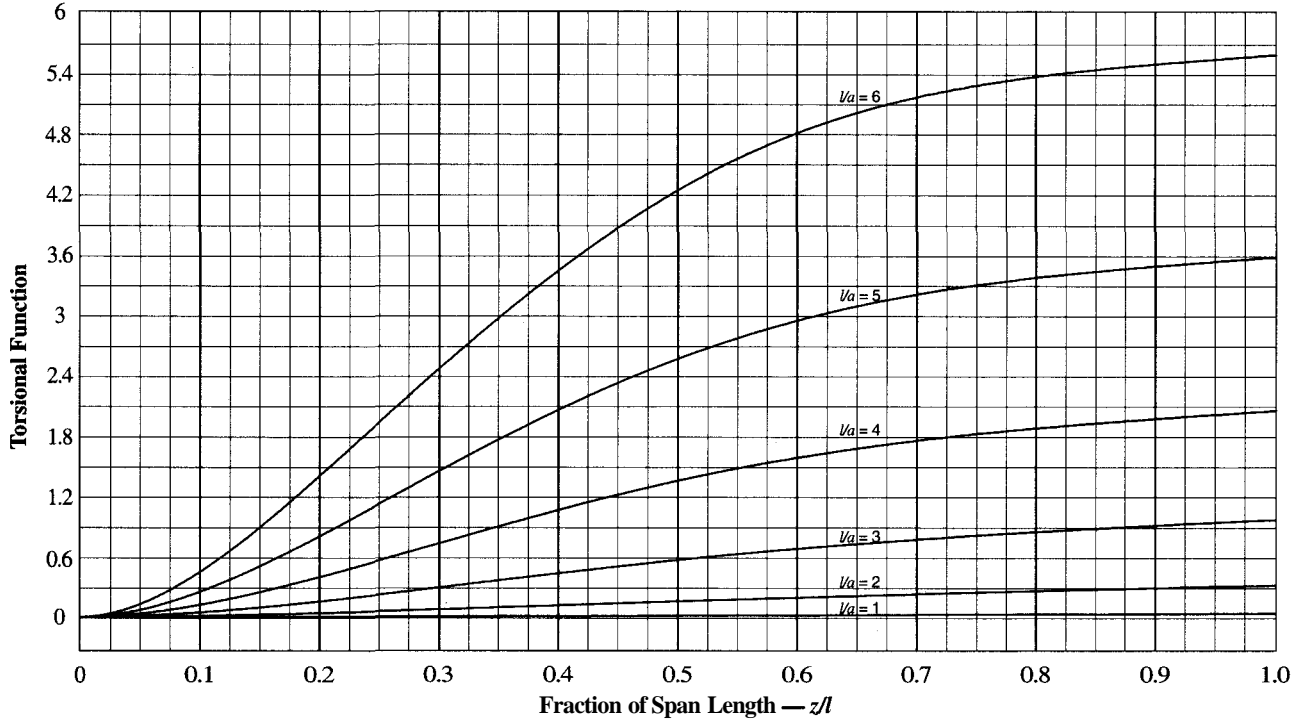

Case 10

$$\theta' \times \left(\frac{GJ}{t} \times \frac{1}{a} \right)$$

$\alpha = 0.7$

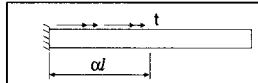

Torsional End Restraints			
Left End		Right End	
Fixed	$\theta = \theta' = 0$	Free	$\theta'' = 0$

Partial uniformly distributed torque along $\alpha = 0.7$ with fixed end and free end

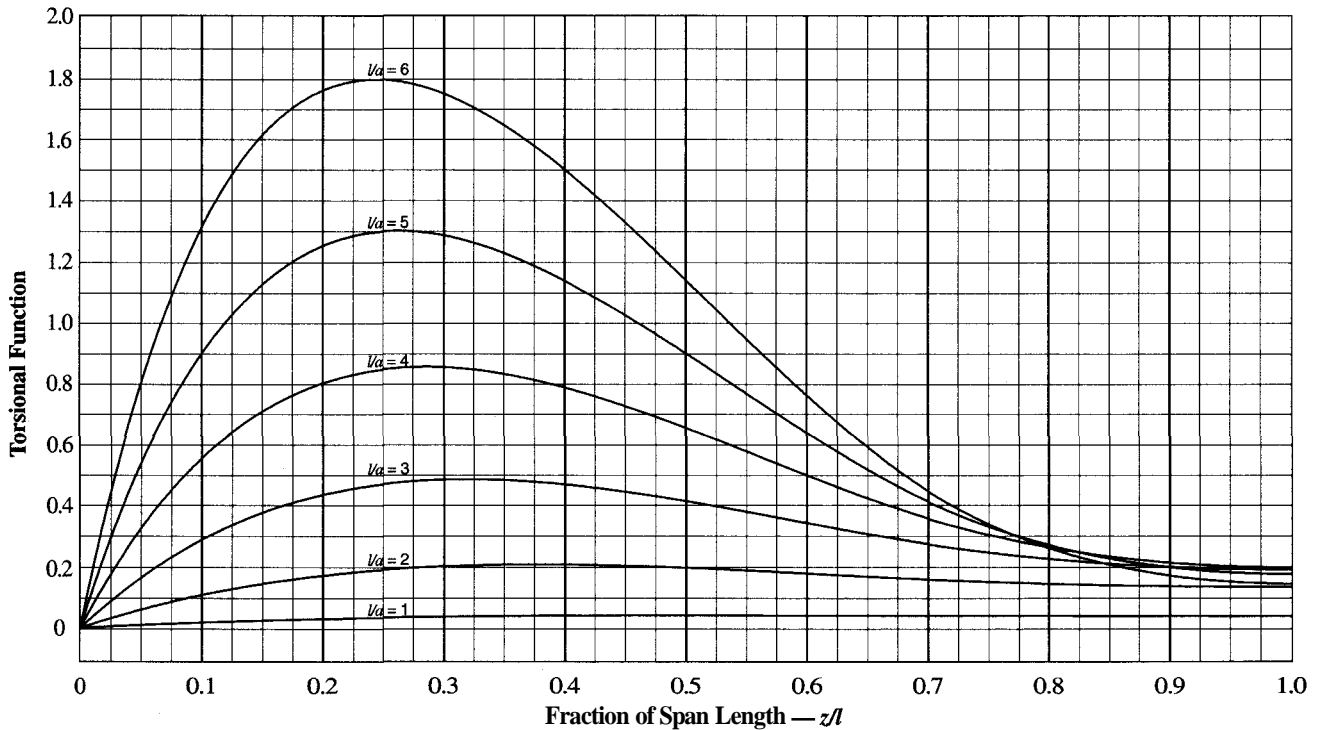

Case 10 $\theta'' \times \left(\frac{GJ}{t}\right)$
 $\alpha = 0.7$

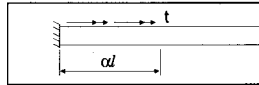

Torsional End Restraints			
Left End		Right End	
Fixed	$\theta = \theta' = 0$	Free	$\theta'' = 0$

Partial uniformly distributed torque along $\alpha = 0.7$ with fixed end and free end

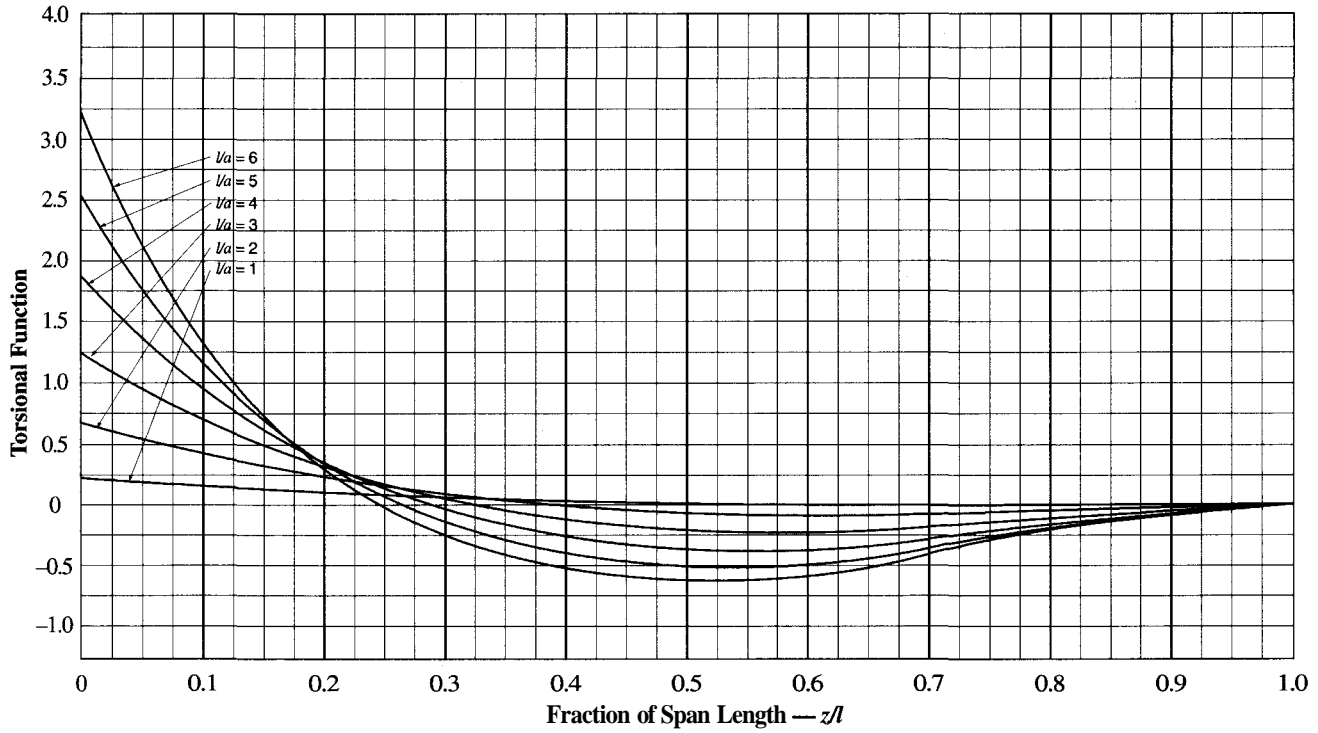

Case 10 $\theta''' \times \left(\frac{GJ}{t} \times a\right)$
 $\alpha = 0.7$

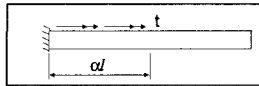

Torsional End Restraints			
Left End		Right End	
Fixed	$\theta = \theta' = 0$	Free	$\theta'' = 0$

Partial uniformly distributed torque along $\alpha = 0.7$ with fixed end and free end

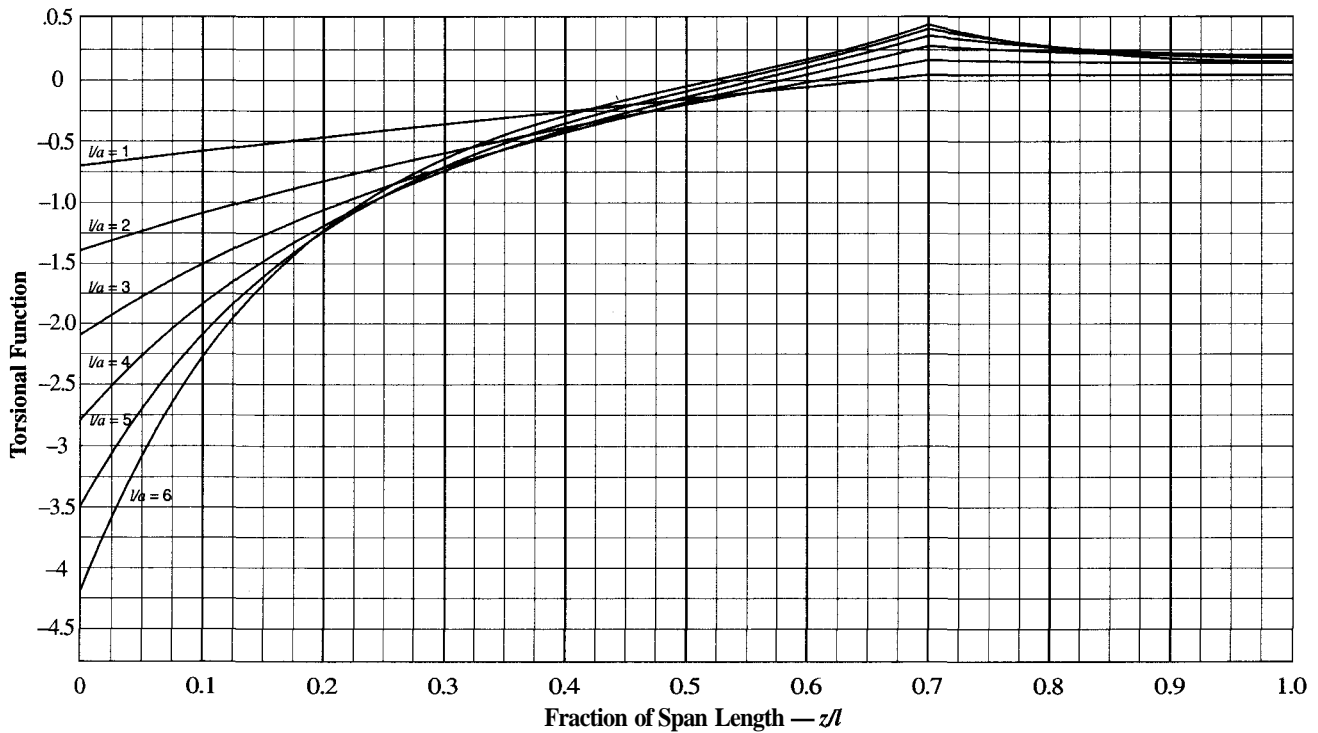

Case 10 $\theta \times \left(\frac{GJ}{t} \times \frac{1}{a^2} \right)$
 $\alpha = 0.9$

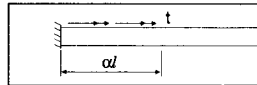

Torsional End Restraints	
Left End	Right End
Fixed $\theta = \theta' = 0$	Free $\theta'' = 0$

Partial uniformly distributed torque along $\alpha = 0.9$ with fixed end and free end

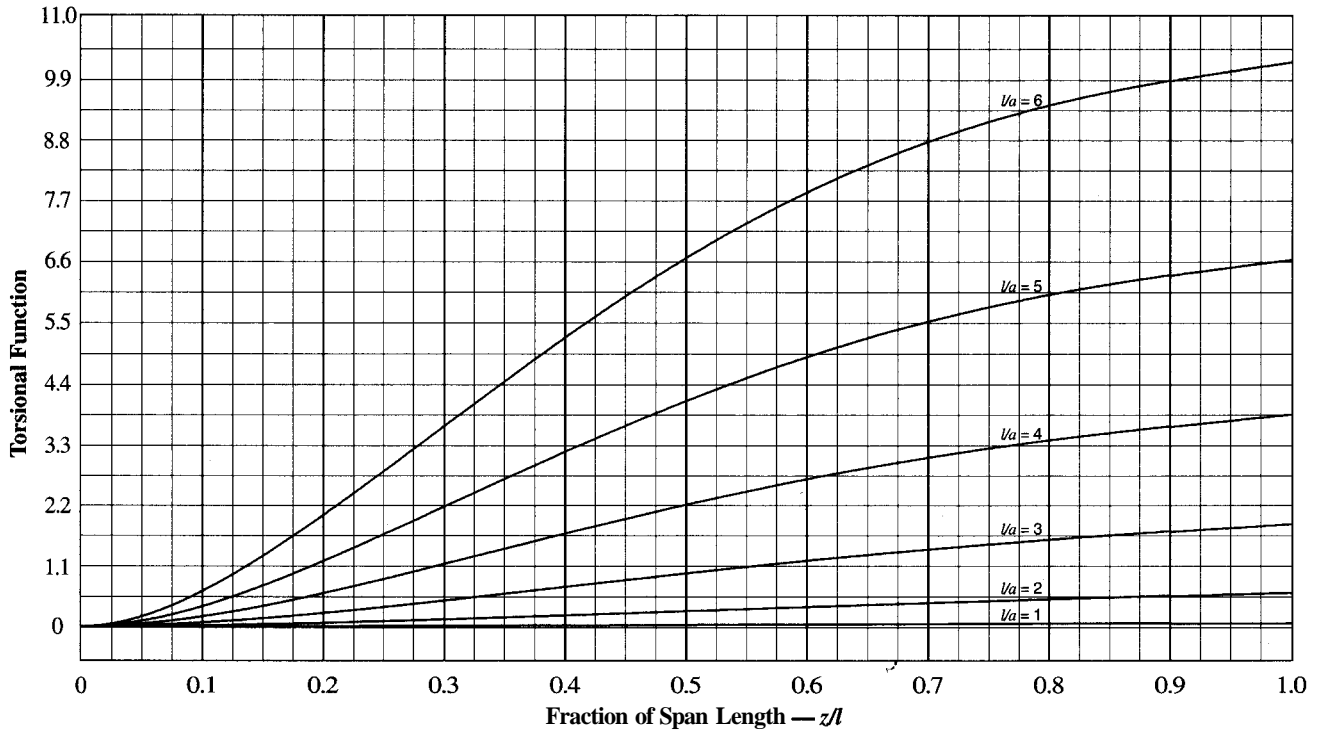

Case 10 $\theta' \times \left(\frac{GJ}{t} \times \frac{2}{a} \right)$
 $\alpha = 0.9$

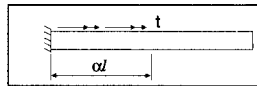

Torsional End Restraints	
Left End	Right End
Fixed $\theta = \theta' = 0$	Free $\theta'' = 0$

Partial uniformly distributed torque along $\alpha = 0.9$ with fixed end and free end

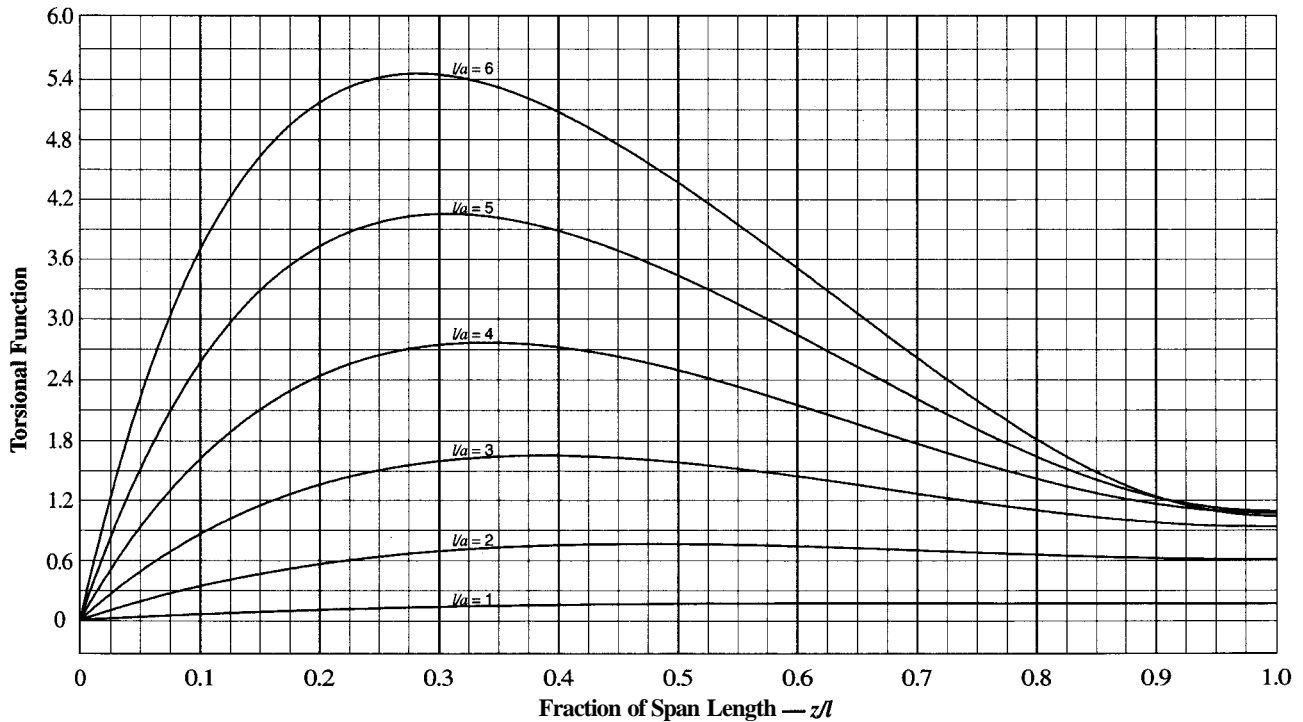

Case 10 $\theta'' \times \left(\frac{GJ}{t}\right)$
 $\alpha = 0.9$

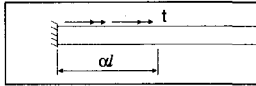

Torsional End Restraints	
Left End	Right End
Fixed $\theta = \theta' = 0$	Free $\theta'' = 0$

Partial uniformly distributed torque along $\alpha = 0.9$ with fixed end and free end

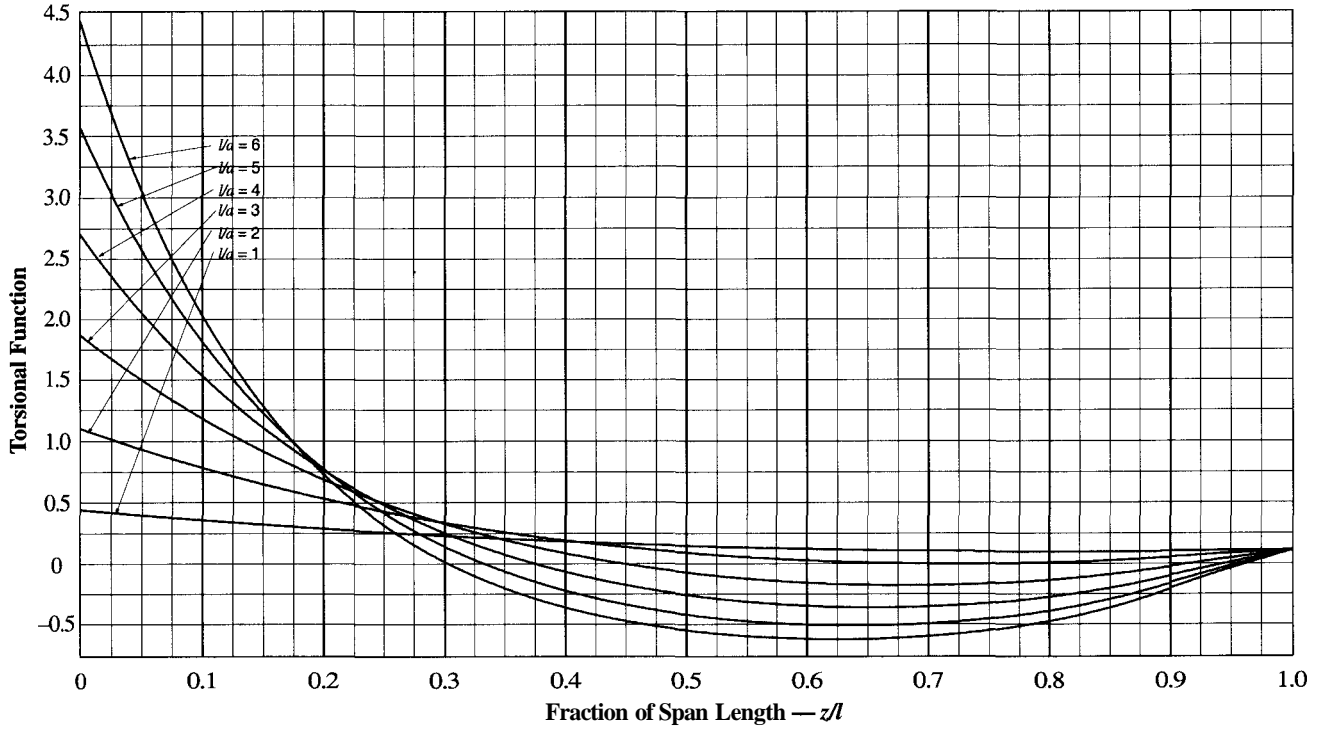

Case 10 $\theta''' \times \left(\frac{GJ}{t} \times a\right)$
 $\alpha = 0.9$

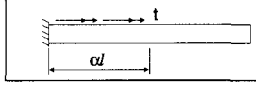

Torsional End Restraints	
Left End	Right End
Fixed $\theta = \theta' = 0$	Free $\theta'' = 0$

Partial uniformly distributed torque along $\alpha = 0.9$ with fixed end and free end

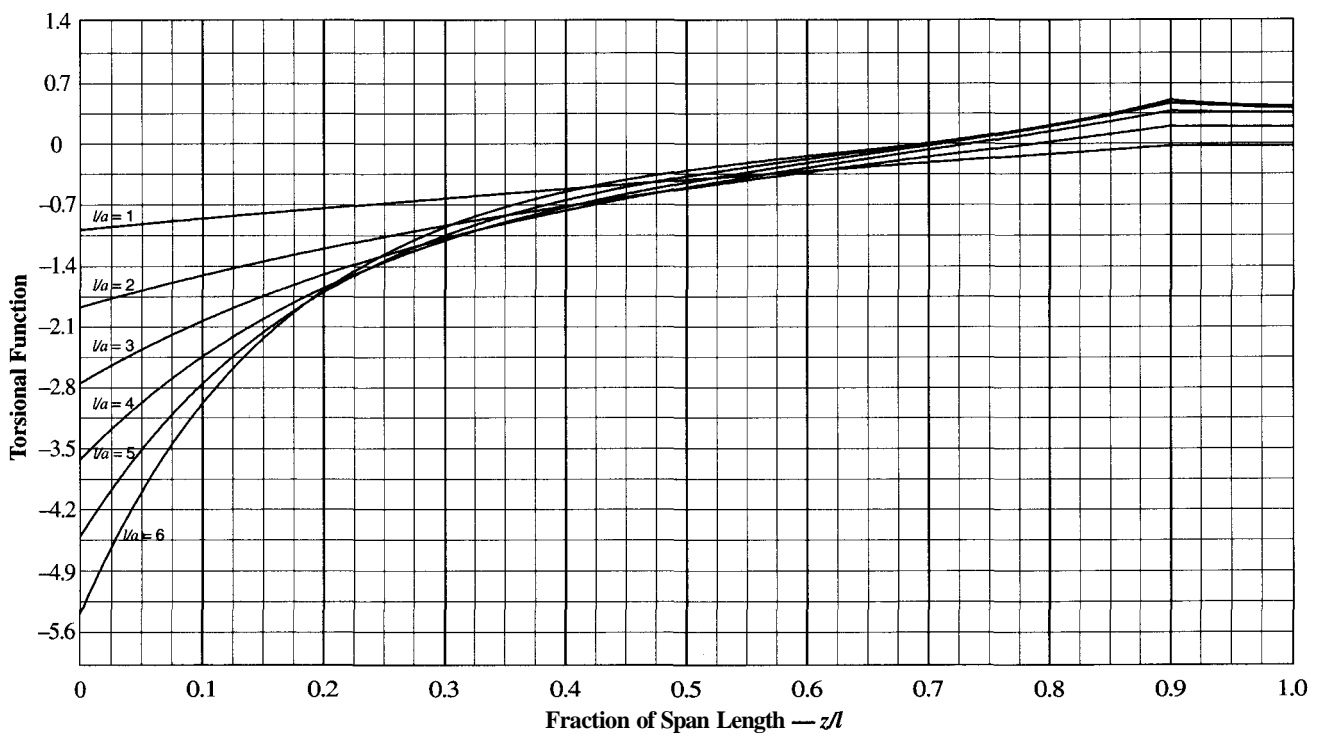

Case 10 $\theta \times \left(\frac{GJ}{t} \times \frac{1}{a^2} \right)$
 $\alpha = 1.0$

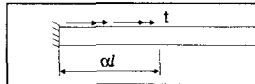

Torsional End Restraints	
Left End	Right End
Fixed $\theta = \theta' = 0$	Free $\theta'' = 0$

Partial uniformly distributed torque along $\alpha = 1.0$ with fixed end and free end

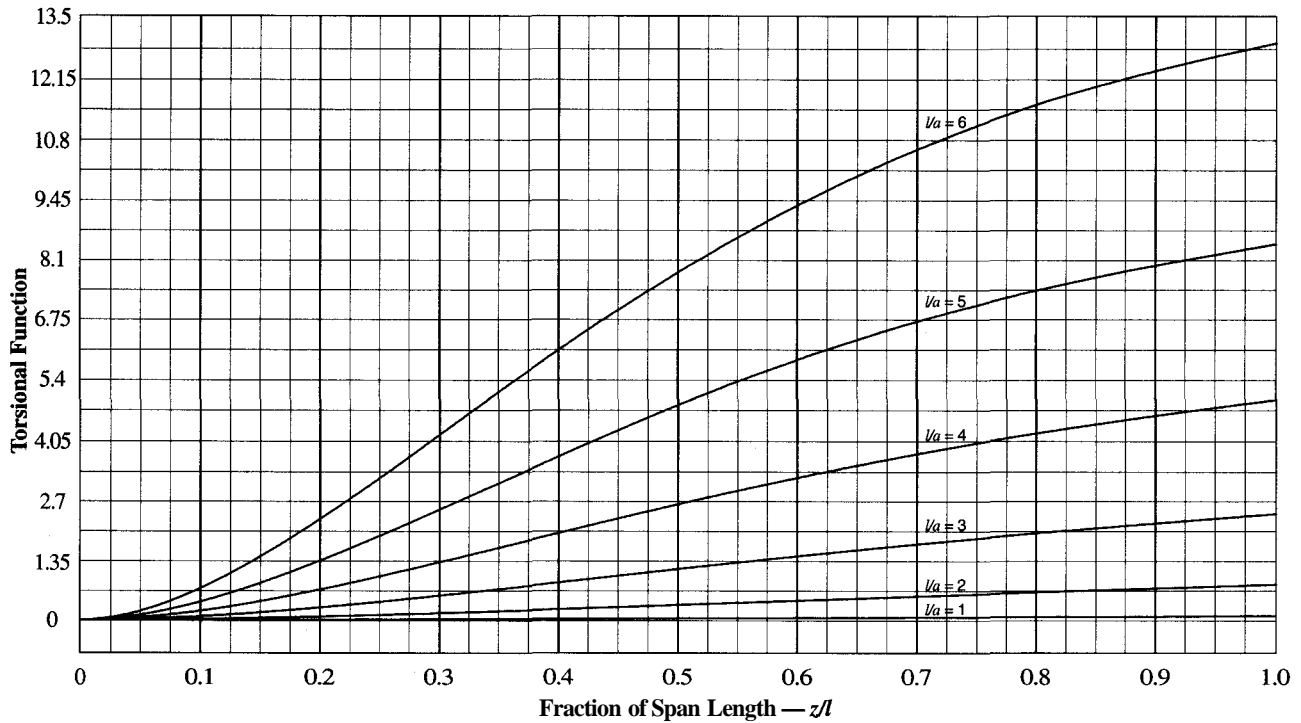

Case 10 $\theta' \times \left(\frac{GJ}{t} \times \frac{2}{a} \right)$
 $\alpha = 1.0$

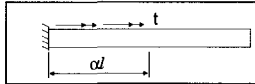

Torsional End Restraints	
Left End	Right End
Fixed $\theta = \theta' = 0$	Free $\theta'' = 0$

Partial uniformly distributed torque along $\alpha = 1.0$ with fixed end and free end

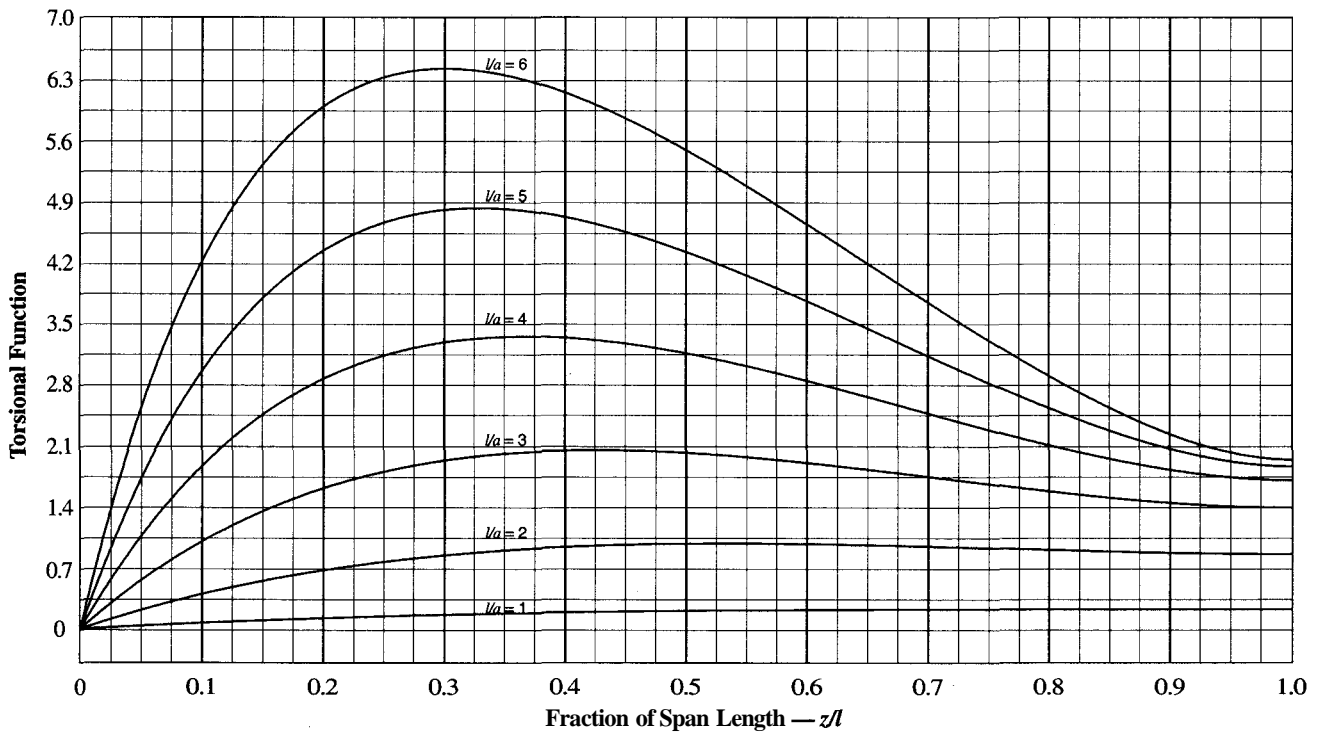

Case 10 $\theta'' \times \left(\frac{GJ}{t}\right)$
 $\alpha = 1.0$

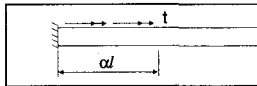

Torsional End Restraints	
Left End	Right End
Fixed $\theta = \theta' = 0$	Free $\theta'' = 0$

Partial uniformly distributed torque along $\alpha = 1.0$ with fixed end and free end

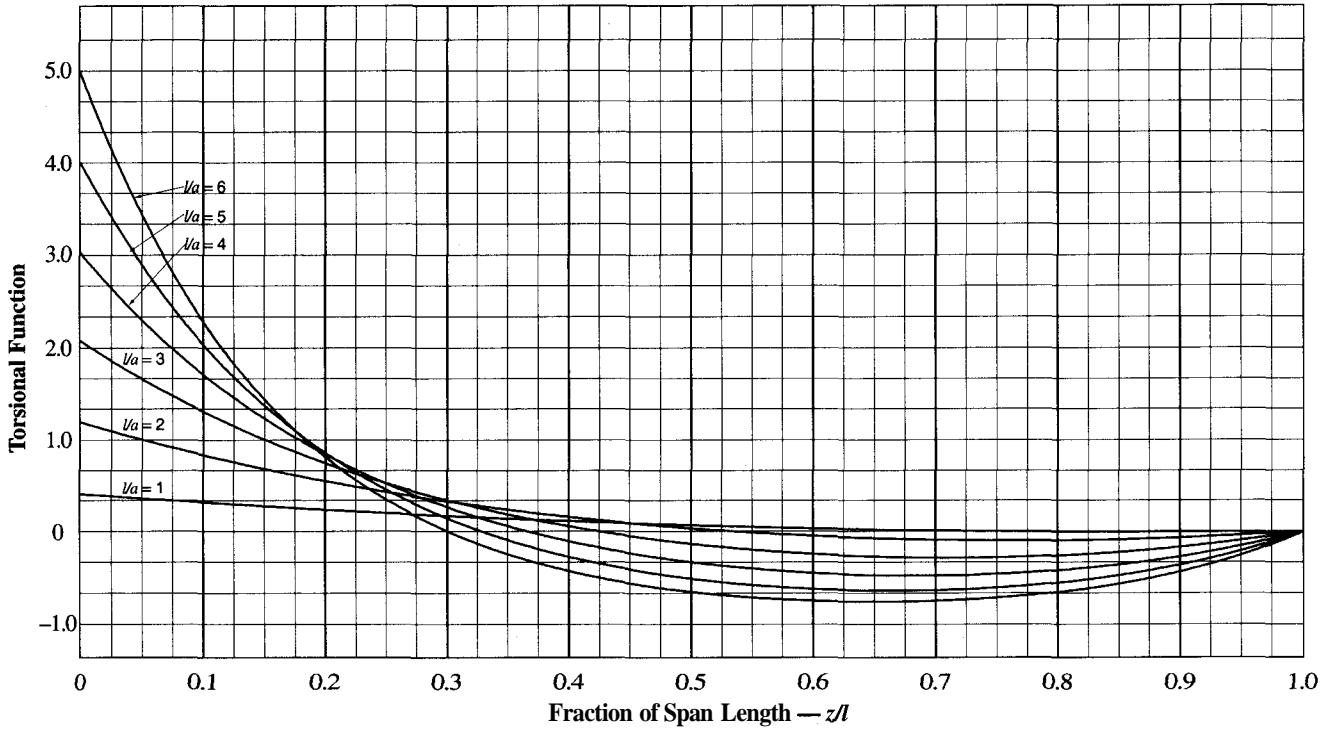

Case 10 $\theta''' \times \left(\frac{GJ}{t} \times a\right)$
 $\alpha = 1.0$

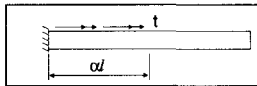

Torsional End Restraints	
Left End	Right End
Fixed $\theta = \theta' = 0$	Free $\theta'' = 0$

Partial uniformly distributed torque along $\alpha = 1.0$ with fixed end and free end

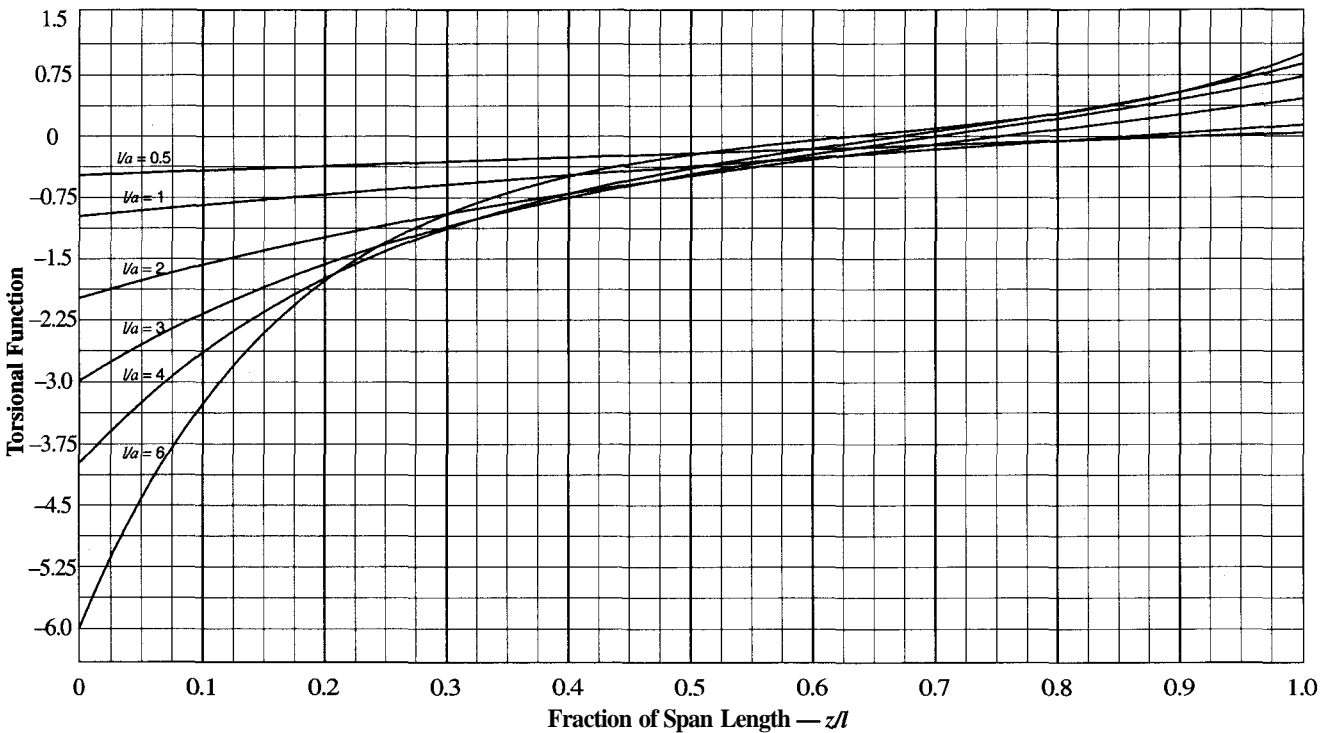

Case 11 $\theta \times \left(\frac{GJ}{t} \times \frac{1}{a^2} \right)$

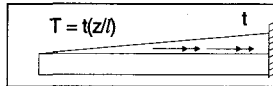

Torsional End Restraints			
Left End		Right End	
Free	$\theta'' = 0$	Fixed	$\theta = \theta' = 0$

Linearly varying torque on member with free and fixed ends

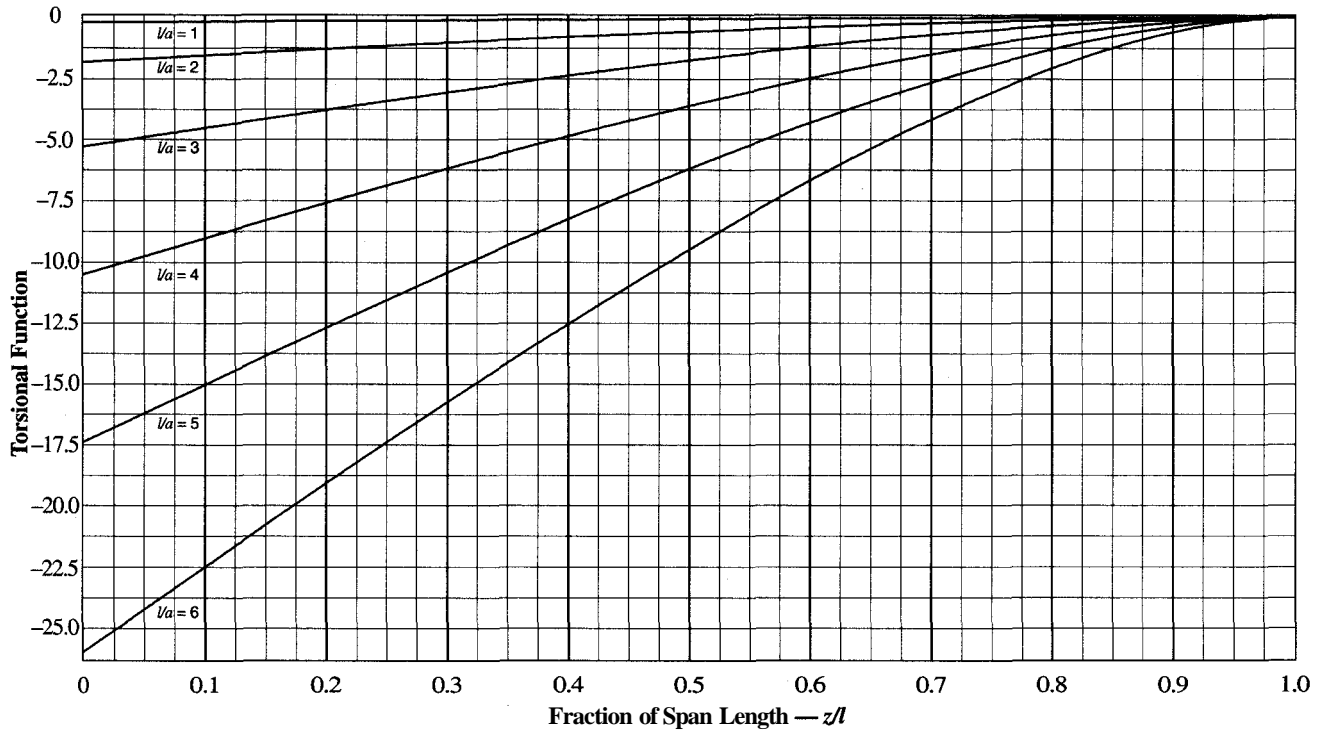

Case 11 $\theta' \times \left(\frac{GJ}{t} \times \frac{1}{a} \right)$

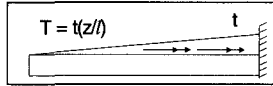

Torsional End Restraints			
Left End		Right End	
Free	$\theta'' = 0$	Fixed	$\theta = \theta' = 0$

Linearly varying torque on member with free and fixed ends

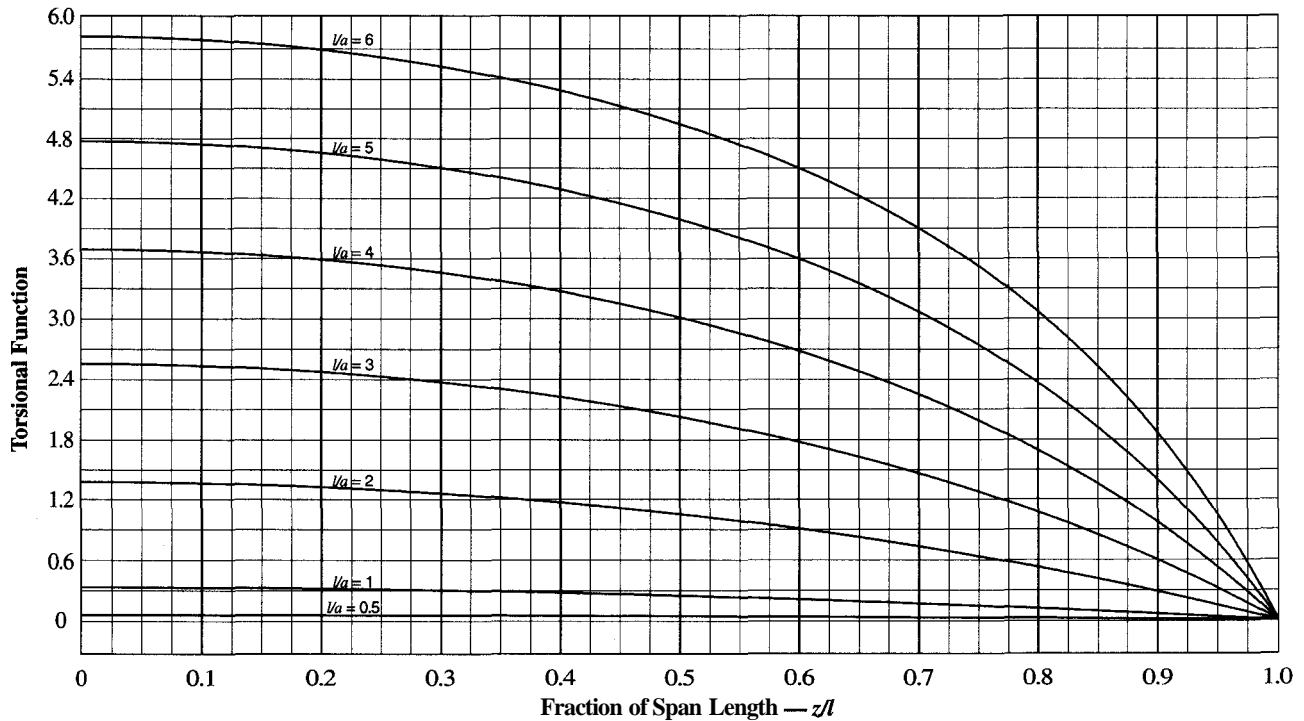

Case 11 $\theta'' \times \left(\frac{GJ}{t} \times 4\right)$

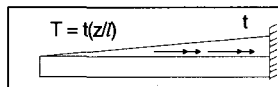

Torsional End Restraints			
Left End		Right End	
Free	$\theta'' = 0$	Fixed	$\theta = \theta' = 0$

Linearly varying torque on member with free and fixed ends

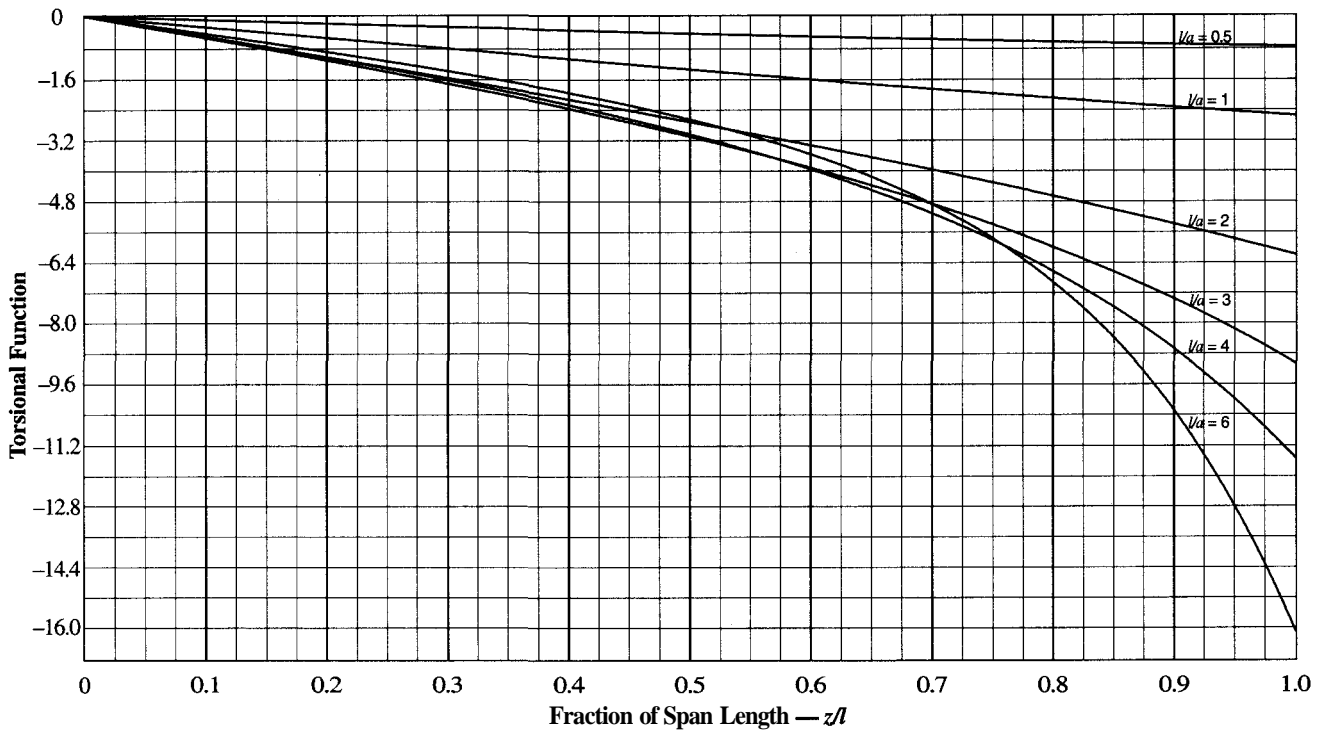

Case 11 $\theta''' \times \left(\frac{GJ}{t} \times 2a\right)$

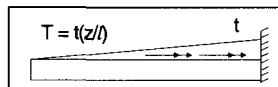

Torsional End Restraints			
Left End		Right End	
Free	$\theta'' = 0$	Fixed	$\theta = \theta' = 0$

Linearly varying torque on member with free and fixed ends

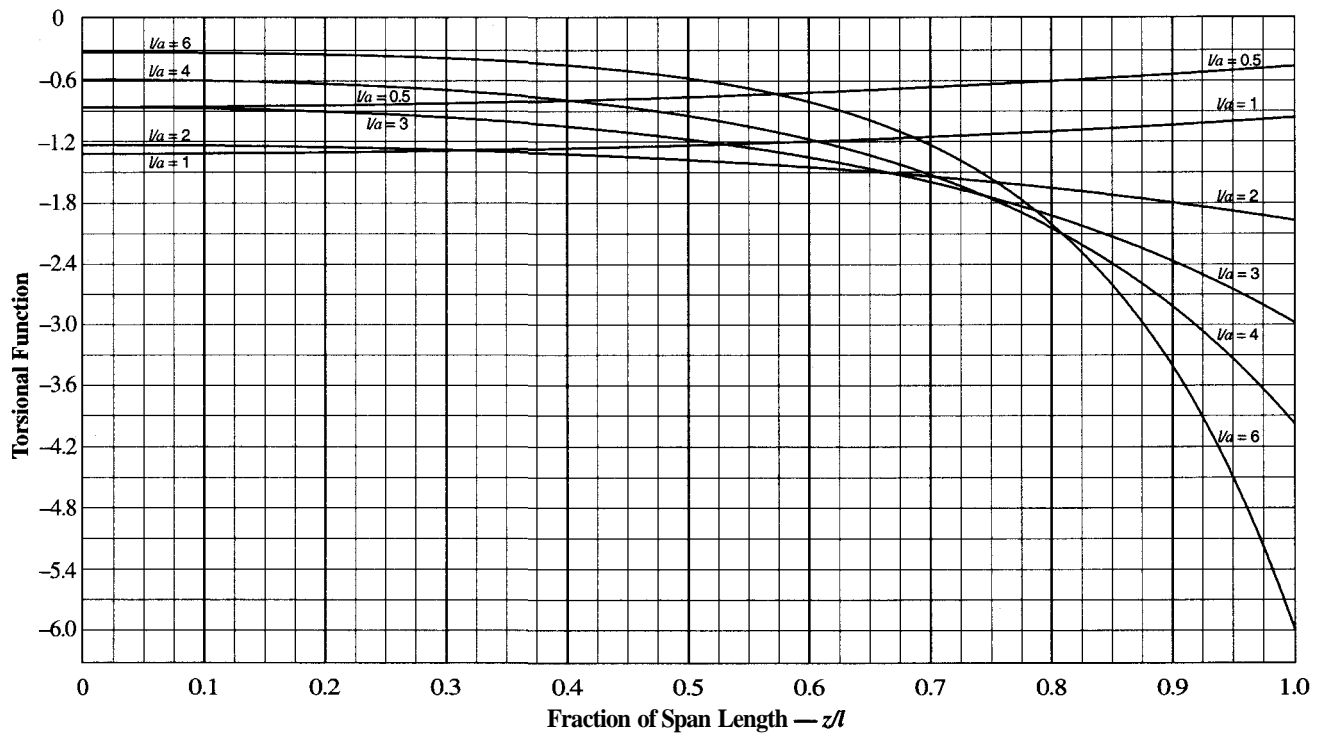

Case 12 $\theta \times \left(\frac{GJ}{t} \times \frac{1}{a^2} \right)$

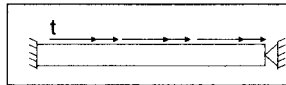

Torsional End Restraints	
Left End	Right End
Fixed $\theta = \theta' = 0$	Pinned $\theta = \theta'' = 0$

Uniformly distributed torque on member with fixed and pinned ends

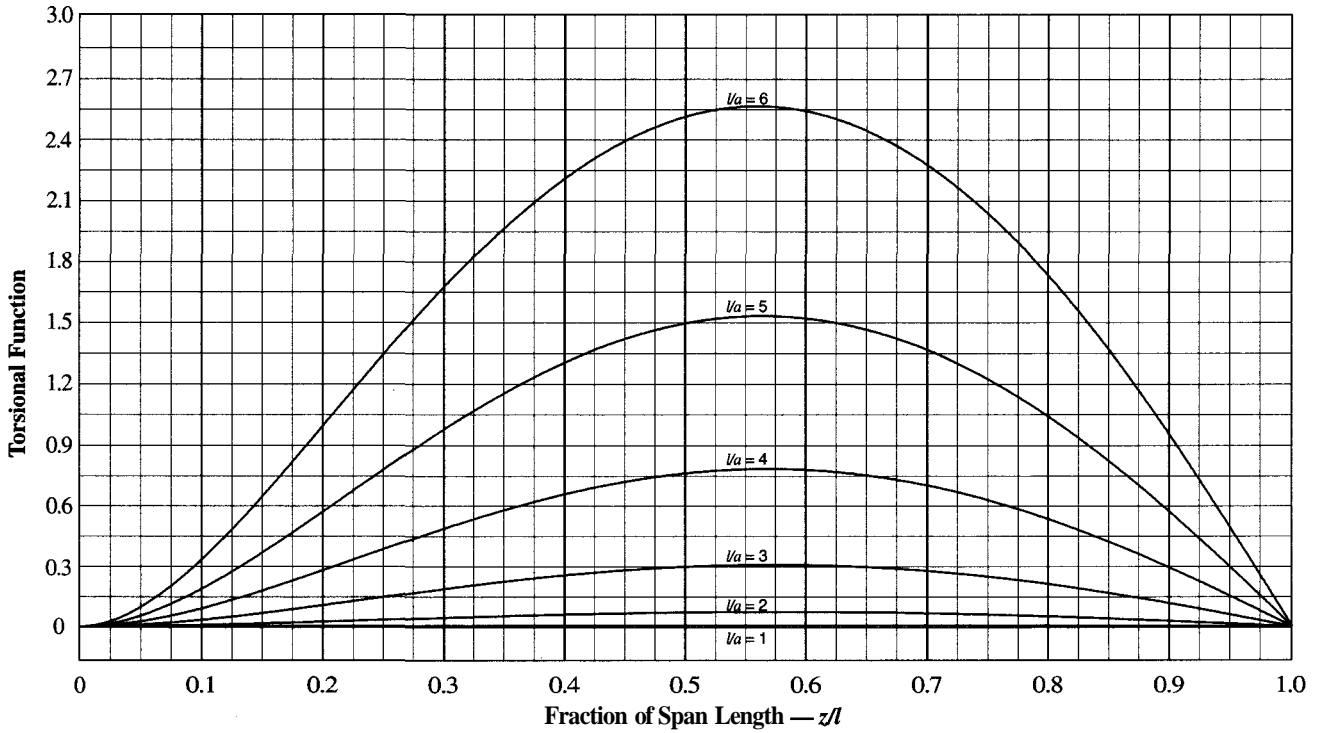

Case 12 $\theta' \times \left(\frac{GJ}{t} \times \frac{2}{a} \right)$

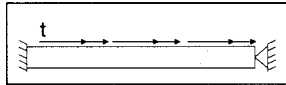

Torsional End Restraints	
Left End	Right End
Fixed $\theta = \theta' = 0$	Pinned $\theta = \theta'' = 0$

Uniformly distributed torque on member with fixed and pinned ends

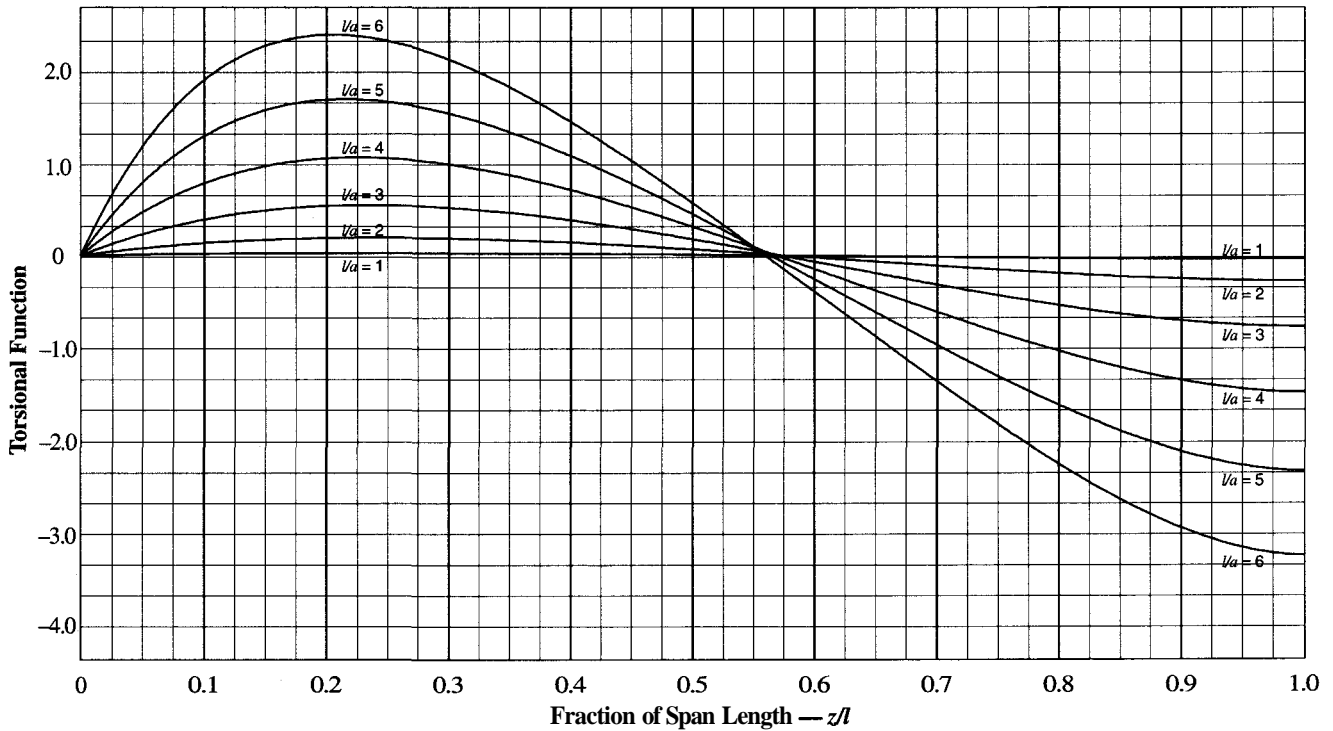

Case 12 $\theta'' \times \left(\frac{GJ}{t}\right)$

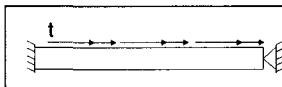

Torsional End Restraints	
Left End	Right End
Fixed $\theta = \theta' = 0$	Pinned $\theta = \theta'' = 0$

Uniformly distributed torque on member with fixed and pinned ends

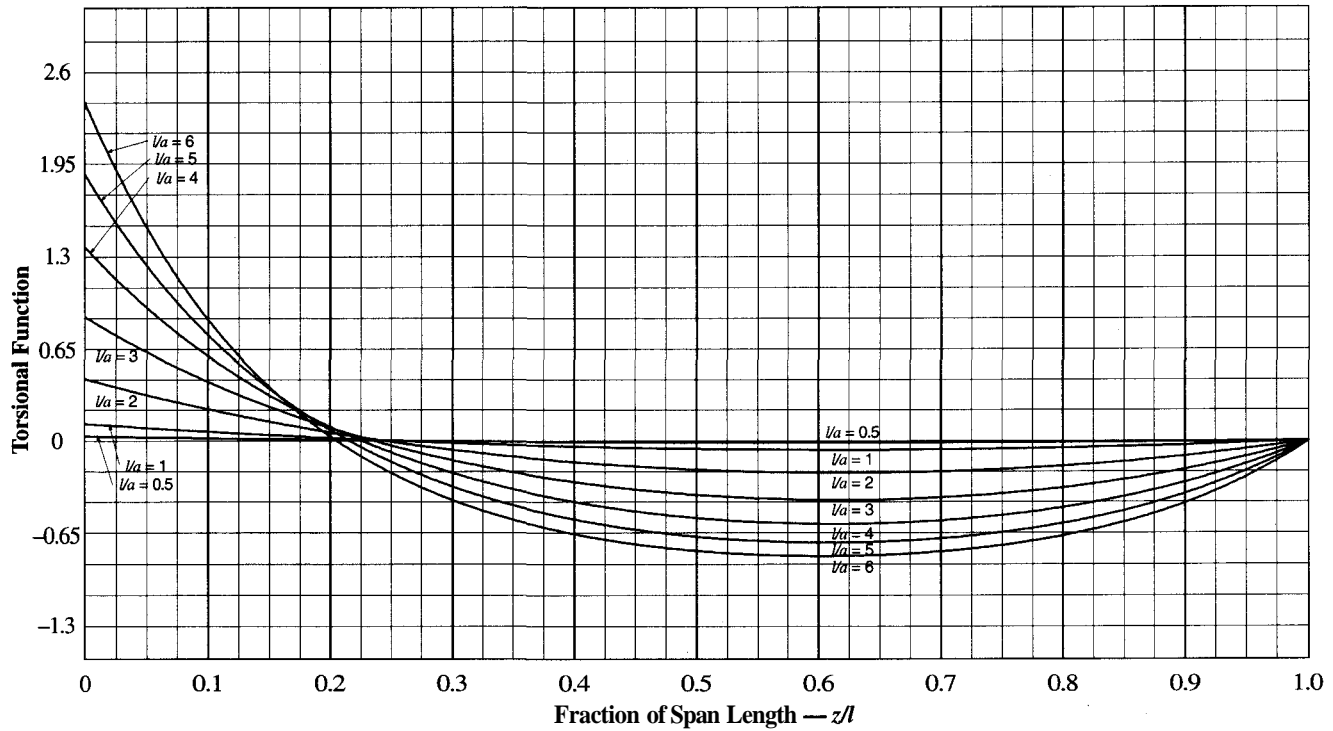

Case 12 $\theta''' \times \left(\frac{GJ}{t} \times a\right)$



Torsional End Restraints	
Left End	Right End
Fixed $\theta = \theta' = 0$	Pinned $\theta = \theta'' = 0$

Uniformly distributed torque on member with fixed and pinned ends

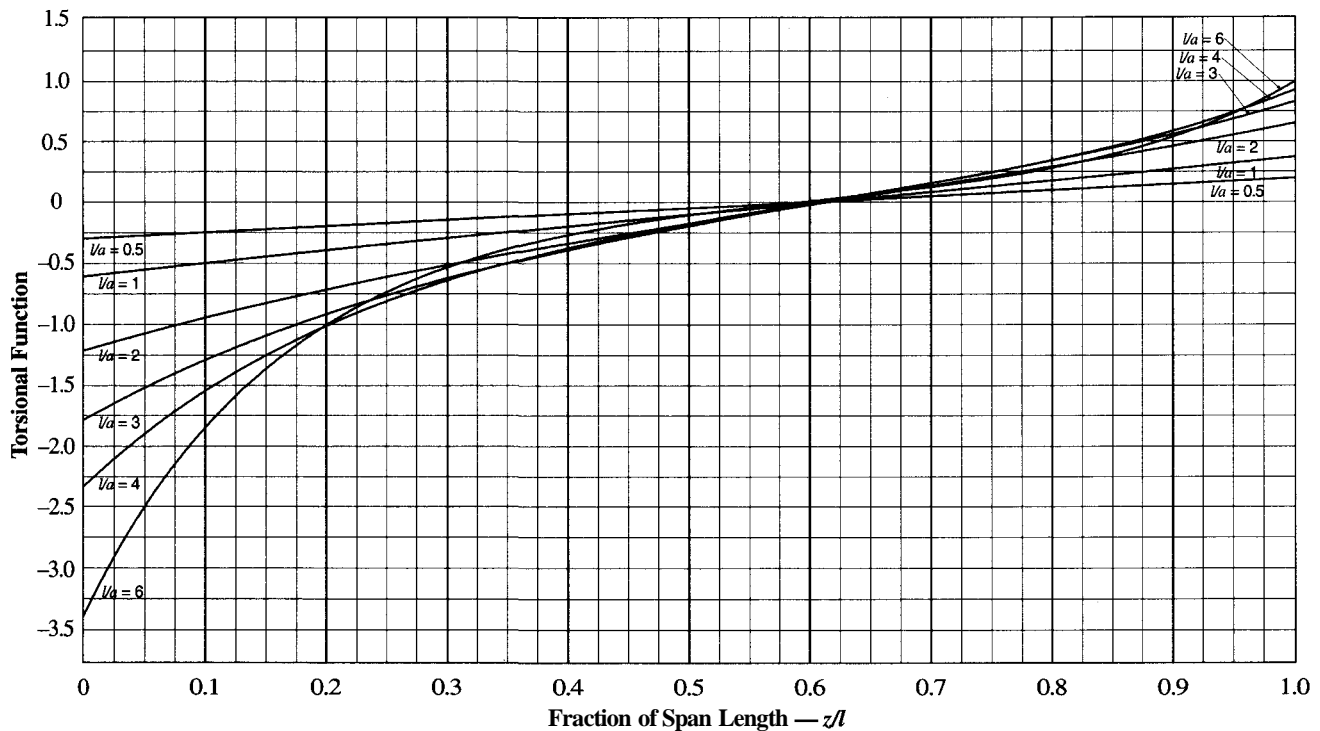

Appendix C

SUPPORTING INFORMATION

C.1 General Equations for θ and its Derivatives

Following are general equations for θ for a constant torsional moment, uniformly distributed torsional moment, and linearly varying torsional moment. They are developed from Equation 2.4 in Section 2.2.

C.1.1 Constant Torsional Moment

For a constant torsional moment T along a portion of the member as illustrated in Figure C.1a, the following equation may be developed:

$$\theta = A + Bz + C \cosh \frac{z}{a} + D \sinh \frac{z}{a} + \frac{Tz}{GJ} \quad (C.1)$$

where

- z = distance along Z-axis from left support, in.
- A, B, C = constants that are determined from boundary conditions

C.1.2 Uniformly Distributed Torsional Moment

A member subjected to a uniformly distributed torsional moment t is illustrated in Figure C.1b. For this case, examine a small segment of the member of length dz . By summation of torsional moments:

$$T + dT + t dz - T = 0 \quad (C.2)$$

or

$$\frac{dT}{dz} = -t \quad (C.3)$$

Differentiating Equation 2.4 and substituting the above yields:

$$\frac{-t}{EC_w I} = \frac{\theta''}{a^2} - \theta'''' \quad (C.4)$$

which may be solved as:

$$\theta = A + Bz + C \cosh \frac{z}{a} + D \sinh \frac{z}{a} - \frac{tz^2}{2GJ} \quad (C.5)$$

C.1.3 Linearly Varying Torsional Moment

For a member subjected to a linearly varying torsional moment as illustrated in Figure C.1c, again examine a small element of the member length dz . Summing the torsional moments:

$$T + dT + \frac{tz}{l} dz - T = 0 \quad (C.6)$$

or

$$\frac{dT}{dz} = -\frac{tz}{l} \quad (C.7)$$

Differentiating Equation 2.4 and substituting the above yields:

$$\frac{-tz}{EC_w I} = \frac{\theta''}{a^2} - \theta'''' \quad (C.8)$$

which may be solved as:

$$\theta = A + Bz + C \cosh \frac{z}{a} + D \sinh \frac{z}{a} - \frac{tz^2}{6GJ} \quad (C.9)$$

C.2. Boundary Conditions

The general equations contain constants that are evaluated for specific cases by imposing the appropriate boundary conditions. These conditions specify mathematically the physical restraints at the ends of the member. They are summarized as follows:

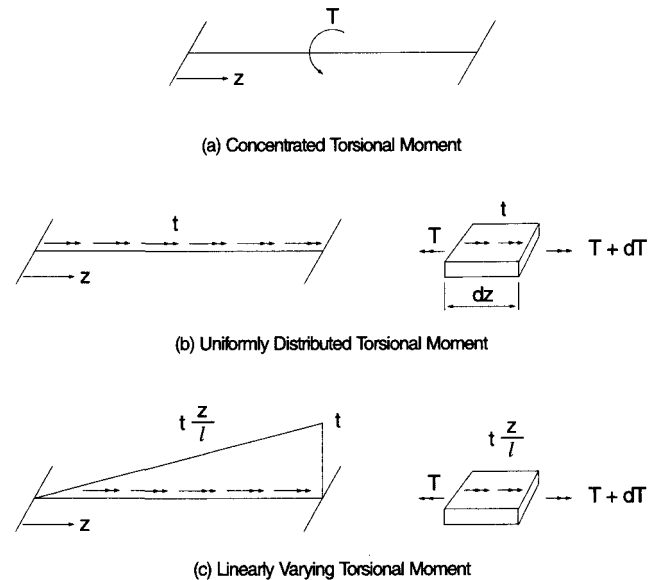

Figure C.1.

Physical Condition	Torsional End Condition	Mathematical Condition
No rotation	Fixed or Pinned	$\theta = 0$
Cross-section cannot warp	Fixed end	$\theta' = 0$
Cross-section can warp freely	Pinned or Free	$\theta'' = 0$

Additionally, the following conditions must be satisfied at a support over which the member is continuous or at a point of applied torsional moment:

$$\theta_{left} = \theta_{right} \quad (C.10)$$

$$\theta'_{left} = \theta'_{right} \quad (C.11)$$

$$\theta''_{left} = \theta''_{right} \quad (C.12)$$

In all solutions in Appendix C, ideal end conditions have been assumed, i.e., free, fixed, or pinned. Where these conditions do not apply, a more advanced analysis may be necessary.

A torsionally fixed end (full warping restraint) is more difficult to achieve than a flexurally fixed end. If the span is one of several for a continuous beam, with each span similarly loaded, there is inherent fixity for flexure and flange warping. If however, the beam is an isolated span, Ojalvo (1975) demonstrated that a closed box made up of several plates or a channel, as illustrated in Figure C.2, would approximate a torsionally fixed end. Simply welding to an end-plate or column flange may not provide sufficient restraint.

C.3. Evaluation of Torsional Properties

Following are the general solutions for the torsional properties given in Chapter 3 and more accurate equations for the torsional constant J for I-shapes, channels, and Z-shapes.

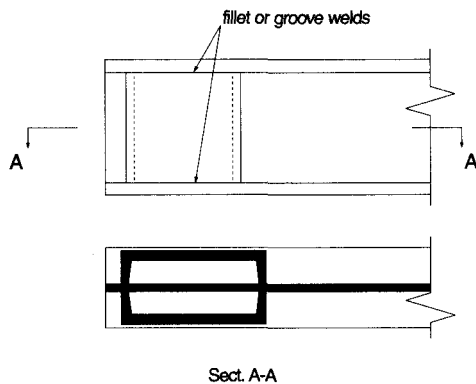

Figure C.2.

C.3.1 General Solution

Referring to the general cross-section and notation in Figure C.3, the torsional properties may be expressed as follows:

$$J = \frac{1}{3} \int_0^b t^3 ds \quad (C.13)$$

$$W_{ns} = \frac{1}{A} \int_0^b W_{os} t ds - W_{os} \quad (C.14)$$

where

$$A = \int_0^b t ds \quad (C.15)$$

$$W_{os} = \int_0^s \rho_o ds \quad (C.16)$$

$$S_{ws} = \int_0^s t ds \quad (C.17)$$

$$C_w = \int_0^b W_{ns}^2 t ds \quad (C.18)$$

C.3.2 Torsional Constant J for Open Cross-Sections

The following equations for J provide a more accurate value than the simple approximation given previously. For I-shapes with parallel-sided flanges as illustrated in Figure C.4a:

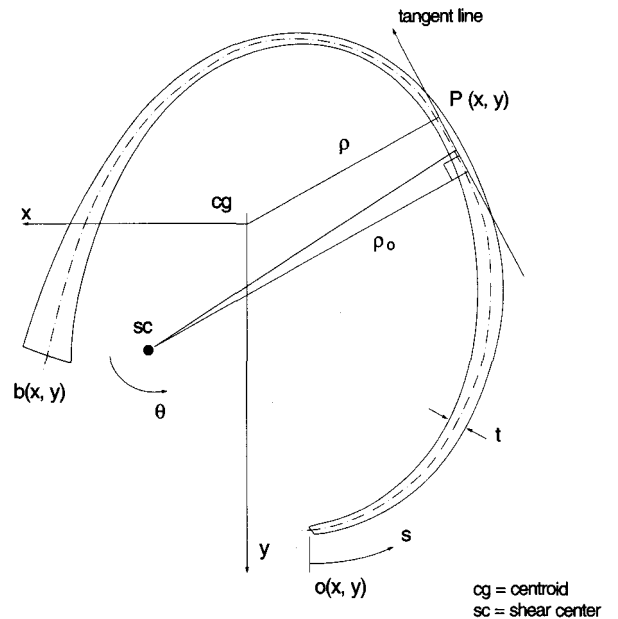

Note: All directions are shown positive; ρ and ρ_o are positive if they are on the left side of an observer at $P(x, y)$ facing the positive direction of s .

Figure C.3.

$$J = \frac{2b_f t_f^3}{3} + \frac{t_w^3(d-2t_f)}{3} + 2\alpha_1 D_1^4 - 0.420 t_f^4 \quad (C.19)$$

where

$$\alpha_1 = -0.0420 + 0.220 \frac{t_w}{t_f} + 0.136 \frac{R}{t_f} - 0.0865 \frac{t_w R}{t_f^2} - 0.0725 \frac{t_w^2}{t_f^2} \quad (C.20)$$

$$D_1 = \frac{(t_f + R)^2 + t_w \left(R + \frac{t_w}{4} \right)}{2R + t_f} \quad (C.21)$$

For I-shapes with sloping-sided flanges as illustrated in Figure C.4b:

$$J = \frac{(b_f - t_w)(t_1 + t_2)(t_1^2 + t_2^2)}{6} + \frac{2t_w t_2^3}{3} + \frac{(d - 2t_2)t_w^3}{3} + 2\alpha_2 D_2^4 - 4V_s t_1^4 \quad (C.22)$$

where for I-shapes with flange slopes of 16 $\frac{2}{3}$ percent only:

$$\alpha_2 = -0.0836 + 0.254 \frac{t_w}{t_2} + 0.127 \frac{R}{t_2} - 0.0806 \frac{t_w R}{t_2^2} - 0.0858 \frac{t_w^2}{t_2^2} \quad (C.23)$$

For flange slopes other than 16 $\frac{2}{3}$ percent, the value of α_2 may be found by linear interpolation between α_2 and α_1 as given above for parallel-sided flanges:

$$D_2 = \frac{(F + m)^2 + t_w \left(R + \frac{t_w}{4} \right)}{F + R + m} \quad (C.24)$$

$$F = RS \left(\sqrt{\frac{1}{S^2} + 1} - 1 - \frac{t_w}{2R} \right) \quad (C.25)$$

$$S = \frac{2(m - t_1)}{b_f} \quad (C.26)$$

$$V_s = 0.105 + 0.100S + 0.0848S^2 + 0.0675S^3 + 0.0515S^4 \quad (C.27)$$

For channels as illustrated in Figure C.4c:

$$J = \frac{(b_f - t_w)(t_1 + t_2)(t_1^2 + t_2^2)}{6} + \frac{2t_w t_2^3}{3} + \frac{(d - 2t_2)t_w^3}{3} + 2\alpha_4 D_4^4 - 2V_s t_1^4 - 0.210 t_2^4 \quad (C.28)$$

where for channels with flange slopes of 16 $\frac{2}{3}$ percent only:

$$\alpha_4 = -0.133 + 0.302 \frac{t_w}{t_2} + 0.140 \frac{R}{t_2} - 0.107 \frac{t_w R}{t_2^2} - 0.0956 \frac{t_w^2}{t_2^2} \quad (C.29)$$

For flange slopes other than 16 $\frac{2}{3}$ percent, the value of α_4 may be found by linear interpolation between α_4 as given above and α_4' as given below for parallel-sided flanges:

$$\alpha_4' = -0.0908 + 0.262 \frac{t_w}{t_2} + 0.123 \frac{R}{t_2} - 0.0752 \frac{t_w R}{t_2^2} - 0.0945 \frac{t_w^2}{t_2^2} \quad (C.30)$$

$$D_4 = 2 \left[(3R + t_w + H) - \sqrt{2(2R + t_w)(2R + H)} \right] \quad (C.31)$$

$$H = t_2 - R(S + 1 - \sqrt{1 + S}) \quad (C.32)$$

$$S = \frac{t_2 - t_1}{b_f - t_w} \quad (C.33)$$

$$V_s = 0.105 + 0.100S + 0.0848S^2 + 0.0675S^3 + 0.0515S^4 \quad (C.34)$$

For Z-shapes with parallel-sided flanges as illustrated in Figure C.4d:

$$J = \frac{2b_f t_f^3}{3} + \frac{t_w^3(d-2t_f)}{3} + 2\alpha_3 D_3^4 - 0.420 t_f^4 \quad (C.35)$$

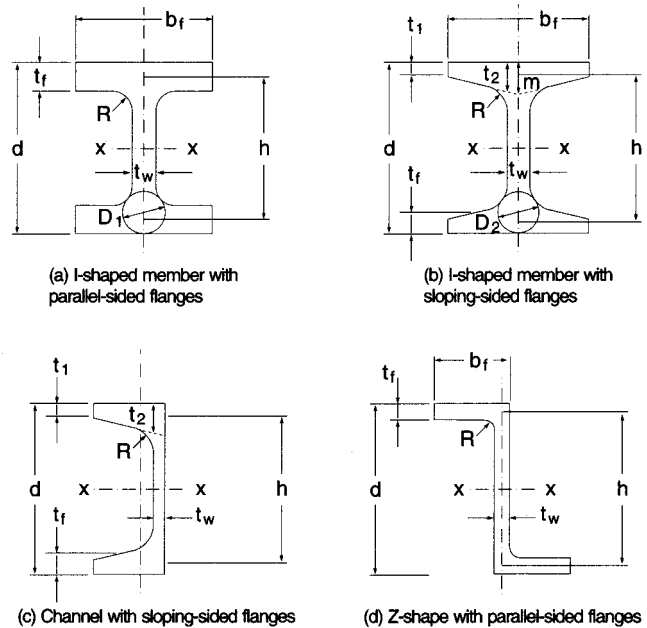

Figure C.4.

where

$$\alpha_3 = -0.0908 + 0.262 \frac{t_w}{t_f} + 0.123 \frac{R}{t_f} - 0.0752 \frac{t_w R}{t_f^2} - 0.0945 \frac{t_w^2}{t_f^2} \quad (\text{C.36})$$

$$D_3 = 2 \left[(3R + t_w + t_f) - \sqrt{2(2R + t_w)(2R + t_f)} \right] \quad (\text{C.37})$$

C.4 Solutions to Differential Equations for Cases in Appendix B

Following are the solutions of the differential equations using the proper boundary conditions. Take derivatives of θ to find θ' , θ'' , and θ''' .

Case	θ
1	$\theta = \frac{Tz}{GJ}$
2	$\theta = \frac{Ta}{GJ} \left(\tanh \frac{l}{2a} \times \cosh \frac{z}{a} - \tanh \frac{l}{2a} + \frac{z}{a} - \sinh \frac{z}{a} \right)$
3	$0 \leq z \leq \alpha l$ $\theta = \frac{Tl}{GJ} \left[(1.0 - \alpha) \frac{z}{l} + \frac{a}{l} \left(\frac{\sinh \frac{\alpha l}{a}}{\tanh \frac{l}{a}} - \cosh \frac{\alpha l}{a} \right) \times \sinh \frac{z}{a} \right]$ $\alpha l \leq z \leq l$ $\theta = \frac{Tl}{GJ} \left[(l - z) \frac{\alpha}{l} + \frac{a}{l} \left(\frac{\sinh \frac{\alpha l}{a}}{\tanh \frac{l}{a}} \times \sinh \frac{z}{a} - \sinh \frac{\alpha l}{a} \times \cosh \frac{z}{a} \right) \right]$
4	$\theta = \frac{ta^2}{GJ} \left[\frac{l^2}{2a^2} \left(\frac{z}{l} - \frac{z^2}{l^2} \right) + \cosh \frac{z}{a} - \tanh \frac{l}{2a} \times \sinh \frac{z}{a} - 1.0 \right]$
5	$\theta = \frac{tl^2}{GJ} \left[\frac{z}{6l} + \frac{a^2}{l^2} \left(\frac{\sinh \frac{z}{a}}{\sinh \frac{l}{a}} - \frac{z}{l} \right) - \frac{z^3}{6l^3} \right]$

Case	θ
6	<p>$0 \leq z \leq \alpha l$</p> $\theta = \frac{Ta}{(H+1)GJ} \left\{ H \times \left(\frac{1}{\sinh \frac{l}{a}} + \sinh \frac{\alpha l}{a} - \frac{\cosh \frac{\alpha l}{a}}{\tanh \frac{l}{a}} \right) + \left(\sinh \frac{\alpha l}{a} - \frac{\cosh \frac{\alpha l}{a}}{\tanh \frac{l}{a}} + \frac{1}{\tanh \frac{l}{a}} \right) \times \left[\cosh \frac{z}{a} - 1.0 \right] - \sinh \frac{z}{a} + \frac{z}{a} \right\}$ <p>$\alpha l \leq z \leq l$</p> $\theta = \frac{Ta}{\left(1 + \frac{1}{H}\right)GJ} \left\{ \left[\frac{\left(\cosh \frac{\alpha l}{a} - 1.0\right)}{H \times \sinh \frac{l}{a}} + \frac{\left(\cosh \frac{\alpha l}{a} - \cosh \frac{l}{a} + \frac{l}{a} \times \sinh \frac{l}{a}\right)}{\sinh \frac{l}{a}} \right] + \cosh \frac{z}{a} \left[\frac{\left(1.0 - \cosh \frac{\alpha l}{a}\right)}{H \times \tanh \frac{l}{a}} + \frac{\left(1.0 - \cosh \frac{\alpha l}{a} \times \cosh \frac{l}{a}\right)}{\sinh \frac{l}{a}} \right] + \sinh \frac{z}{a} \left[\frac{\left(\cosh \frac{\alpha l}{a} - 1.0\right)}{H} + \cosh \frac{\alpha l}{a} \right] - \frac{z}{a} \right\}$ <p>where:</p> $H = \frac{\left[\frac{\left(1.0 - \cosh \frac{\alpha l}{a}\right)}{\tanh \frac{l}{a}} + \frac{\left(\cosh \frac{\alpha l}{a} - 1.0\right)}{\sinh \frac{l}{a}} + \sinh \frac{\alpha l}{a} - \frac{\alpha l}{a} \right]}{\left[\frac{\left(\cosh \frac{l}{a} + \cosh \frac{\alpha l}{a} \times \cosh \frac{l}{a} - \cosh \frac{\alpha l}{a} - 1.0\right)}{\sinh \frac{l}{a}} + \frac{l}{a}(\alpha - 1.0) - \sinh \frac{\alpha l}{a} \right]}$
7	$\theta = \frac{tla}{2GJ} \left[\frac{\left(1 + \cosh \frac{l}{a}\right)}{\sinh \frac{l}{a}} \left(\cosh \frac{z}{a} - 1.0 \right) + \frac{z}{a} \left(1 - \frac{z}{l} \right) - \sinh \frac{z}{a} \right]$
8	$\theta = \frac{tl^2}{GJ} \left\{ \frac{a}{2l \sinh \frac{l}{a}} - S \times \tanh \frac{l}{2a} \right\} \times \left(\cosh \frac{z}{a} - 1.0 \right) + S \times \left(\sinh \frac{z}{a} - \frac{z}{a} \right) - \frac{z^3}{6l^3}$ <p>where:</p>

Case	θ
8 (cont.)	$S = \left[\frac{\frac{a}{2l} \times \left(\cosh \frac{l}{a} - 1.0 \right) - \frac{\sinh \frac{l}{a}}{6.0}}{\left(\frac{l}{a} \sinh \frac{l}{a} + 2.0 - 2 \cosh \frac{l}{a} \right)} \right]$
9	$0 \leq z \leq \alpha l$ $\theta = \frac{Ta}{GJ} \left[\left(\sinh \frac{\alpha l}{a} - \tanh \frac{l}{a} \times \cosh \frac{\alpha l}{a} + \tanh \frac{l}{a} \right) \left(\cosh \frac{z}{a} - 1.0 \right) - \sinh \frac{z}{a} + \frac{z}{a} \right]$ $\alpha l \leq z \leq l$ $\theta = \frac{Ta}{GJ} \left[\left(\tanh \frac{l}{a} \times \cosh \frac{\alpha l}{a} - \tanh \frac{l}{a} - \sinh \frac{\alpha l}{a} \right) - \left(\cosh \frac{\alpha l}{a} - 1.0 \right) \left(\tanh \frac{l}{a} \times \cosh \frac{z}{a} \right) + \left(\cosh \frac{\alpha l}{a} - 1.0 \right) \times \sinh \frac{z}{a} + \frac{\alpha l}{a} \right]$
10	$0 \leq z \leq \alpha l$ $\theta = \frac{ta^2}{GJ} \left\{ \tanh \frac{l}{a} \left(\frac{\alpha l}{a} - \sinh \frac{\alpha l}{a} \right) + \cosh \frac{\alpha l}{a} \right\} \left[\cosh \frac{z}{a} - 1.0 \right] - \frac{\alpha l}{a} \times \sinh \frac{z}{a} + \frac{z}{a} \left(\frac{\alpha l}{a} - \frac{z}{2a} \right)$ $\alpha l \leq z \leq l$ $\theta = \frac{ta^2}{GJ} \left[\tanh \frac{l}{a} \times \sinh \frac{\alpha l}{a} - \cosh \frac{\alpha l}{a} - \frac{\alpha l}{a} \times \tanh \frac{l}{a} + 1.0 + \frac{\alpha^2 l^2}{2a^2} - \left(\sinh \frac{\alpha l}{a} - \frac{\alpha l}{a} \right) \times \tanh \frac{l}{a} \times \cosh \frac{z}{a} + \left(\sinh \frac{\alpha l}{a} - \frac{\alpha l}{a} \right) \times \sinh \frac{z}{a} \right]$
11	$\theta = \frac{ta^2}{GJ} \left\{ \left[1.0 - \frac{5l^2}{6a^2} - \left(\frac{a}{l} - \frac{l}{2a} \right) \times \tanh \frac{l}{a} \right] + \left[-\frac{z}{l} + \frac{zl}{a^2} \right] + \left[\frac{a}{l} - \frac{l}{2a} \right] \left(\frac{\sinh \frac{z}{a}}{\cosh \frac{l}{a}} \right) - \frac{z^2}{6a^2} \times \frac{z}{l} \right\}$
12	$\theta = \frac{ta^2}{GJ} \left[H \times \left(\tanh \frac{l}{a} - \frac{z}{a} - \tanh \frac{l}{a} \times \cosh \frac{z}{a} + \sinh \frac{z}{a} \right) + \frac{\cosh \frac{z}{a}}{\cosh \frac{l}{a}} - \frac{1}{\cosh \frac{l}{a}} - \frac{z^2}{2a^2} \right]$ <p>where:</p> $H = \left(\frac{l^2}{2a^2} - 1.0 + \frac{1}{\cosh \frac{l}{a}} \right) \times \frac{1}{\left(\tanh \frac{l}{a} - \frac{l}{a} \right)}$

REFERENCES

- AASHTO, 1993, *Guide Specifications for Horizontally Curved Highway Bridges*, AASHTO, Washington, D.C.
- AISC, 1994, *LRFD Manual of Steel Construction*, 2nd Ed., AISC, Chicago, IL.
- AISC, 1993a, *Load and Resistance Factor Design Specification for Structural Steel Buildings*, AISC, Chicago, IL.
- AISC, 1993b, *Specification for Load and Resistance Factor Design of Single-Angle Members*, AISC, Chicago, IL.
- AISC, 1989a, *Specification for Structural Steel Buildings, Allowable Stress Design*, AISC, Chicago, IL.
- AISC, 1989b, *Specification for Allowable Stress Design of Single-Angle Members*, AISC, Chicago, IL.
- AISC, 1986, "Horizontally Curved Girders," *Highway Structures Design Handbook, Volume II, Chapter 6*, AISC, Chicago, IL.
- Bleich, F., 1952, *Buckling Strength of Metal Structures*, McGraw-Hill, Inc., New York, NY.
- Boothby, T. E., 1984, "The Application of Flexural Methods to Torsional Analysis of Thin-Walled Open Sections," *Engineering Journal*, Vol. 21, No. 4, (4th Qtr.), pp. 189-198, AISC, Chicago, IL.
- Chu, K. H. and Johnson, R. B., 1974, "Torsion in Beams with Open Sections," *Journal of the Structural Division*, Vol. 100, No. ST7 (July), p. 1397, ASCE, New York, NY.
- El Darwish, I. A. and Johnston, B. G., 1965, "Torsion of Structural Shapes," *Journal of the Structural Division*, Vol. 91, No. ST1 (Feb.), ASCE, New York, NY.
- Evick, D. R. and Heins, C. P., 1972, "Torsion of Nonprismatic Beams of Open Section," *Journal of the Structural Division*, Vol. 98, No. ST12 (Dec.), ASCE, New York, NY.
- Galambos, T. V., 1988, *Guide to Stability Design Criteria for Metal Structures*, 4th Ed., John Wiley & Sons, Inc., New York, NY.
- Gjelsvik, A., 1981, *The Theory of Thin-Walled Bars*, John Wiley & Sons, New York, NY.
- Heins, C. R., 1975, *Bending and Torsional Design in Structural Members*, Lexington Book Co., Lexington, MA.
- Heins, C. P. and Firmage, D. A., 1979, *Design of Modern Steel Highway Bridges*, John Wiley Interscience, New York, NY.
- Heins, C. P. and Kuo, J. T., 1972, "Composite Beams in Torsion," *Journal of the Structural Division*, Vol. 98, No. ST5 (May), ASCE, New York, NY.
- Heins, C. P. and Potocko, R. A., 1979, "Torsional Stiffness of I-Girder Webs," *Journal of the Structural Division*, Vol. 105, No. ST8 (Aug.), ASCE, New York, NY.
- Heins, C. P. and Seaburg, P. A., 1963, *Torsion Analysis of Rolled Steel Sections*, Bethlehem Steel Company, Bethlehem, PA.
- Hotchkiss, J. G., 1966, "Torsion of Rolled Steel Sections in Building Structures," *Engineering Journal*, Vol. 3, No. 1, (Jan.), pp. 19-45, AISC, Chicago, IL.
- Johnston, B. G., 1982, "Design of W-Shapes for Combined Bending and Torsion," *Engineering Journal*, Vol. 19, No. 2, (2nd Qtr.), pp. 65-85, AISC, Chicago, IL.
- Johnston, B. G., Lin, F. J., and Galambos, T. V., 1980, *Basic Steel Design*, 2nd Ed., Prentice-Hall, Englewood Cliffs, NJ.
- Liew, J. Y. R., Thevendran, V., Shanmugam, N. E., and Tan, L. O., 1995, "Behaviour and Design of Horizontally Curved Steel Beams," *Journal of Constructional Steel Research*, Vol. 32, No. 1, pp. 37-67, Elsevier Applied Science, Oxford, United Kingdom.
- Lin, PH., 1977, "Simplified Design for Torsional Loading of Rolled Steel Members," *Engineering Journal*, Vol. 14, No. 3, (3rd Qtr.), pp. 98-107, AISC, Chicago, IL.
- Lyse, I. and Johnston, B. G., 1936, "Structural Beams in Torsion," *ASCE Transactions*, Vol. 101, ASCE, New York, NY.
- Nakai, H. and Heins, C. P., 1977, "Analysis Criteria for Curved Bridges," *Journal of the Structural Division*, Vol. 103, No. ST7 (July), ASCE, New York, NY.
- Nakai, H. and Yoo, C. H., 1988, *Analysis and Design of Curved Steel Bridges*, McGraw-Hill, Inc., New York, NY.
- Ojalvo, M., 1975, "Warping and Distortion at I-Section Joints"—Discussion, *Journal of the Structural Division*, Vol. 101, No. ST1 (Jan.), ASCE, New York, NY.
- Ojalvo, M. and Chamber, R., 1977, "Effect of Warping Restraints on I-Beam Buckling," *Journal of the Structural Division*, Vol. 103, No. ST12 (Dec.), ASCE, New York, NY.
- Salmon, C. G. and Johnson, J. E., 1990, *Steel Structures Design and Behavior*, 3rd Ed., Harper Collins Publishers, New York, NY.
- Siev, A., 1966, "Torsion in Closed Sections," *Engineering Journal*, Vol. 3, No. 1, (January), pp. 46-54, AISC, Chicago, IL.
- Tide, R. H. R. and Krogstad, N. V., 1993, "Economical Design

- of Shelf Angles," *Proceedings of the Symposium on Masonry: Design and Construction, Problems and Repair*, STP 1180, American Society for Testing and Materials, Philadelphia, PA.
- Timoshenko, S., 1945, "Theory of Bending, Torsion and Buckling of Thin-Walled Members of Open Cross-Section," *Journal of the Franklin Institute*, March/April/May, Philadelphia, PA.
- Tung, D. H. H. and Fountain, R. S., 1970, "Approximate Torsional Analysis of Curved Box Girders by the M/R Method," *Engineering Journal*, Vol. 7, No. 3, (July), pp. 65-74, AISC, Chicago, IL.
- Vlasov, V. Z., 1961, *Thin-Walled Elastic Beams*, National Science Foundation, Wash., DC.
- Young, W. C., 1989, *Roark's Formulas for Stress & Strain*, McGraw-Hill, Inc., New York, NY.

NOMENCLATURE

A	area, in. ² ; also, constant determined from boundary conditions (see Equations C.1, C.5, C.9, and C.14)	V_s	variable in Equation C.32 or C.39, in.
B	constant determined from boundary conditions (see Equations C.1, C.5, C.9, and C.14)	W_{ns}	normalized warping function at point s on cross-section, in. ²
C	constant determined from boundary conditions (see Equations C.1, C.5, C.9, and C.14)	a	torsional constant as defined in Equation 3.6
C_w	warping constant of cross-section, in. ⁶	b	width of cross-sectional element, in.
D_1	variable in Equation C.26, in.	b'	variable in Equation 3.21 or 3.30, in.
D_2	variable in Equation C.29, in.	b_f	flange width, in.
D_3	variable in Equation C.42, in.	dT	incremental torque corresponding to incremental length dz , kip-in.
D_4	variable in Equation C.36, in.	dz	incremental length along Z-axis, in.
E	modulus of elasticity of steel, 29,000 ksi	e	eccentricity, in.
E_0	horizontal distance from Centerline of channel web to shear center, in.	e_o	horizontal distance from outside of web of channel to shear center, in.
F	variable in Equation C.30, in.	f_a	axial stress under service load, ksi
F_a	allowable axial stress (ASD), ksi	f_n	total normal stress due to torsion and all other causes, ksi
F_b	allowable bending stress (ASD), ksi	f_v	total shear stress due to torsion and all other causes, ksi
F_e'	Euler stress divided by factor of safety (see ASD Specification Section H1), ksi	h	depth center-to-center of flanges for I-, C-, and Z-shaped members, in. depth minus half flange thickness for structural tee, in. leg width minus half leg thickness for single angles, in.
F_v	allowable shear stress (ASD), ksi	k	torsional stiffness from Equation 2.1
F_y	yield strength of steel, ksi	l	span length, in.
F_{cr}	critical buckling stress, ksi	m	thickness of sloping flange at beam Centerline (see Figure C.4b), in.
G	shear modulus of elasticity of steel, 11,200 ksi	s	subscript relative to point 0, 1, 2,... on cross-section
H	variable in Equation 3.37	t	distributed torque, kip-in, per in.; also, thickness of cross-sectional element, in.
I	moment of inertia, in. ⁴	t_f	flange thickness, in.
J	torsional constant of cross-section, in. ⁴	t_w	web thickness, in.
M	bending moment, kip-in.	t_1	thickness of sloping flange at toe (see Figure C.4b), in.
P	concentrated force, kips	t_2	thickness of sloping flange, ignoring fillet, at face of web (see Figure C.4b), in.
Q	statical moment about the neutral axis of the entire cross-section of the cross-sectional area between the free edges of the cross-section and a plane cutting the cross-section across the minimum thickness at the point under examination, in. ³	u	subscript denoting factored loads (LRFD); also, variable in Equation 3.22 or 3.31, in.
Q_f	value of Q for a point in the flange directly above the vertical edge of the web, in. ³	u'	variable in Equation 3.32, in.
Q_s	value of Q for a point at mid-depth of the cross-section, in. ³	x	subscript relating to strong axis
R	fillet radius, in.	y	subscript relating to weak axis
S	elastic section modulus, in. ³ ; also, variable used in calculation of torsional properties (see Equation 3.31 or C.38)	z	distance along Z-axis of member from left support, in.
S_{ws}	warping statical moment at point s on cross-section, in. ⁴	θ	angle of rotation, radians
T	applied concentrated torsional moment, kip-in.	θ'	first derivative of θ with respect to z
T_t	resisting moment due to pure torsion, kip-in.	θ''	second derivative of θ with respect to z
T_w	resisting moment due to warping torsion, kip-in.	θ'''	third derivative of θ with respect to z
V	shear, kips		

θ''''	fourth derivative of θ with respect to z	ρ	perpendicular distance to tangent line from centroid (see Figure C.3), in.
α	distance from support to point of applied torsional moment or to end of uniformly distributed torsional load over a portion of span, divided by span length l	ρ_o	perpendicular distance to tangent line from shear center (see Figure C.3), in.
α_1	variable in Equation C.19, in.	σ_a	normal stress due to axial load, ksi
α_2	variable in Equation C.22, in.	σ_b	normal stress due to bending, ksi
α_3	variable in Equation C.35, in.	σ_{ws}	normal stress at point s due to warping torsion, ksi
α_4	variable in Equation C.28, in.	τ_b	shear stress, ksi
α_4'	variable in Equation C.30, in.	τ_t	shear stress at element edge due to pure torsion, ksi
ϕ	0.90, resistance factor for yielding (LRFD)	τ_{ws}	shear stress at point s due to warping torsion, ksi
ϕ_c	0.85, resistance factor for buckling (LRFD)		



DESIGN GUIDE SERIES
American Institute of Steel Construction, Inc.
One East Wacker Drive, Suite 3100
Chicago, Illinois 60601-2001

Pub. No. D809 (5M297)