



DEPARTMENT OF LICENSING AND REGULATORY AFFAIRS
DIRECTOR'S OFFICE
CONSTRUCTION SAFETY STANDARDS

Filed with the Secretary of State on August 17, 1979 (as amended November 23, 1982)
(as amended January 11, 1988) (as amended July 8, 1993)
(as amended September 3, 1996) **(as amended March 14, 2013)**

These rules become effective immediately upon filing with the Secretary of State
unless adopted under section 33, 44, or 45a(6) of 1969 PA 306.

Rules adopted under these sections become effective 7 days after filing with the Secretary of State.

(By authority conferred on the director of the department of licensing and regulatory affairs
by sections 19 and 21 of 1974 PA 154, and Executive Reorganization Order Nos. 1996-2, 2003-1, 2008-4,
and 2011-4, MCL 445.2001, 445.2011, 445.2025, and 445.2030)

R 408.40932, R 408.40933, R 408.40941, and R 408.40951 of the Michigan Administrative Code are amended
and R 408.40946 and R 408.40952 are rescinded, as follows:

PART 9. EXCAVATION, TRENCHING, AND SHORING

TABLE OF CONTENTS

R 408.40901. Scope.	1	R 408.40941. Excavation; angle of repose.	3
R 408.40925. Definitions A to Q.	1	R 408.40942. Supporting systems; angle of repose; tie backs; tight sheeting; additional bracing.	4
R 408.40926. Definitions; S.	2	R 408.40943. Additional requirements for trench support systems	4
R 408.40927. Definitions; T, U.	2	R 408.40944. Benching and sloping.	5
R 408.40931. Locating utility lines.	2	R 408.40945. Trenching boxes and shields.	5
R 408.40932. Excavation; consideration of soil types; water; slide hazards.	2	R 408.40951. Walkways, sidewalks, roadways.	5
R 408.40933. Excavation; obstructions; retaining materials; egress; guarding; heavy equipment.	3	R 408.40953. Adjacent structures; protection; design; inspection of shoring, bracing, and underpinning.	5
R 408.40934. Hazardous atmospheres; testing and controls.	3	Appendix.	6

R 408.40901. Scope.

Rule 901. This part pertains to the digging of excavations and trenches which an employee is required to enter and the supporting systems used on construction operations.

R 408.40925. Definitions A to Q.

Rule 925. (1) "Angle of repose" means the maximum permissible slope as determined by table 1.

(2) "Braces" or "struts" means the horizontal cross members of a shoring system that bear against the uprights or stringers.

(3) "Excavation" means any man-made cavity or depression in the earth's surface, including its sides, walls, or faces, formed by earth removal. For the purpose of this part, a trench is an excavation.

(4) "Hazardous atmosphere" means an atmosphere which, by reason of being any of the following, may cause death, illness, or injury:

- (a) Explosive.
 - (b) Flammable.
 - (c) Poisonous.
 - (d) Corrosive.
 - (e) Irritating.
 - (f) Oxygen deficient.
 - (g) Toxic.
 - (h) Otherwise harmful.
- (5) "Kickouts" means the accidental release or failure of a stringer or brace.
- (6) "Qualified person" means a person who, by possession of a recognized degree or certificate of professional standing, or who, by extensive knowledge, training, and experience, has successfully demonstrated the ability to solve or resolve problems relating to the subject matter and work.

R 408.40926. Definitions; S.

Rule 926. (1) "Sheet piling" means a continuous row of timber or steel piles driven in close contact to provide a tight wall to resist lateral pressure of water, adjacent earth, or other materials.

(2) "Sides," sometimes called faces or walls, means the vertical or inclined earth surfaces formed as a result of excavation work.

(3) "Slope" means the acute angle formed by the side of a trench or excavation and the horizontal plane.

(4) "Soil" means any of the following:

(a) "Clay" — a very fine textured soil that derives its resistance to displacement from cohesion and may be:

(i) "Soft clay" — a clay-type soil that has an unconfined strength of less than 1.0 ton per square foot.

(ii) "Medium clay," sometimes called plastic — a clay-type soil that has a minimum unconfined strength of 1.0 ton per square foot.

(iii) "Firm soil" — a clay-type soil that is resistant to forces causing rupture or displacement. A firm clay has a minimum unconfined strength of 1.5 tons per square foot.

(iv) "Stiff clay" — a clay-type soil that is very resistant to forces causing rupture or displacement. A stiff clay has a minimum unconfined strength of 2.5 tons per square foot.

(b) "Fill" — a manmade soil condition that may be constructed of any type of soil or combination thereof.

(c) "Granular soil" — a coarse grained soil that does not possess cohesion but derives its strength from internal friction.

(d) "Organic soil" — A soil that contains significant amounts of peat, muck, or marl.

(e) "Running soil" — any type of soil that has insufficient strength to stand unsupported. Running soil tends to run or slough into the excavation as the excavation is being dug.

(5) "Stringers" means the horizontal members of a trench shoring system whose sides bear against the uprights or earth.

(6) "Supporting system" means the total system necessary to restrain the sides of an excavation from moving.

R 408.40927. Definitions; T, U.

Rule 927. (1) "Tight sheeting" means a continuous row of wood or steel sheets in close contact to provide a tight wall, but is not driven as with piling.

(2) "Toe of slope" means the point at which the side of an excavation intersects the lowest level of the excavation.

(3) "Trench" means an excavation having a depth greater than its width measured at the bottom.

(4) "Trench jack," means a screw or hydraulic jack used as a brace in a trench shoring system.

(5) "Trench shield" sometimes called a trench box, means a trench shoring system composed of steel plates and bracing, welded or bolted together, which can be moved along as work progresses.

(6) "Uprights" means the vertical members of a trench shoring system.

R 408.40931. Locating utility lines.

Rule 931. (1) An employer shall not excavate in a street, highway, public place, a private easement of a public utility, or near the location of a public utility facility owned, maintained, or installed on a customer's premises, without having first ascertained the location of all underground facilities of a public utility in the proposed area of excavation.

(2) Upon receiving the information from the public utility, an employer shall exercise reasonable care when working in close proximity to the underground facilities of any public utility. If the facilities are to be exposed, or are likely to be exposed, only hand digging shall be employed in such circumstances and such support, as may be reasonably necessary for protection of the facilities, shall be provided in and near the construction area.

(3) When any contact with, or damage to, any pipe, cable, or its protective coating, or any other underground facility of a public utility occurs, the public utility shall be notified immediately by the employer responsible for operations causing the damage. If an energized electrical cable is severed, an energized conductor is exposed, or dangerous fluids or gasses are escaping from a broken line, the employer shall evacuate the employees from the immediate area while awaiting the arrival of the public utility personnel.

R 408.40932. Excavation; consideration of soil types; water; slide hazards.

Rule 932. (1) If different textured soils are encountered in the side of an excavation, each soil type of the excavation shall be cut to the proper angle of repose, except that the slope shall not steepen between the toe of the slope and the ground level where soft clay or running soil is encountered in the lower cut.

(2) An employee shall not work in an excavation in which there is accumulated water or in which water is accumulating unless precautions have been taken to protect employees against the hazards posed by water accumulation. The precautions necessary to protect employees adequately vary with each situation, but may include special support or shield systems to protect from cave-ins, water removal to control the level of accumulating water, or the use of a safety harness and lifeline.

(3) If water is controlled or prevented from accumulating by the use of water removal equipment, the water removal equipment and operation shall be monitored by a qualified person or a monitoring system to ensure that the equipment is properly operated.

(4) An ongoing inspection of an excavation or trench shall be made by a qualified person. After every rainstorm or other hazard-producing occurrence, an inspection shall be made by a qualified employee for evidence of possible slides or cave-ins. Where these conditions are found, all work shall cease until additional precautions, such as additional shoring or reducing the slope, have been accomplished.

(5) When installed forms, walls, or similar structures create a trench between the form, wall, or structure and the side of the excavation, an employer shall comply with the provisions of R 408.40941 to R 408.40944.

R 408.40933. Excavation; obstructions; retaining materials; egress; guarding; heavy equipment.

Rule 933. (1) A tree, boulder, rock fragments, or other obstructions whose movement could cause injury to an employee shall be removed or supported.

(2) An excavation that an employee is required to enter shall have excavated and other material stored and retained not less than 2 feet from the excavation edge.

(3) When mobile equipment is utilized or permitted adjacent to an excavation where the operator's vision is restricted, stop logs or barricades shall be utilized or a signal person shall be used.

(4) An excavation 48 or more inches in depth and occupied by an employee shall be provided with either a ladder extending not less than 3 feet above the top as a means of access or with a ramp meeting the requirements of subrule (5) of this rule. Lateral travel along the wall of a trench to a ladder or other means of egress shall not exceed 25 feet.

(5) An earth ramp may be used in place of a ladder if it meets all of the following requirements:

(a) The ramp material shall be stable.

(b) The sides of the excavation above the ramp shall be maintained to the angle of repose or sheeted or shored along the means of egress.

(c) The degree of angle of the ramp shall not be more than 45 degrees.

(d) Vertical height between the floor of the trench and the toe of the ramp shall not exceed 30 inches.

R 408.40934. Hazardous atmospheres; testing and controls.

Rule 934. To prevent exposure to harmful levels of atmospheric contaminants and to assure acceptable atmospheric conditions, all of the following requirements shall apply:

(a) Where an oxygen deficiency (an atmosphere that contains less than 19.5% oxygen) or a hazardous atmosphere exists, such as in excavations in areas where hazardous substances are stored nearby, the atmosphere in the excavation shall be tested before employees enter excavations that are more than 4 feet (1.22 m) deep.

(b) Precautions shall be taken to prevent employee exposure to atmospheres that contain less than 19.5% oxygen and any other hazardous atmosphere. These precautions include providing proper respiratory protection or ventilation in accordance with the requirements of this part.

(c) Precautions shall be taken, such as providing ventilation, to prevent employee exposure to an atmosphere that contains a concentration of a flammable gas in excess of 20% of the lower flammable limit of the gas.

(d) When controls are used that are intended to reduce the level of atmospheric contaminants to acceptable levels, testing shall be conducted as often as necessary to ensure that the atmosphere remains safe.

R 408.40941. Excavation; angle of repose.

Rule 941. (1) The side of an excavation more than 5 feet deep shall be sloped as prescribed in table 1, unless supported as prescribed in this part.

(2) An excavation less than 5 feet in depth shall also be effectively protected when examination of the ground indicates hazardous earth movement may be expected.

TABLE 1

MAXIMUM ALLOWABLE ANGLE OF REPOSE FOR THE SIDE OF AN EXCAVATION IN EXCESS OF 5' DEPTH

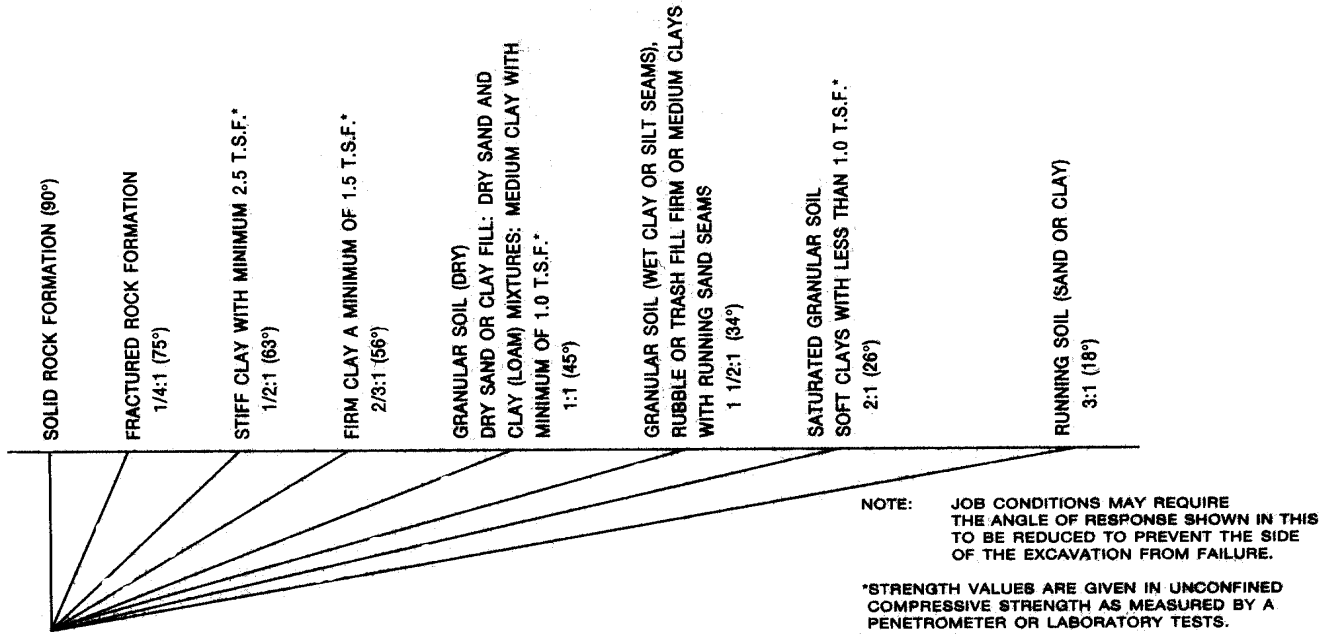

R 408.40942. Supporting systems; angle of repose; tie backs; tight sheeting; additional bracing.

Rule 942. (1) The angle of repose and the design of the supporting system for a side of an excavation shall be based on the evaluation of all of the following factors:

- (a) Depth of cut and type of soil.
 - (b) Possible variation in the water content of the material while the excavation is open.
 - (c) Anticipated changes in the material due to exposure to air, sun, water, or freezing.
 - (d) Load imposed by structures, equipment, overlying material, or stored material.
 - (e) Vibration from traffic, equipment, or blasting.
- (2) A support system shall be designed by a qualified employee. The design of the supporting system shall be maintained at the jobsite. Changes from the design of the support system shall be approved by a qualified employee.

(3) Tie rods and other forms of tie backs used to restrain the top of sheeting shall be anchored a minimum of 10 feet. The measurement to the anchor point shall start at the intersection of an angle of repose with the surface of the soil retained. The tie back and anchor shall be capable of restraining any pressure exerted on the system.

(4) When tight sheeting or sheet piling is used, pressures due to existing ground water conditions shall be considered in the design. Sheet piling shall be driven to the predetermined depth set forth in the required design. Changes from the design shall be approved by the designer of the support system.

(5) Materials used for a supporting system shall be in good serviceable condition. When timbers are used, they shall be sound and free of large or loose knots.

(6) A supporting system shall include additional bracing approved by the designer of the support system when the sides of excavations are cut adjacent to a previous known excavation or a known fill, particularly when the separation between the previous excavation and the new excavation is less than the depth of the excavation.

(7) Tight sheeting shall be braced or anchored at the bottom and along the vertical plane to prevent lateral movement.

R 408.40943. Additional requirements for trench support systems

Rule 943. (1) A brace or trench jack that is used for a support system for a trench shall be spaced as designed and shall be secured to prevent sliding, failing, or kickout.

(2) The backfilling and the removal of a support system for a trench shall progress together from the bottom of the trench. In unstable or running soil, the jacks and braces shall be removed from above the trench after employees have cleared the trench.

(3) The excavation of material to a level that is not more than 2 feet (.61 m) below the bottom of the members of a support system shall be permitted, but only if the system is designed to resist the forces calculated for the full depth of the trench and if there are no indications, while the trench is open, of a possible loss of soil from behind or below the bottom of the support system.

(4) The installation of a support system shall be closely coordinated with the excavation of trenches.

R 408.40944. Benching and sloping.

Rule 944. (1) The angle of repose shall be flattened when an excavation has water conditions, silty materials, loose boulders, or areas where erosion, deep frost action, or slide planes appear.

(2) When benching the side of an excavation, the vertical rise shall not be more than 5 feet and the step back shall extend at least to the angle of repose as required by table 1.

(3) When benching a side of a trench, the height of the lower bench shall not be more than the lesser of 5 feet or width of the trench measured at the bottom.

(4) An employee shall not be permitted to work on sloped or benched excavations at levels above another employee, except when an employee at the lower level is protected from the hazard of falling, rolling, or sliding material or equipment.

R 408.40945. Trenching boxes and shields.

Rule 945. (1) Portable trench boxes or sliding trench shields may be used for the protection of personnel in place of a shoring system or sloping. Where such trench boxes or shields are used, they shall be designed, constructed, and maintained in a manner that provides protection equal to or greater than the sheeting or shoring required for the trench.

(2) The use of benching in conjunction with a portable trench box is permitted when the toe of the trench box is not more than 2 feet above the trench bottom, but only if the trench box is designed to resist the forces calculated for the full depth of the trench and if there are no indications, while the trench is open, of a possible cave-in below the bottom of the trench box.

(3) An employee shall not be allowed in shields when shields are being installed, removed, or moved.

R 408.40946. Rescinded.

R 408.40951. Walkways, sidewalks, roadways.

Rule 951. (1) A sidewalk shall not be undermined unless it is shored to support a live load of not less than 125 pounds per square foot.

(2) If an employee or equipment is required or permitted to cross a trench or ditch, a walkway, runway, ramp, or bridge shall be provided and shall have a designed capacity of not less than 3 times the imposed load. A guardrail prescribed by the provisions of Part 21. Guarding of Walking and Working Areas and Part 45. Fall Protection, R 408.42101 and R 408.44501, shall be provided.

R 408.40952. Rescinded.

R 408.40953. Adjacent structures; protection; design; inspection of shoring, bracing, and underpinning.

Rule 953. (1) A structure that is adjacent to an excavation or trench below the level of the base or footing of any foundation or retaining wall shall be protected against settlement, lateral movement, undermining, or washout.

(2) Before the excavation begins, the design of the protection used shall be set forth by a qualified person who is knowledgeable in the subject area.

(3) The shoring, bracing, and underpinning shall be inspected daily or more often, as conditions warrant, by a qualified employee.

APPENDIX

PART 9. EXCAVATIONS, TRENCHING & SHORING

The following pages are not a part of the mandatory requirements of this safety standard. They are, however, examples of good engineering practices based on the rules contained herein.

EXAMPLES OF EXCAVATION
& TRENCH PROTECTION
EXCAVATIONS

EXAMPLE 1 0-5' Deep

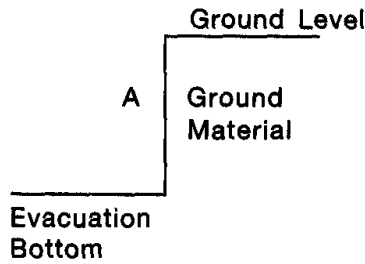

SIDE A: If examination of the ground indicated hazardous ground movement may be expected Side A shall be cut to the angle of repose of a supporting system shall be provided.

EXAMPLE 2 More than 5' Deep

A. Stiff Clay

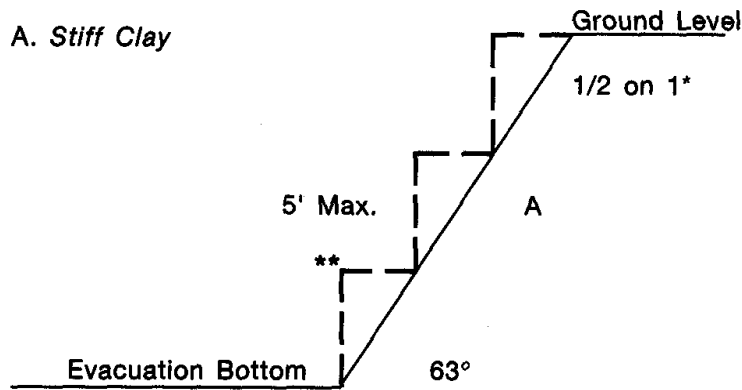

* 1/2 HORIZONTAL: 1 VERTICAL

** See rule 944(3) for lower bench height.

EXAMPLE 2 More than 5' Deep (continued)

B. Firm Clay

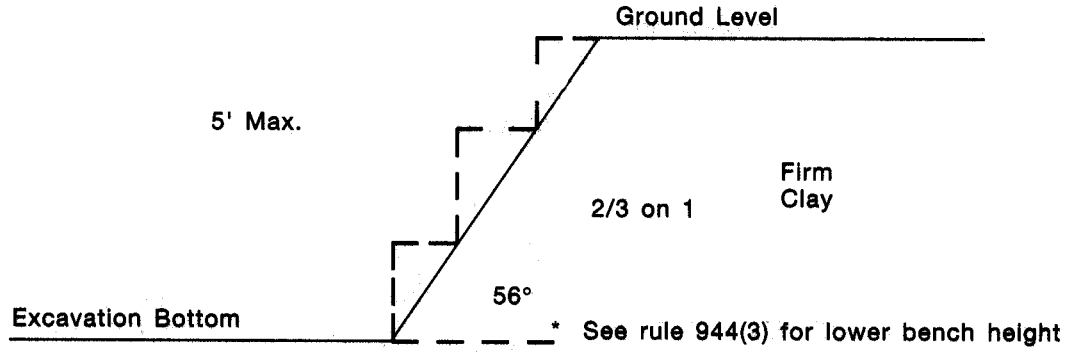

C. Granular Material

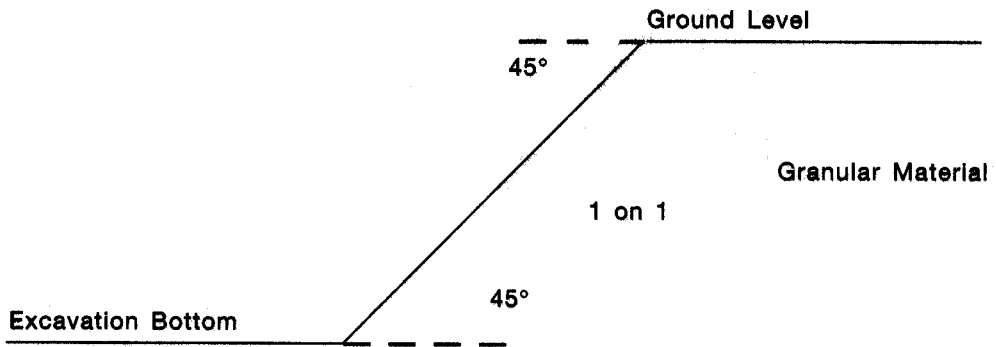

D. Granular Material (Wet Clay or Silt Seams)

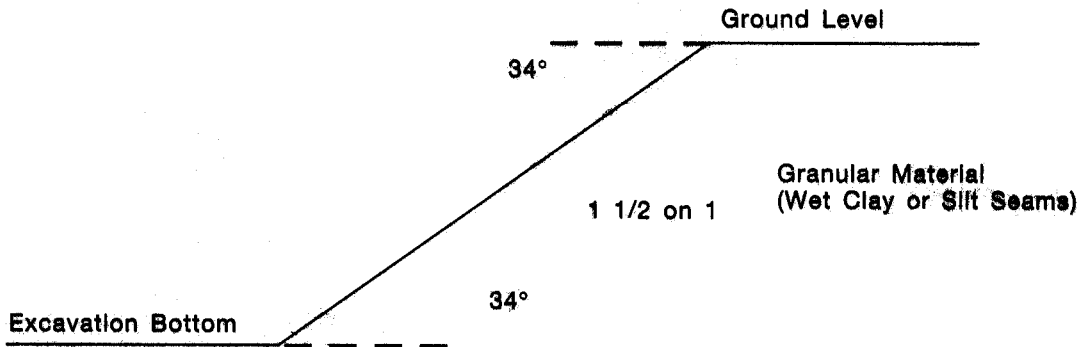

E. Saturated Granular Material or Soft Clay

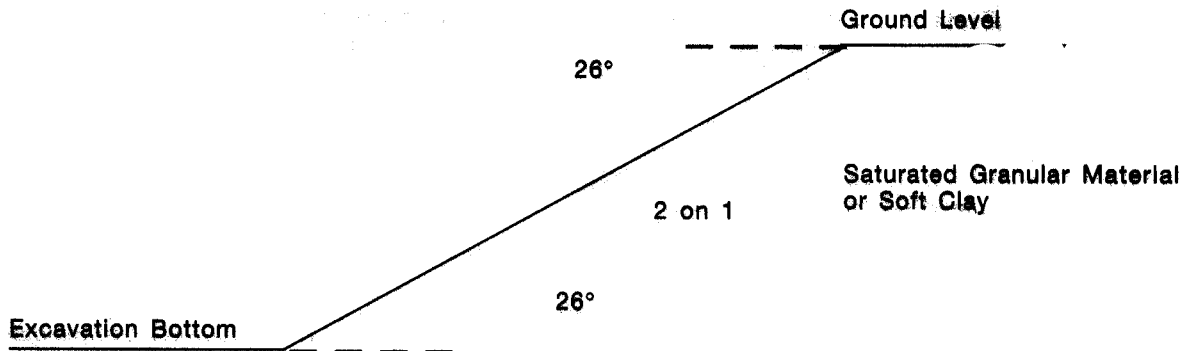

EXAMPLE 3 Support System — Sheet Piling

Wet Granular Material

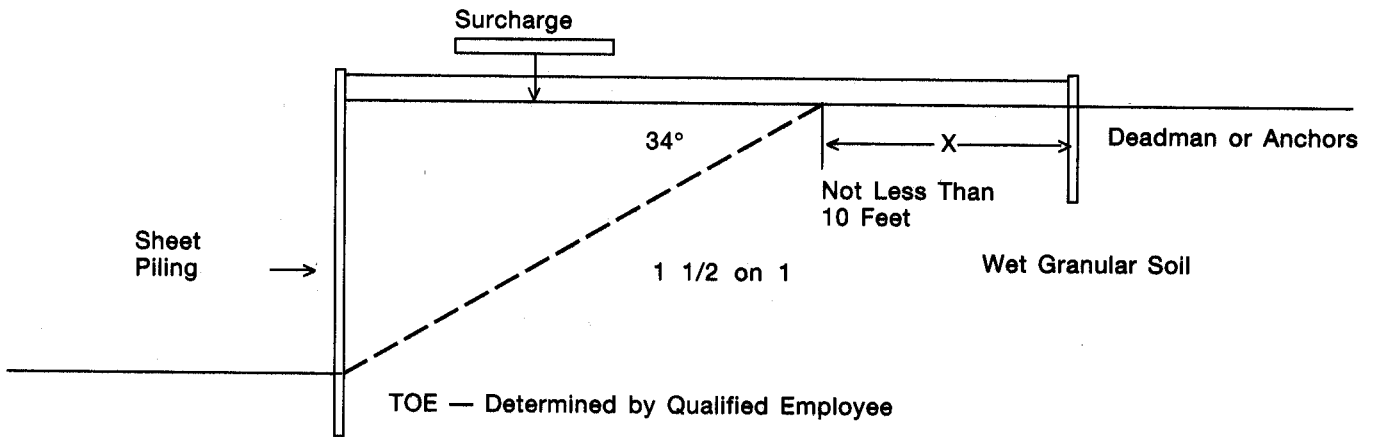

The design of the supporting system should take into consideration any surcharge, such as, stockpiled material, equipment, or hydrostatic pressure that must be supported by the system.

X = Not Less than 10'

EXAMPLE 4 Wall in Place

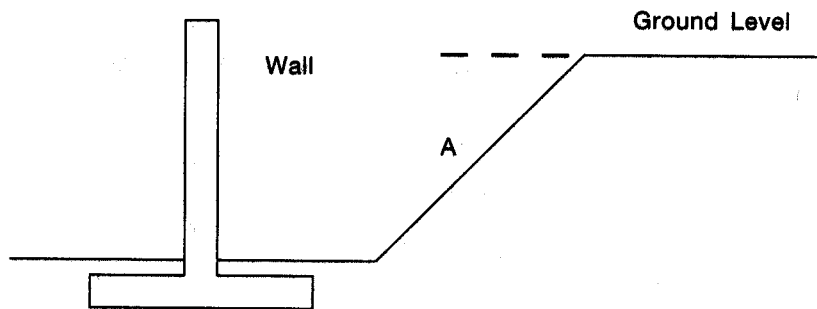

Side A: Side A should be cut to the angle of repose or a supporting system provided.

If a support system is designed for Side A, no braces or members should bear against the wall unless the wall is designed to withstand bracing loads.

EXAMPLE 5 Different Textured Soils

Case 1

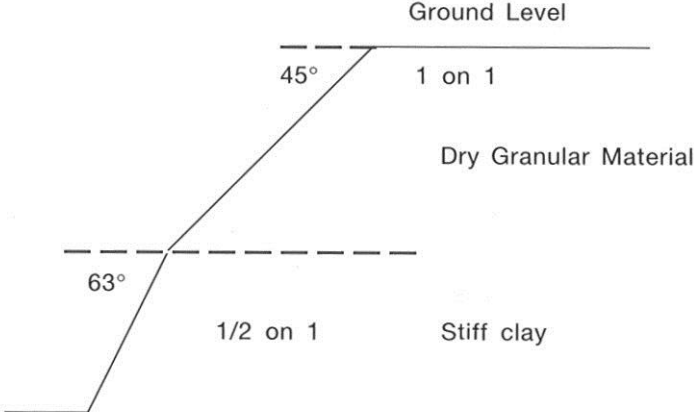

Case 2

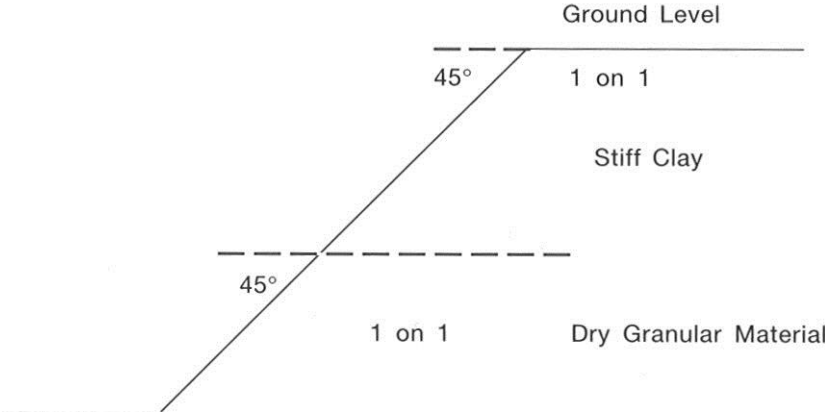

EXAMPLE 6 0-5' Deep

TRENCHES

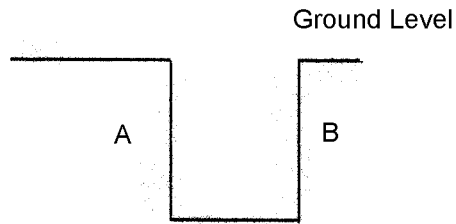

SIDES A & B: If examination of the ground indicates ground movement may be expected Sides A & B shall be cut to the angle of repose or a supporting system shall be provided.

EXAMPLE 7 Trench Shoring System

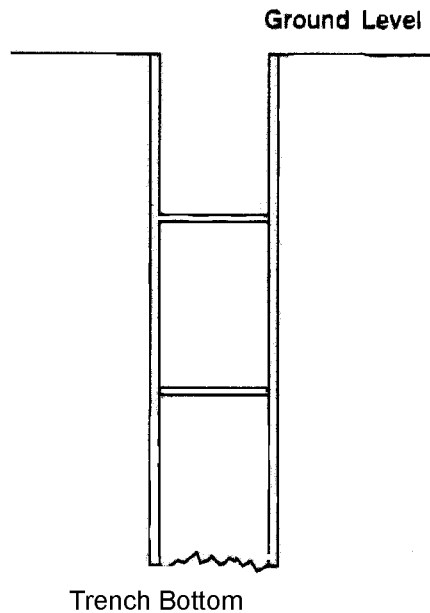

A trench support system shall be designed by a qualified employee knowledgeable in the field. The arrangement of stringers, struts, and braces should be a designated by the plans.

**EXAMPLE 8 Use of a Trench Supporting System
Such as a trench shield not extending to ground level**

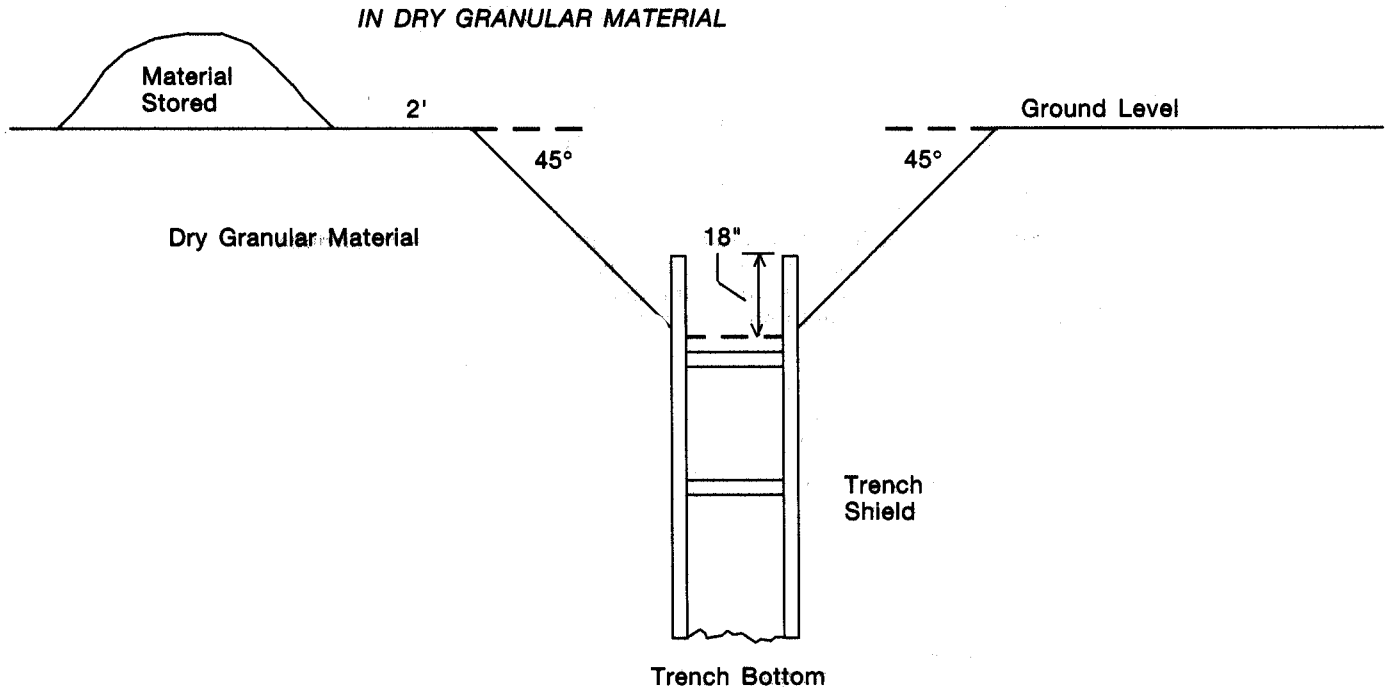

EXAMPLE 9 Trench Cut In Sloping Ground

MEDIUM CLAY

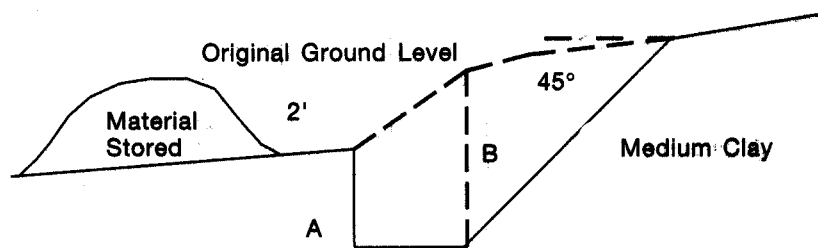

- If Side A is 5' or less and Side B is more than 5'
- (1) Side A should be sloped as provided for in Example 6.
 - (2) Side B should be cut to the correct angle of repose
 - (3) All excavated material should be stored on the low side of the trench, if possible.

EXAMPLE 10 Trench Cut in Different Textured Materials

Case 1

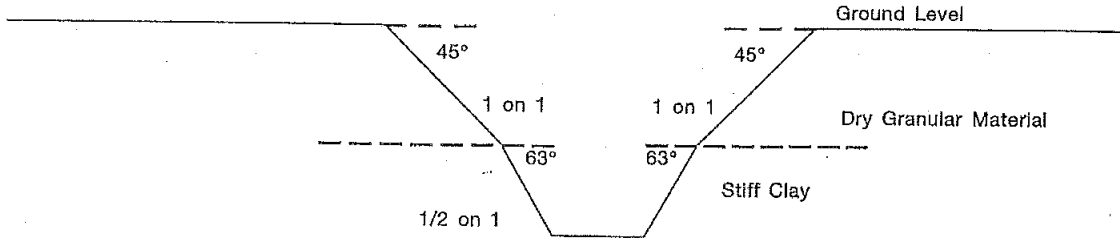

Case 2

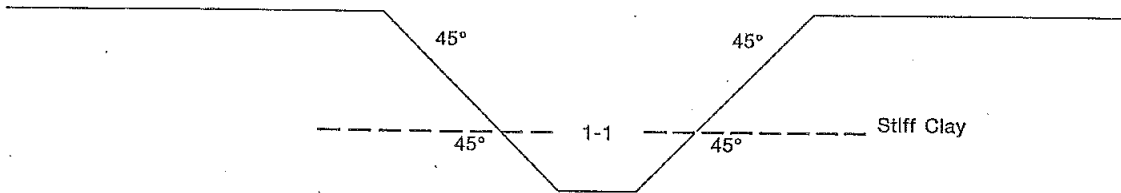

EXAMPLE 11 Fill Areas

Case 1 Dry Clay or Sand Fill

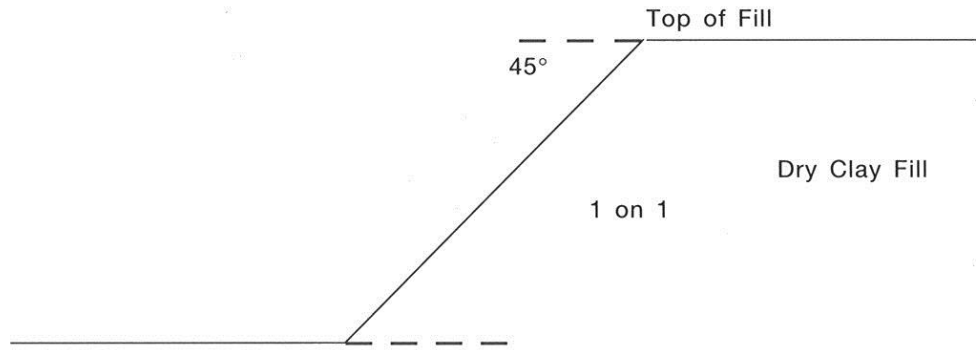

Case 2 Wet Soil, Rubble, Trash or Organic Material Fill

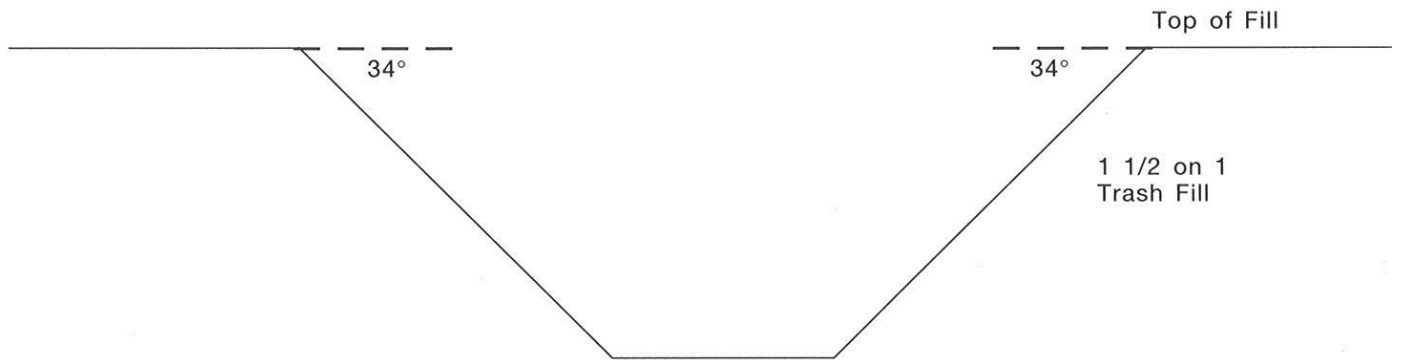

EXAMPLE 12

Excavation — Saturated sand, soft clay or organic soil encountered at depth under fill area.

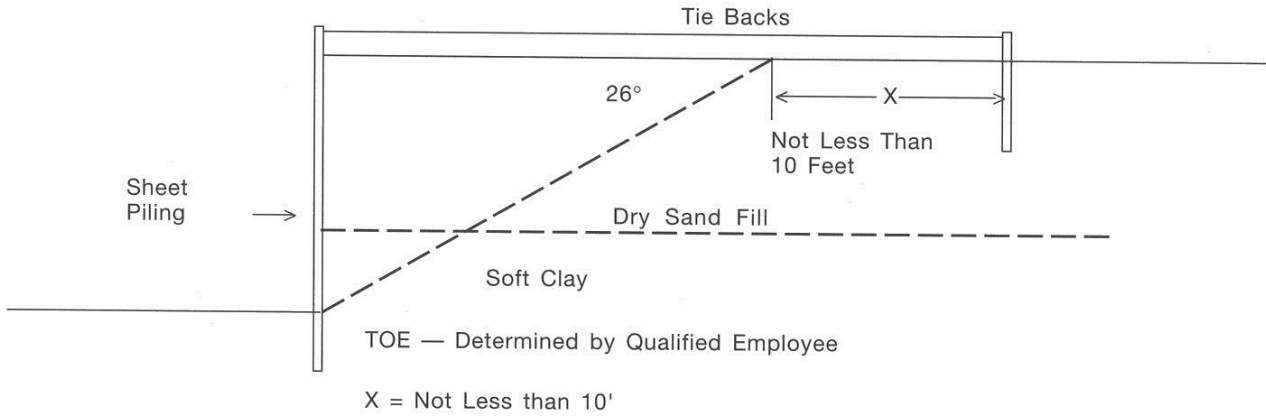

EXAMPLE 13

Trench — Saturated sand, soft clay, or organic soil encountered at depth under a fill.

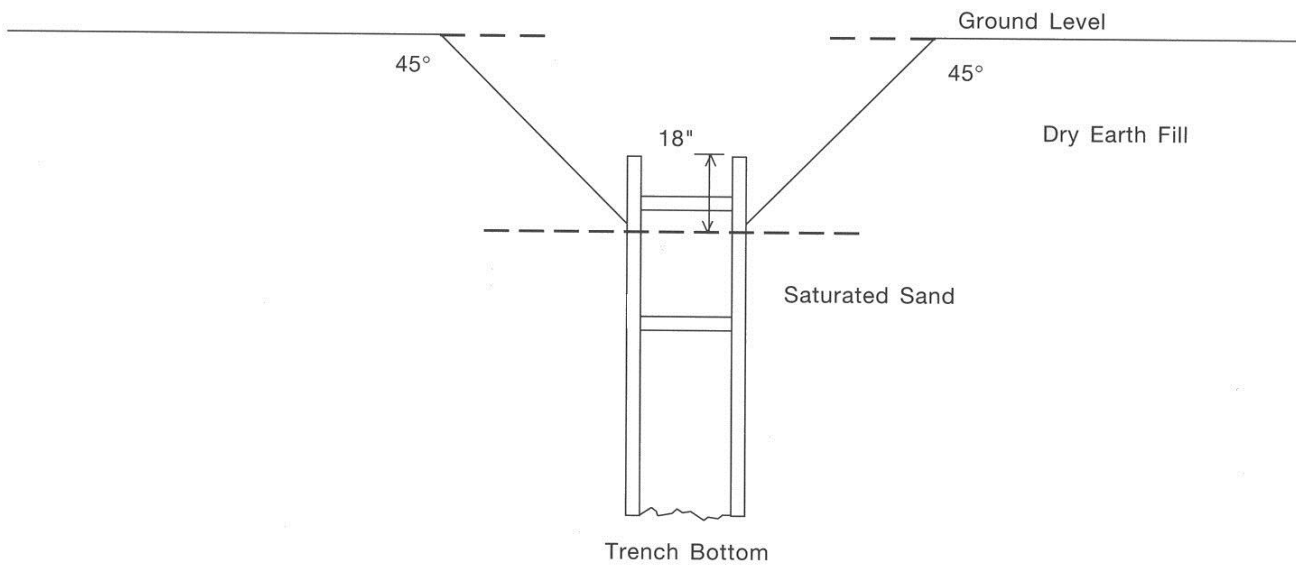

If the bottom of the trench extends into saturated sand, soft clay, or organic soil under a fill, a trench supporting system should be used to provide protection below the fill.



Michigan Occupational Safety and Health Administration
PO Box 30643
Lansing, Michigan 48909-8143
Ph: 517-284-7740

The Department of Licensing and Regulatory Affairs will not discriminate against any individual or group because of race, sex, religion, age, national origin, color, marital status, disability, or political beliefs. Auxiliary aids, services and other reasonable accommodations are available upon request to individuals with disabilities.